

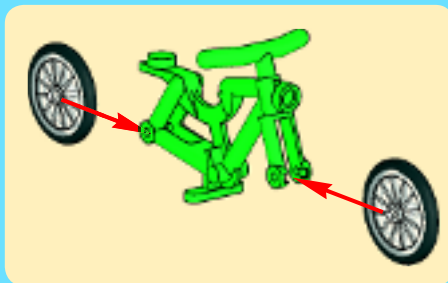

10218

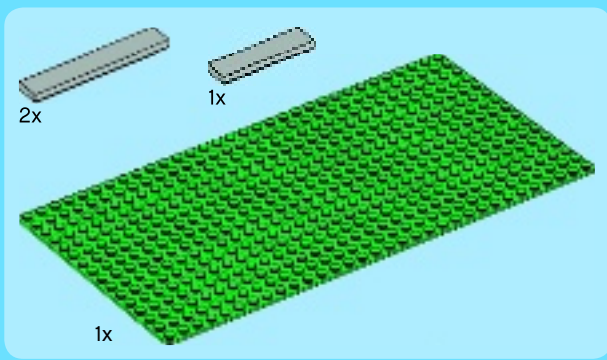





1

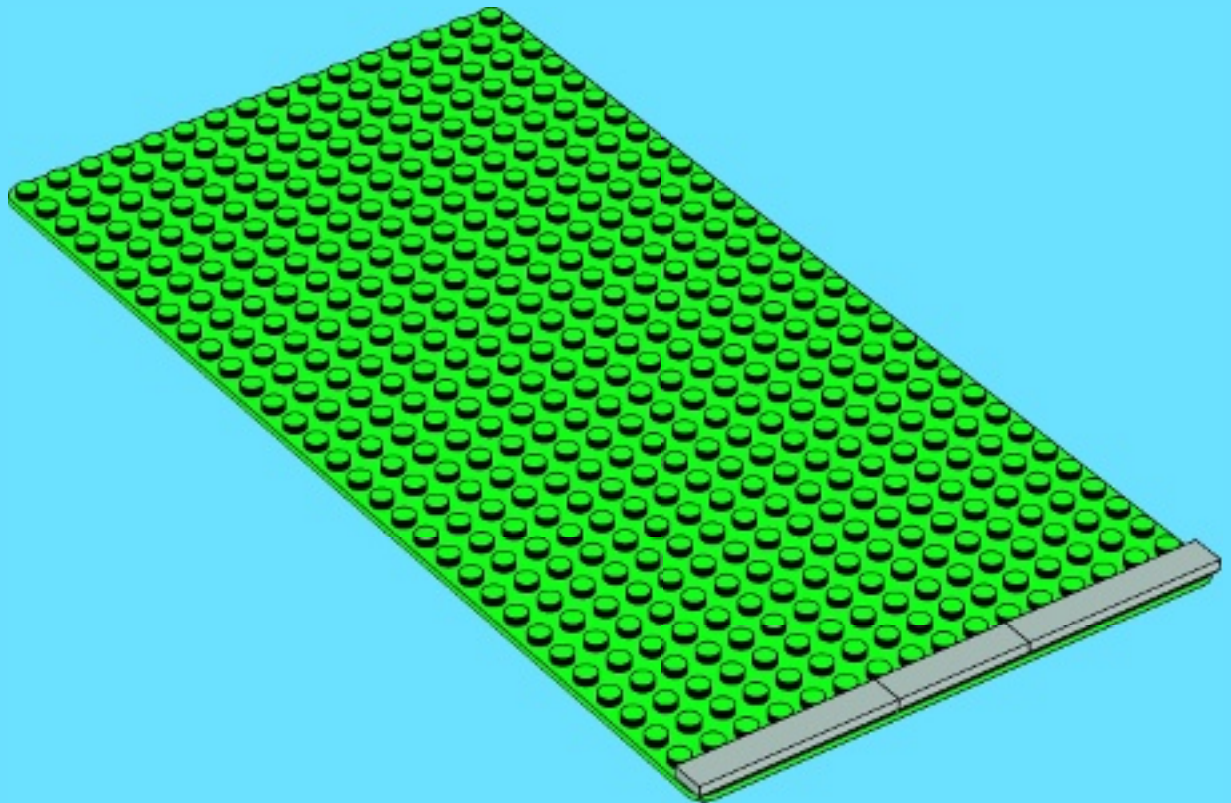



7x



10x



1x

2

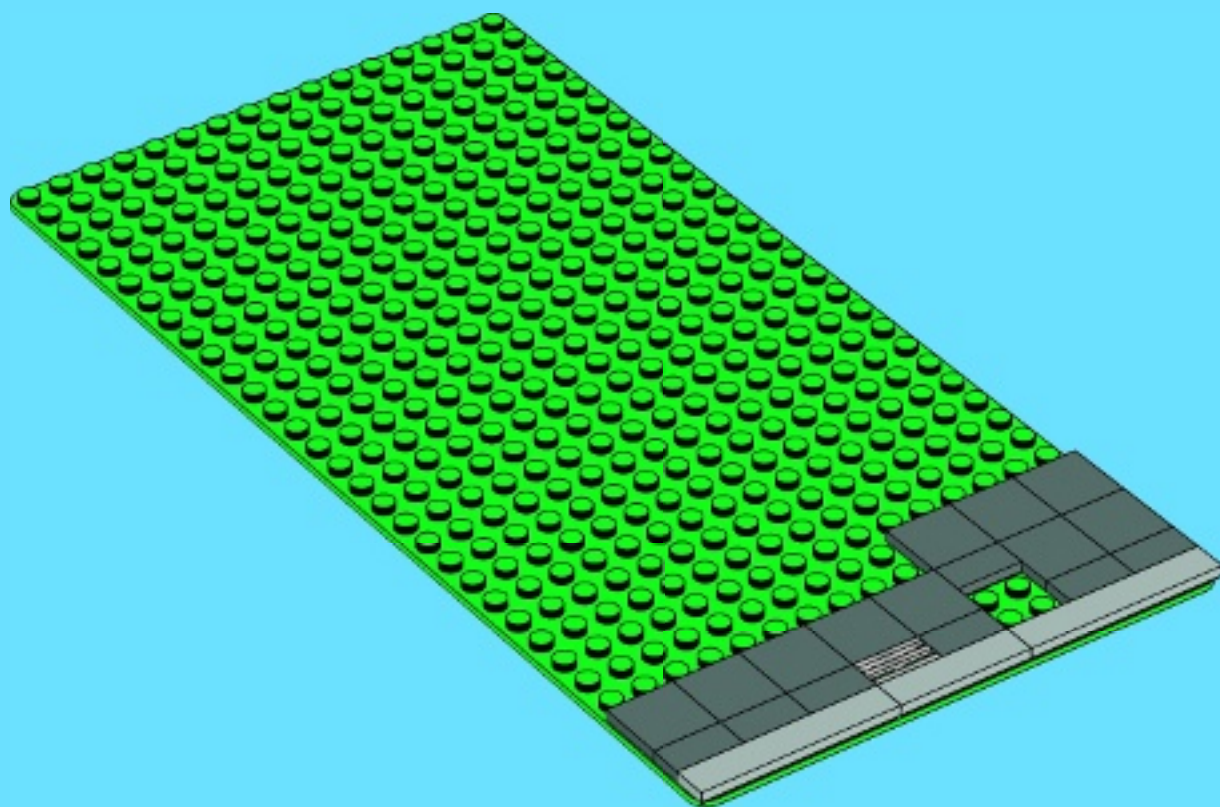

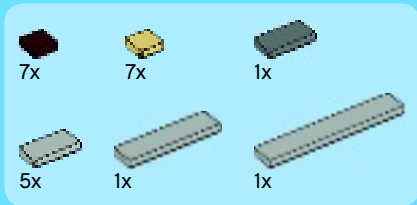

3

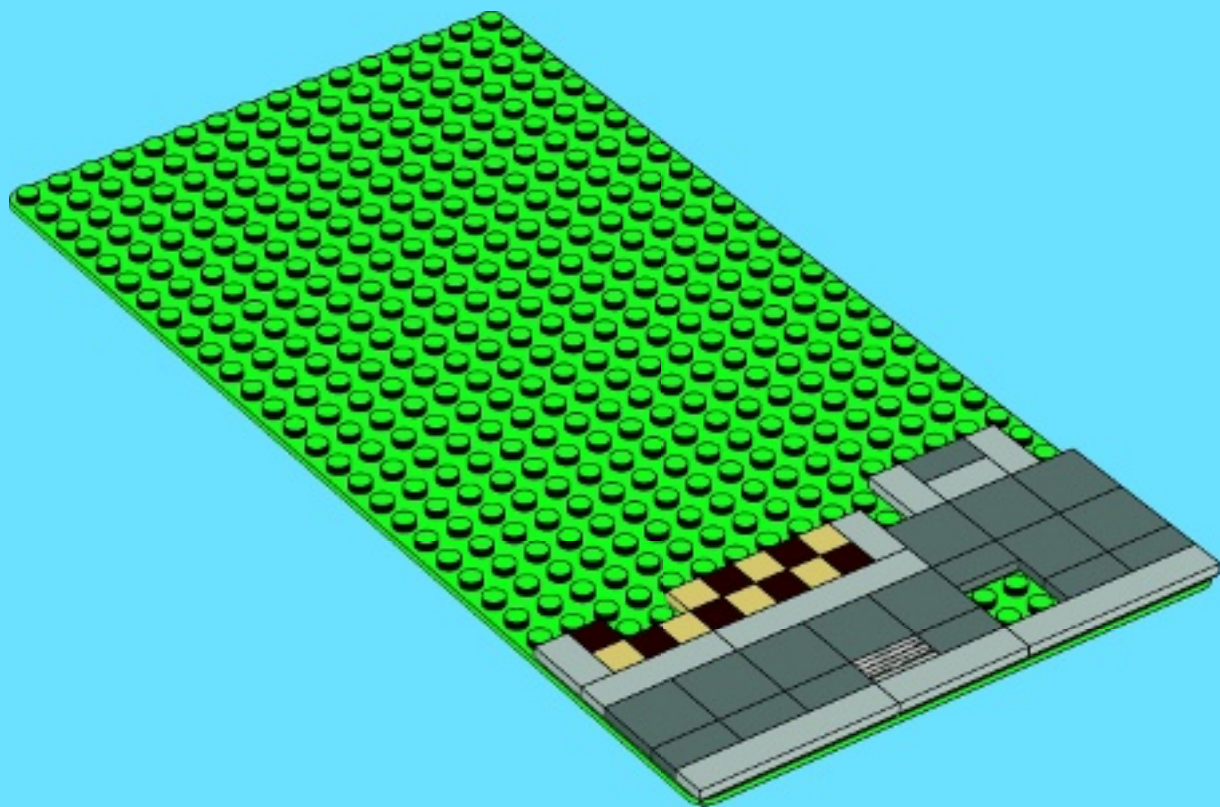

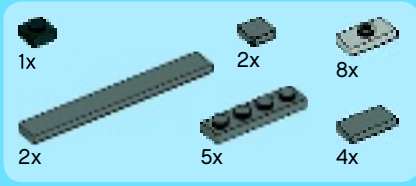

4

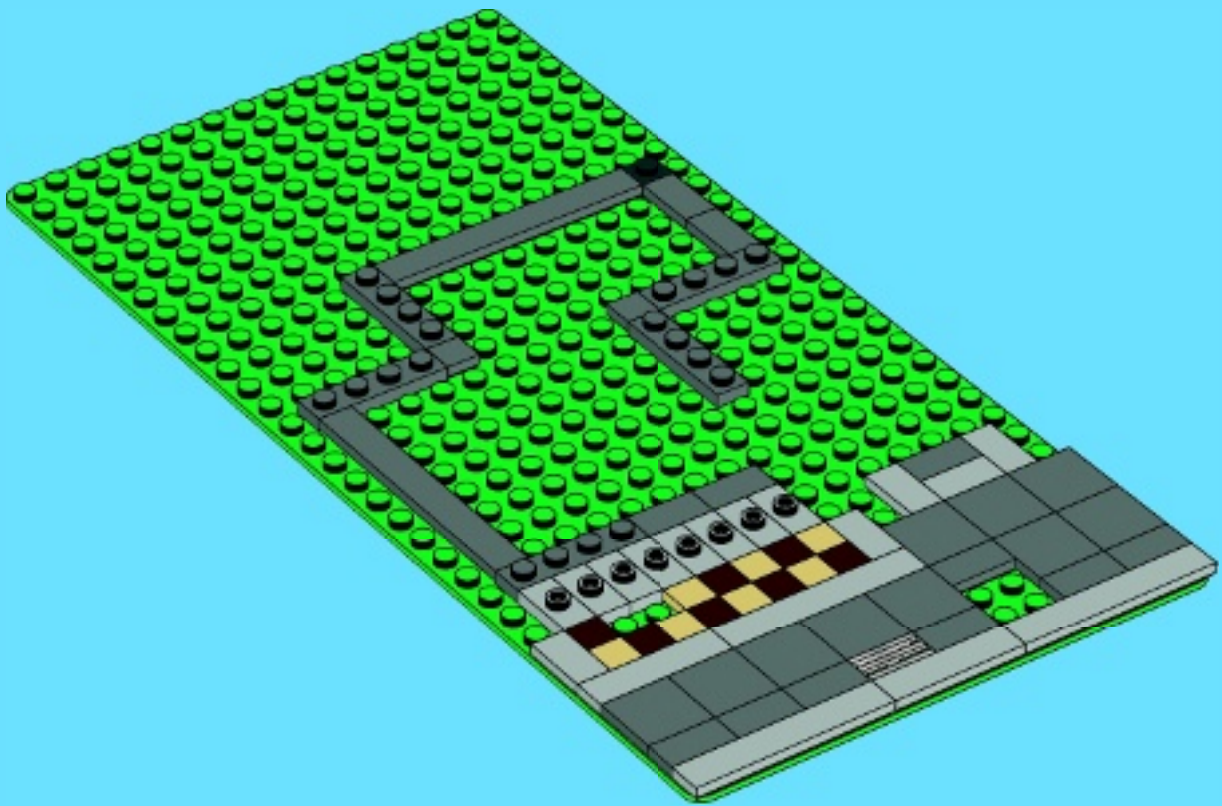



1x



2x



11x



12x

5

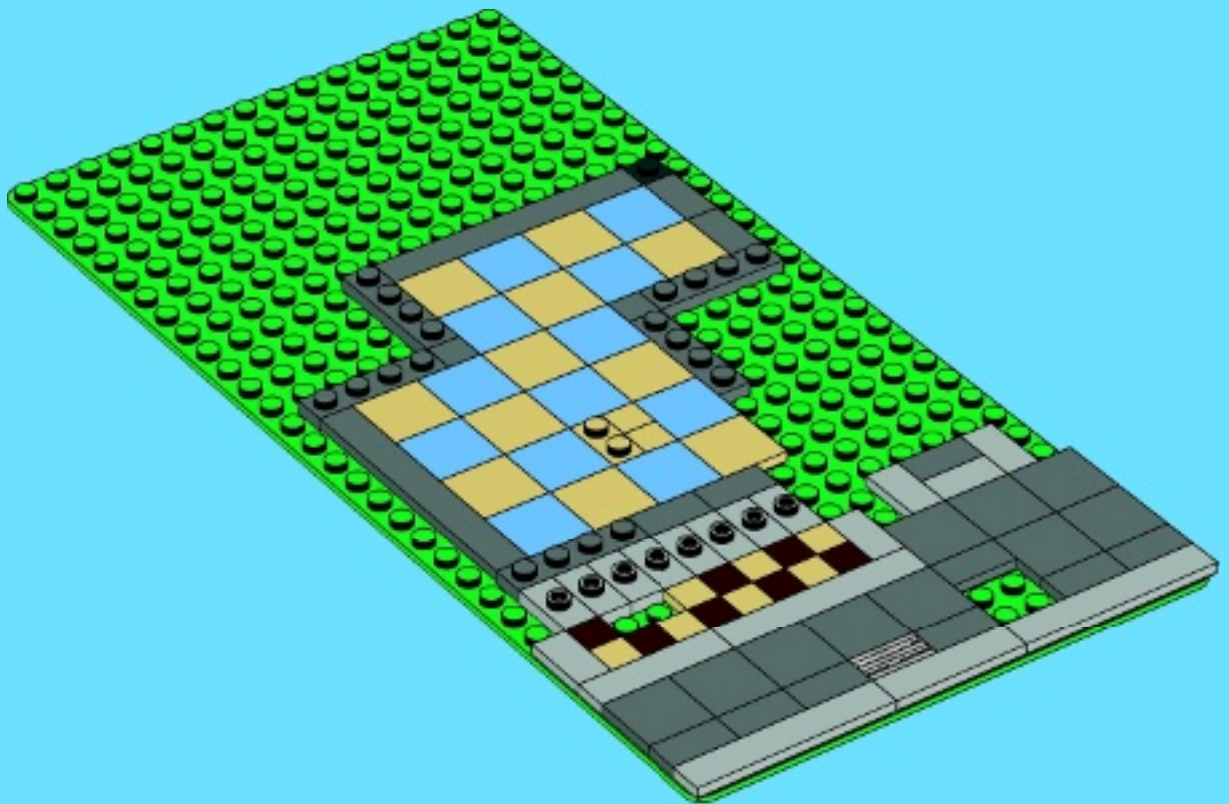

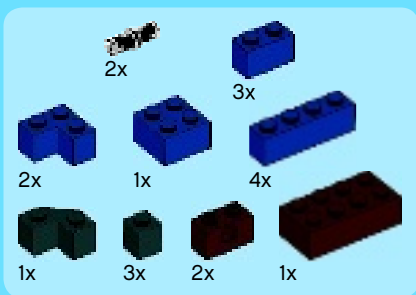

6

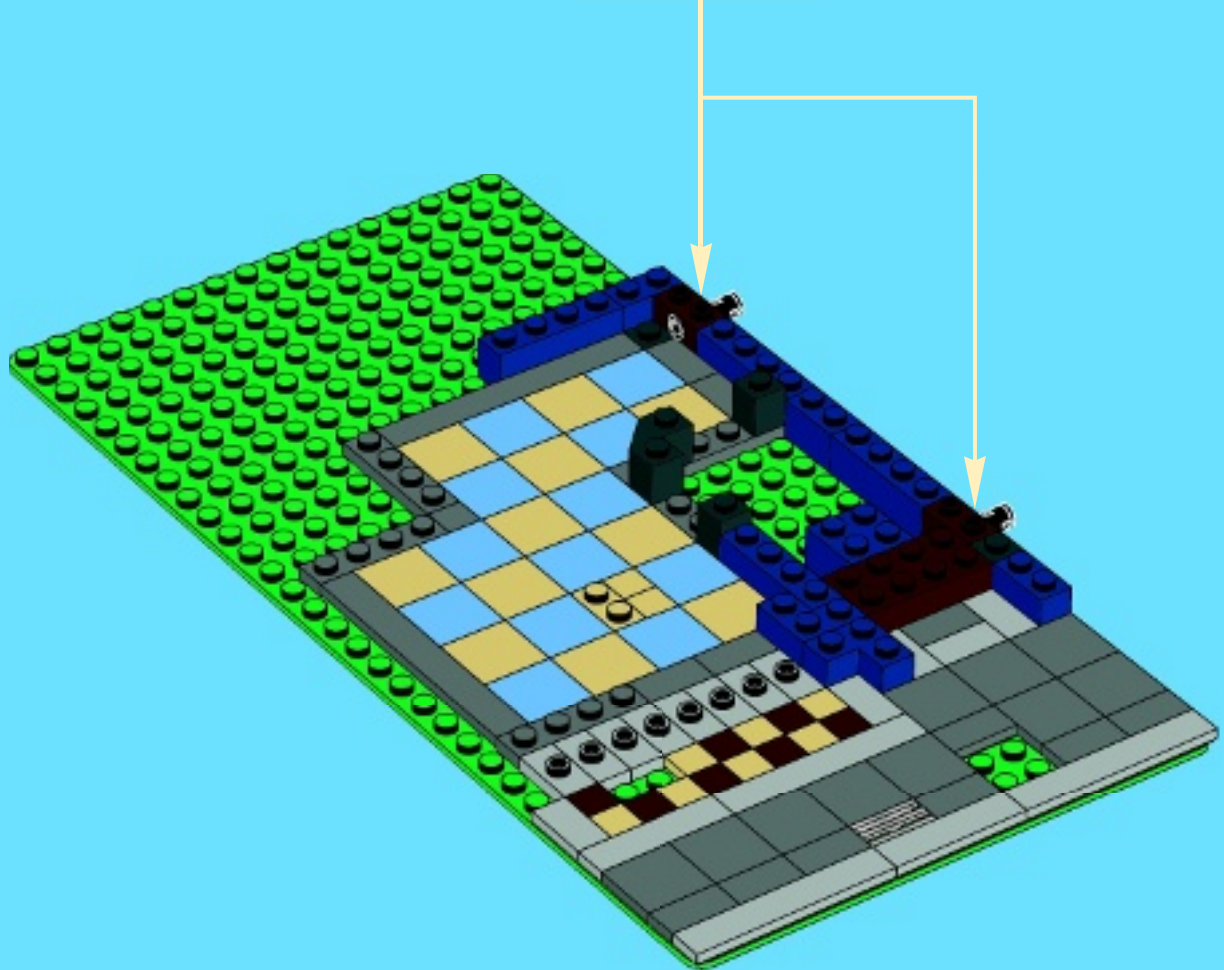
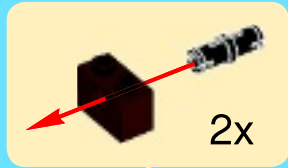

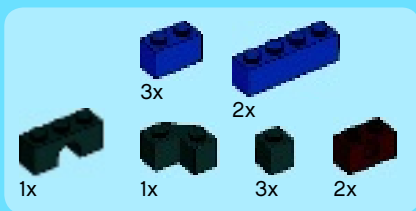

7

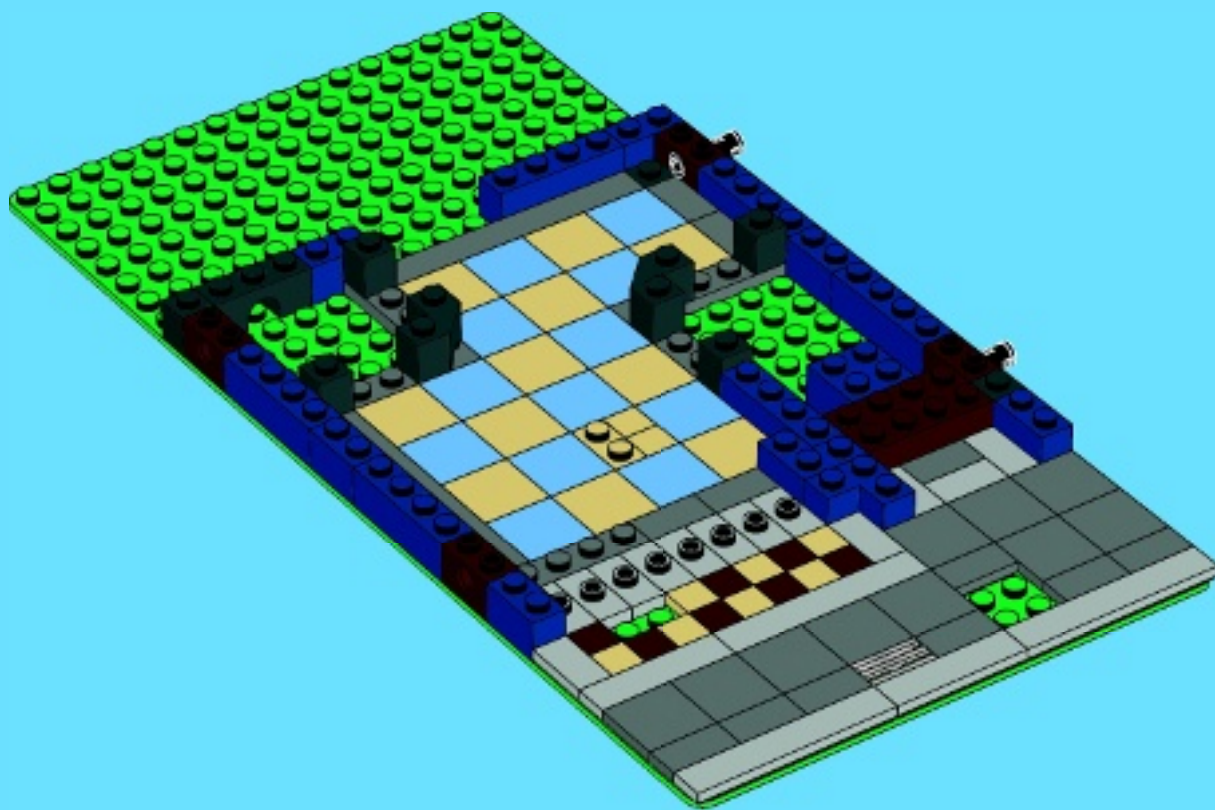



8

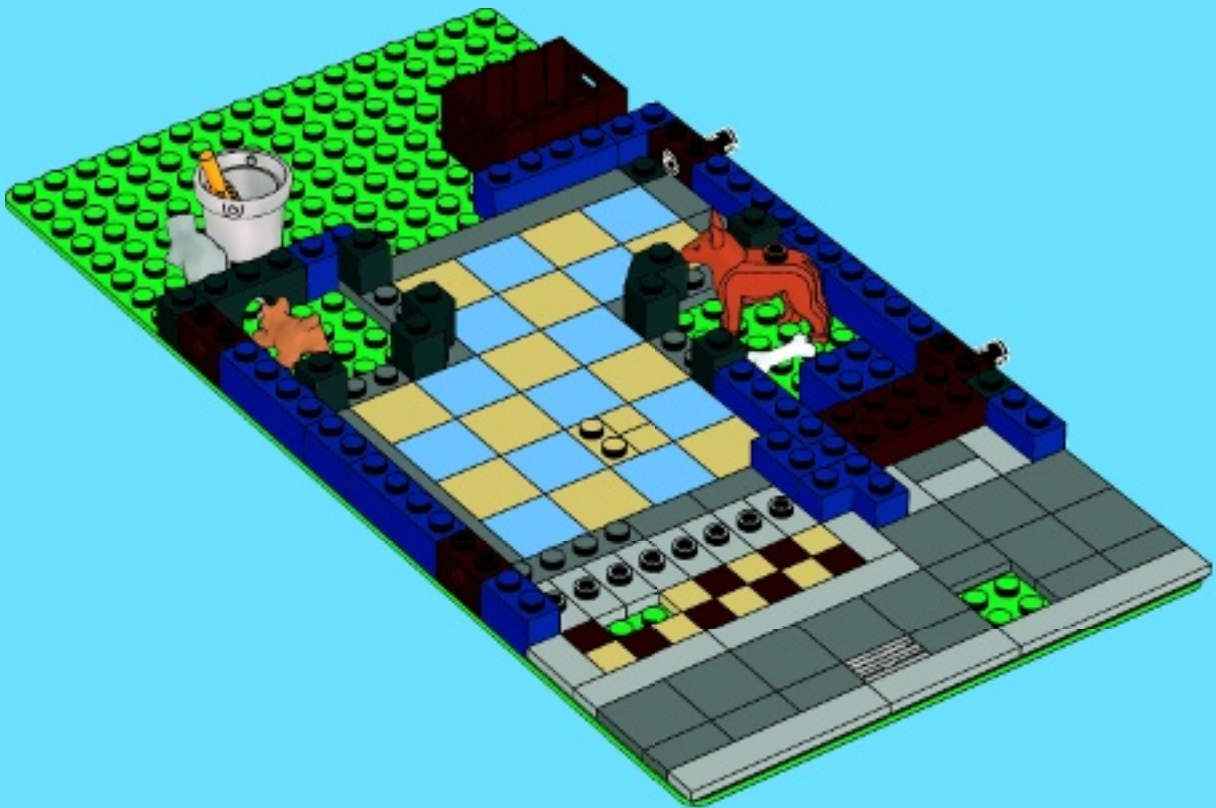

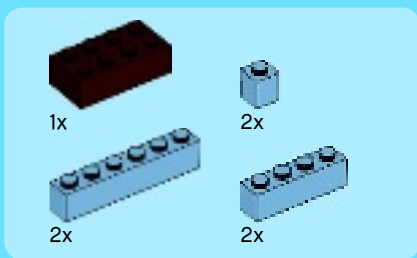

9

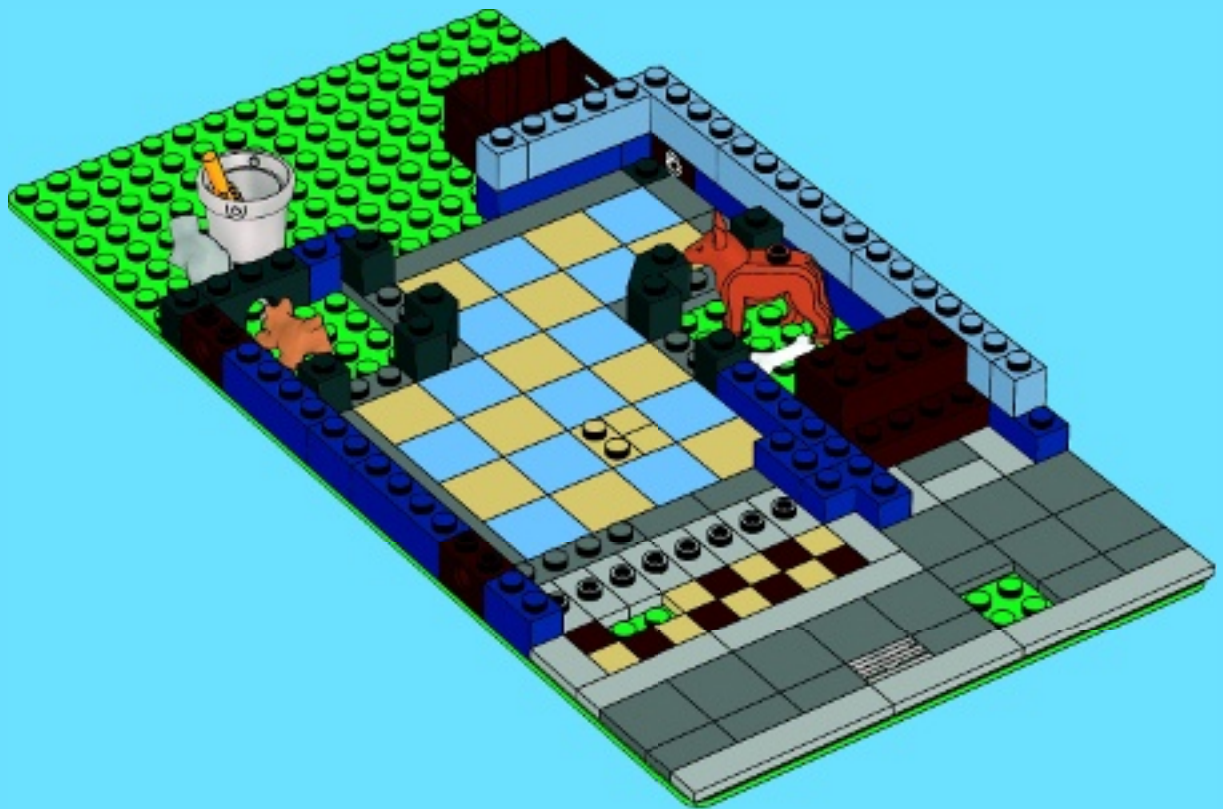



1x



2x



3x



1x

10

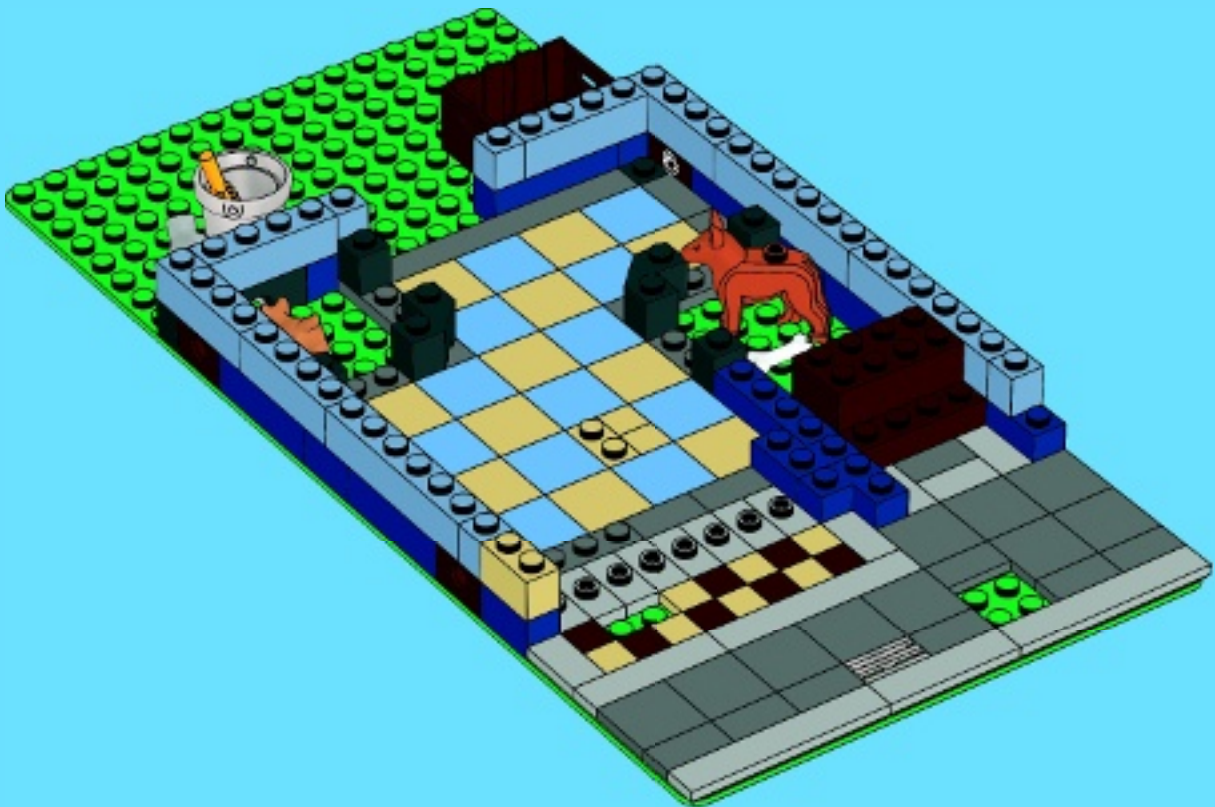

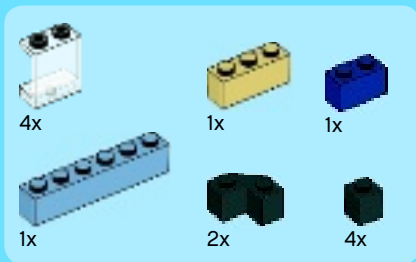

11

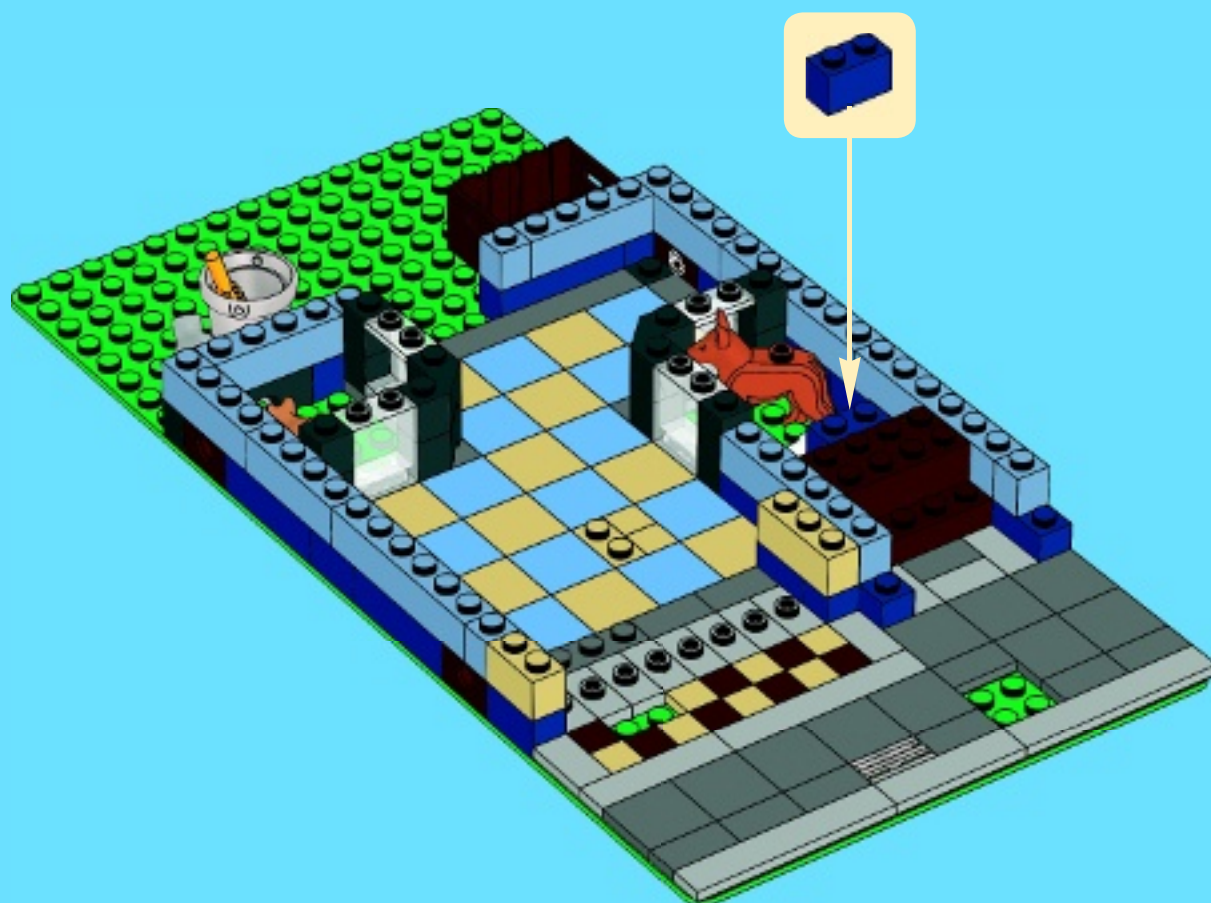

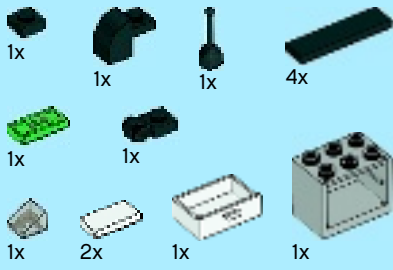

12

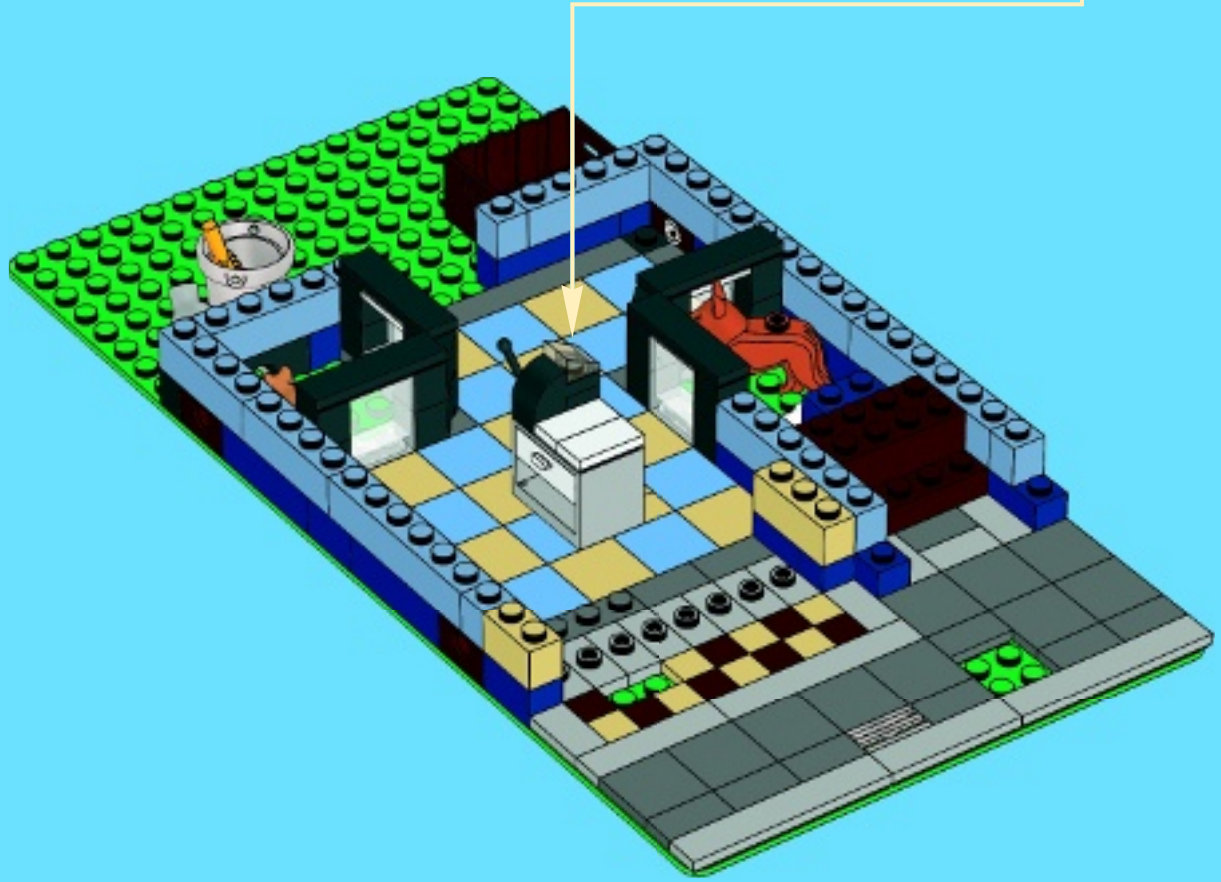
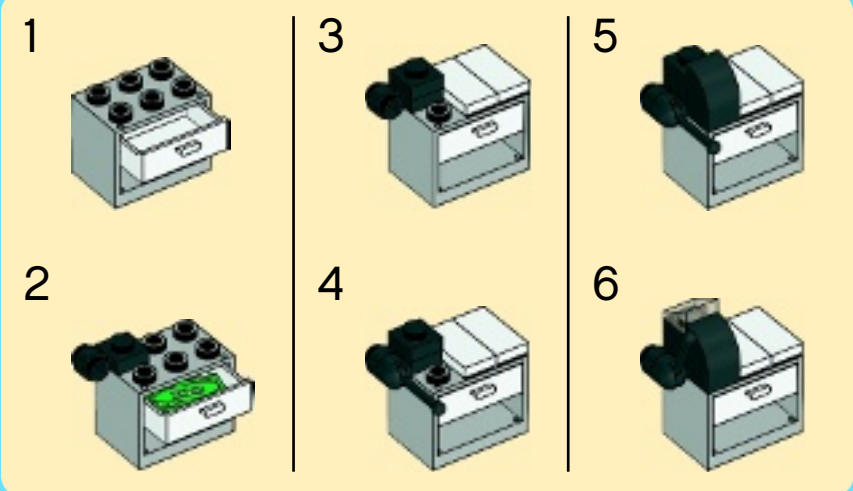

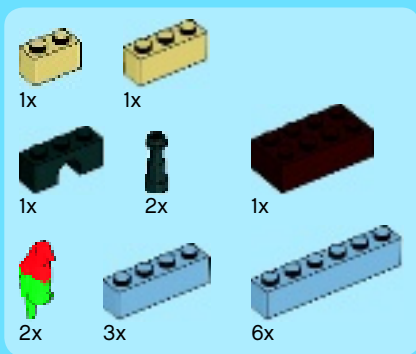

13

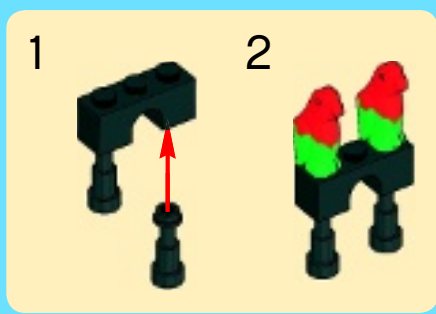
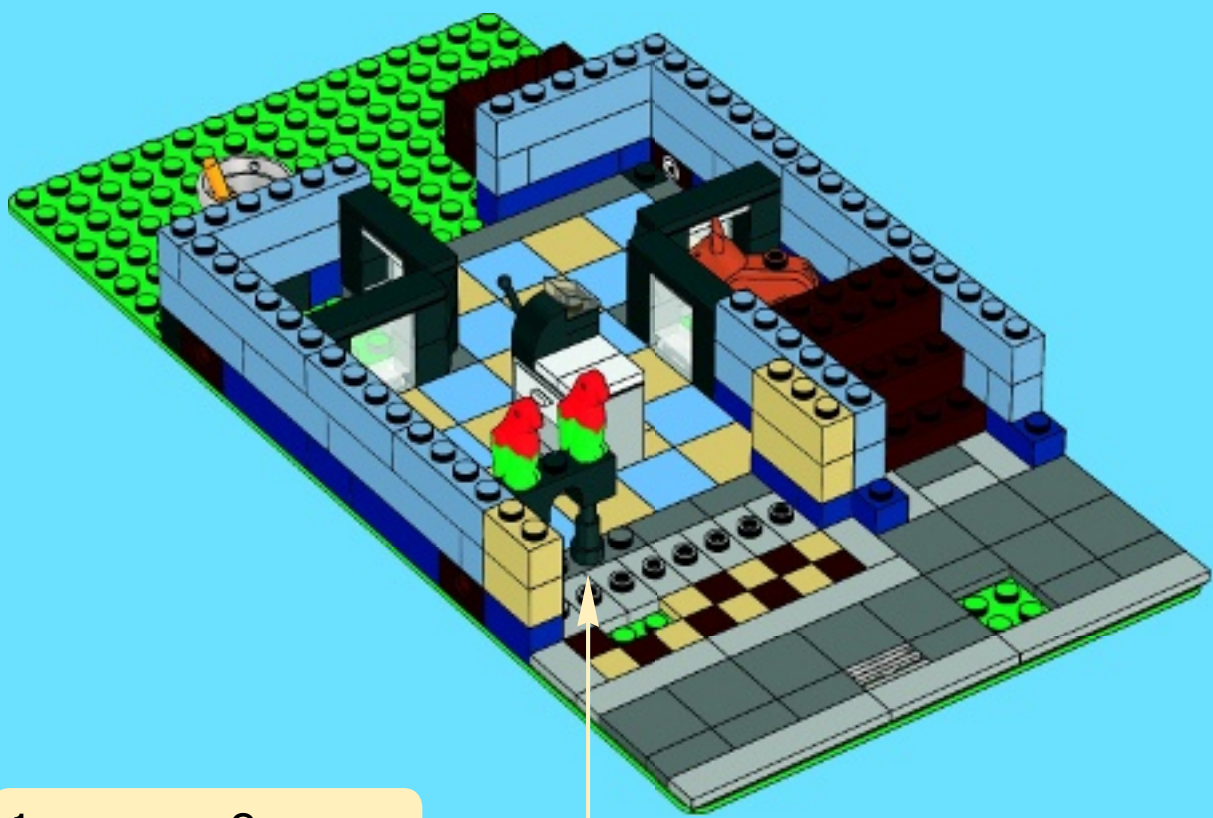

14

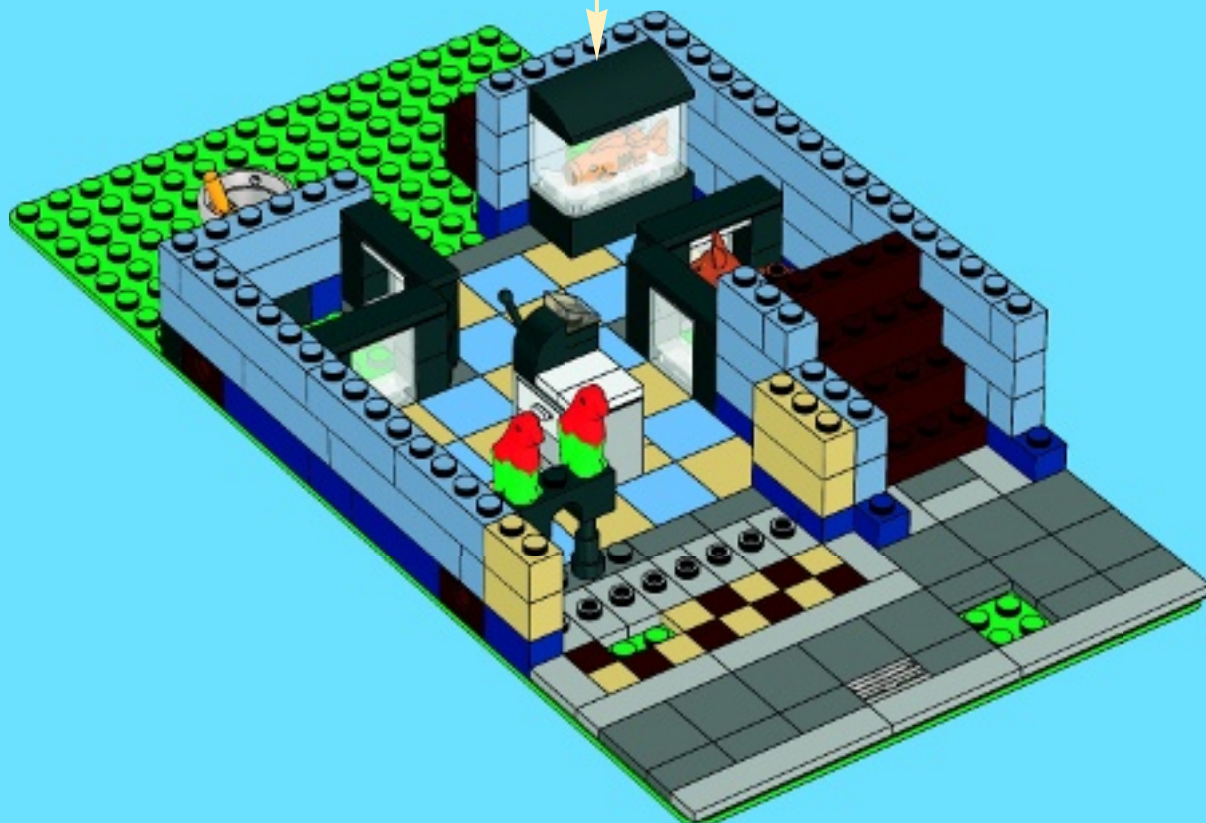
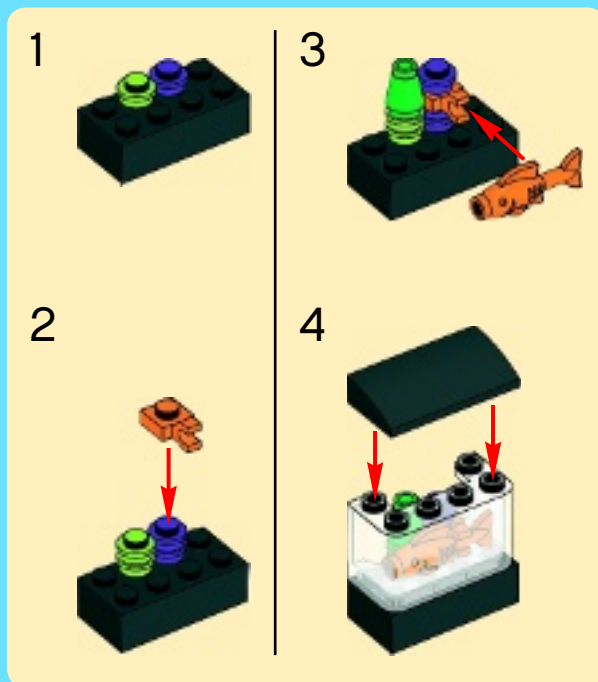
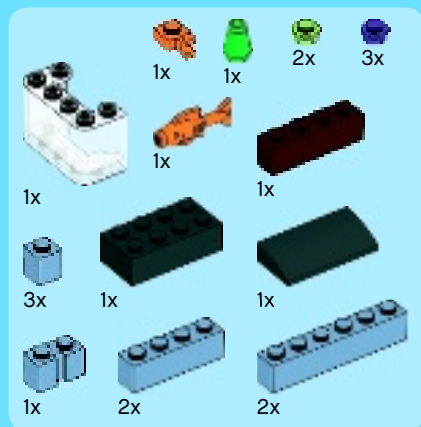

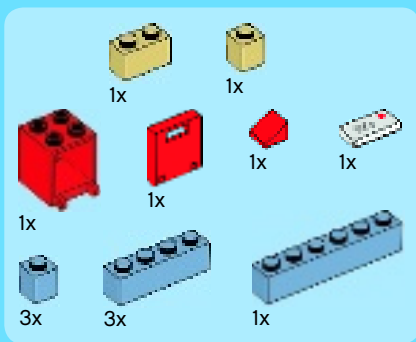

15

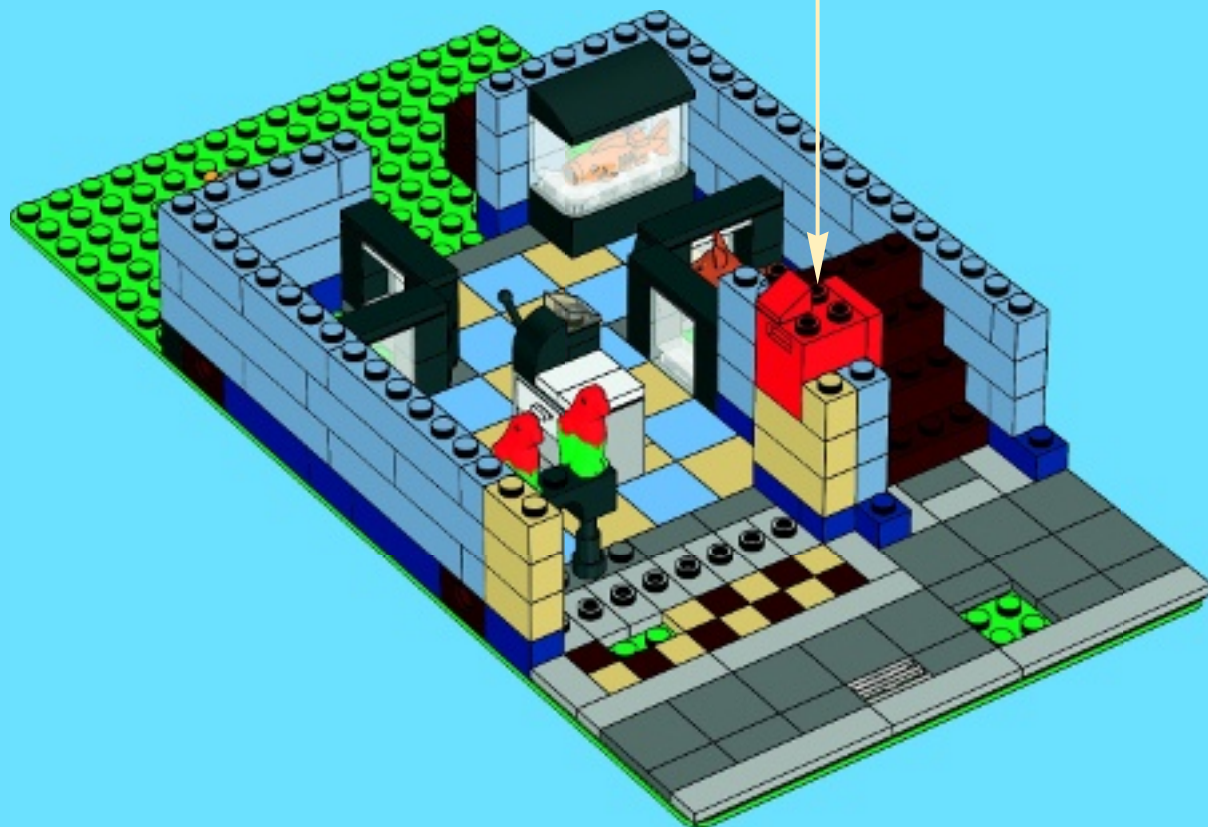
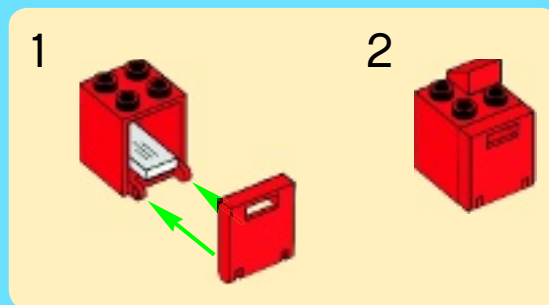

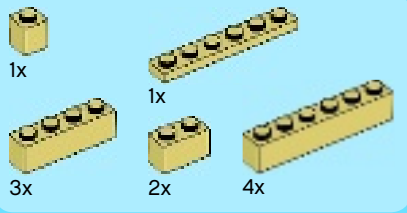

16

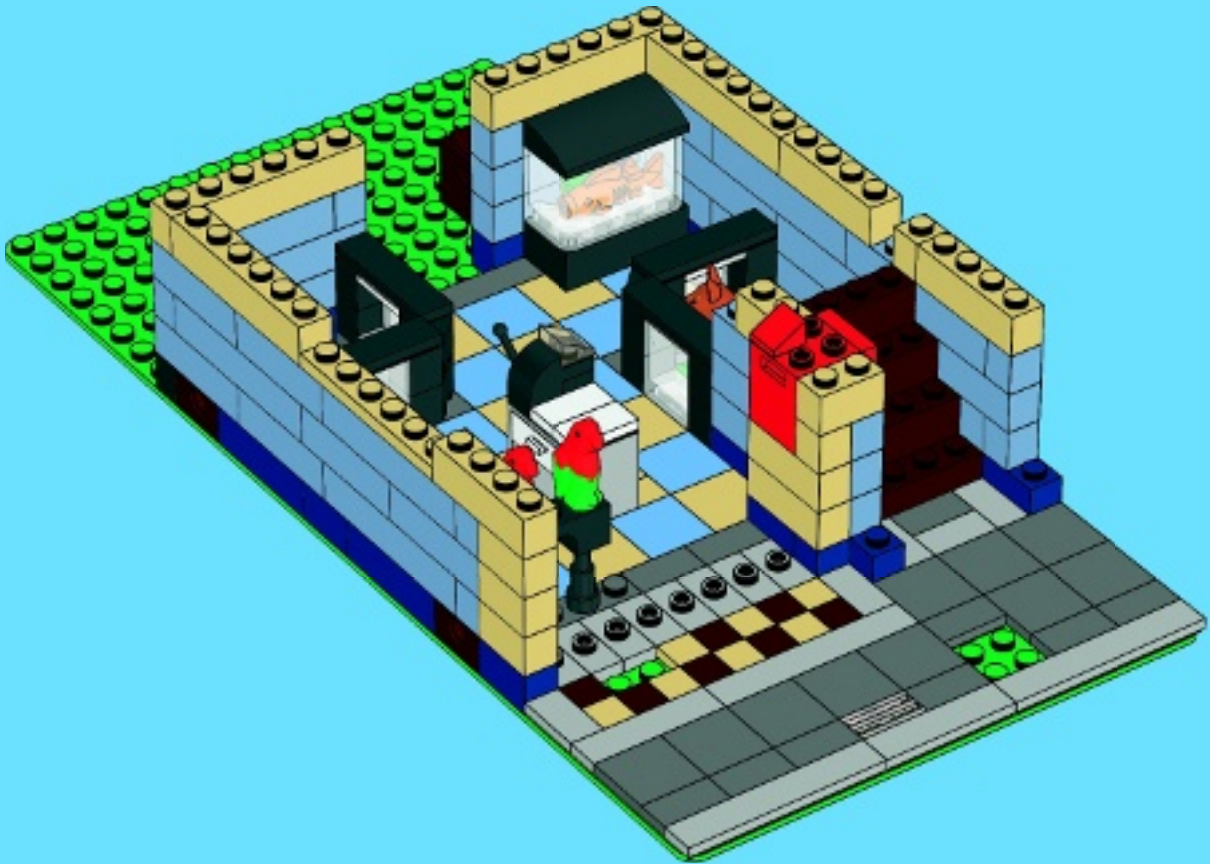

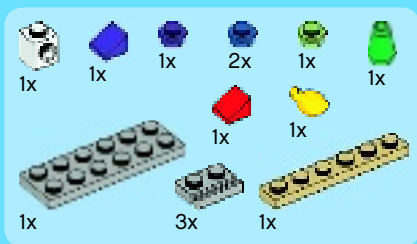

17

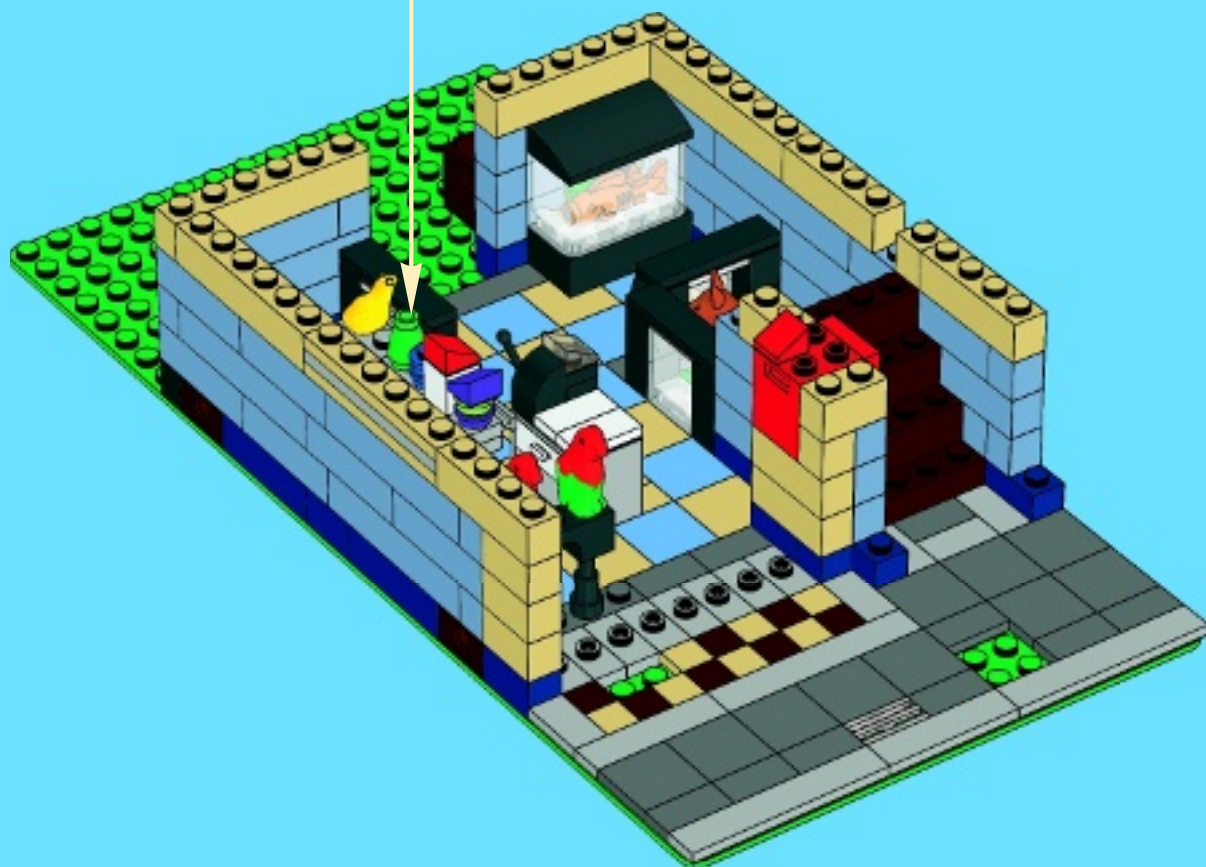
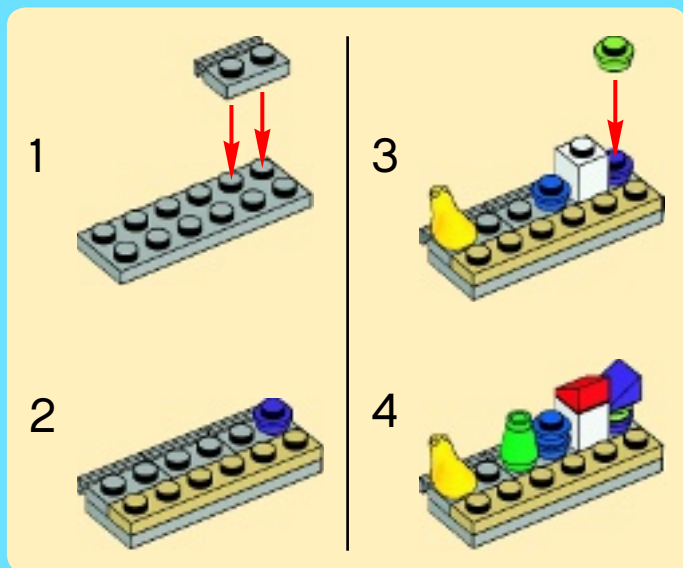

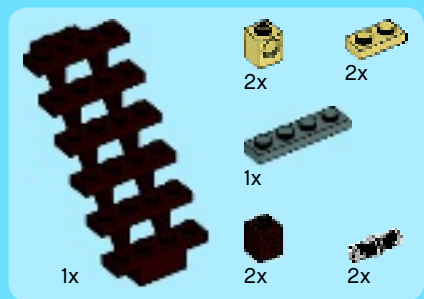

18

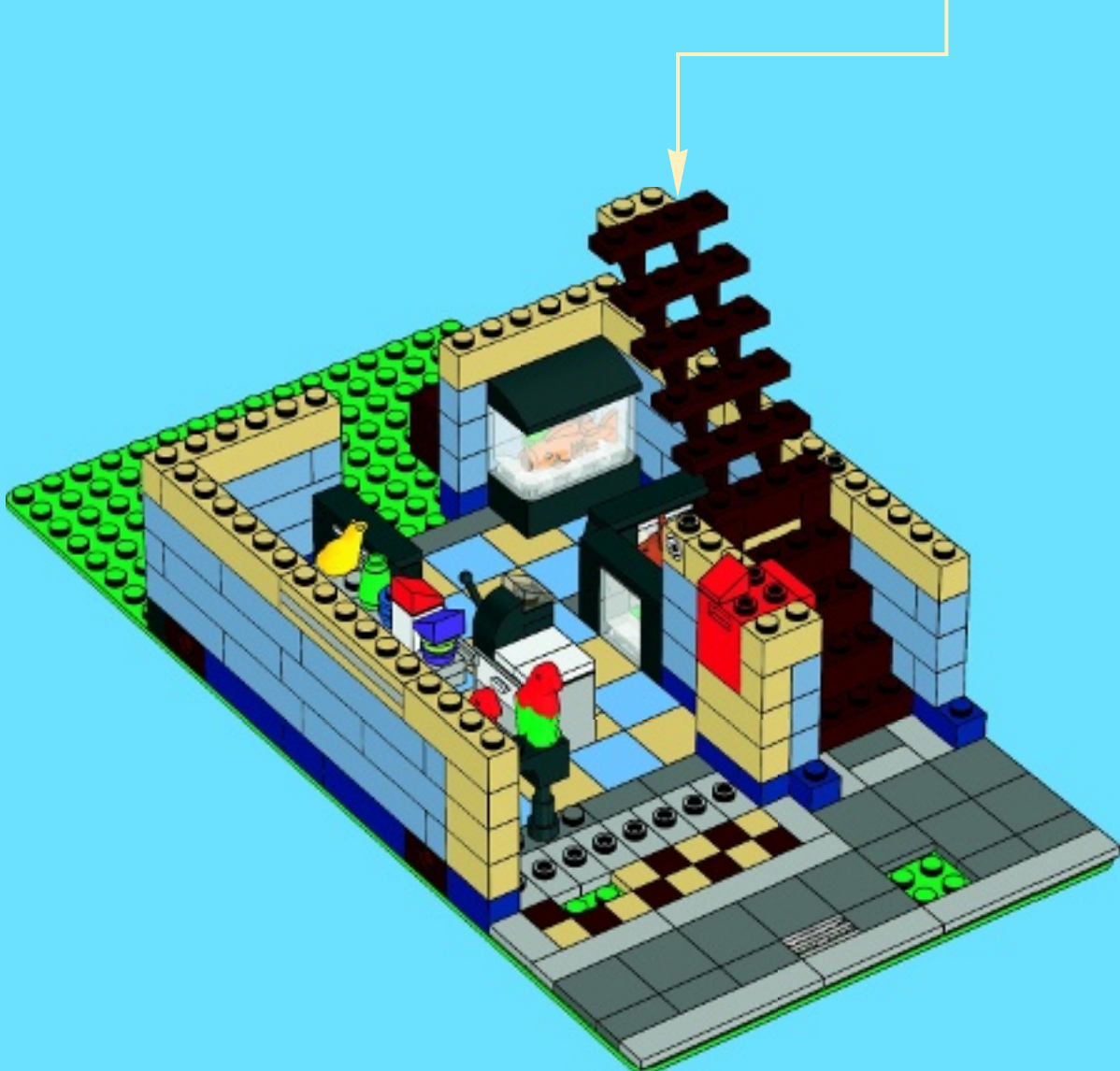
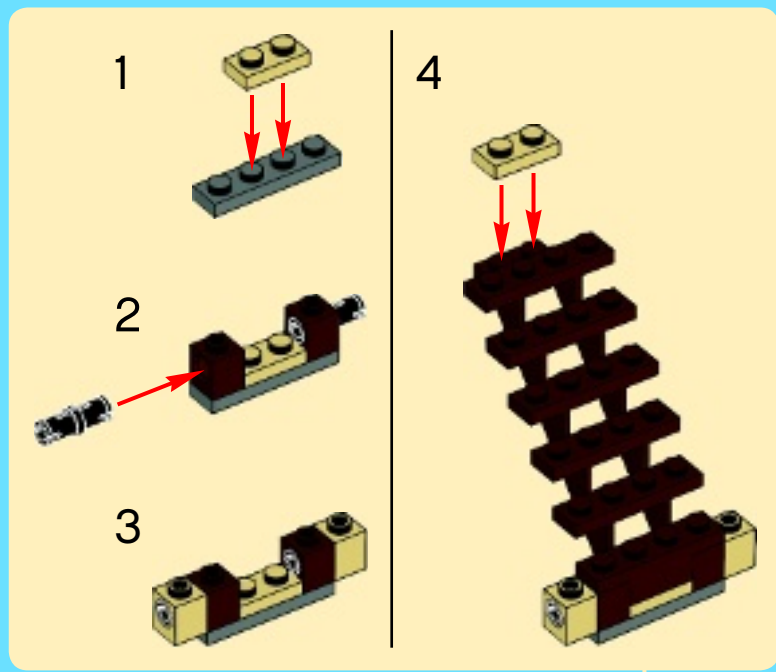

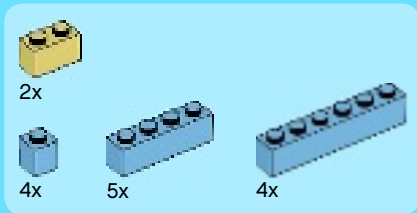

19

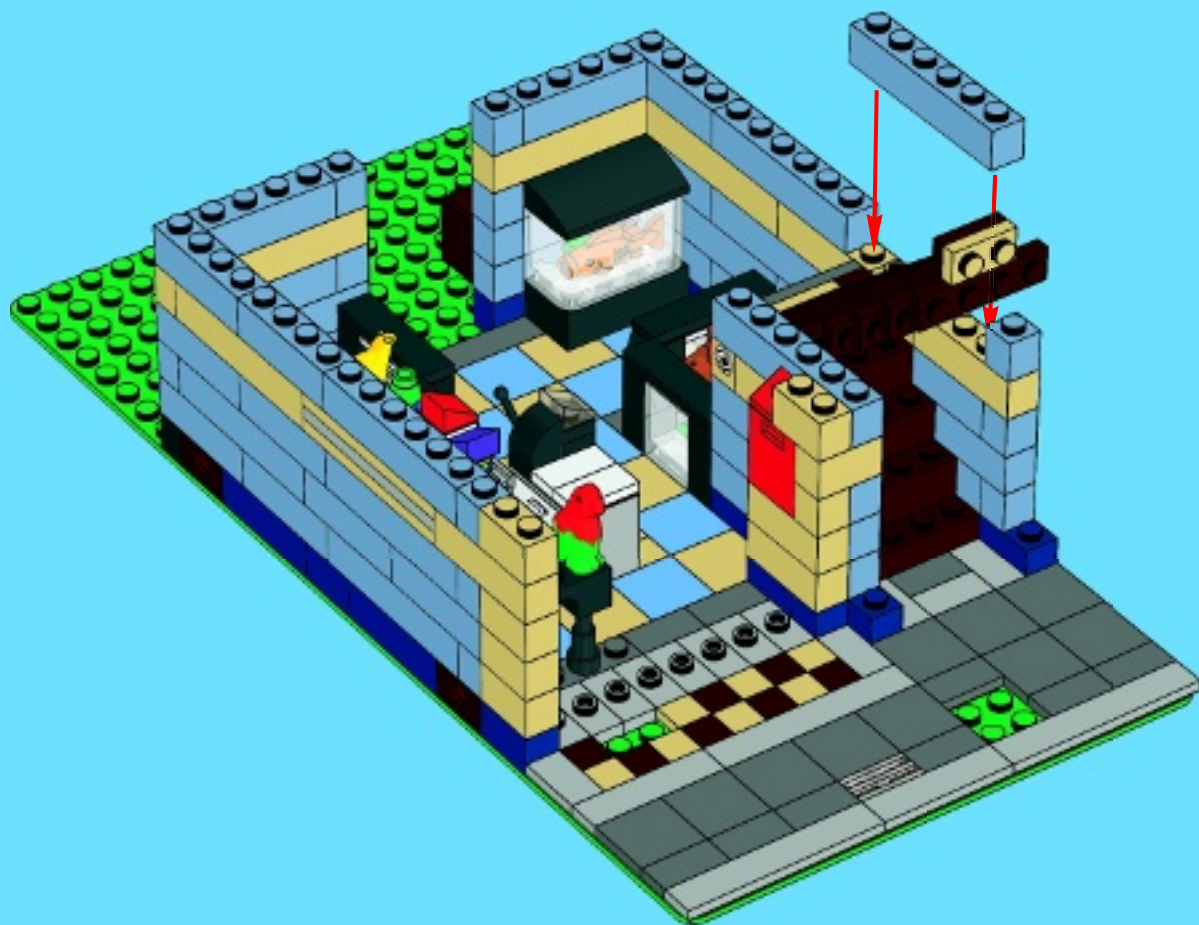

20

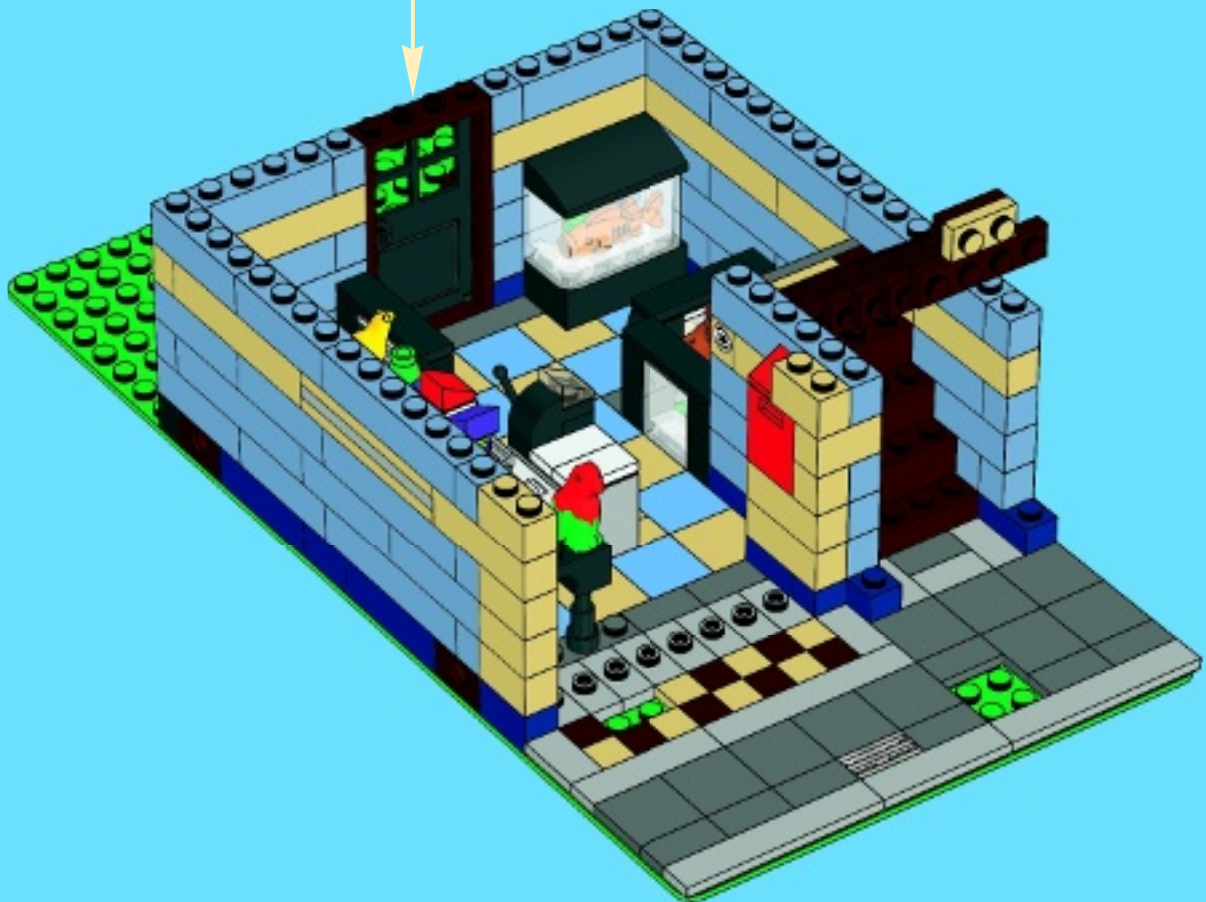
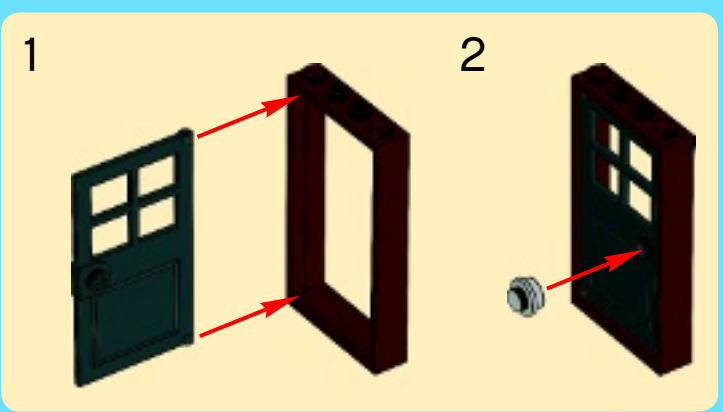
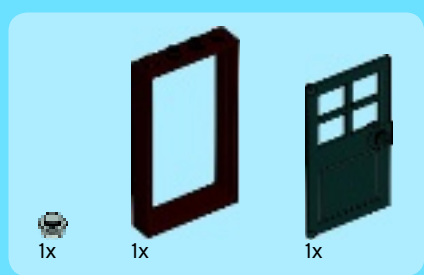

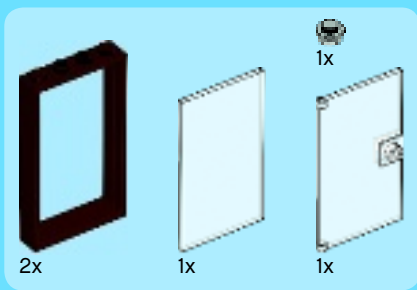

21

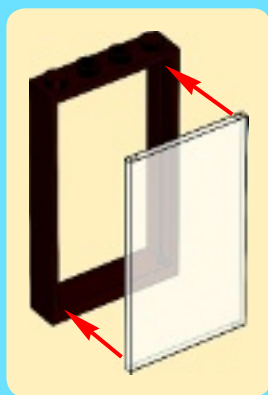
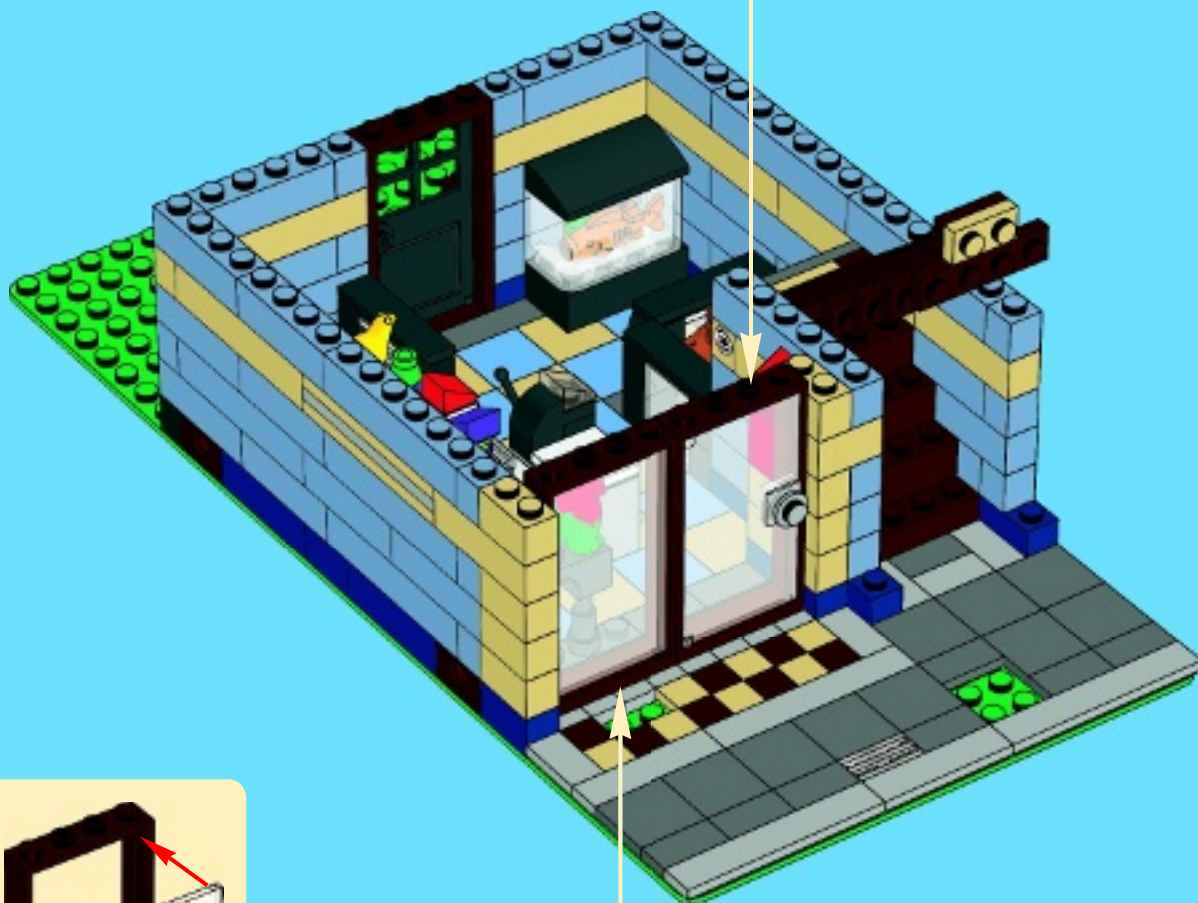
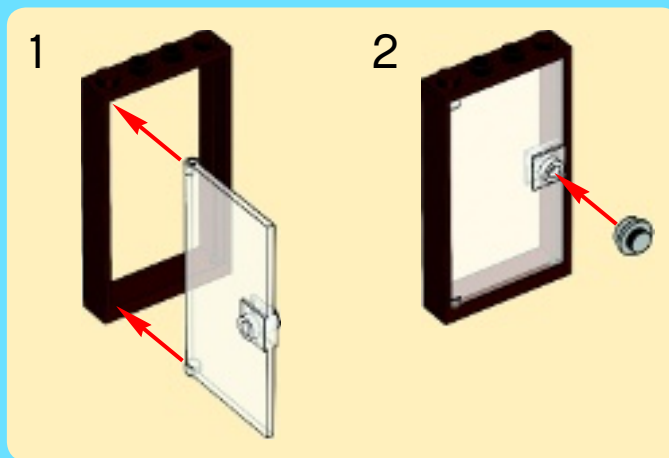

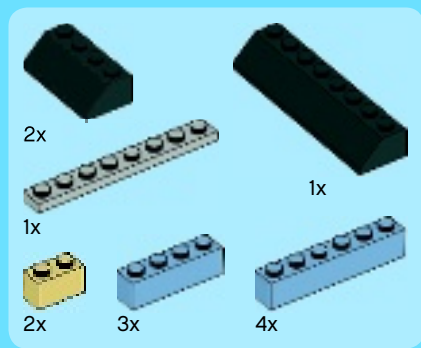

22





23

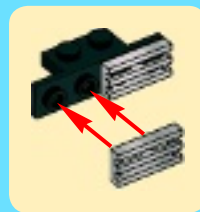

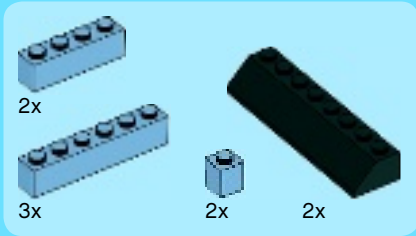

24



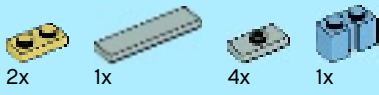

25

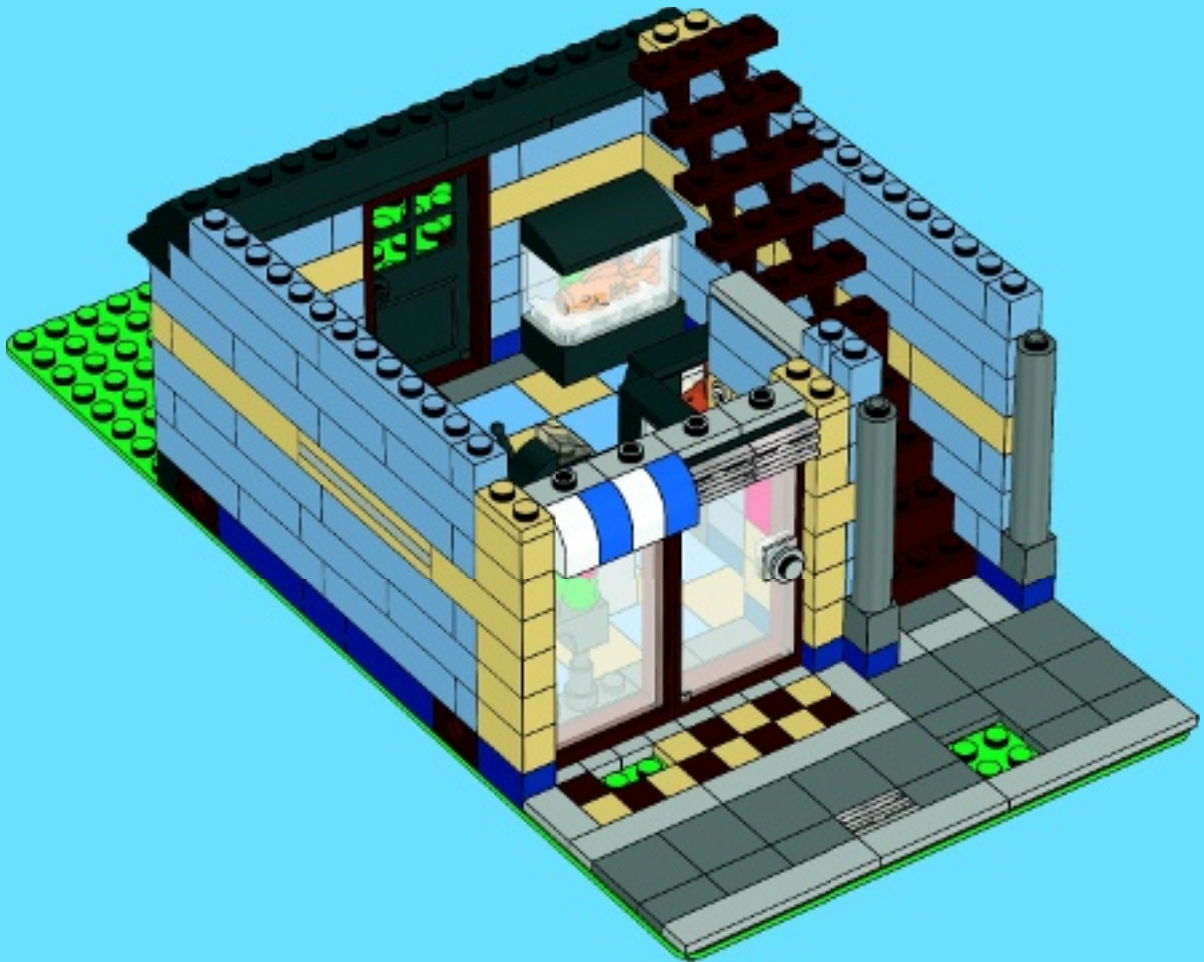

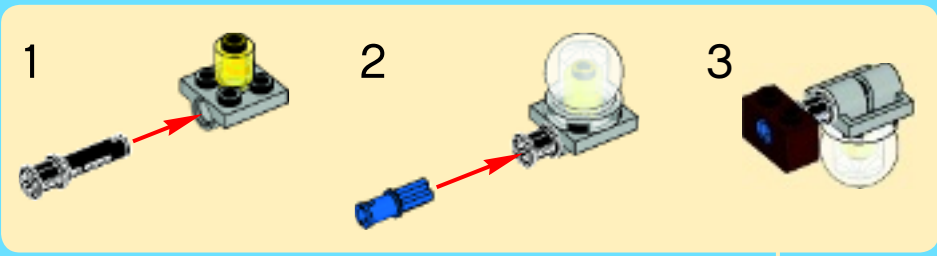
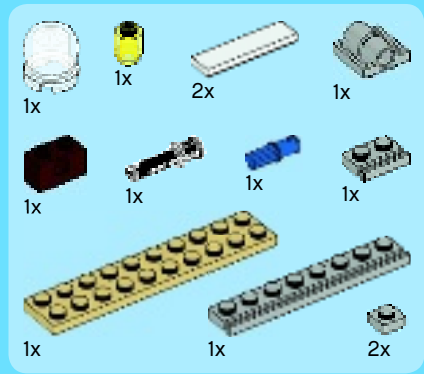

26

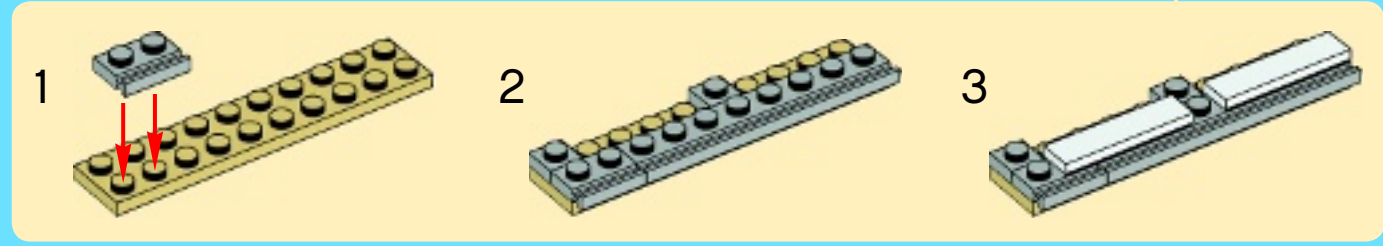
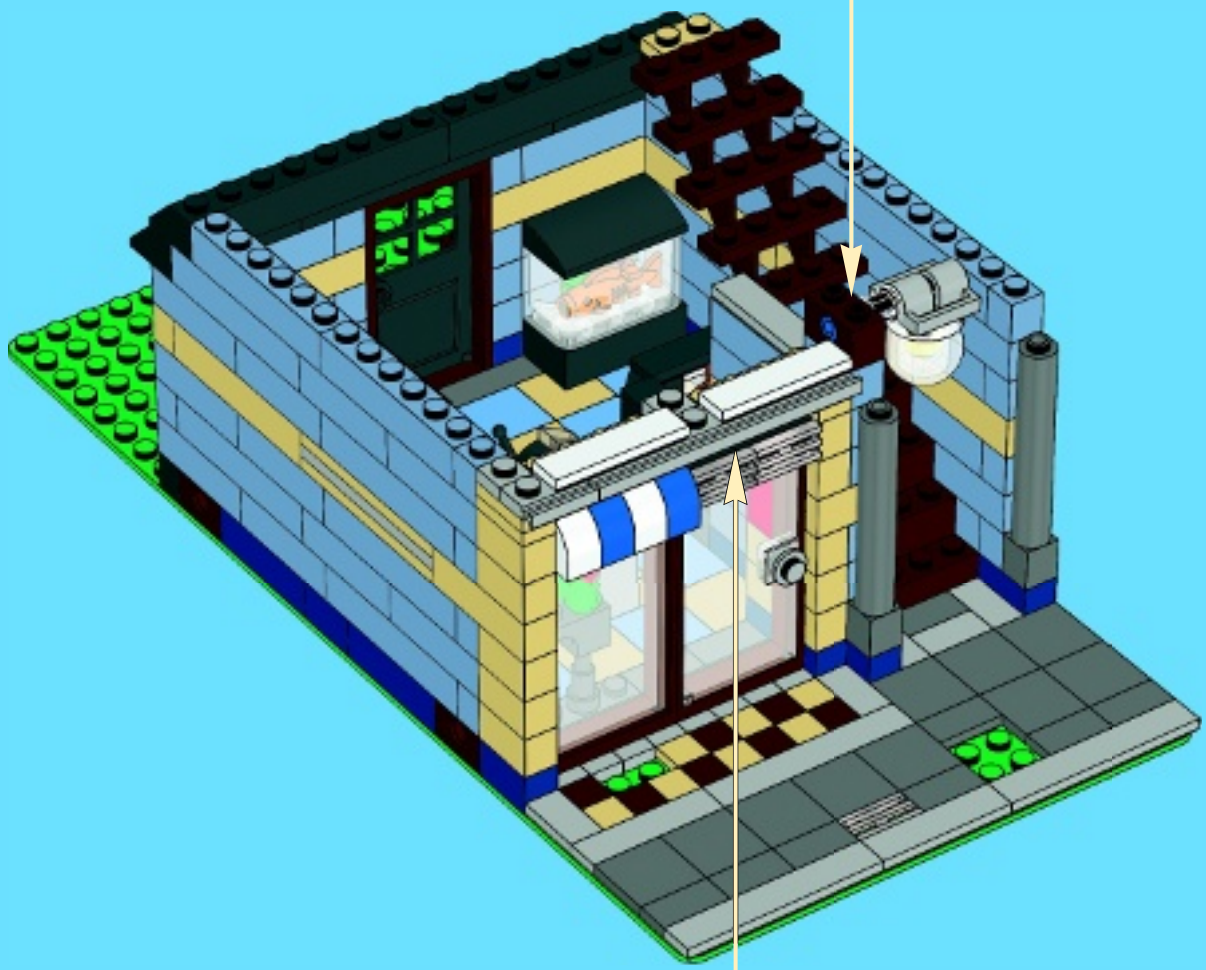

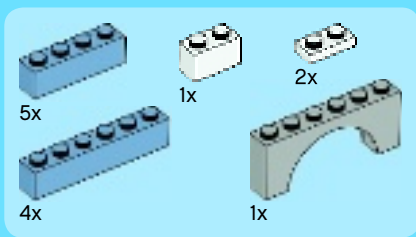

27

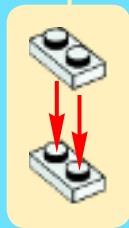
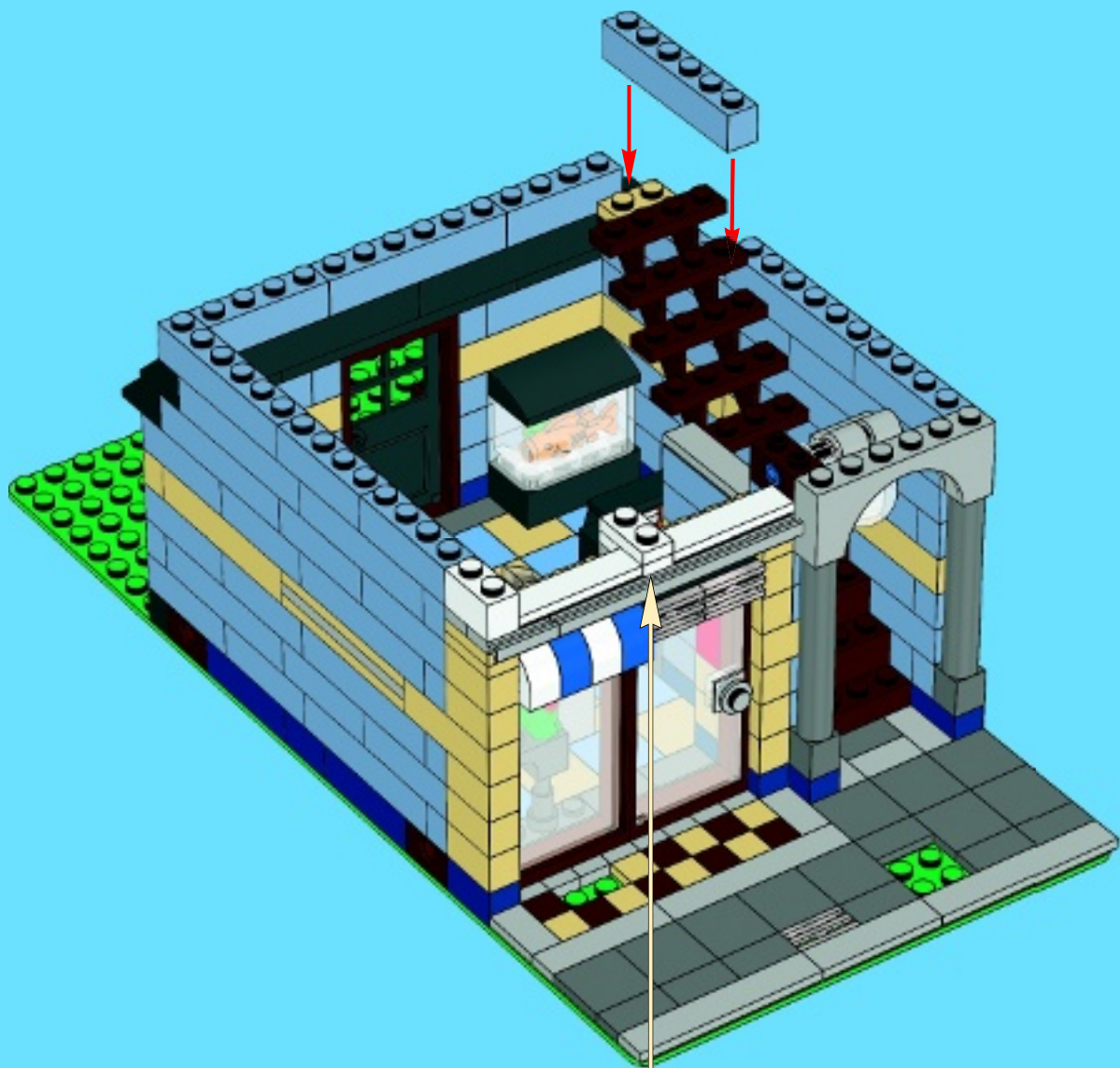

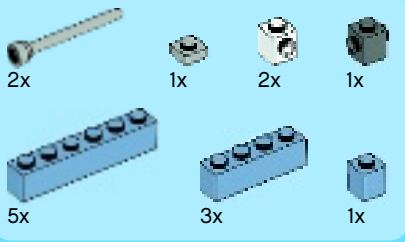

28

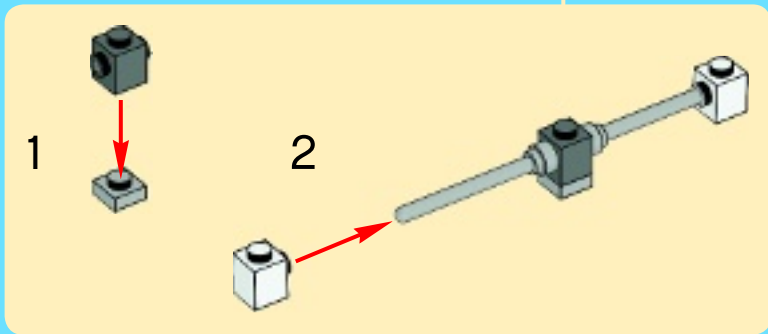
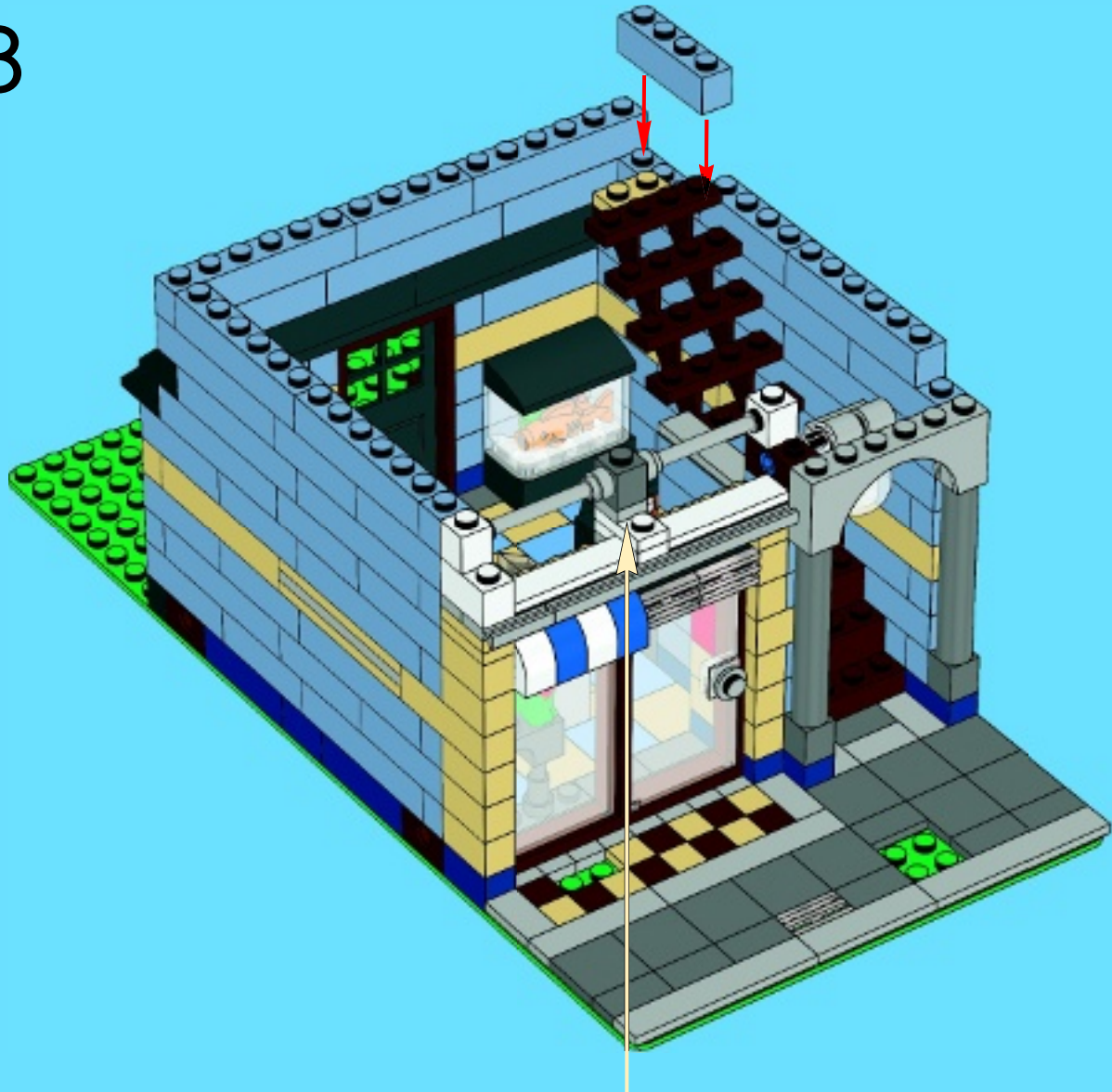

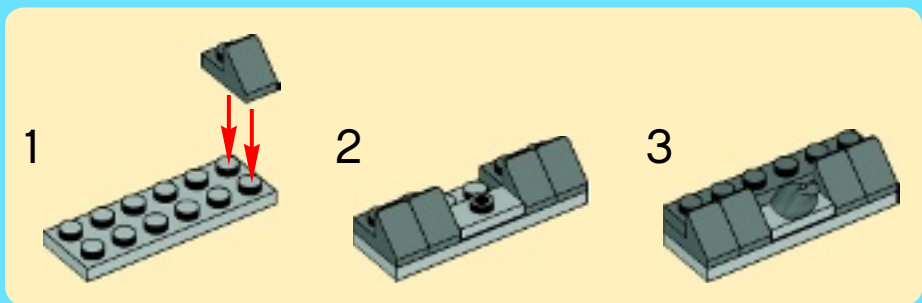
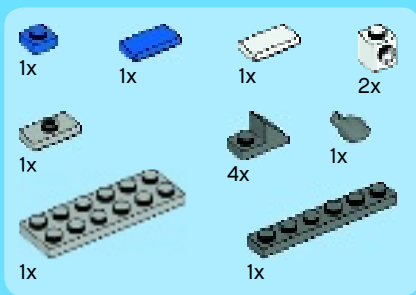

29

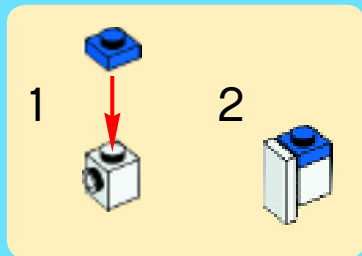
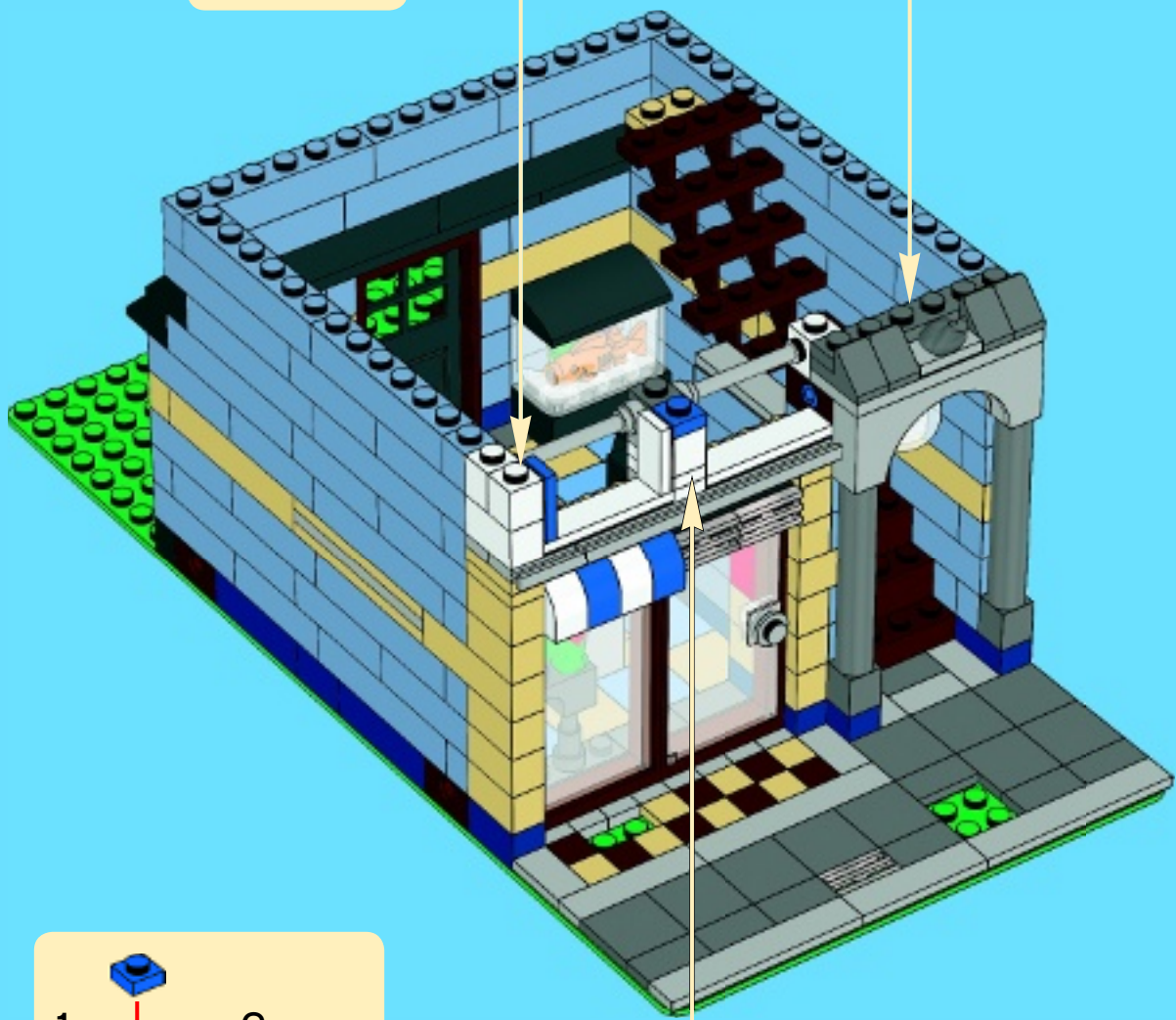
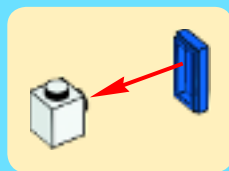



1x



1x



1x



1x



3x



1x

1



2

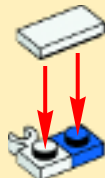

30

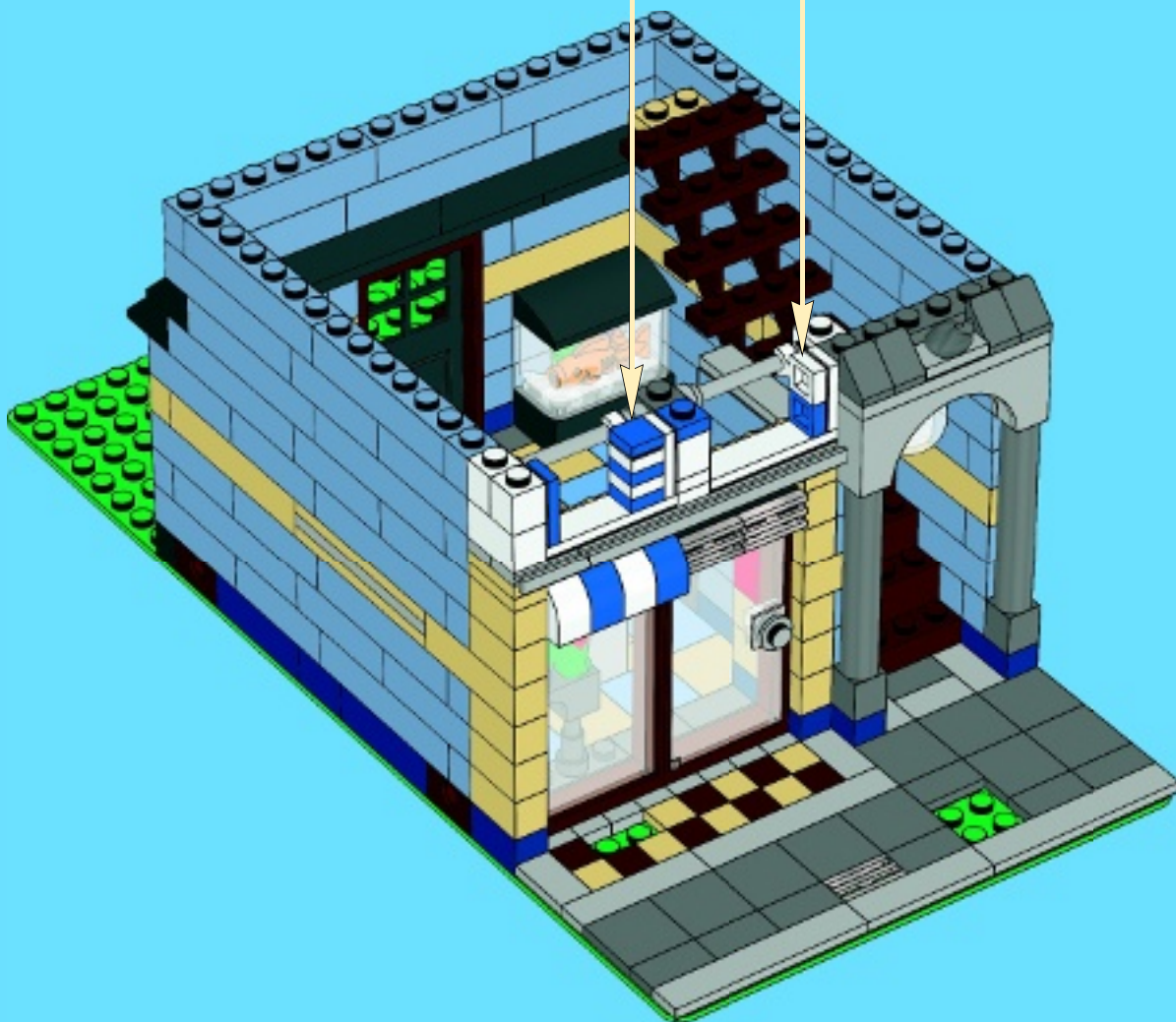

- | | | | |
|----|----|----|----|
| | | | |
| 1x | 3x | 1x | 1x |
| | | | |
| 2x | 2x | 1x | 1x |

31

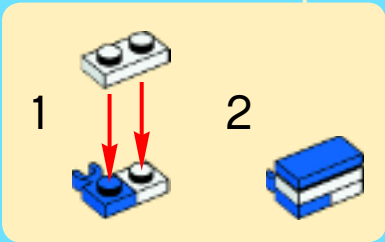
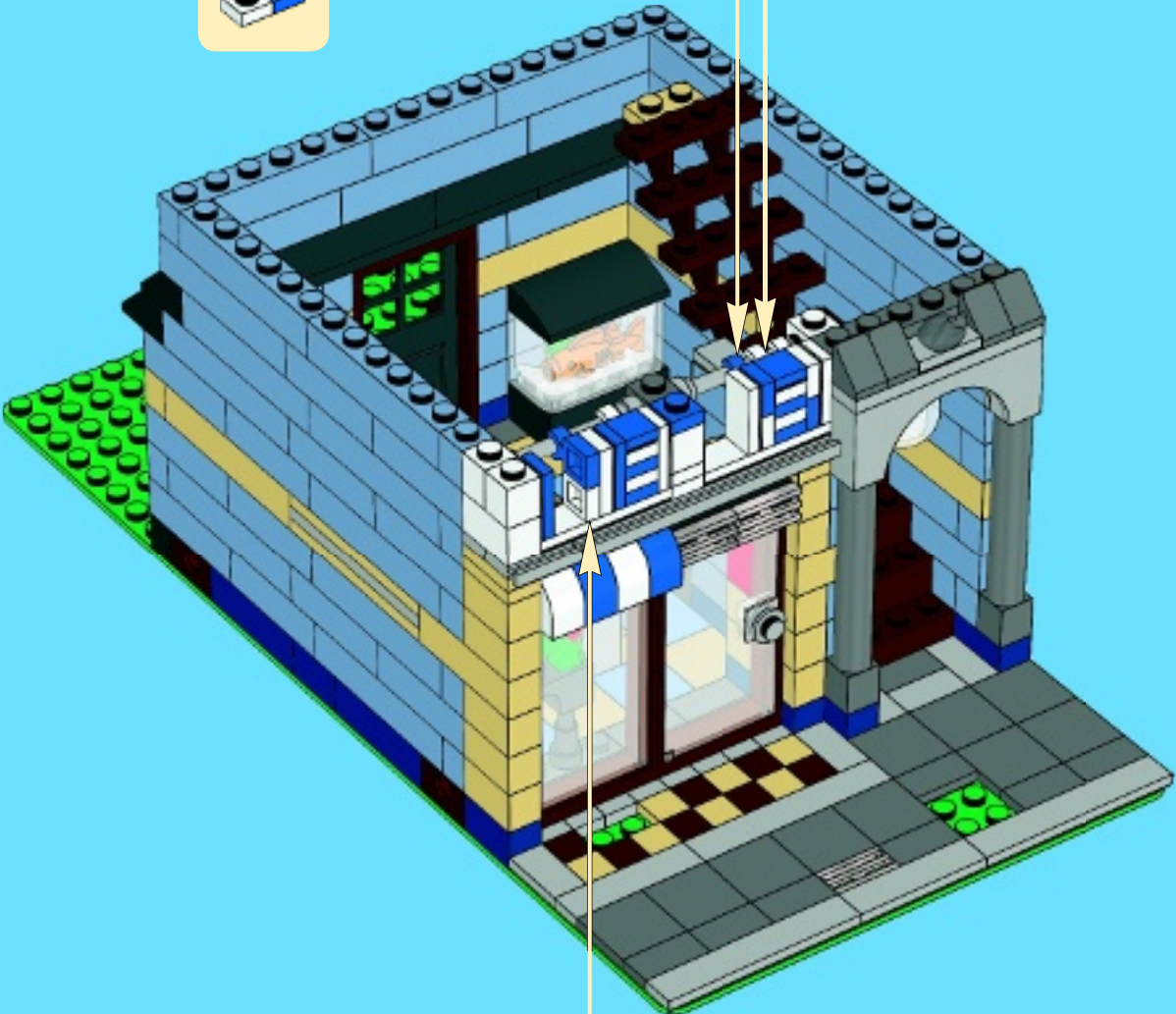
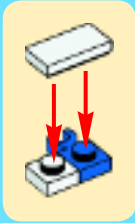
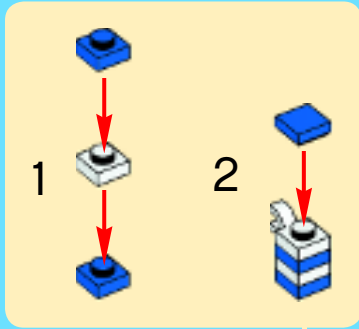

- 1x
- 2x
- 1x
- 1x
- 2x
- 2x

32

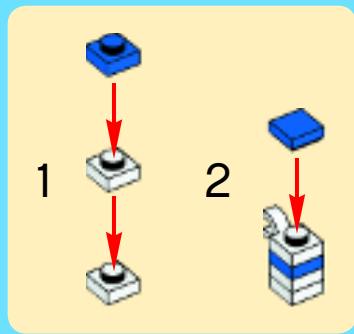
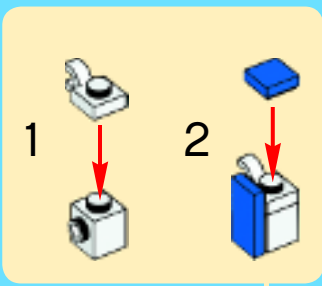

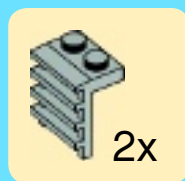
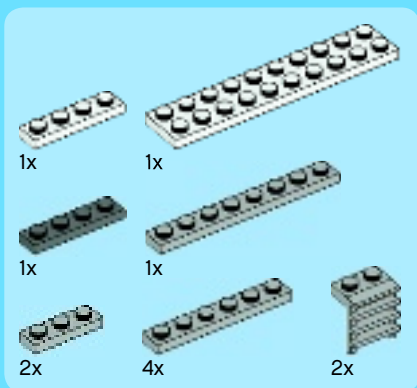

33



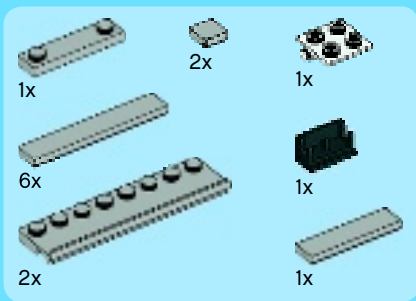

34

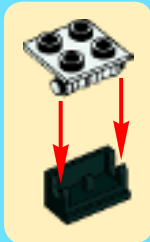

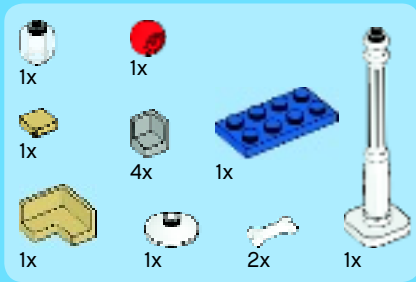

35

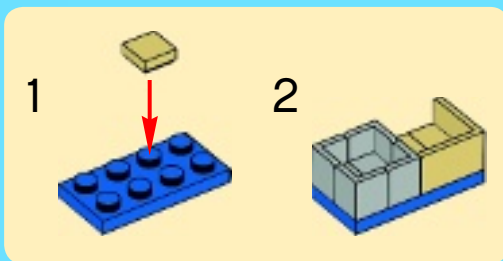
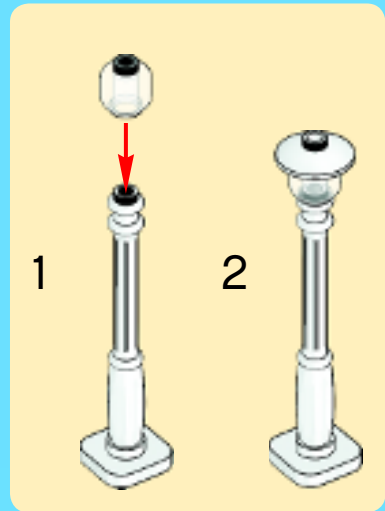

36

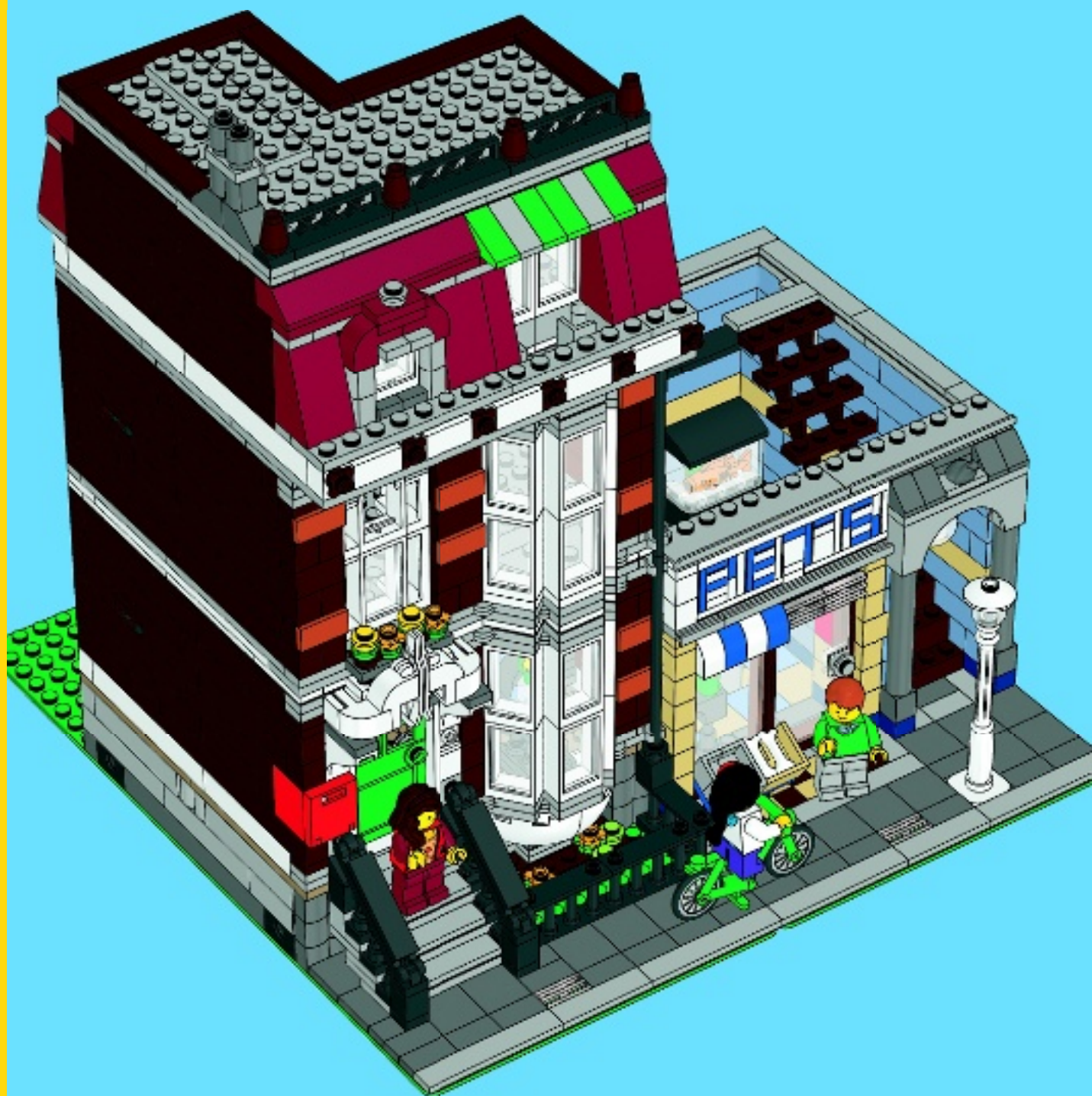



4

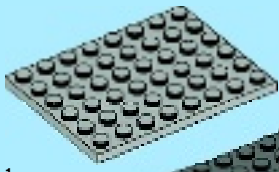
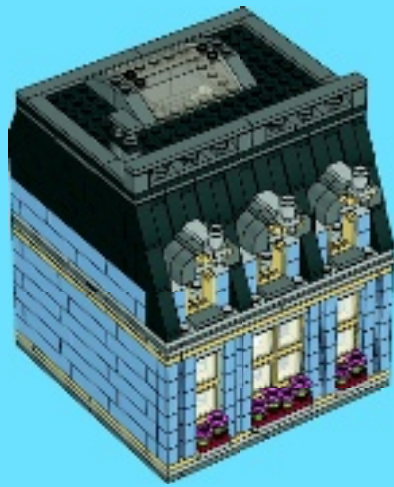

1x

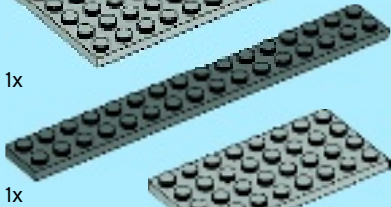

1x

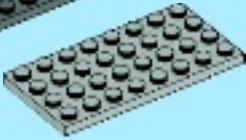

1x

1

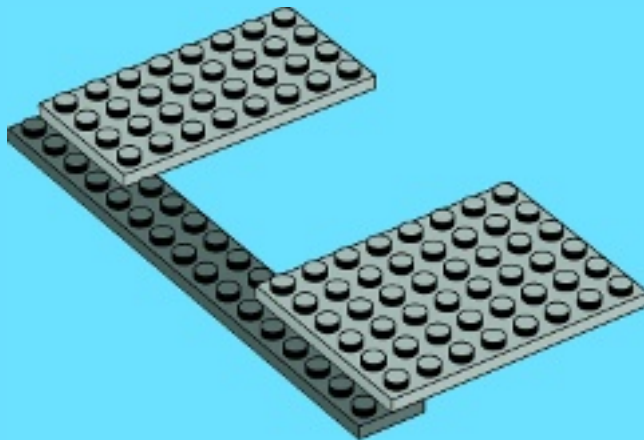



1x

2

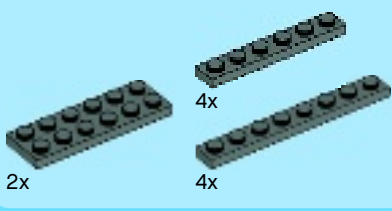
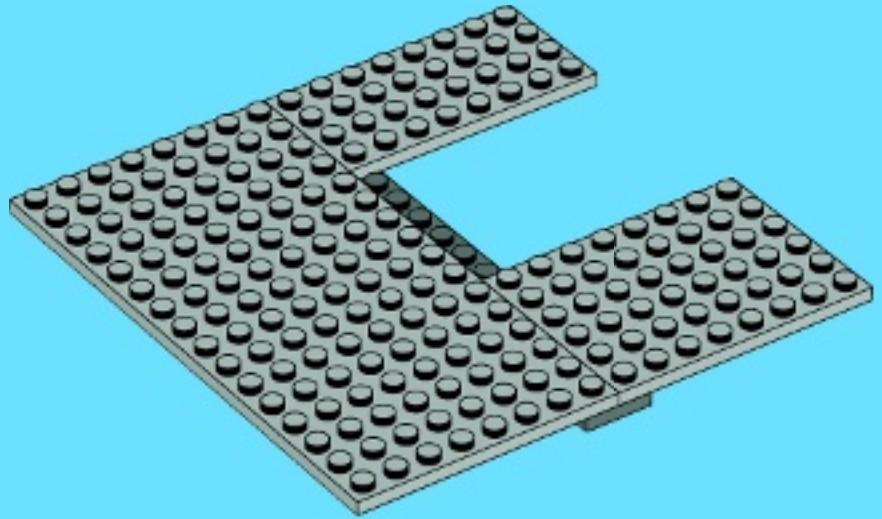

2x

4x

4x



3

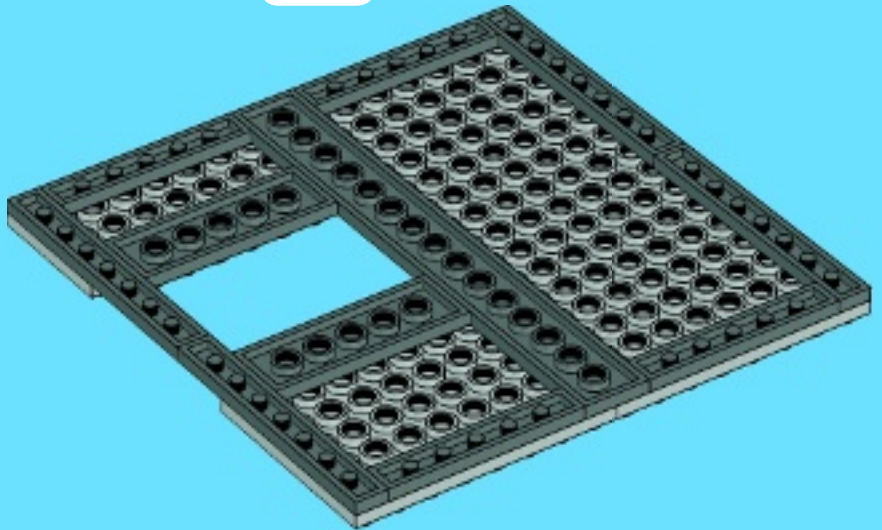

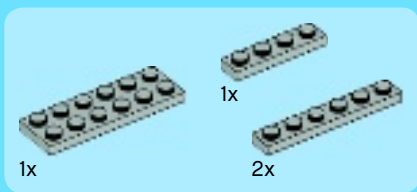

4

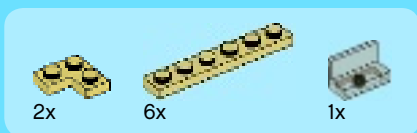
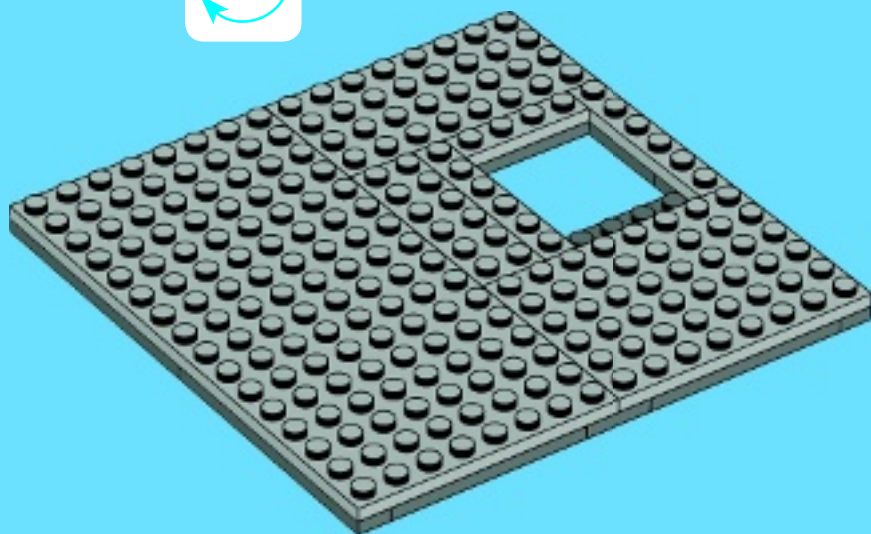

5

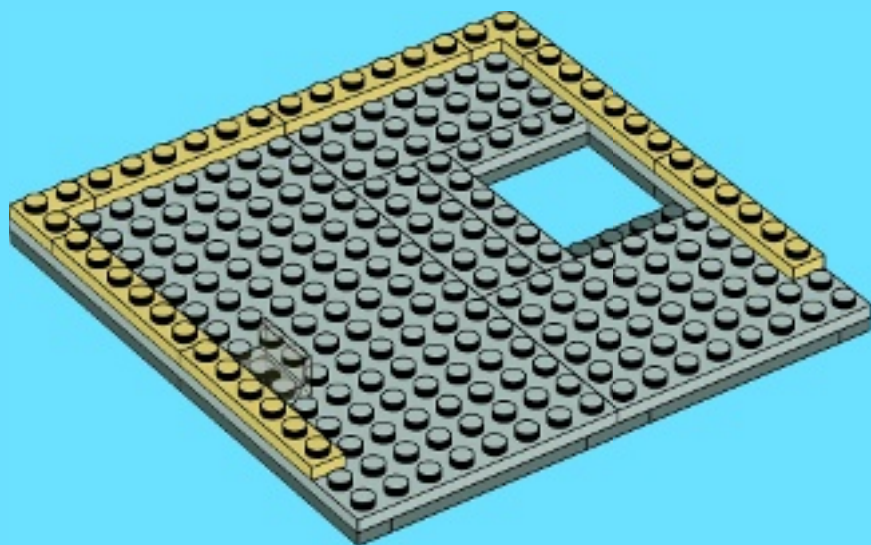

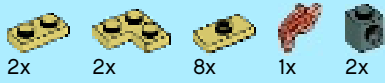

6

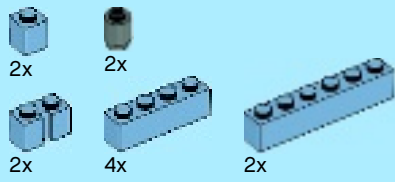
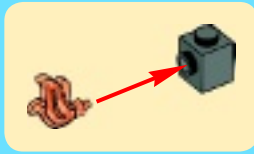
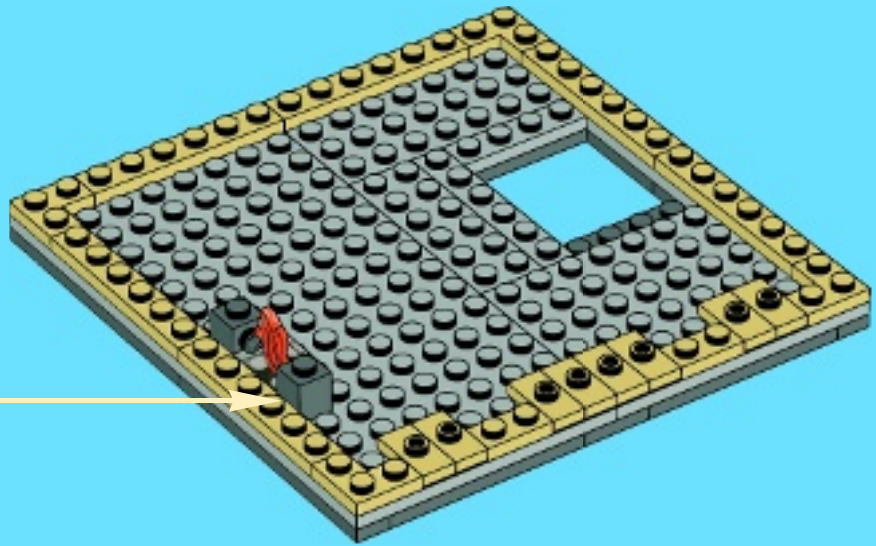

7

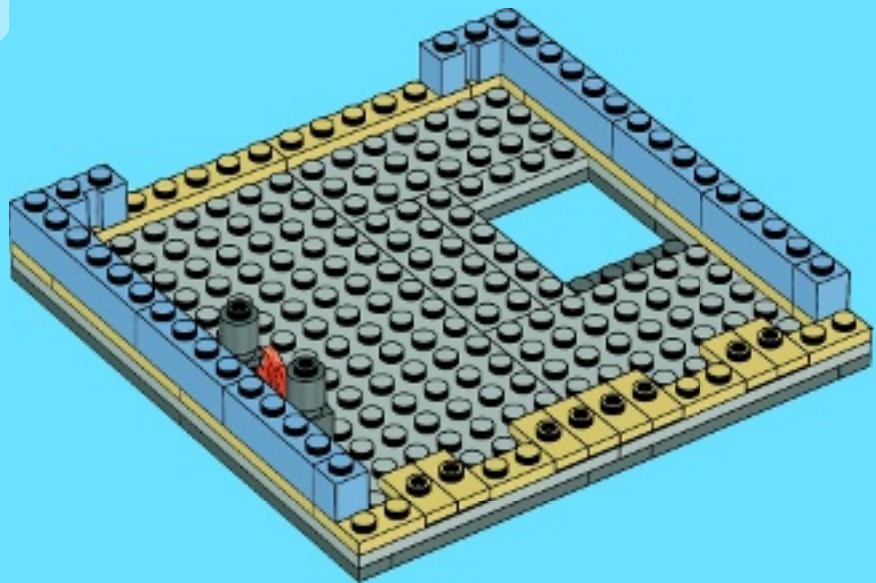

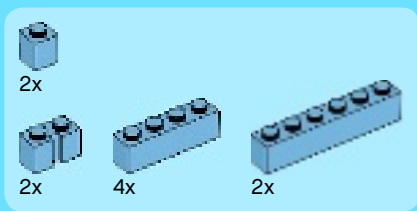

8

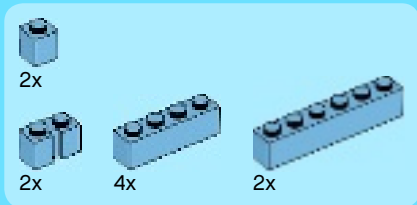
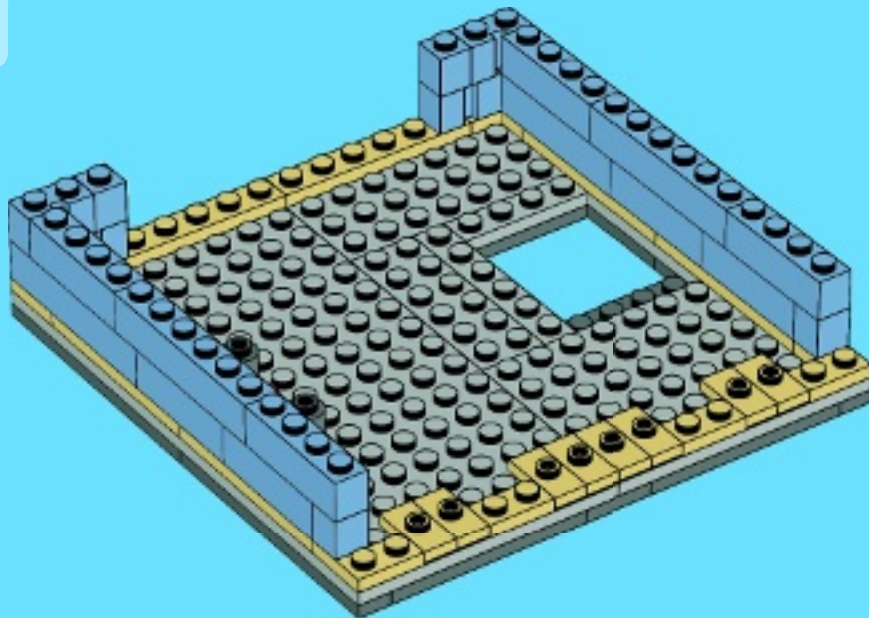

9

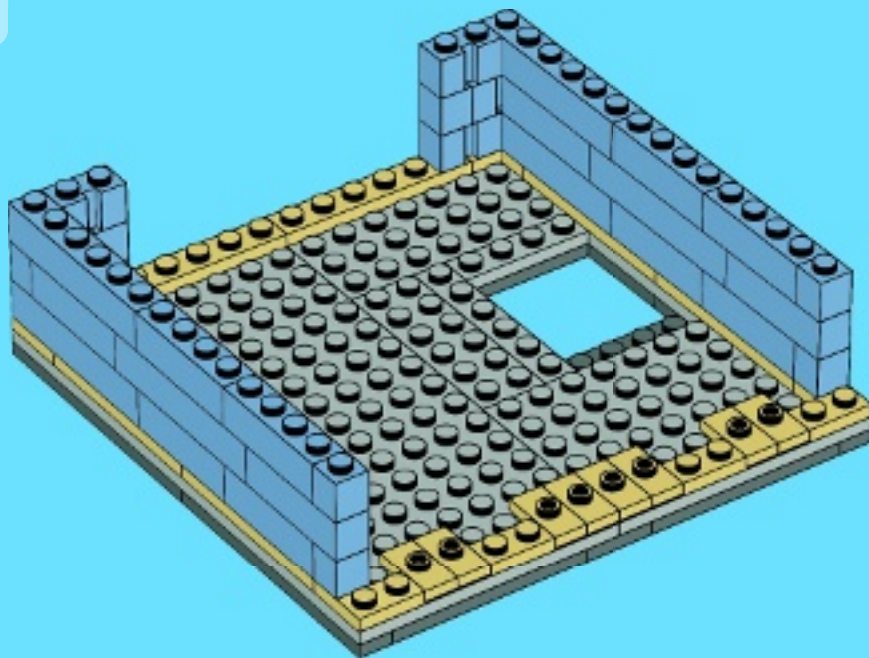



10

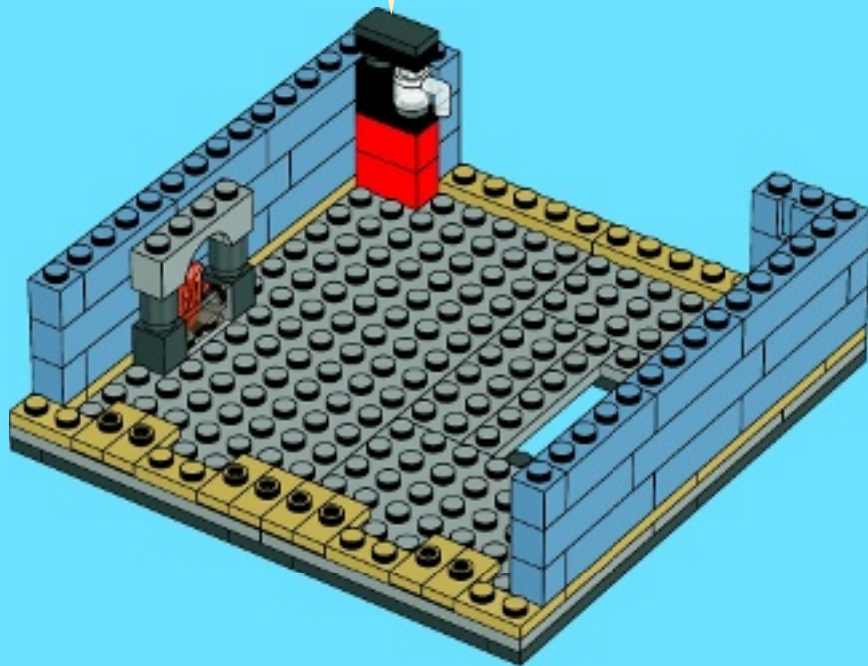
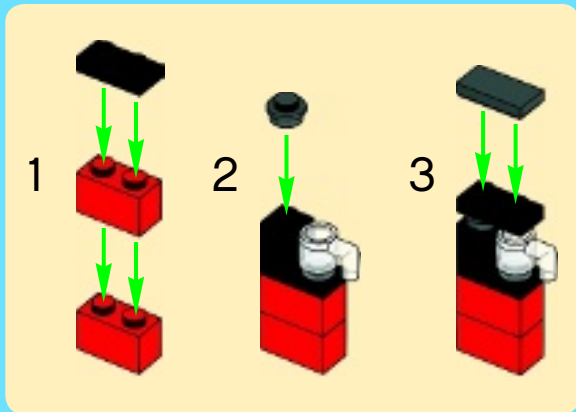



11

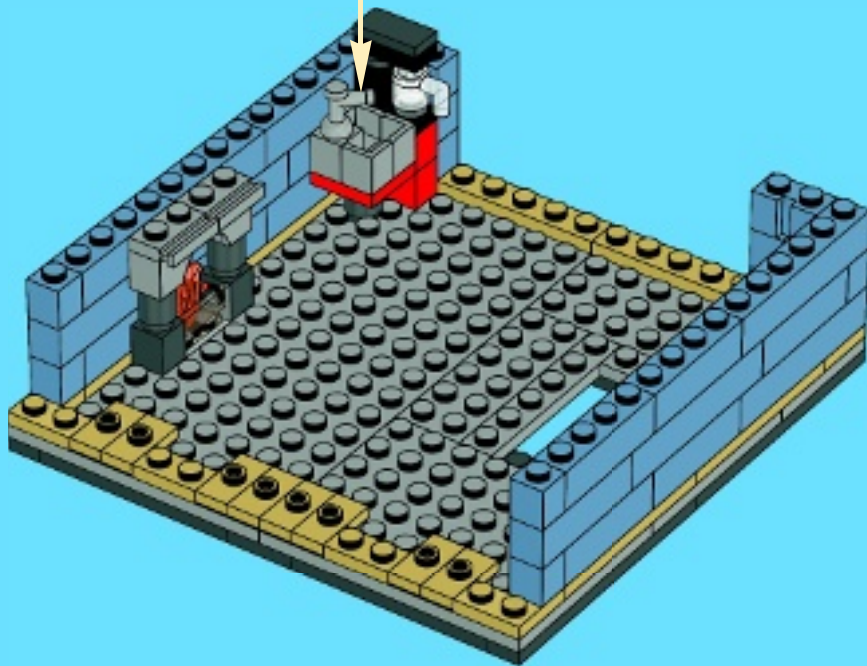
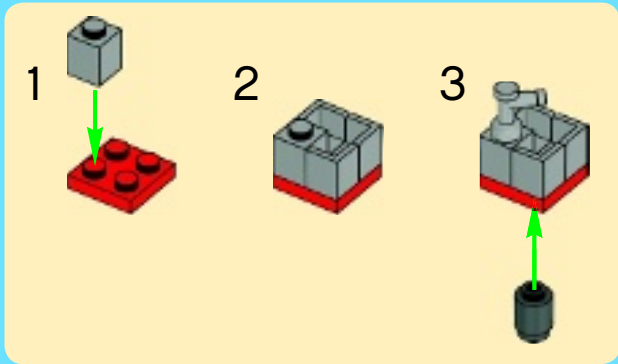

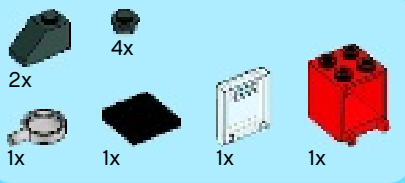

12

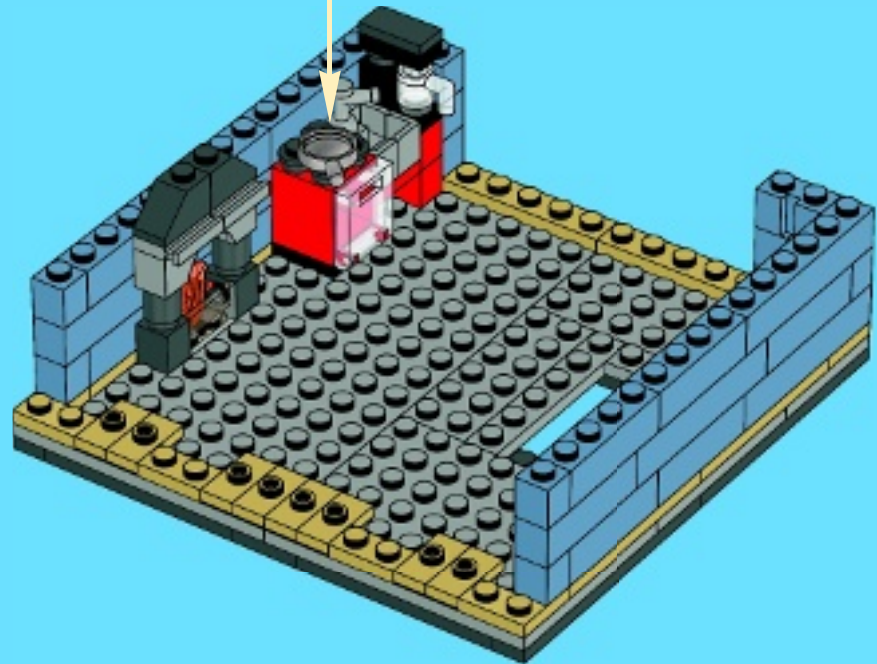
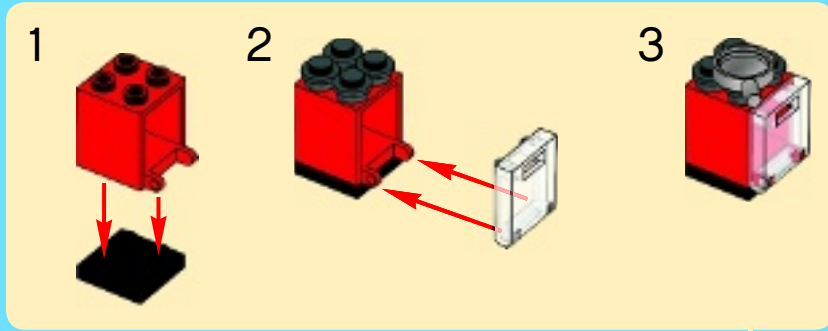

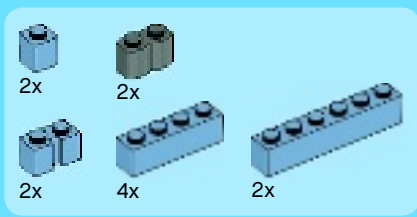

13

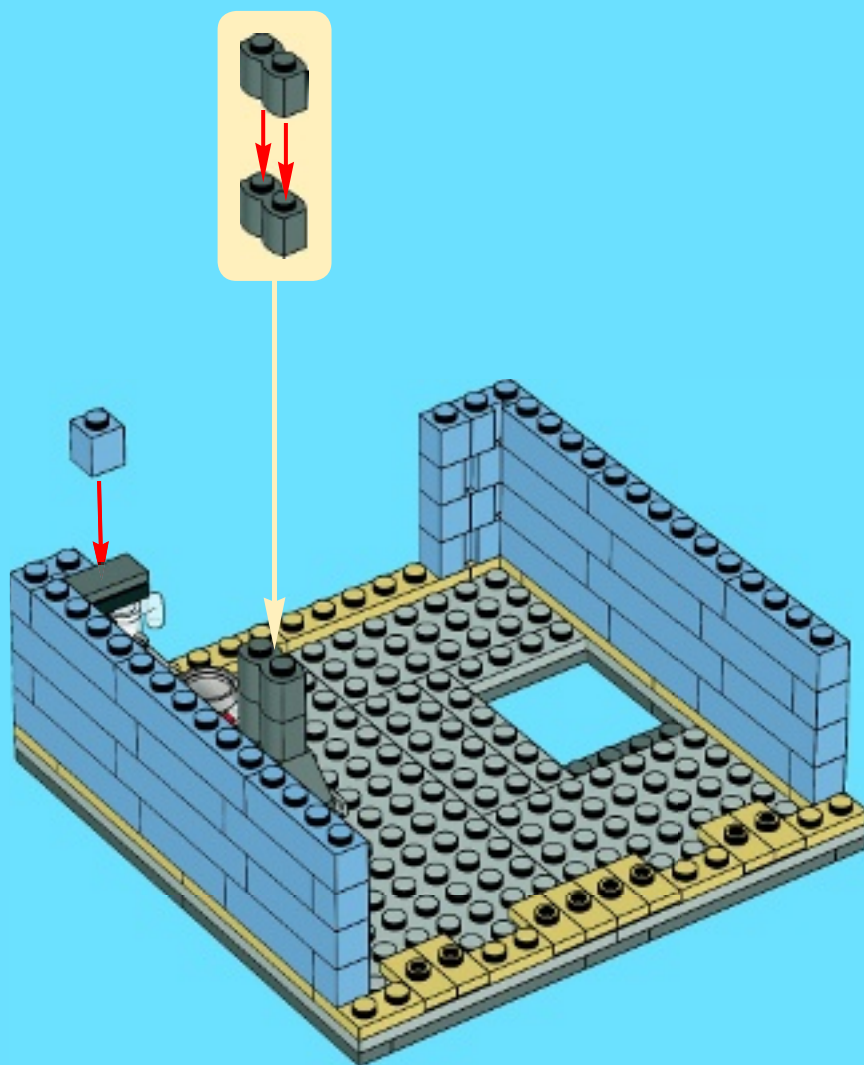

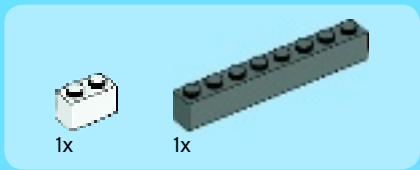
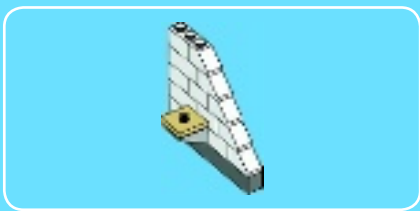

1

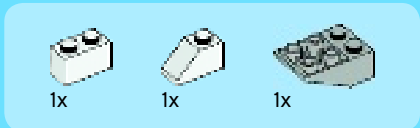
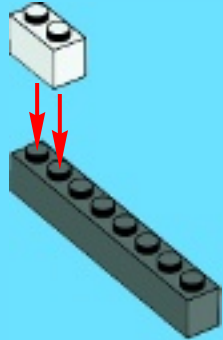

2

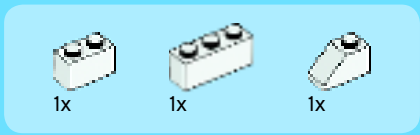

3

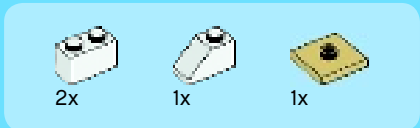
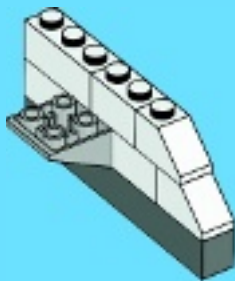

4

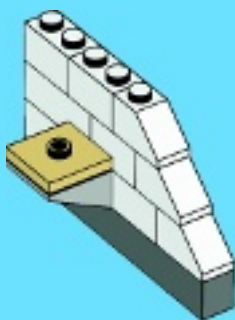



1x



1x

5

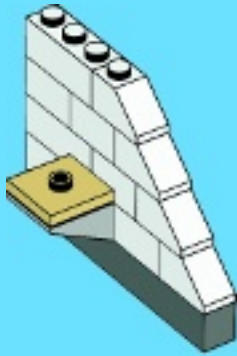

1x



1x

6

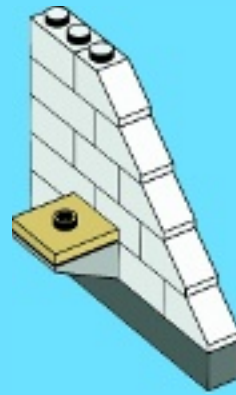

15

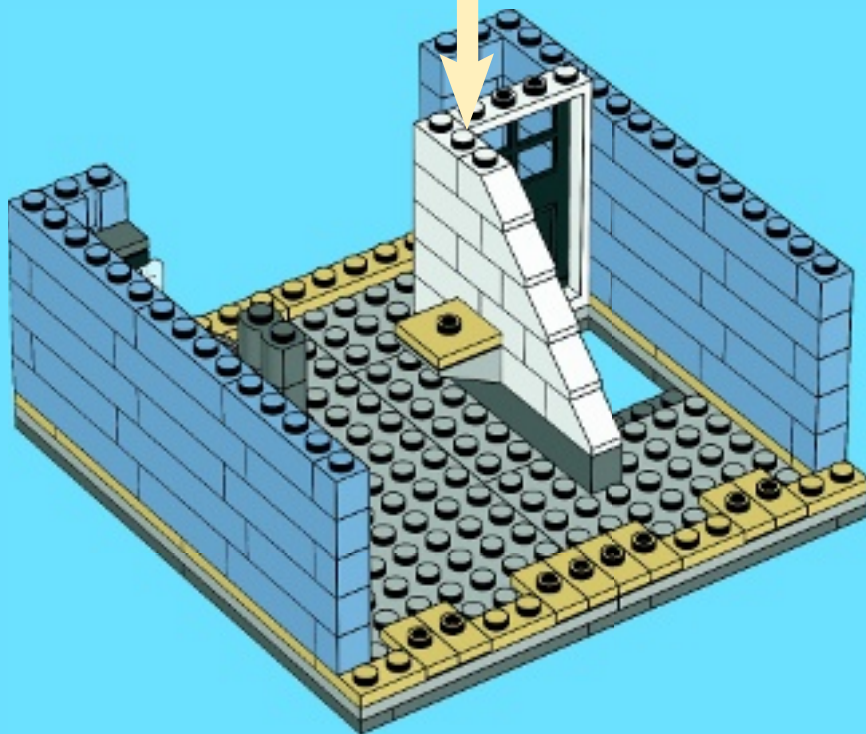

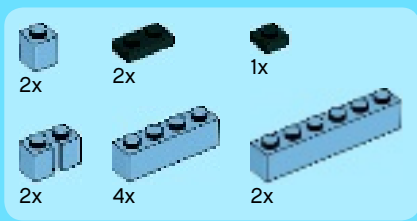

16

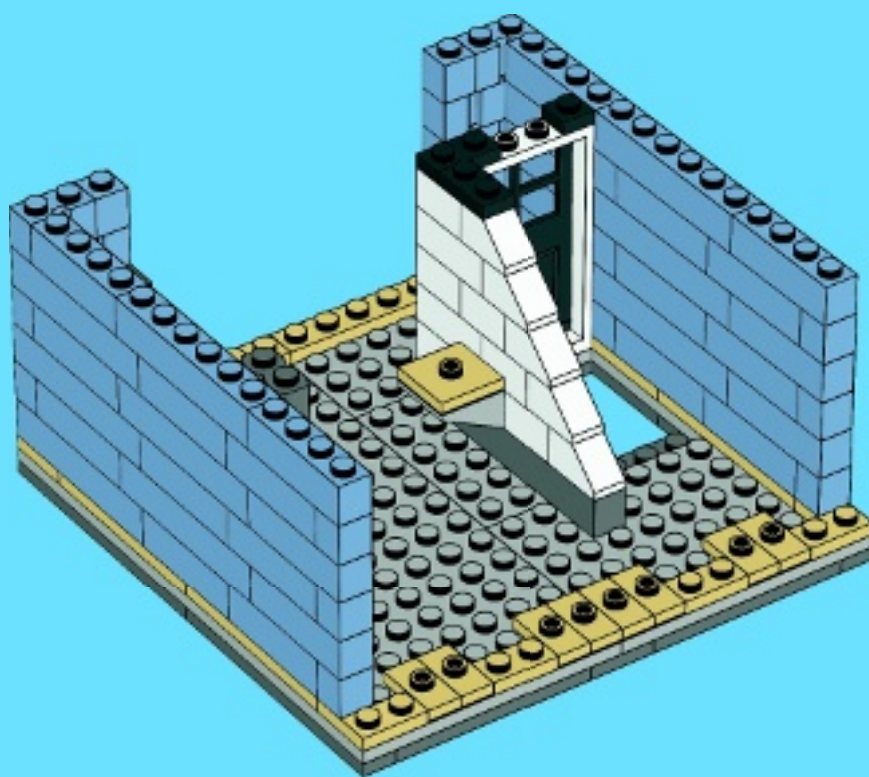

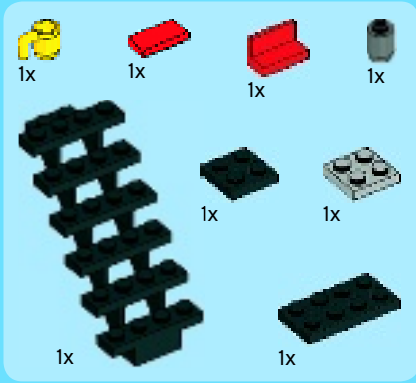

17

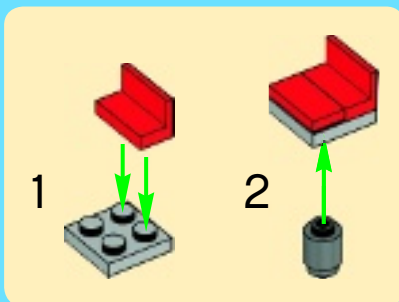
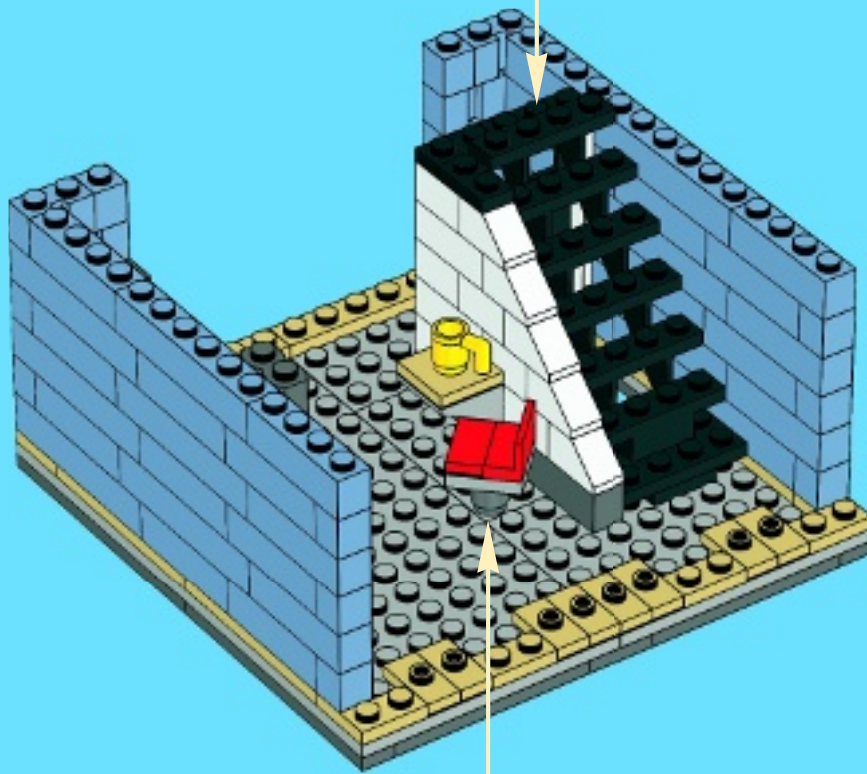
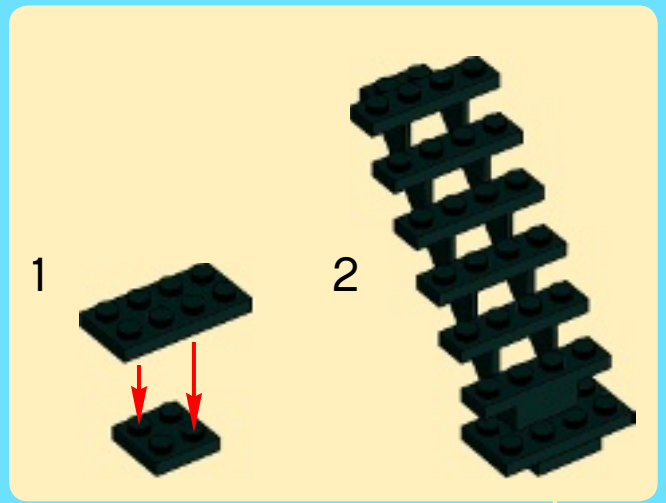



30x

18

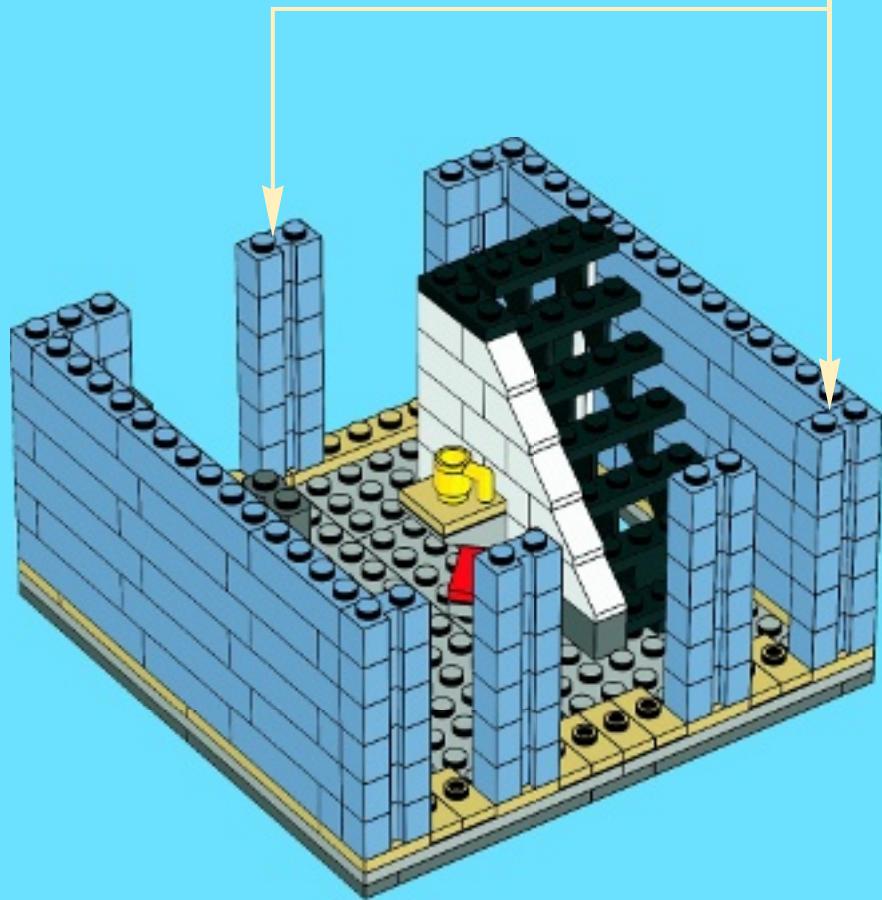
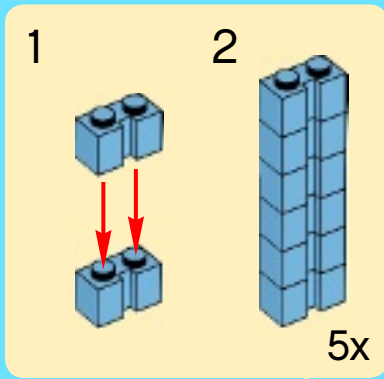

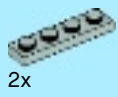

2x



8x



4x

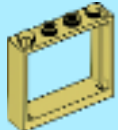

2x



2x



4x

19

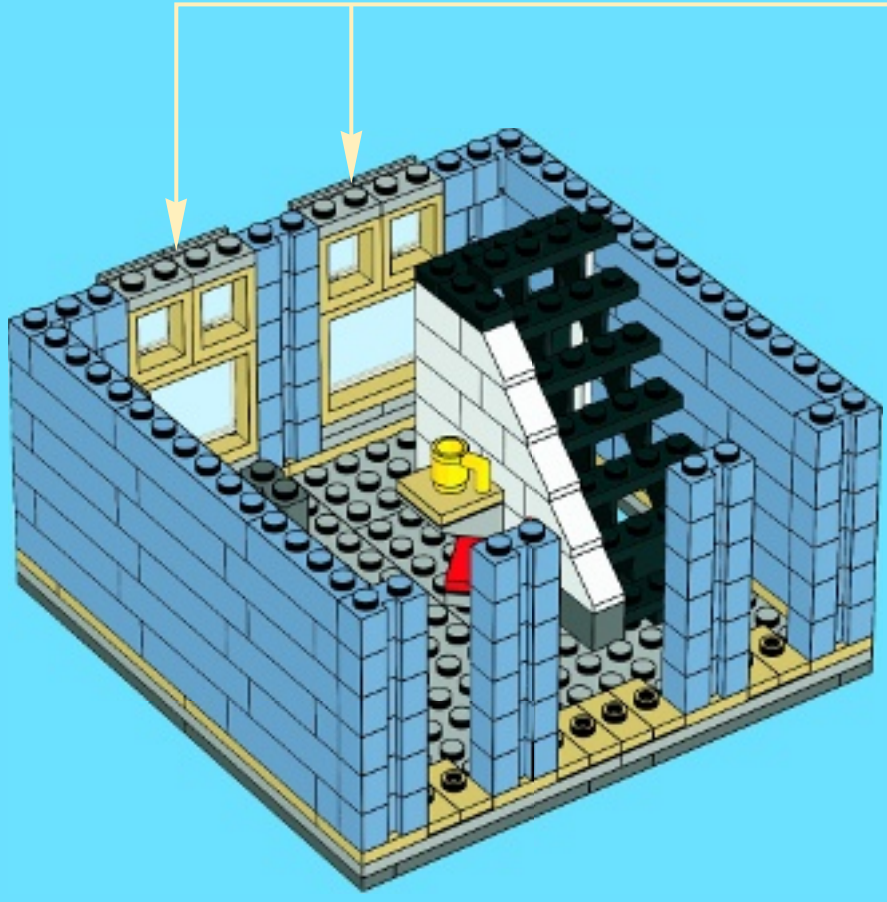
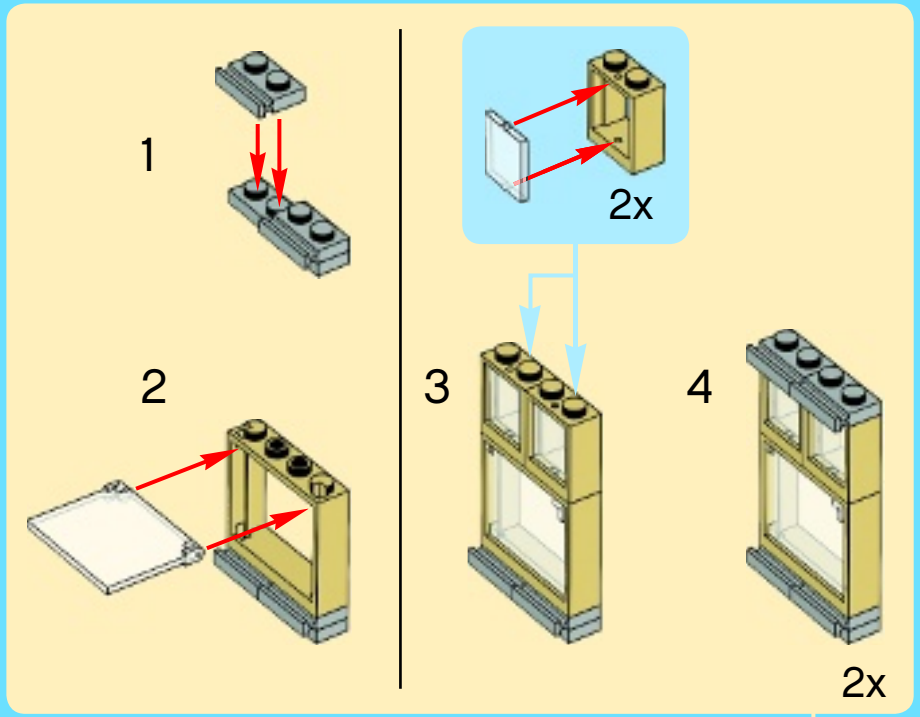

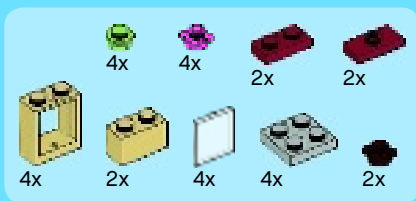

20

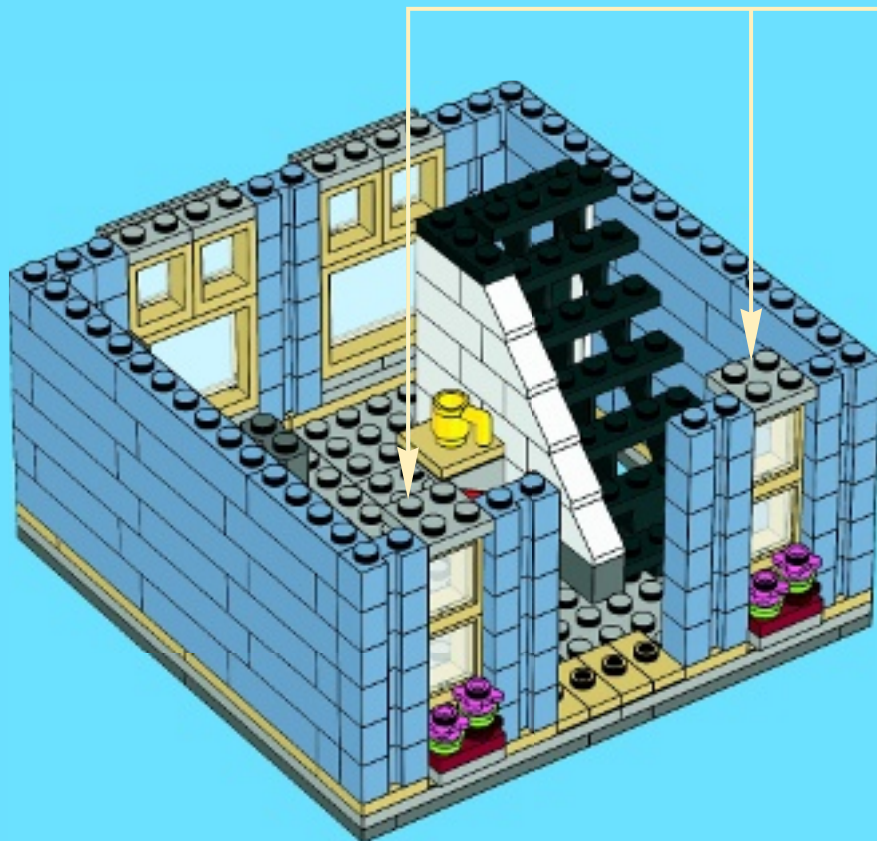
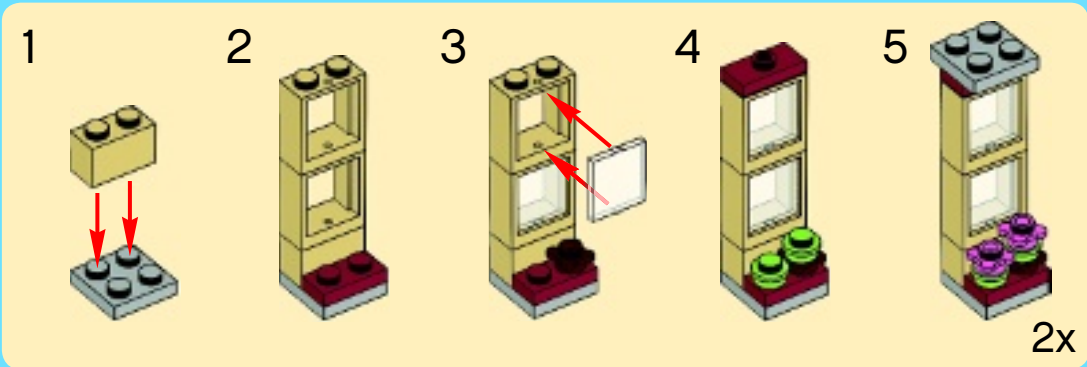

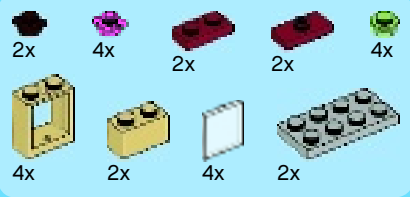

21

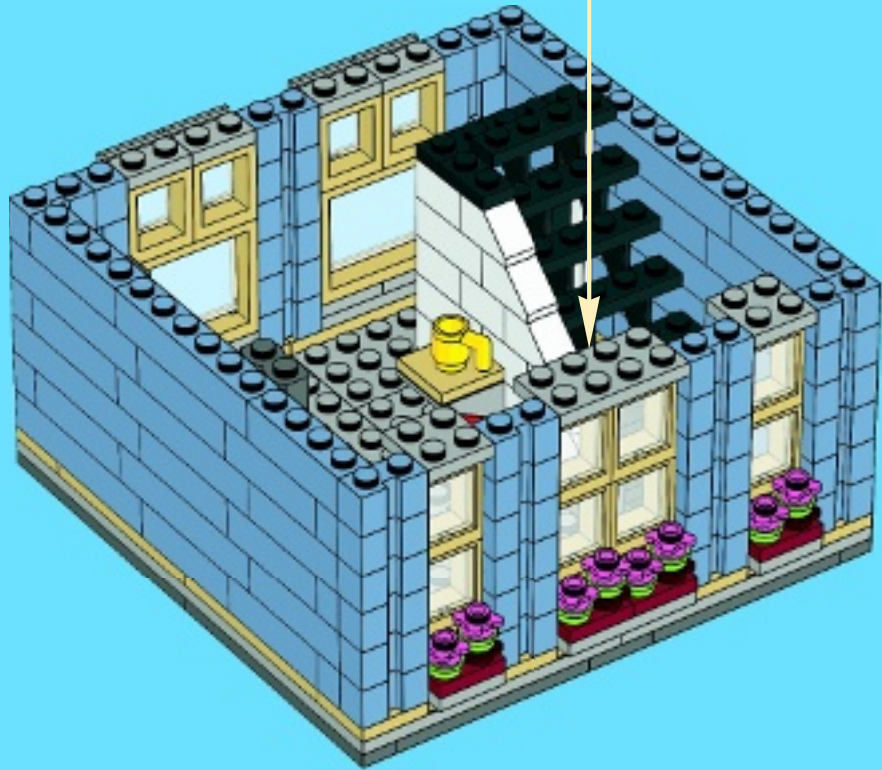
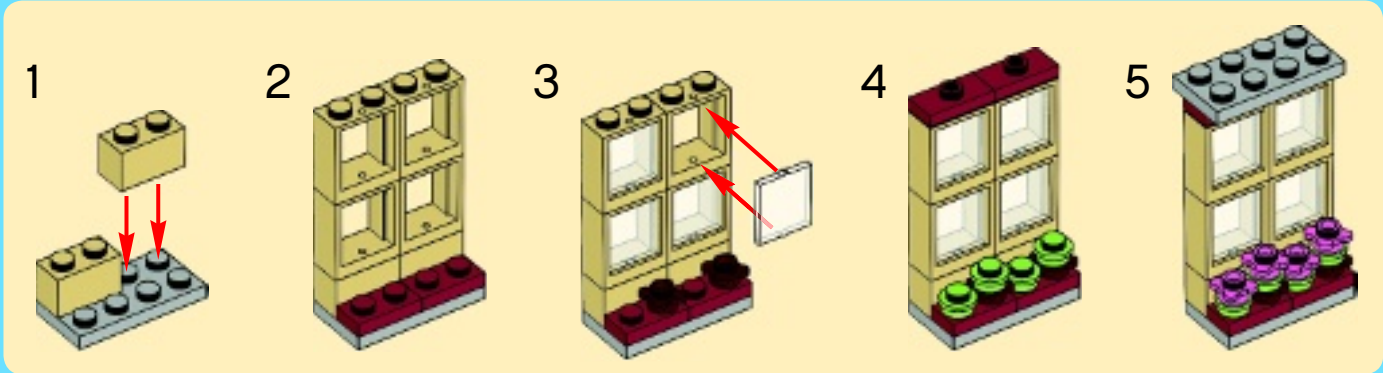

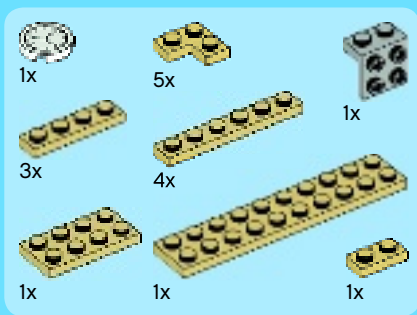

22

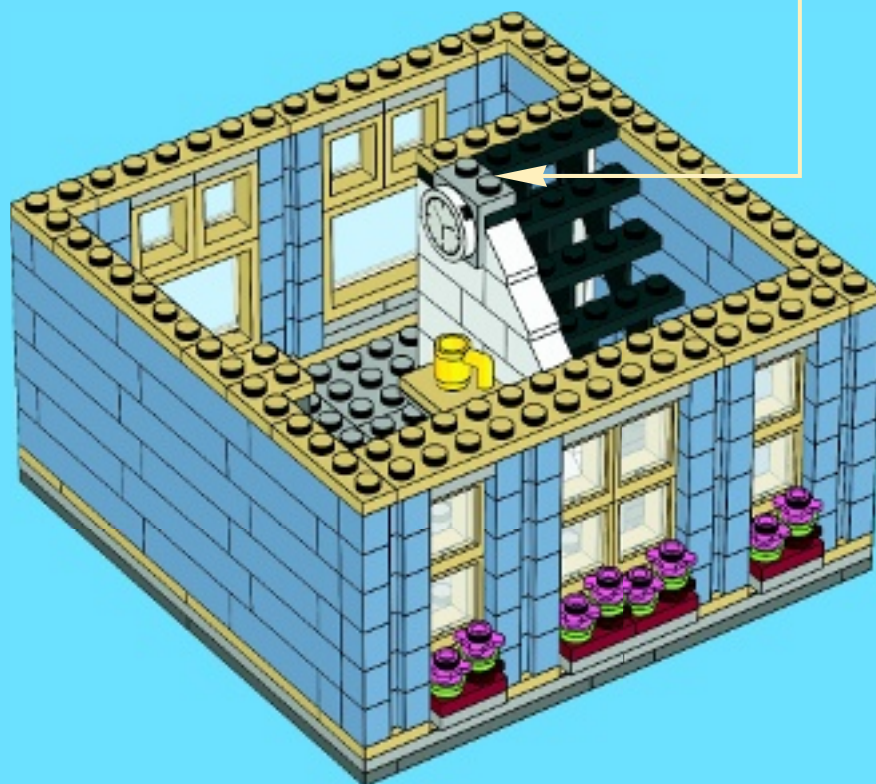
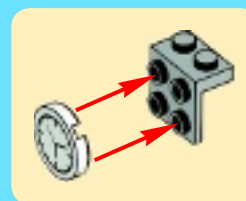

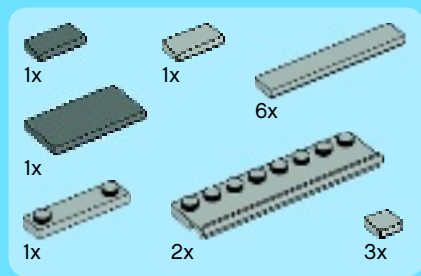

23

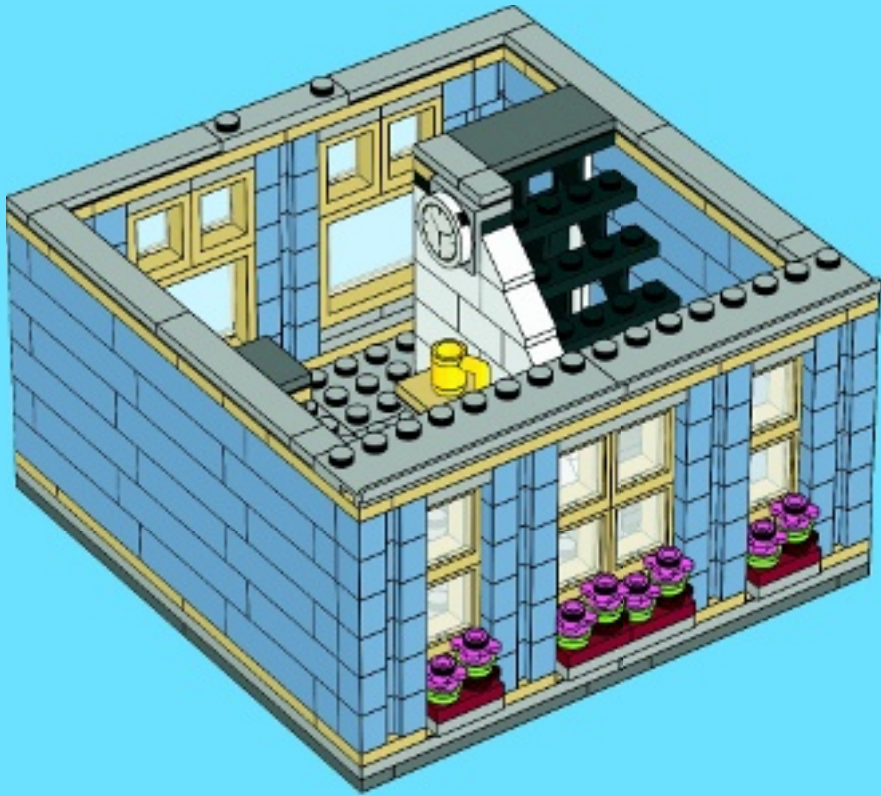

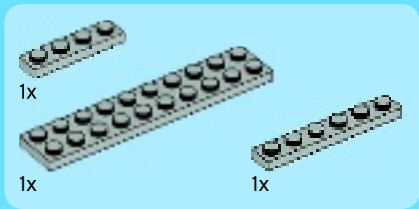
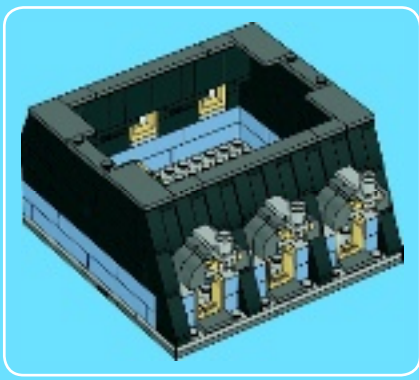

1

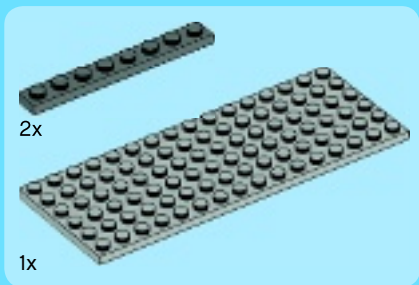
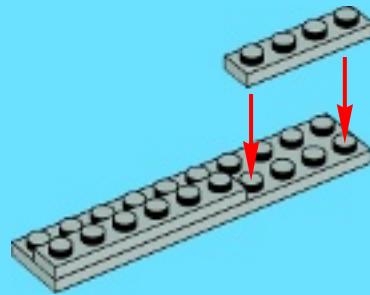

2

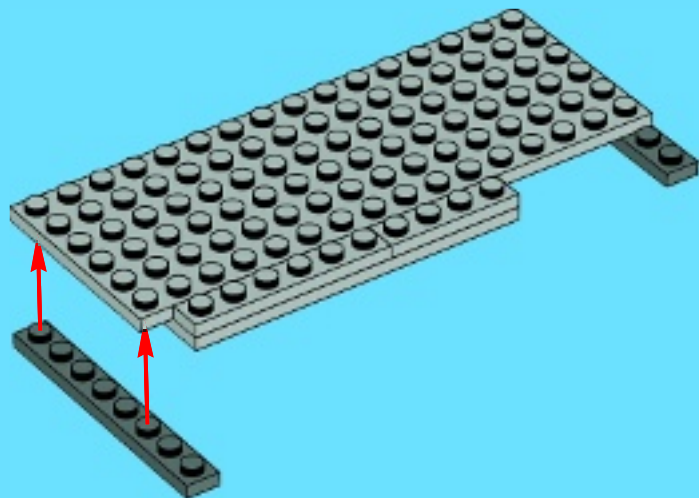

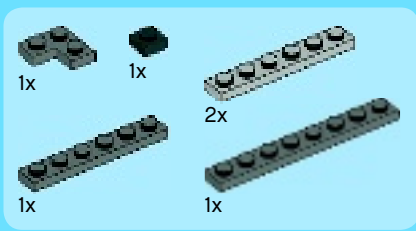

3

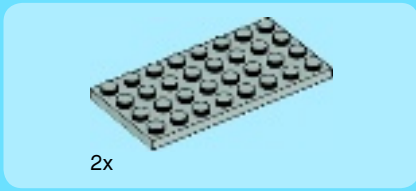
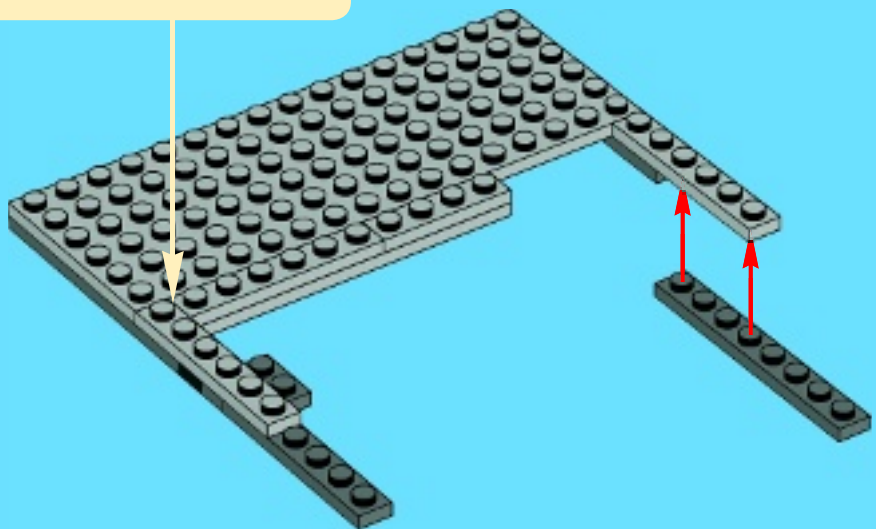
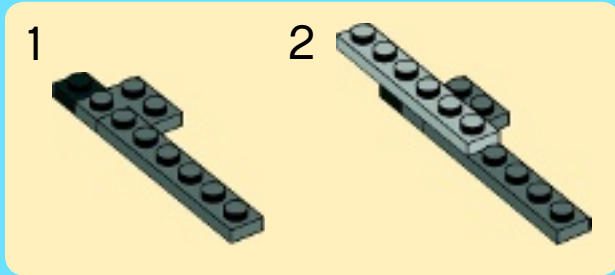

4

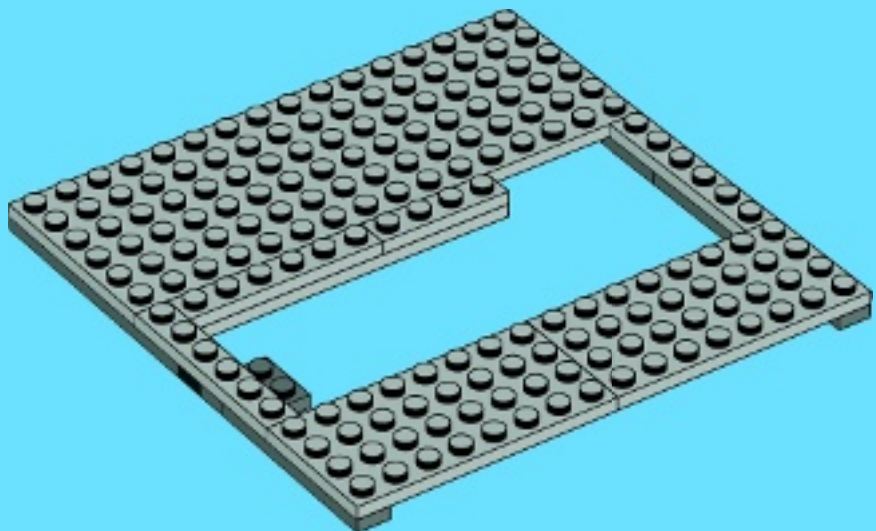

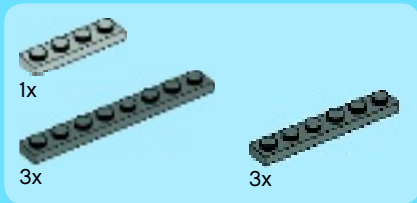

5

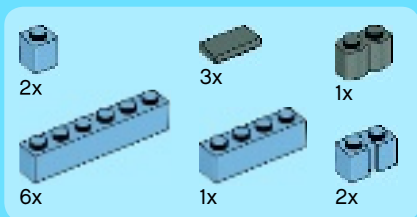
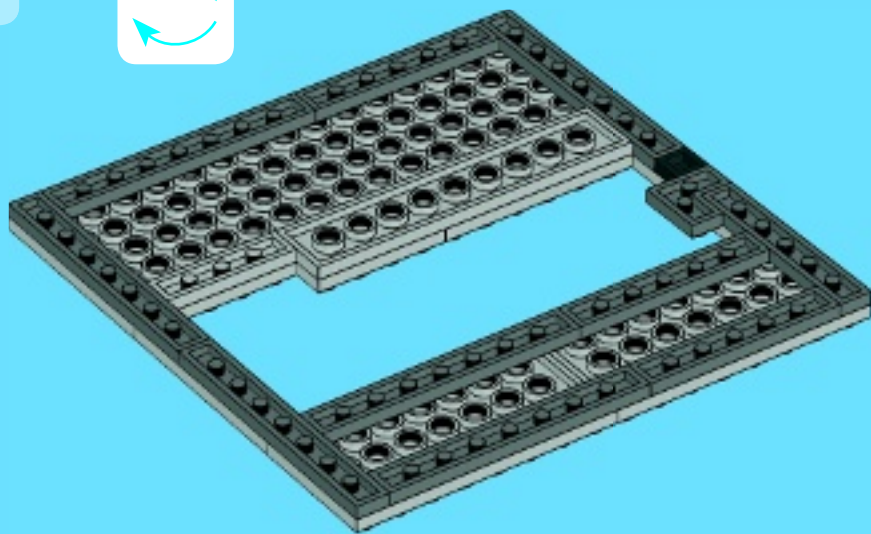

6

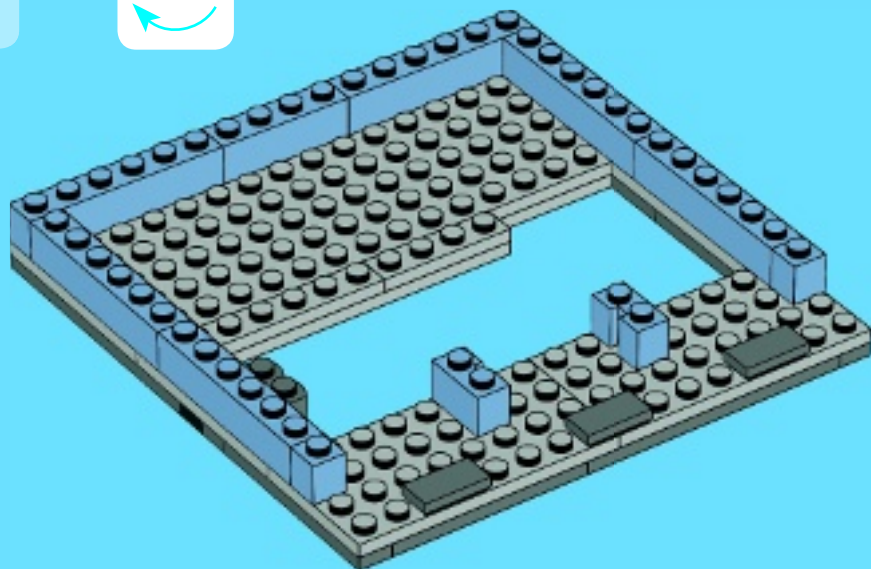

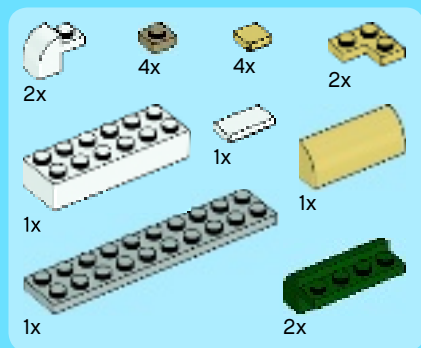

7

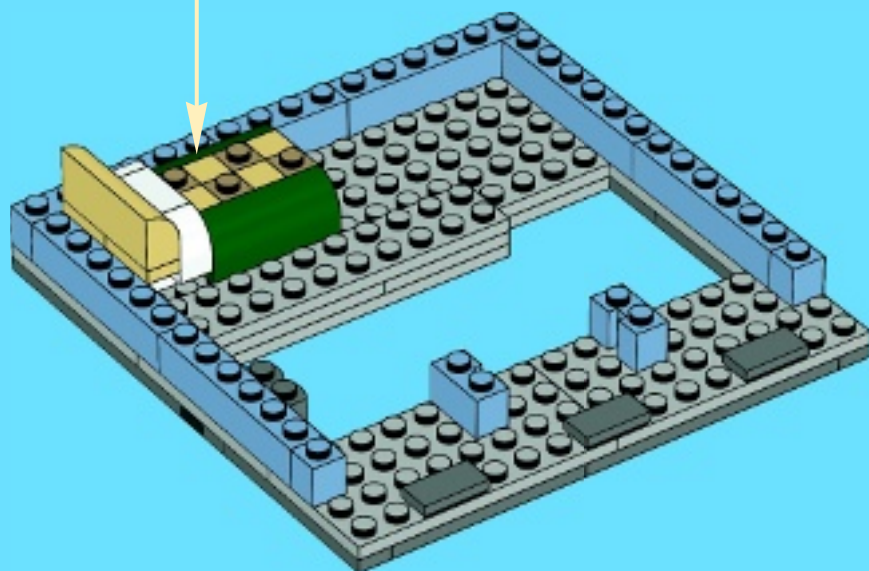
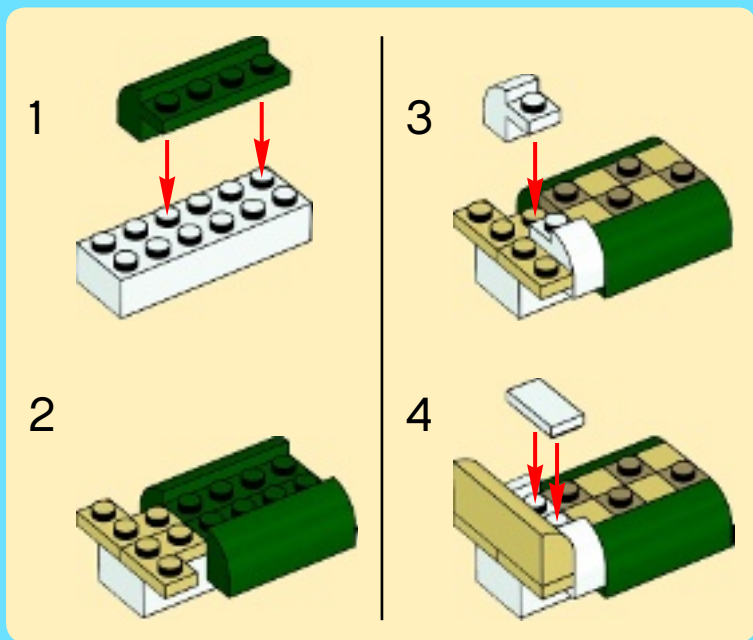

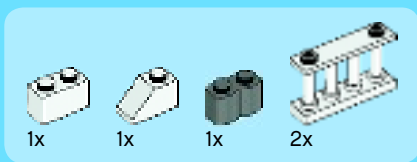

8

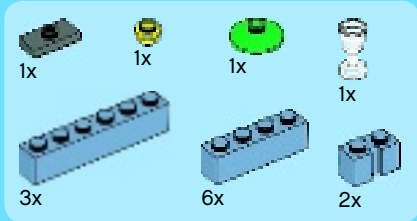
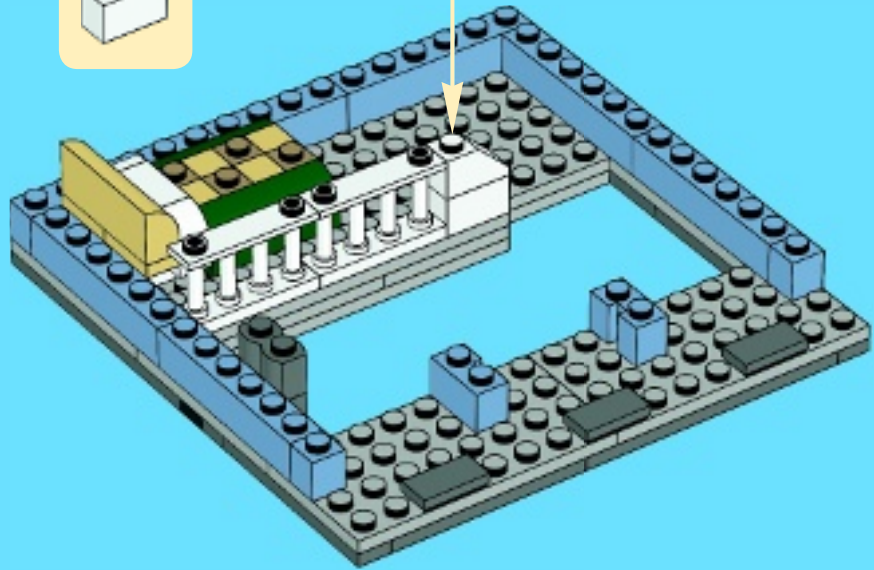
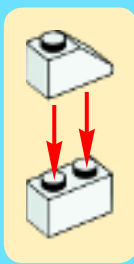

9

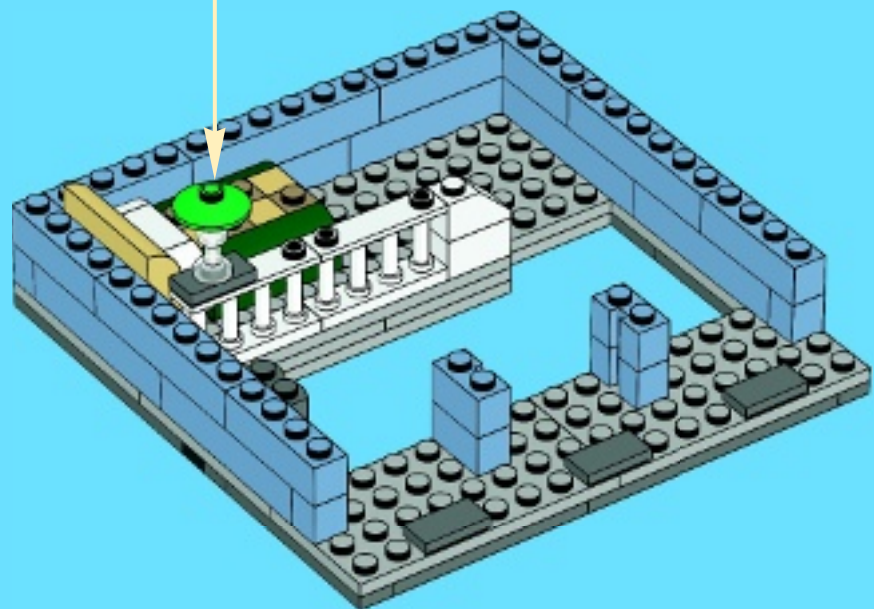



10

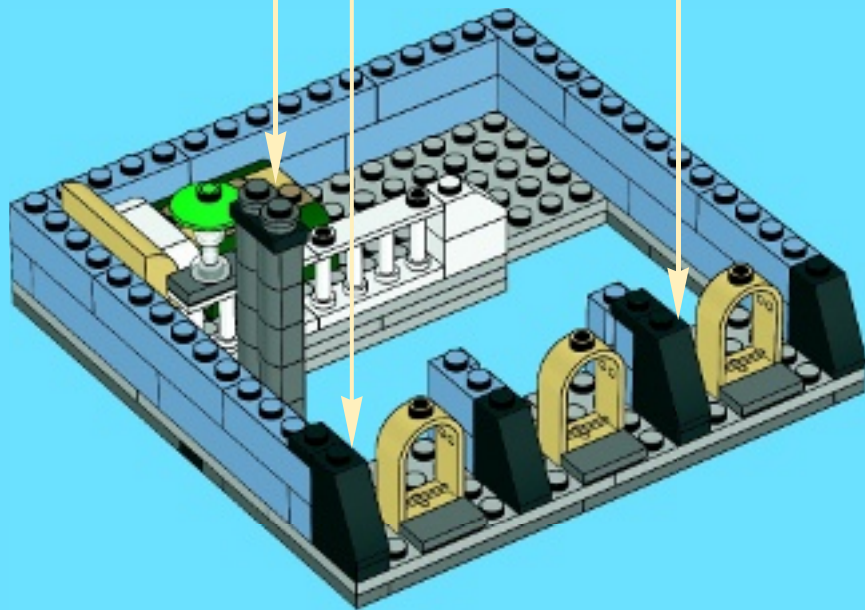
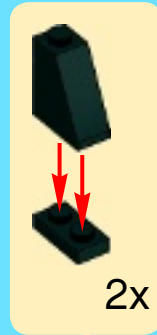
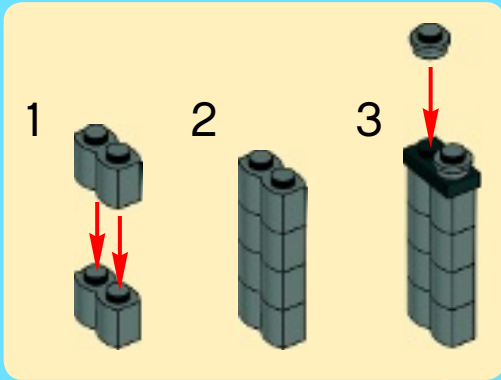

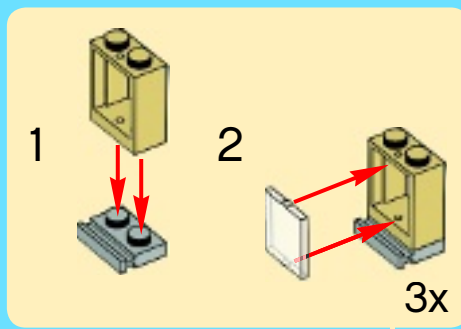
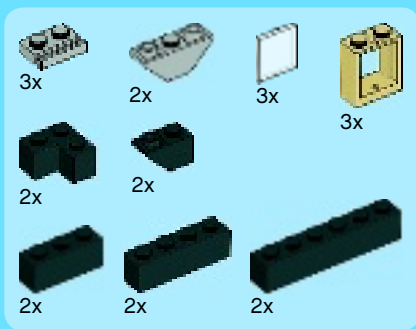

11

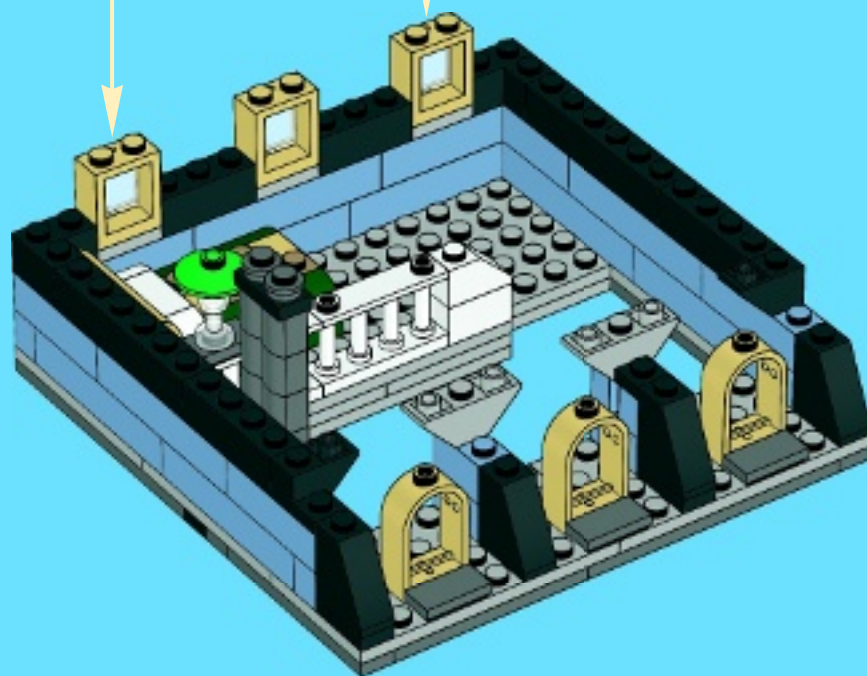



2x



4x



3x



12x

12

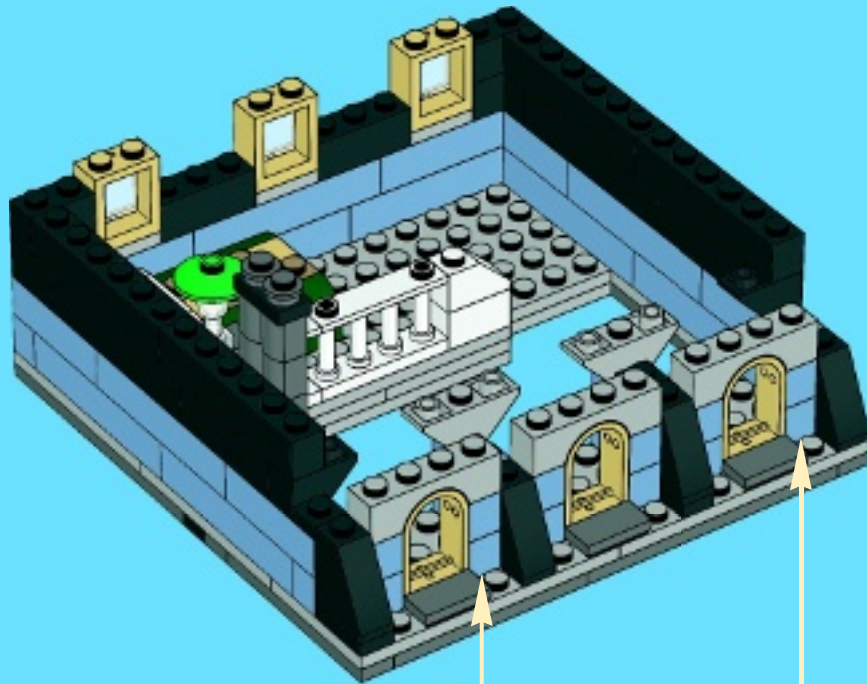

1

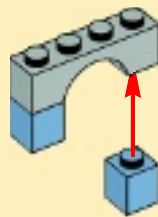

2

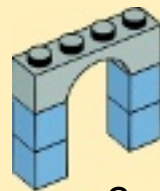

3x

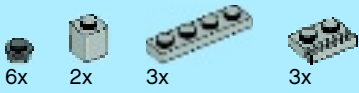

13

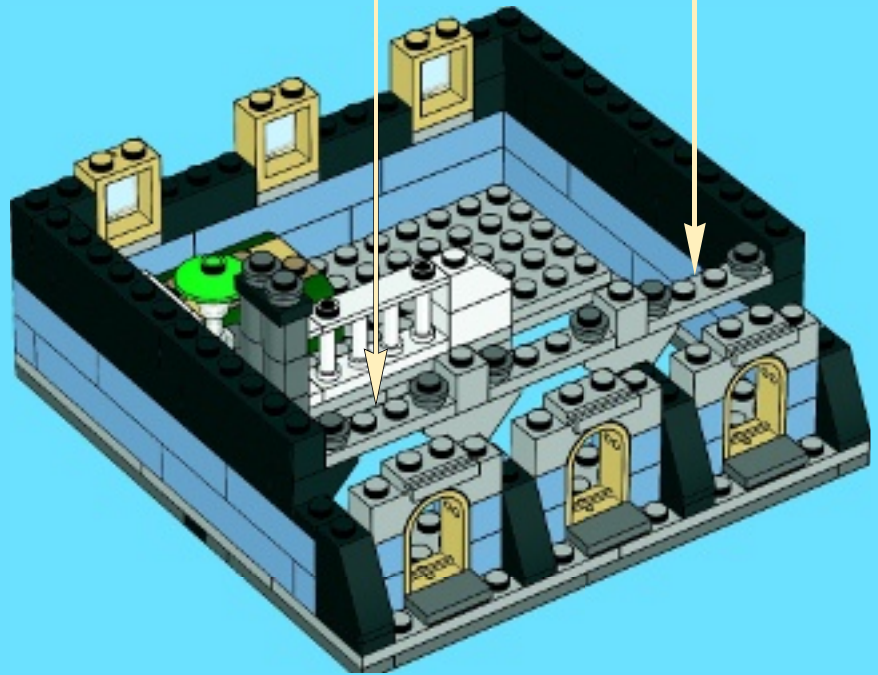
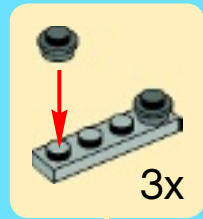

14

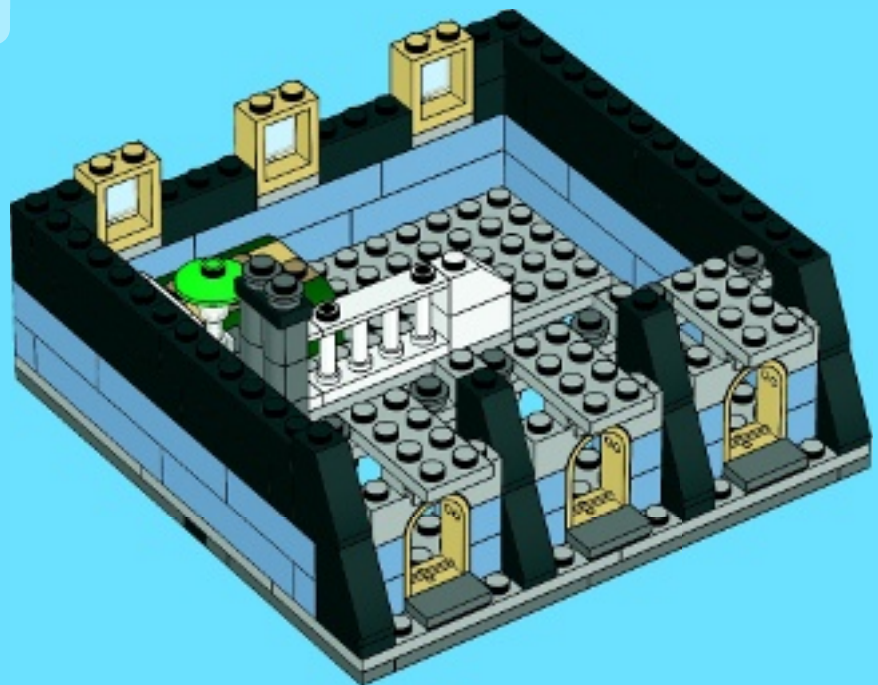



3x



2x



4x

15

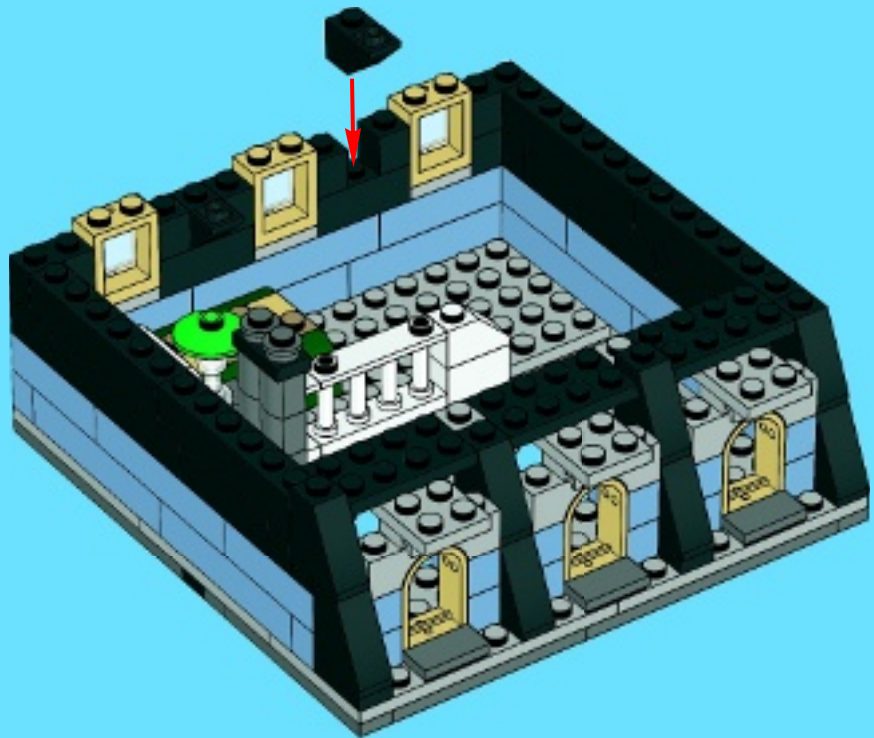

12x



2x



2x



2x

16

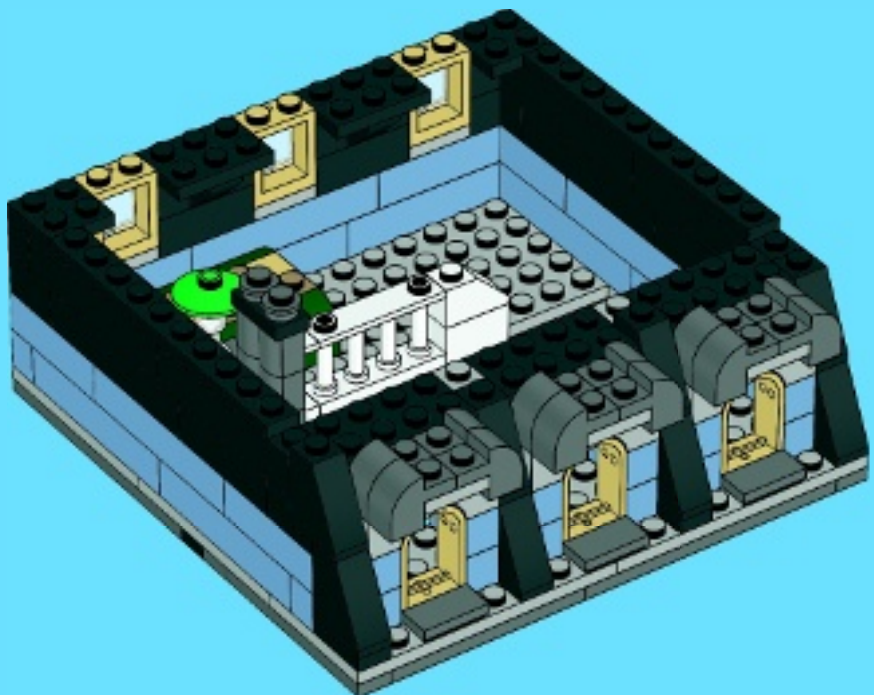



6x



2x



3x



3x

17

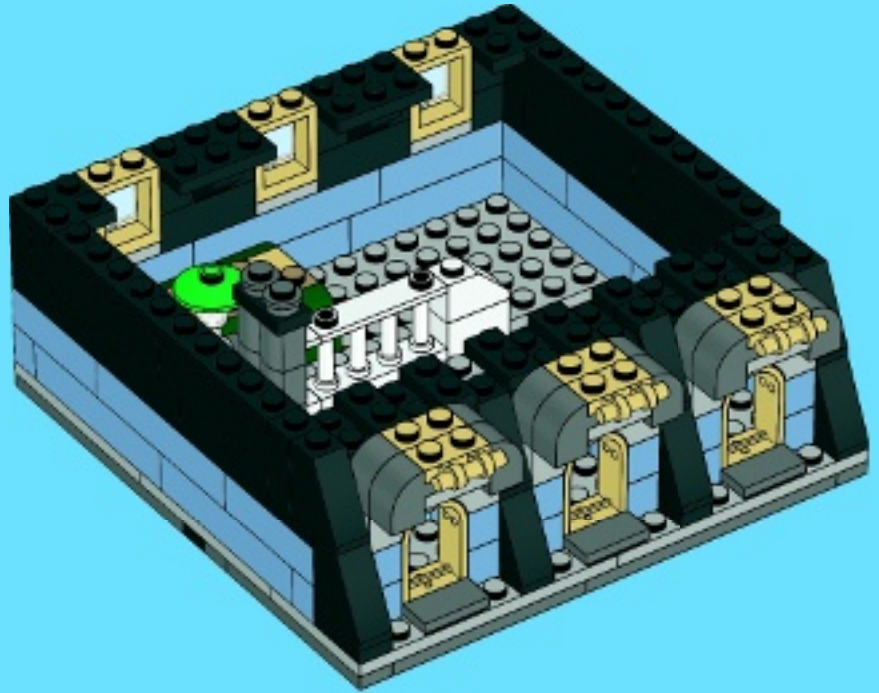

6x



6x



4x



2x



2x

18

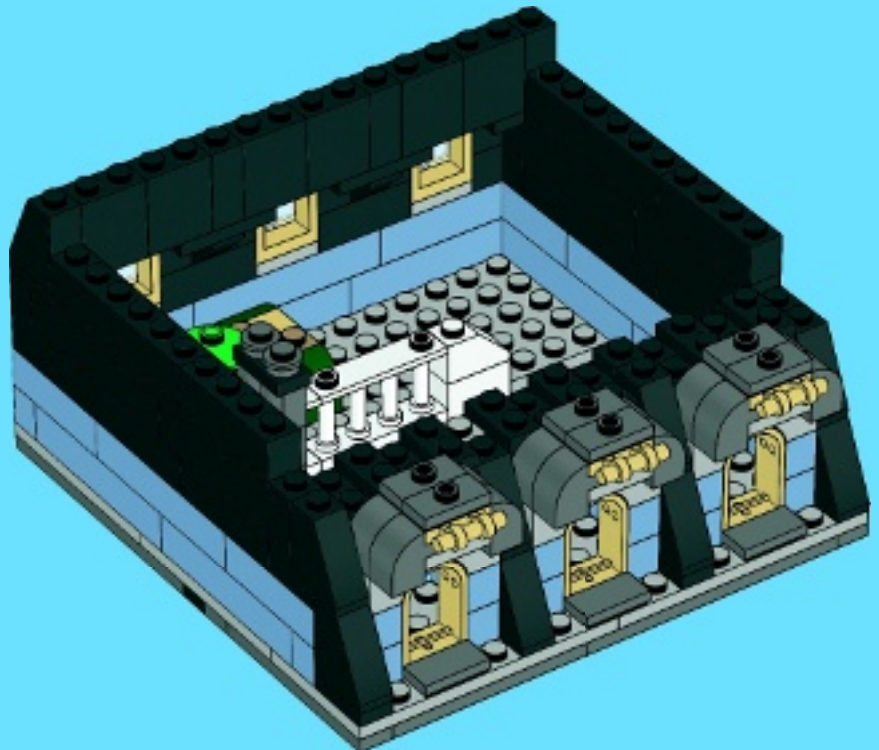



3x



16x

19

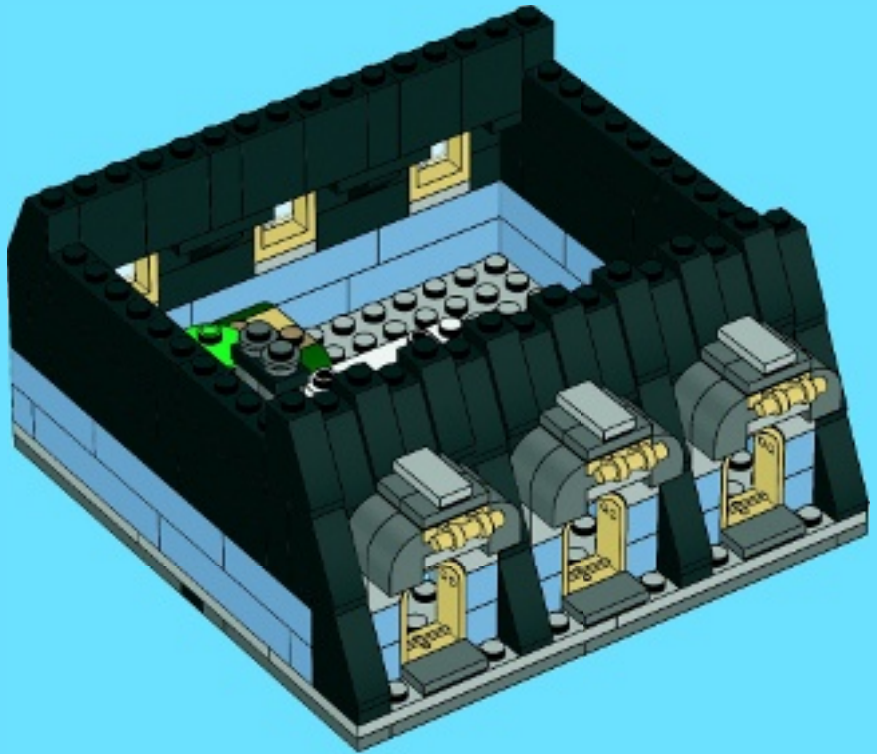

3x



3x



8x



2x



2x

20

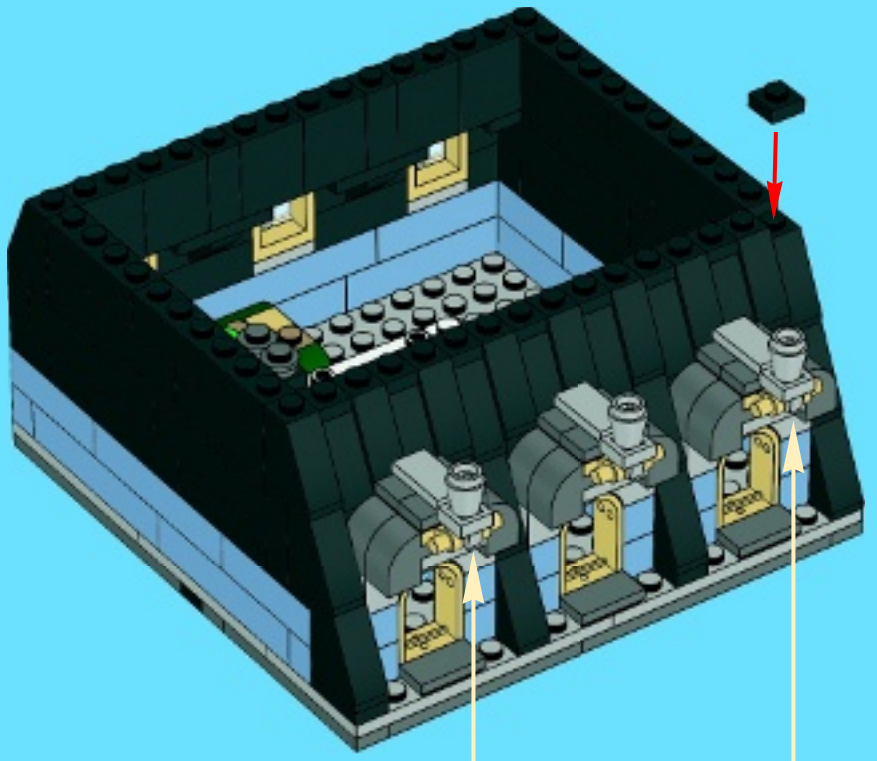

3x

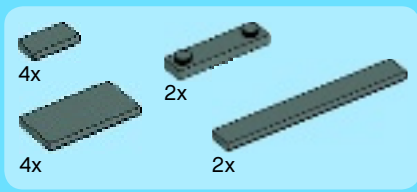

21

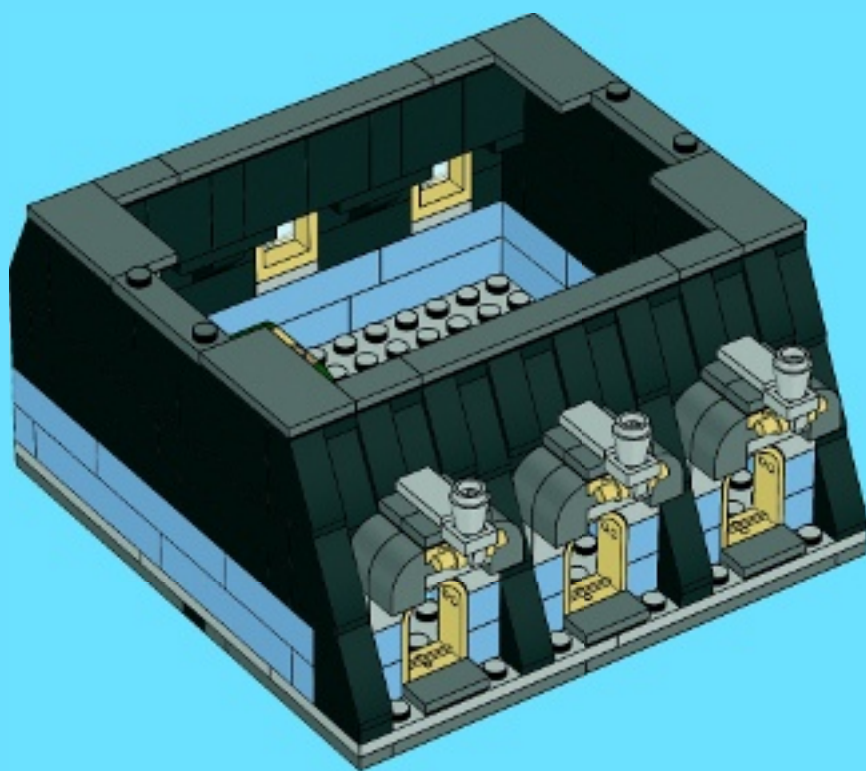

24

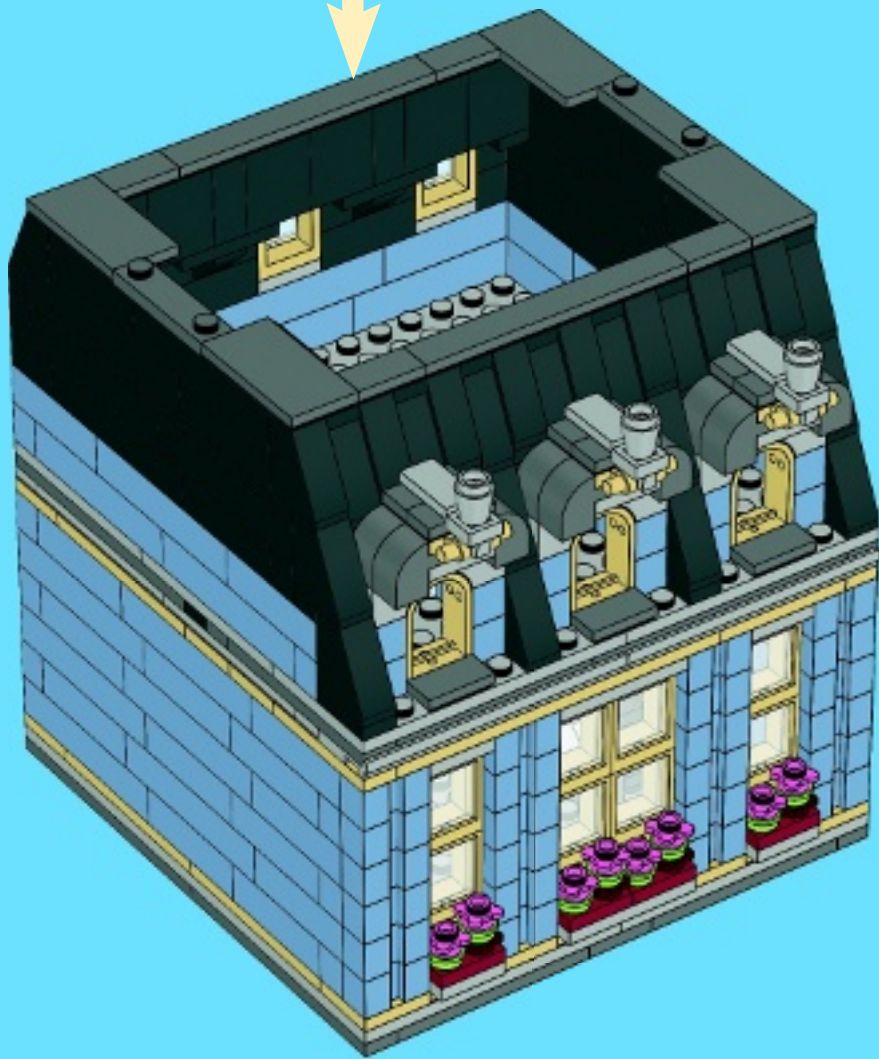

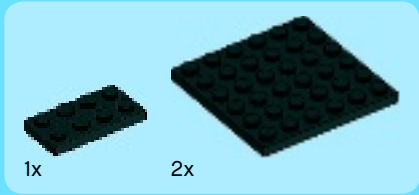
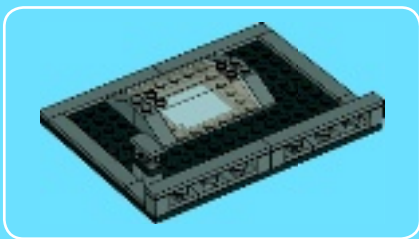

1

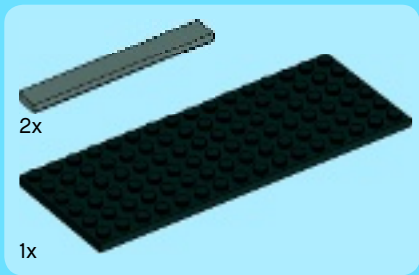
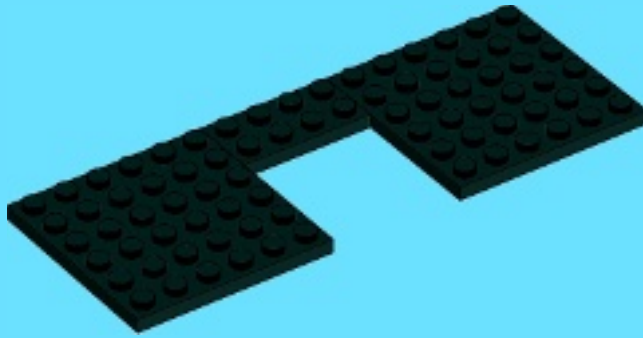

2

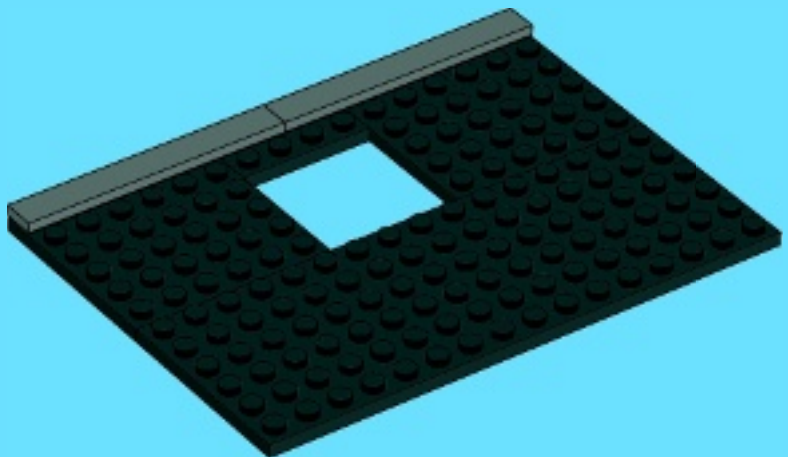

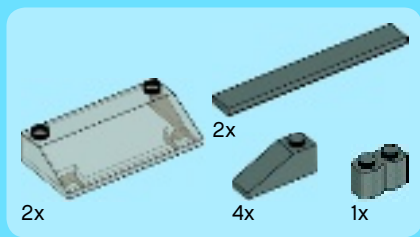

3

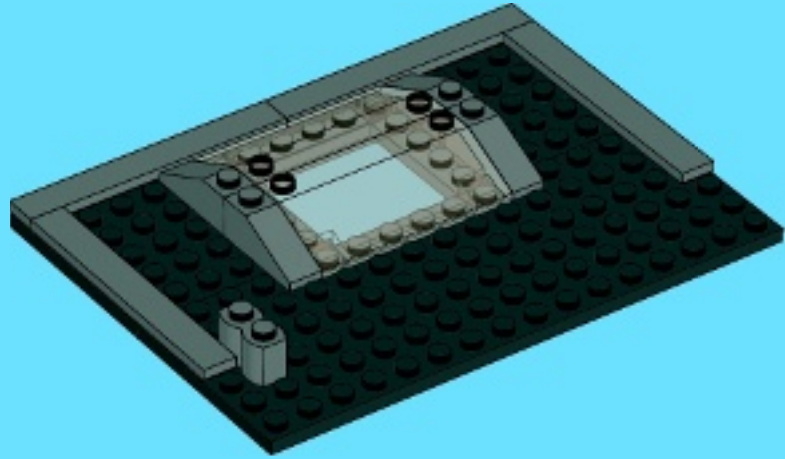

4

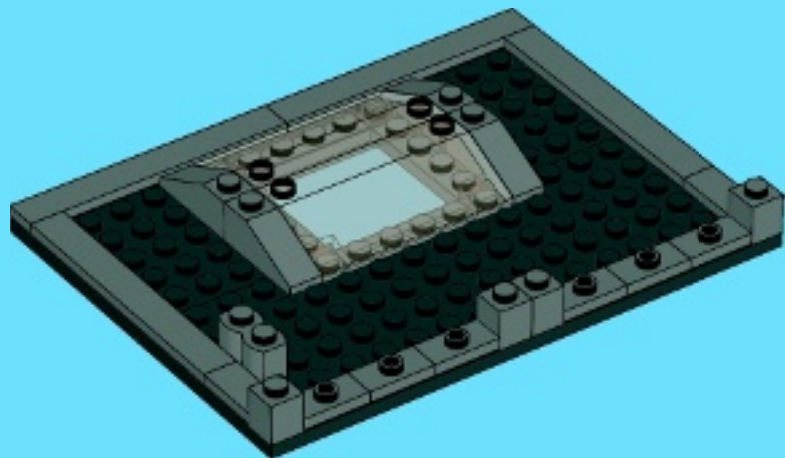

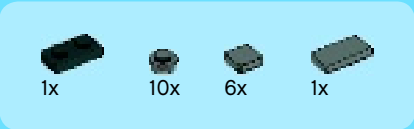

5

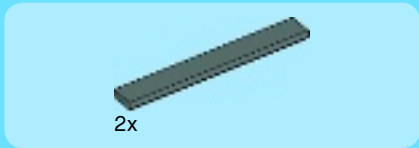
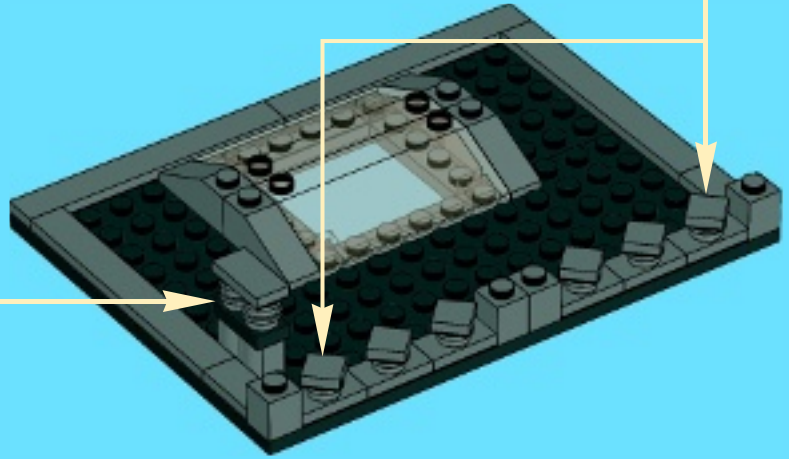
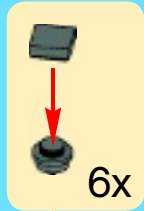
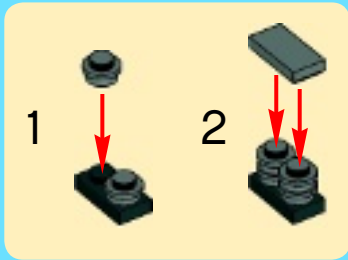

6

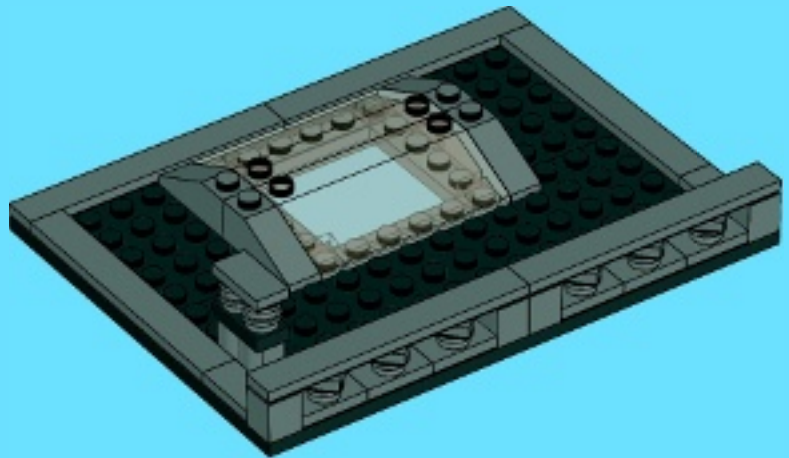

25

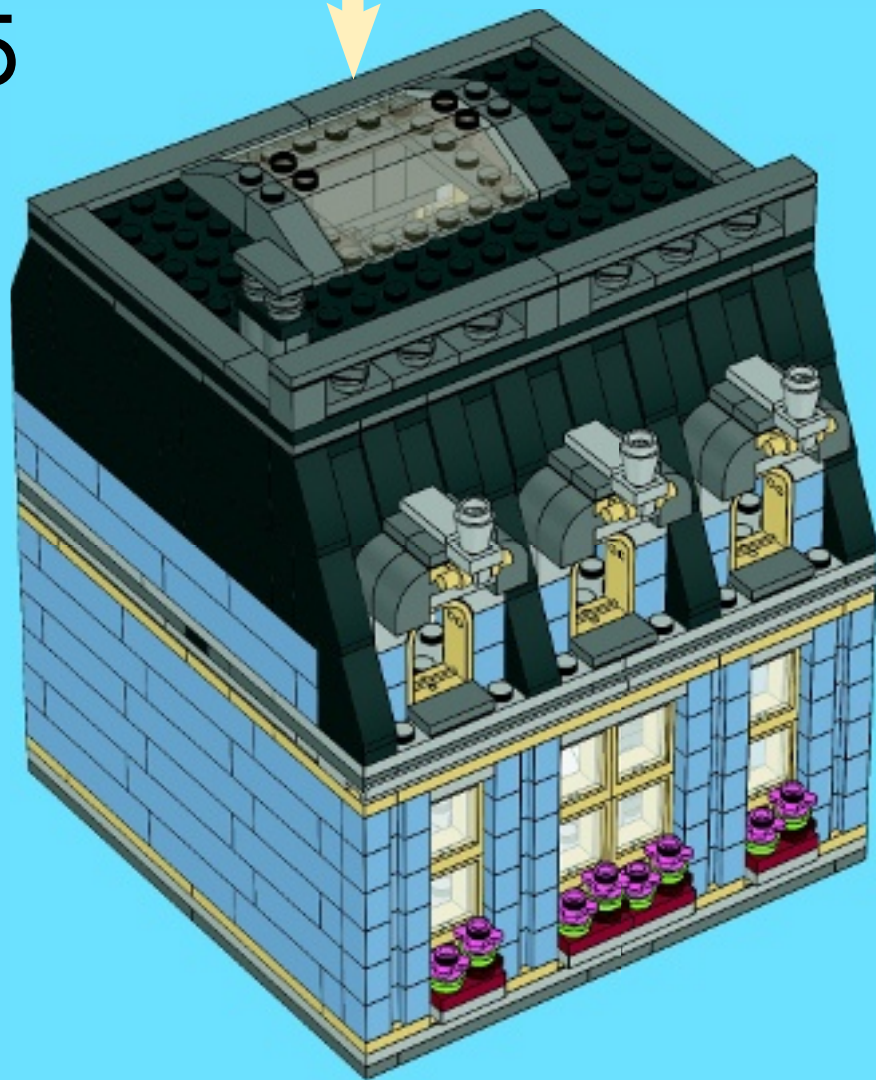



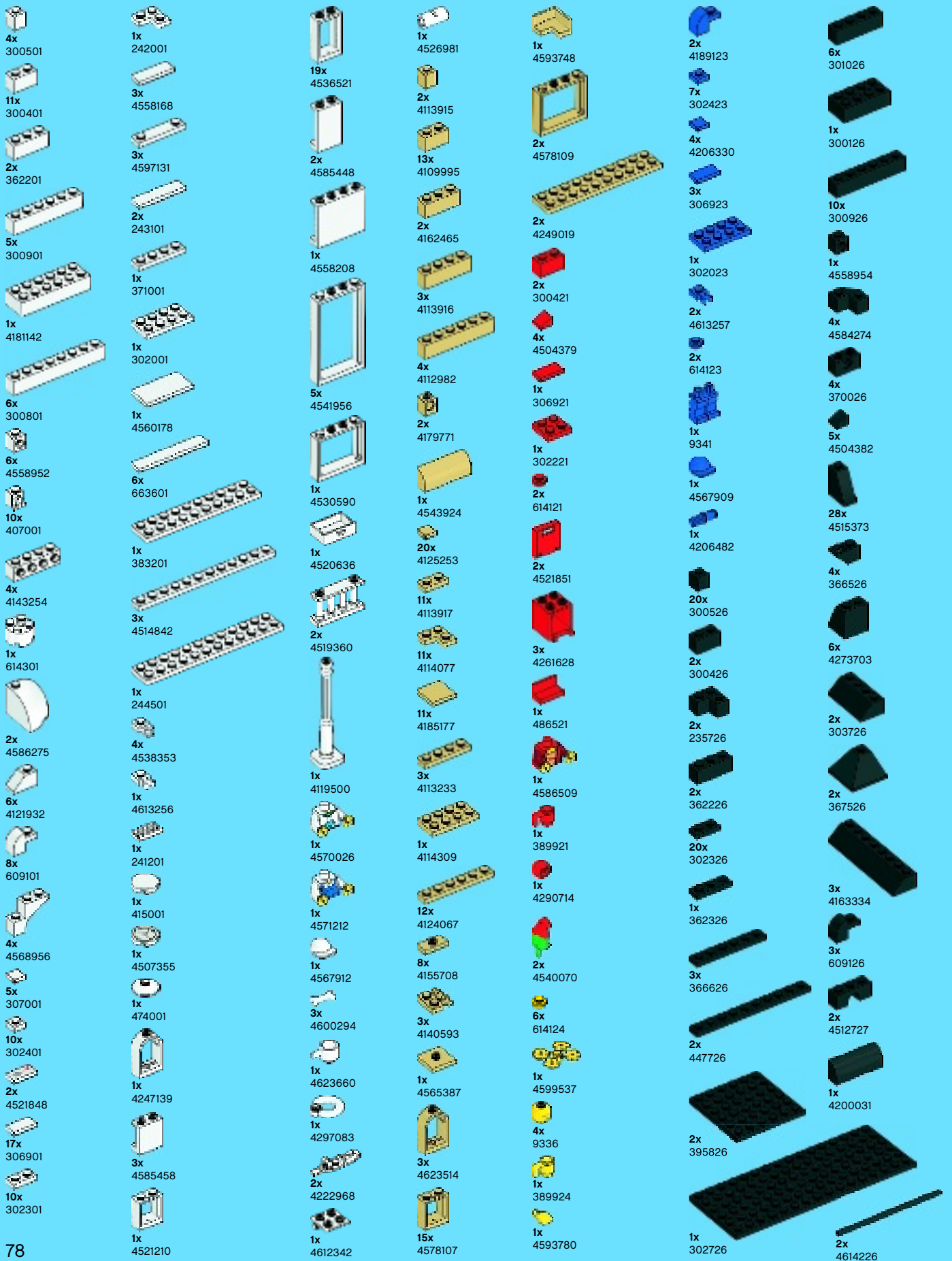

29x 302426
 4x 302226
 1x 4558170
 2x 302126
 7x 243126
 5x 302026
 3x 255526
 1x 4632571
 2x 4565323
 4x 4515368
 2x 317626
 1x 4282746
 3x 4114689
 38x 614126
 2x 403226
 4x 4521208
 1x 4536520
 2x 459926
 6x 243226

3x 4185652
 3x 4187209
 1x 4279270
 1x 73587
 2x 4538456
 7x 4249857
 5x 4598897
 1x 4587844
 2x 4289538
 1x 393726
 6x 4121715
 1x 4140801
 2x 4529239
 4x 4107637
 1x 4295260
 6x 4569058
 2x 4219615

1x 4567908
 2x 4583718
 1x 374128
 1x 4586882
 1x 4592277
 9x 4619599
 2x 4119479
 1x 4624374
 8x 4614158
 3x 4616027
 1x 4529755
 2x 4119350
 1x 3006844
 1x 4567332
 1x 3005744
 1x 4540865
 1x 306548

1x 4106556
 16x 4552035
 19x 4536998
 4x 4113028
 1x 4508261
 1x 4521504
 3x 4552033
 1x 4219773
 2x 3001140
 1x 3000240
 1x 626440
 2x 4622574
 1x 4620810





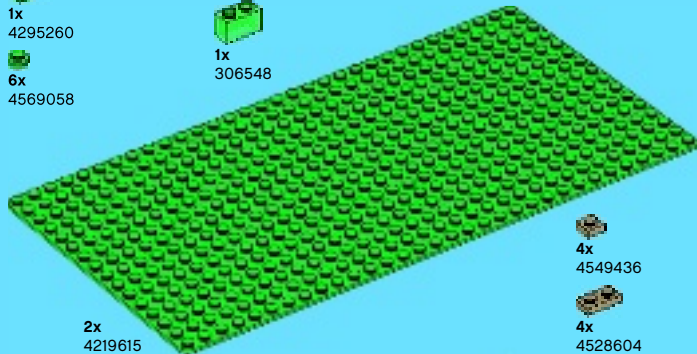

6x 4179826
 14x 4528357
 1x 4179828
 2x 4581079
 1x 4593773
 1x 4623481
 1x 4244368
 1x 4200798
 2x 4498370
 15x 4183133
 43x 4620077
 62x 4620993
 54x 4620992
 48x 4620991
 3x 4255416
 3x 4247145
 4x 4549436
 4x 4528604

2x 4507045
 3x 4570111
 1x 4595712
 1x 4595709
 7x 4249891
 1x 4296785
 2x 4264578
 6x 4264569
 2x 4579753
 2x 4623597
 1x 4609925
 7x 4623695
 2x 4585518
 2x 4539082
 6x 4539097
 2x 4539105
 5x 4539061

1x 4539062
 5x 4539063
 1x 4541496
 2x 4262655
 7x 4624184
 1x 4243668
 37x 4211242
 32x 4211149
 2x 4211200
 8x 4211220
 9x 4211225
 3x 4211201
 32x 4211193
 42x 4263776
 16x 4225469
 4x 4225823
 4x 4529242
 2x 4620075
 5x 4211252
 4x 4211199



Customer Service
Kundenservice
Service Consommateurs
Servicio Al Consumidor
www.lego.com/service or dial
 00800 5346 5555 :     
 1-800-422-5346 :  



CREATOR

5770

5771



creator.LEGO.com



The LEGO logo is displayed in its characteristic white, bold, rounded font with a black outline, set against a red square background.

10220





FREE! GRATIS! GRATUIT!



www.LEGOclub.com



LEGO® Club Magazine



LEGO® Club Email

SIGN UP ONLINE!

www.LEGOclub.com

VISIT THE WORLD'S BIGGEST LEGO® SHOP!

www.LEGOshop.com



GO TO

www.LEGOclub.com

00800 5346 5555*



1-866-534-6258 • 1-877-518-5346

US & Canada only

Canada seulement



* Freephone. Mobile charges may apply. * Numéro sans frais. Des frais peuvent s'appliquer avec les téléphones cellulaires. * Gebührenfrei. Kosten für Anrufe aus Mobilfunknetzen können abweichen. * Gratis telefoonnummer vanaf vaste lijn. * Det er et gratis nummer, når du ringer fra fasttelefon. * Det är gratis, när du ringer från en fast telefon. * Numéro sans frais. Des frais peuvent s'appliquer avec les téléphones portables.



WIN!

Go to www.LEGOsurvey.com/product to fill out a survey for a chance to win a cool LEGO® Product.
No purchase necessary.
Open to all residents where not prohibited.



www.LEGO.com



www.LEGOsurvey.com/product

GEWINNE!

Nimm an der Umfrage auf www.LEGOsurvey.com/product teil und hab die Chance ein cooles LEGO® Produkt zu gewinnen!

Die Teilnahme am Gewinnspiel führt zu keinerlei Kaufverpflichtungen. Teilnahme in allen nicht ausgeschlossenen Ländern möglich.

WIN!

Ga naar www.LEGOsurvey.com/product, vul een enquêteformulier in en maak kans op een cool LEGO® product.

Geen aankoopverplichting.
Iedereen mag deelnemen, uitgezonderd ingezetenden van landen waar een enquêteverbod geldt.

GAGNE!

Visite www.LEGOsurvey.com/product pour répondre à un questionnaire et avoir une chance de gagner un produit LEGO® très cool!

Aucune obligation d'achat.
Ouvert à tous les résidents des pays autorisés.

当てよう!

www.LEGOsurvey.com/product にアクセスして、アンケートにご記入ください。当選者にはレゴ製品を差し上げます。

お買い上げの必要はありません。
禁止されていない限り、すべての皆様にご利用いただけます。

Trademarks, design patents and copyrights are used with the approval of the owner Volkswagen AG./

Les marques déposées, les brevets de conception et les copyrights sont utilisés avec l'autorisation du propriétaire Volkswagen AG./
El uso de las marcas comerciales, patentes de diseño y derechos de autor se realiza con el consentimiento de su propietario, Volkswagen AG.
LEGO and the LEGO logo are trademarks of the LEGO Group. ©2011 The LEGO Group. ©2011 LucasFilm Ltd. & TM. All rights reserved.