



THE LORD OF THE RINGS

10237





5

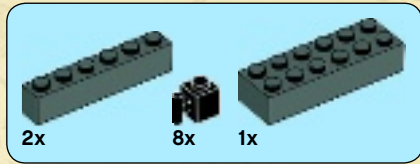

2x

8x

1x

32





32x



2x

33

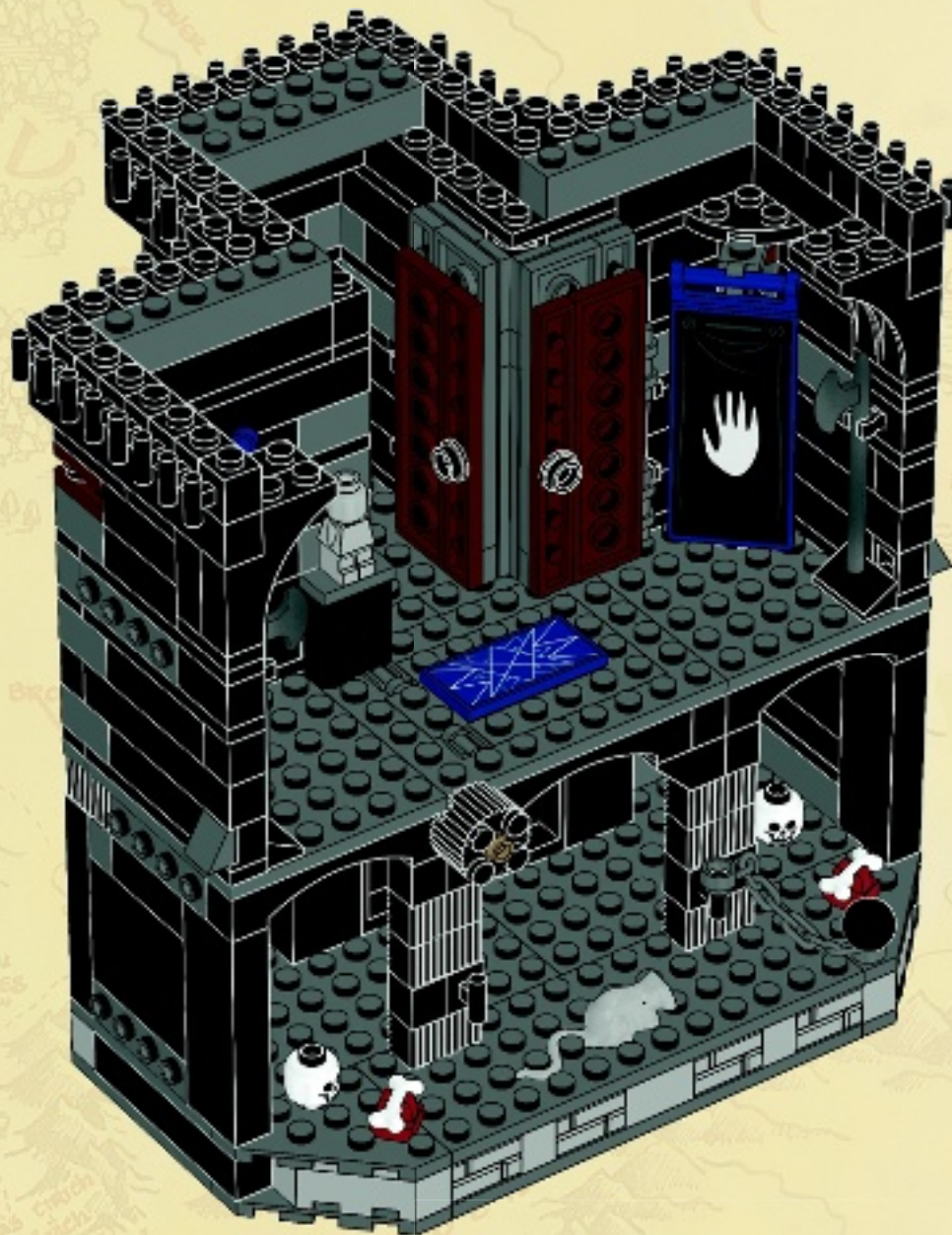

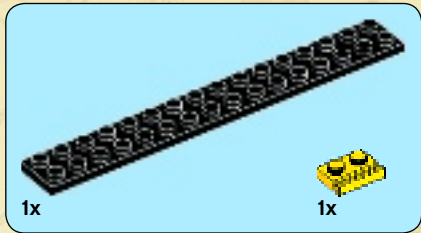

1

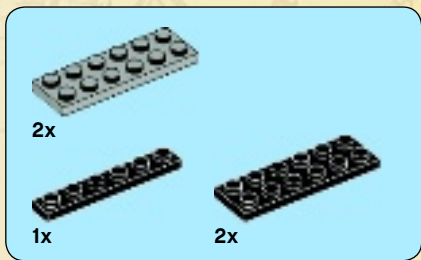
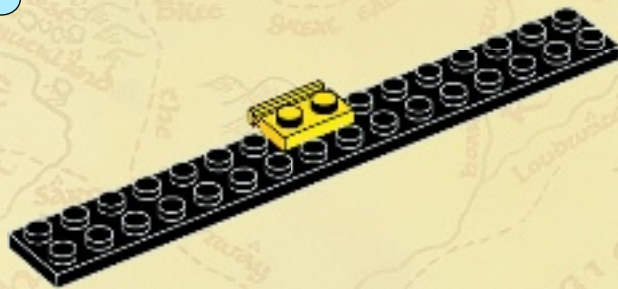

2

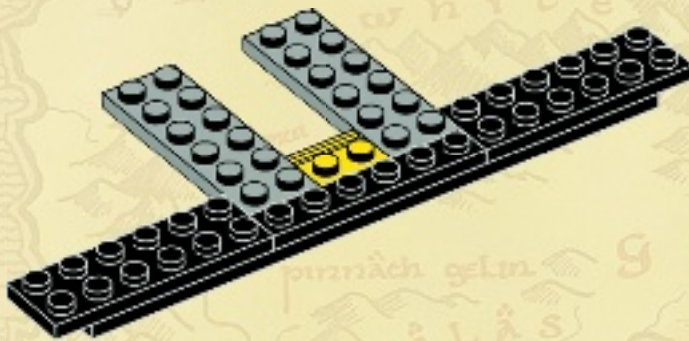

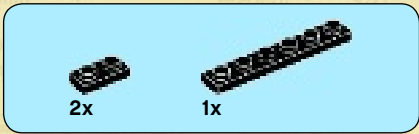

3

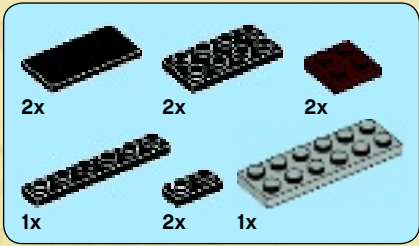
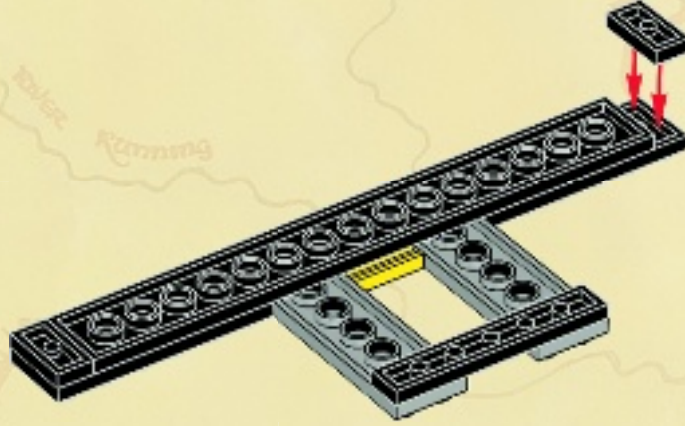

4

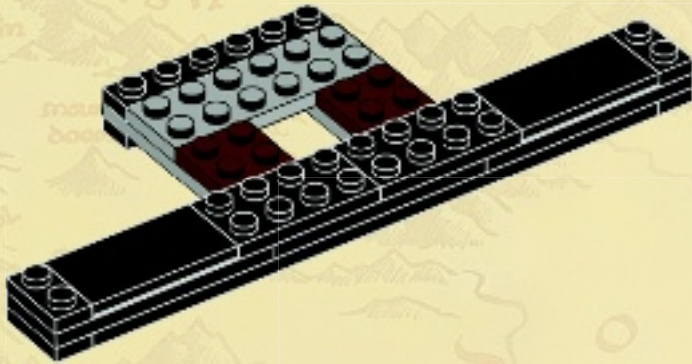



5

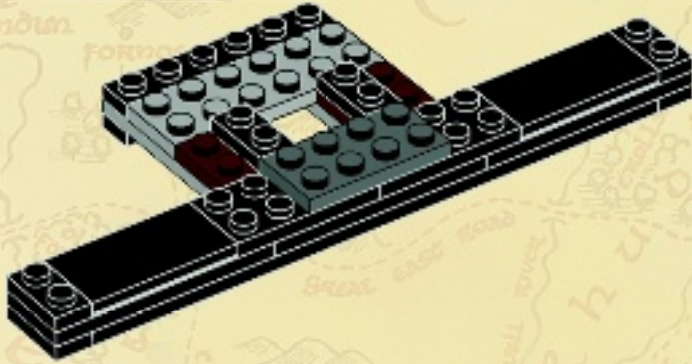

34

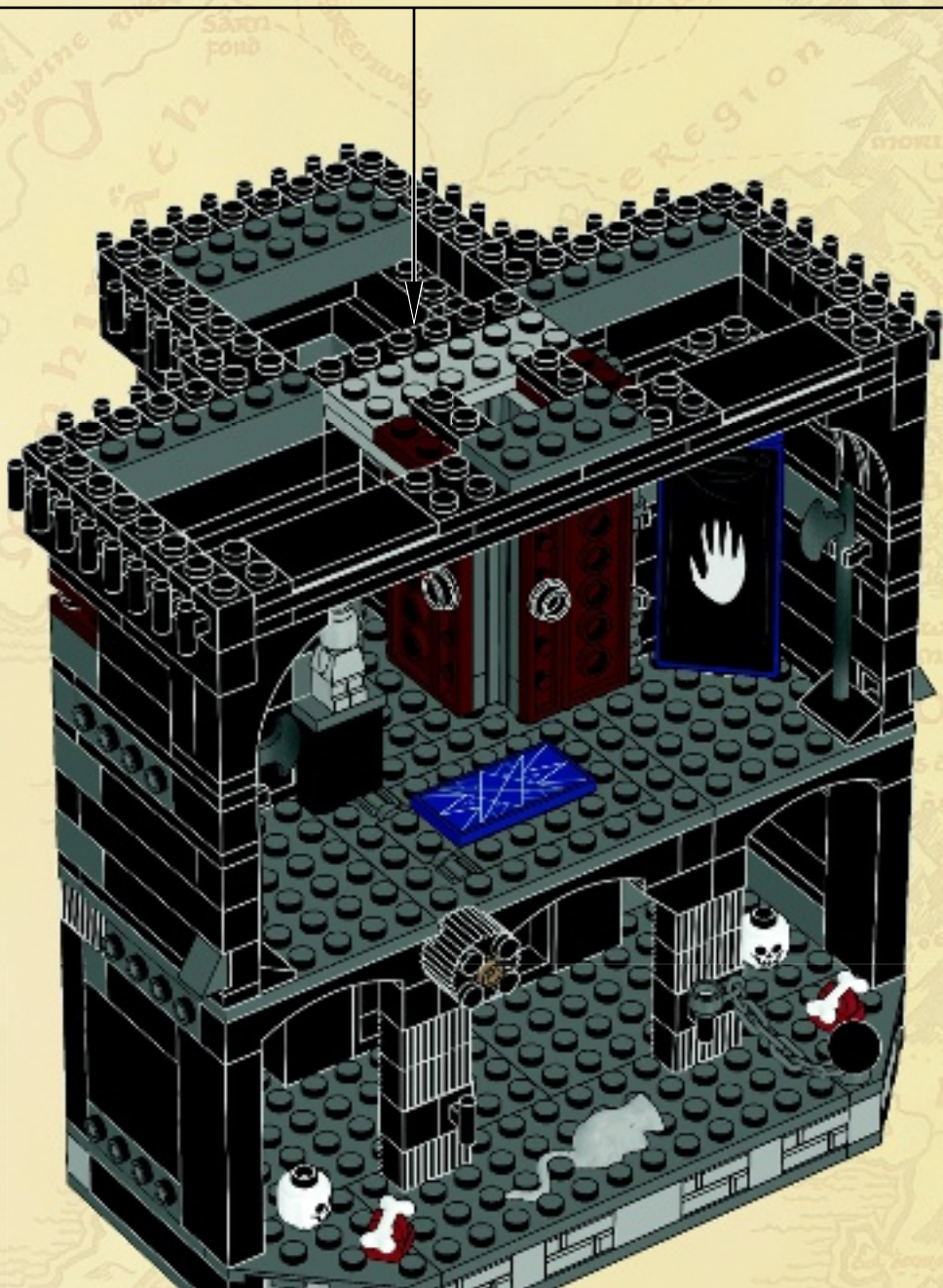

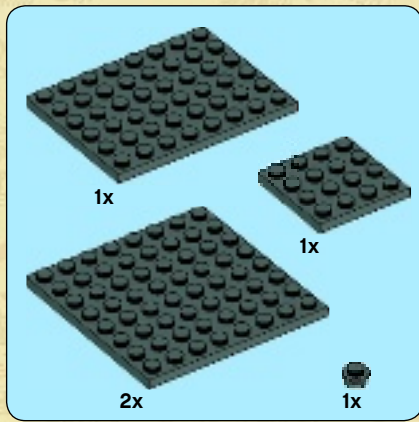

35

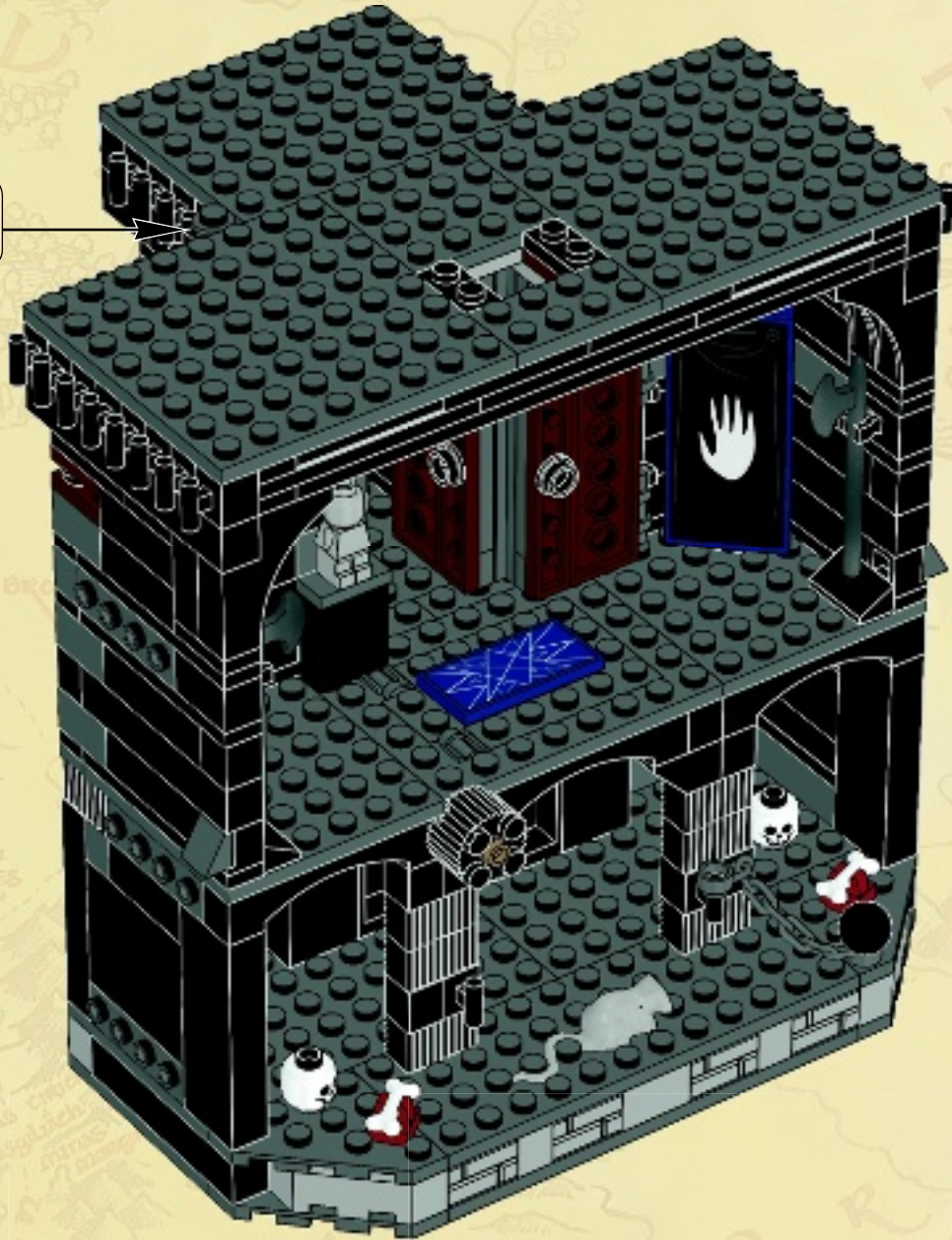

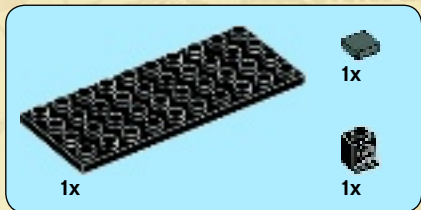
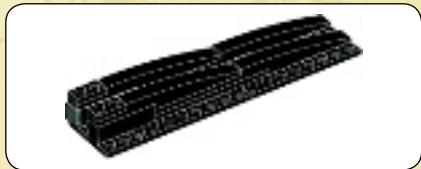

1

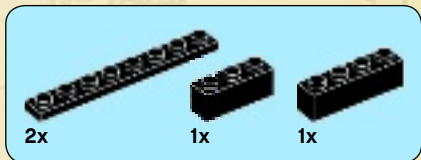
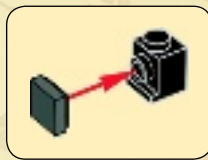

2

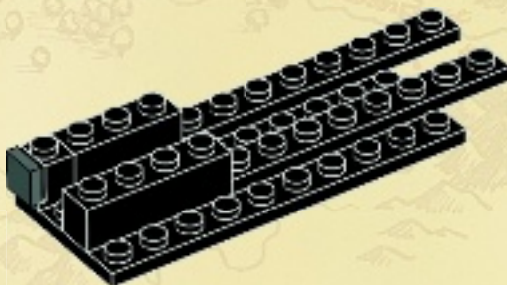

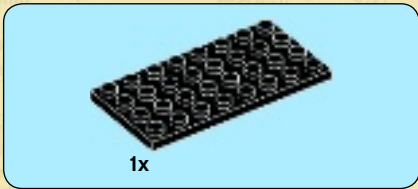

3

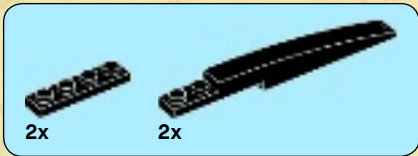
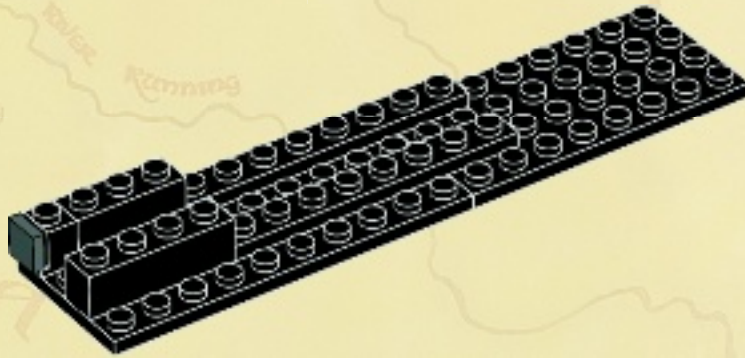

4

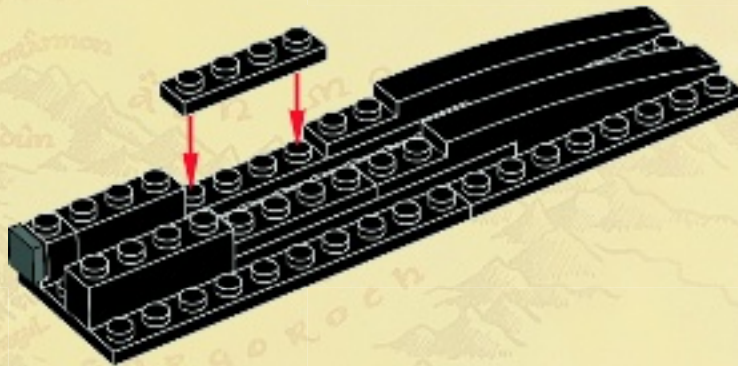

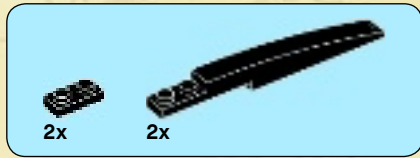

5

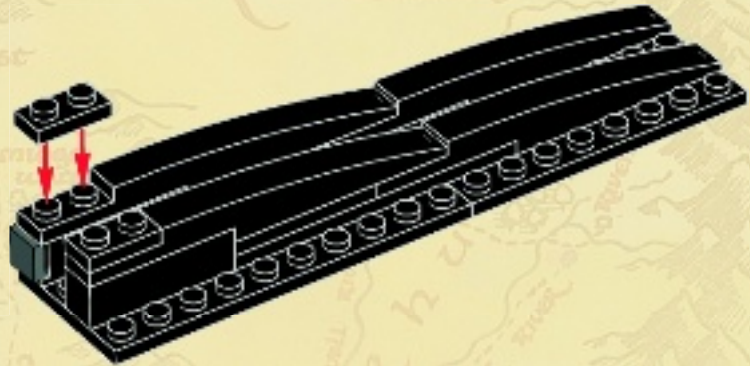

36

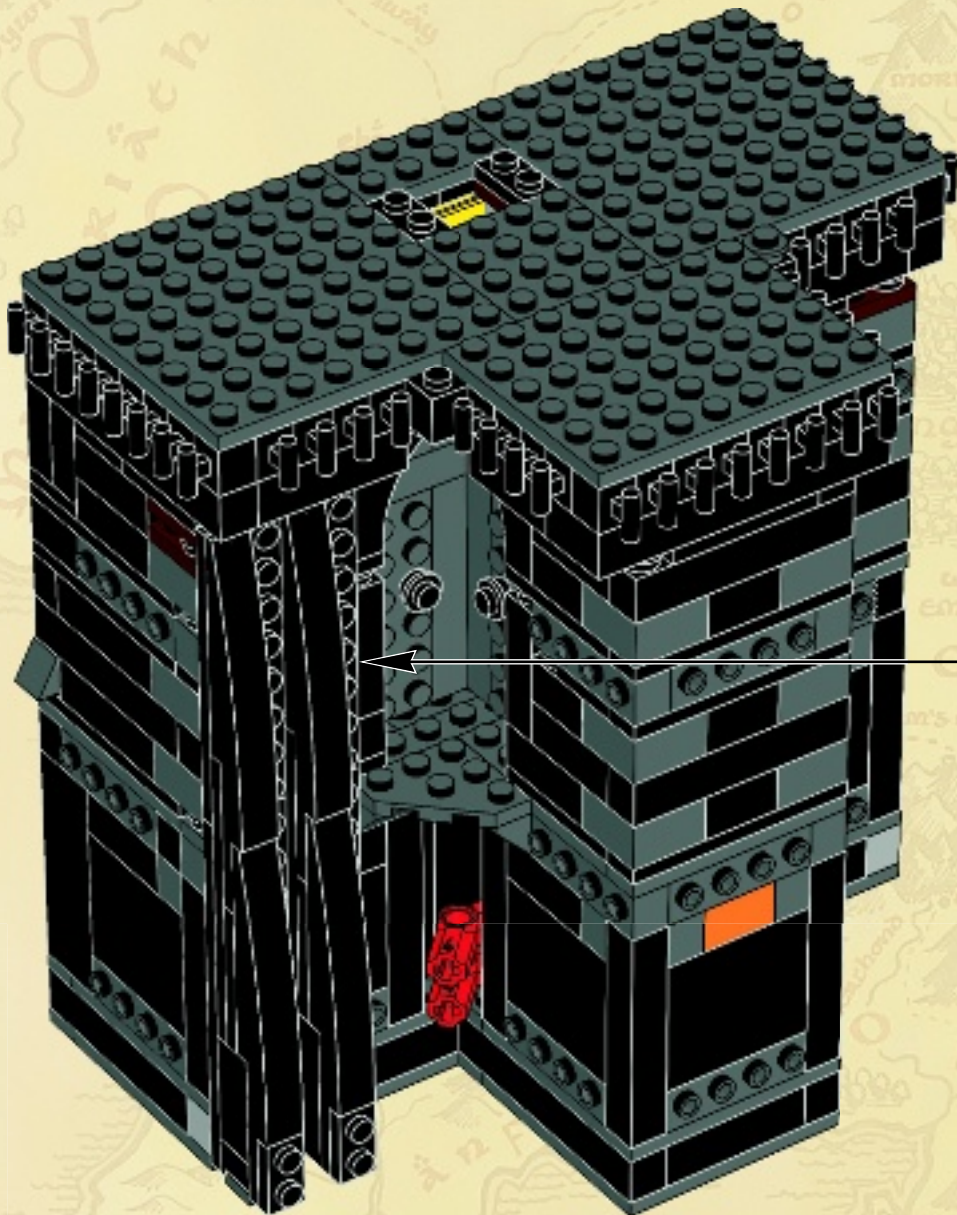

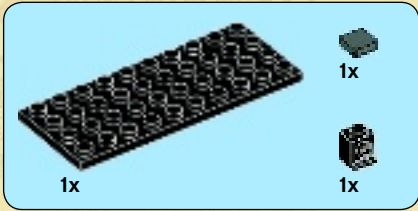
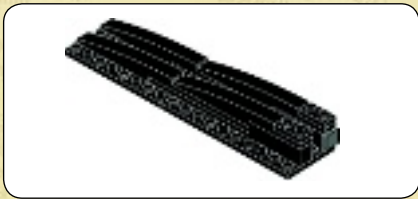

1

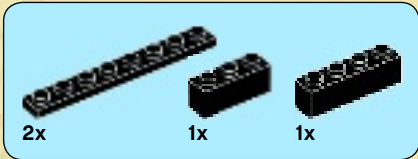
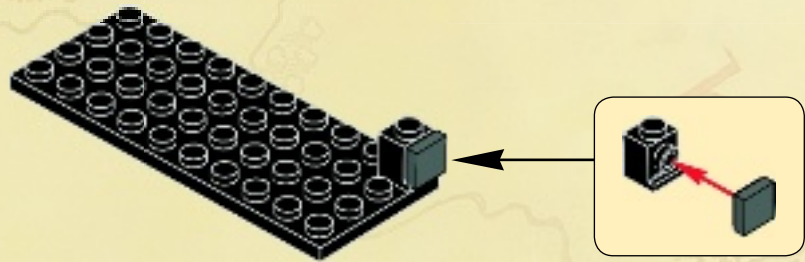

2



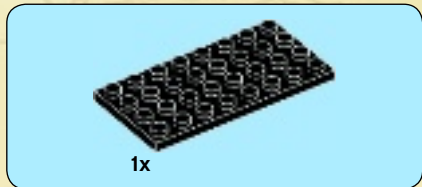

3

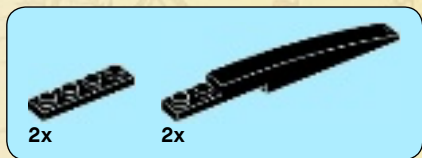
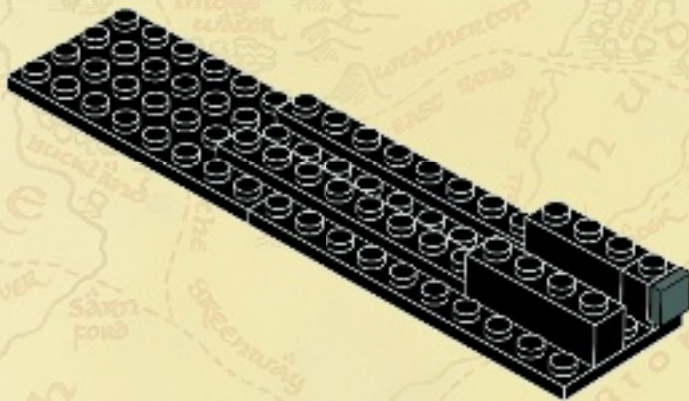

4

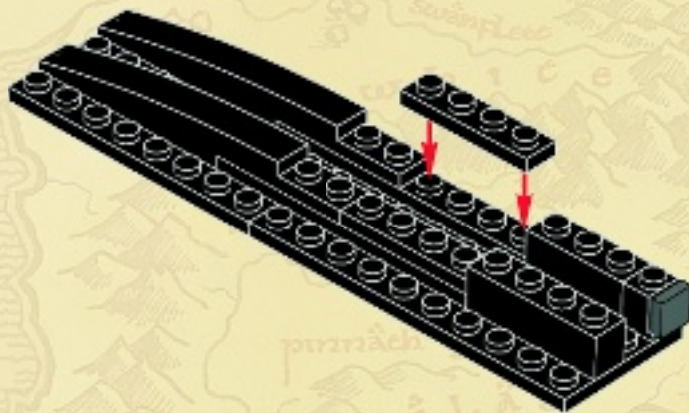

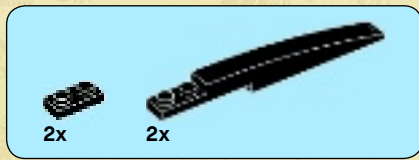

5

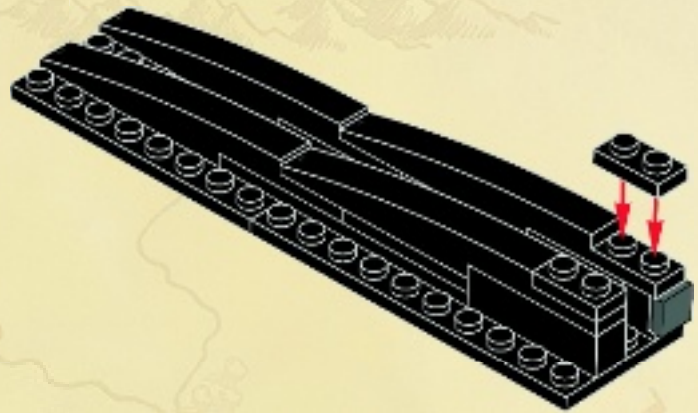

37

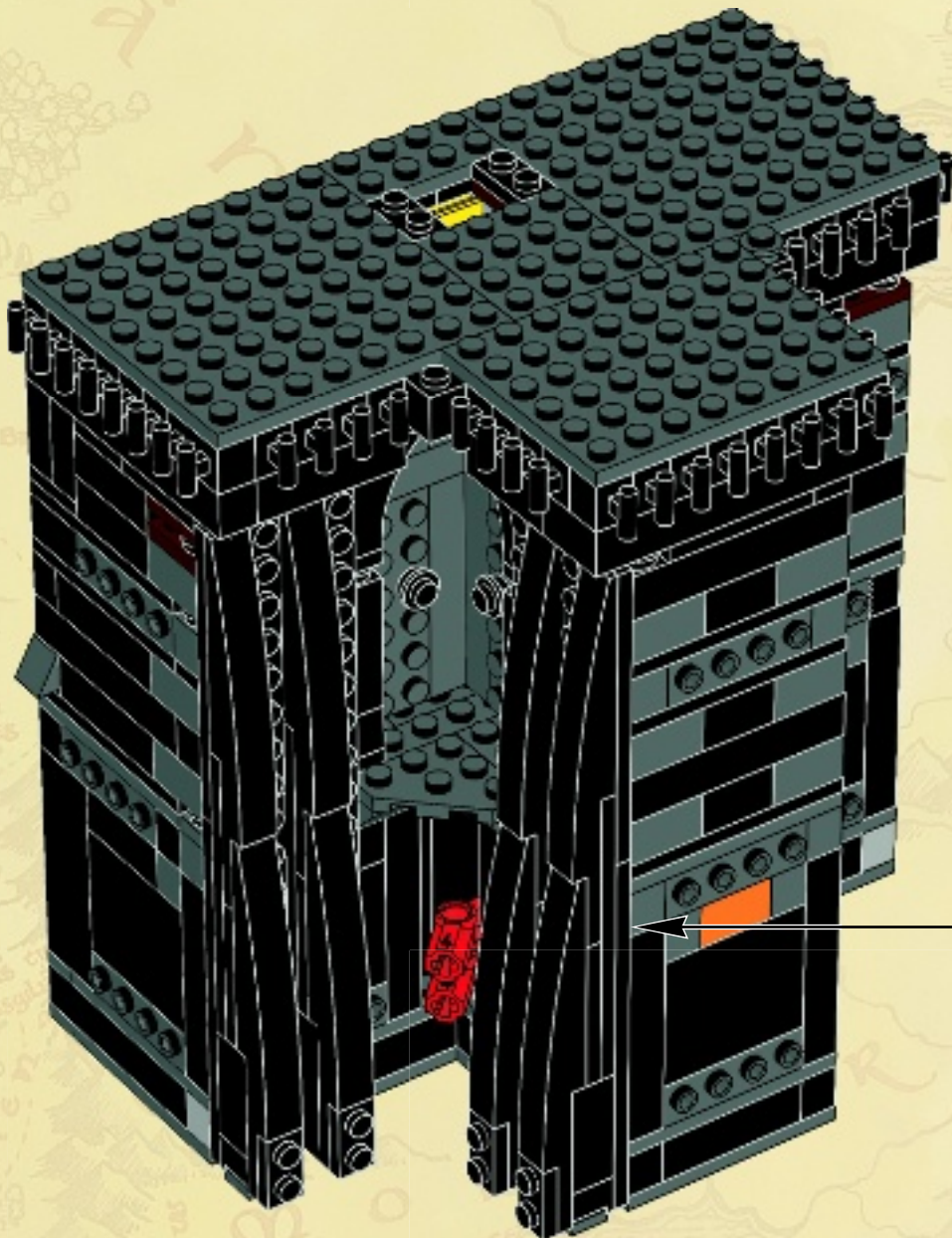



1



2



3

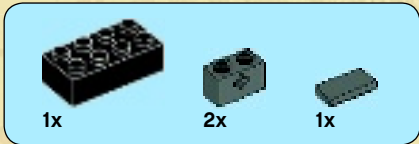

4

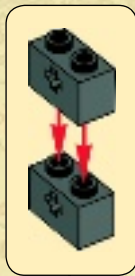

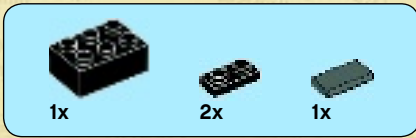

5

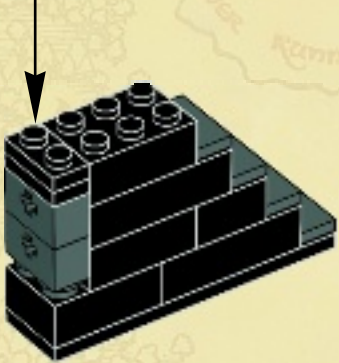
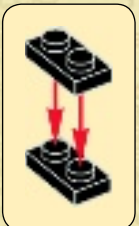

7

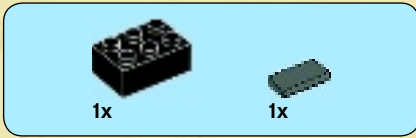

6

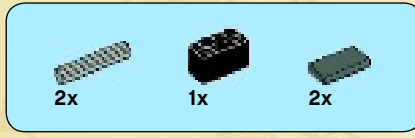
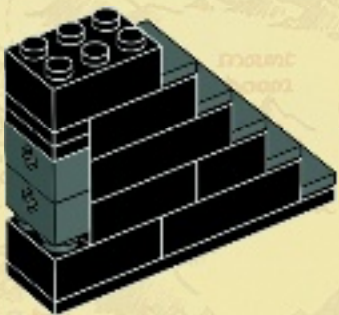

8



38

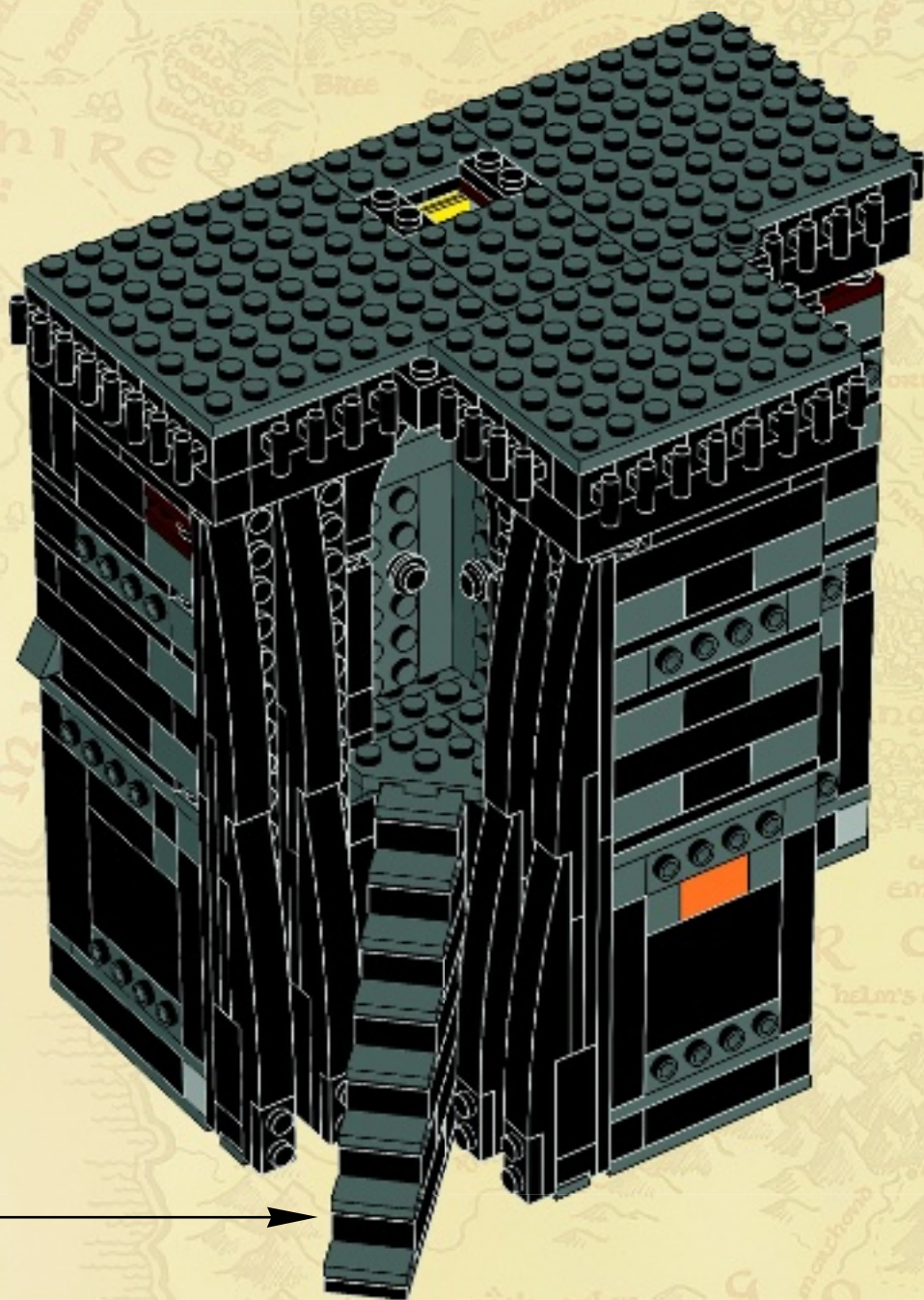

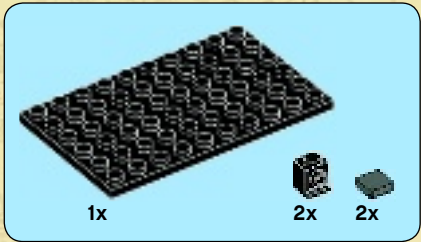
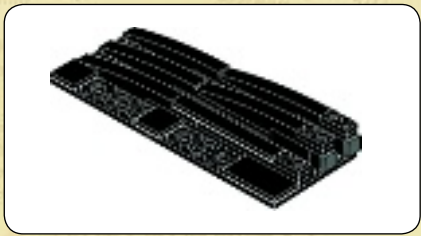

1

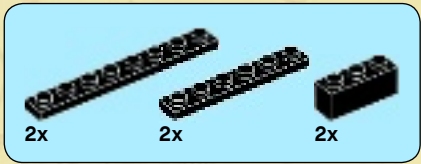
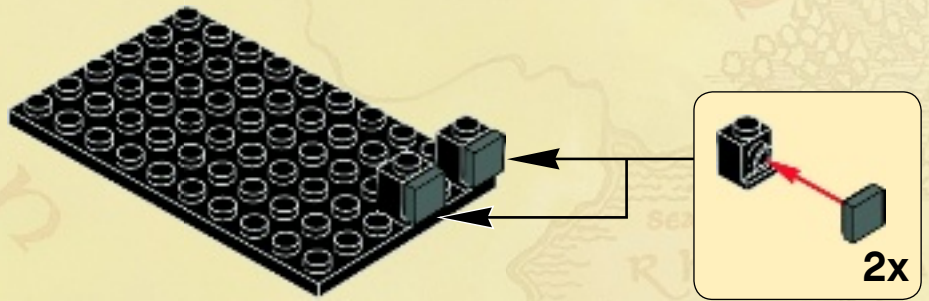

2

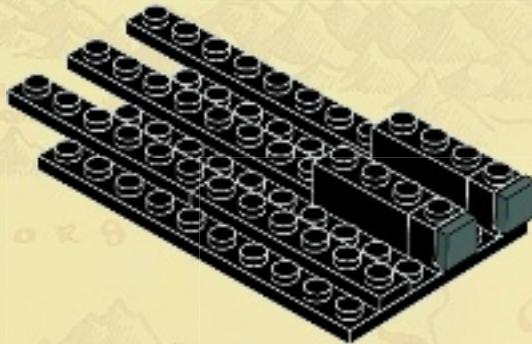

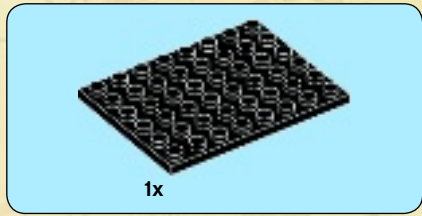

3

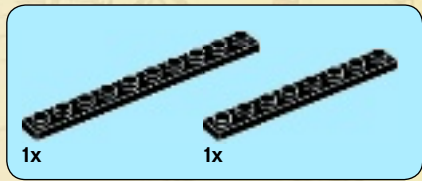
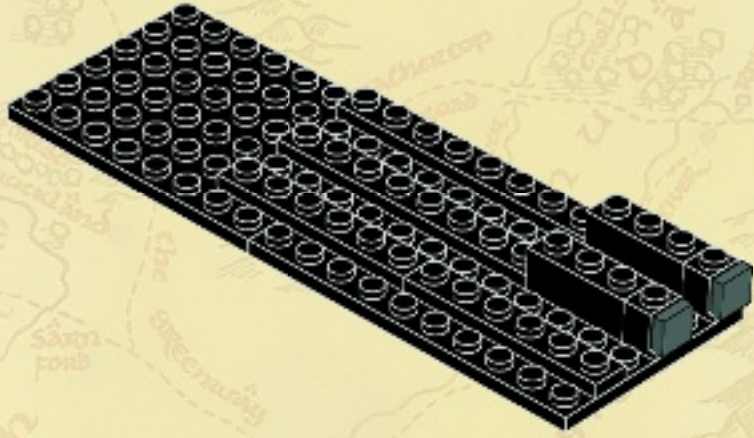

4

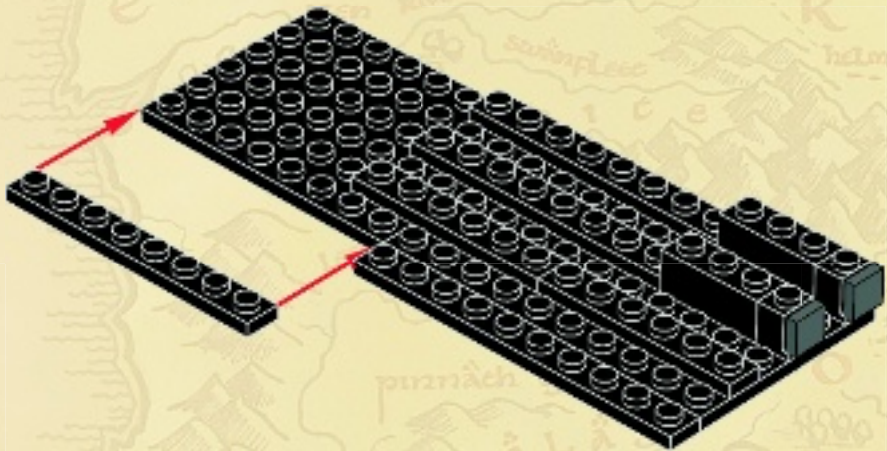

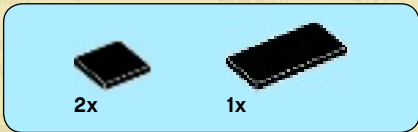

5

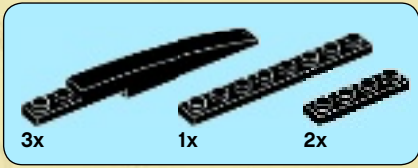
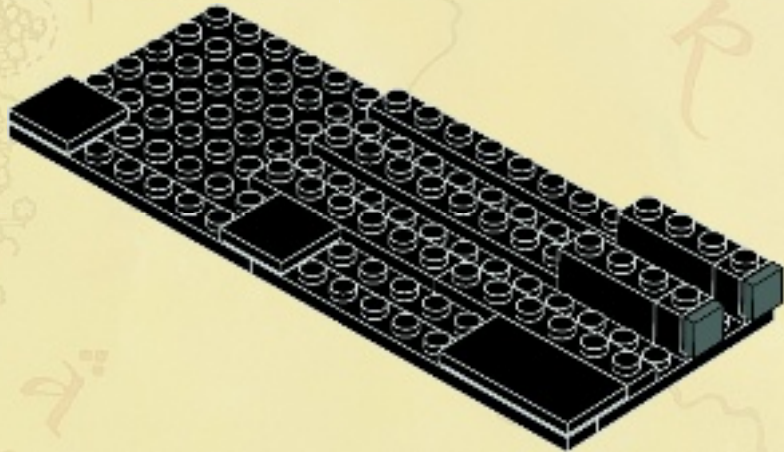

6

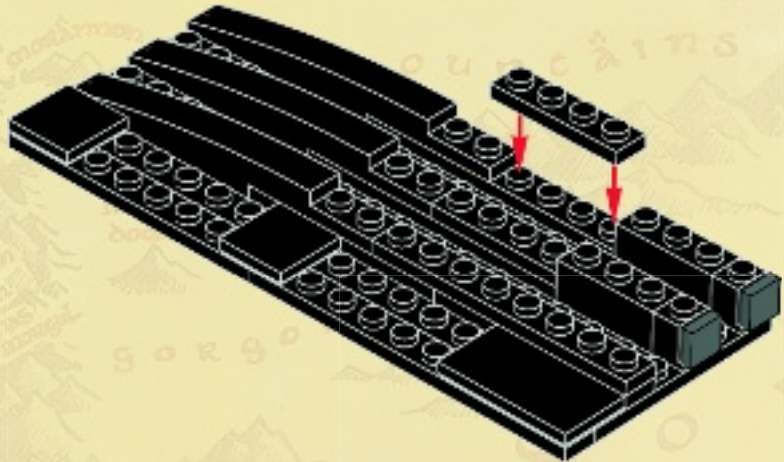

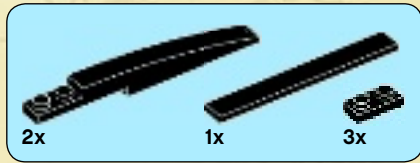

7

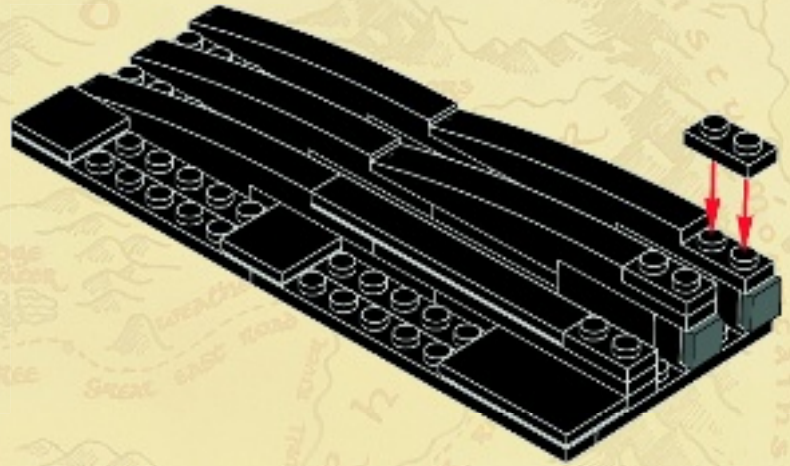

39

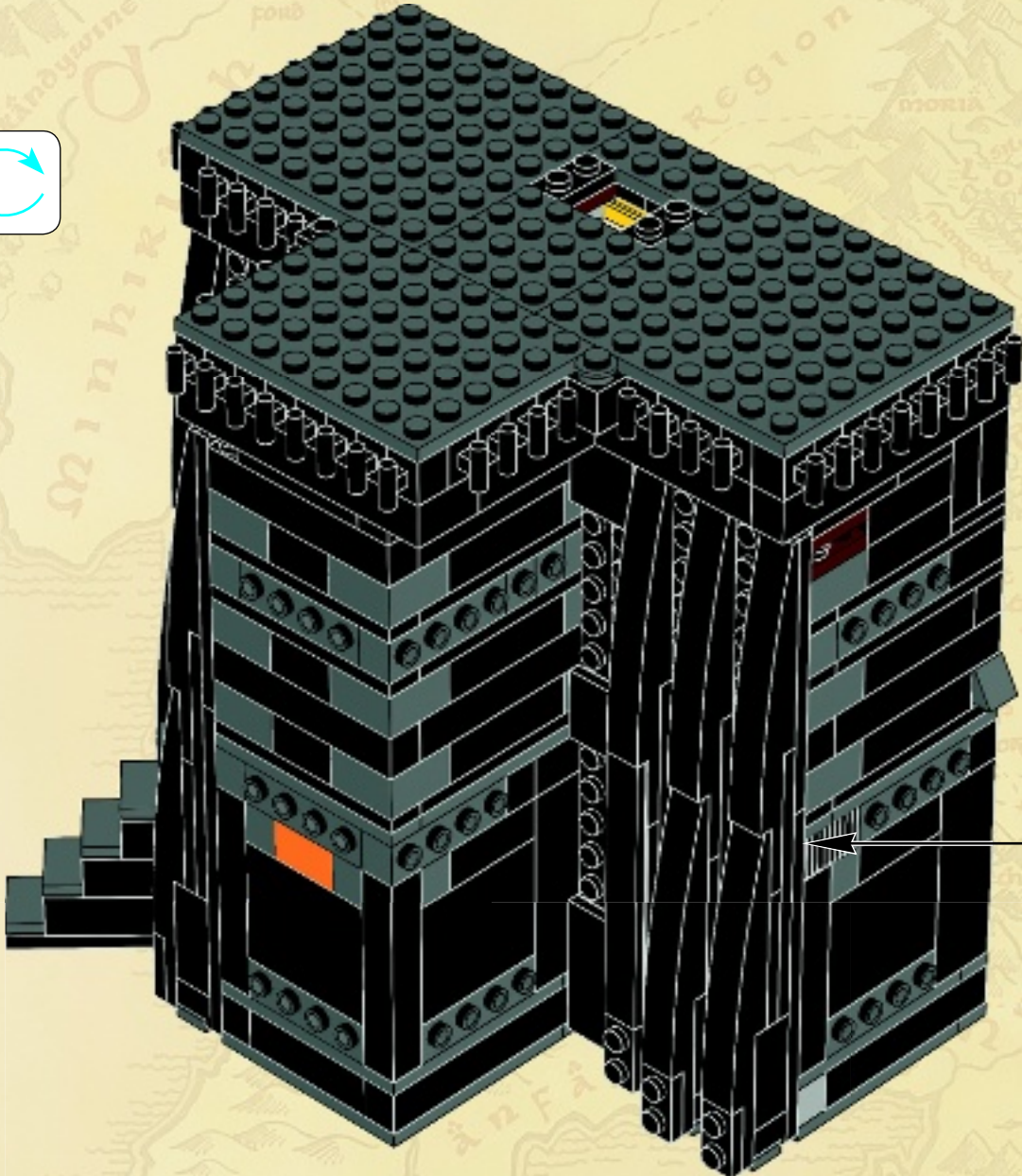

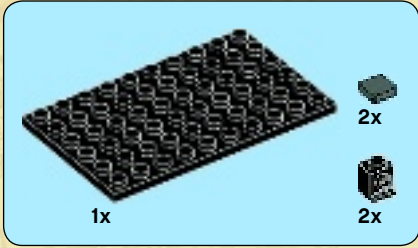

1

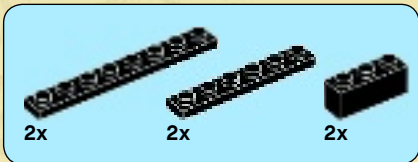
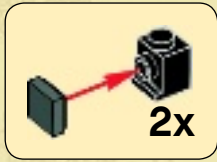

2



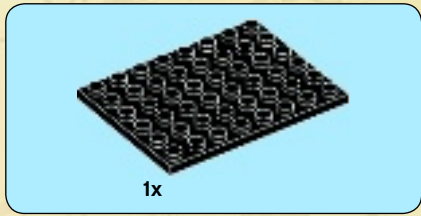

3

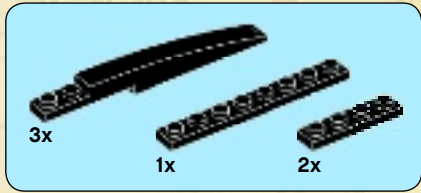
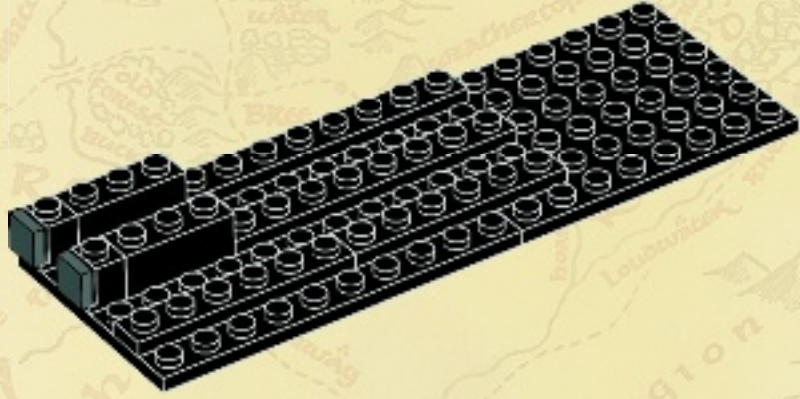

4

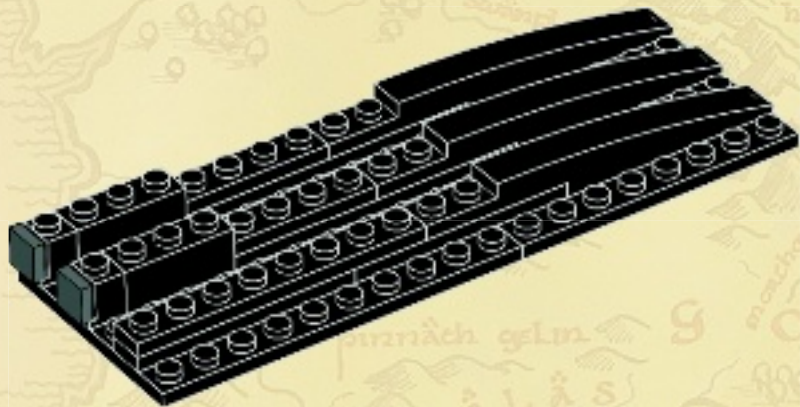

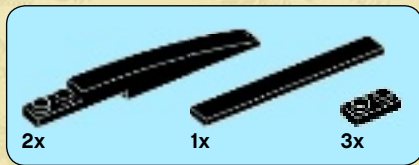

5

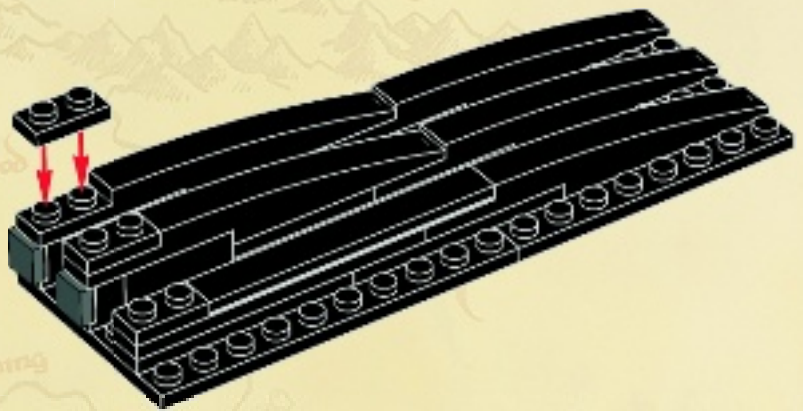

40

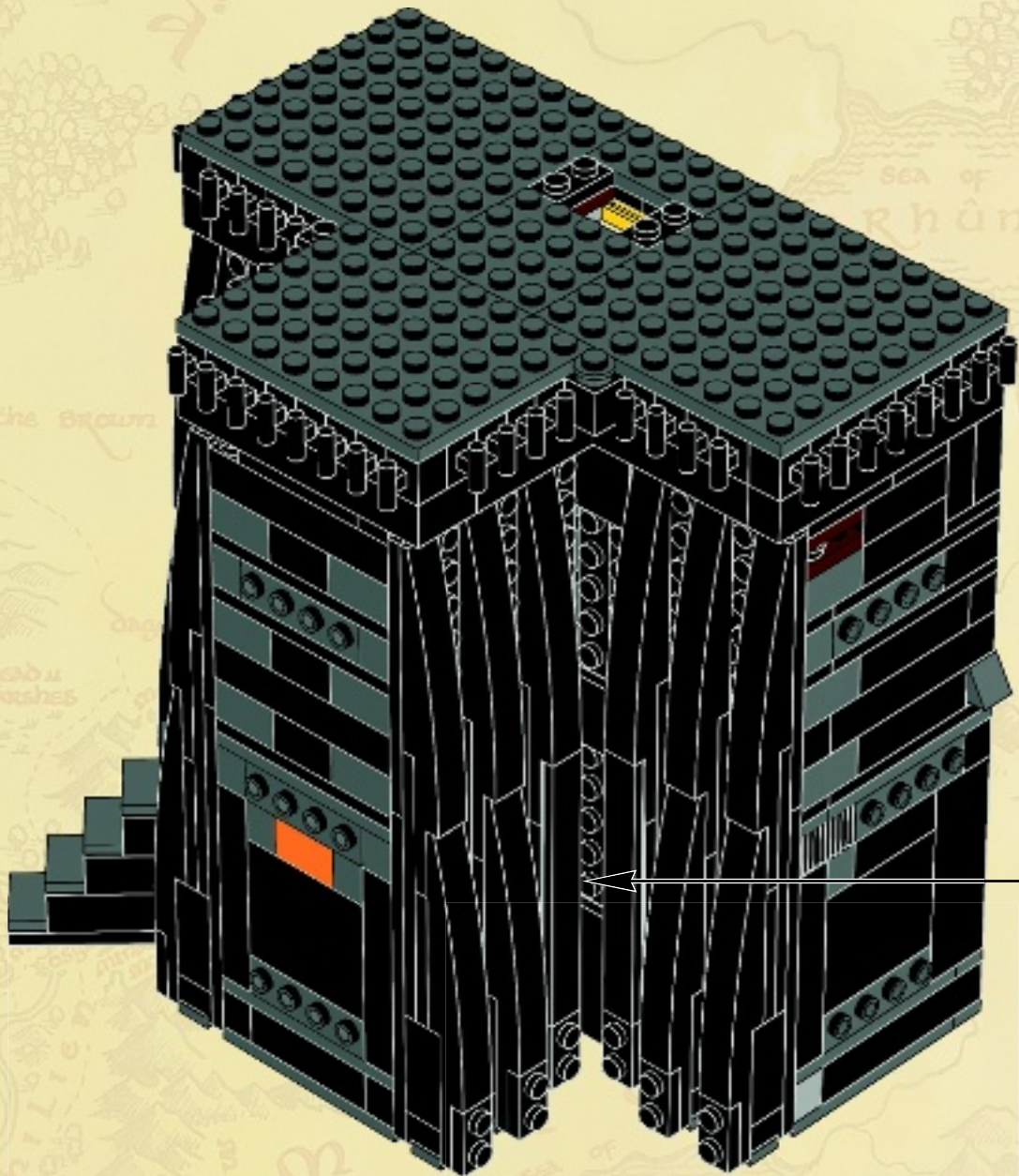

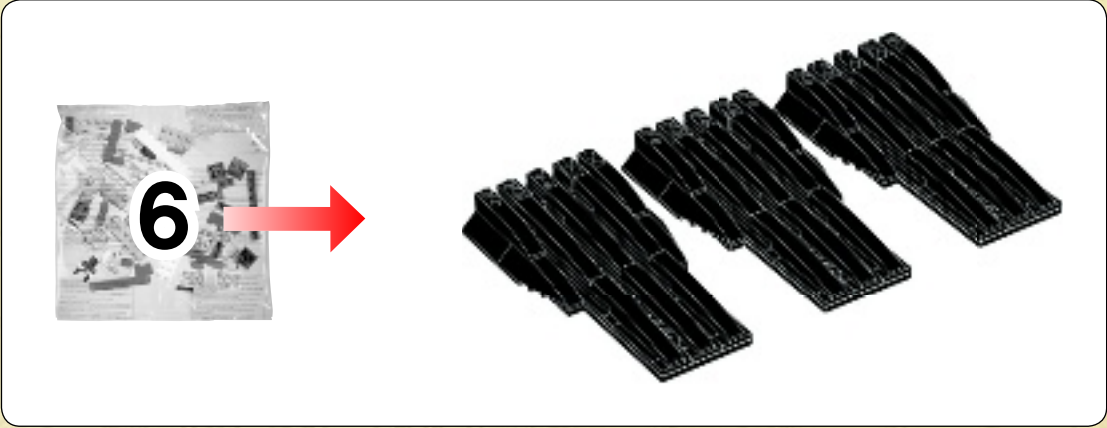

1

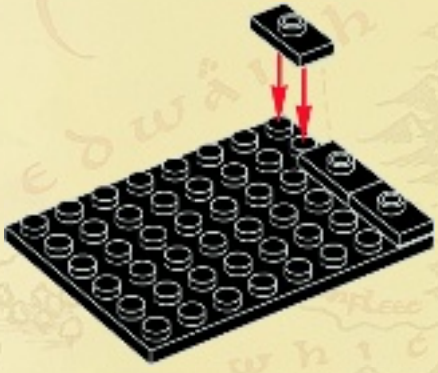

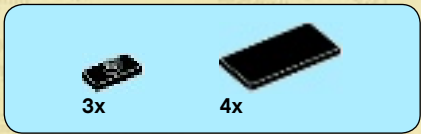

2

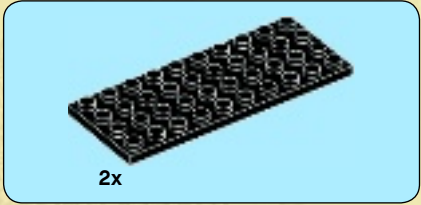
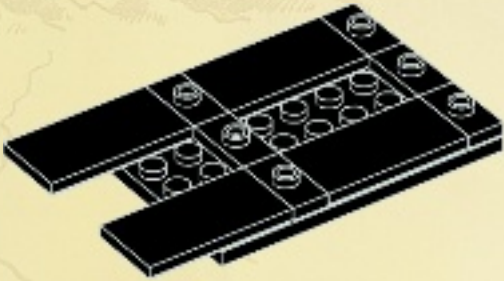

3

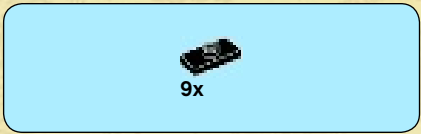
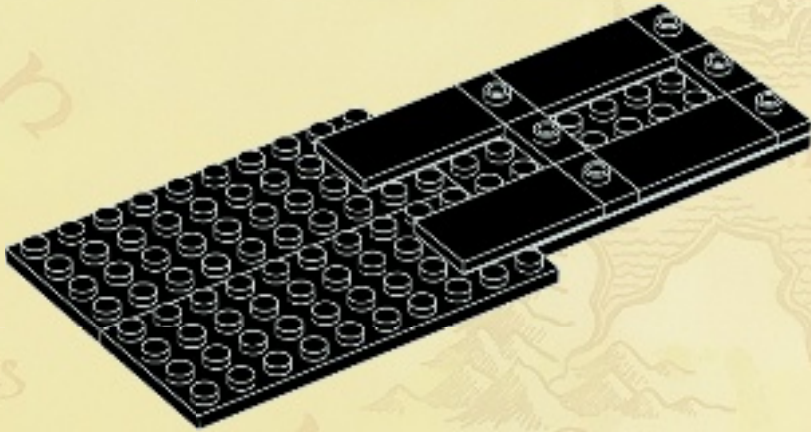

4

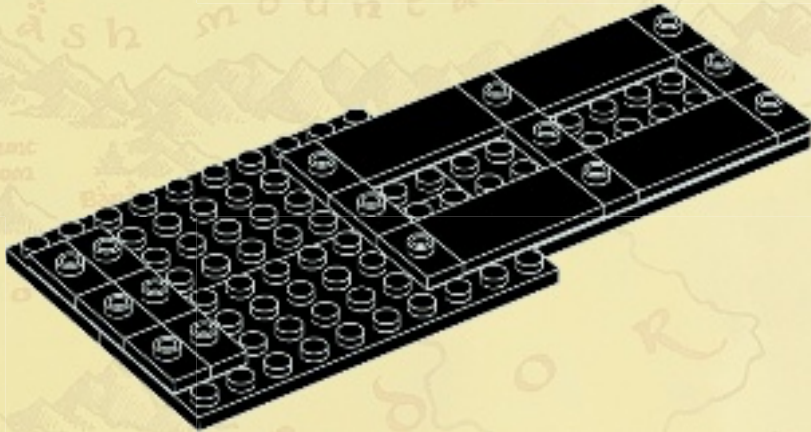



5

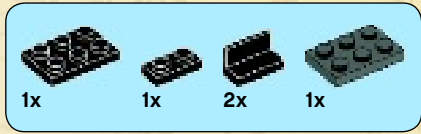
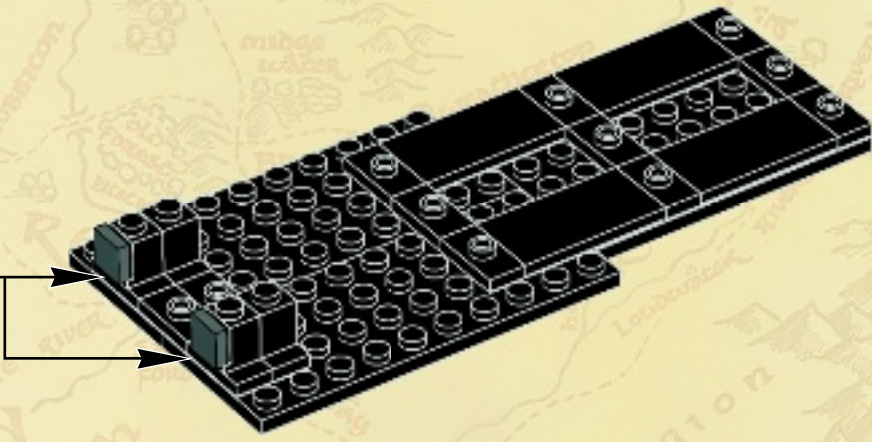
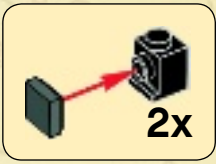

6

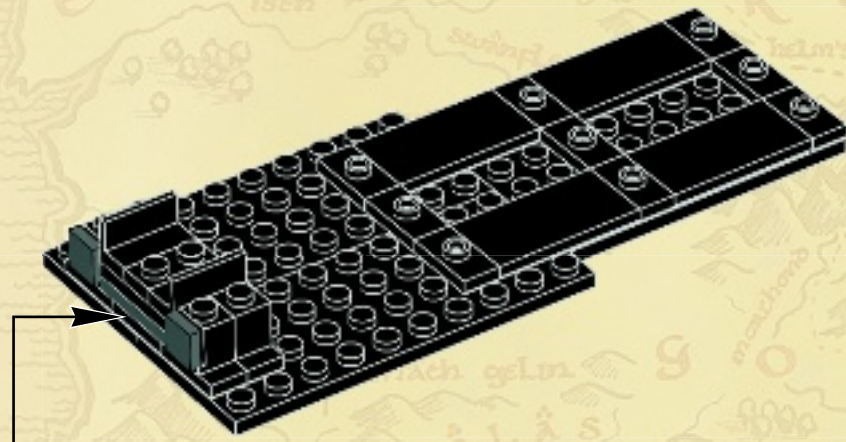
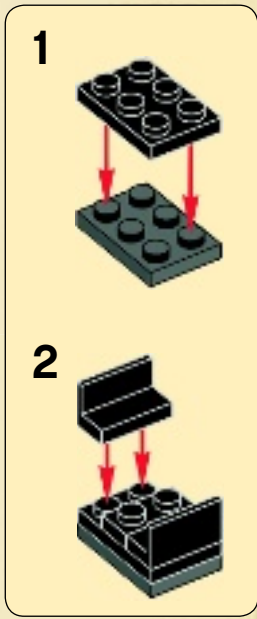

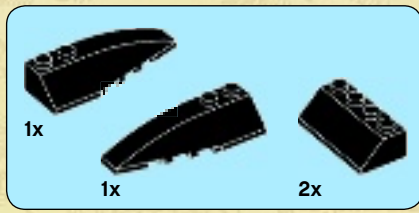

7

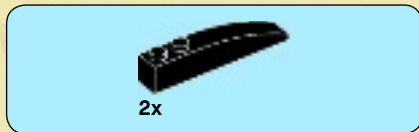
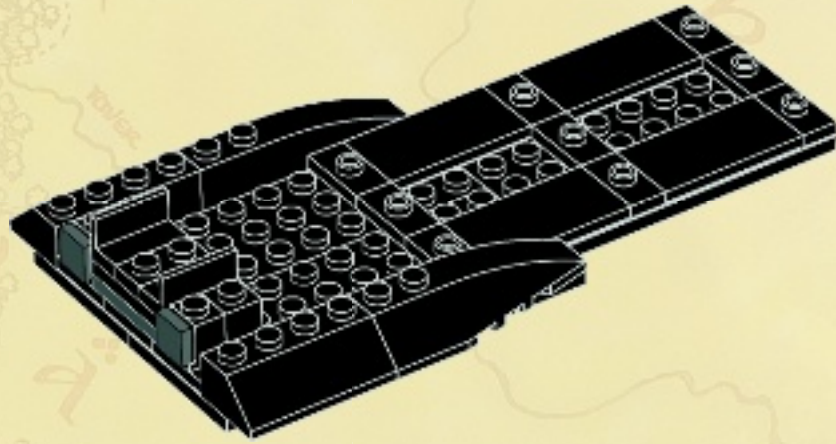

8

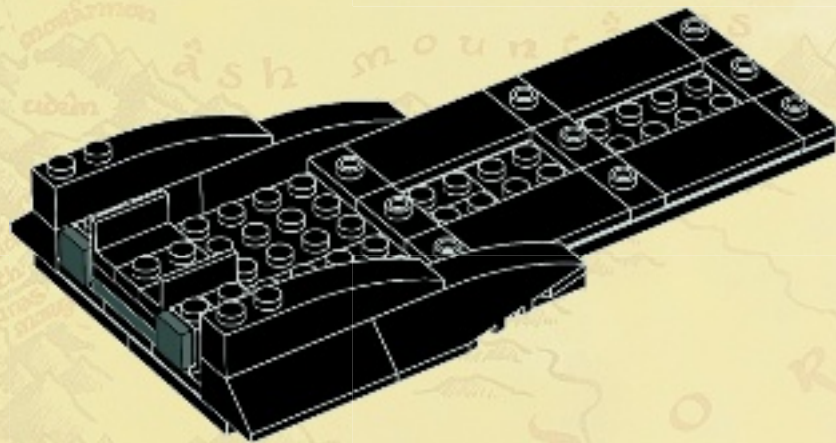

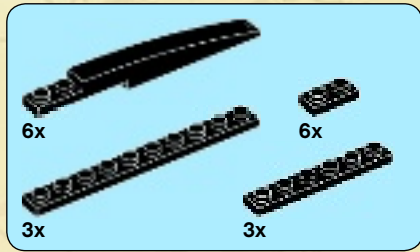

9

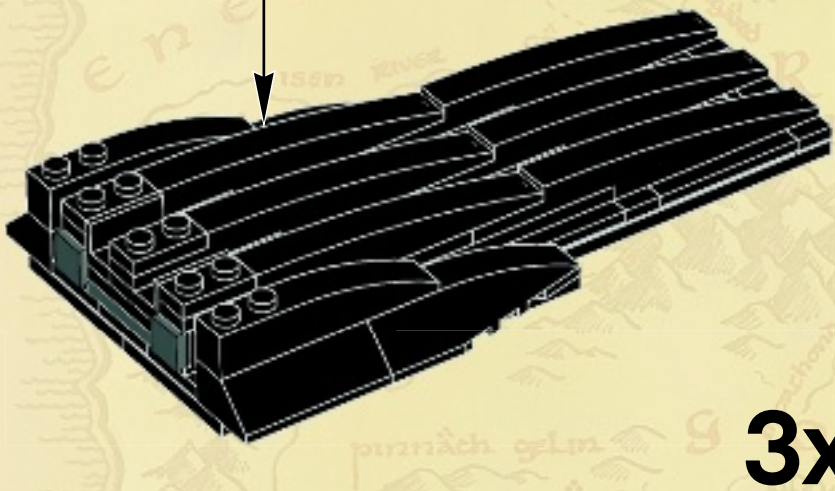
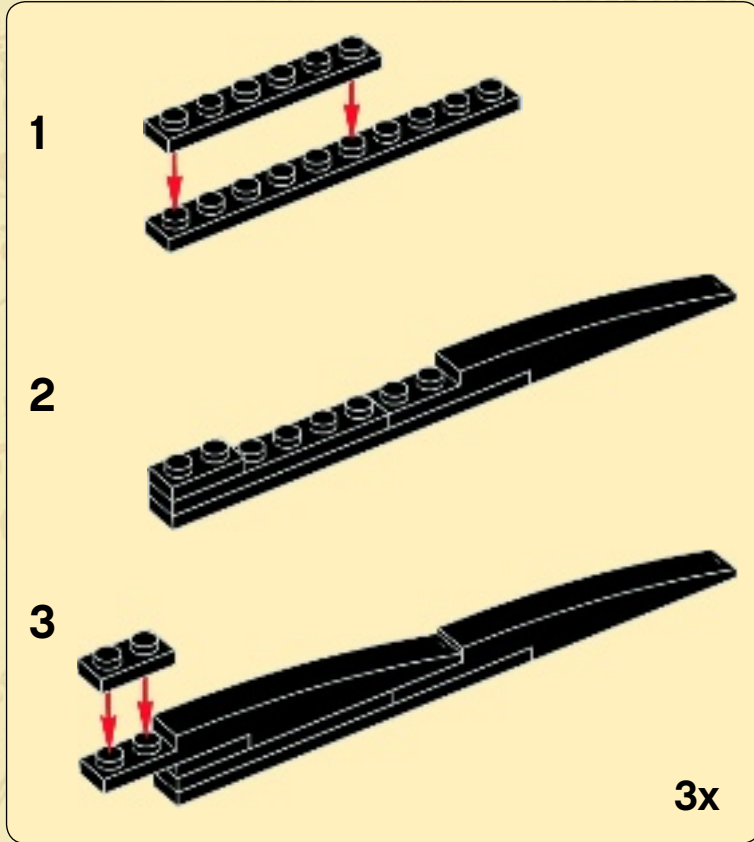

41

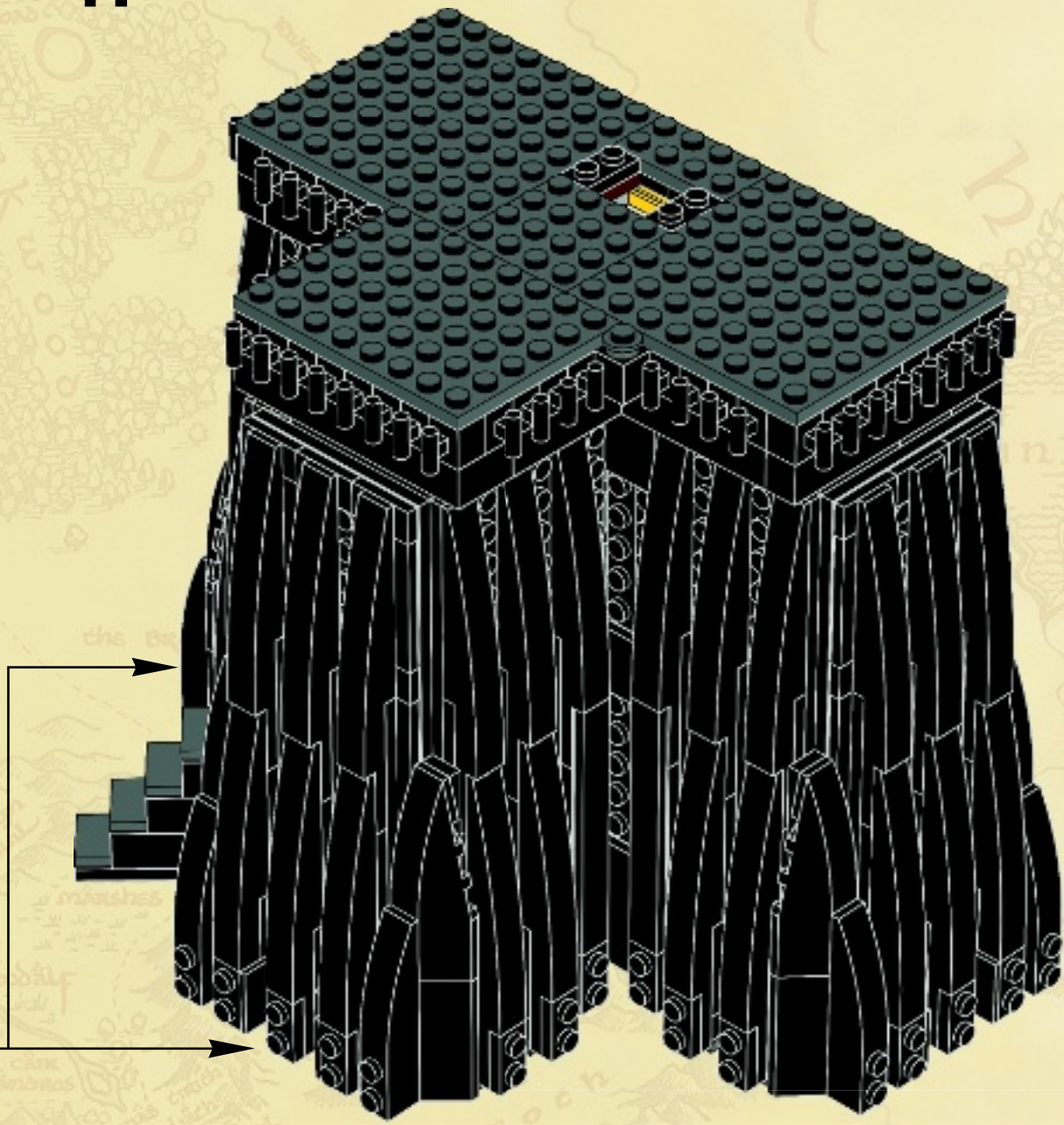

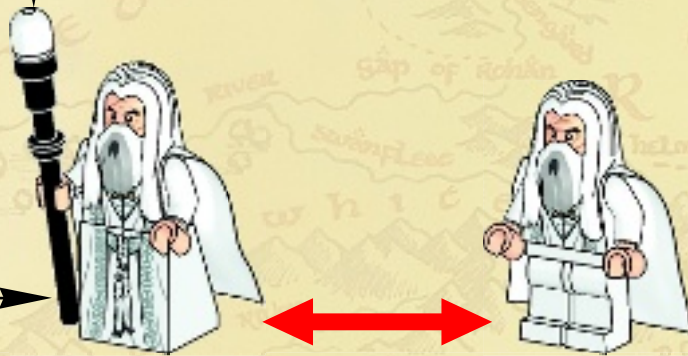
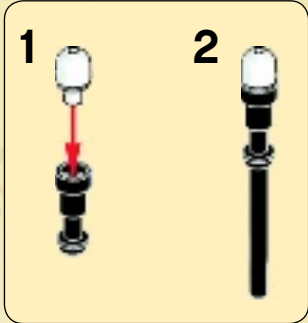
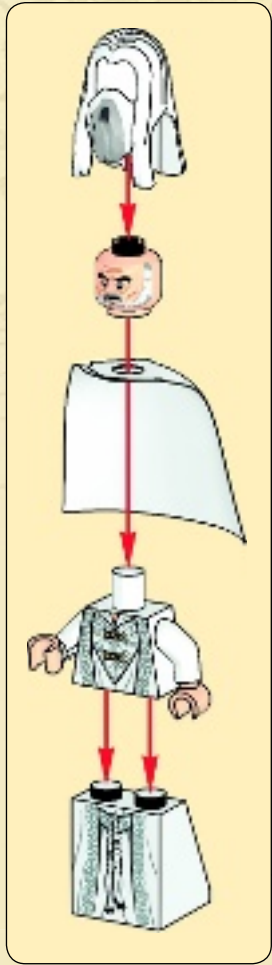
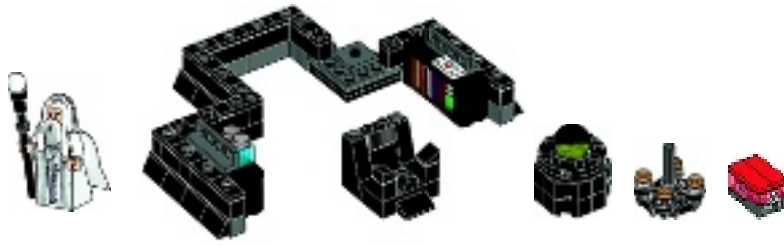

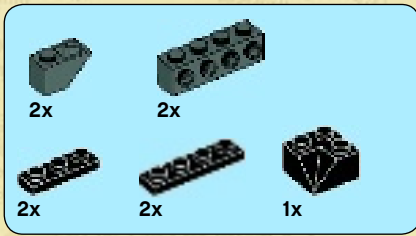

42

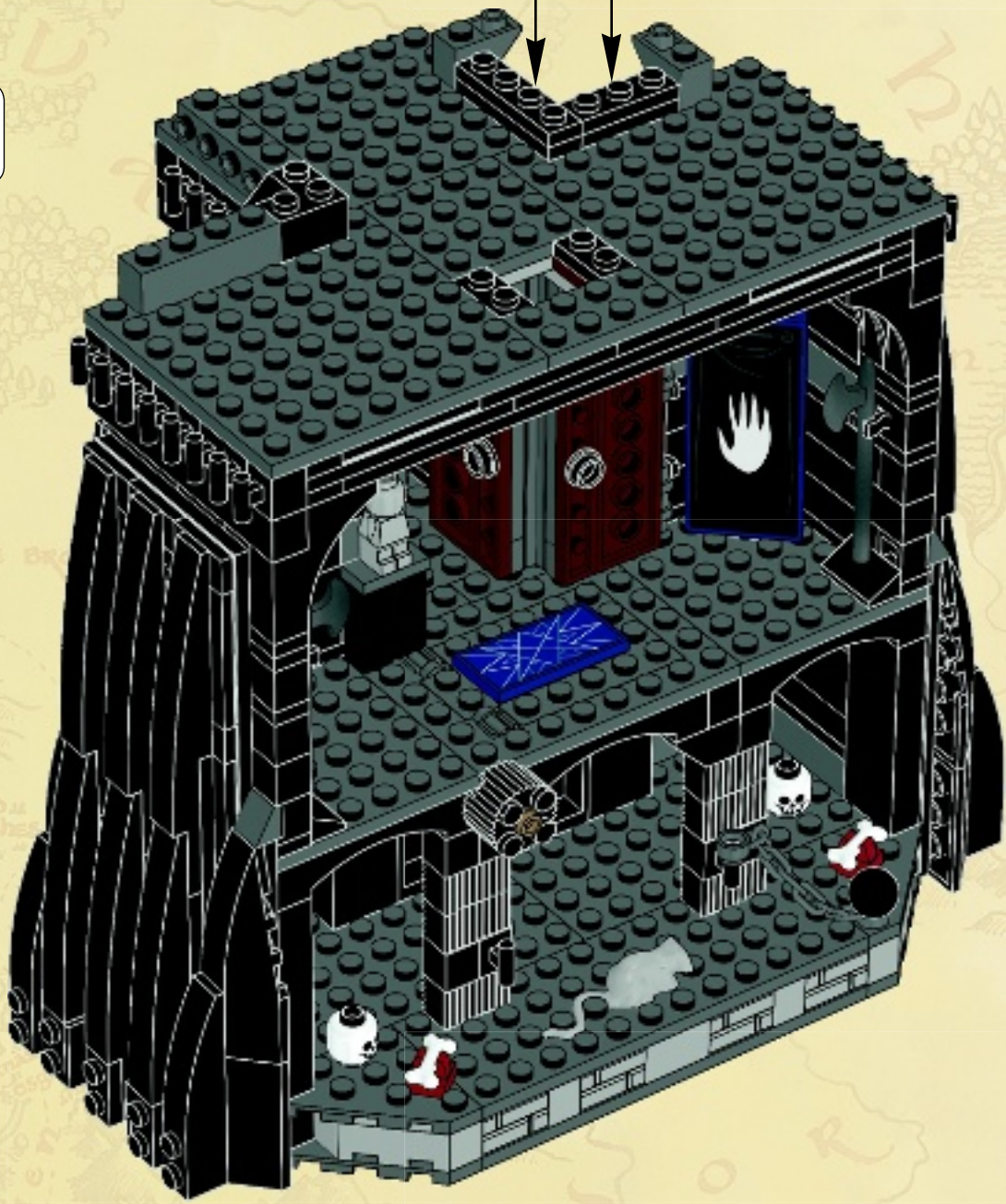
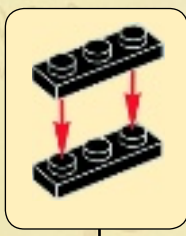
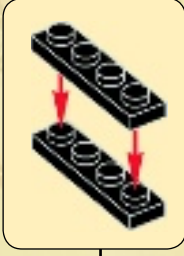



43

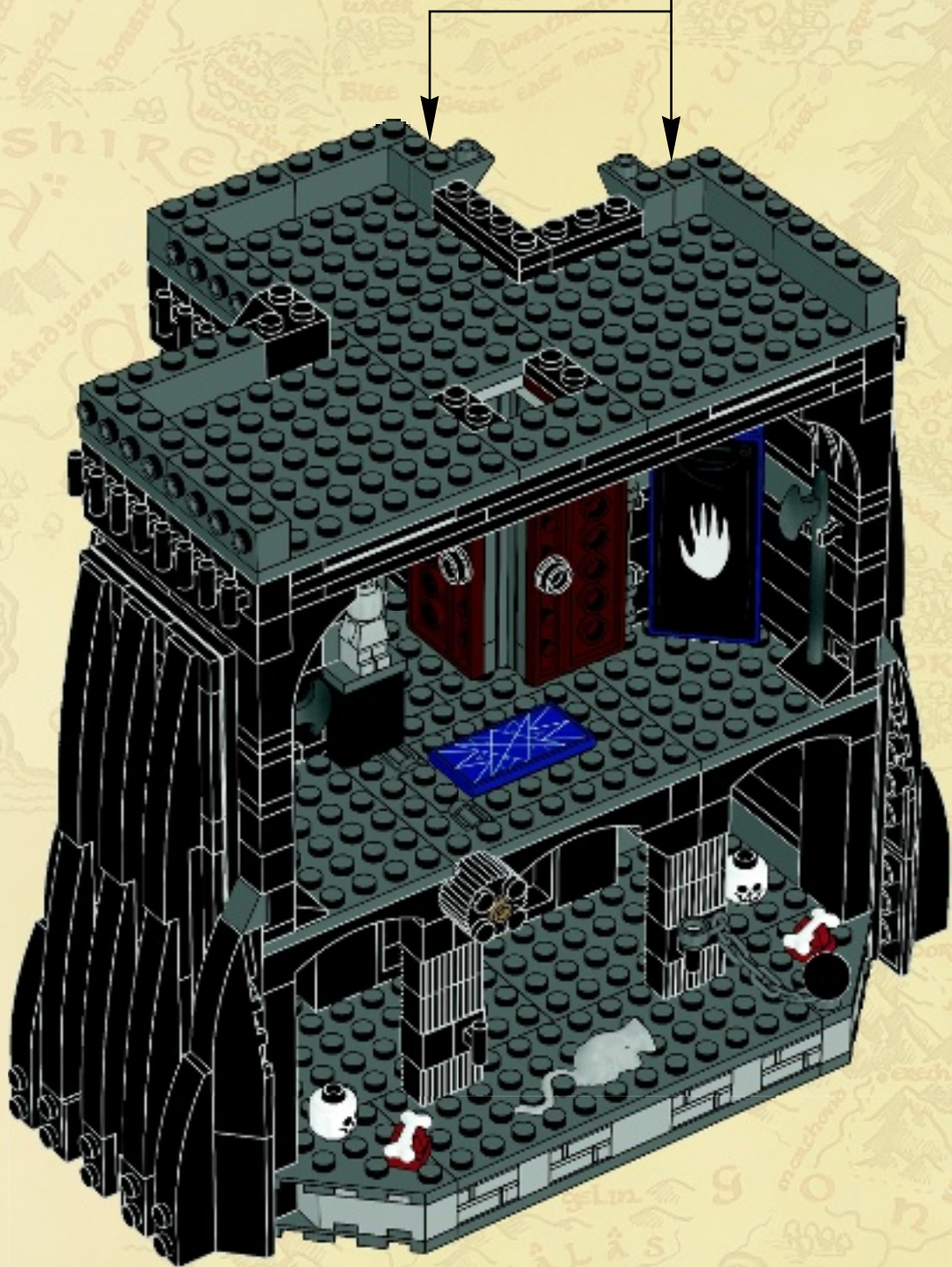

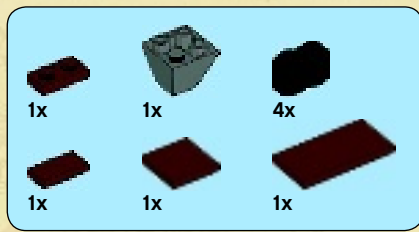

44

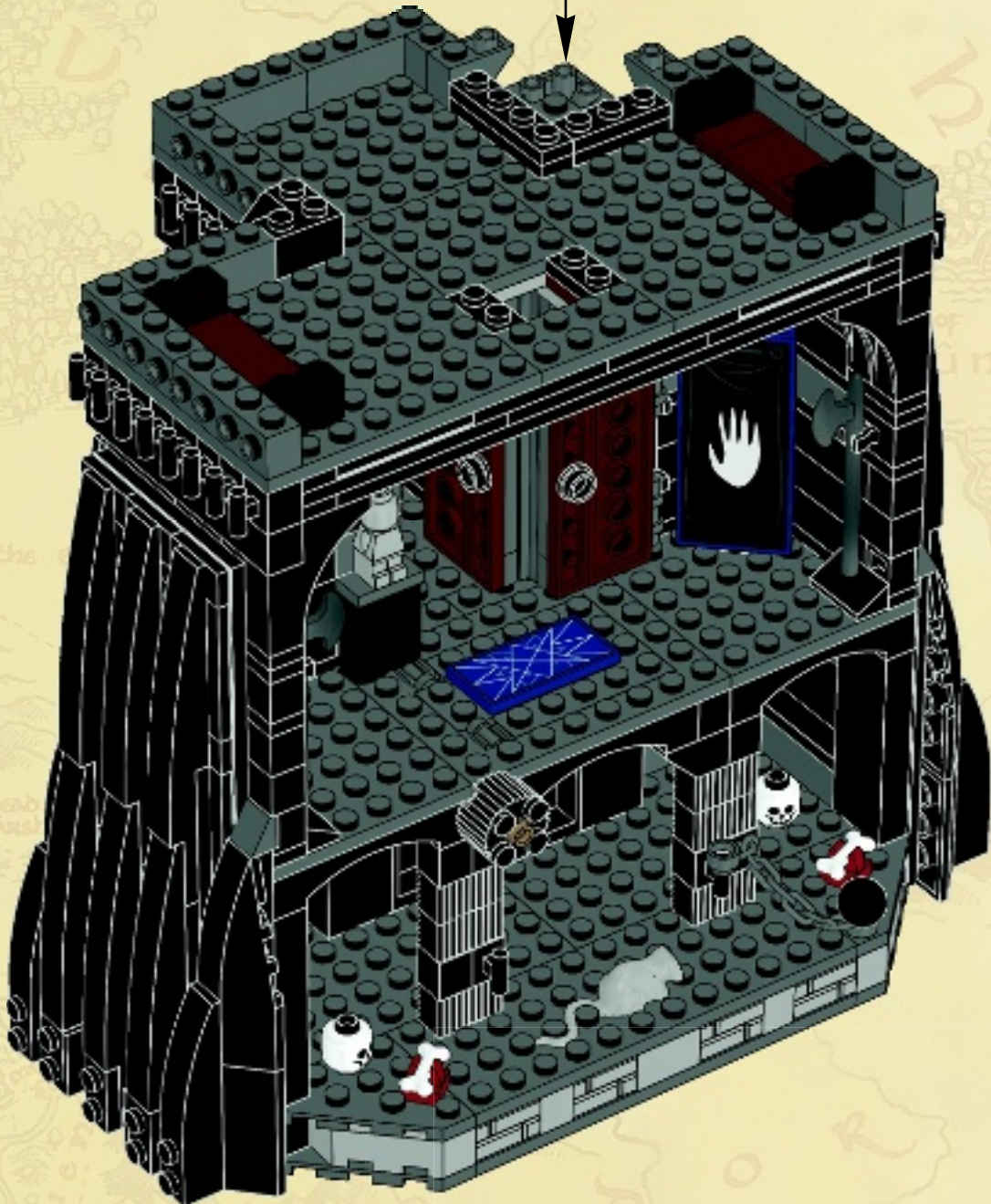
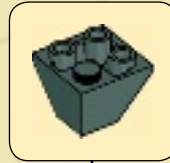

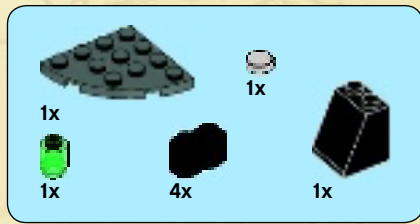

45

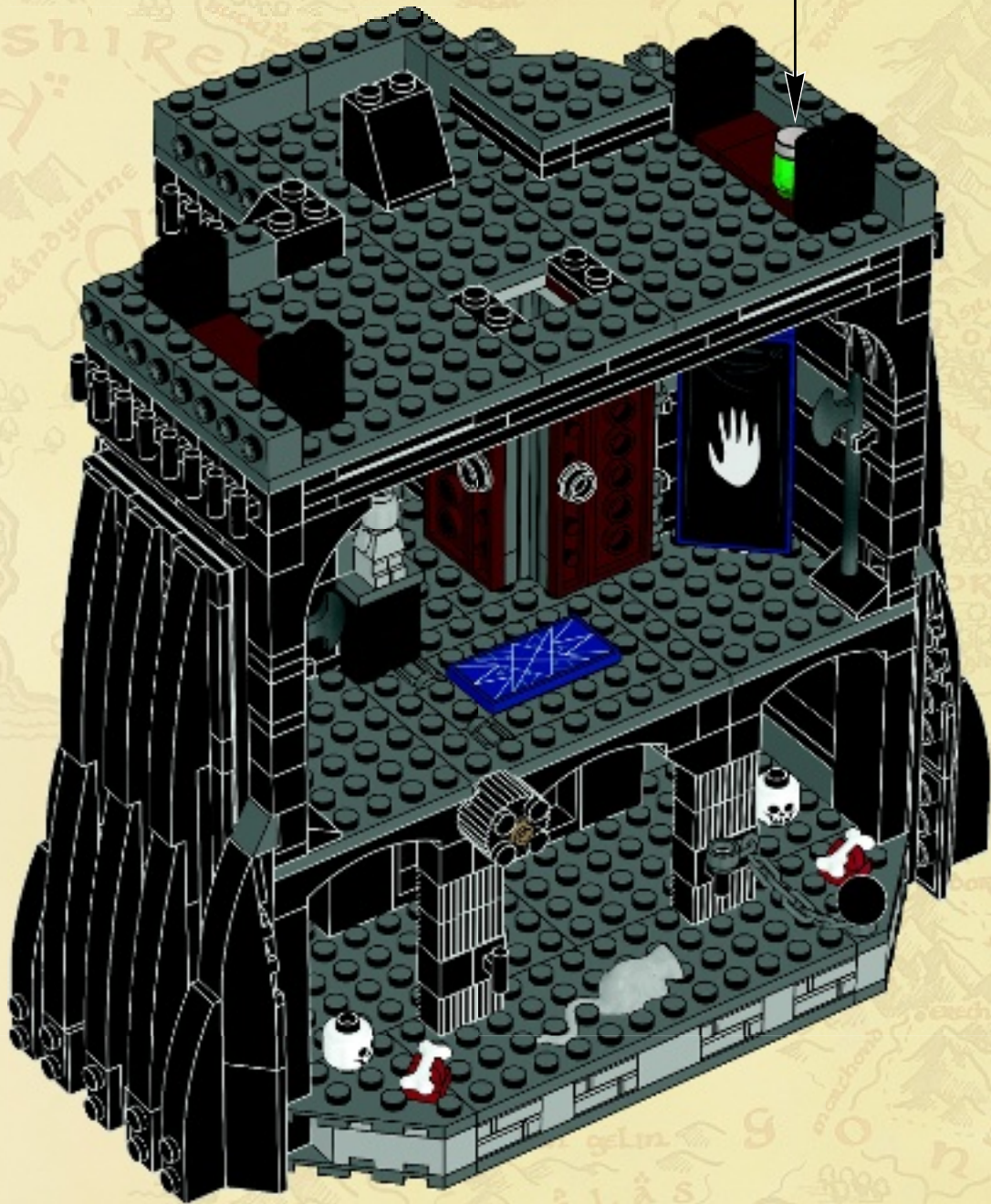

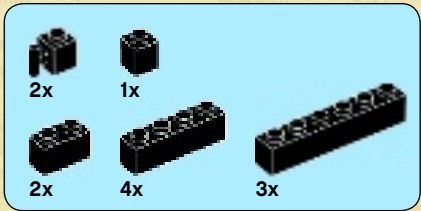

46

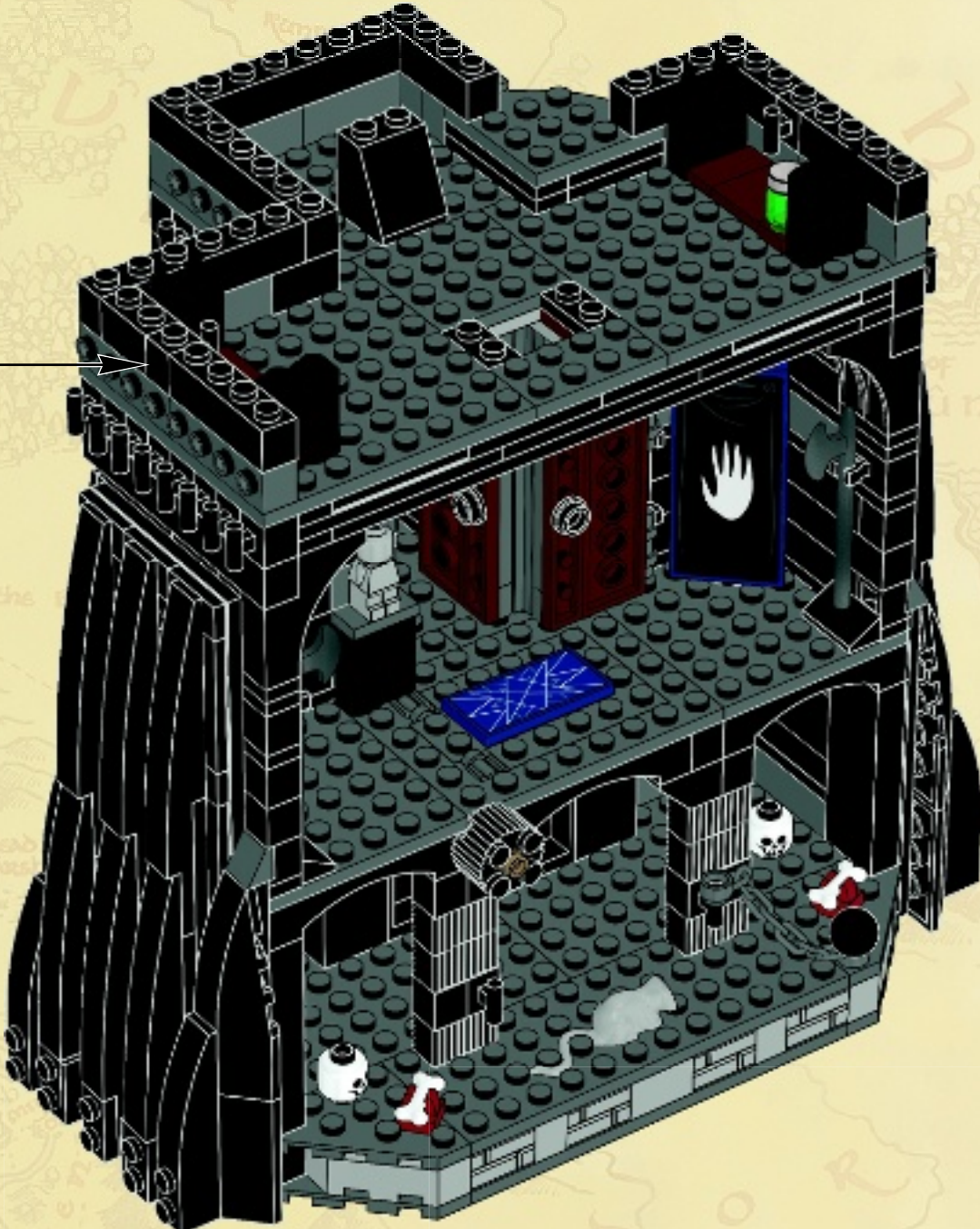

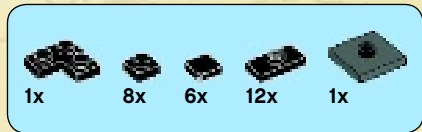

47

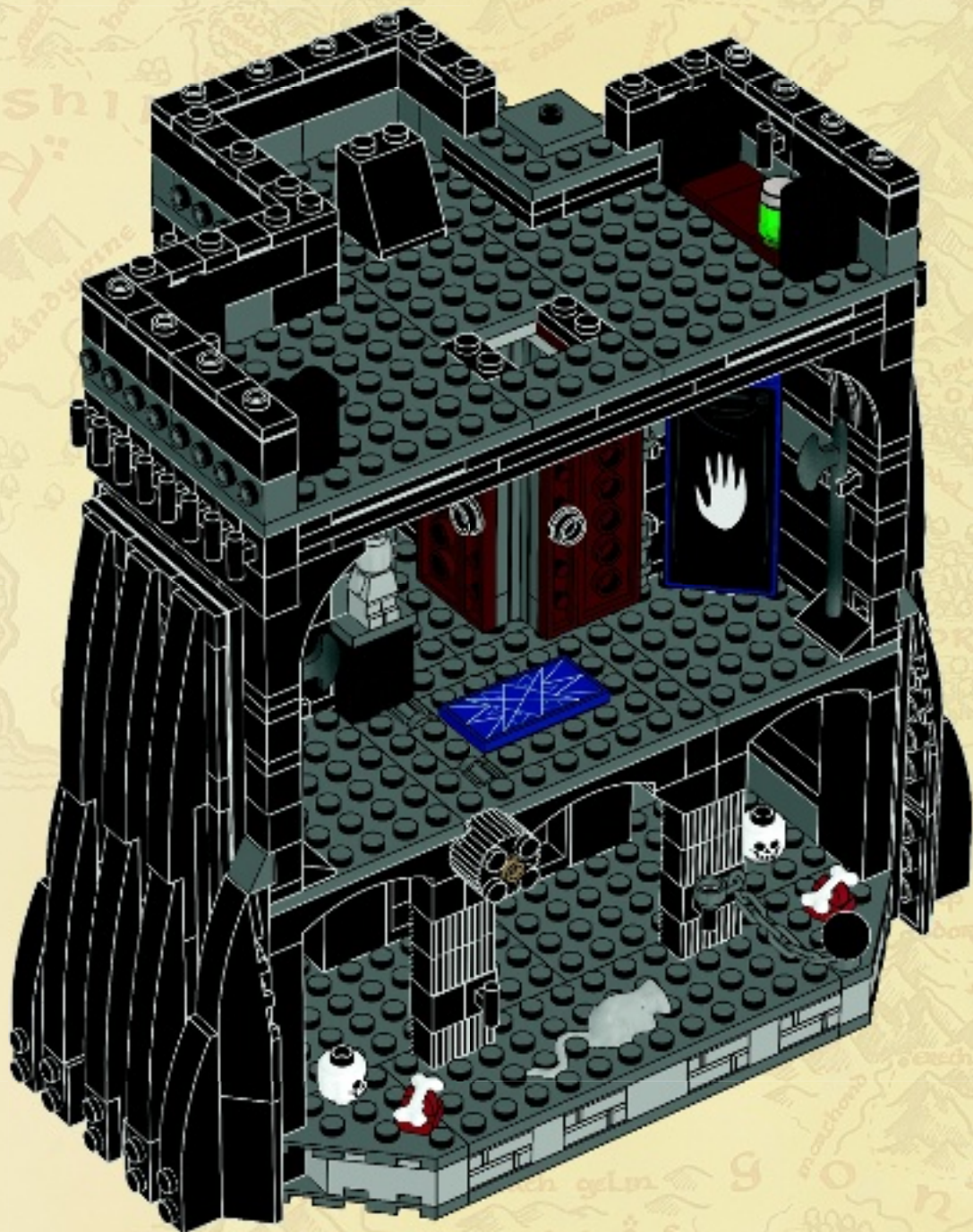

- 1x
- 3x
- 3x
- 3x
- 2x
- 1x

48

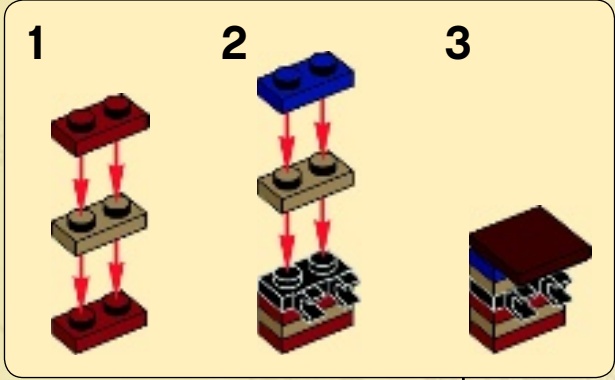
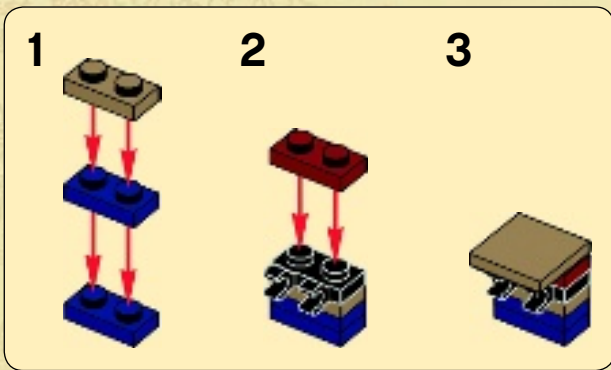



2x



18x

49

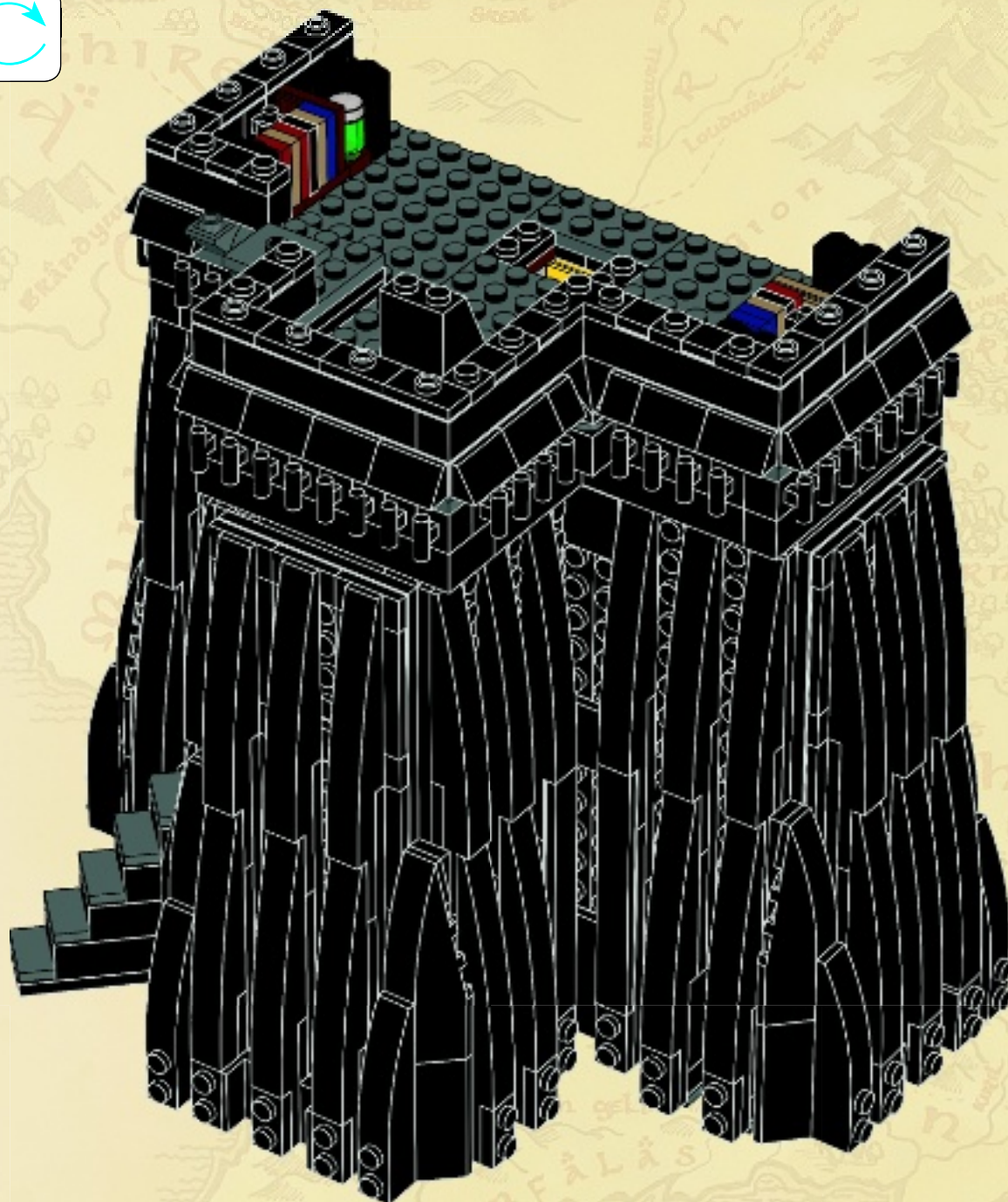
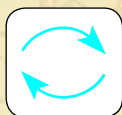

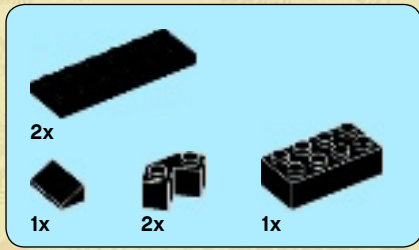

50

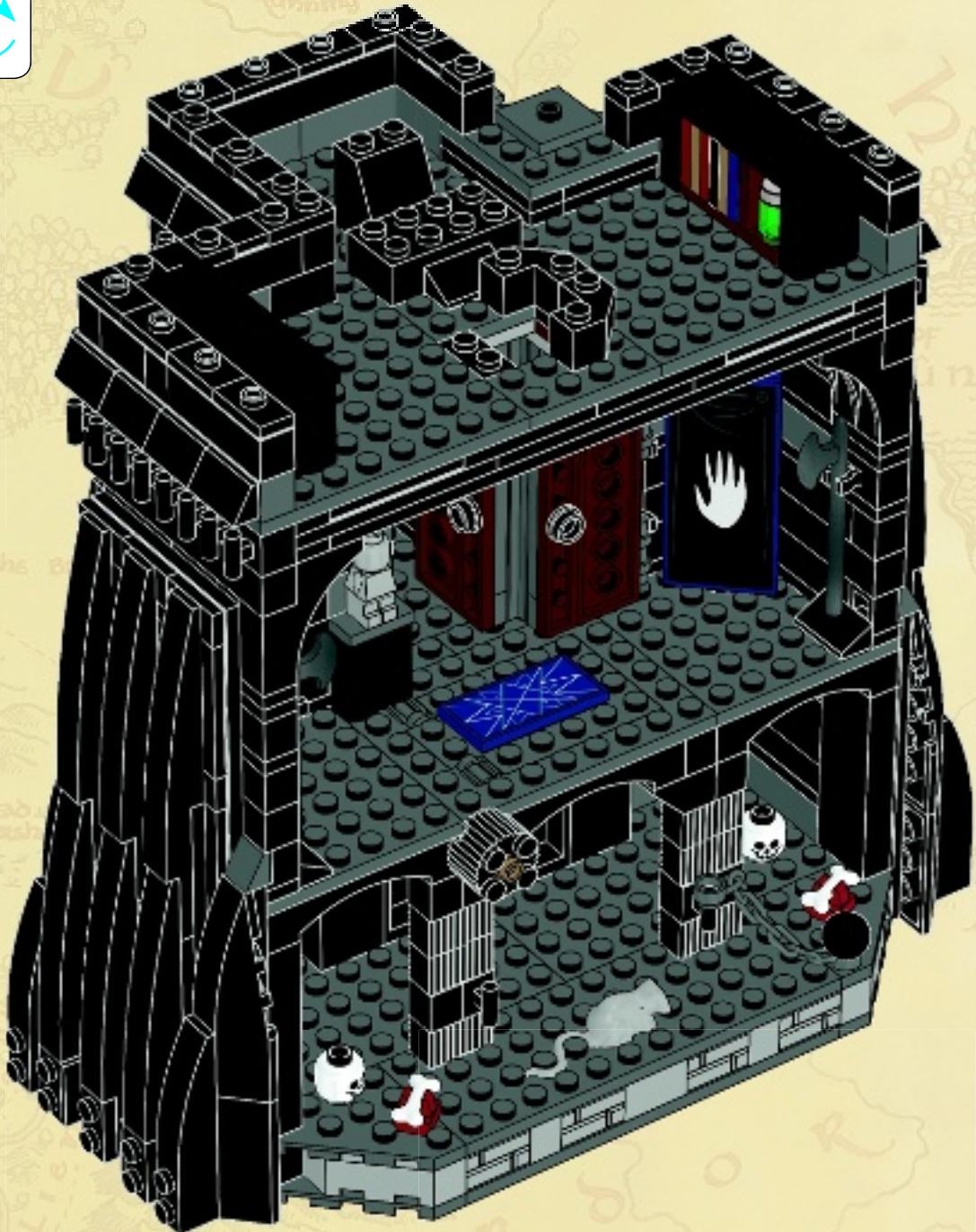

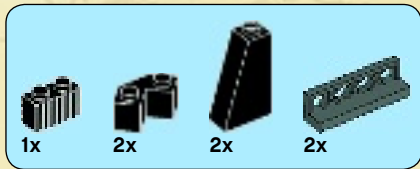

51

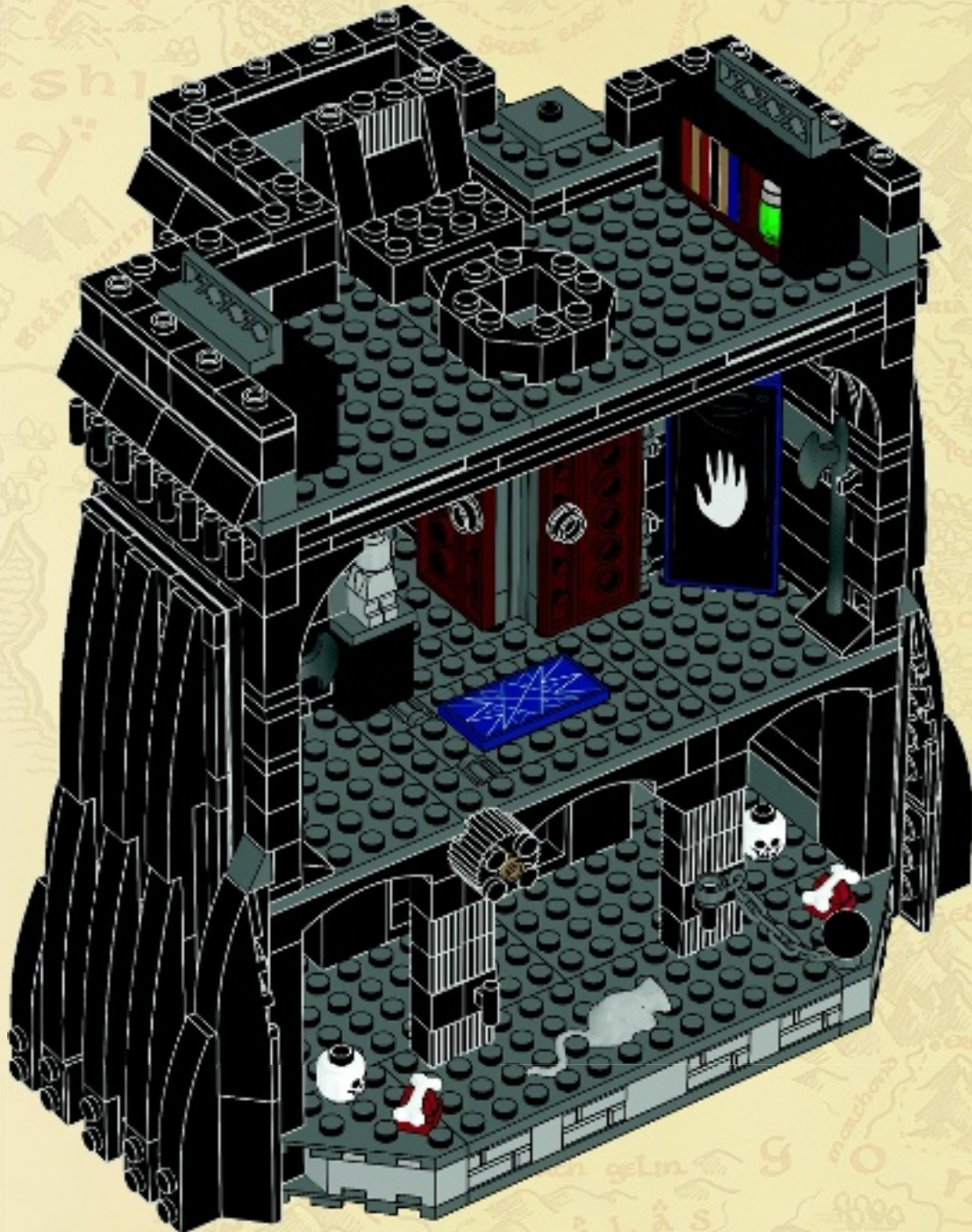

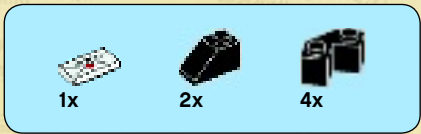

52

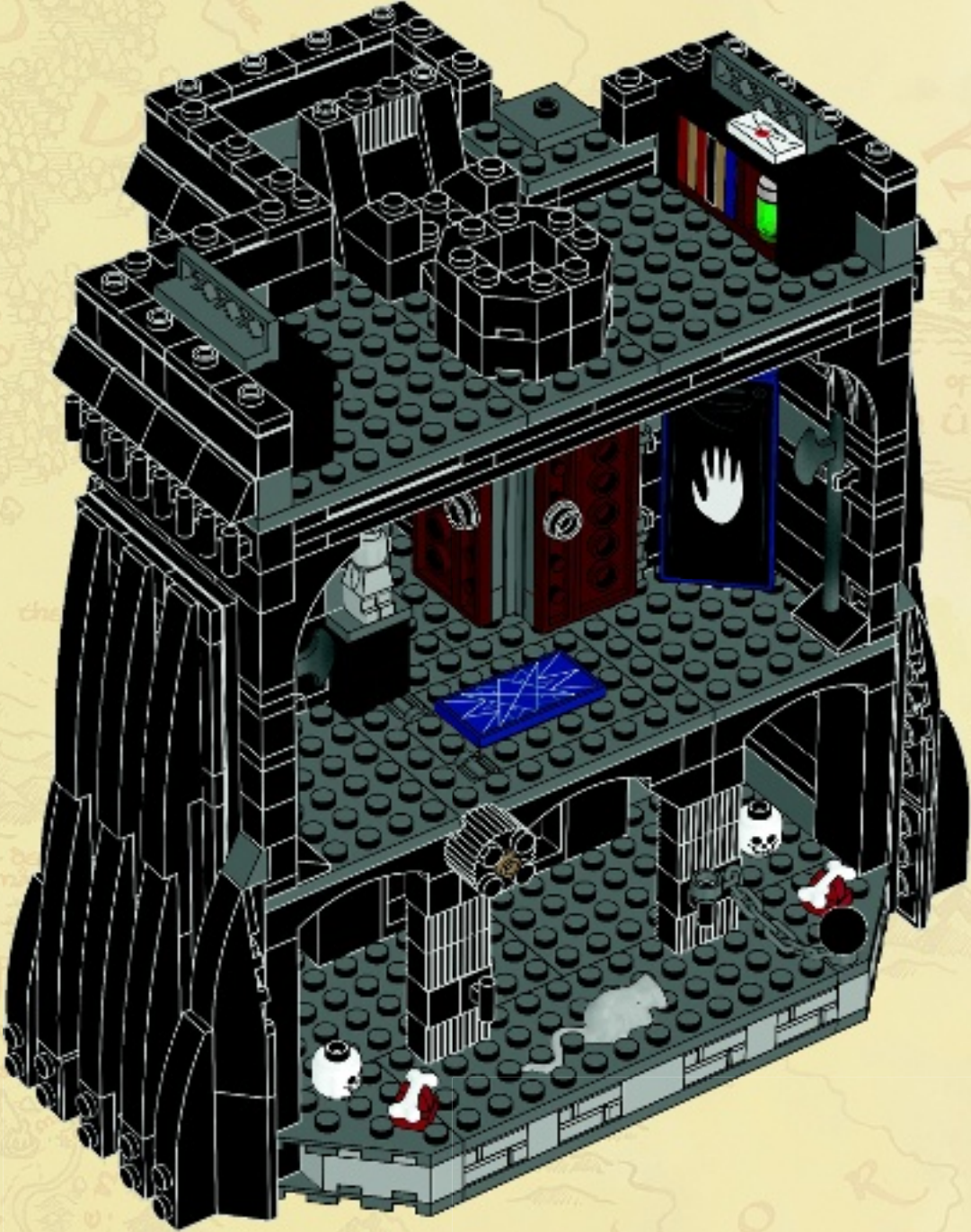



Light brick



53

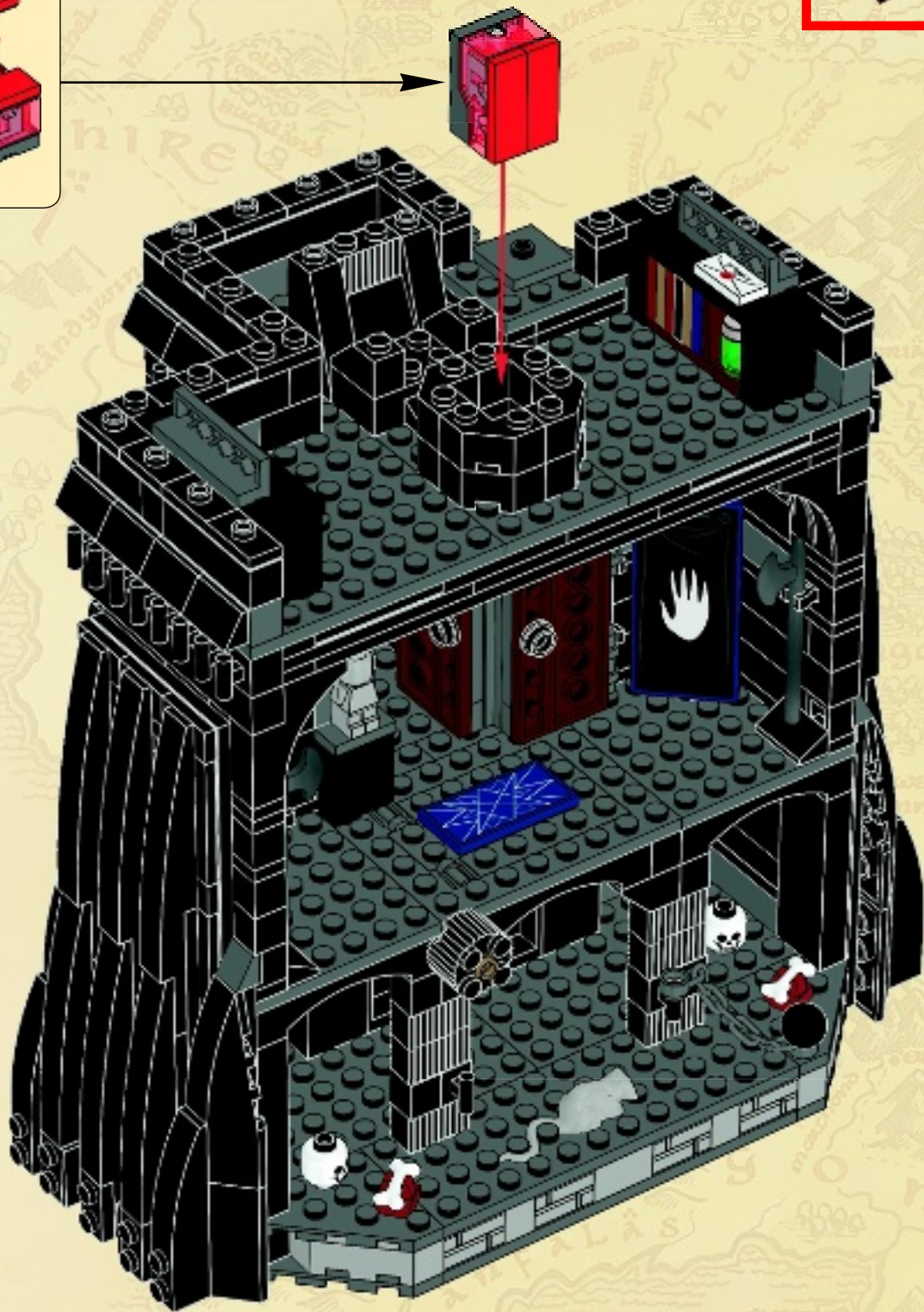
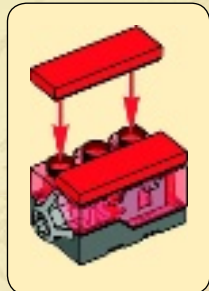

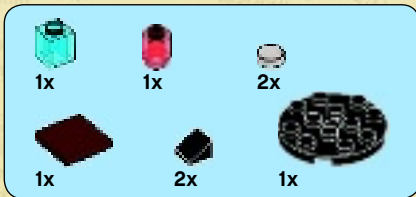

54

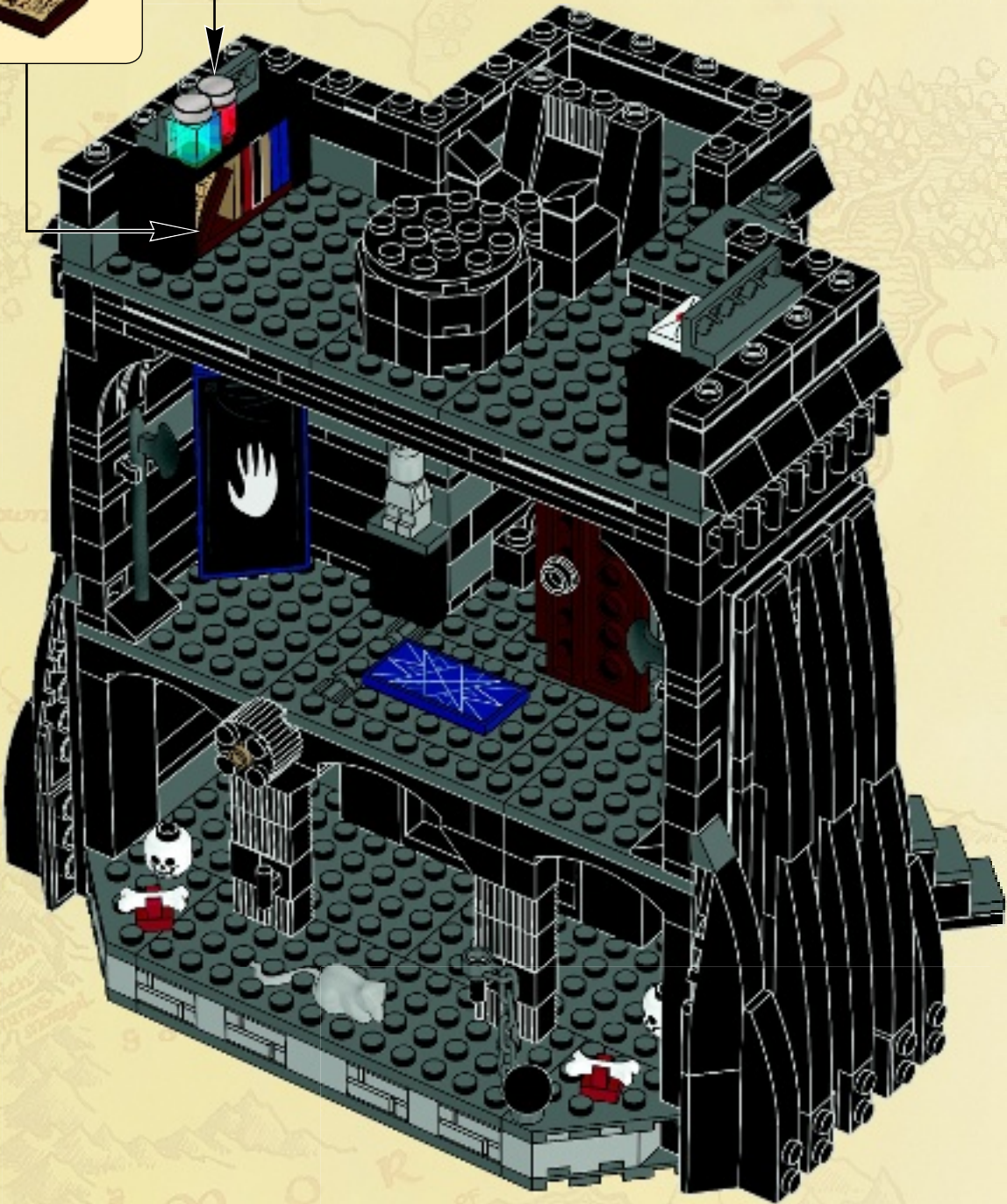
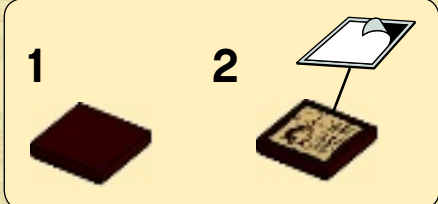

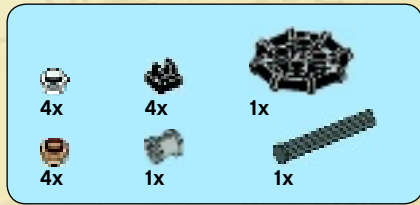

55

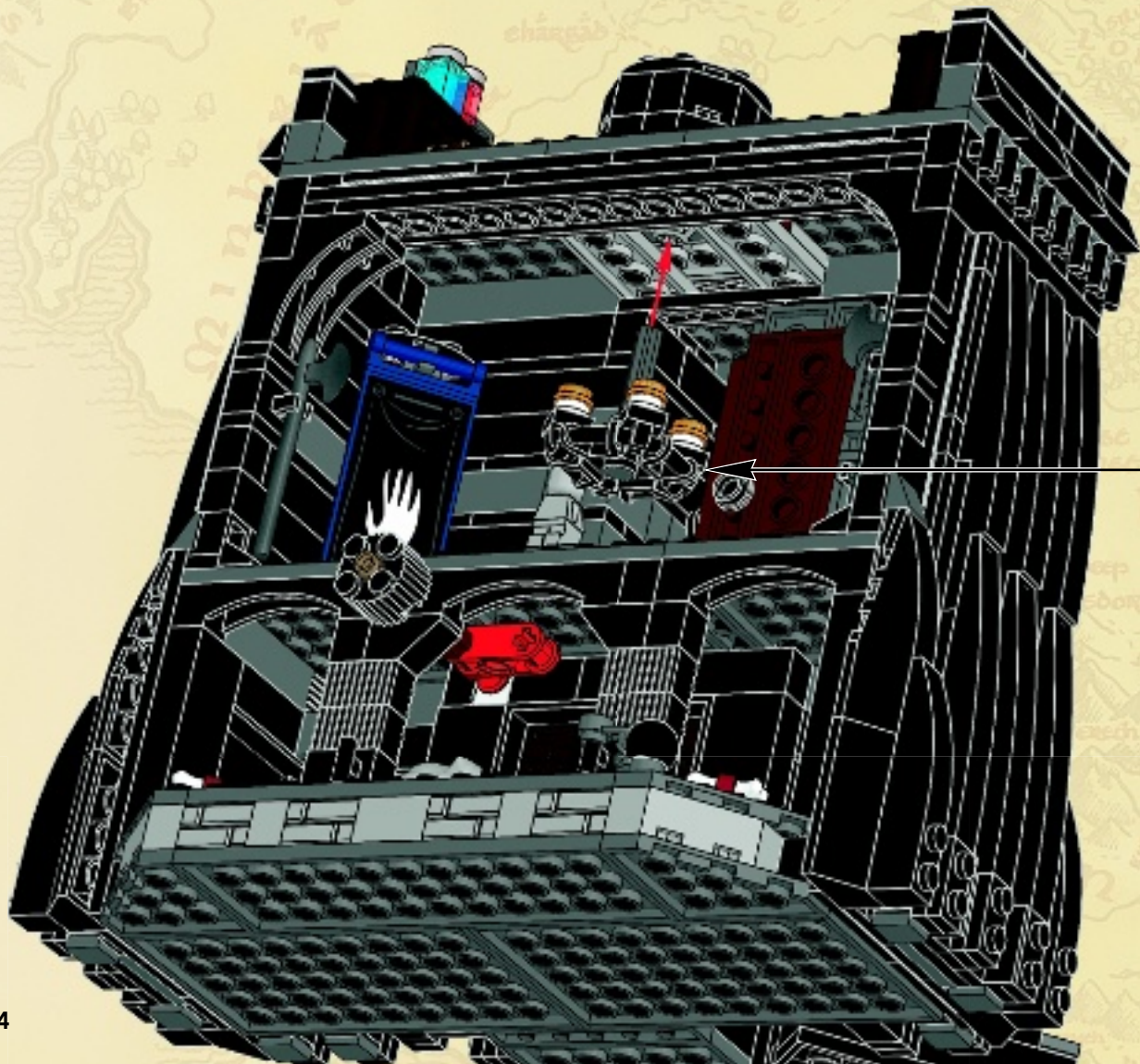



56

Light brick

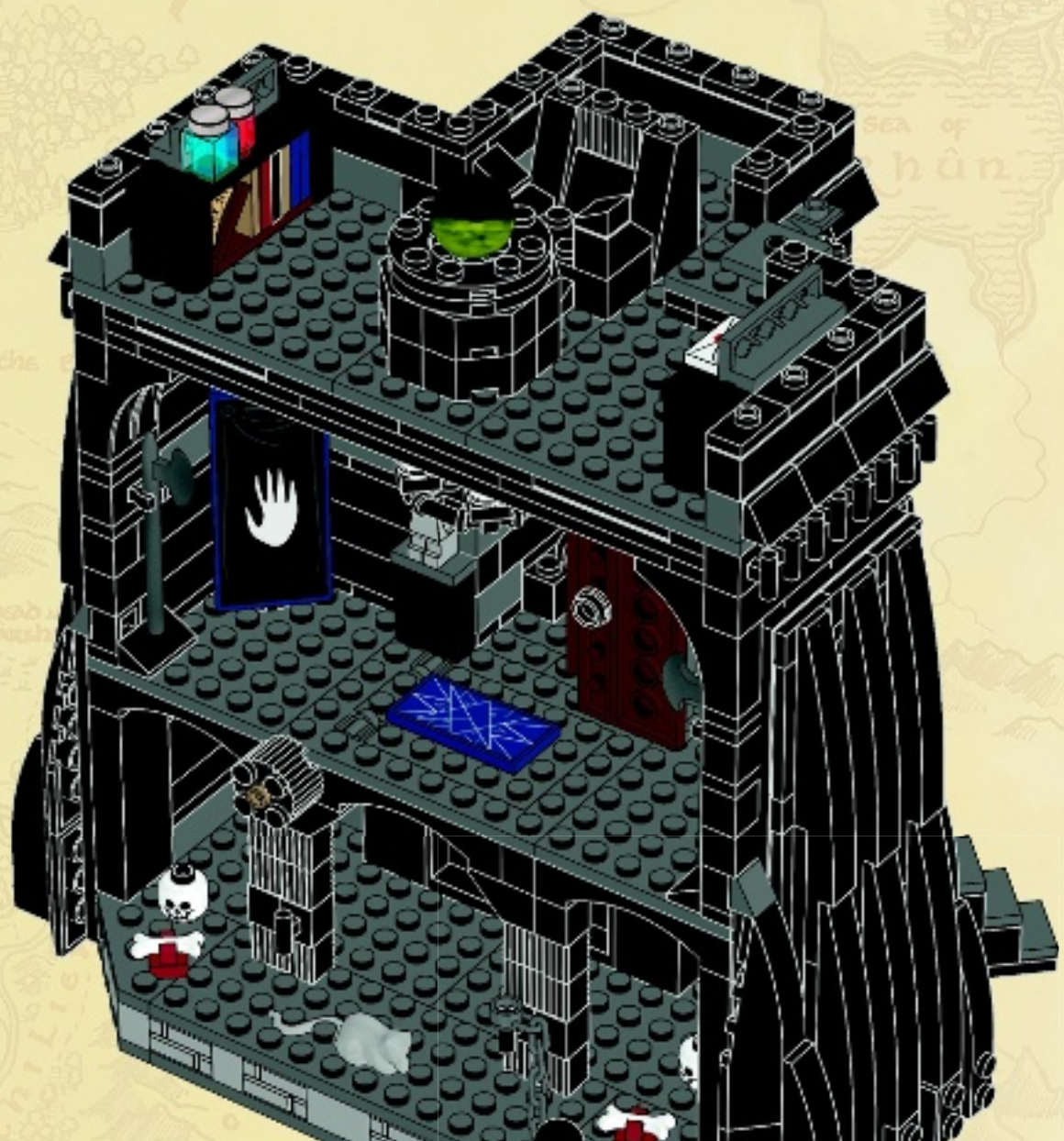

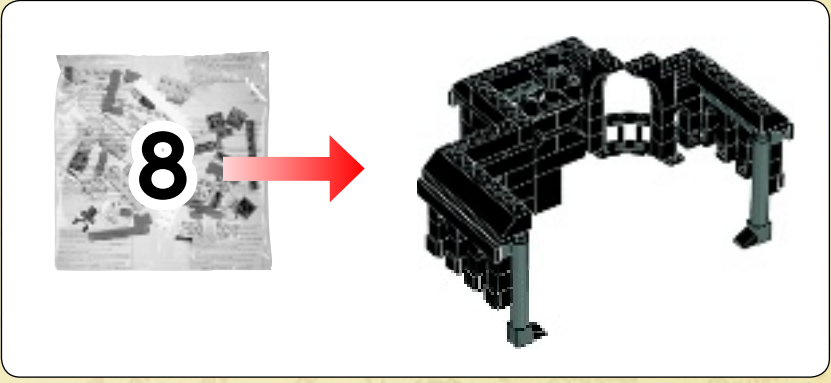

22x 18x 18x

A light blue rounded rectangle containing three small icons of black Technic parts: a 1x2 brick with a hole, a 1x2 brick, and a 1x2 brick with a hole. Below each icon is a quantity: 22x, 18x, and 18x respectively.

57

1 2 18x

1: A small black 1x2 brick with a hole is shown being attached to a larger black Technic structure.

2: A black 1x2 brick with a hole is shown being attached to another black Technic structure.

18x: A black 1x2 brick with a hole is shown with the quantity 18x below it.

2x

A black 1x2 brick with a hole is shown being attached to another black Technic structure.

2x: A black 1x2 brick with a hole is shown with the quantity 2x below it.





3x



10x

58

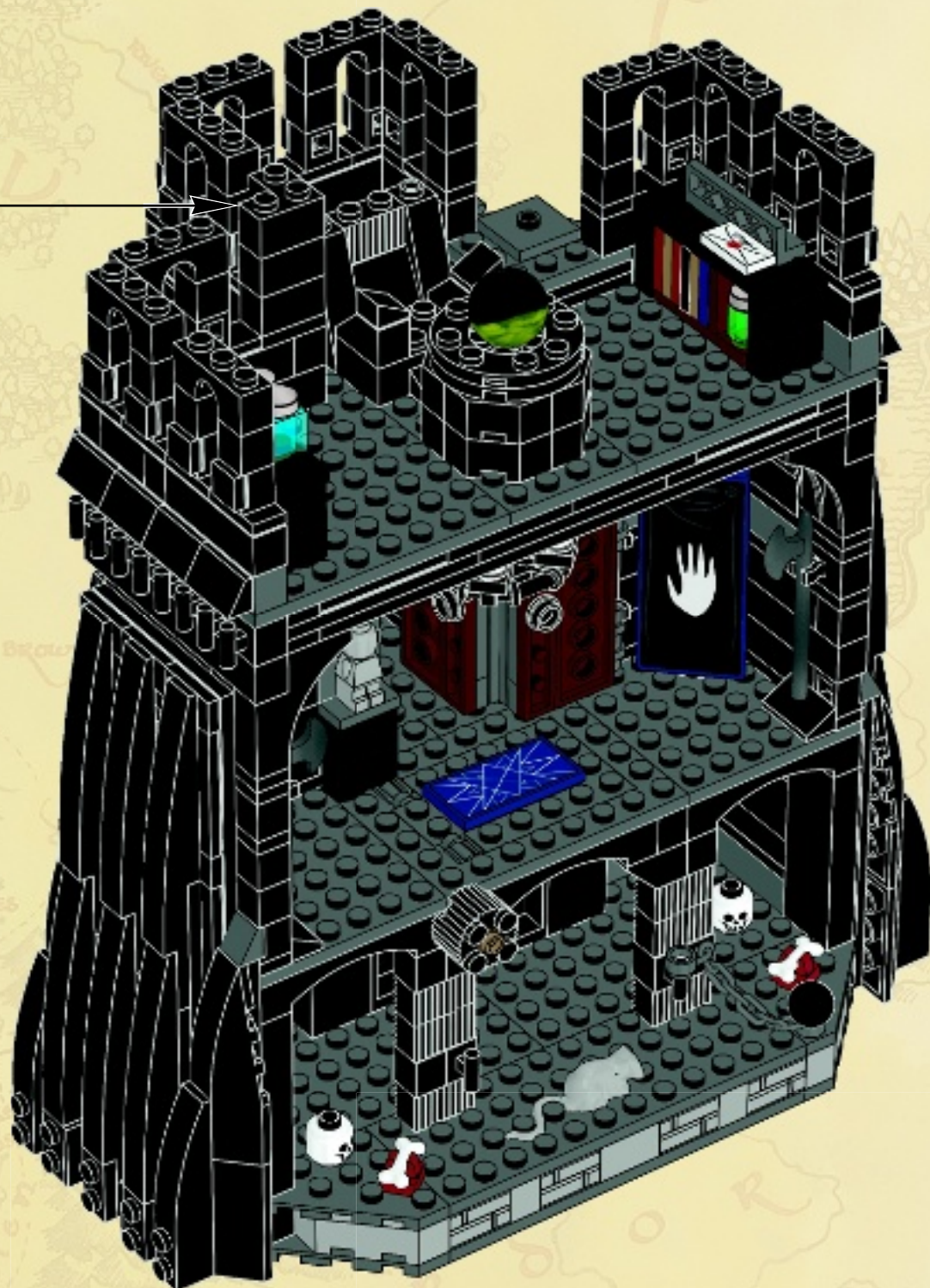
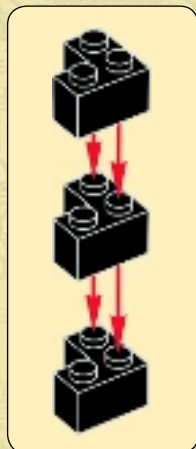

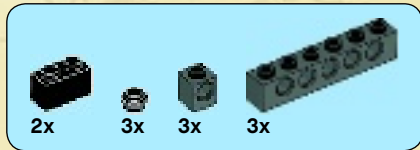

59

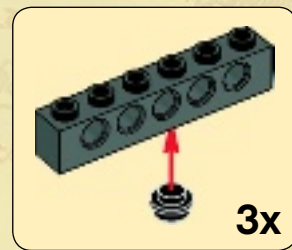
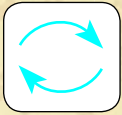

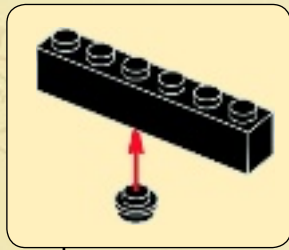
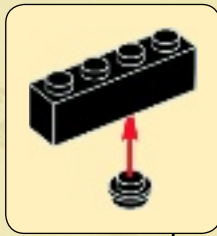
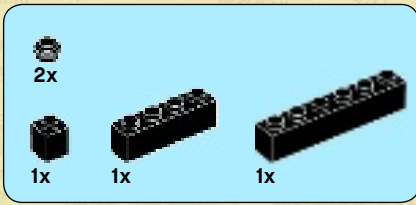

60



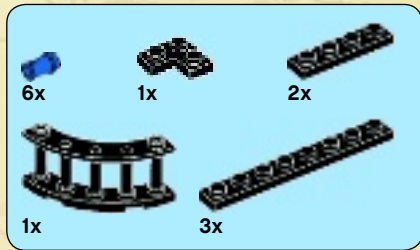

61

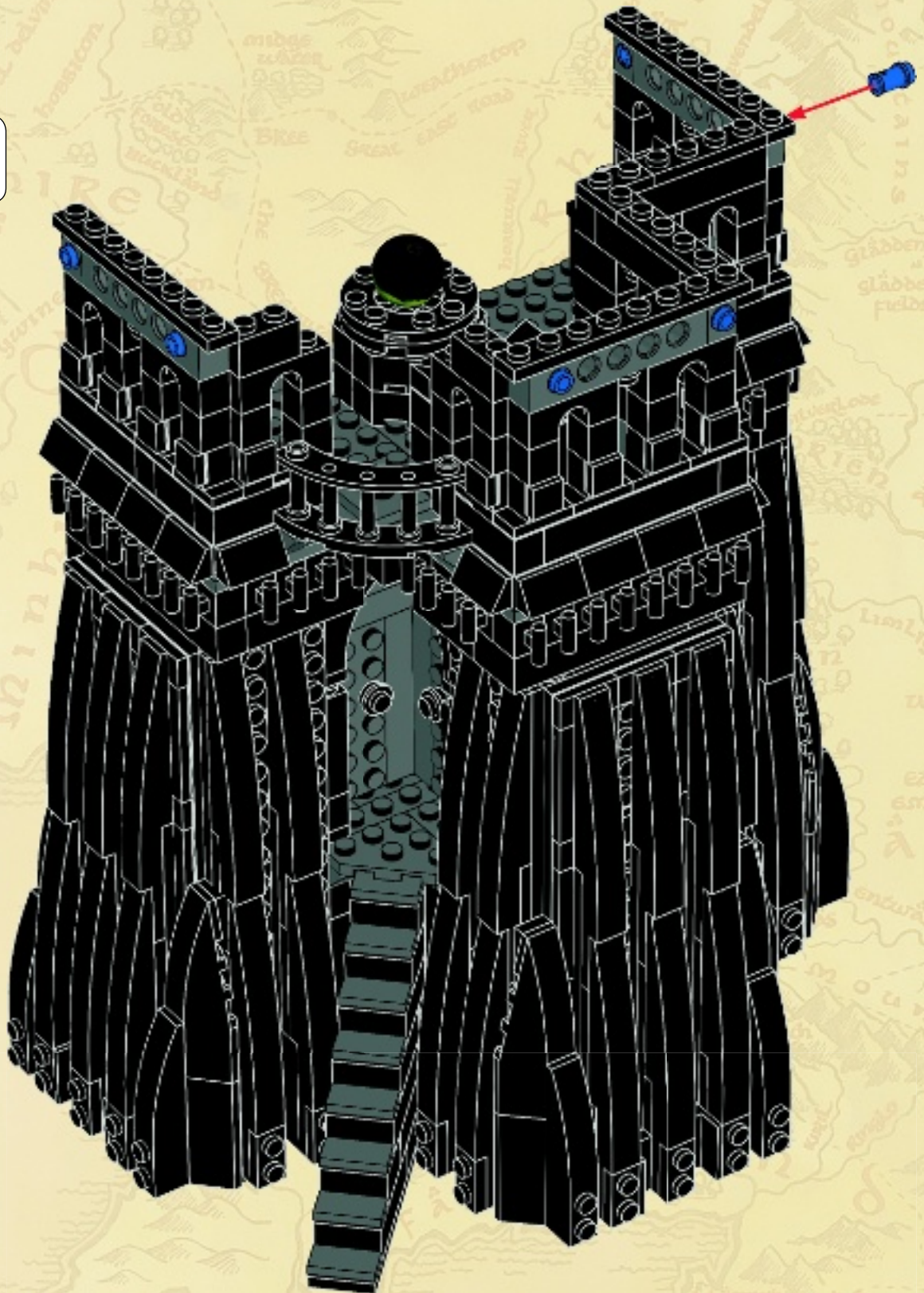

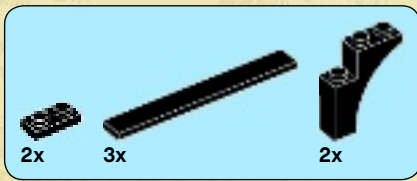

62





63

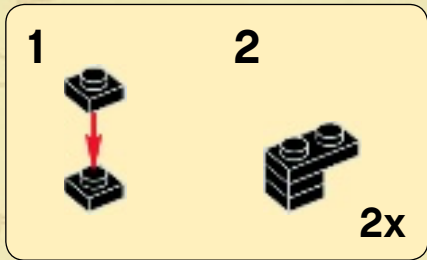

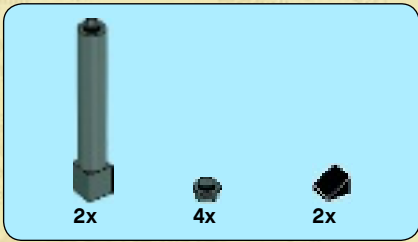

64

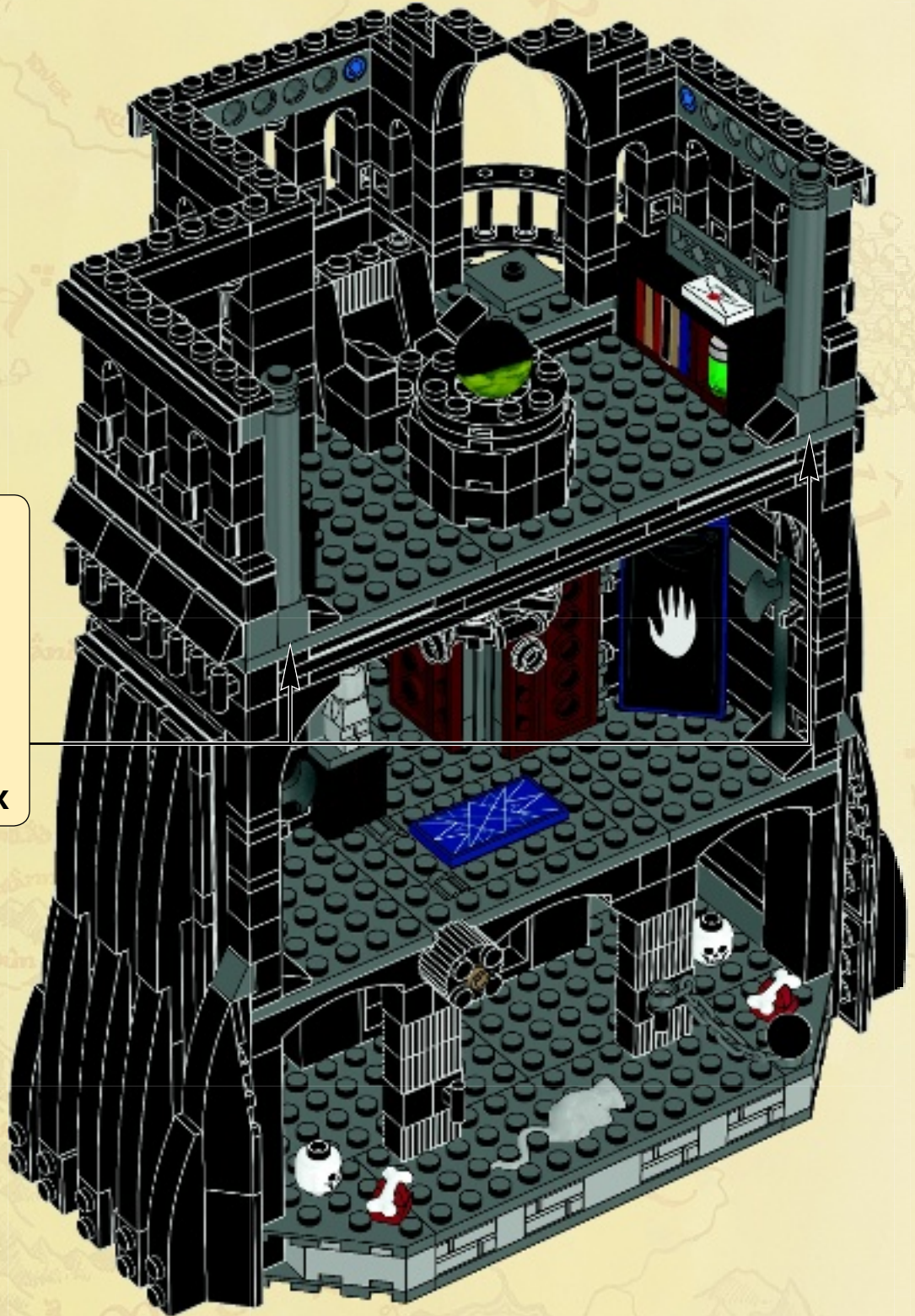
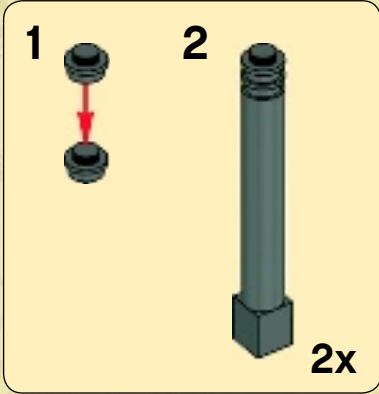
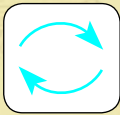

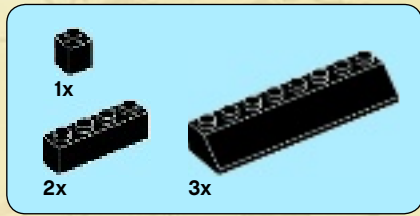

65

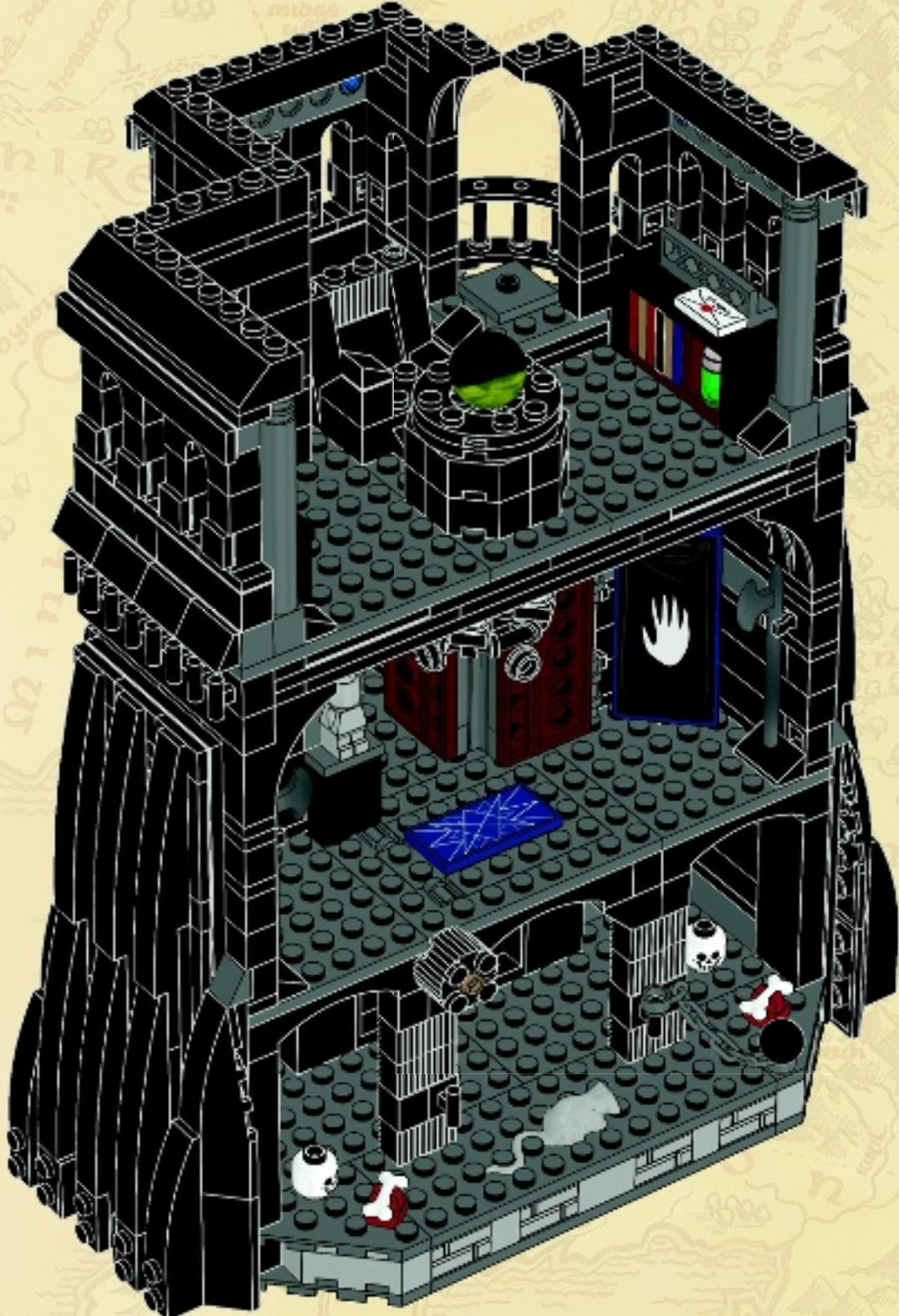

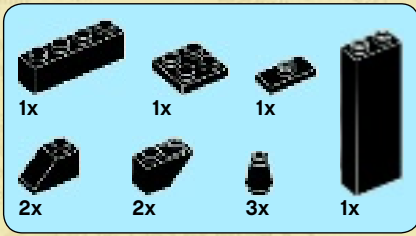

66

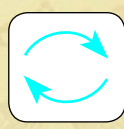
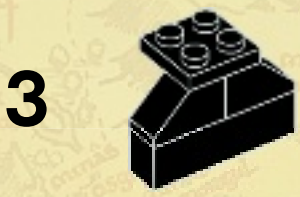

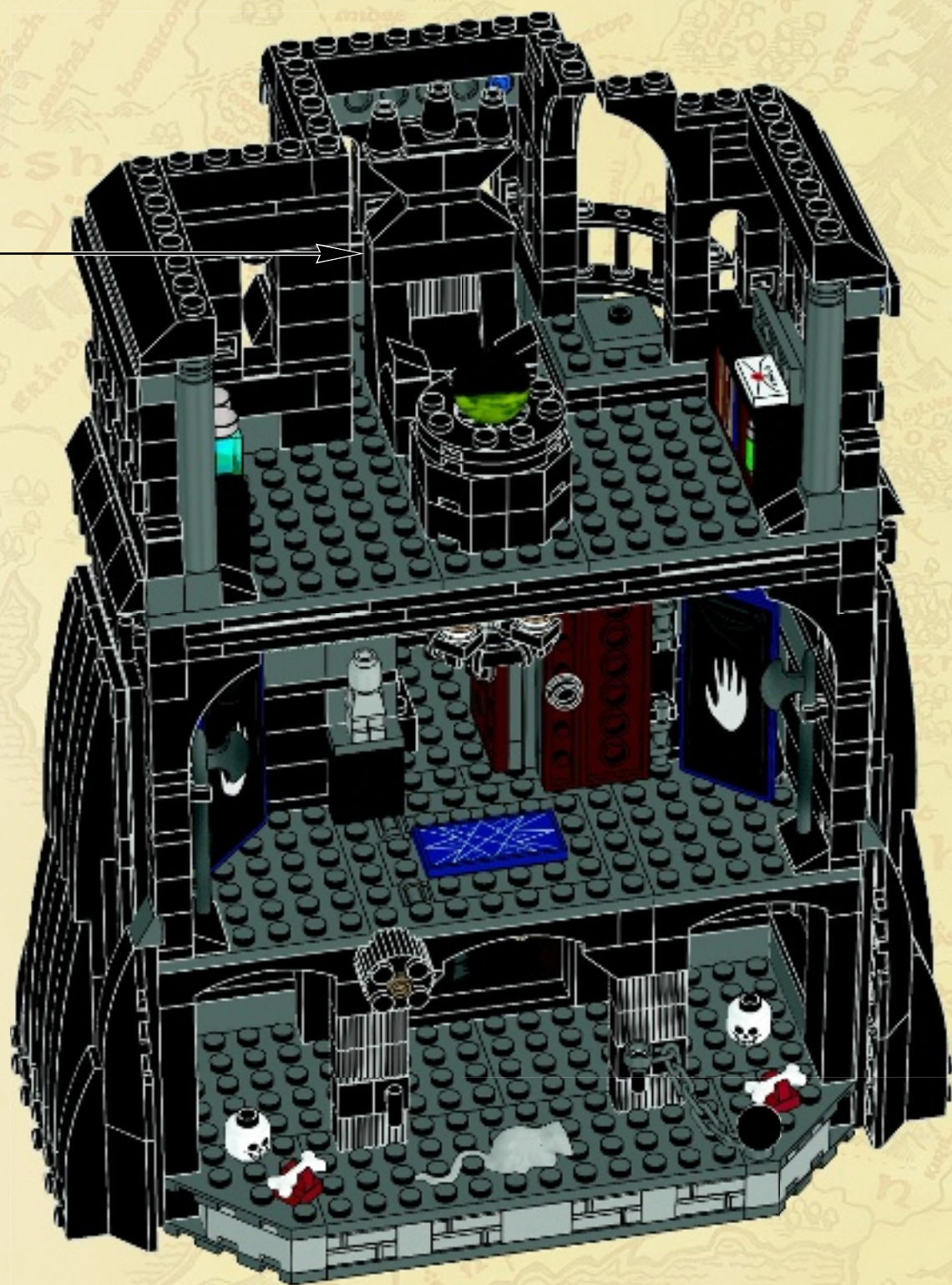

-  1x
-  1x
-  2x
-  1x

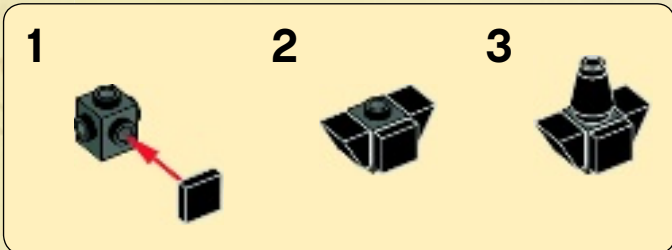

67

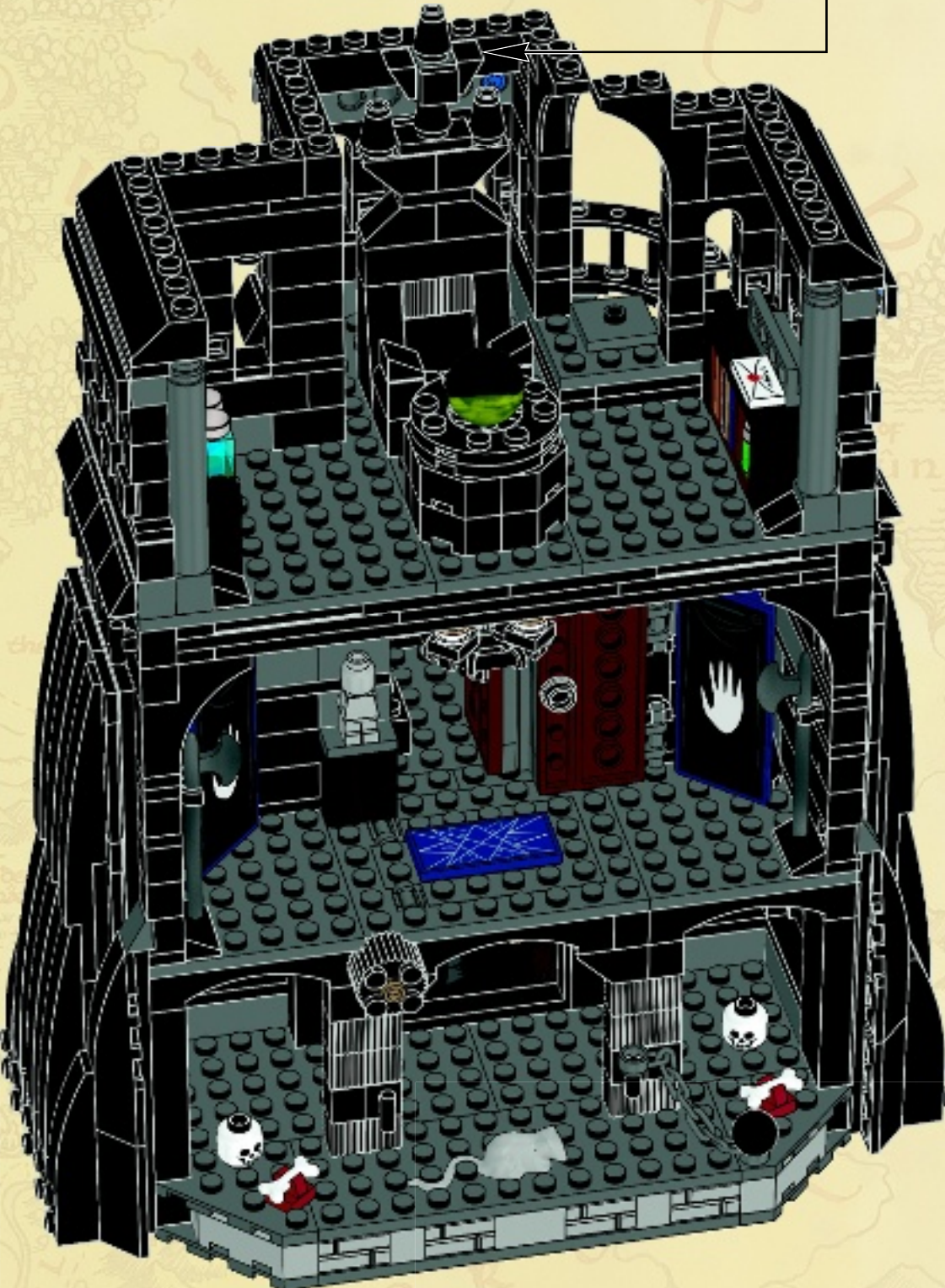

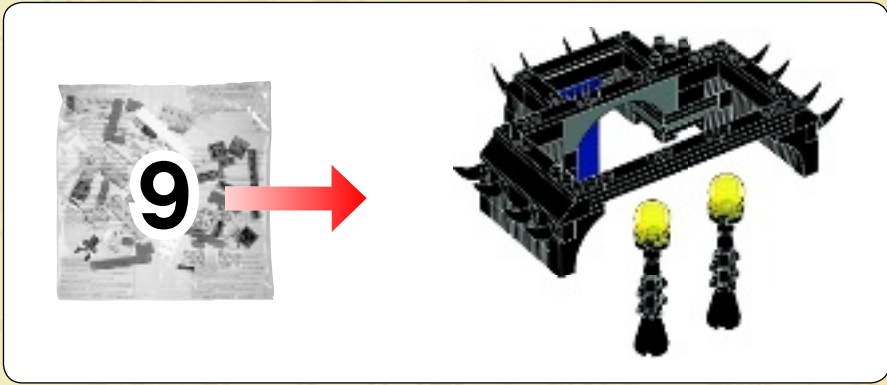

68

1



2



3



4



2x

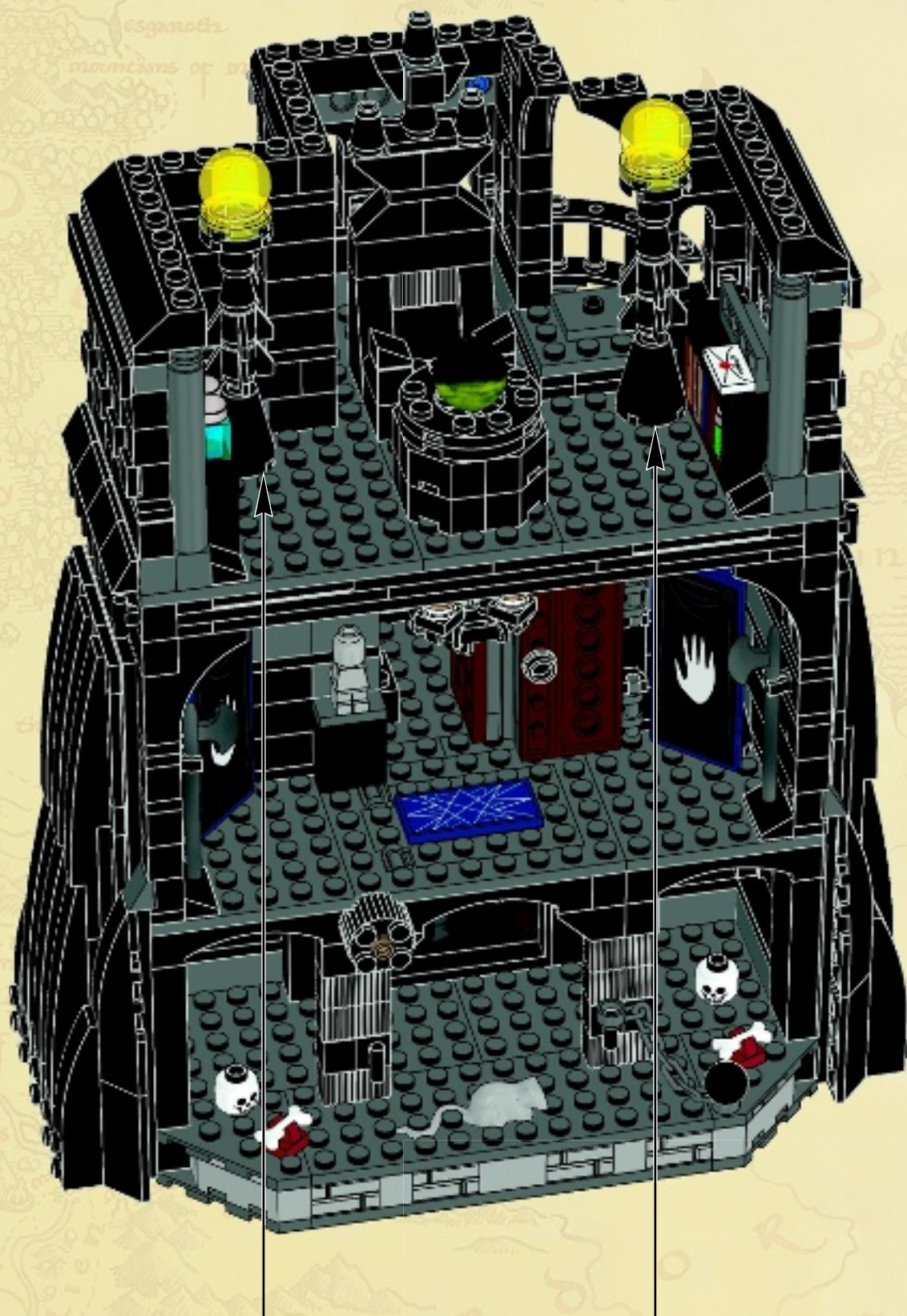



15x



5x

69

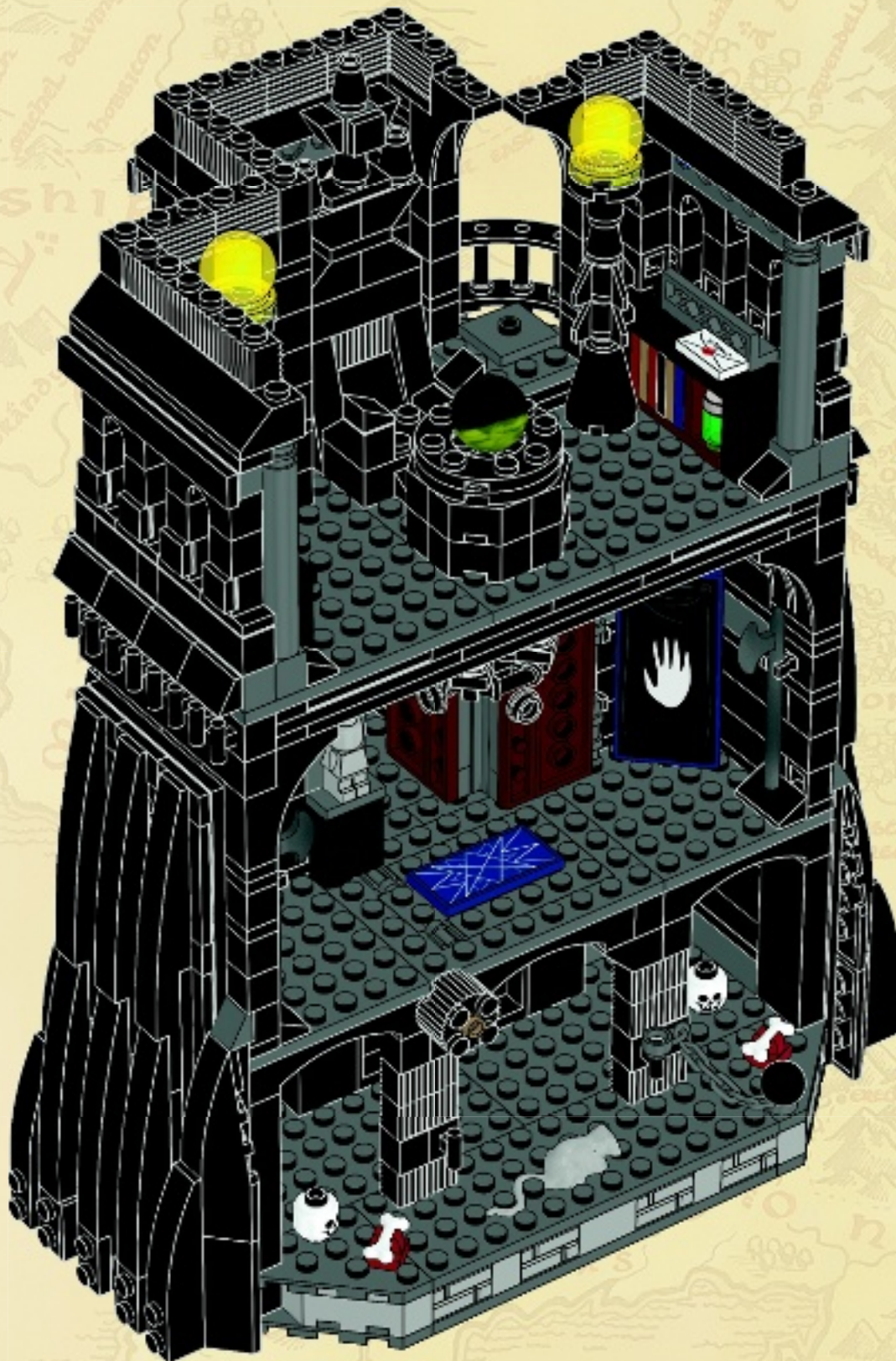



13x



2x



3x

70

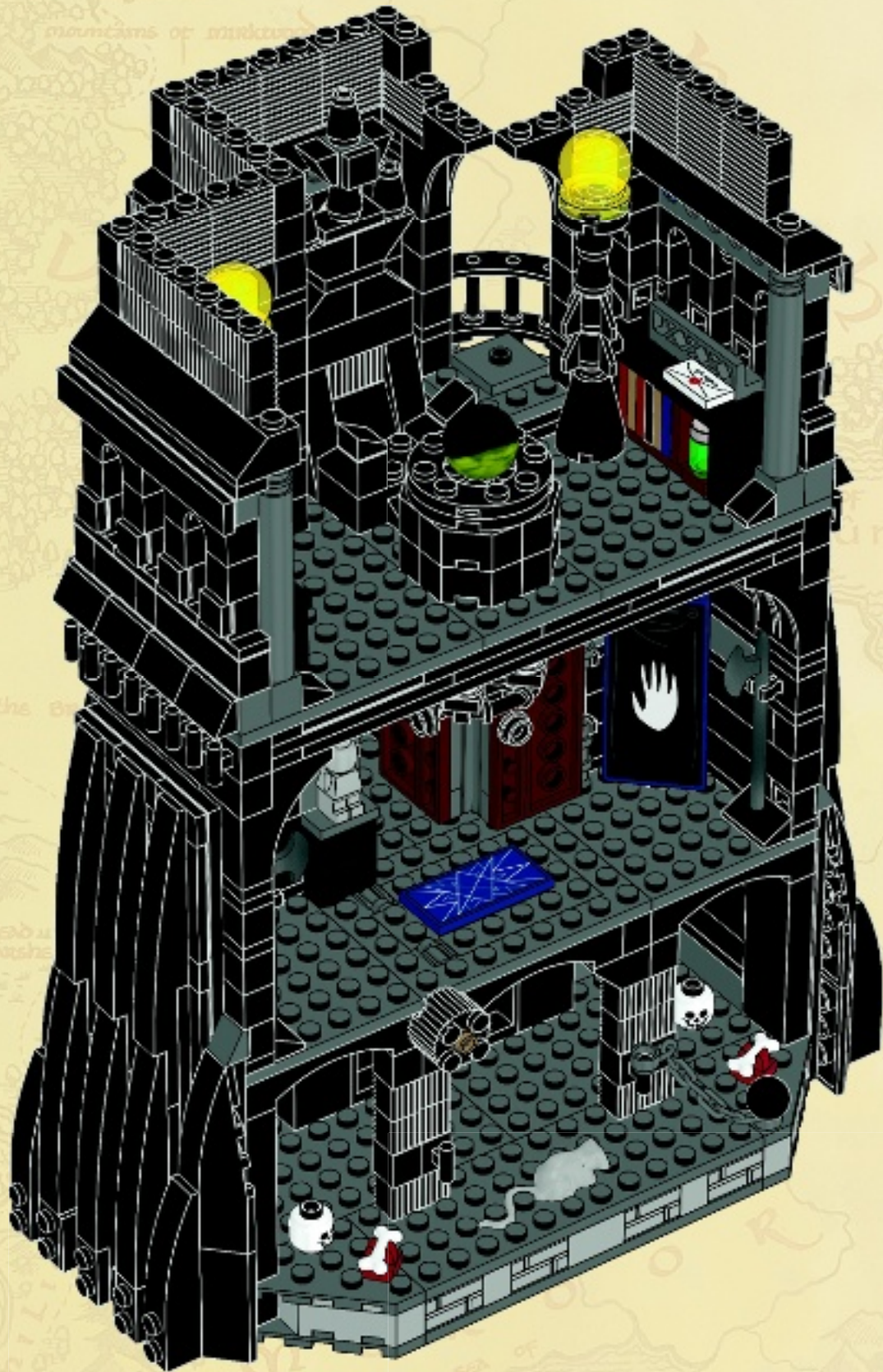

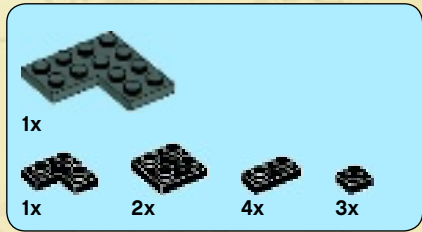

71

1



2



3

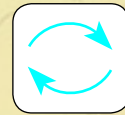

4



5



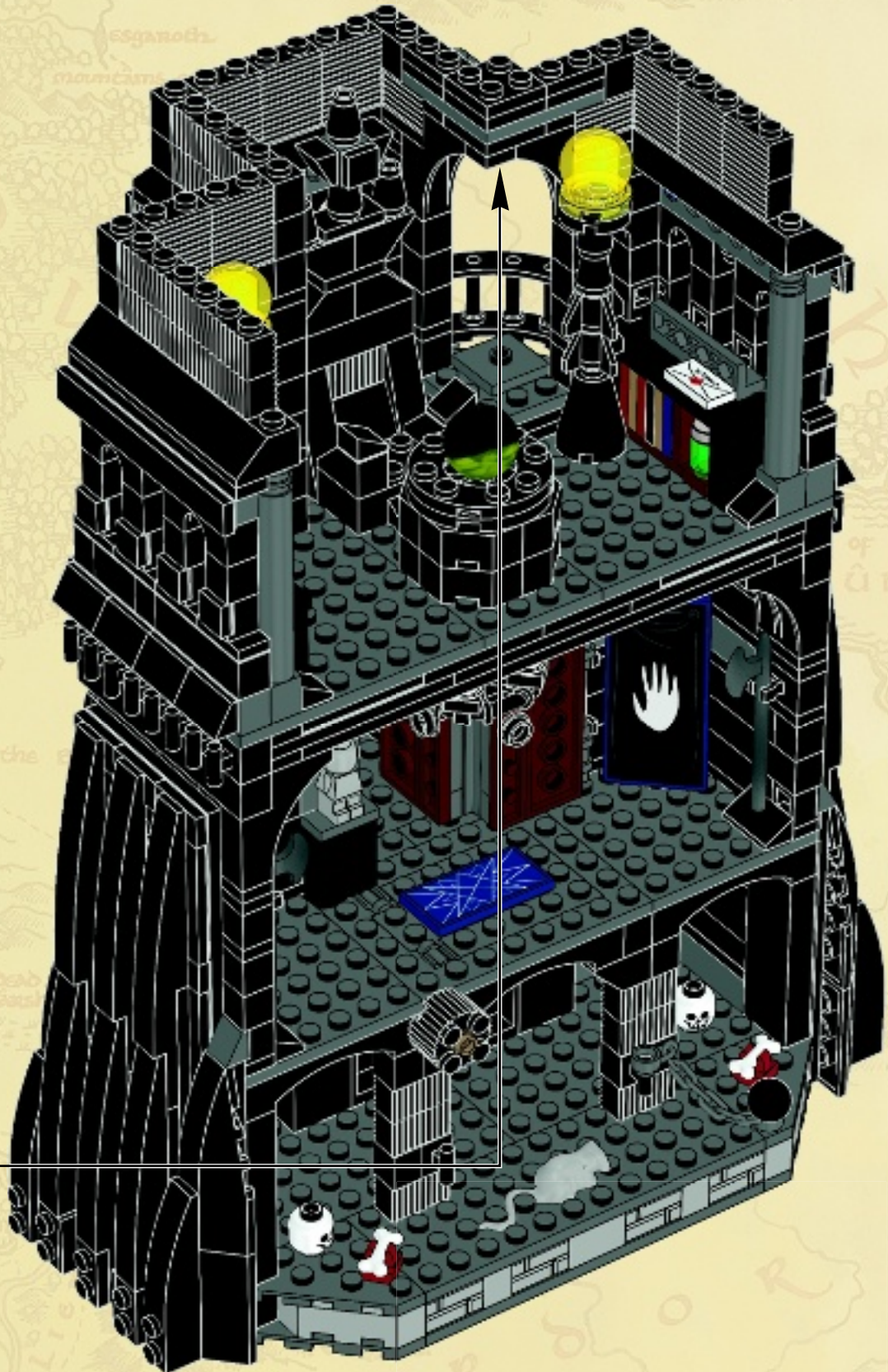

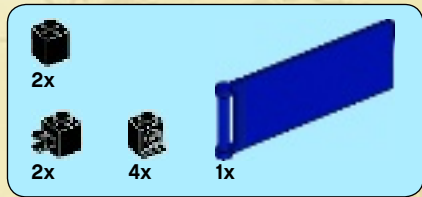

72

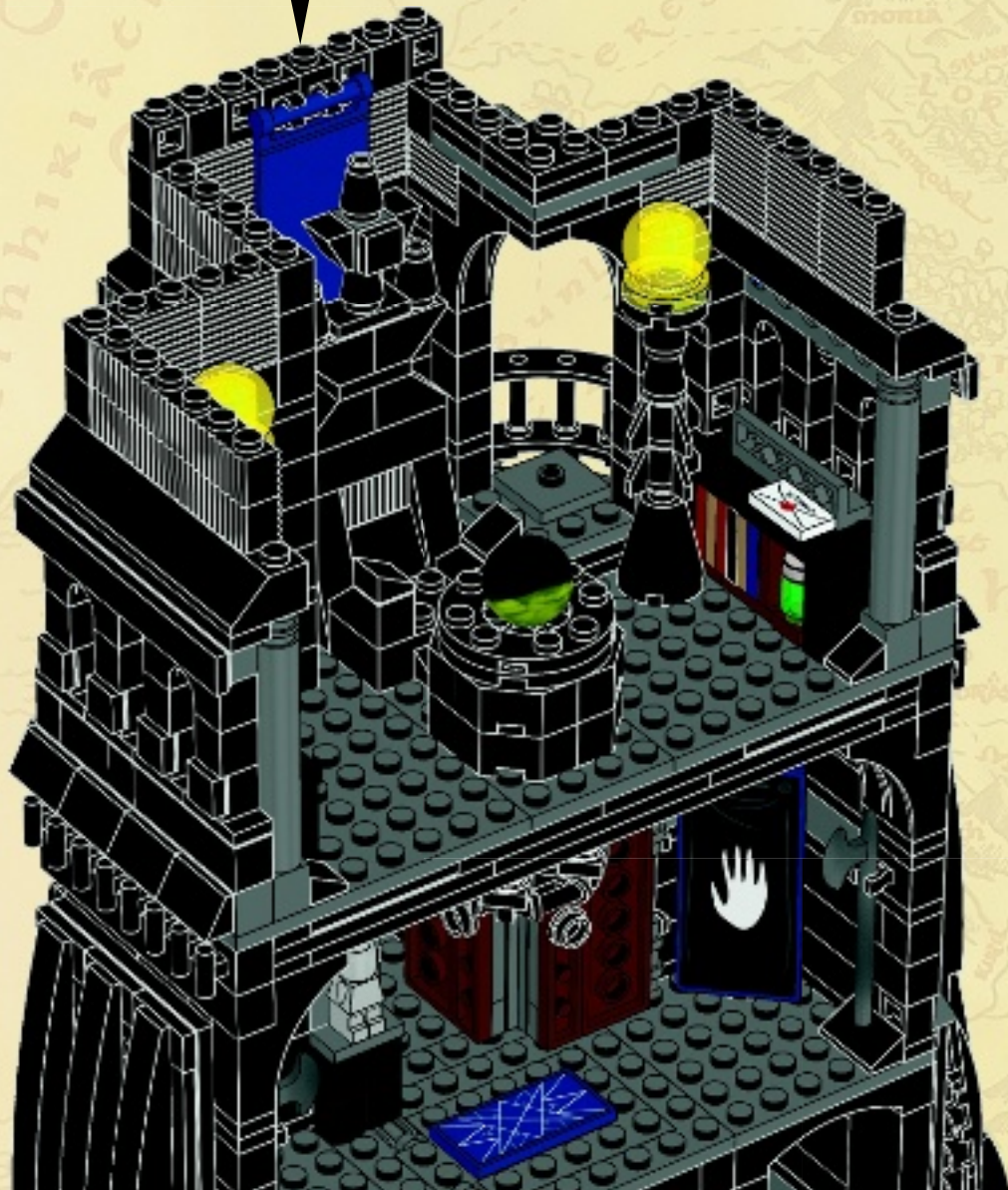
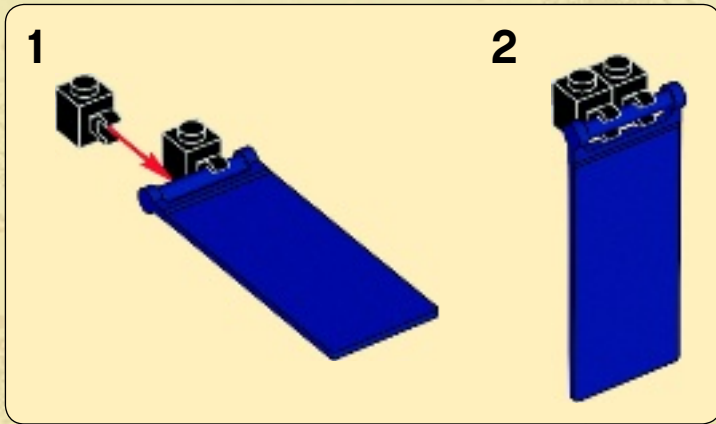

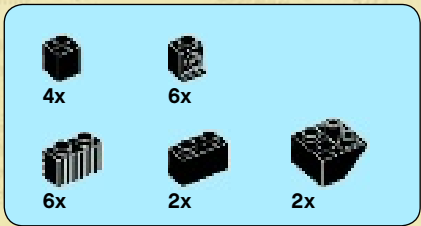

73

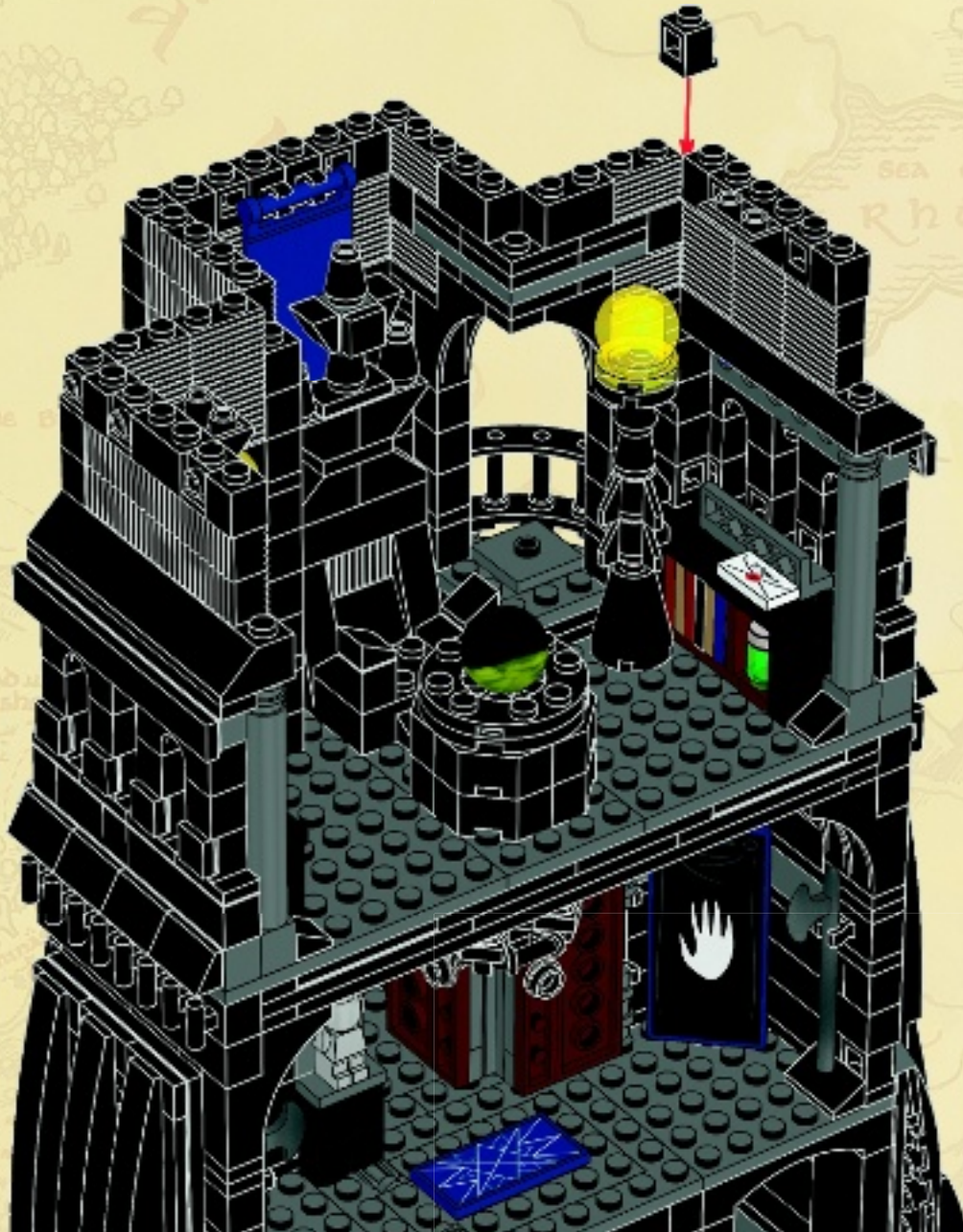

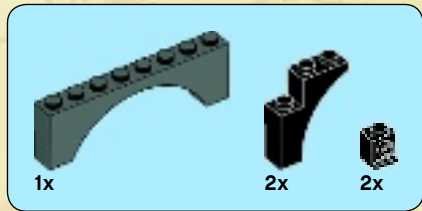

74

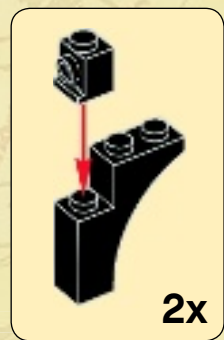

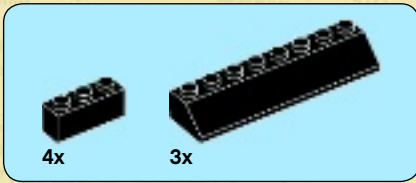

75



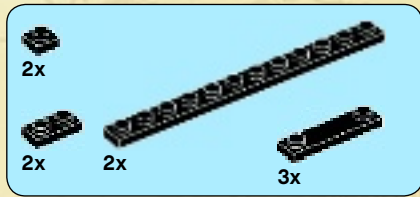

76

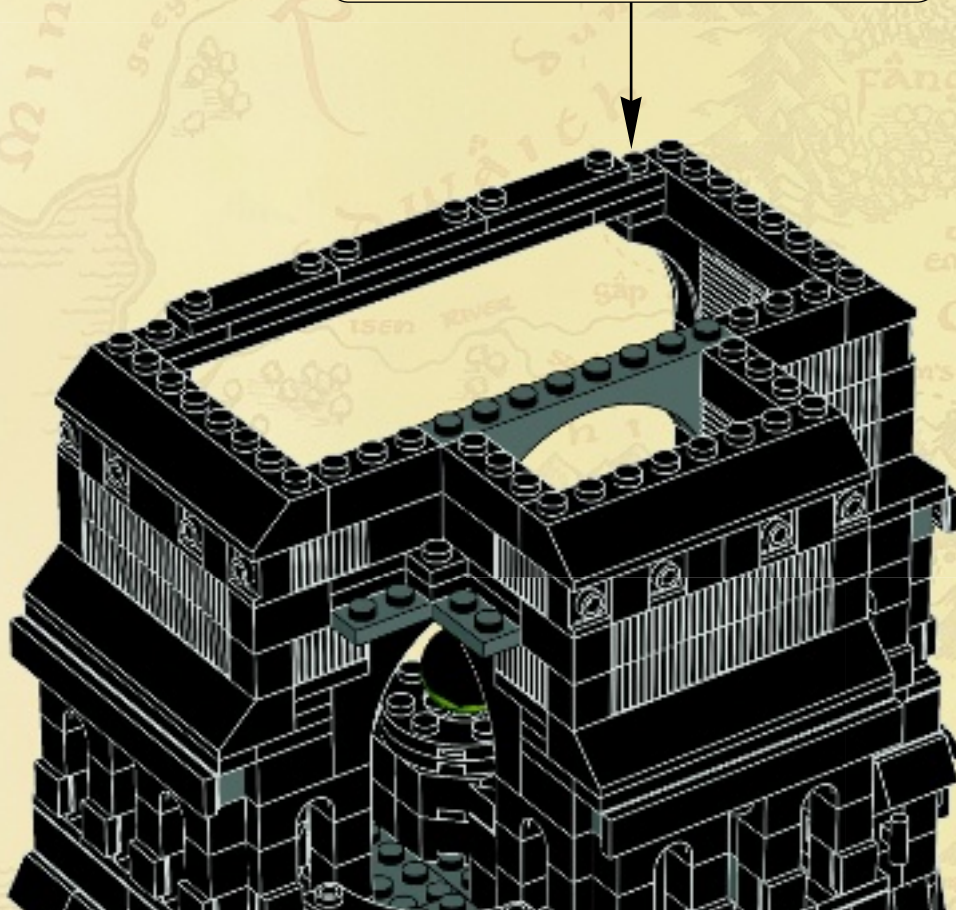
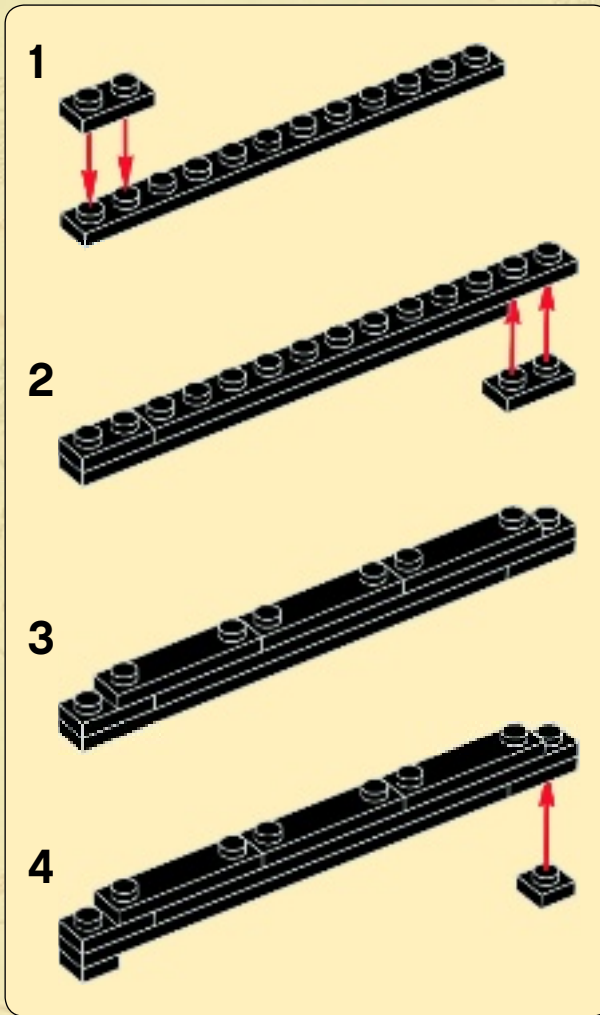



77



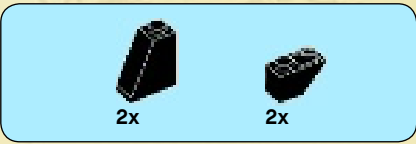

78





1x  3x  12x 

79

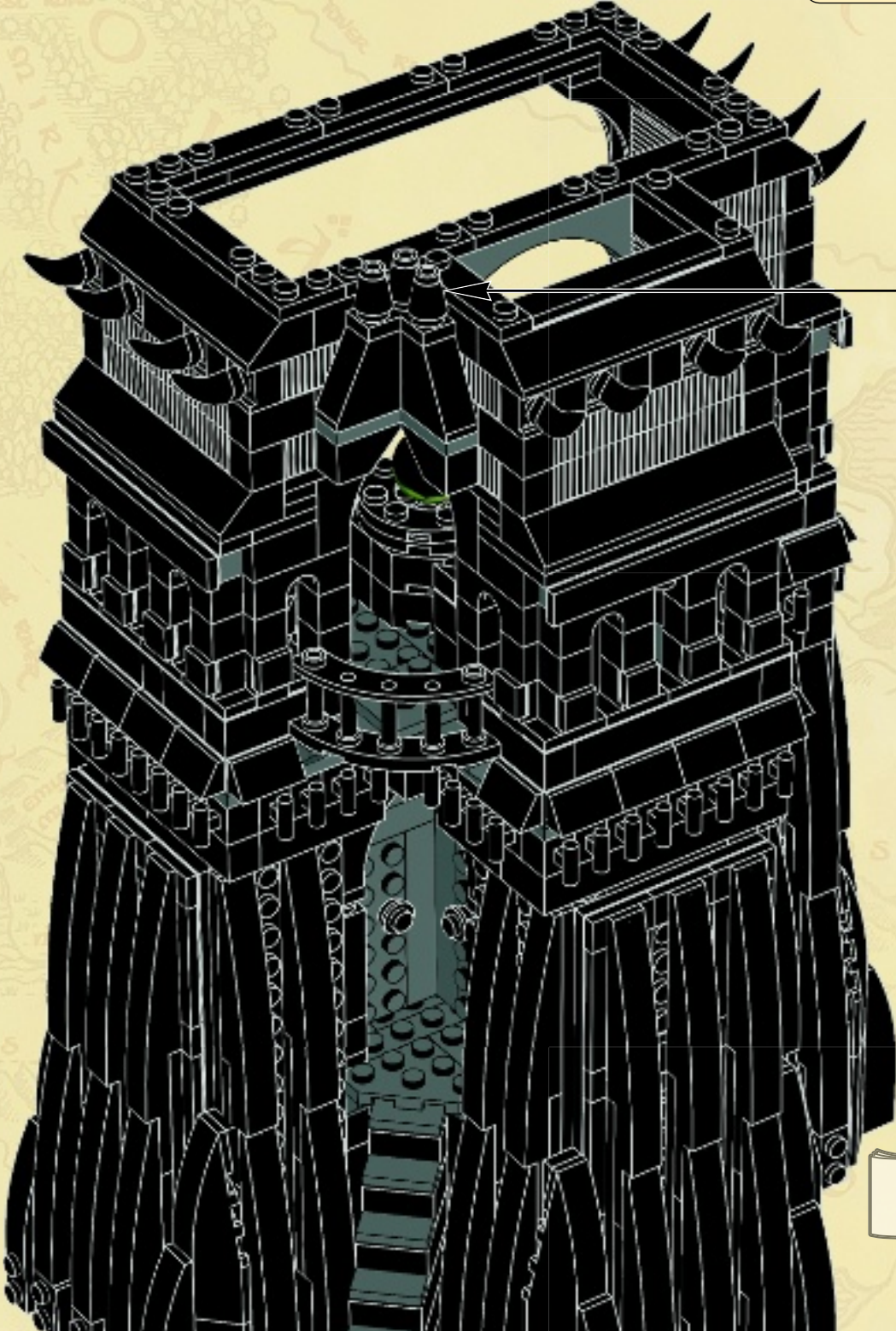
1  2 



 → 



WIN!

Go to www.LEGOsurvey.com/product to fill out a survey for a chance to win a cool LEGO® Product.

No purchase necessary.

Open to all residents where not prohibited.



www.LEGOsurvey.com/product

GEWINNE!

Nimm an der Umfrage auf www.LEGOsurvey.com/product teil und hab die Chance ein cooles LEGO® Produkt zu gewinnen!

Die Teilnahme am Gewinnspiel führt zu keinerlei Kaufverpflichtungen. Teilnahme in allen nicht ausgeschlossenen Ländern möglich.

WIN!

Ga naar www.LEGOsurvey.com/product, vul een enquêteformulier in en maak kans op een cool LEGO® product.

Geen aankoopverplichting. Iedereen mag deelnemen, uitgezonderd ingezetenden van landen waar een enquêteverbod geldt.

GAGNE!

Visite www.LEGOsurvey.com/product pour répondre à un questionnaire et avoir une chance de gagner un produit LEGO® très cool!

Aucune obligation d'achat. Ouvert à tous les résidents des pays autorisés.

当てよう!

www.LEGOsurvey.com/product にアクセスして、アンケートにご記入ください。当選者にはレゴ製品を差し上げます。

お買い上げの必要はありません。禁止されていない限り、すべての皆様にご利用いただけます。