



# THE LORD OF THE RINGS

10237





5

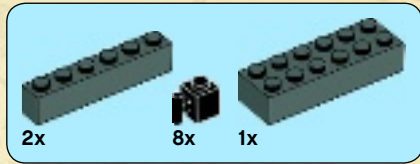

2x

8x

1x

32





32x



2x

33

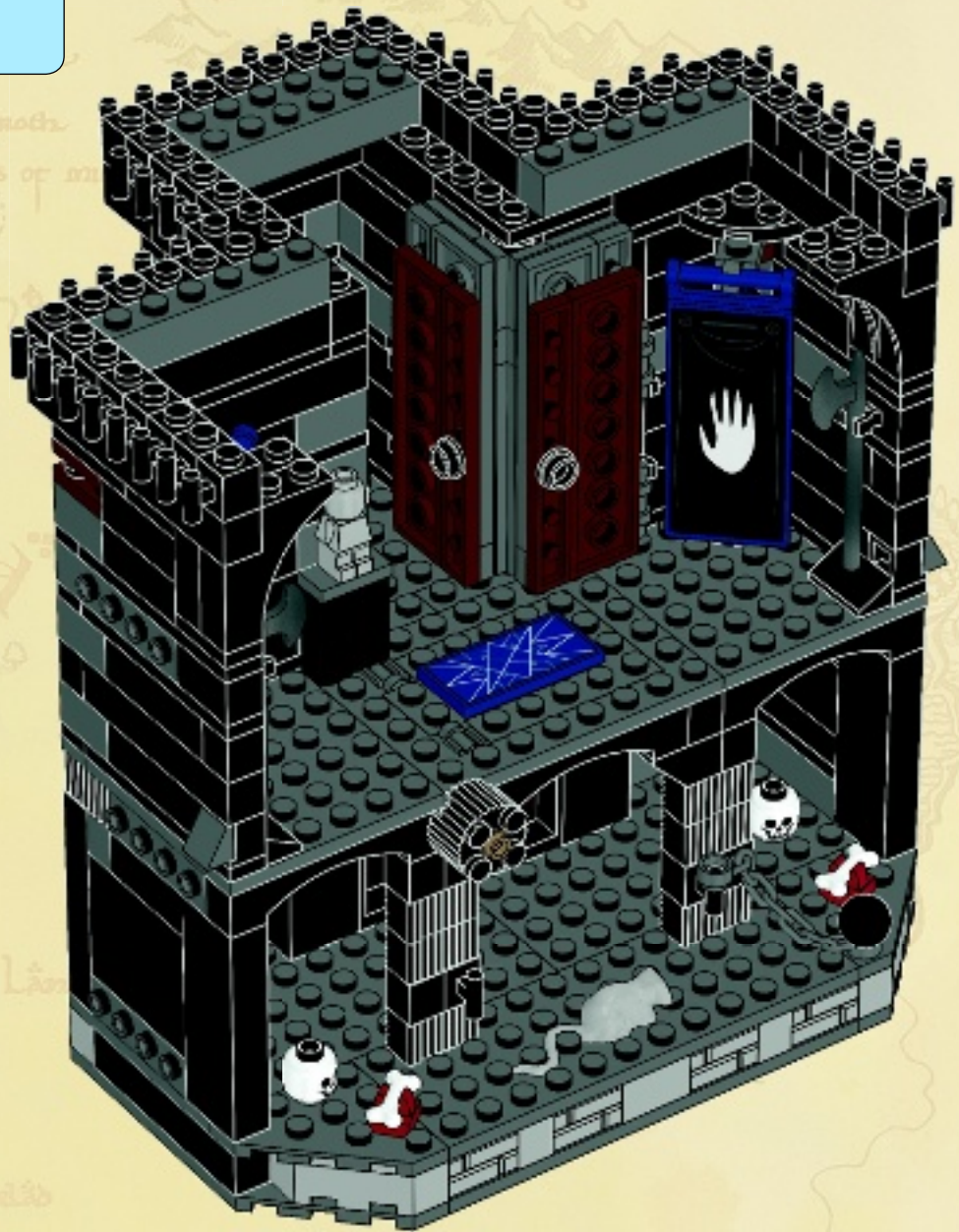

THE LORD OF THE RINGS



LE SEIGNEUR DES ANNEAUX



EL SEÑOR DE LOS ANILLOS

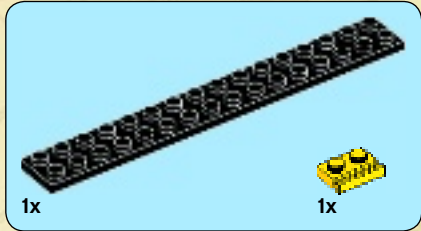

1

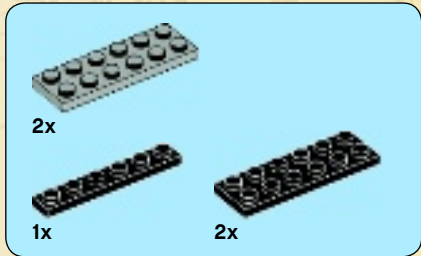
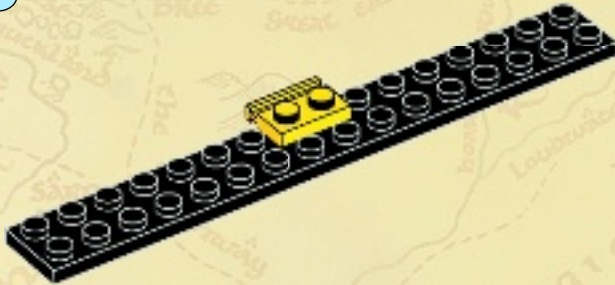

2

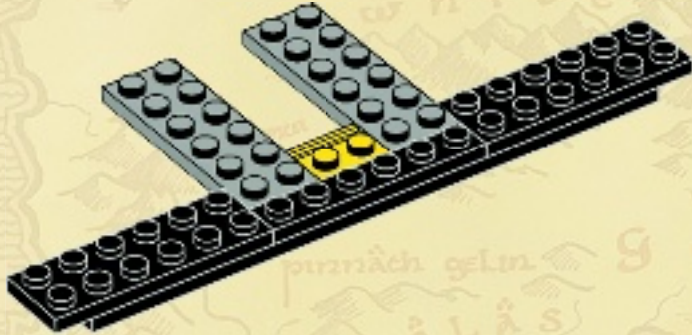

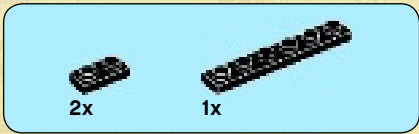

3

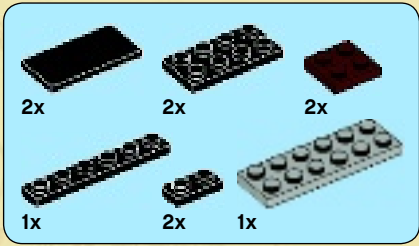
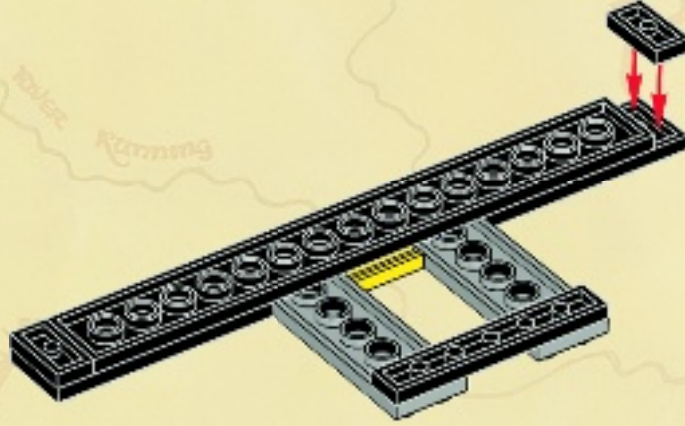

4

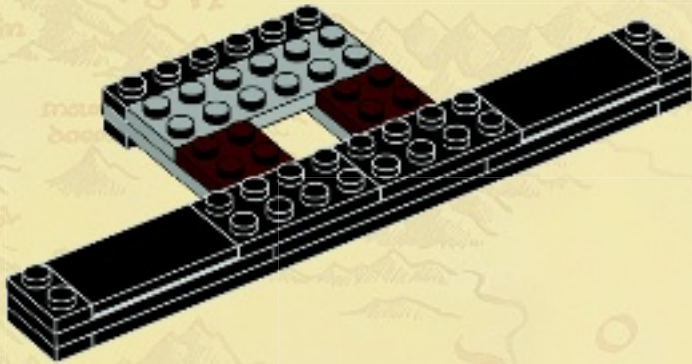



5

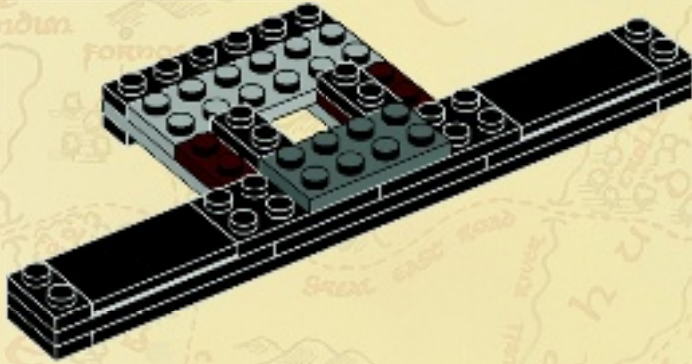

34

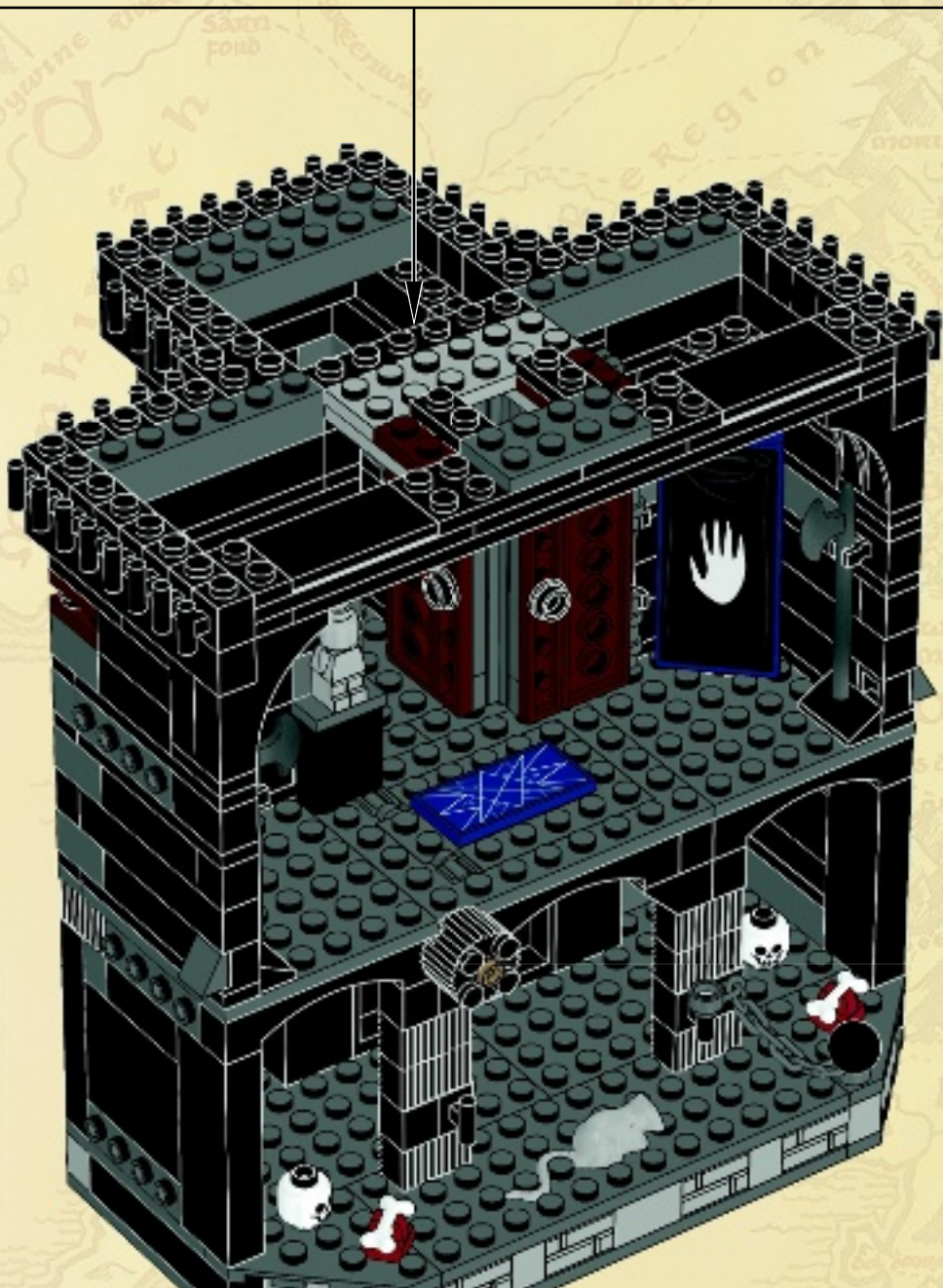

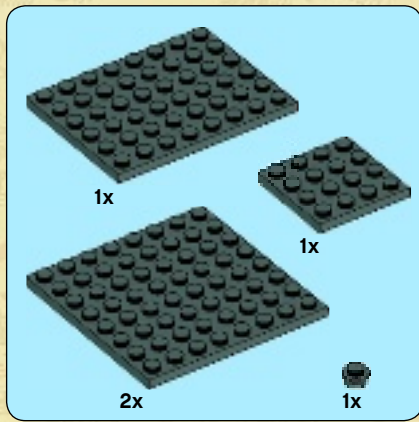

35

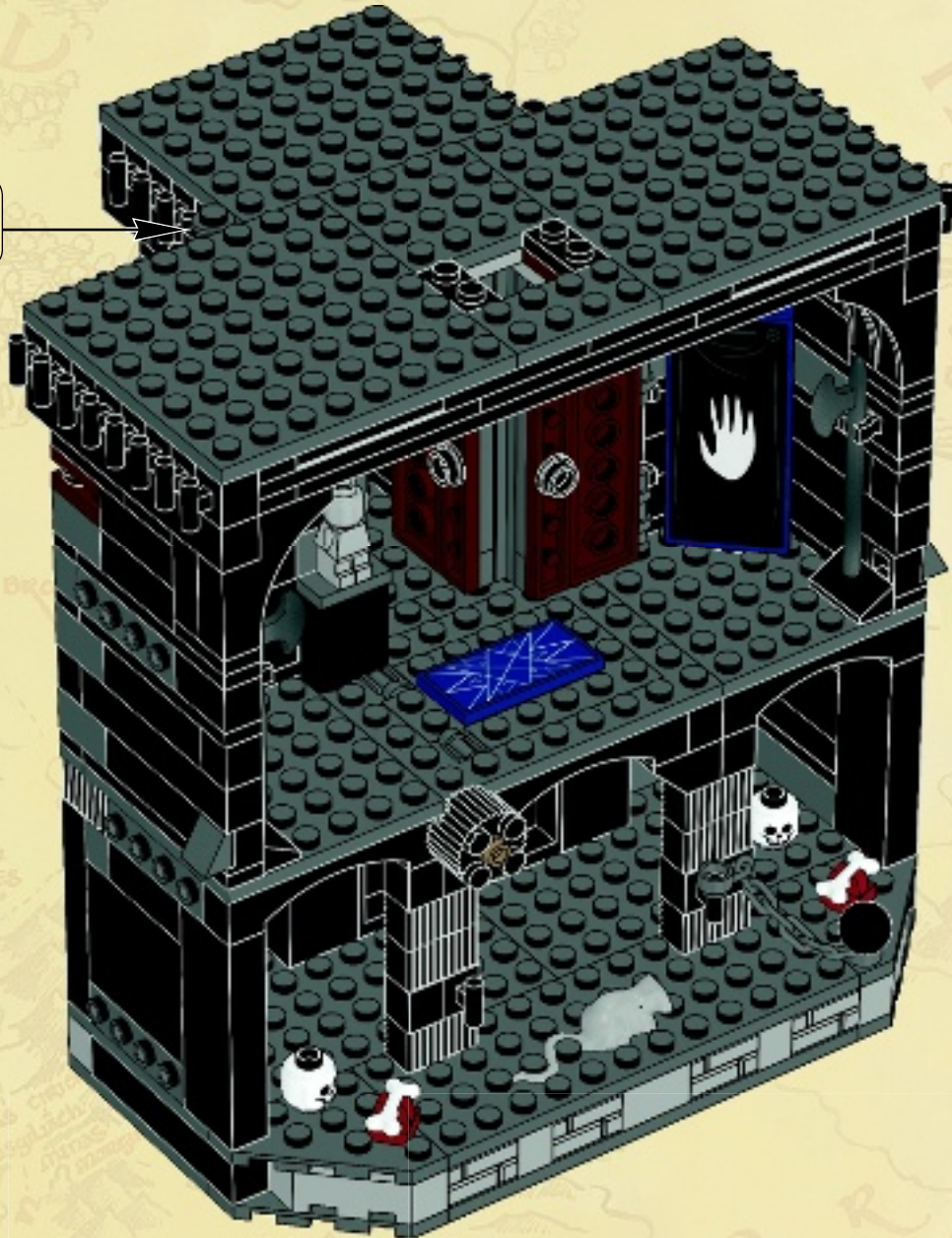

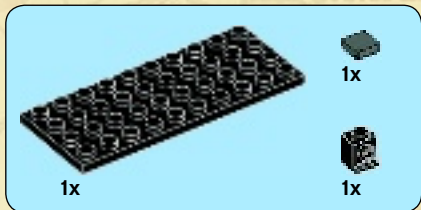
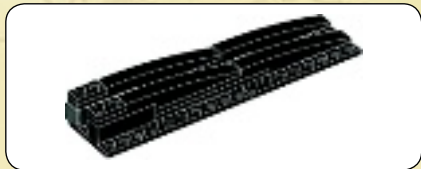

1

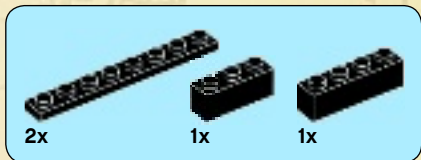
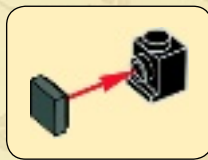

2

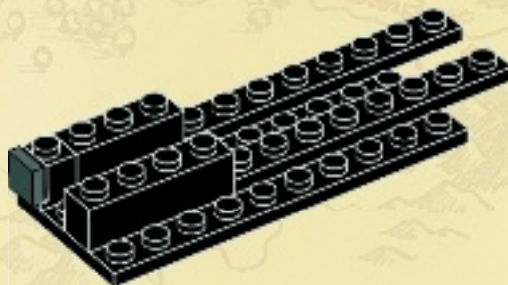



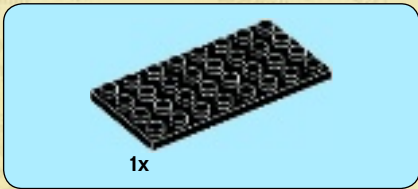

3

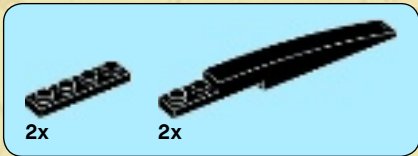

4

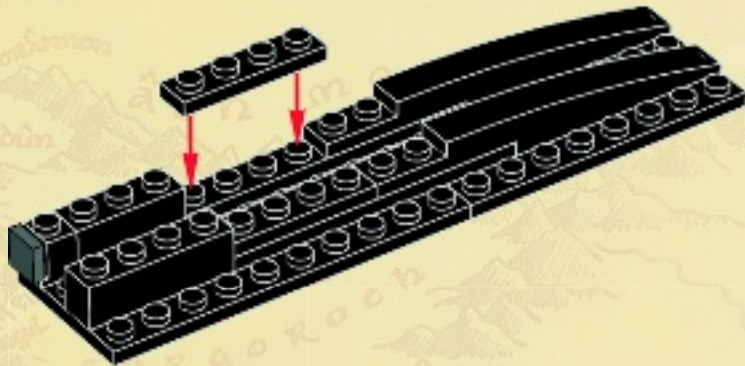

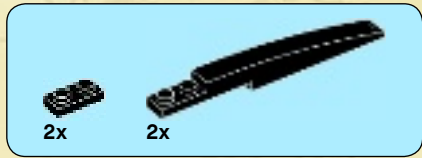

5

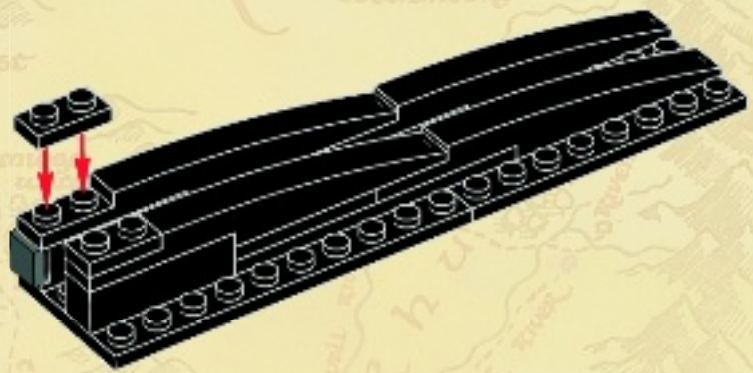

36

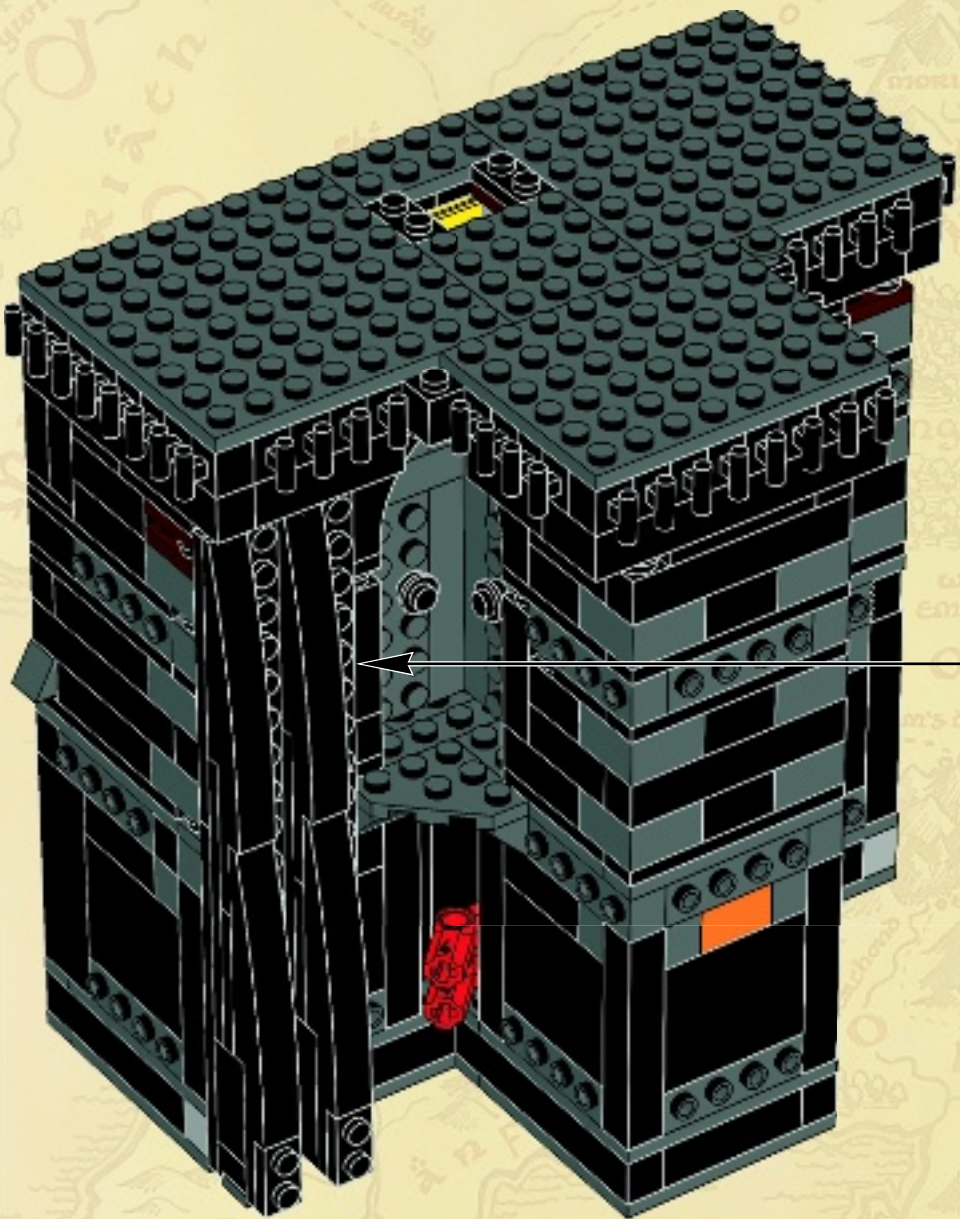

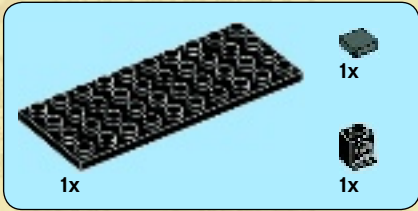

1

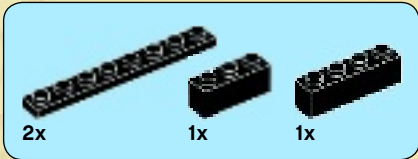
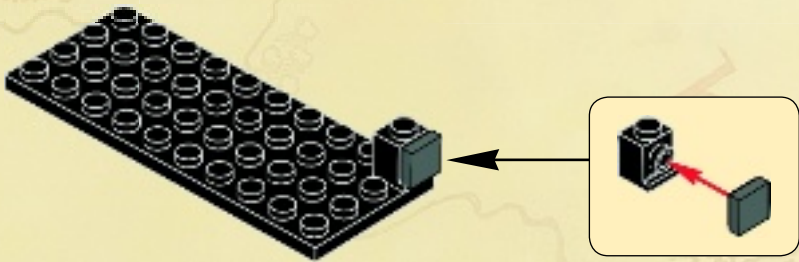

2

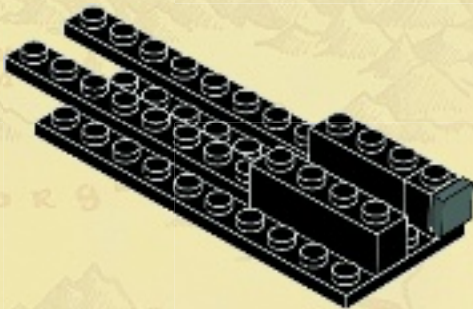

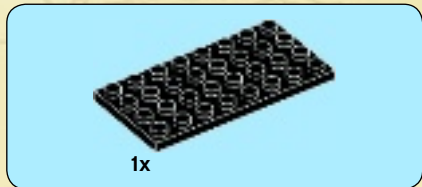

3

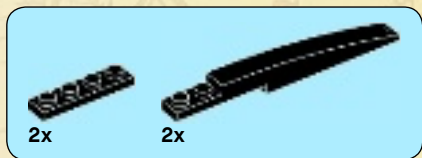
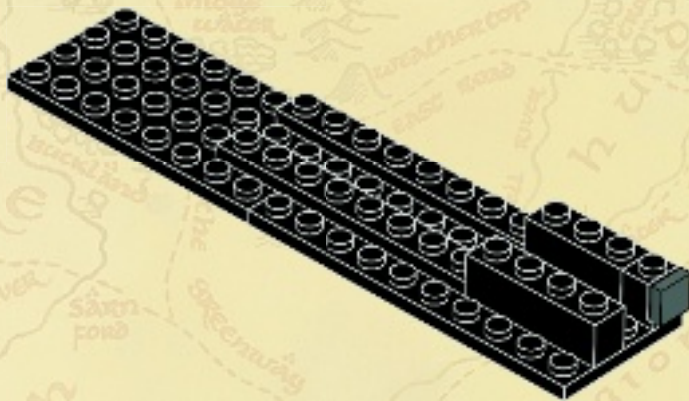

4

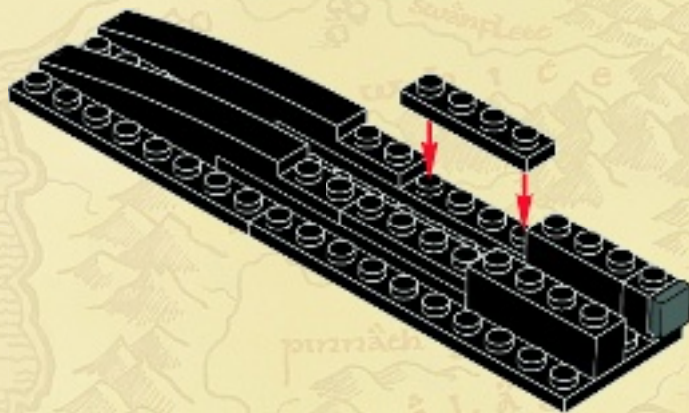

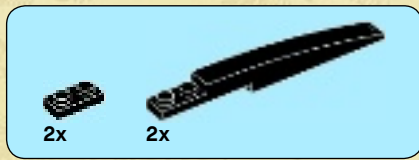

5

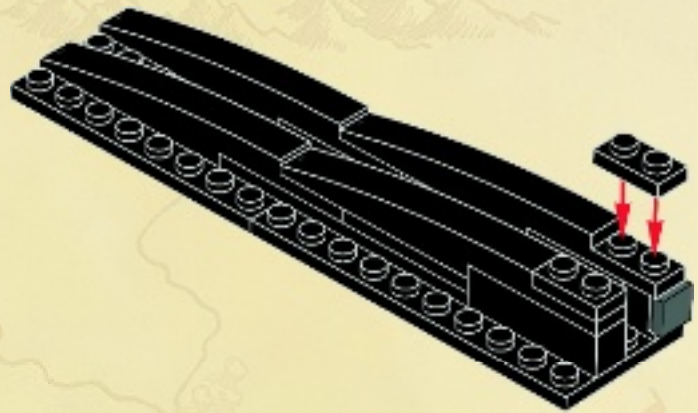

37

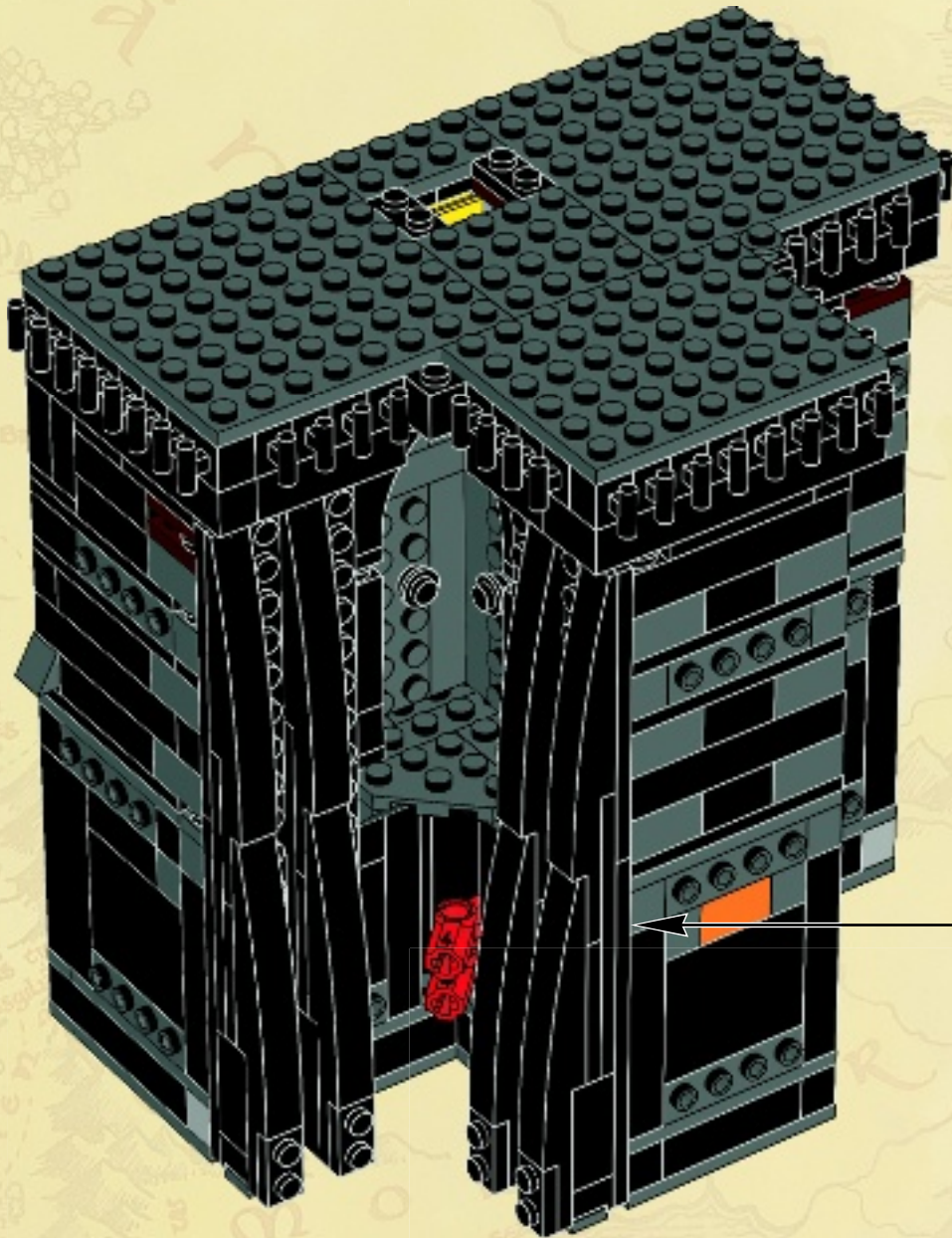

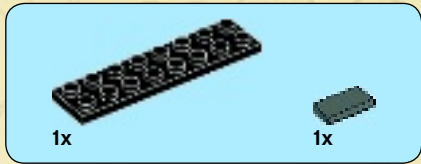

1



2



3

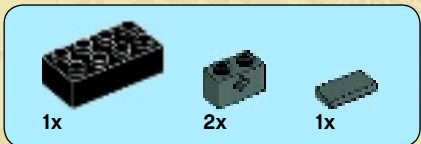

4

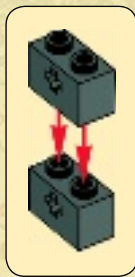

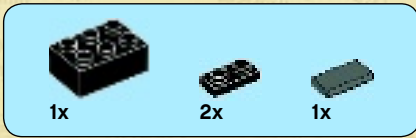

5



7

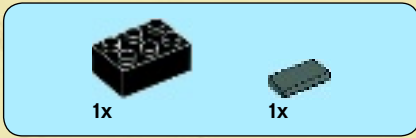

6

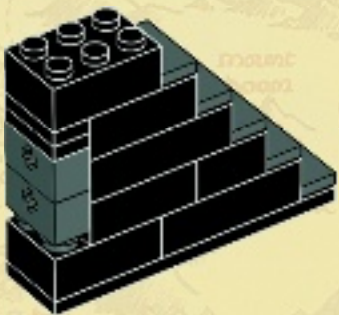

8

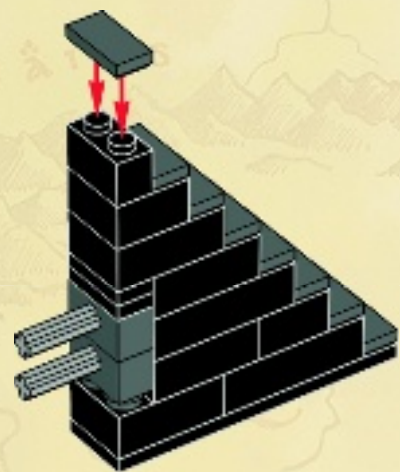

38

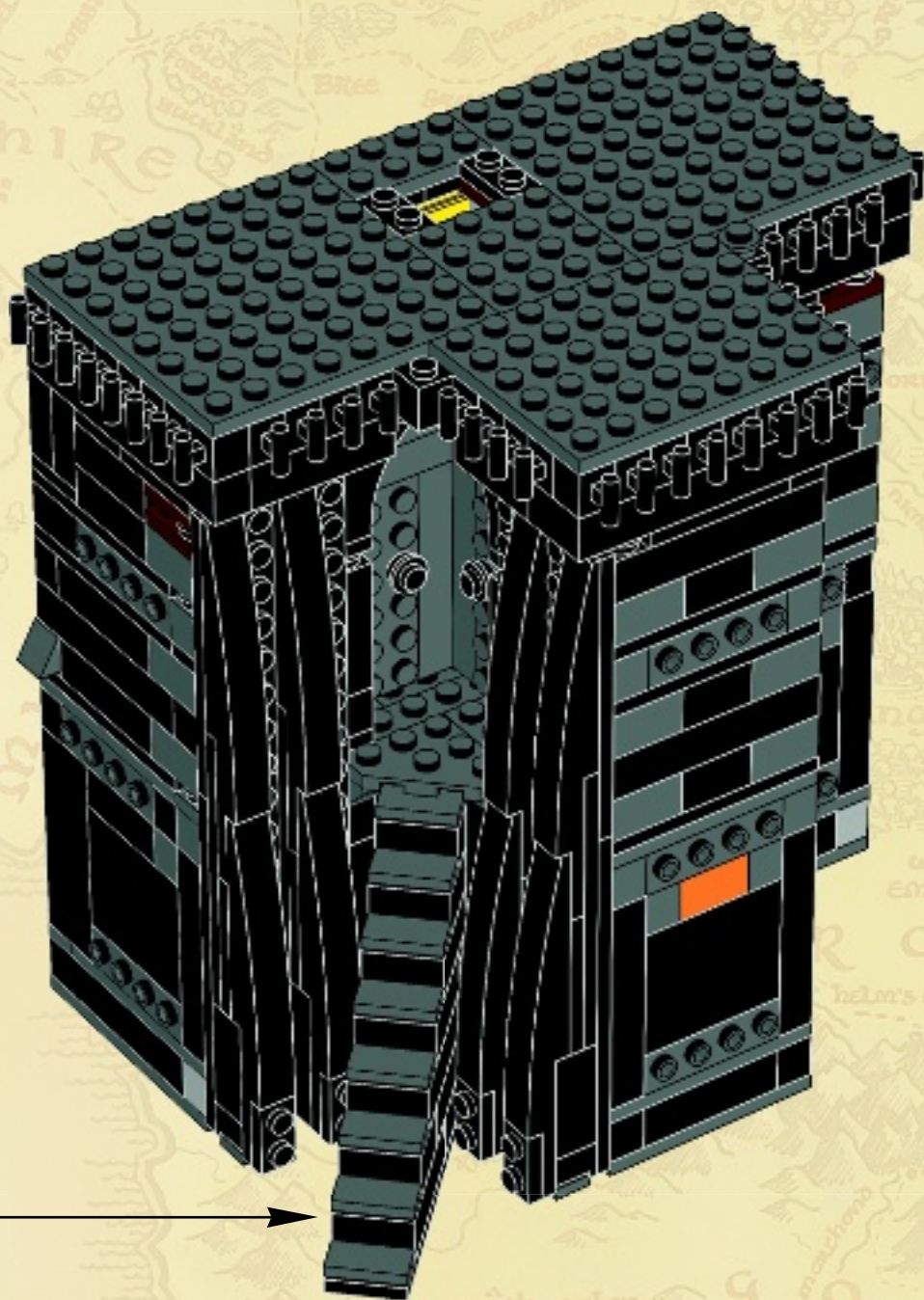



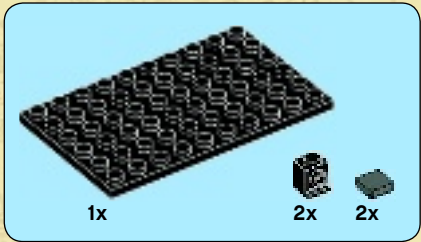
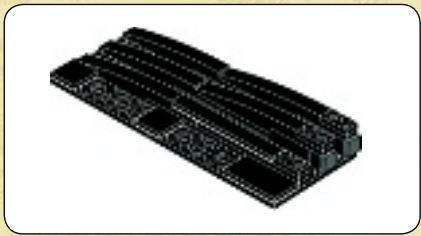

1

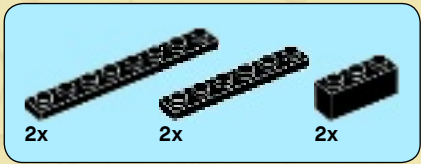
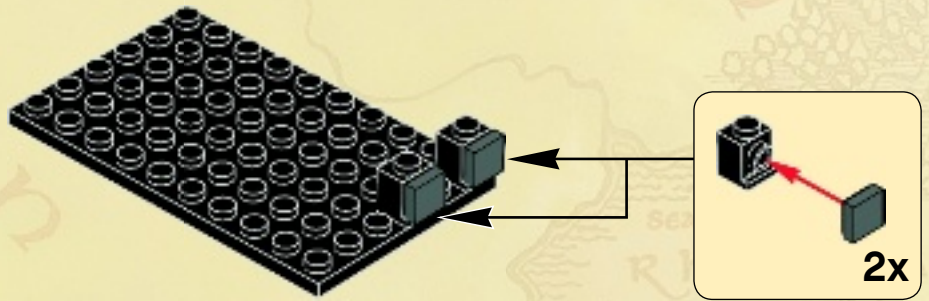

2

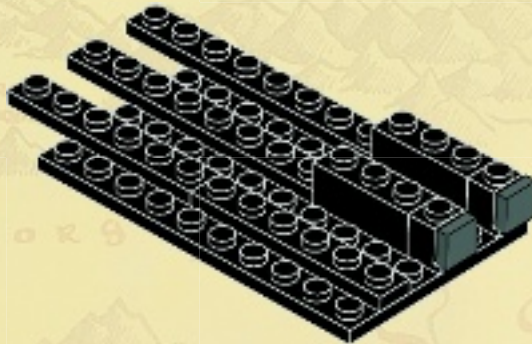

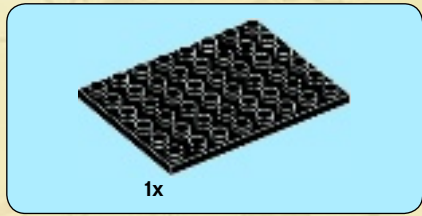

3

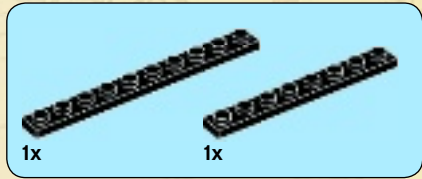
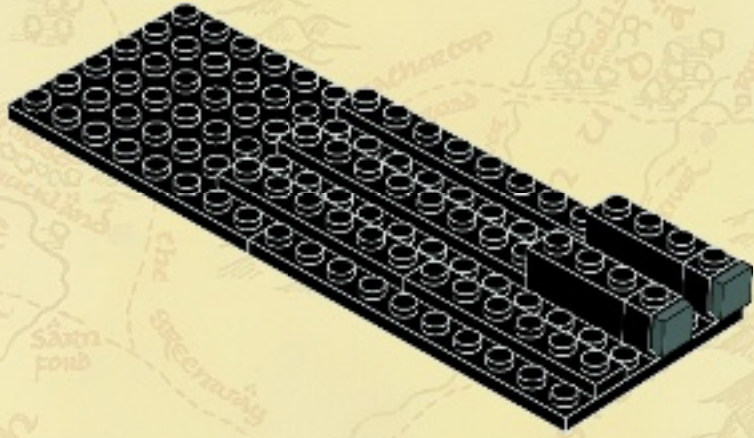

4

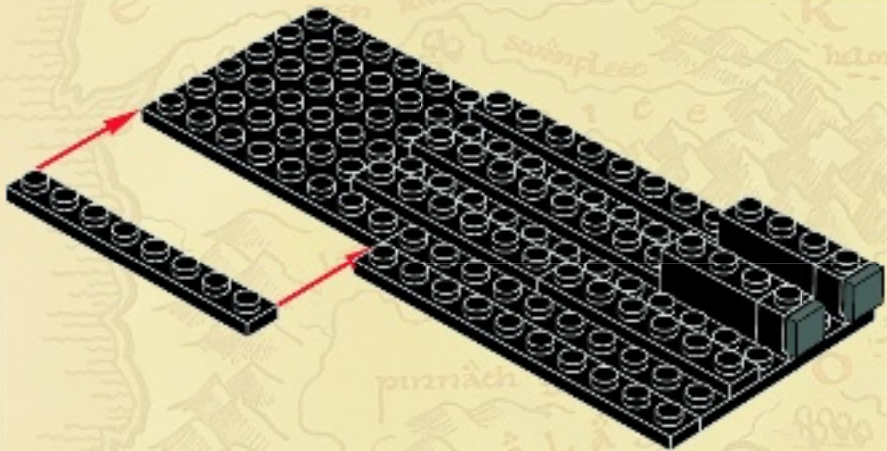

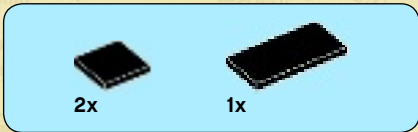

5

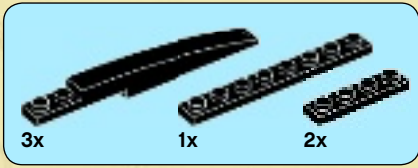
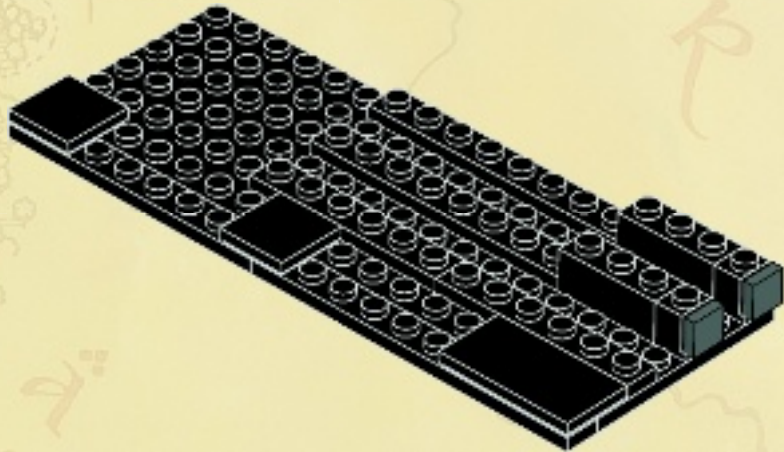

6

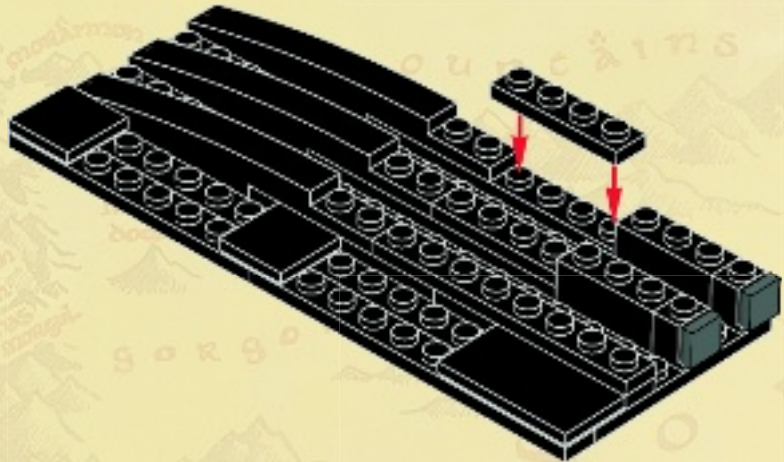

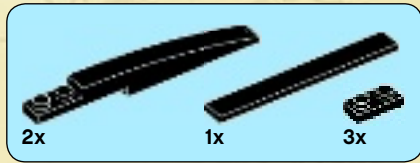

7

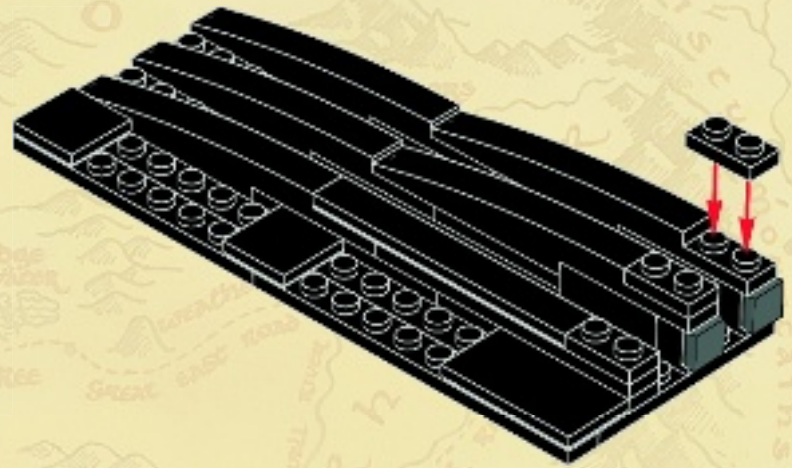

39

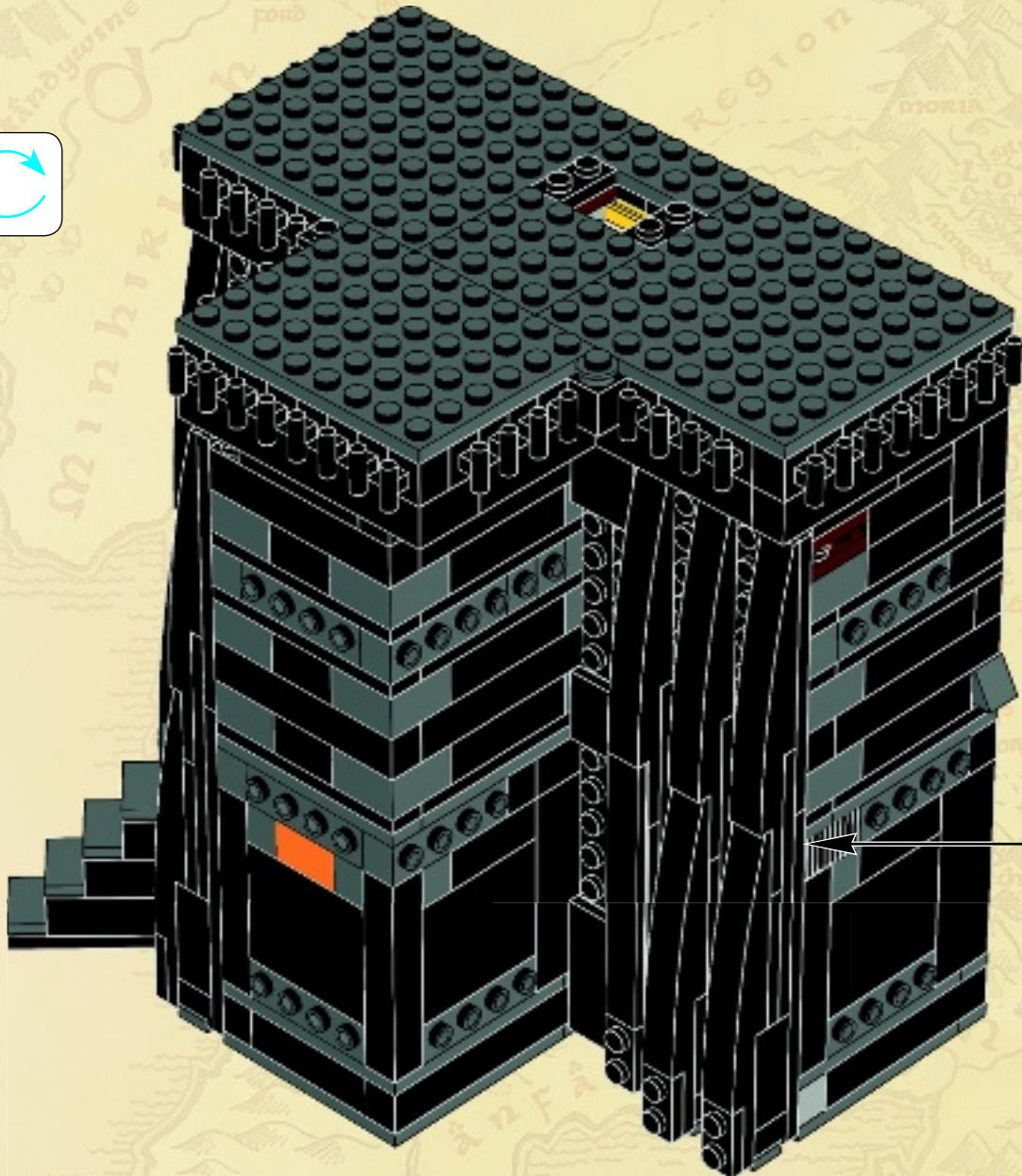

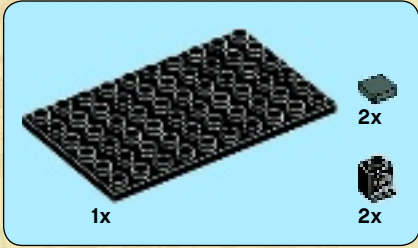

2x

2x

1

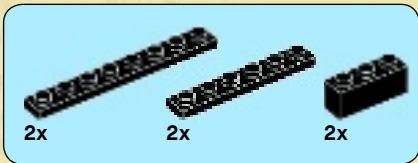
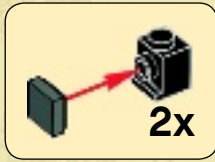

2

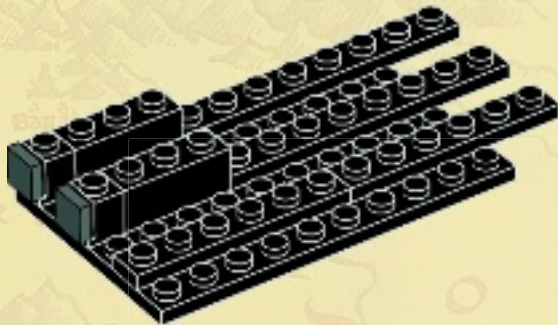

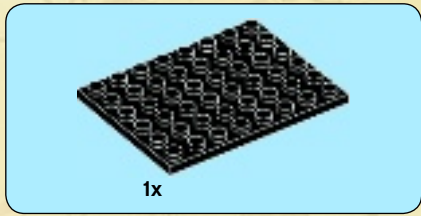

3

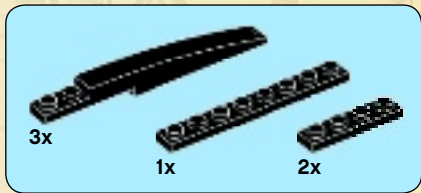
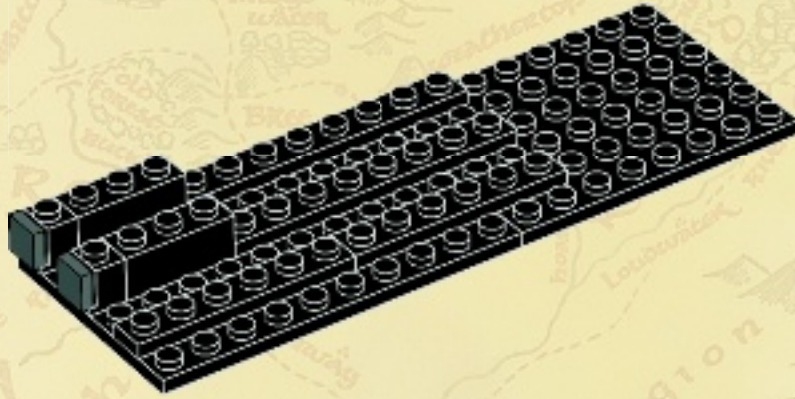

4

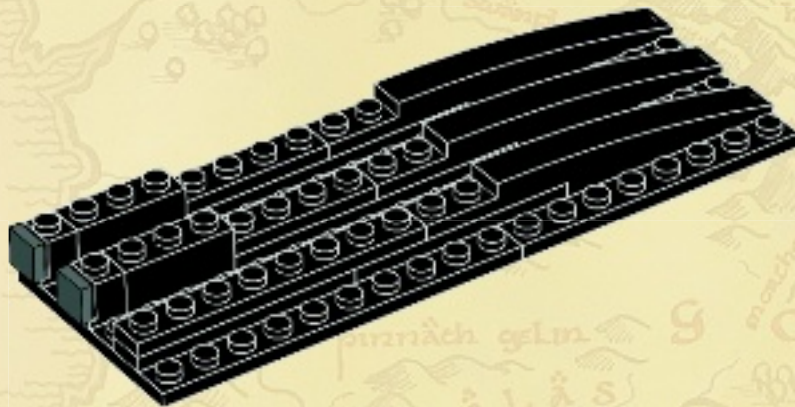

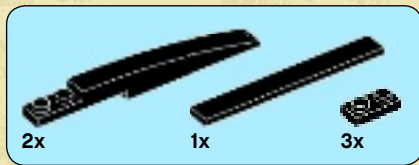

5

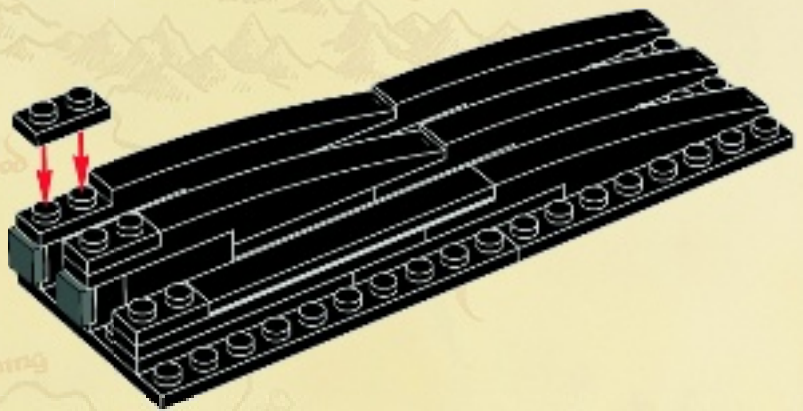

40

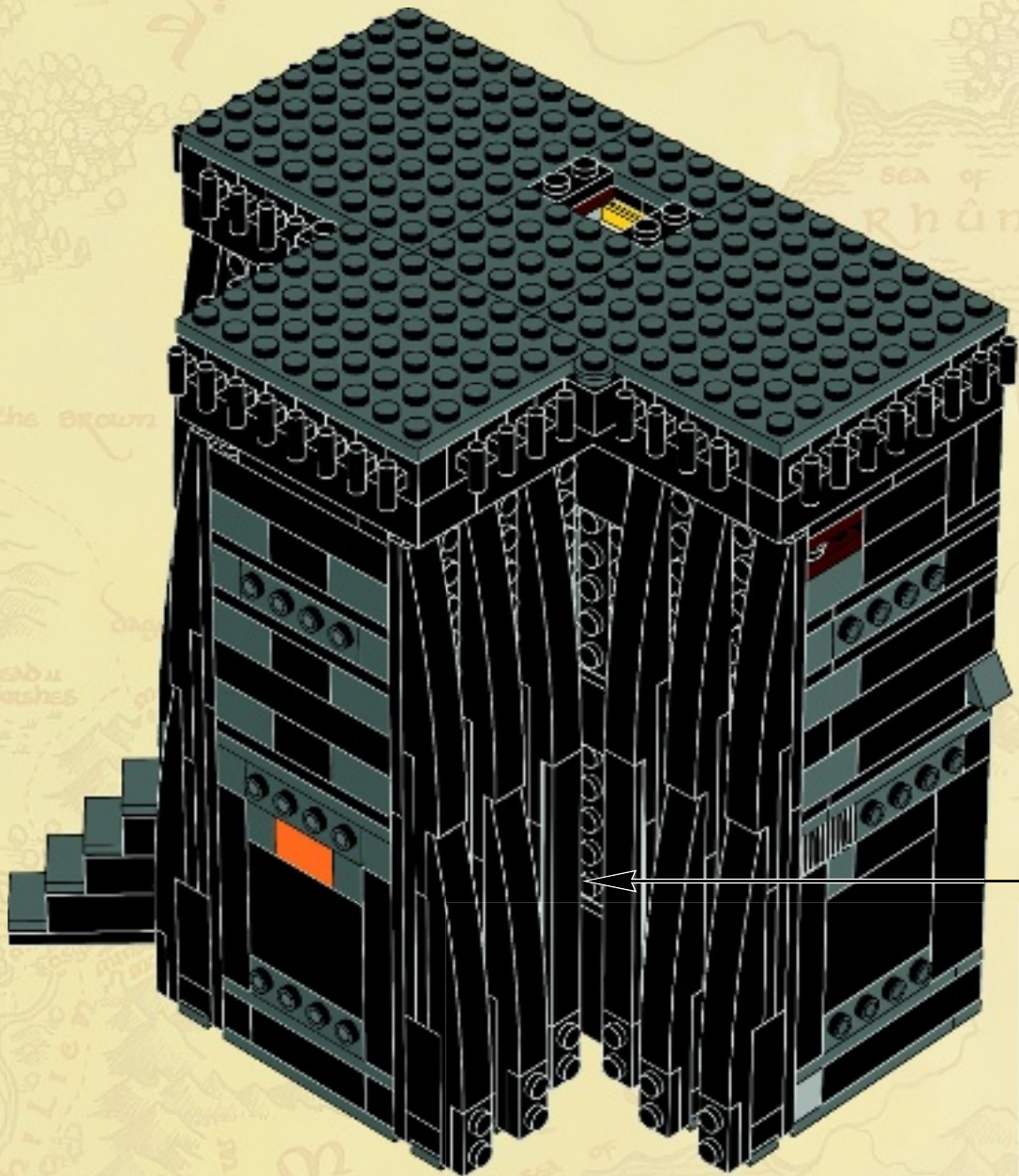

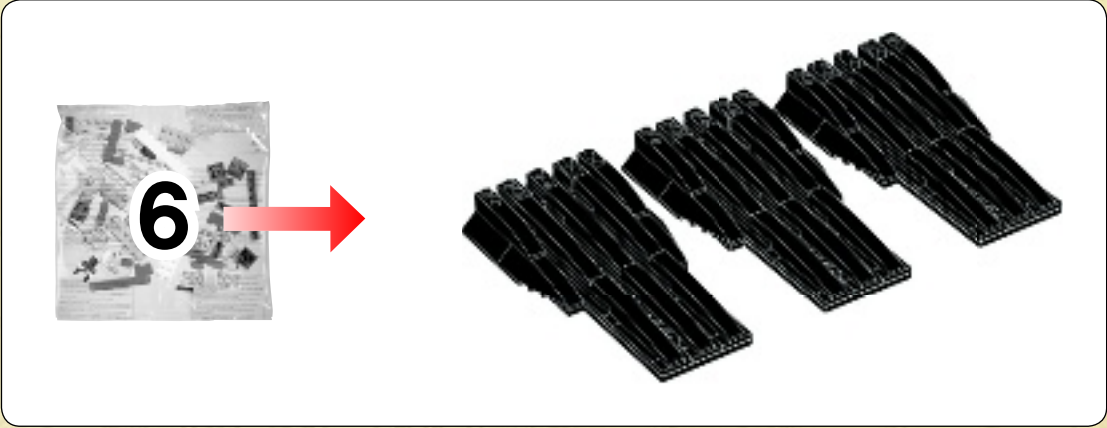

1

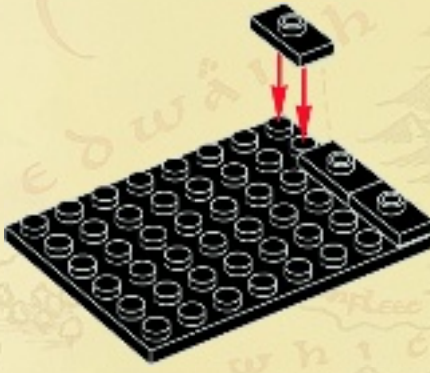



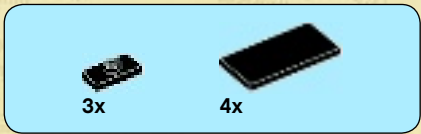

2

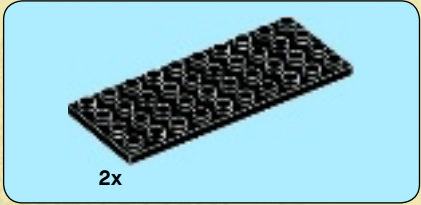
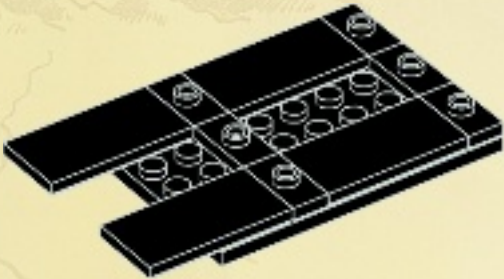

3

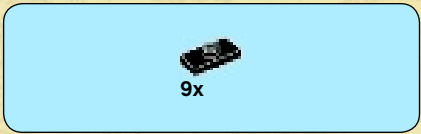
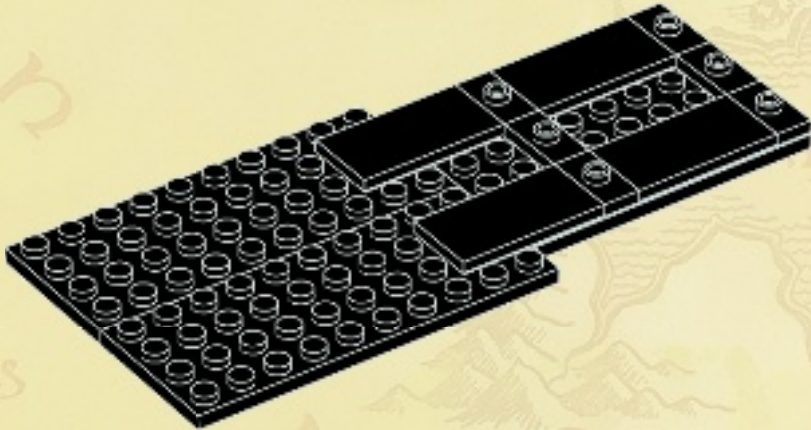

4

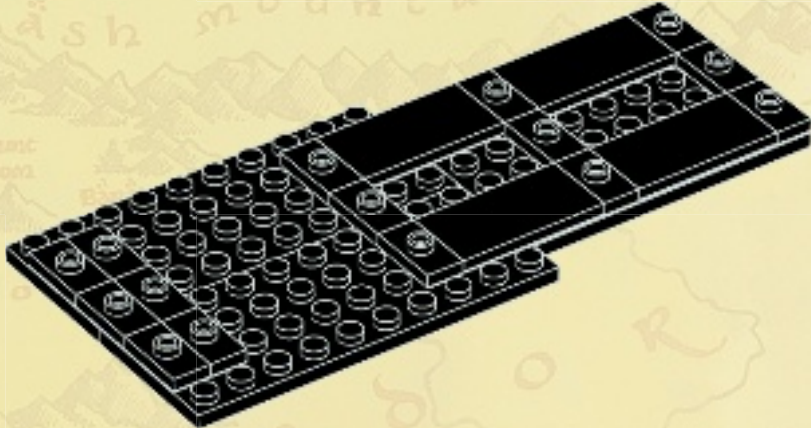



5

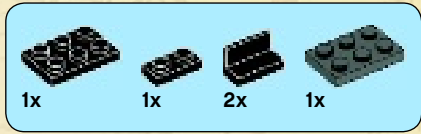
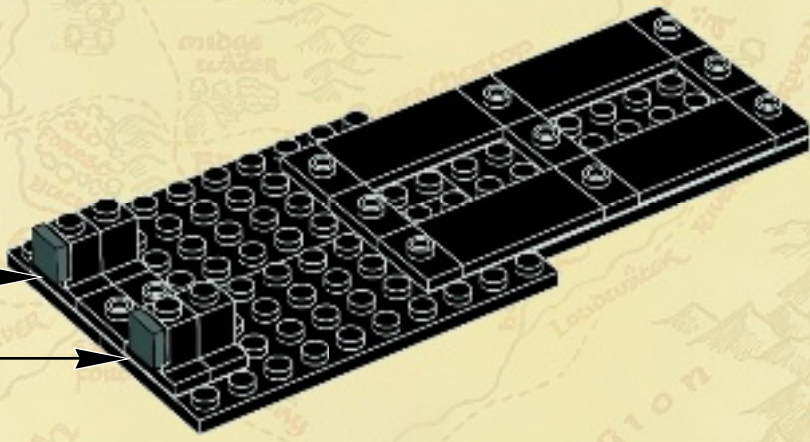
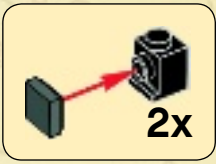

6

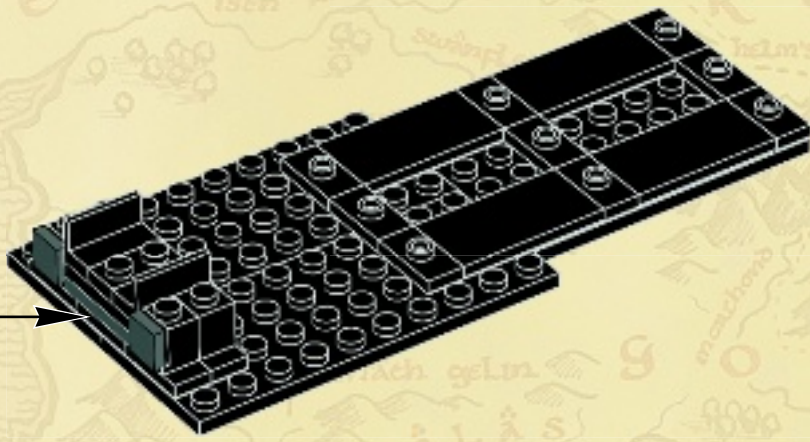
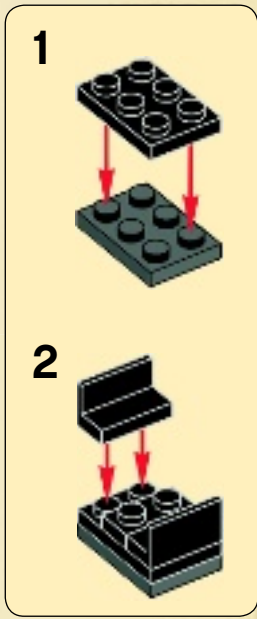

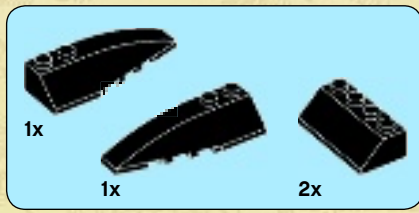

7

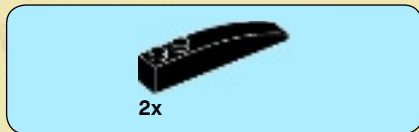
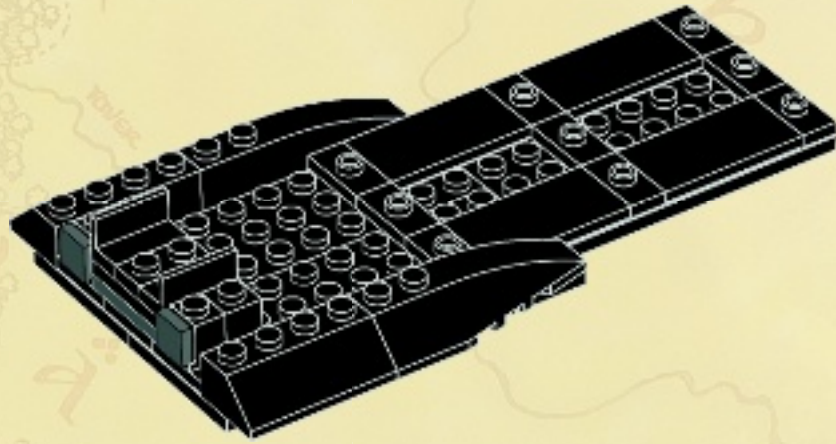

8

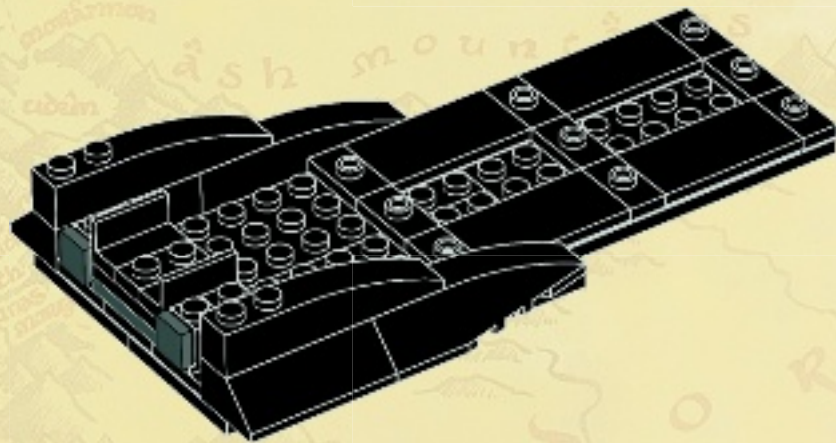

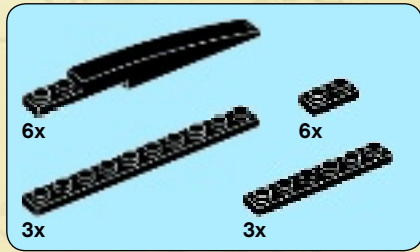

9

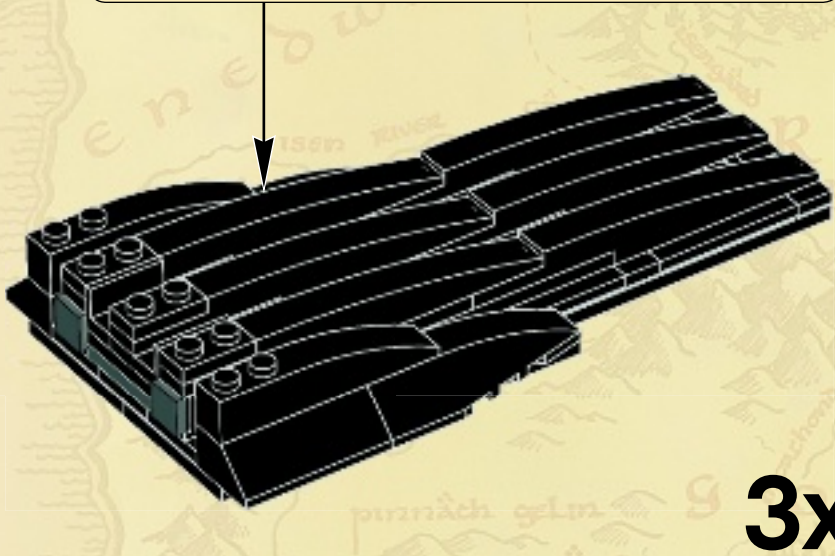
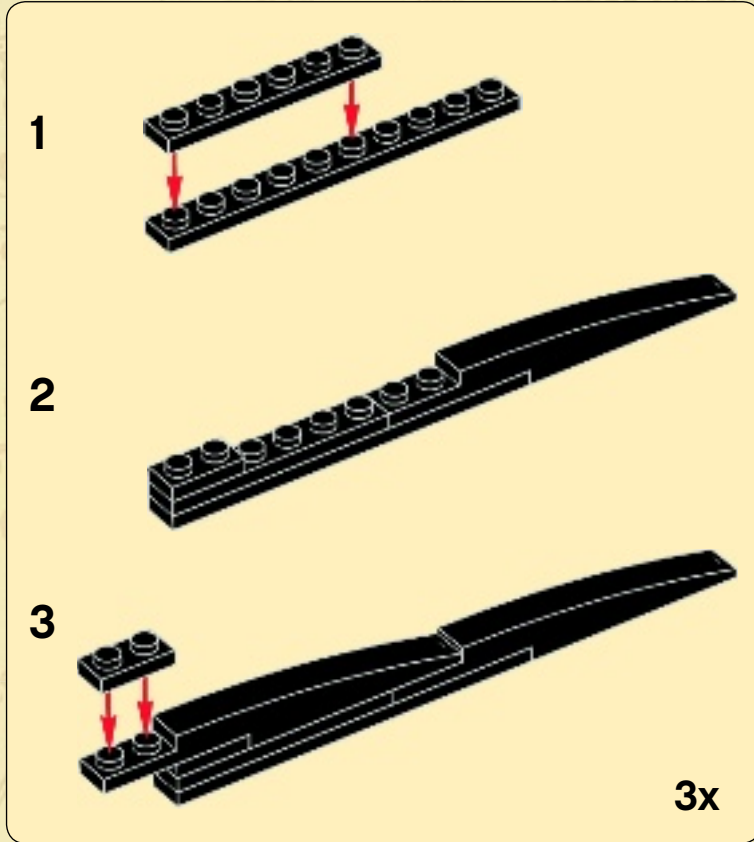

41

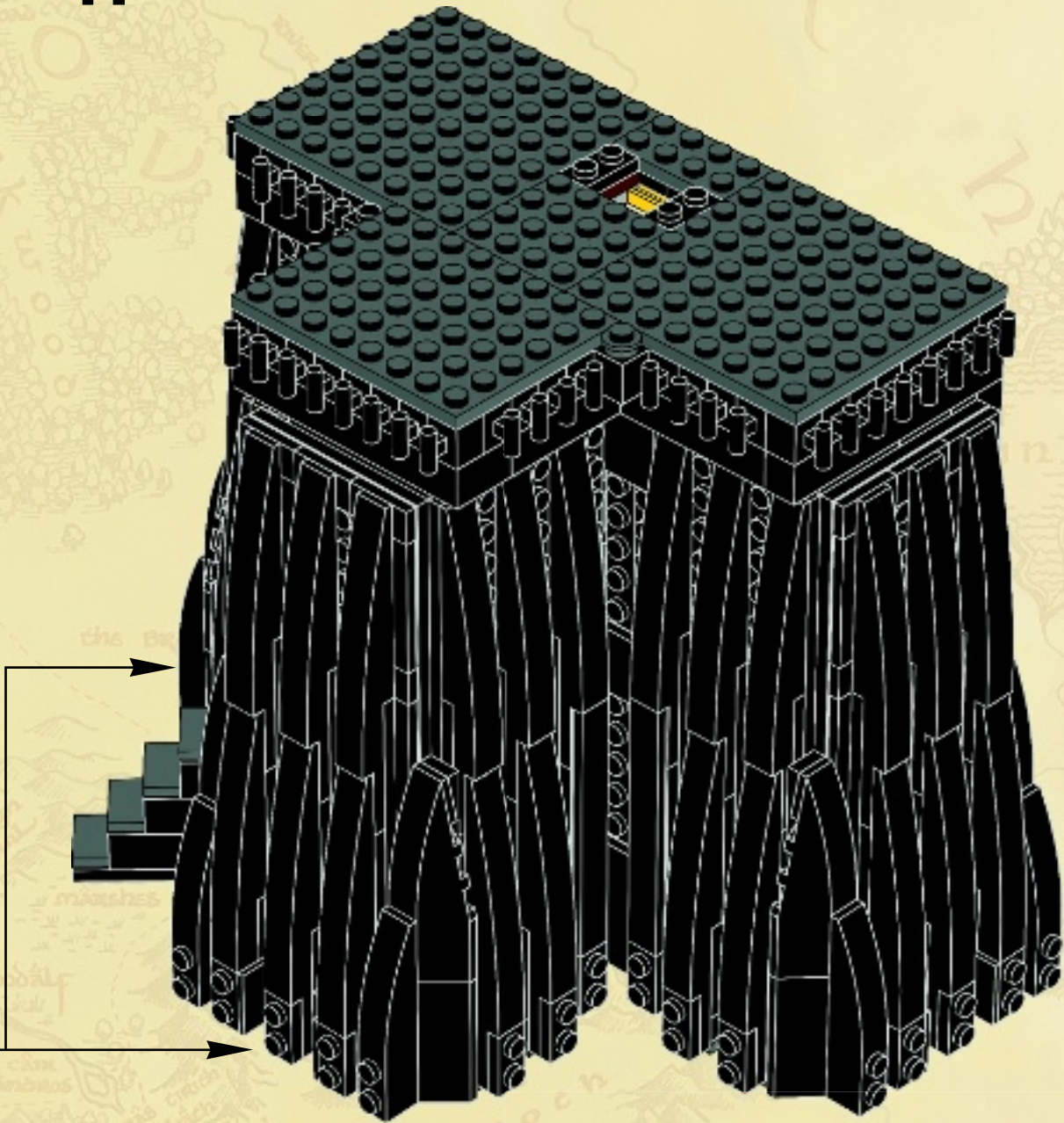

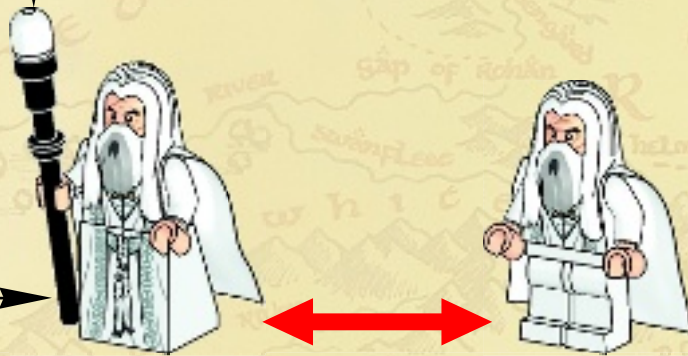
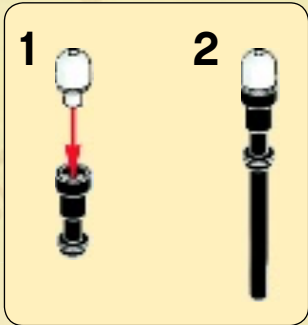
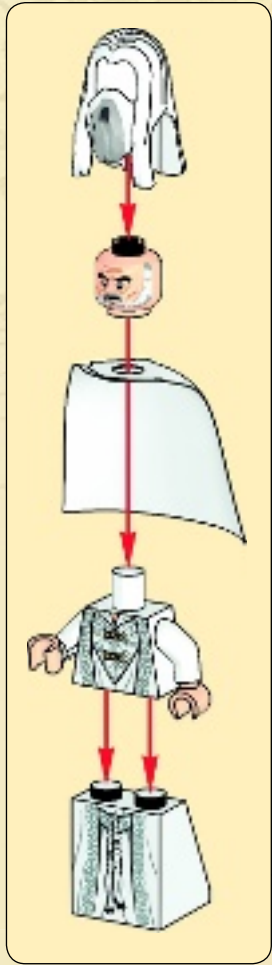
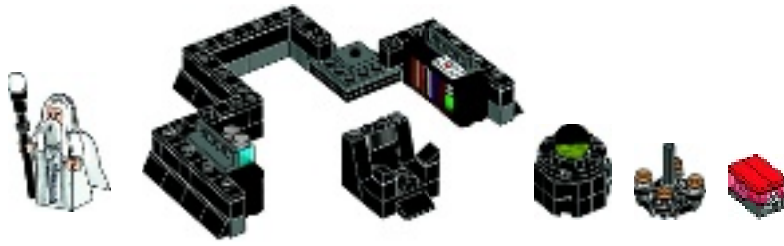

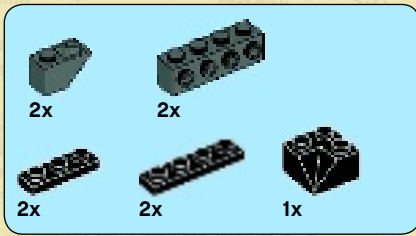

42

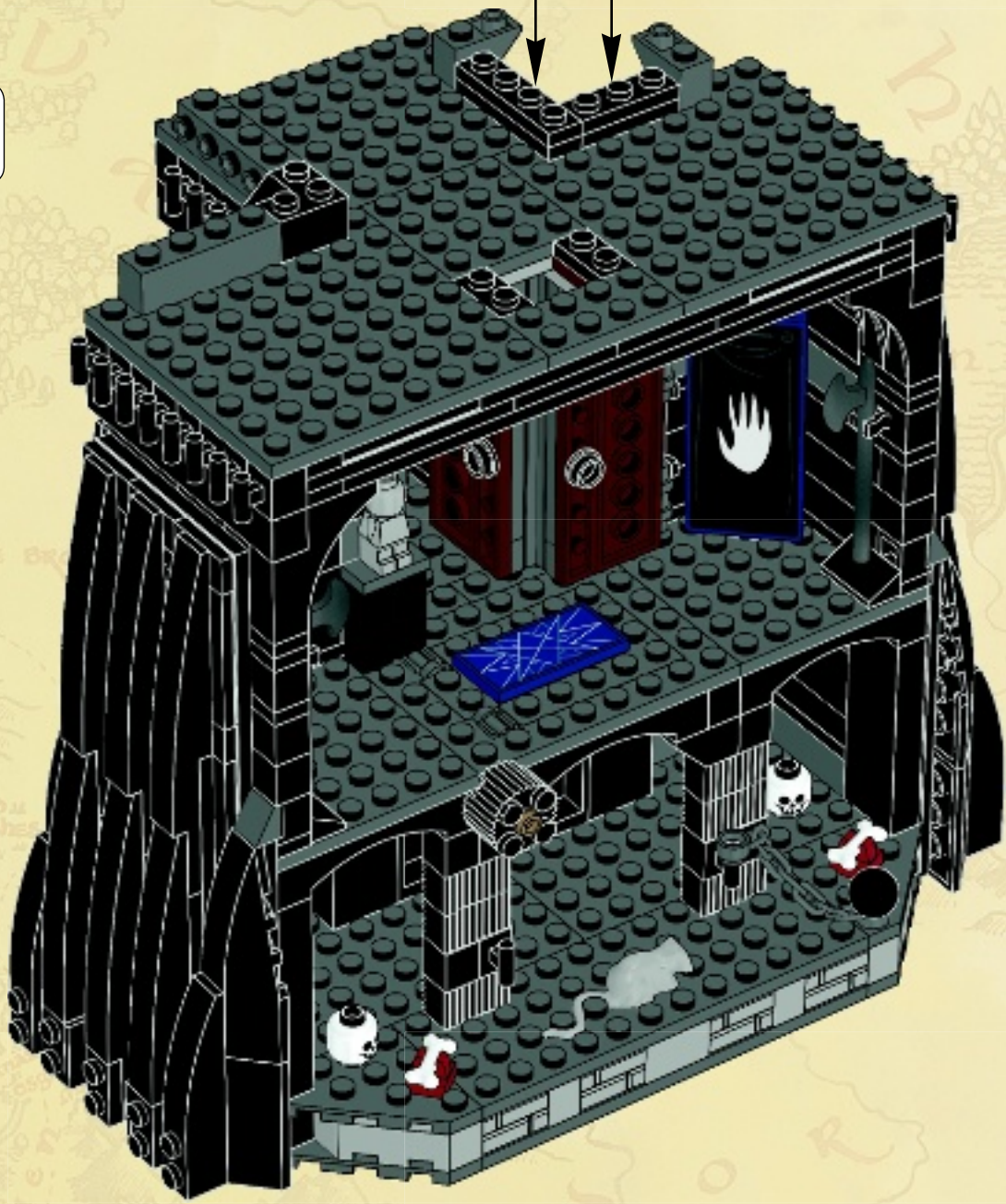
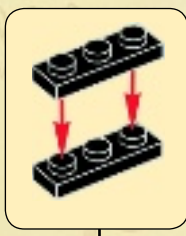
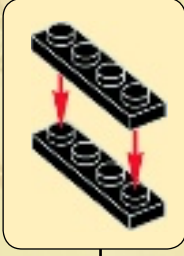



# 43

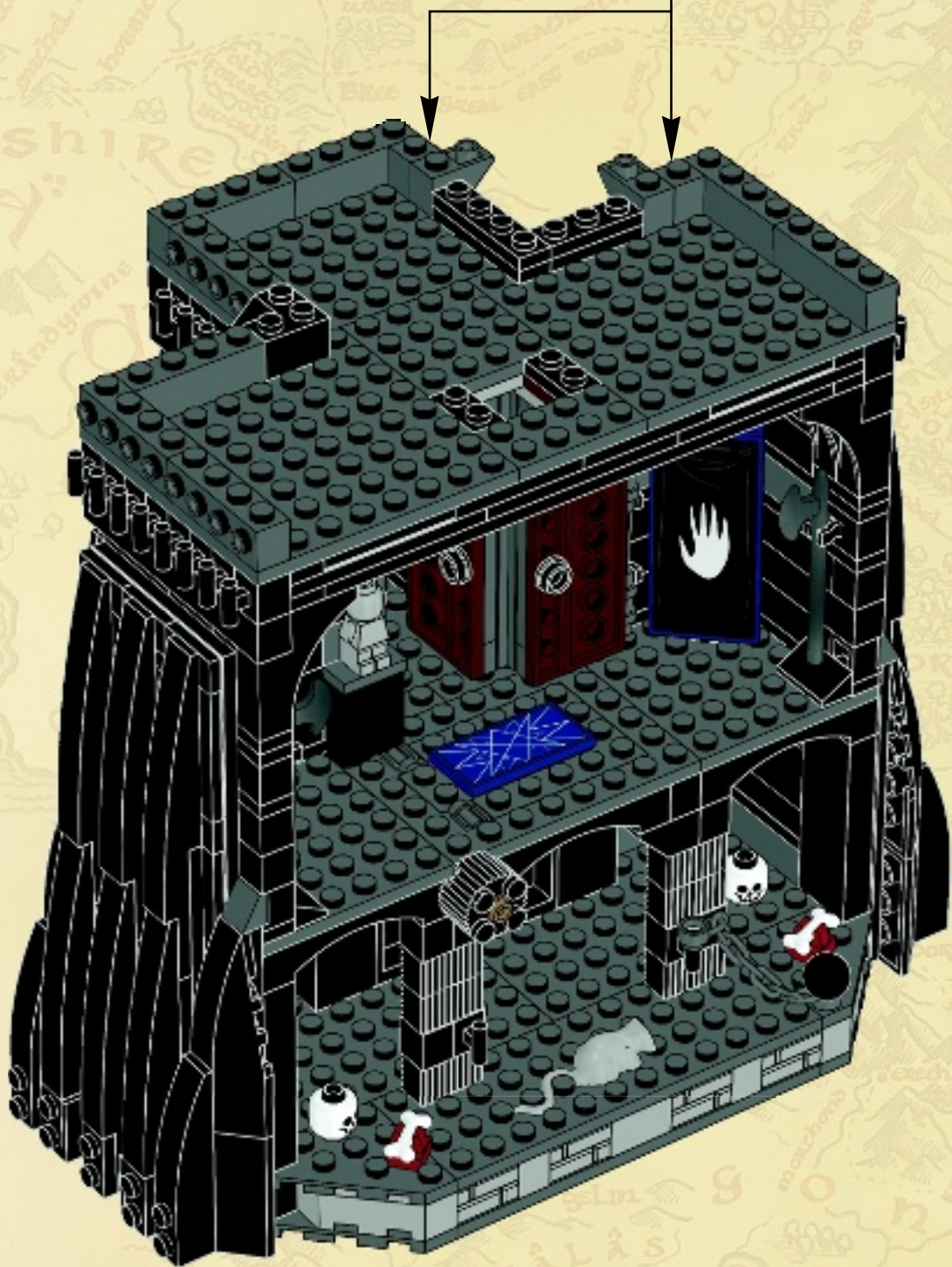
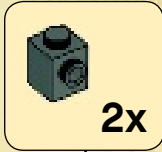



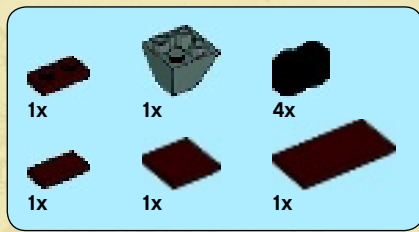

44

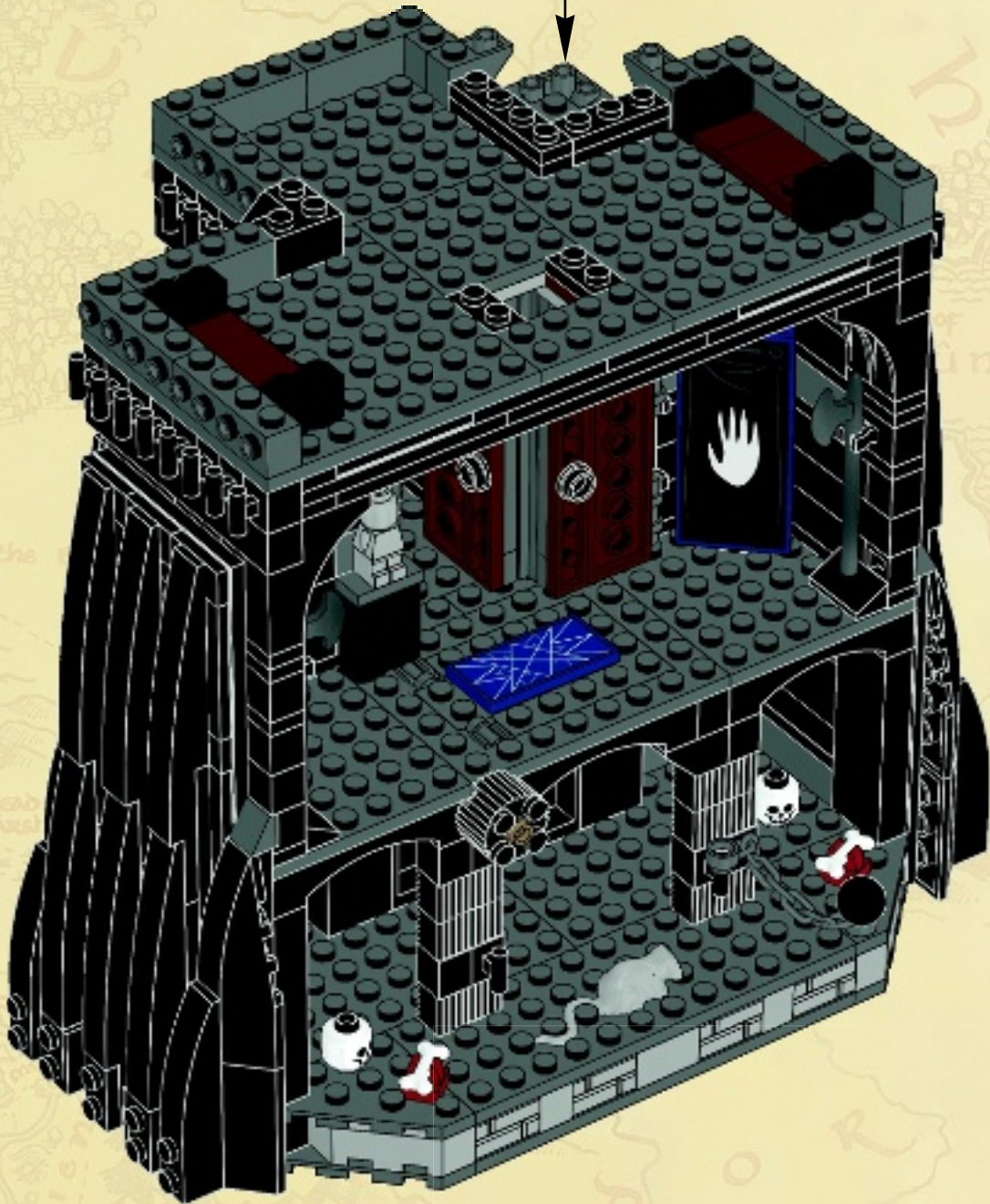
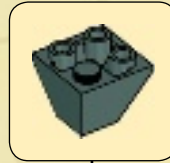

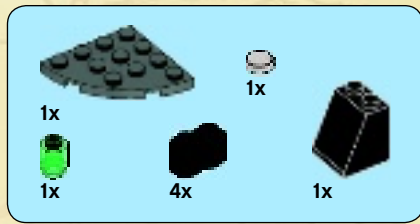

45

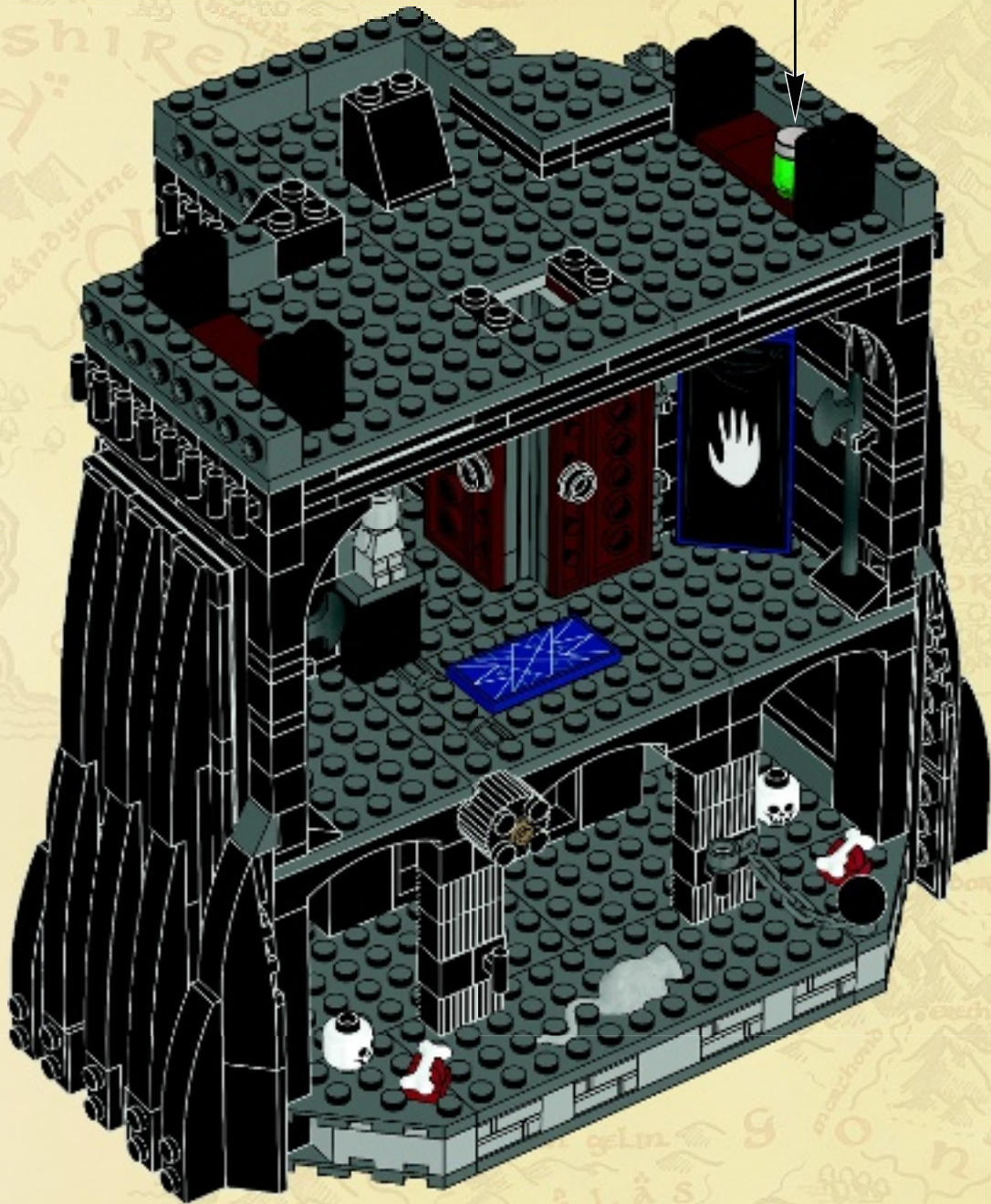

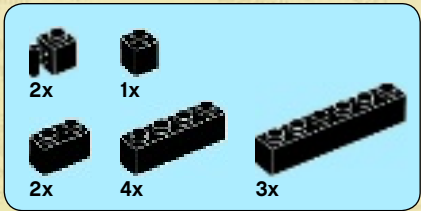

# 46

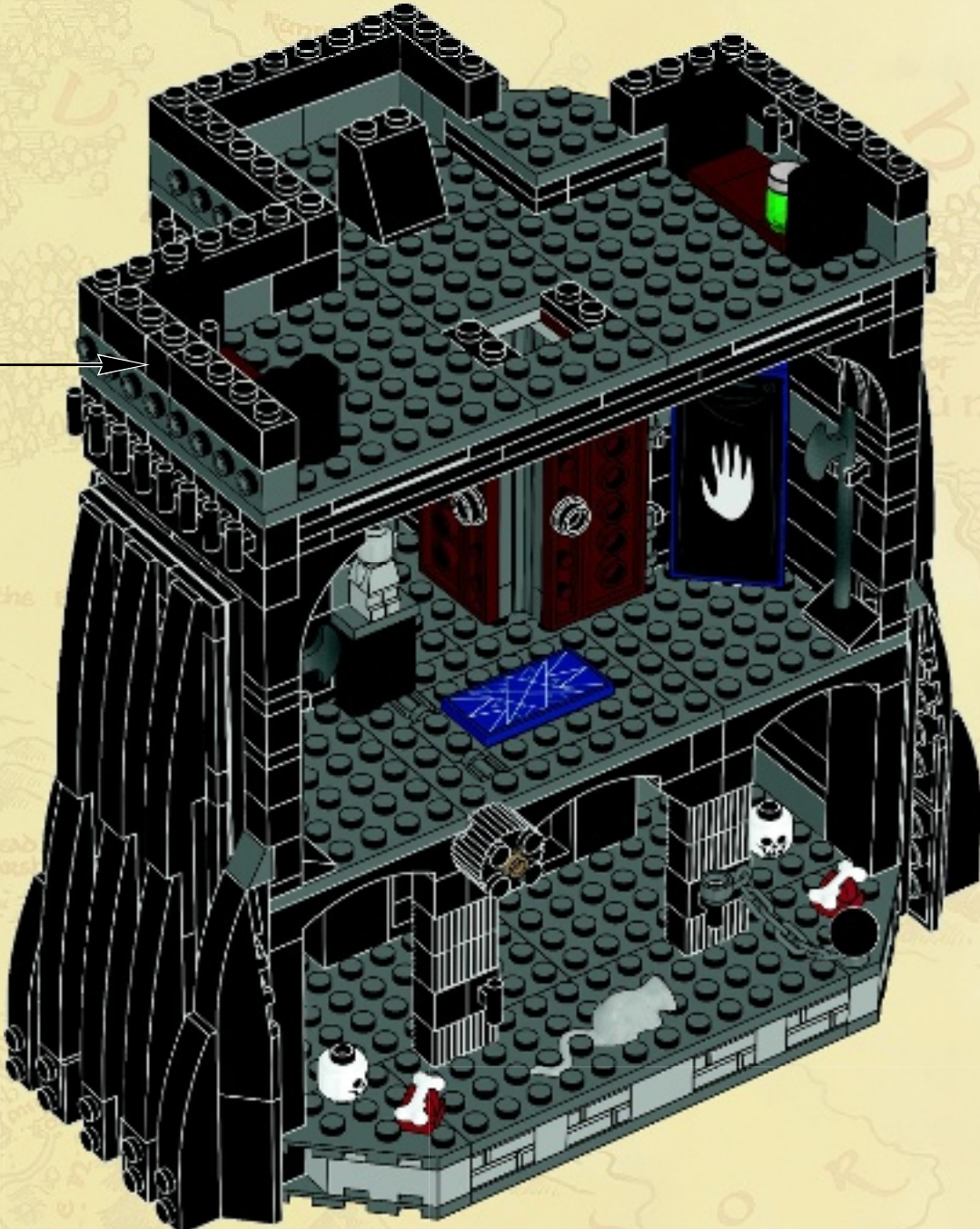



47

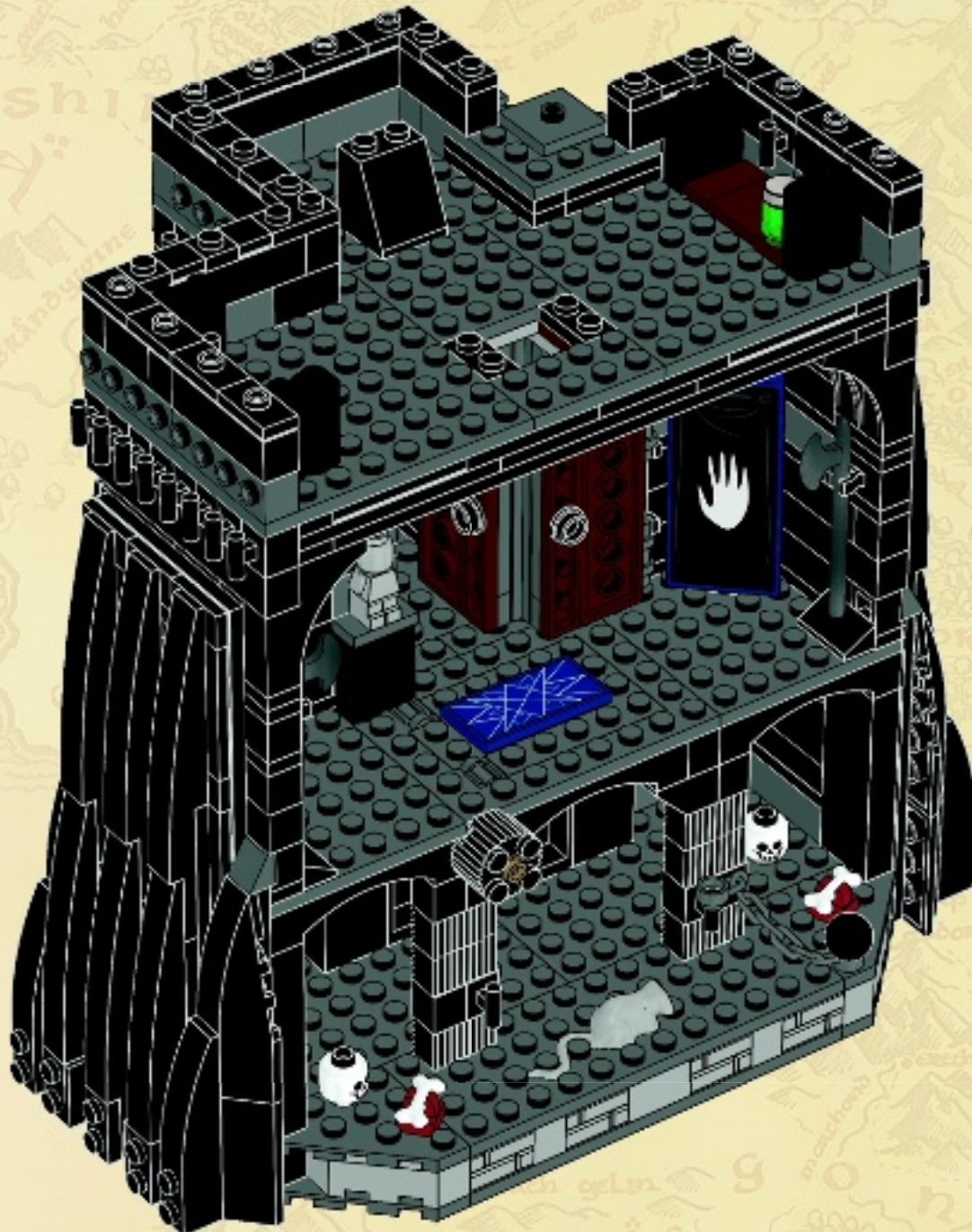

- 1x
- 3x
- 3x
- 3x
- 2x
- 1x

# 48

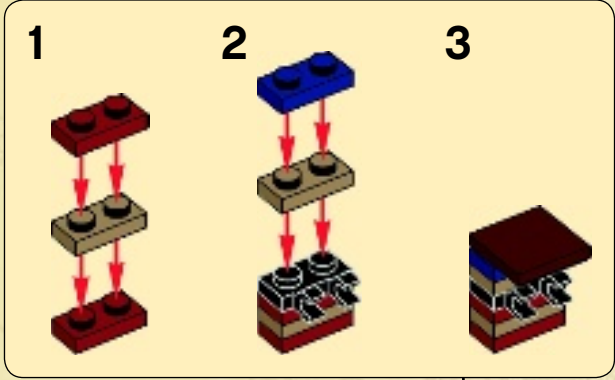
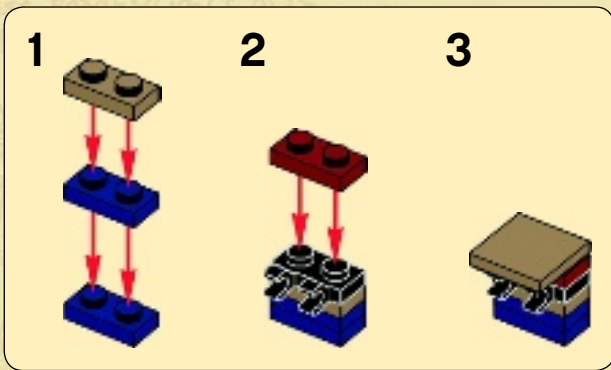



2x



18x

# 49

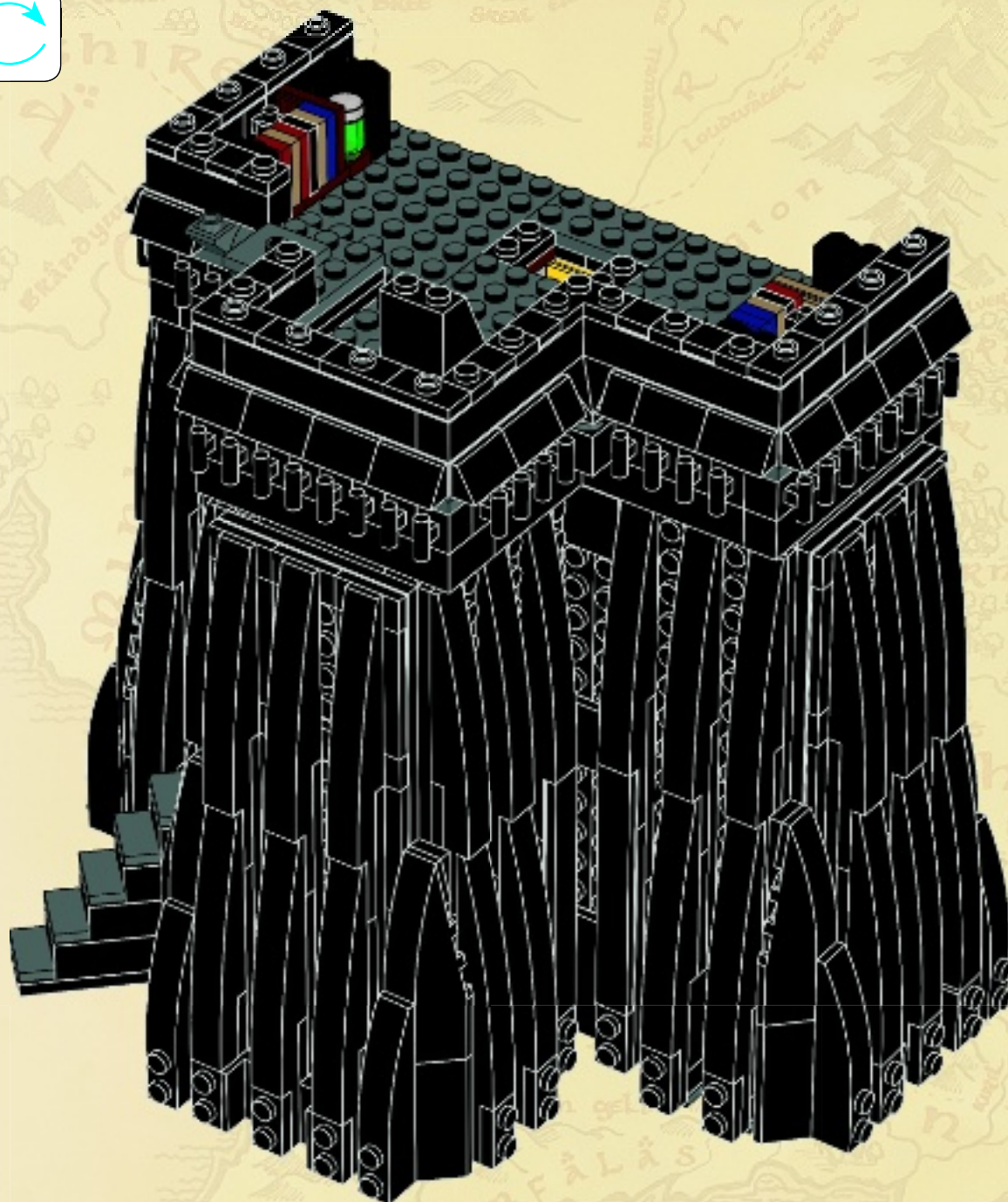
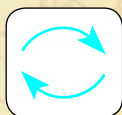

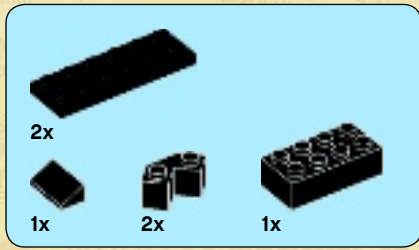

50

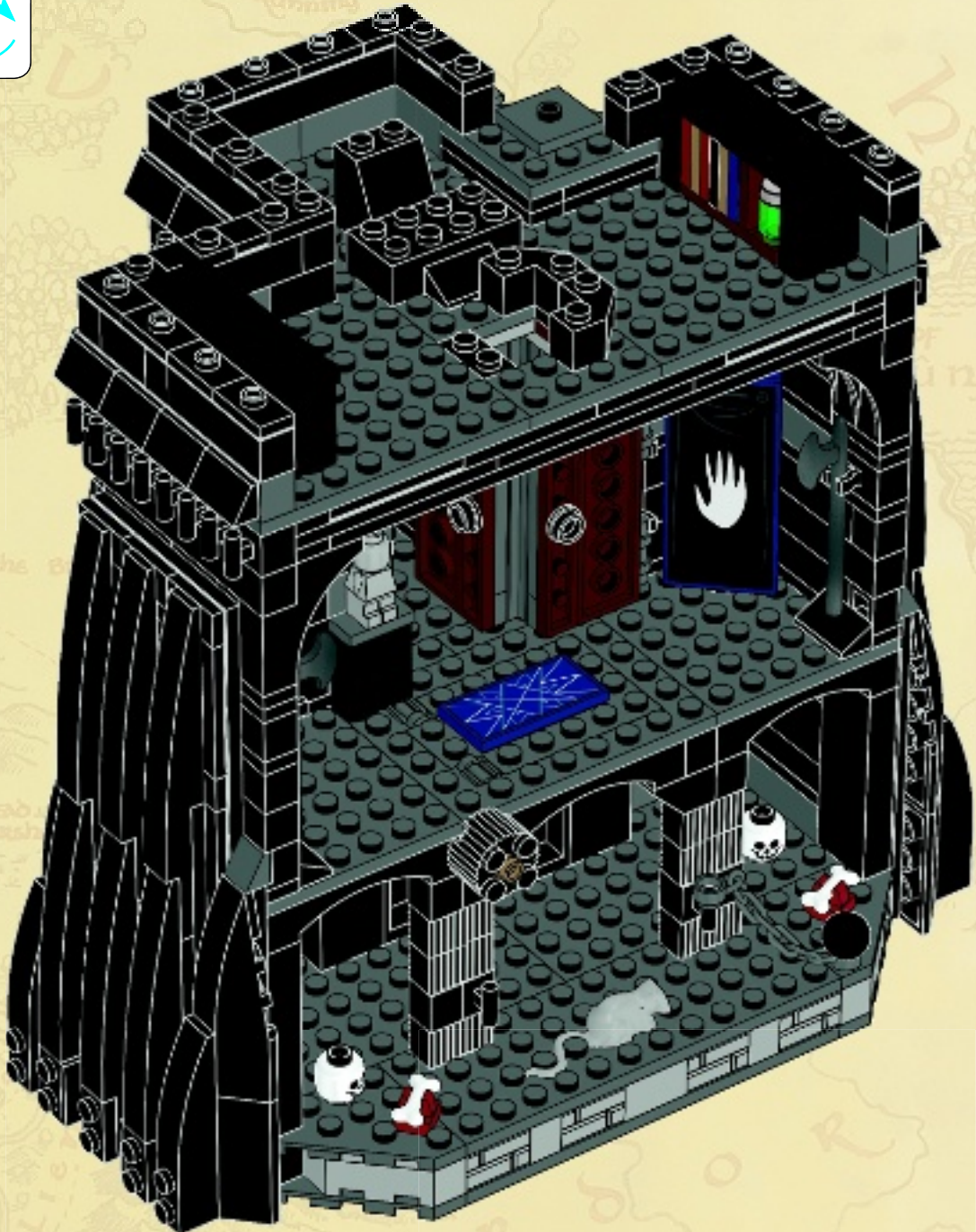

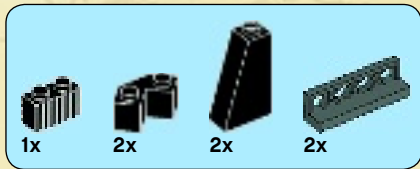

51

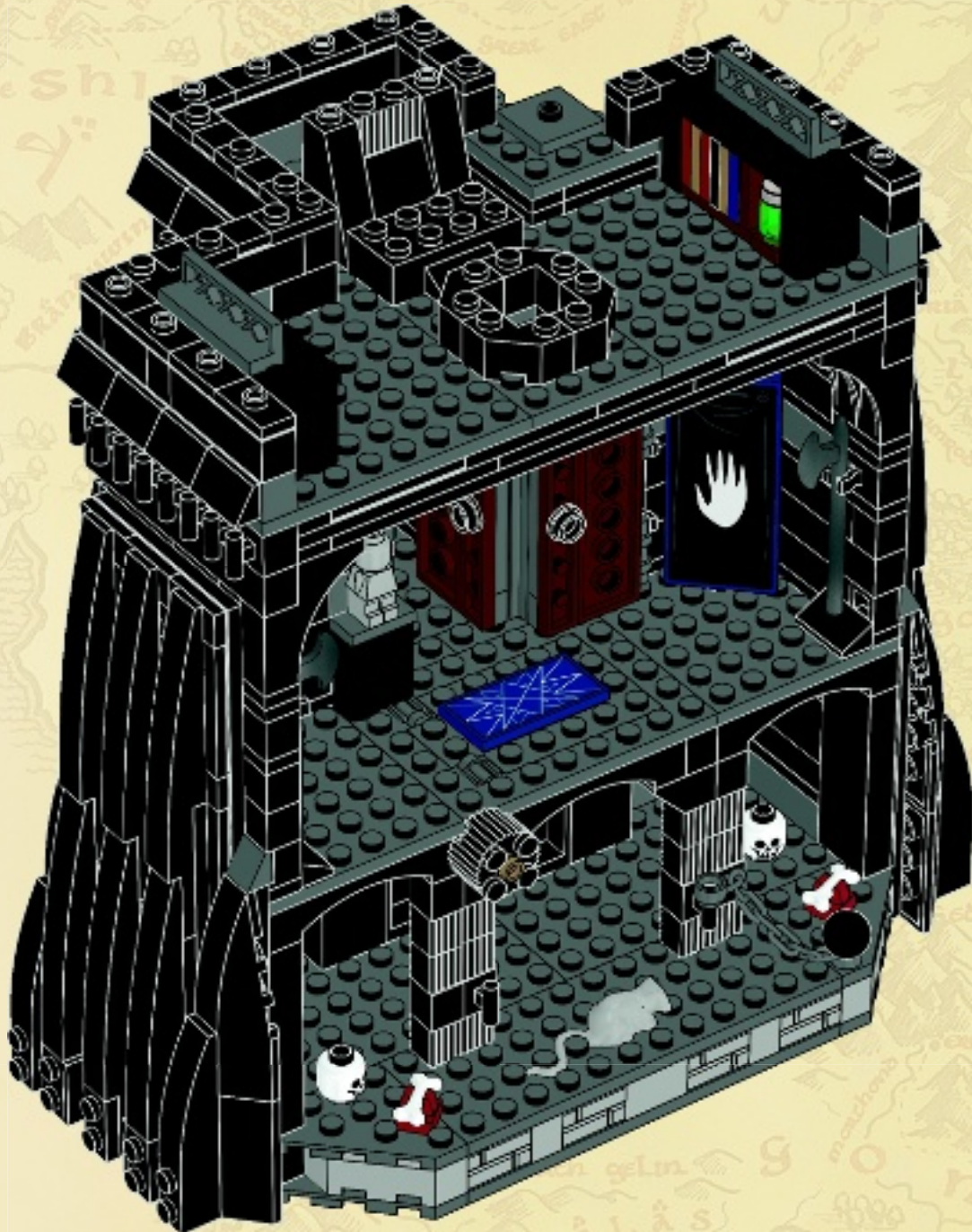



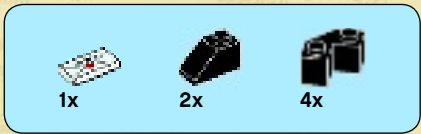

# 52

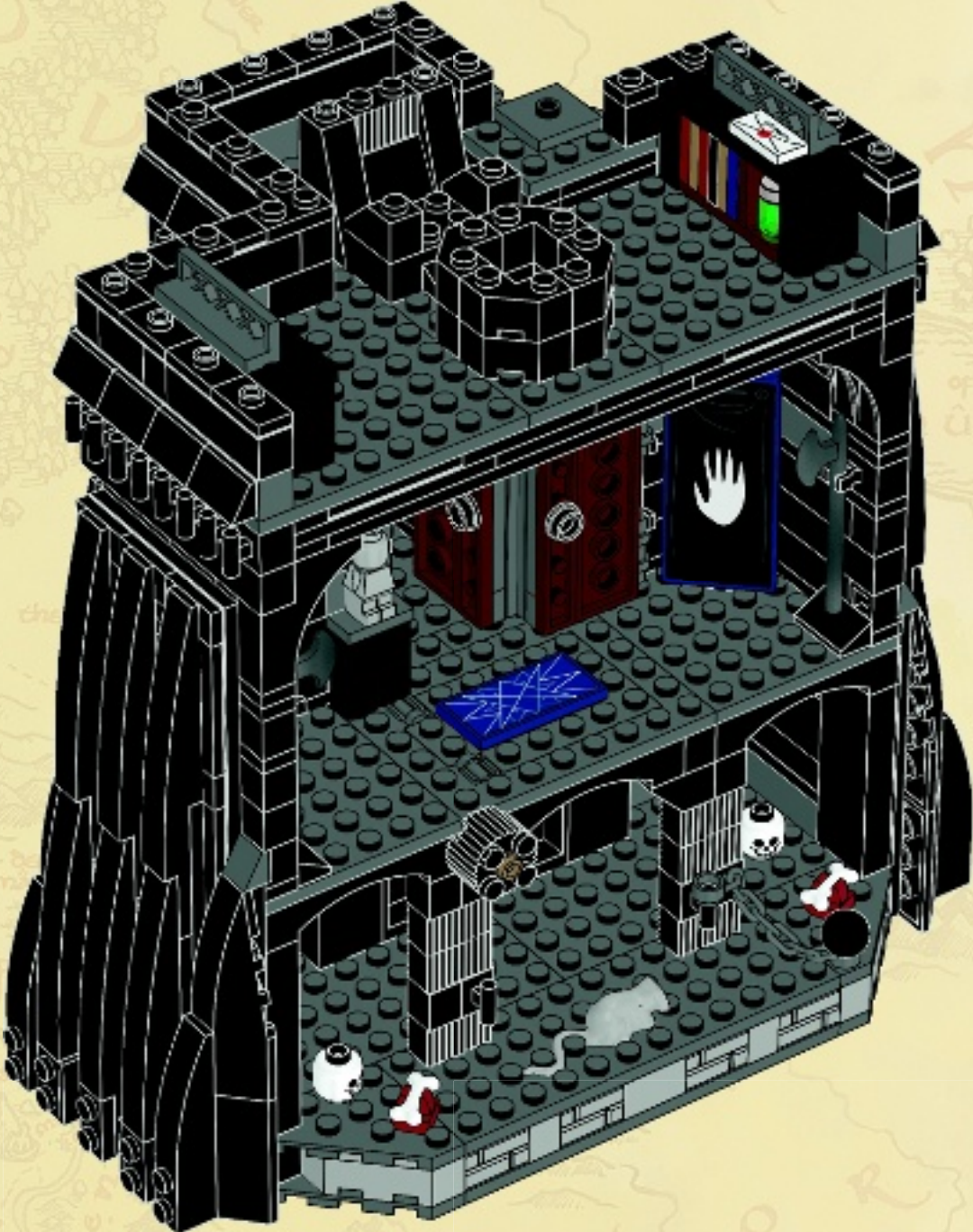

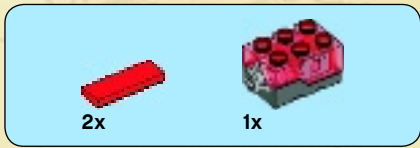

Light brick  
Brique lumière  
Ladrillo luminoso



53

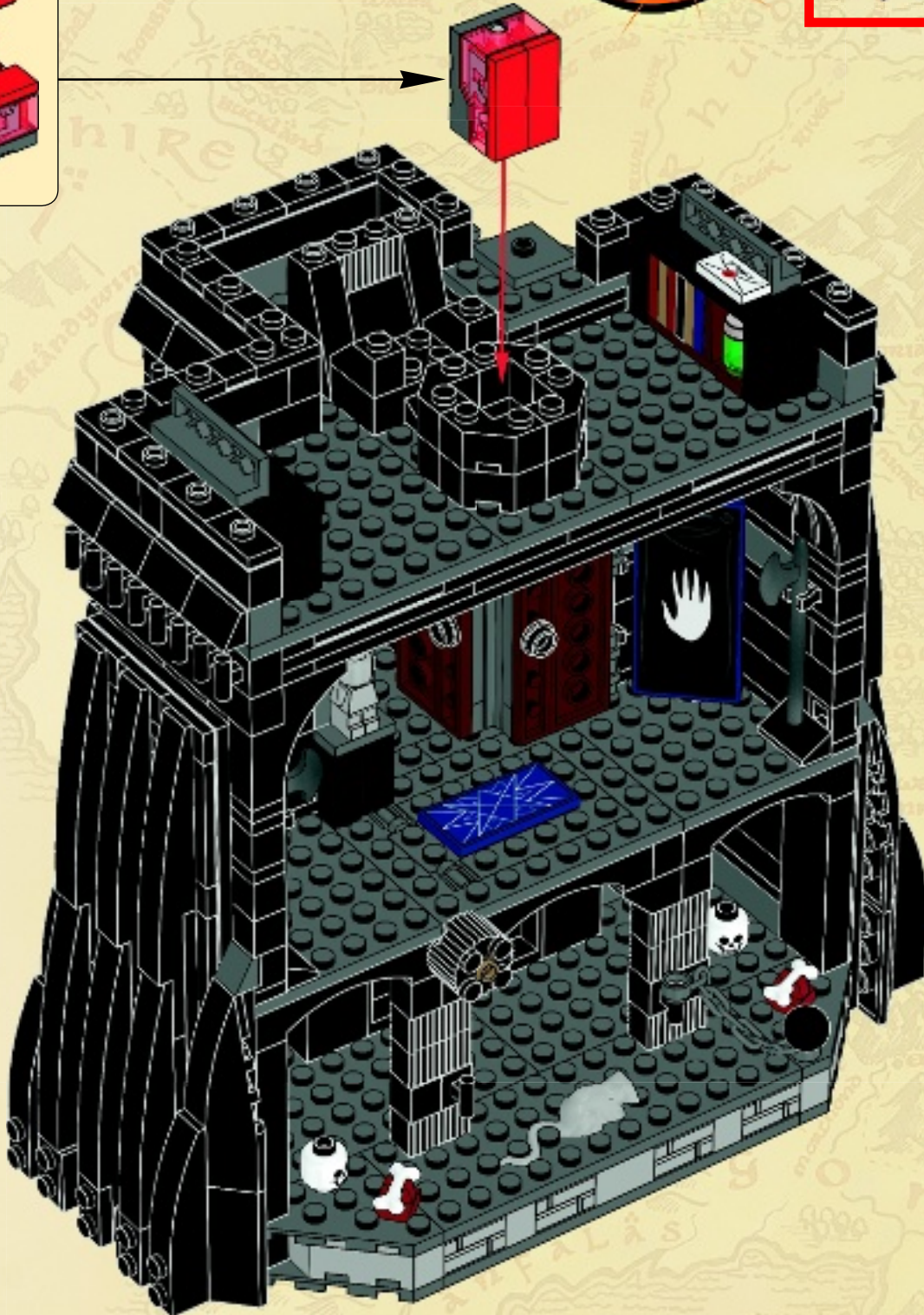
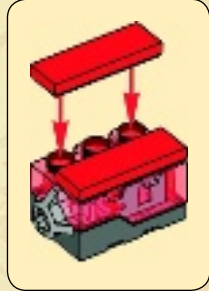

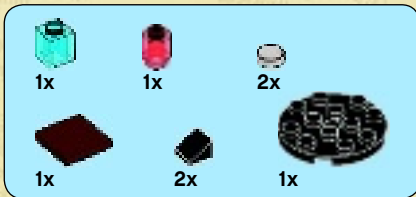

# 54

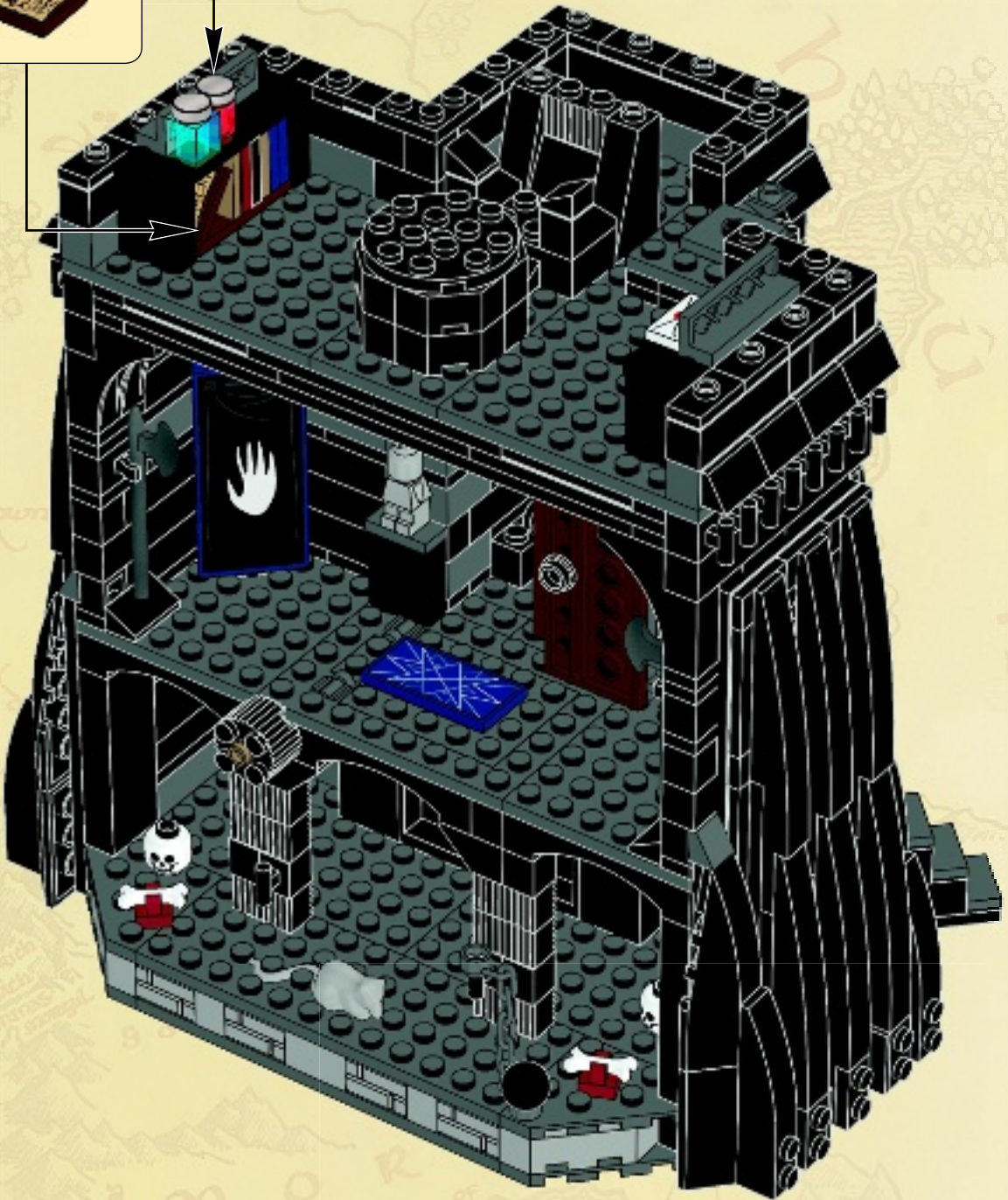
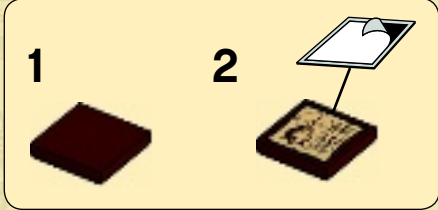

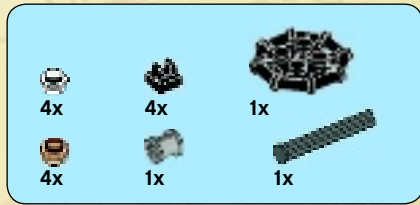

55

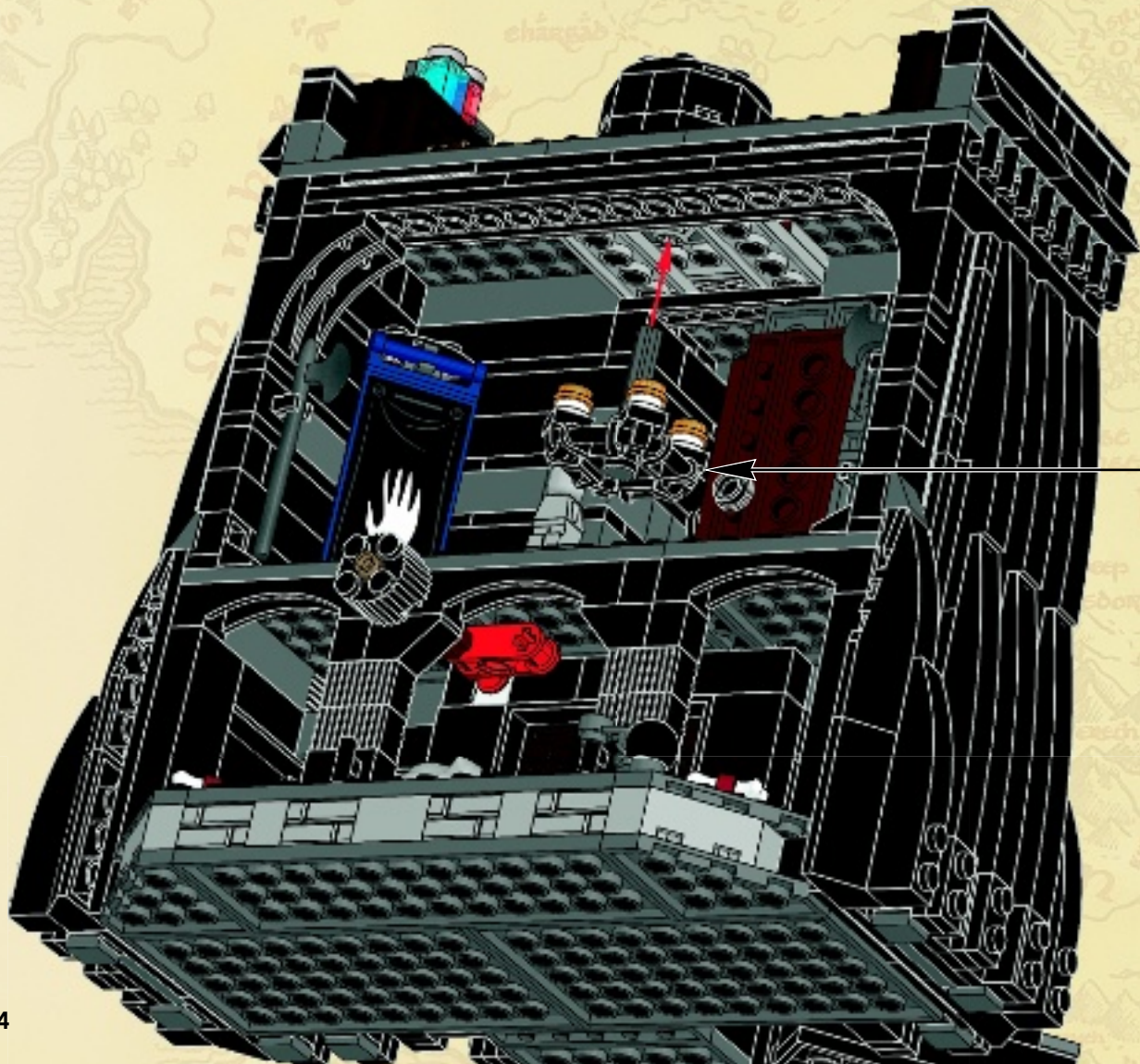



56

Light brick  
Brique lumière  
Ladrillo luminoso

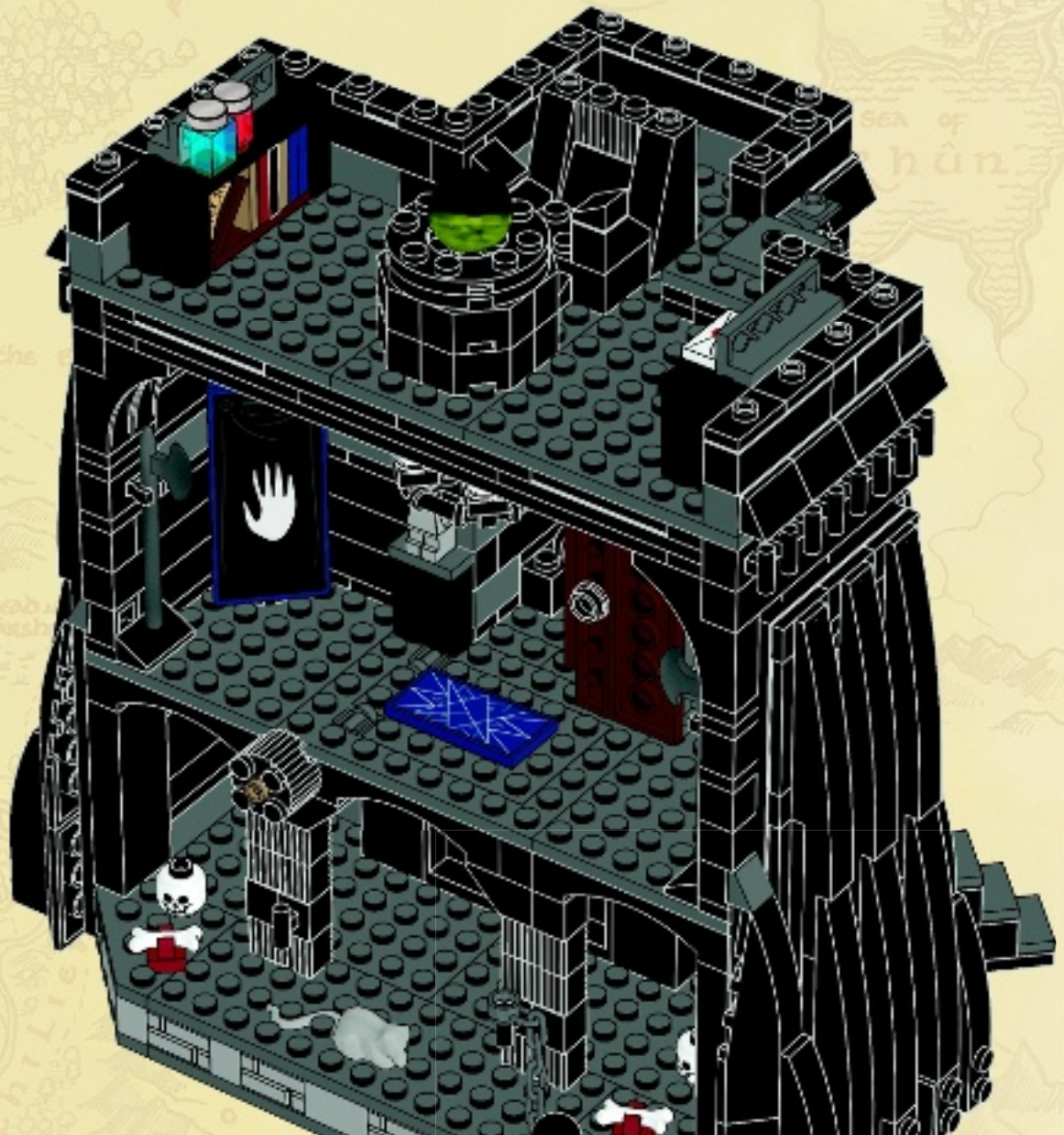

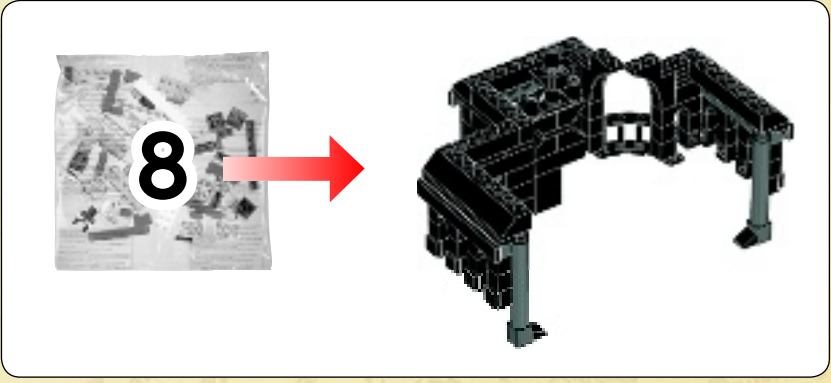

22x 18x 18x

A light blue box containing three small images of black Technic parts: a 1x2 Technic brick with a hole, a 1x2 Technic brick, and a 1x2 Technic brick with a hole.

# 57

1 2 18x

Two inset diagrams. The first shows a 1x2 Technic brick with a hole being attached to a 1x2 Technic brick. The second shows a 1x2 Technic brick with a hole being attached to a 1x2 Technic brick.

2x

An inset diagram showing a 1x2 Technic brick with a hole being attached to a 1x2 Technic brick.





3x



10x

# 58

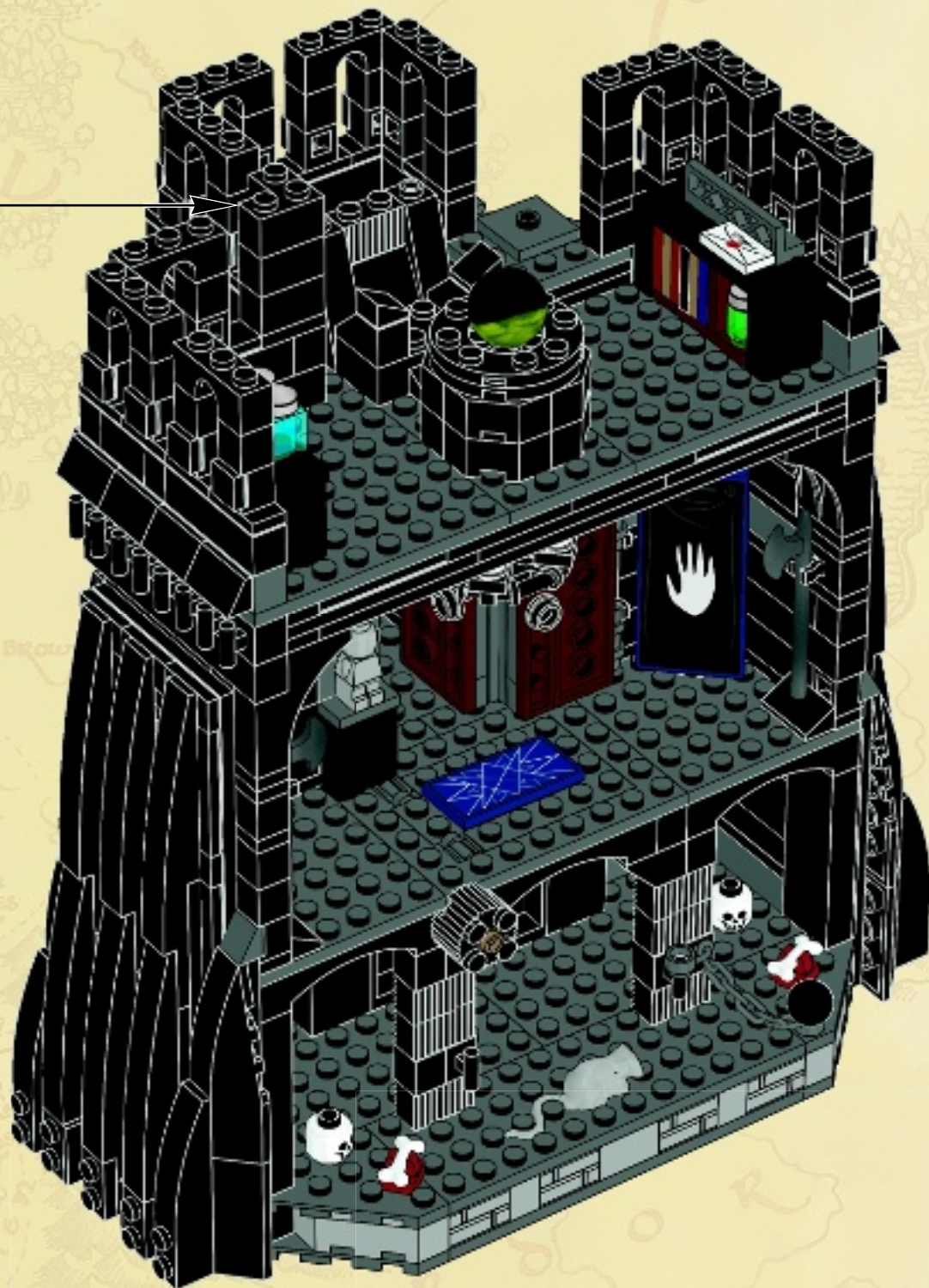
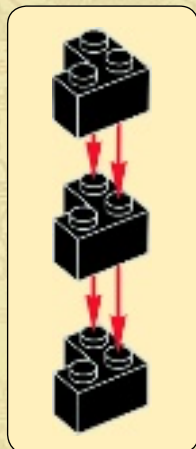

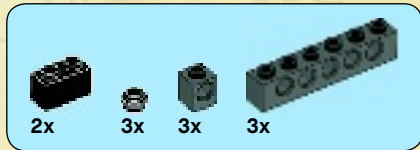

59

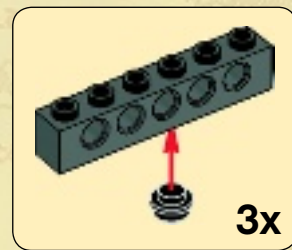
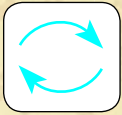



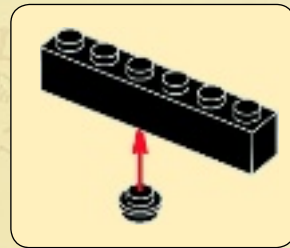
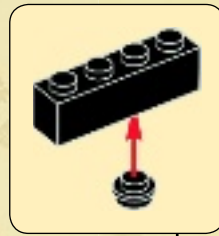
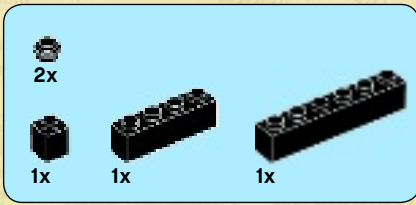

60



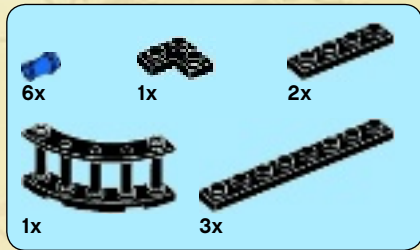

61

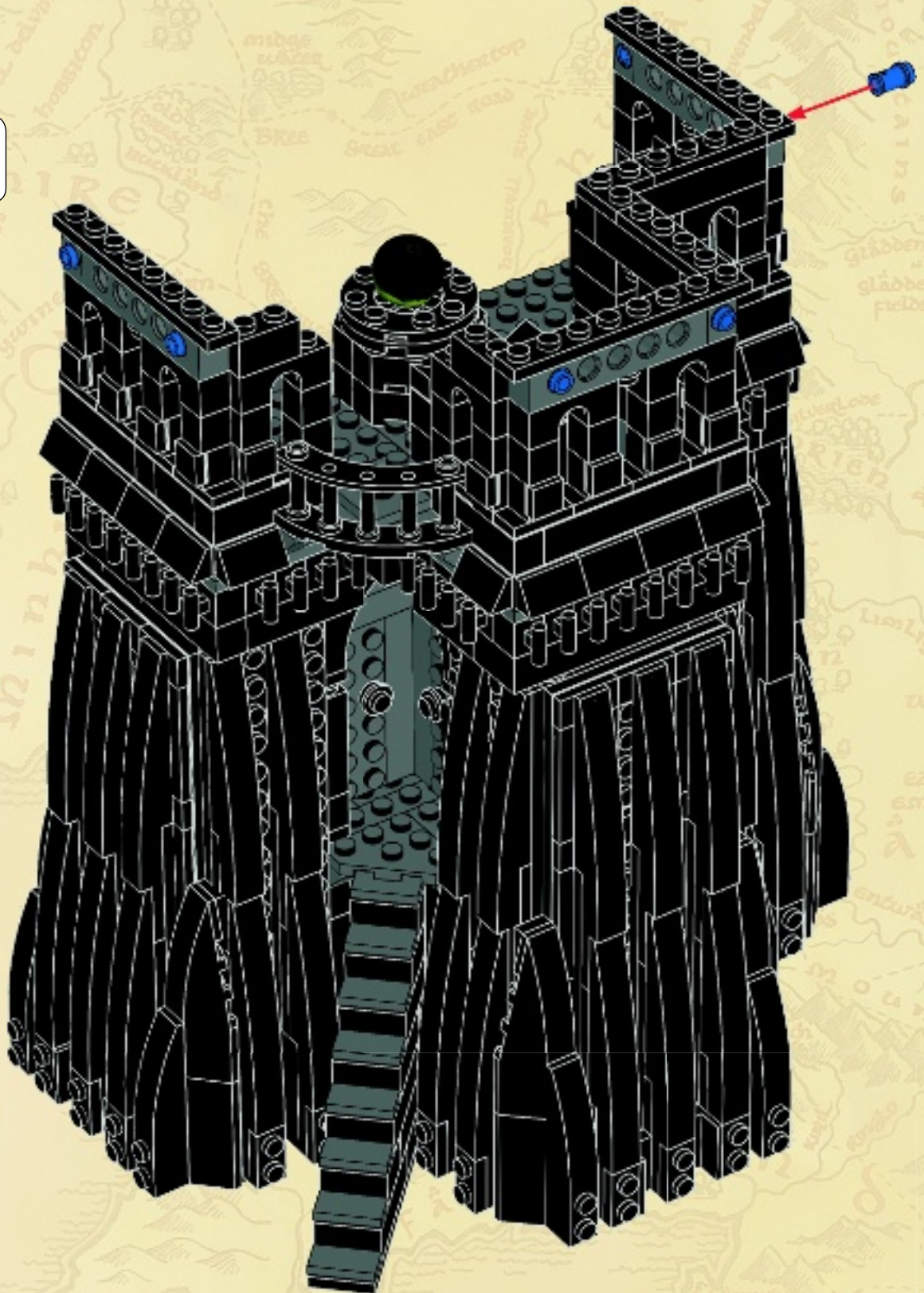

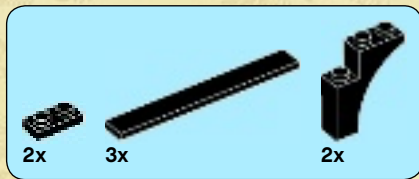

62





63

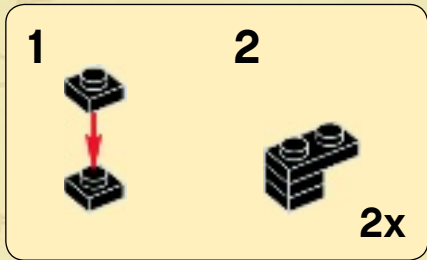

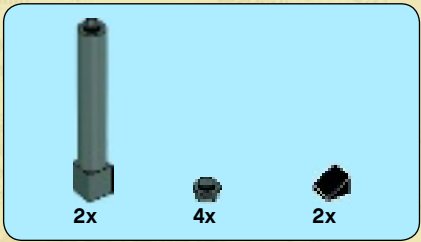

# 64

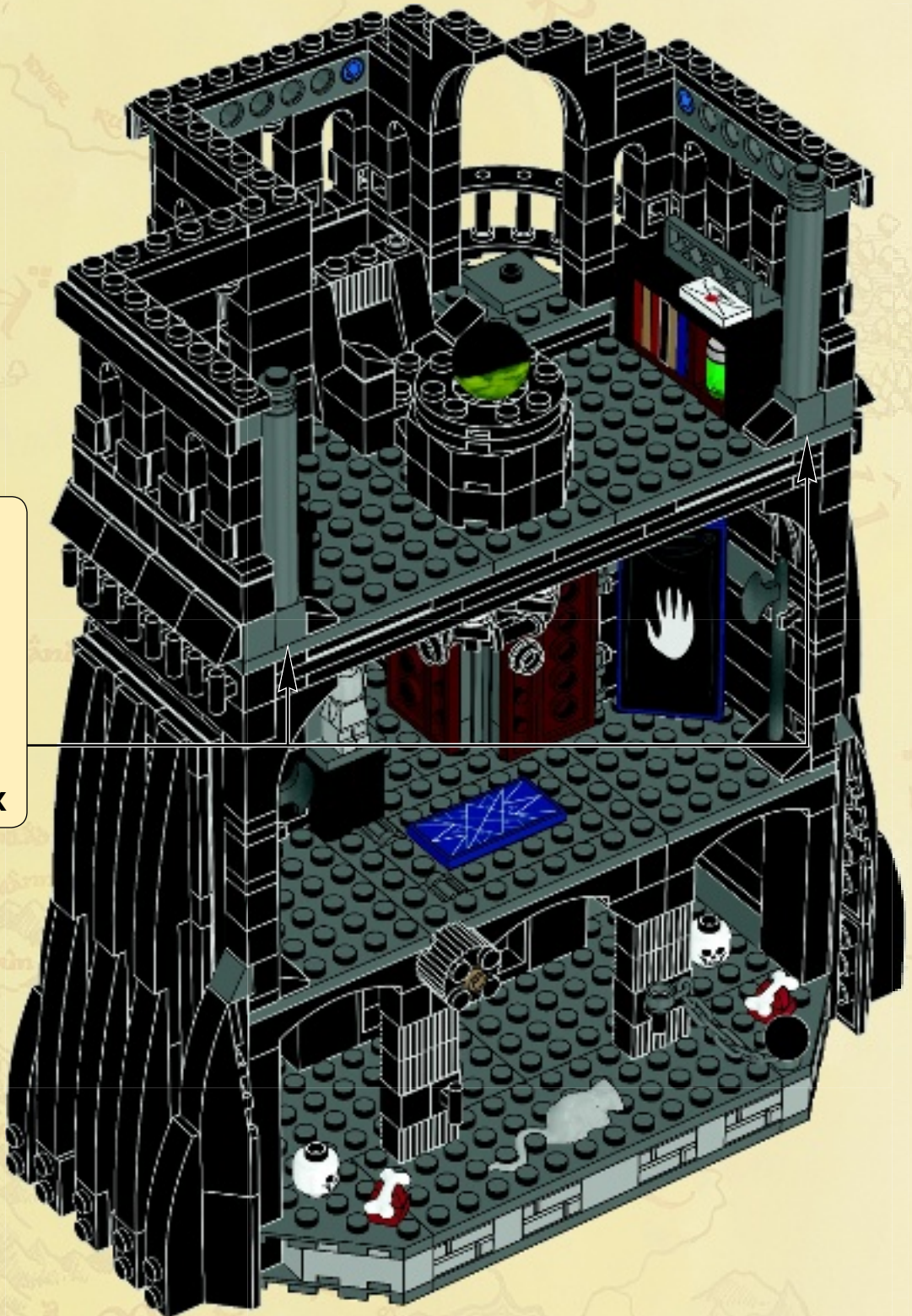
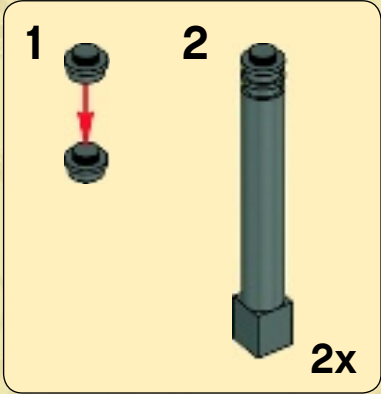
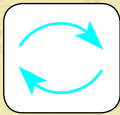

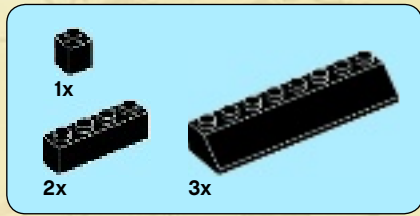

65

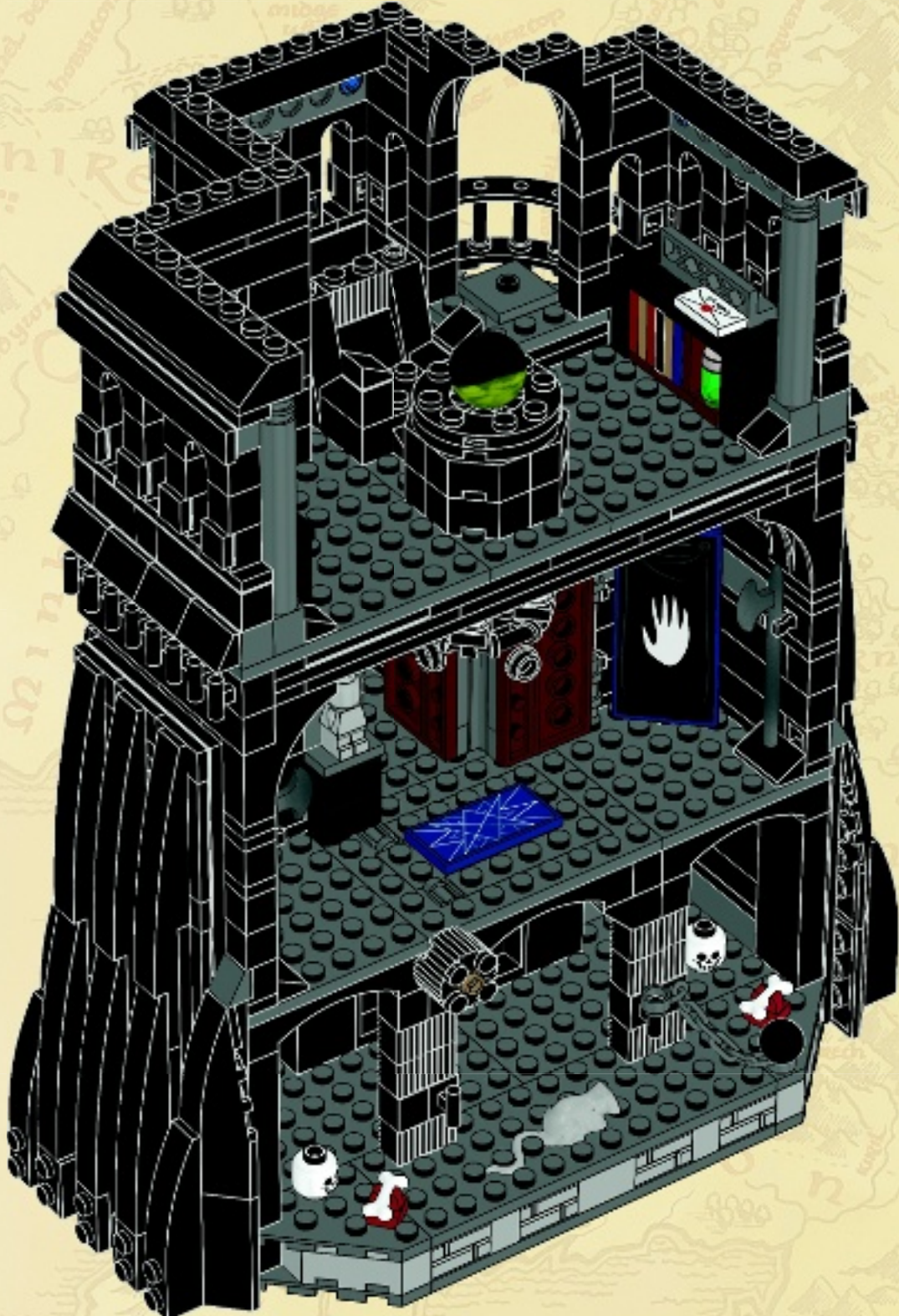

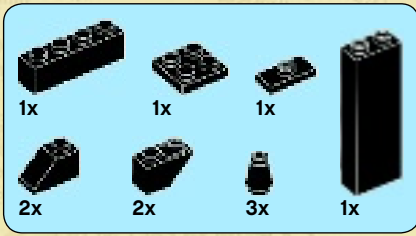

# 66

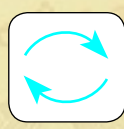
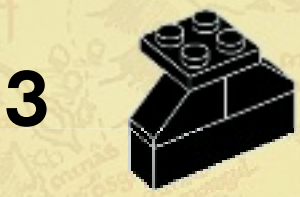

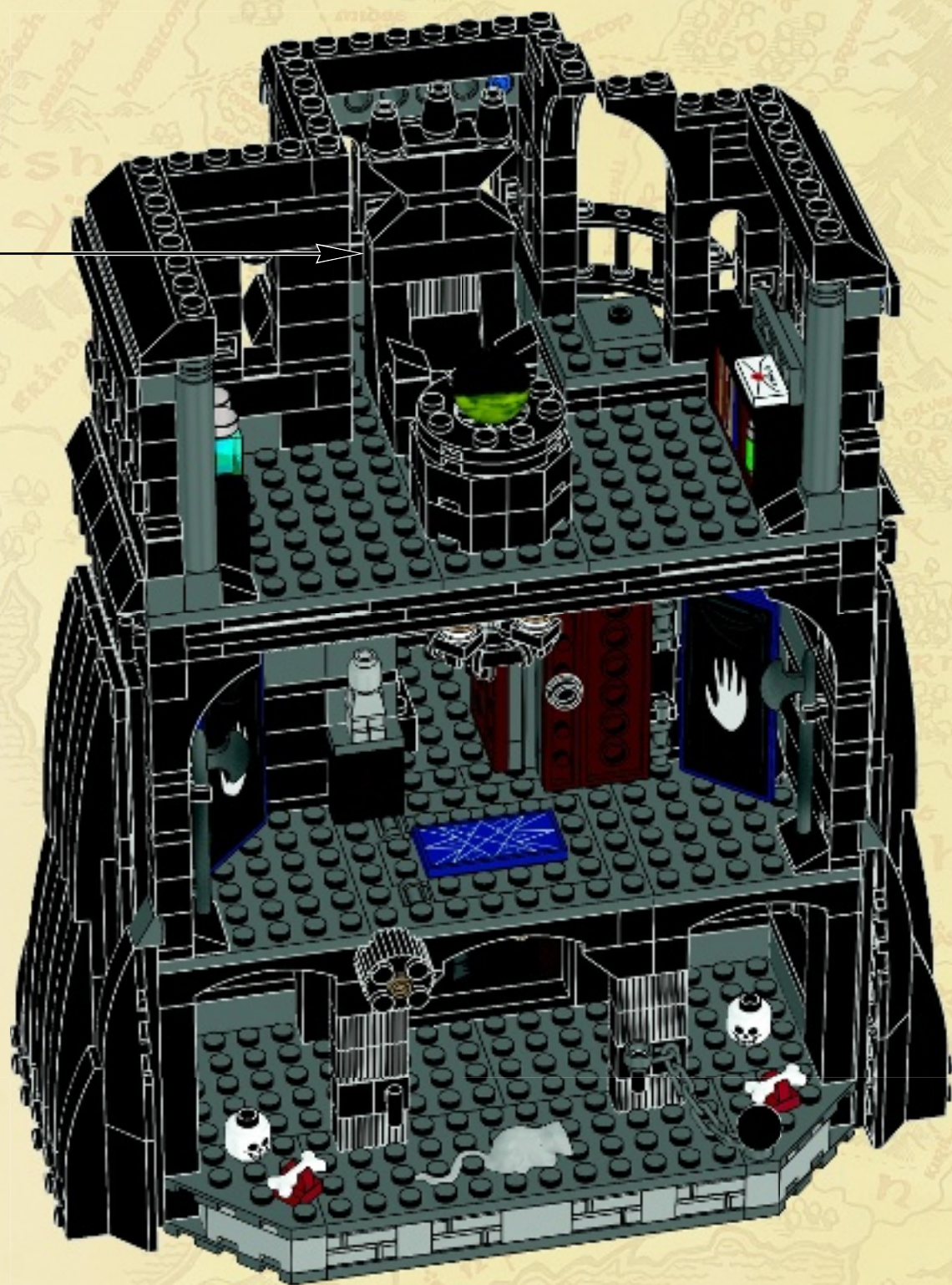



-  1x
-  1x
-  2x
-  1x

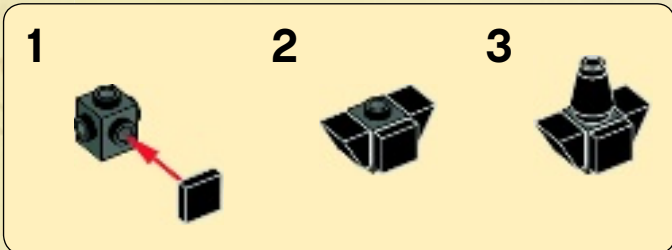

67

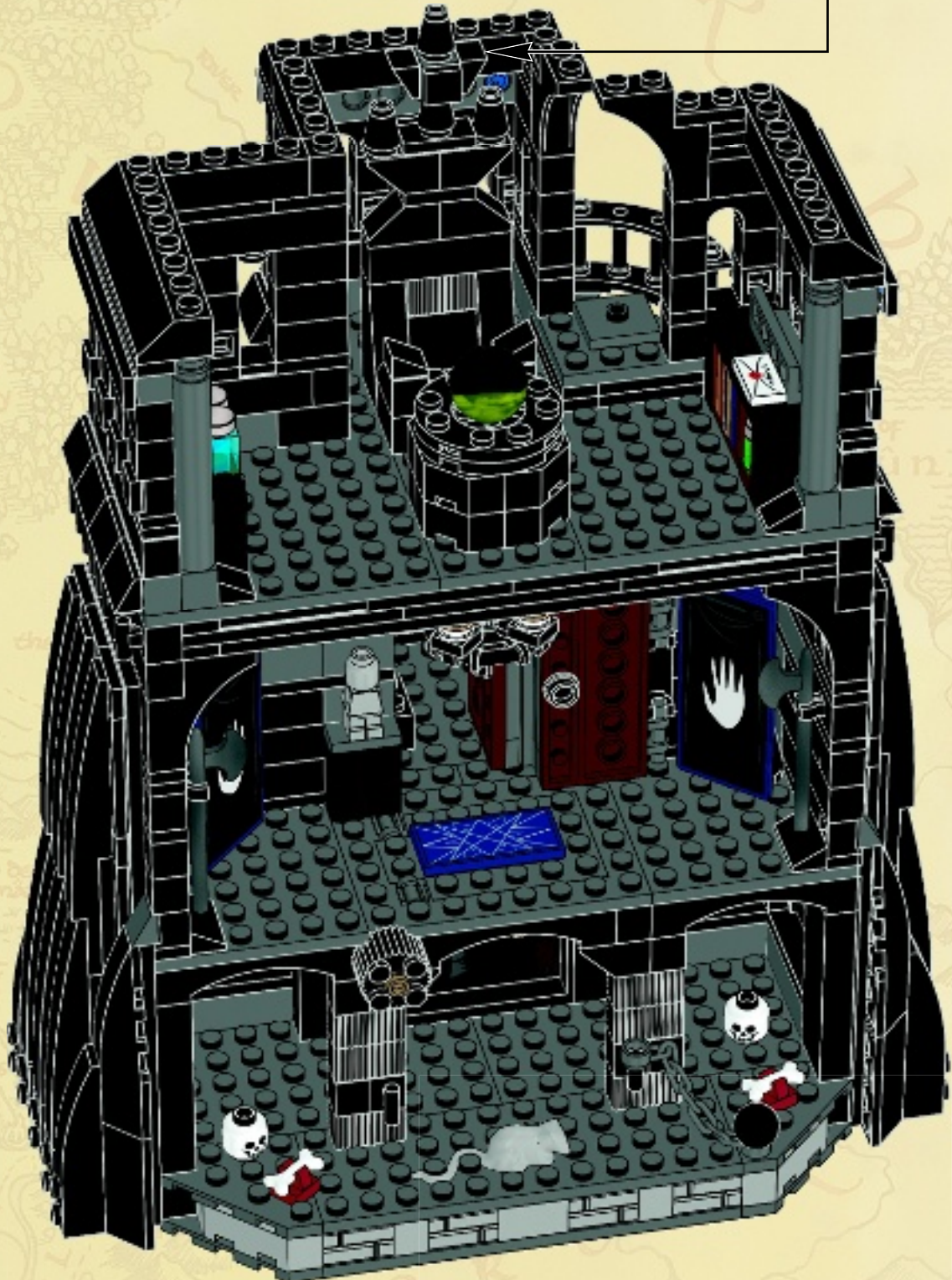

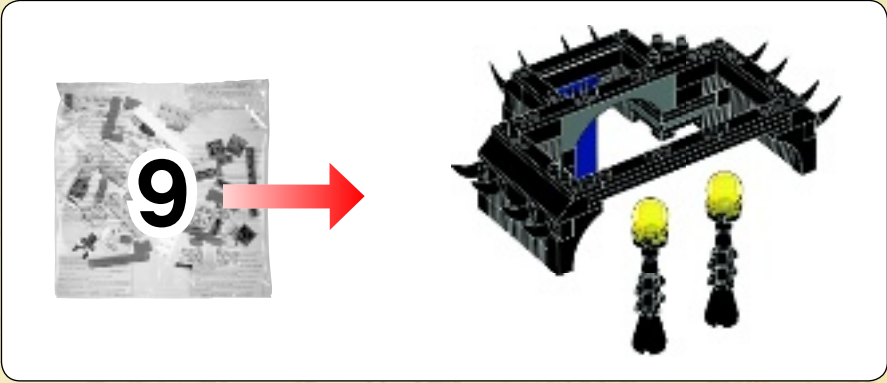

# 68

1



2



3



4



2x

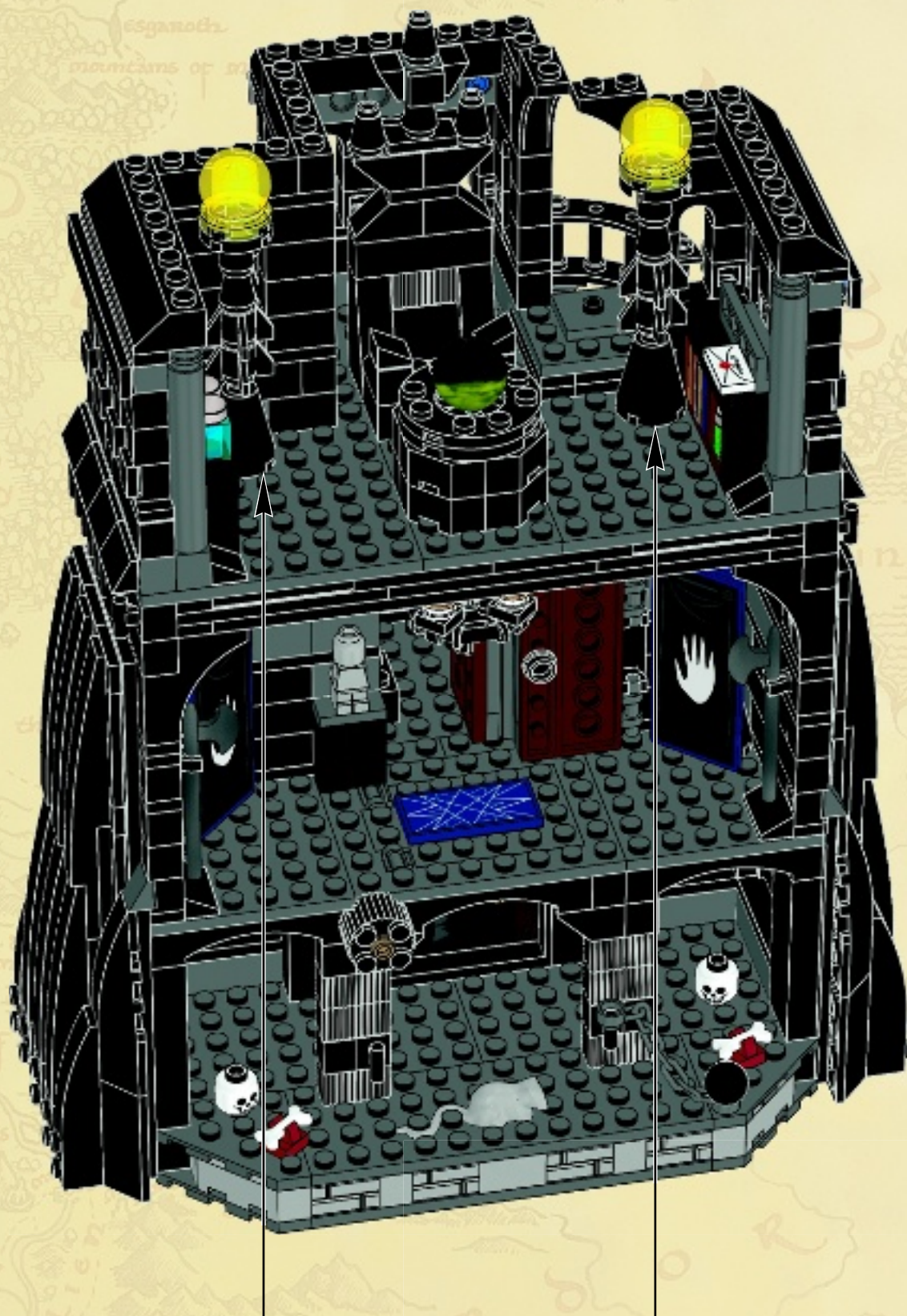



15x



5x

# 69

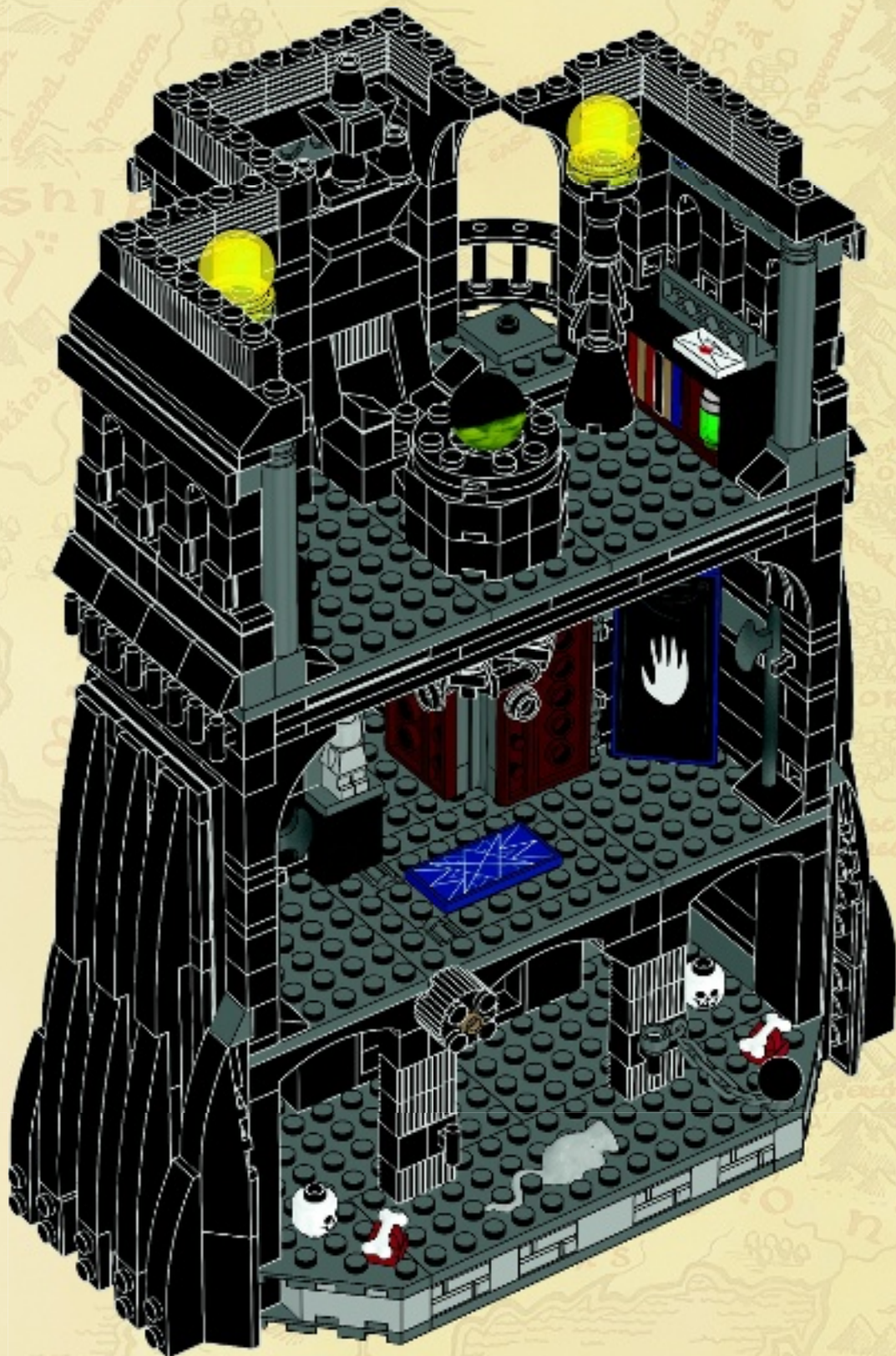



13x



2x



3x

# 70

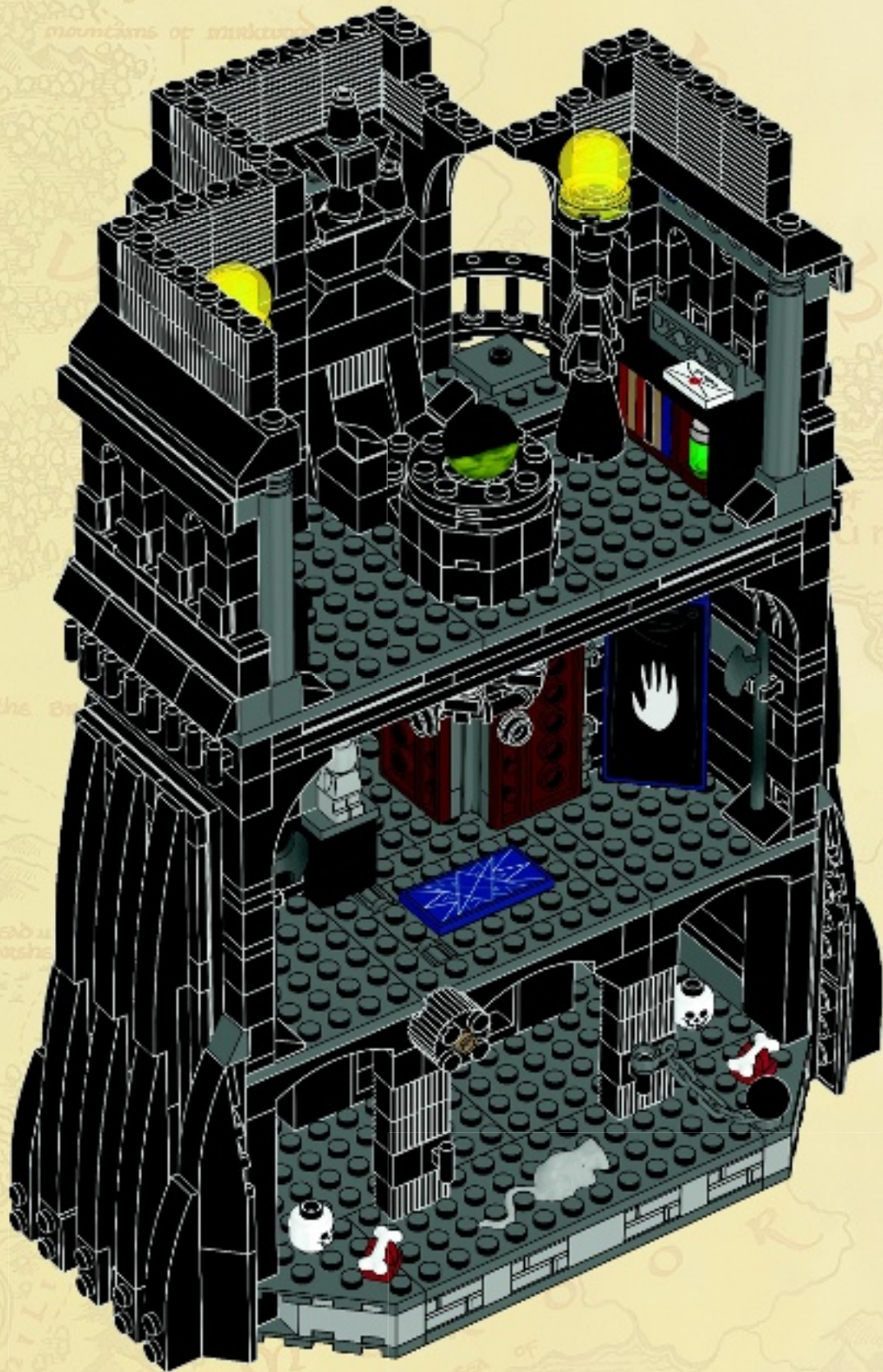

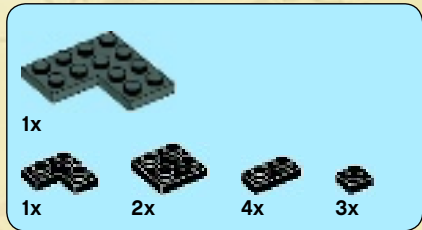

71

1



2



3

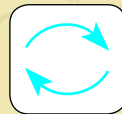
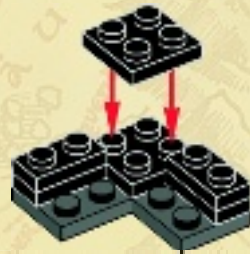

4



5



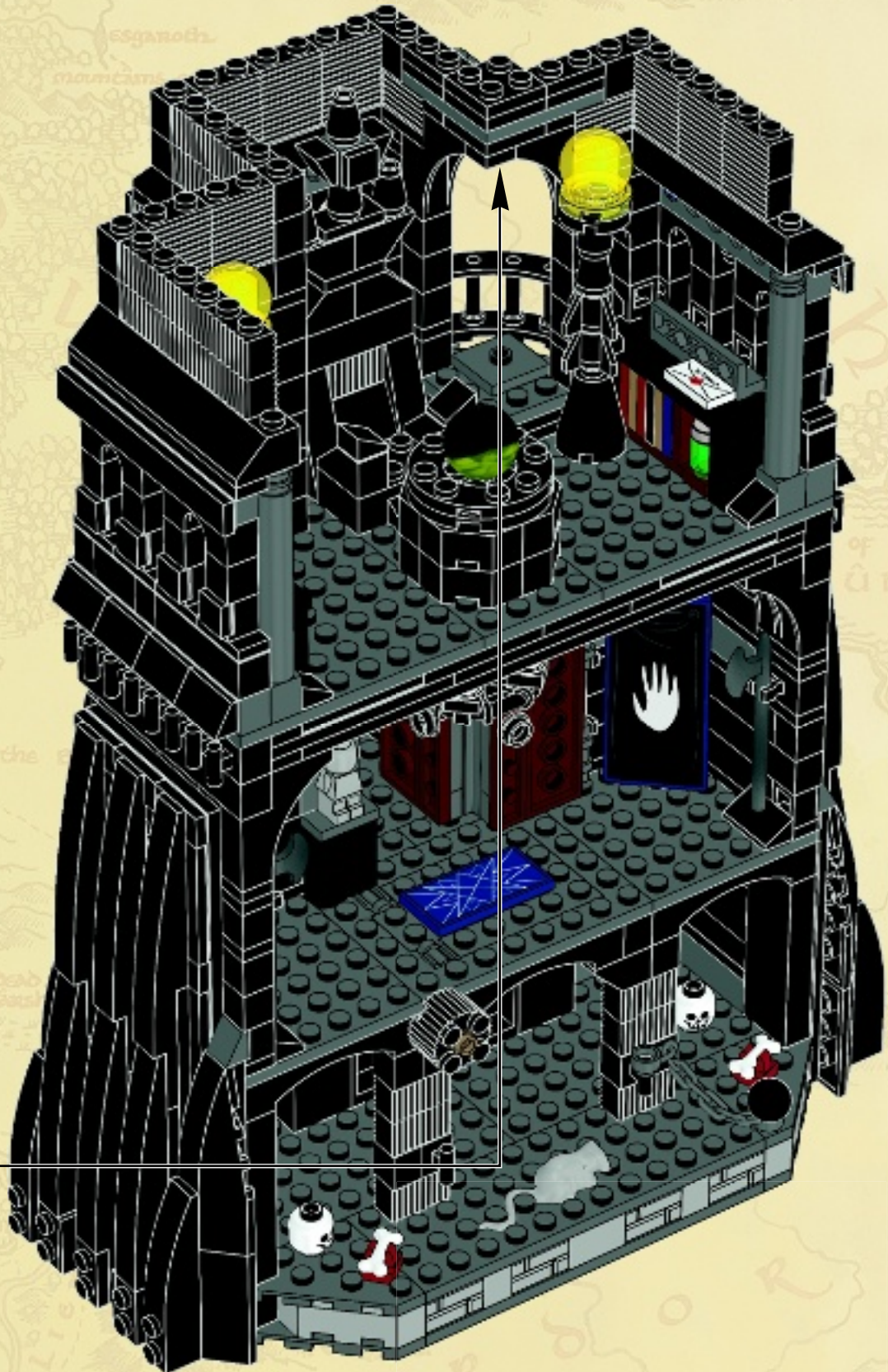

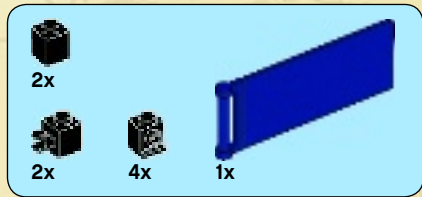

72

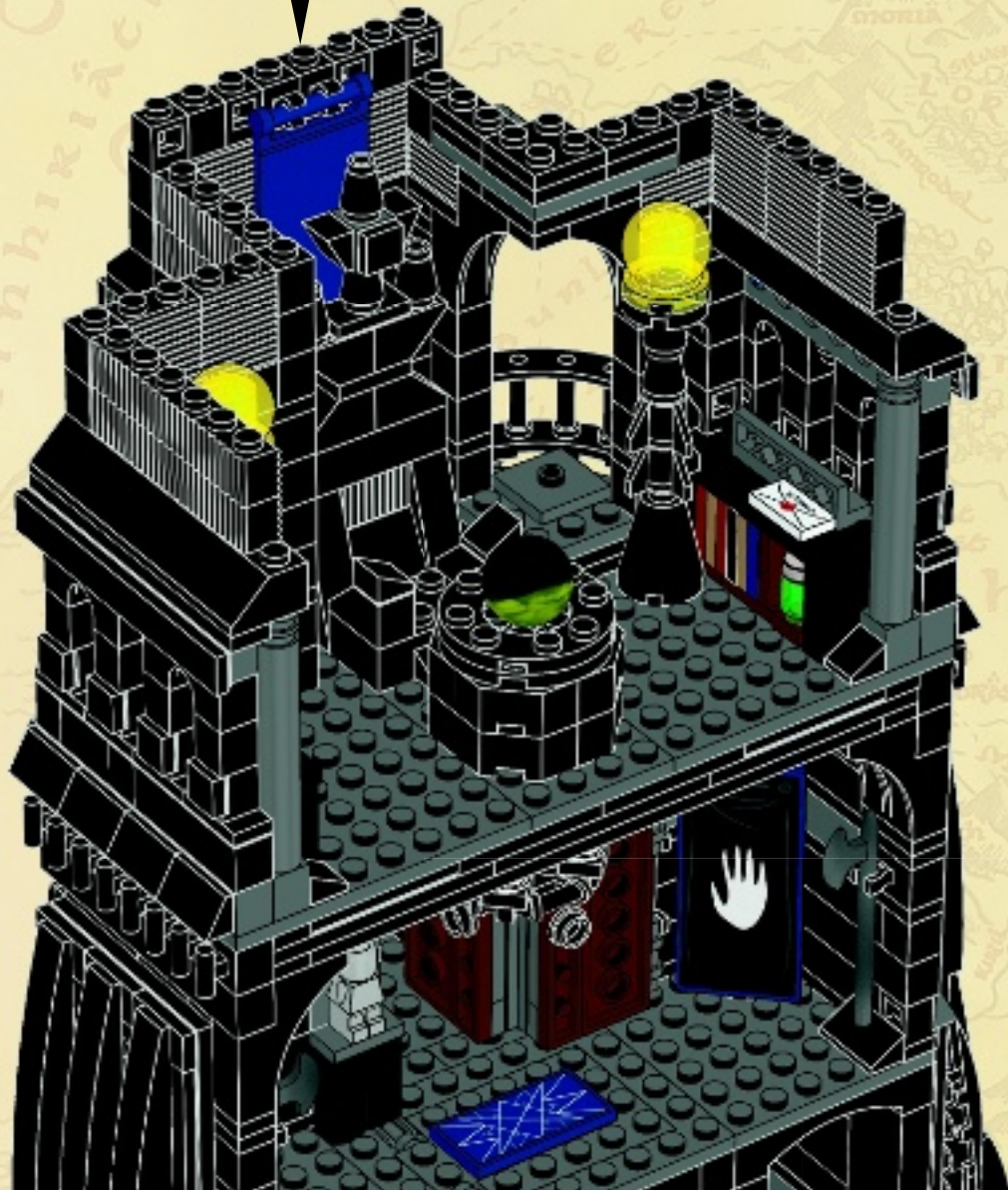
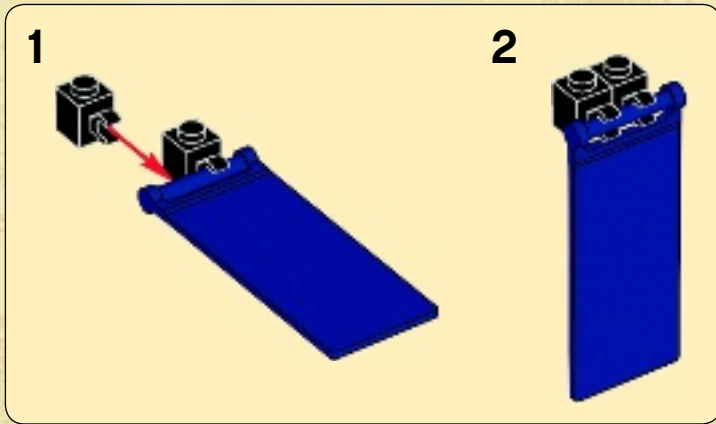



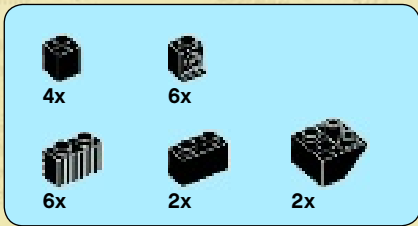

73

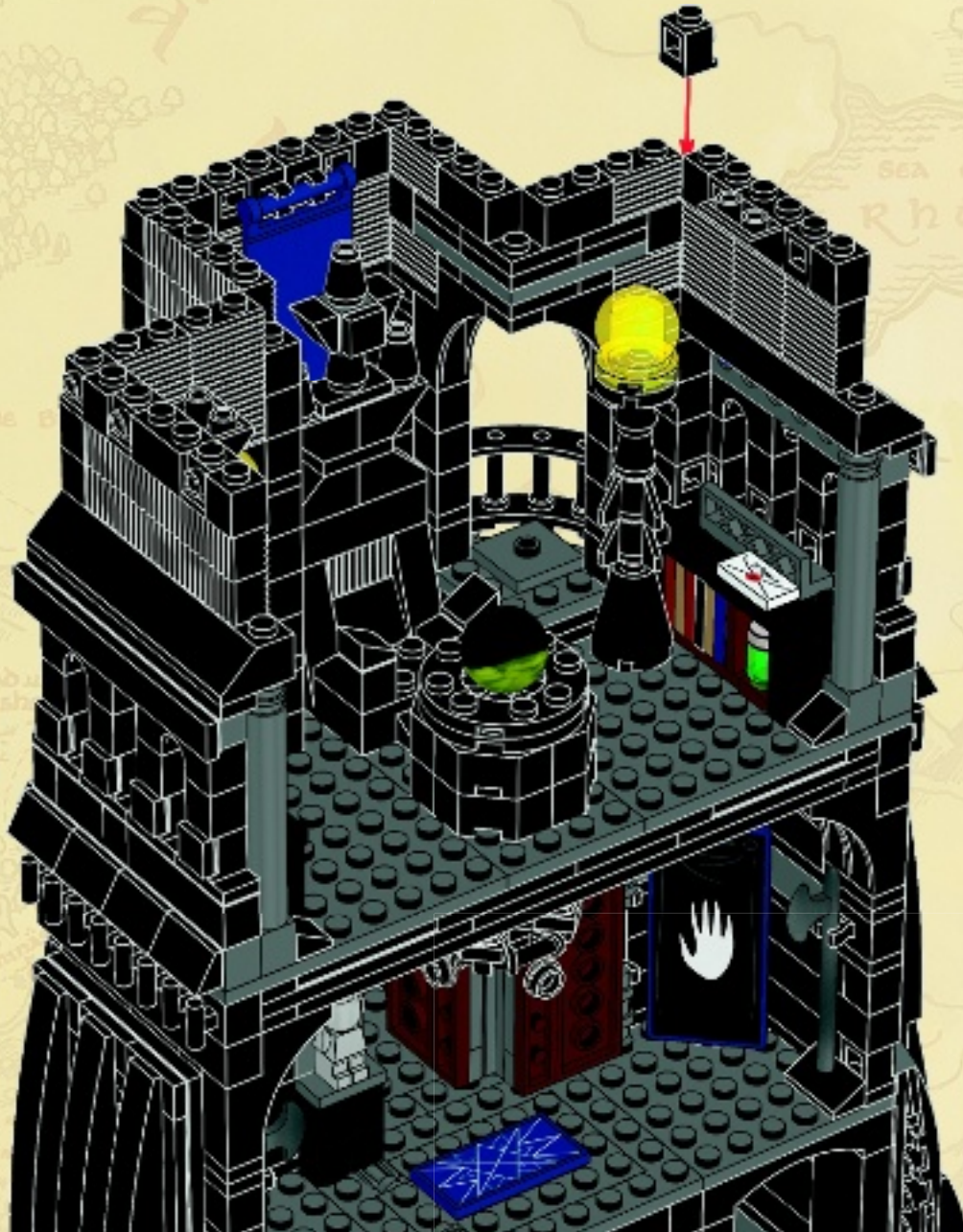

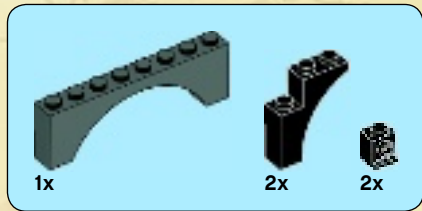

74

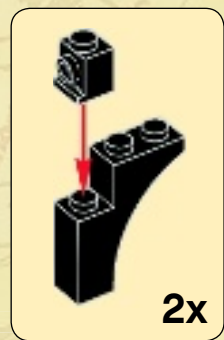

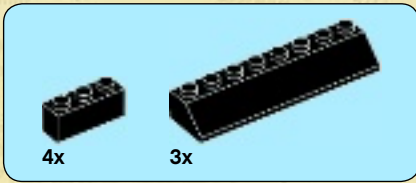

75



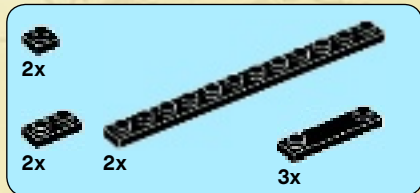

76

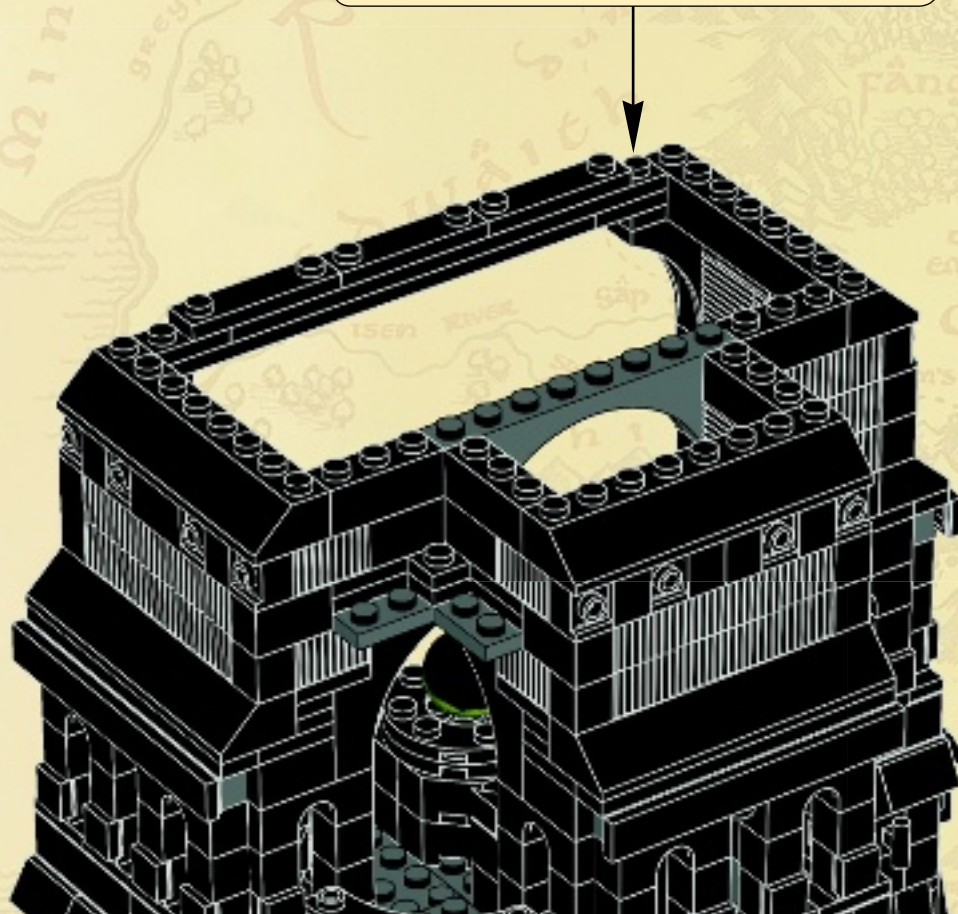
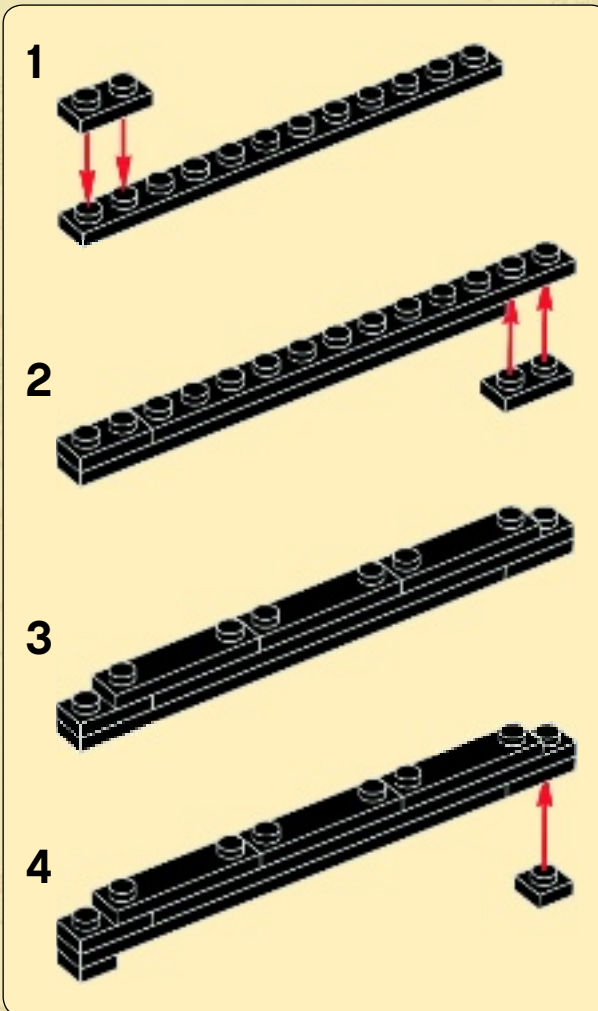



77



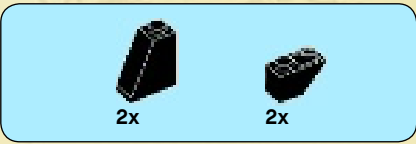

78

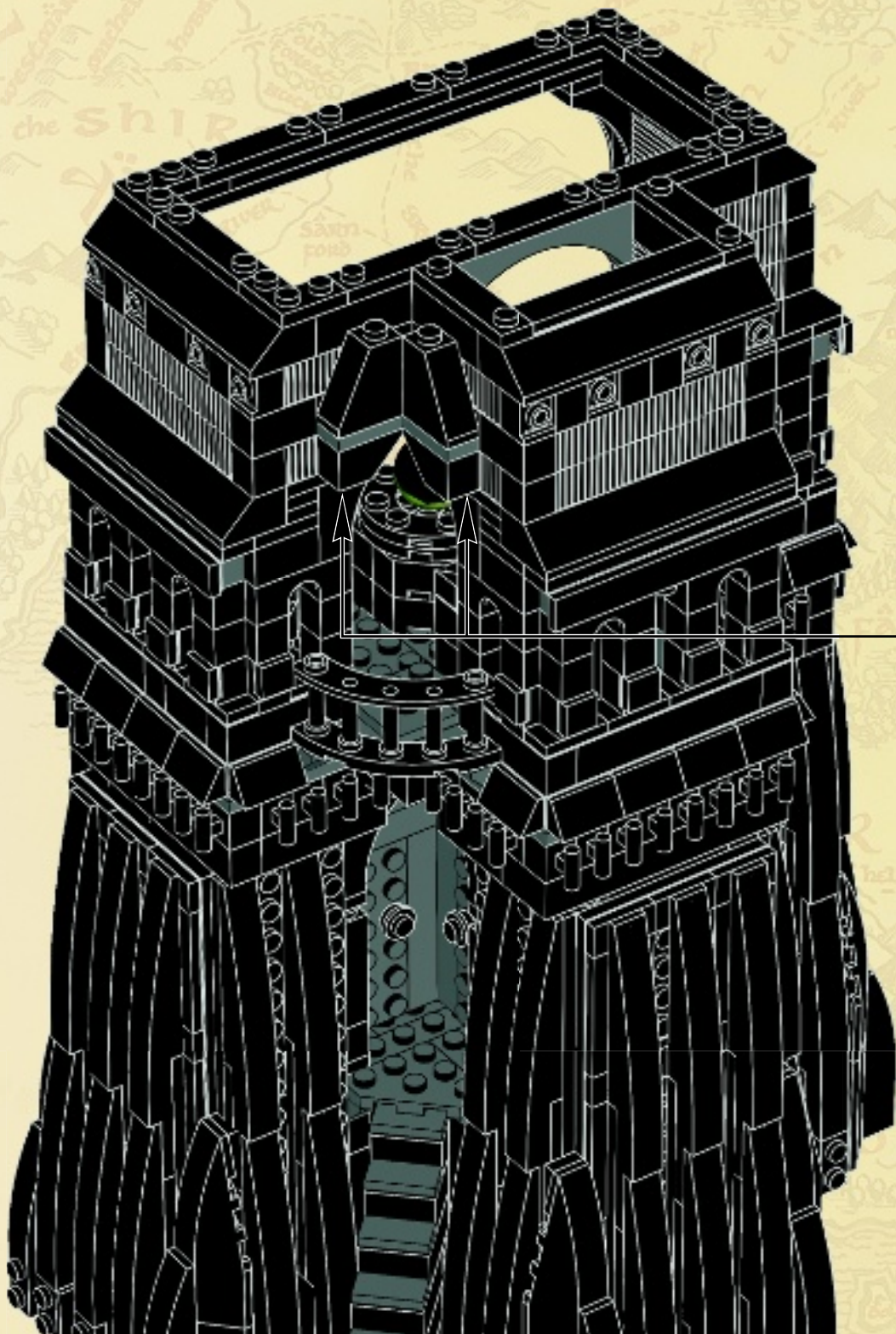

1x  3x  12x 

# 79

1  2 



2  3



# WIN!

Go to [www.LEGOsurvey.com/product](http://www.LEGOsurvey.com/product) to fill out a survey for a chance to win a cool LEGO® Product.

No purchase necessary.

Open to all residents where not prohibited.



## [www.LEGOsurvey.com/product](http://www.LEGOsurvey.com/product)

### GEWINNE!

Nimm an der Umfrage auf [www.LEGOsurvey.com/product](http://www.LEGOsurvey.com/product) teil und hab die Chance ein cooles LEGO® Produkt zu gewinnen!

Die Teilnahme am Gewinnspiel führt zu keinerlei Kaufverpflichtungen. Teilnahme in allen nicht ausgeschlossenen Ländern möglich.

### WIN!

Ga naar [www.LEGOsurvey.com/product](http://www.LEGOsurvey.com/product), vul een enquêteformulier in en maak kans op een cool LEGO® product.

Geen aankoopverplichting. Iedereen mag deelnemen, uitgezonderd ingezetenden van landen waar een enquêteverbod geldt.

### GAGNE!

Visite [www.LEGOsurvey.com/product](http://www.LEGOsurvey.com/product) pour répondre à un questionnaire et avoir une chance de gagner un produit LEGO® très cool!

Aucune obligation d'achat. Ouvert à tous les résidents des pays autorisés.

### 当てよう!

[www.LEGOsurvey.com/product](http://www.LEGOsurvey.com/product) にアクセスして、アンケートにご記入ください。当選者にはレゴ製品を差し上げます。

お買い上げの必要はありません。禁止されていない限り、すべての皆様にご利用いただけます。

LEGO and the LEGO logo are trademarks of the/sont des marques de commerce de/son marcas registradas de LEGO Group.

©2013 The LEGO Group.

THE LORD OF THE RINGS: © NLP™ Middle-earth Ent. Lic. to New Line.  
LE SEIGNEUR DES ANNEAUX: © NLP™ Middle-earth Ent. Lic. à New Line.  
EL SEÑOR DE LOS ANILLOS: © NLP™ Middle-earth Ent.; uso autorizado a New Line.  
(s13)