



# CREATOR

10254



[LEGO.com/creator](http://LEGO.com/creator)

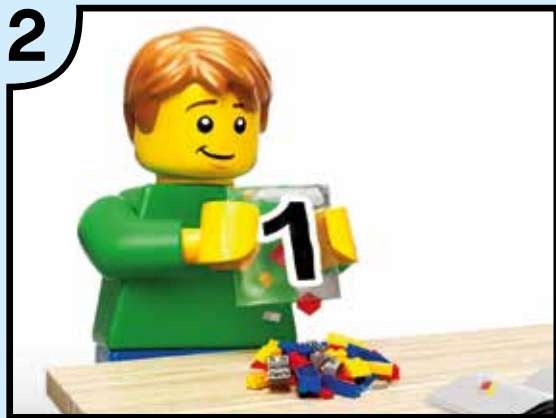

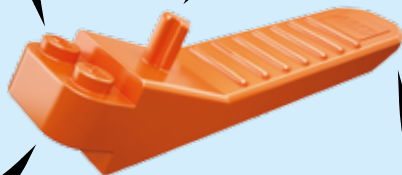
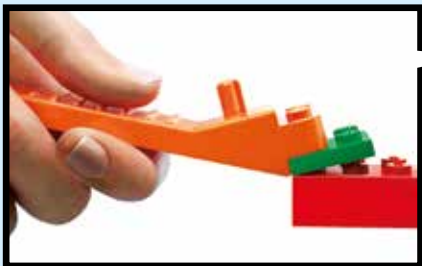

[LEGO.com/brickseparator](https://LEGO.com/brickseparator)

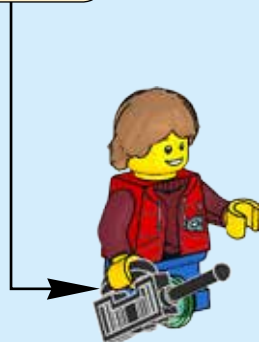

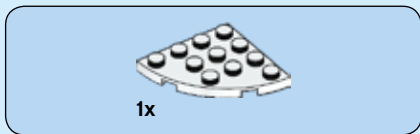

1

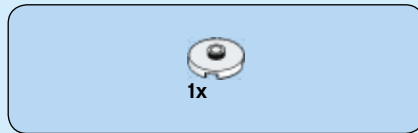

2

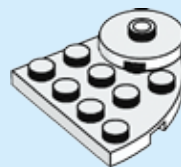



1x



1x

3

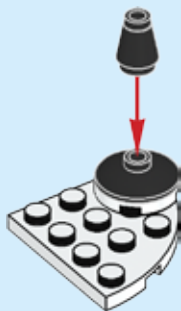

1x



1x

4

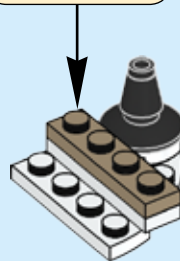
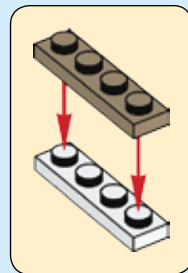



1x

# 5

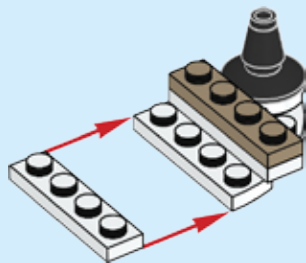

1x



1x

# 6

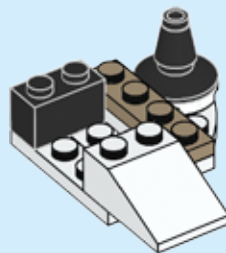

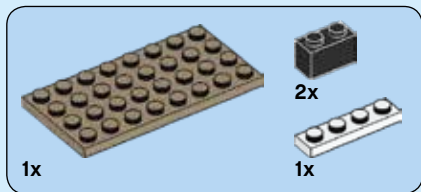

7

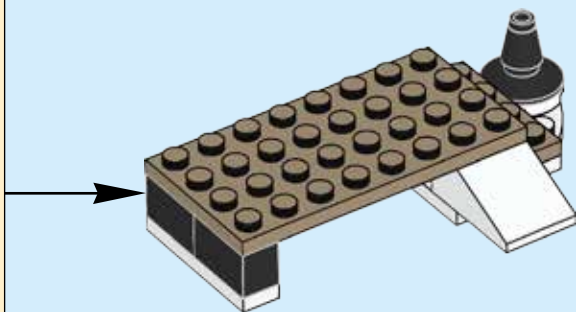
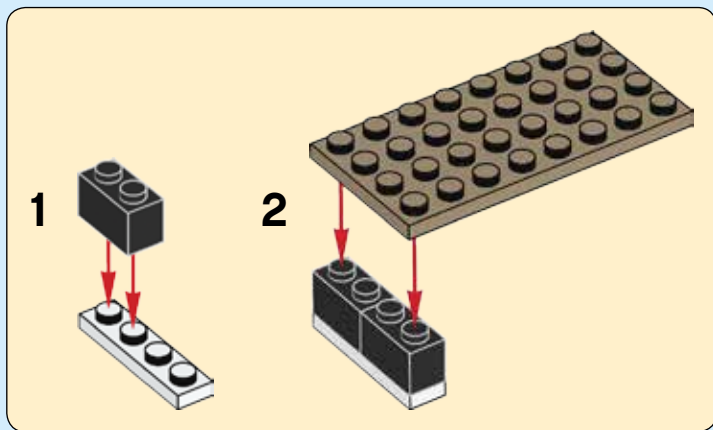

8





4x



2x

8

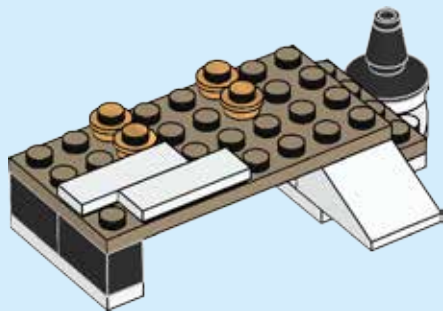

2x

9

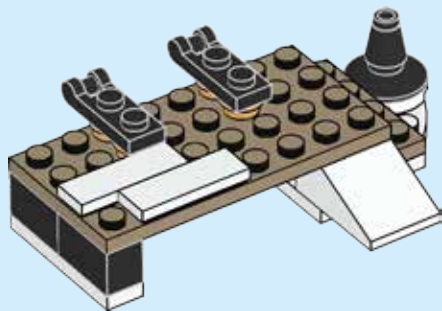

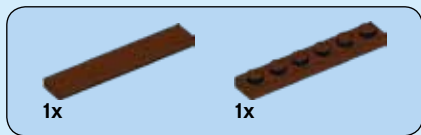

10

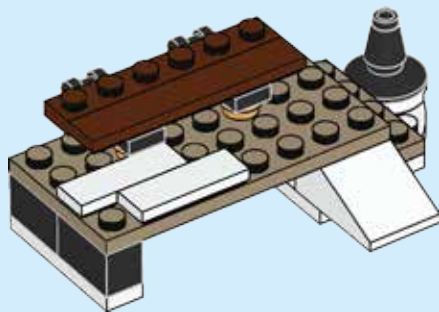

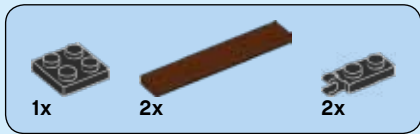

11

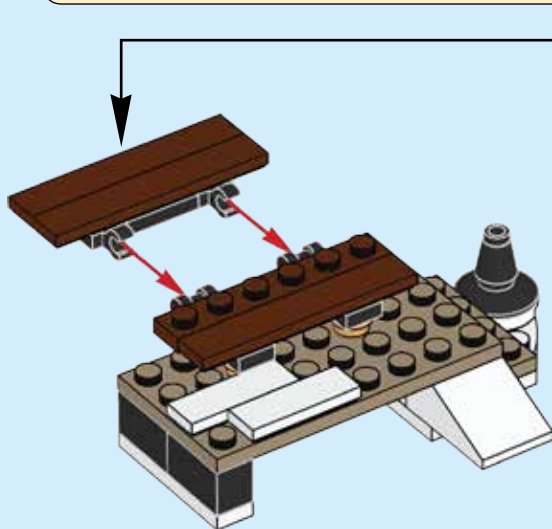
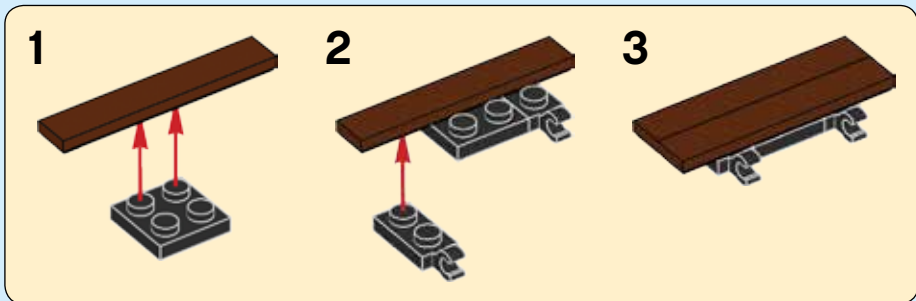

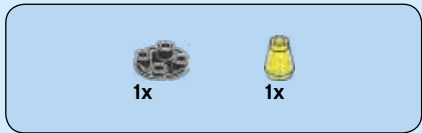

12

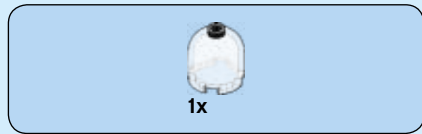

13





1x



1x

# 14



2x

# 15

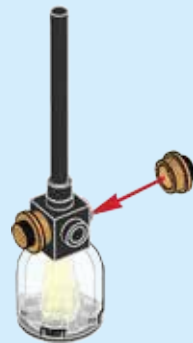



16

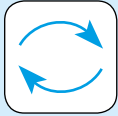

17

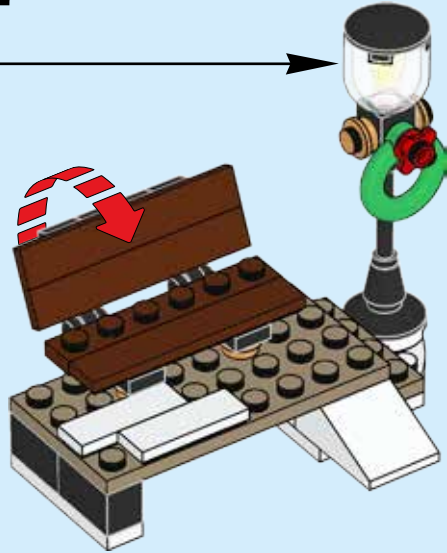



18





# 19

1

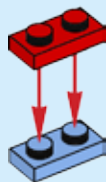

2

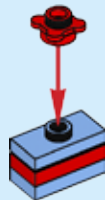



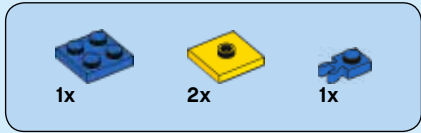

# 20

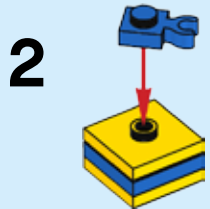
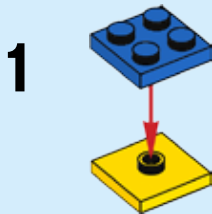

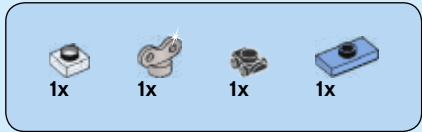

# 21

1

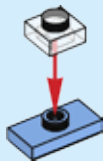

2

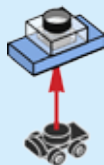

3



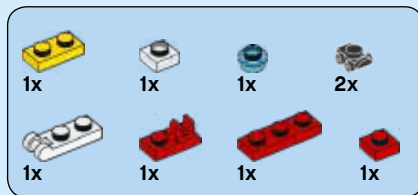

# 22

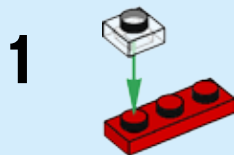

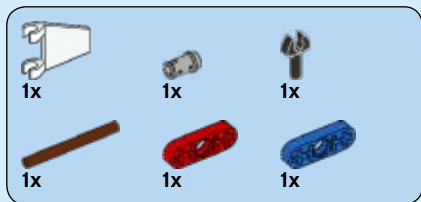

# 23

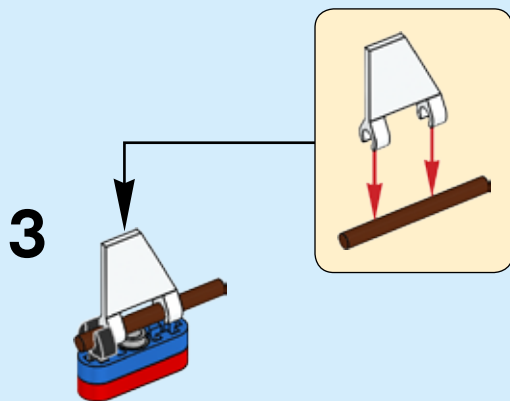
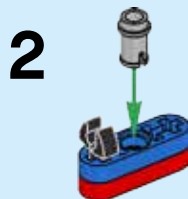
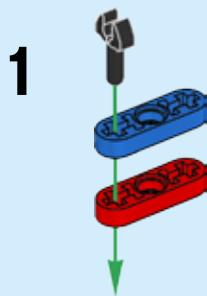



# 24

1

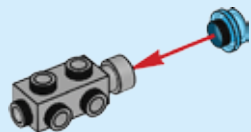

2



3

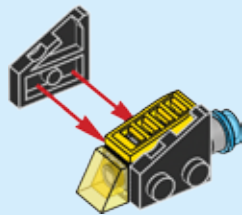

4

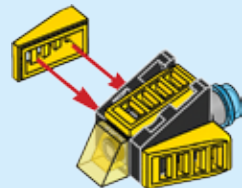

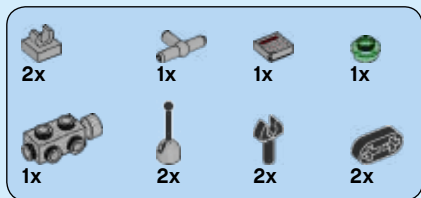

# 25

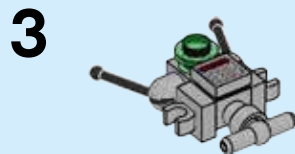
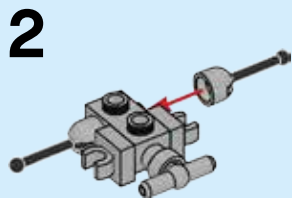
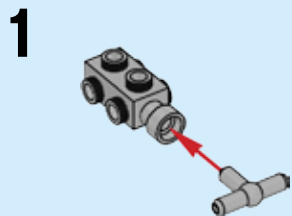

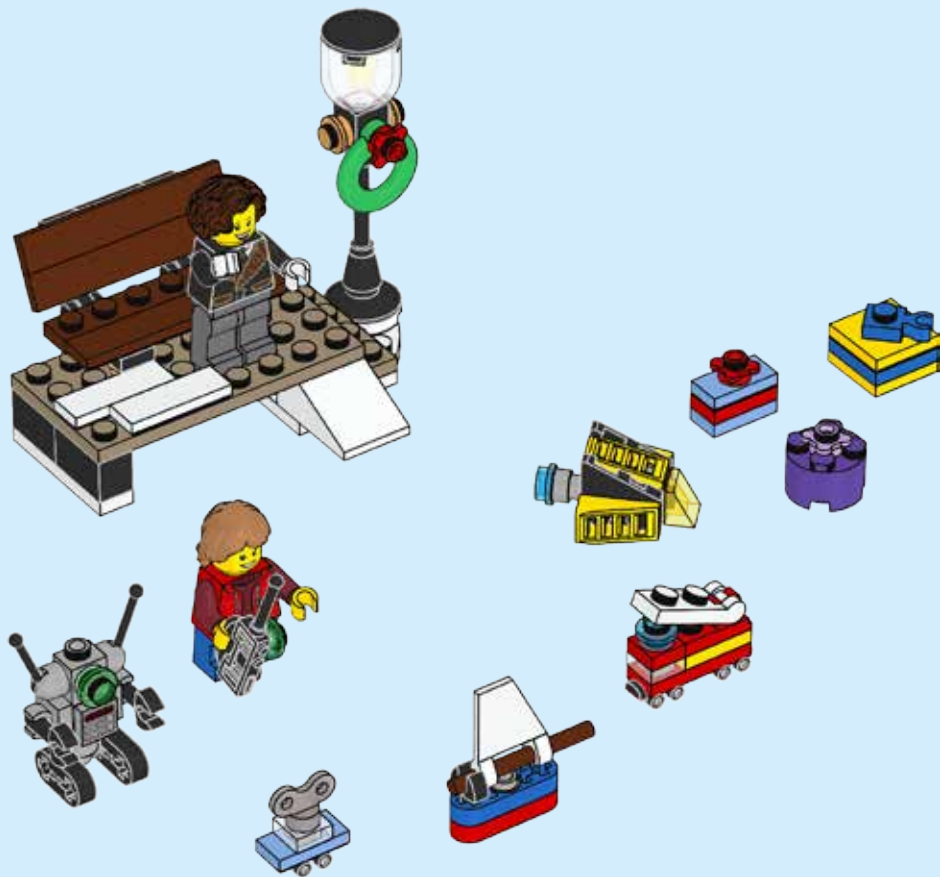



# CREATOR

LEGO and the LEGO logo are trademarks of the/son des marques de commerce  
du/son marcas registradas de LEGO Group. ©2016 The LEGO Group.  
6179160



Apple and the Apple logo are trademarks of Apple Inc., registered in the U.S. and other countries.  
App Store is a service mark of Apple Inc.

Google Play is a trademark of Google Inc.

[LEGO.com/creator](http://LEGO.com/creator)

