

FAIRGROUND COLLECTION
HAUNTED
HOUSE





Los diseñadores (de izquierda a derecha):

- Niek "Codos" van Slagmaat
- Milan "Pimienta" Madge
- Carl "Perro Loco" Merriam
- Michael "Mike" Psiaki
- Austin "Fotitos" Carlson

Lo logramos.

Esta expedición ha sido... sobrenatural, por decir algo. Después de Día 204
20 días, la fiebre casi acaba conmigo. Un par de semanas después, por
poco me aniquila la Maldición de la Momia. Cada vez que colcaba un
ladrillo, ¡parecía haber pasado otra semana!
Afortunadamente, no estaba solo en esta empresa me acompañaban mis leales
compañeros de aventura. Estaría perdido sin su ayuda. Después de tantos callejones
sin salida y tantísimos contratiempos, ¡por fin! La mansión está acabada.

- Carl Merriam, jefe de la expedición
P.D. ¡Seguid construyendo!

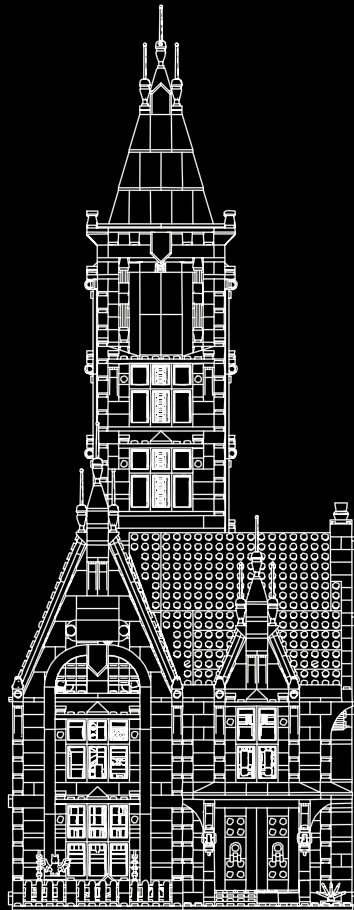

MANSIÓN VON BARRON

La mansión Von Barron es un tenebroso juego mecánico instalado en un parque temático.

Fue el hogar de Samuel von Barron: uno de los más grandes villanos del mundo. Viajó por todo el mundo en busca de antigüedades que pudiera robar e incluir en su colección.

¡Aunque tal vez robó demasiadas! Cuando Von Barron se apoderó del rubí Re-Gou, el faraón Hotep maldijo su mansión durante 1000 generaciones. Te invitamos a entrar... ¡si te atreves!

Lee la historia completa en:

LEGO.COM/HAUNTEDHOUSE

Compatible con Powered Up



10273



88009



88008 x2



LEGO® Powered Up
LEGO.com/apps



DESCARGA GRATIS LA APP

MOTORES ELÉCTRICOS

SE REQUIERE UN DISPOSITIVO INTELIGENTE (NO INCLUIDO).

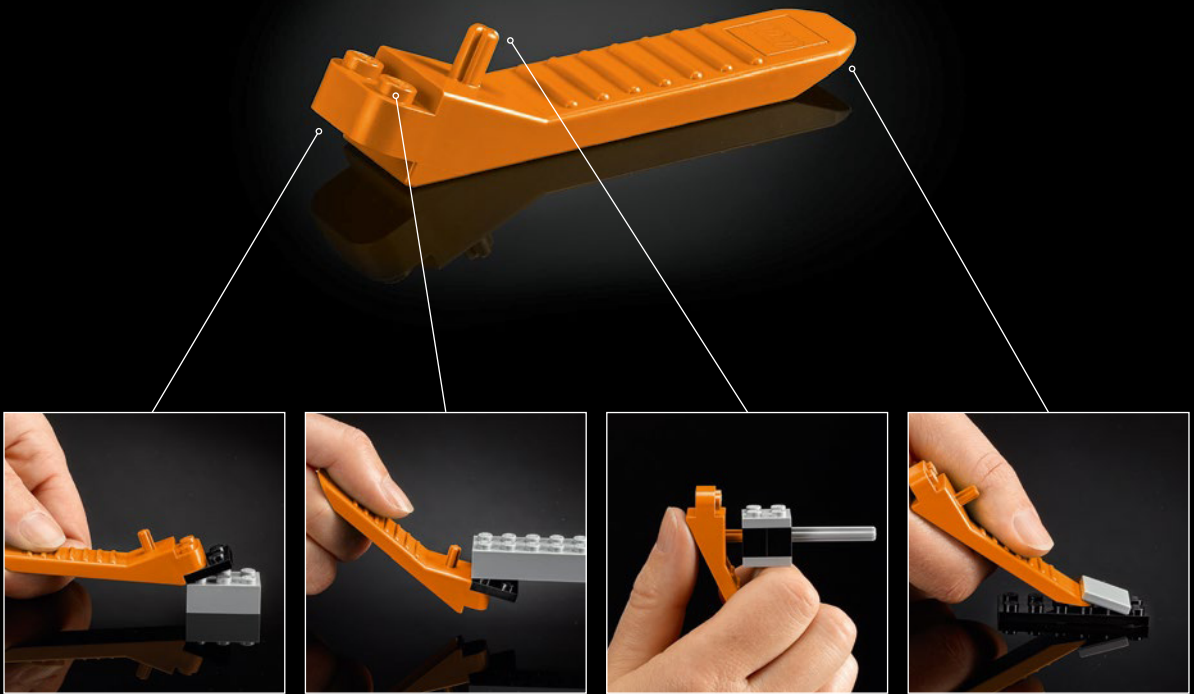

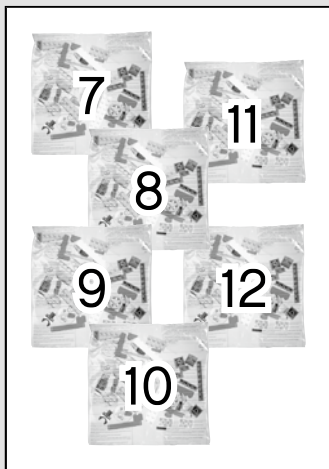
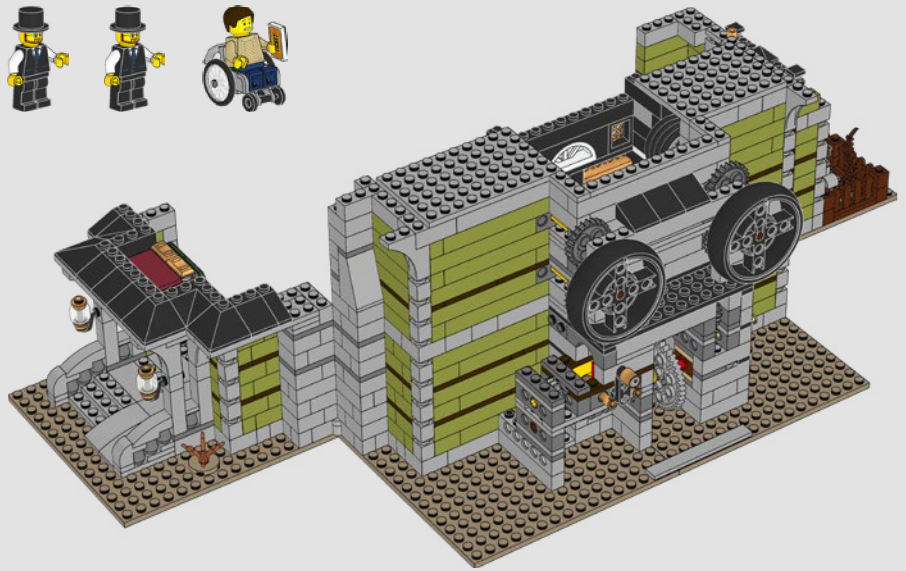
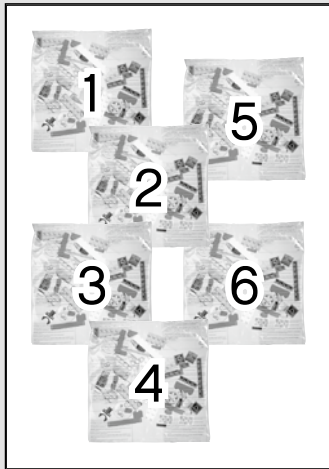

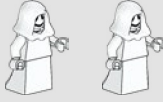
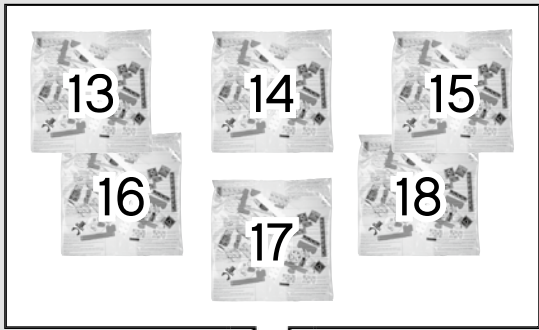

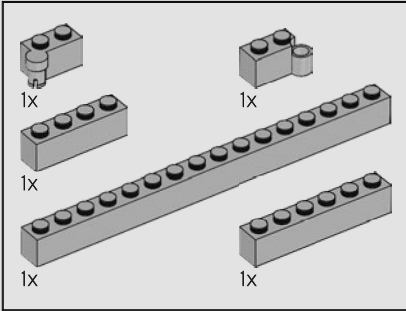
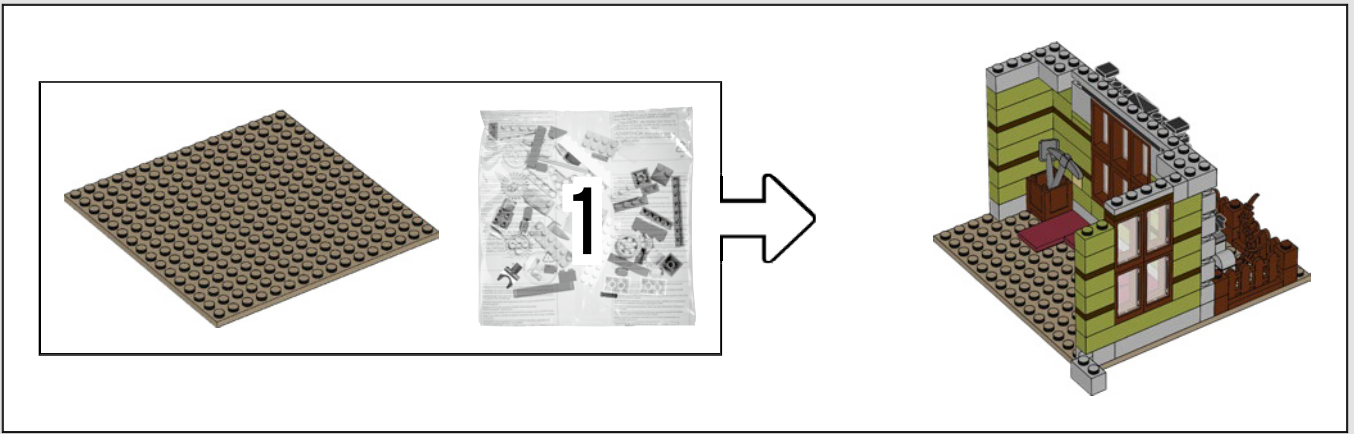

1

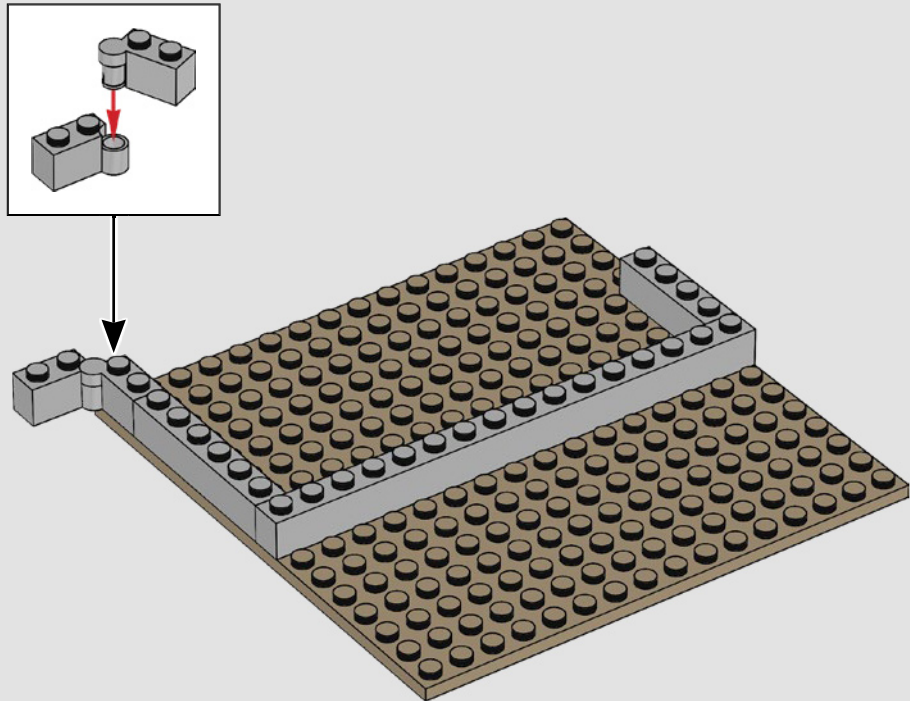

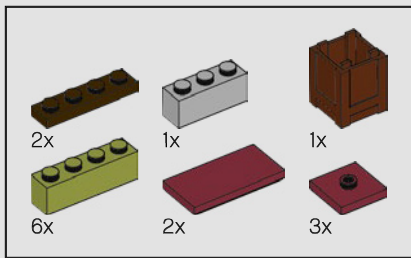

2

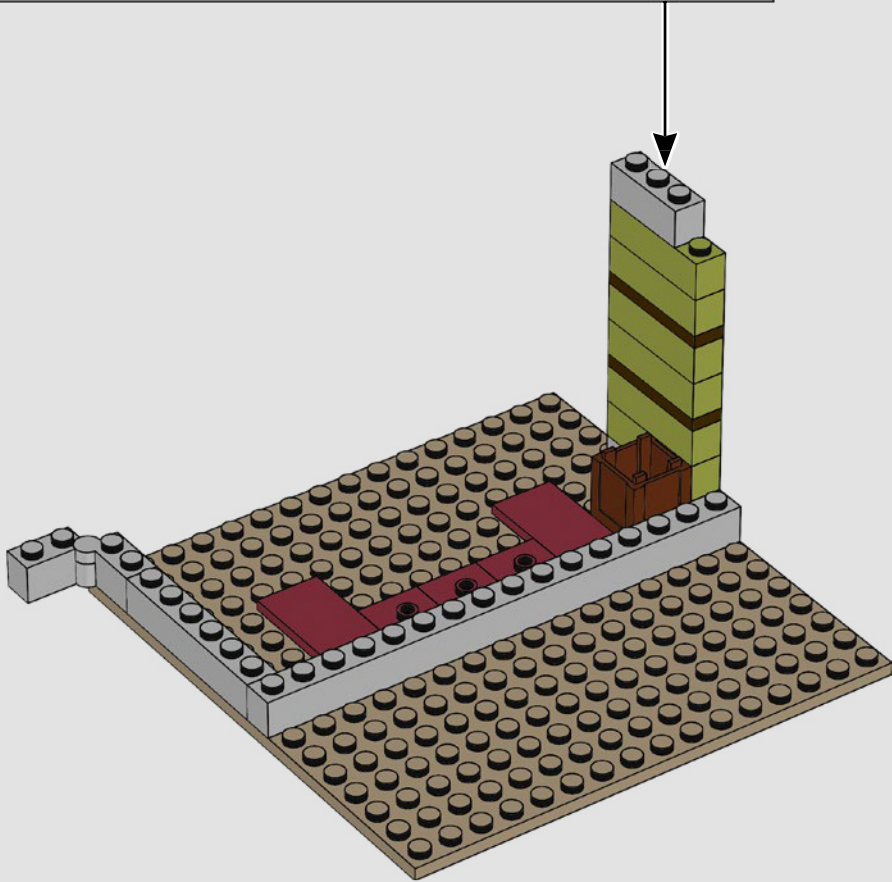
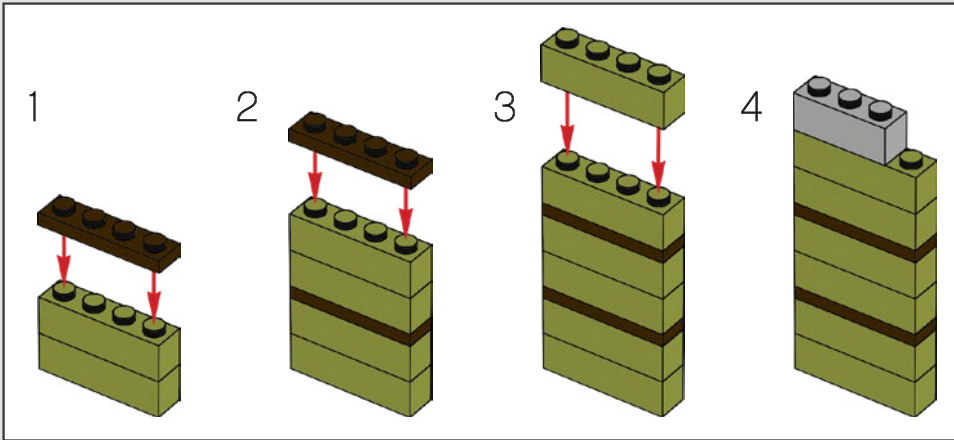

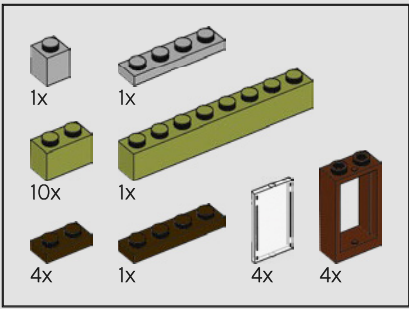

3

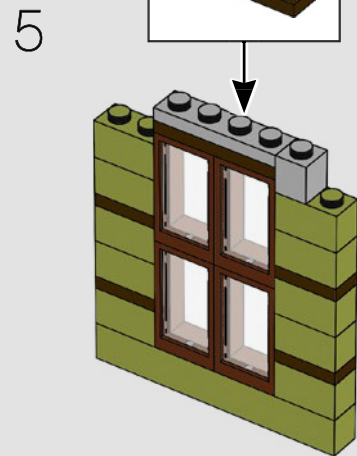
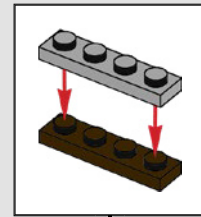
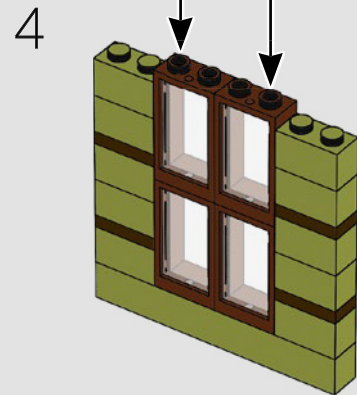
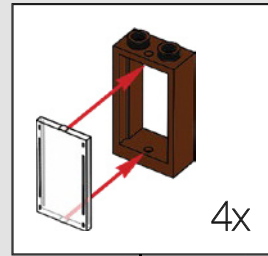
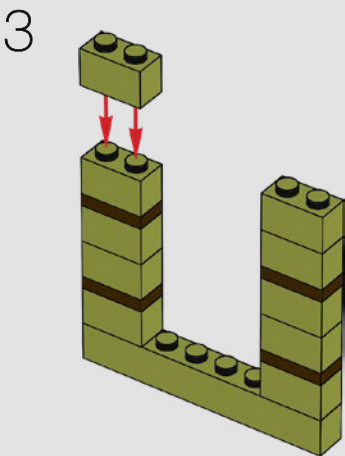
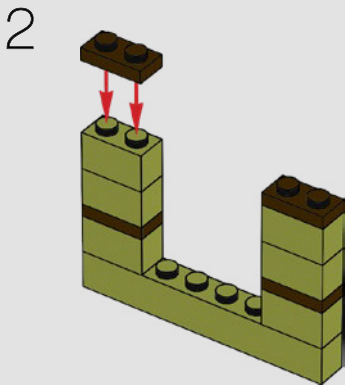
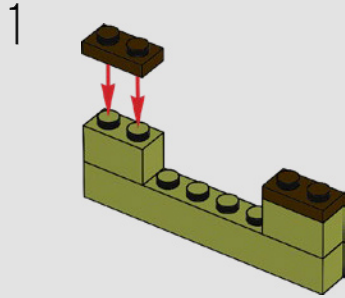

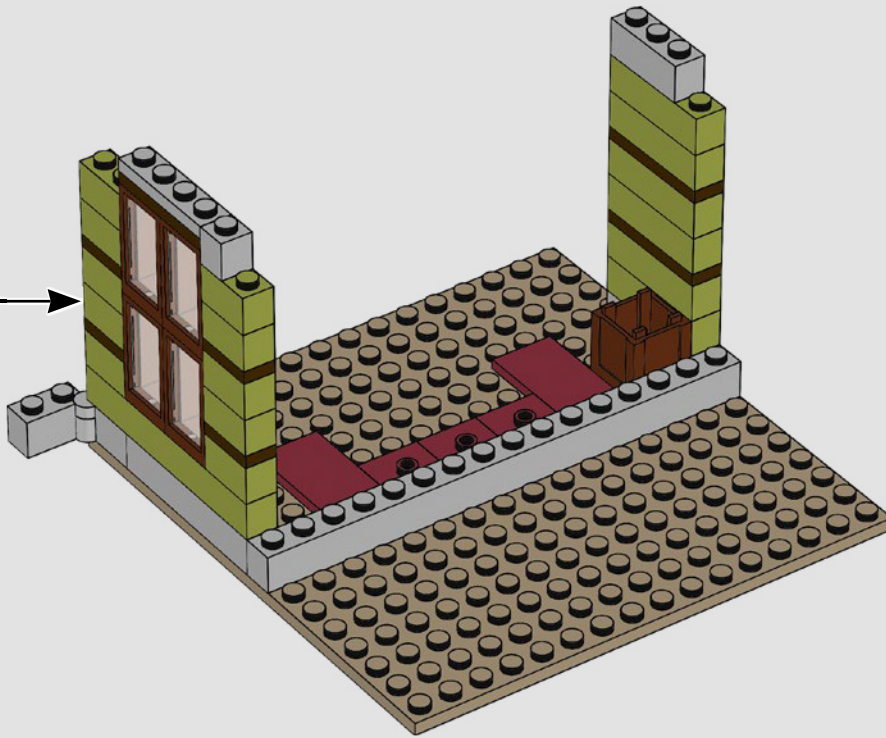

4

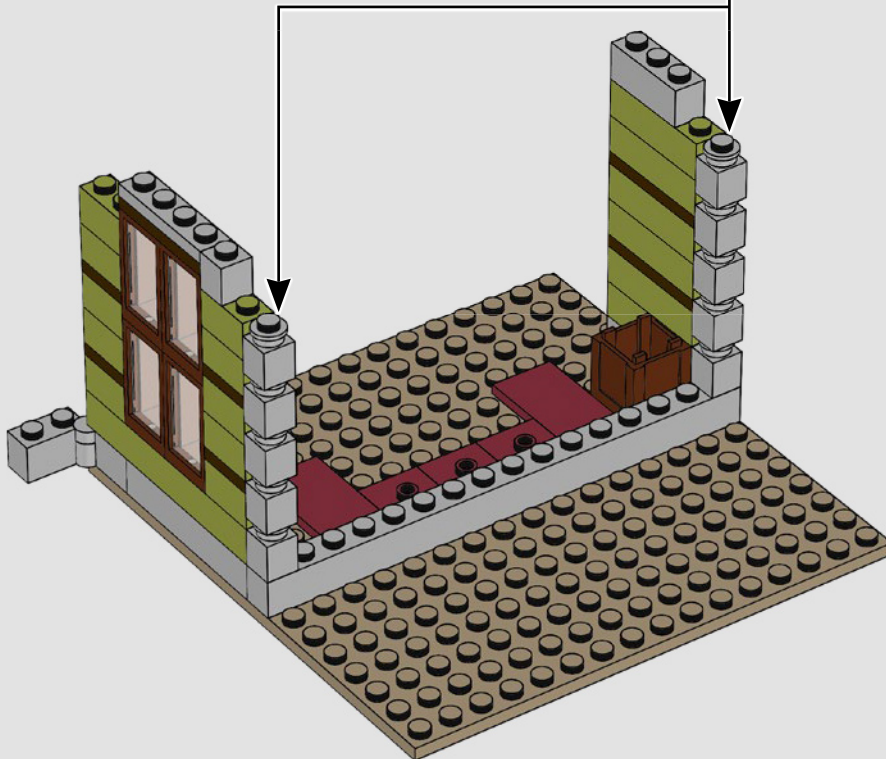
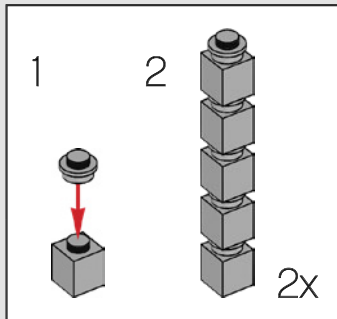

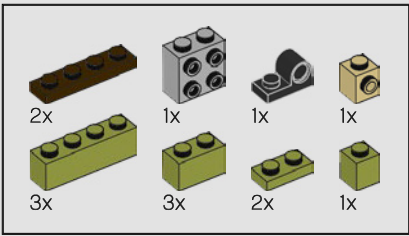

5

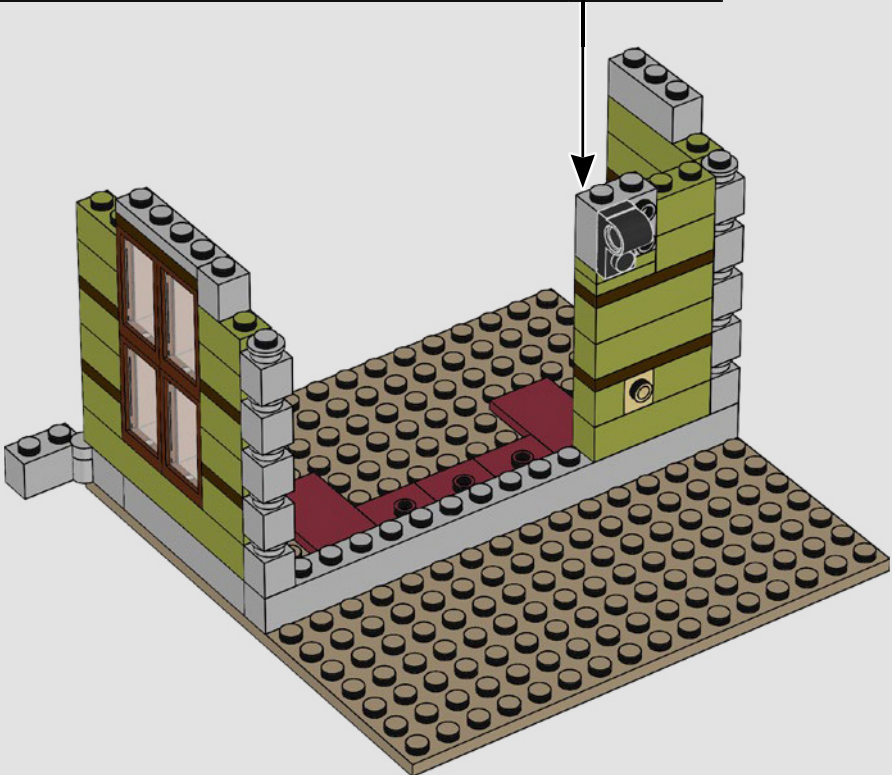
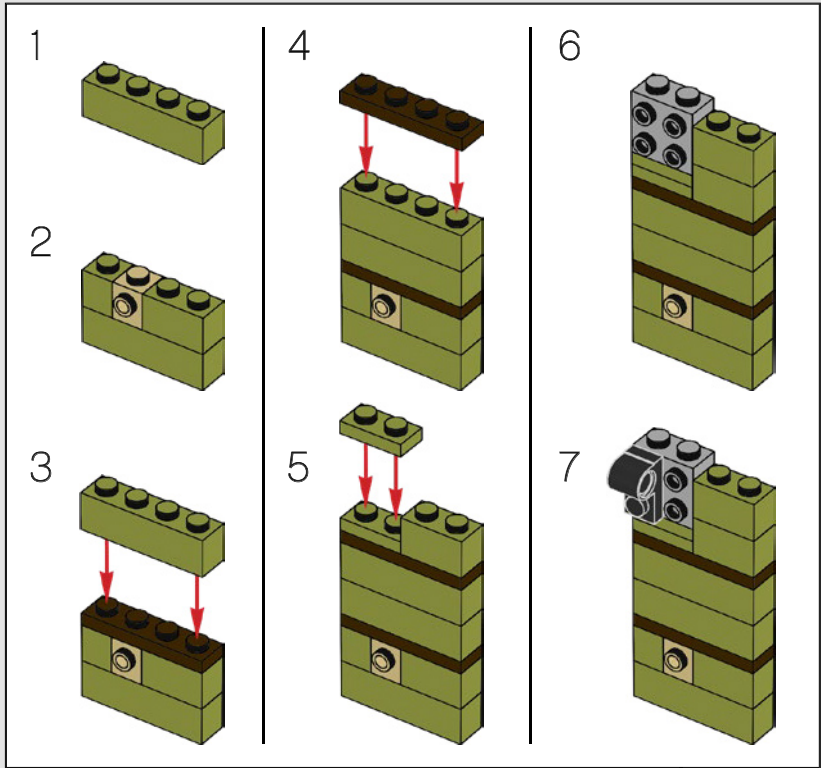

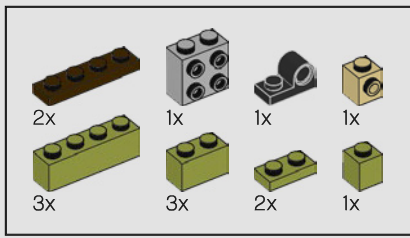

6

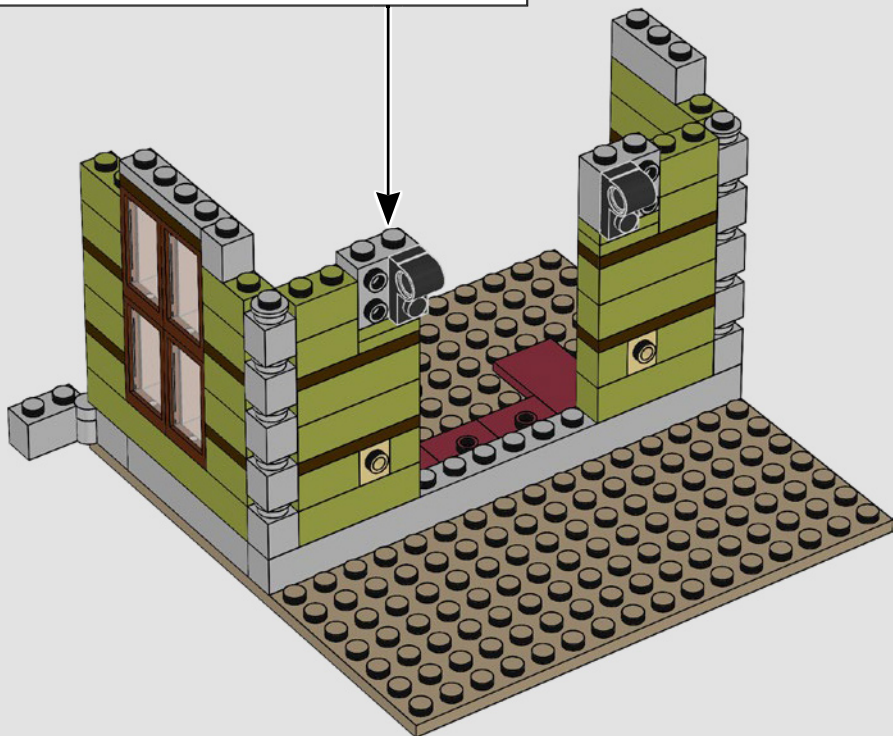
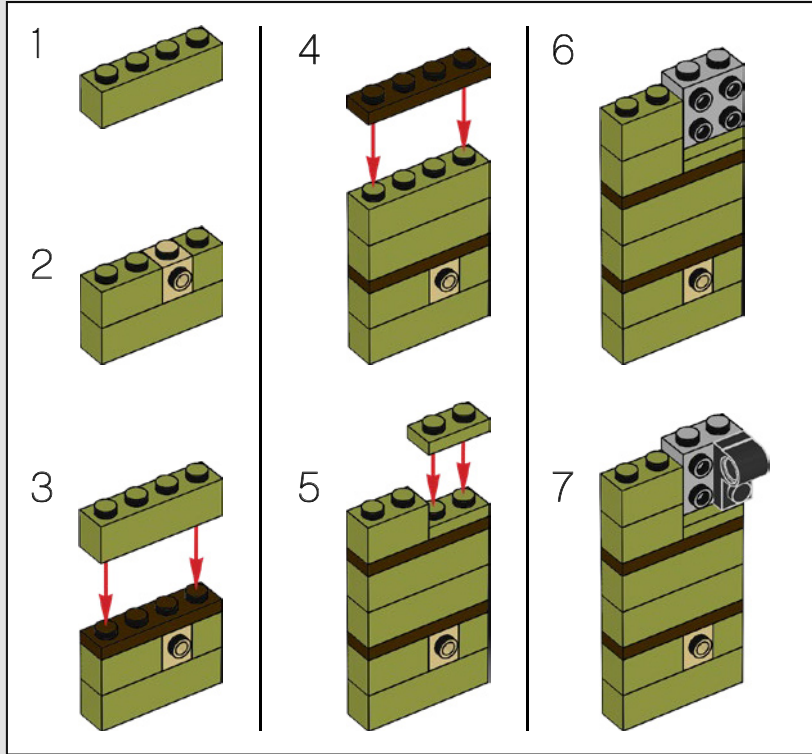

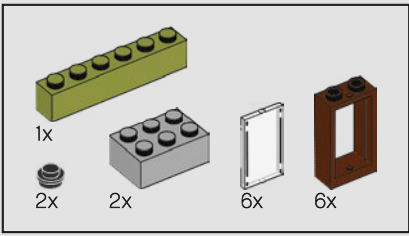

7

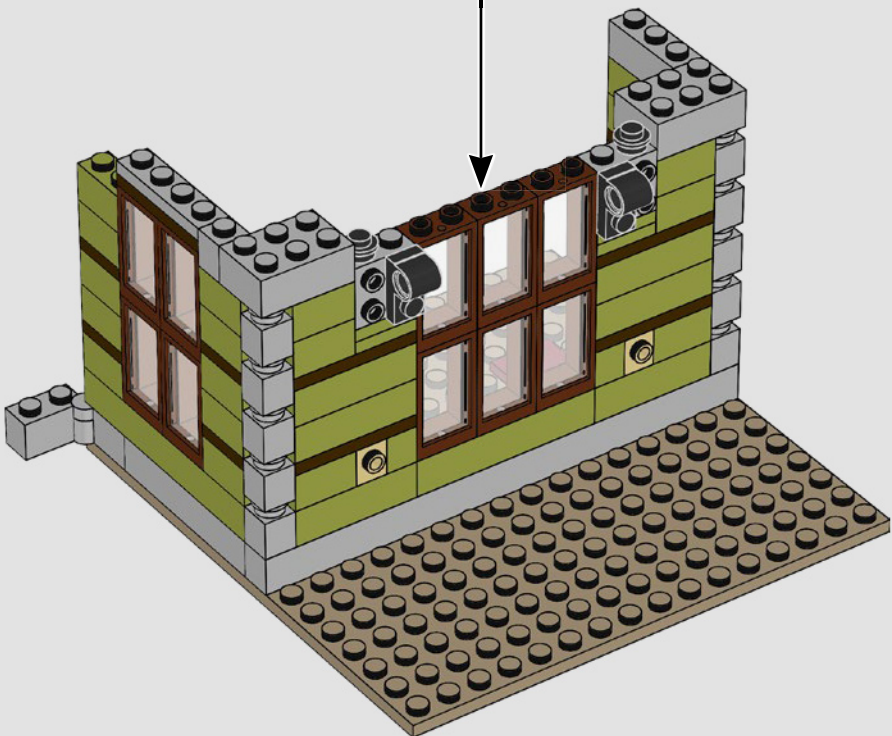
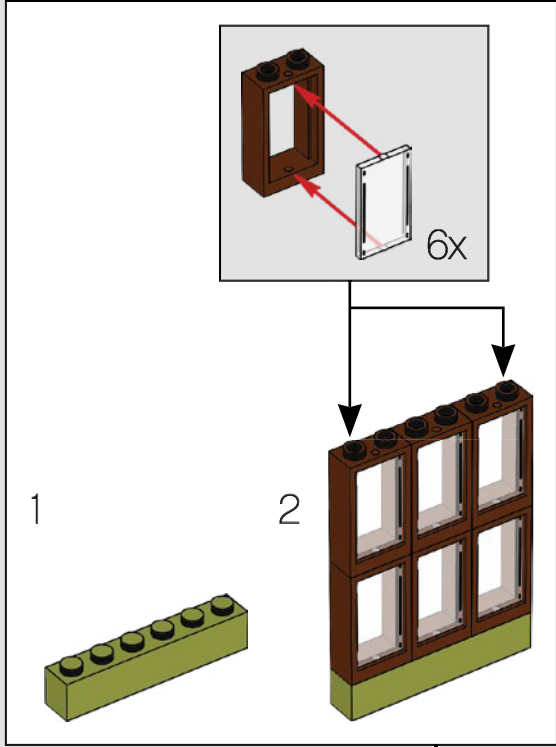

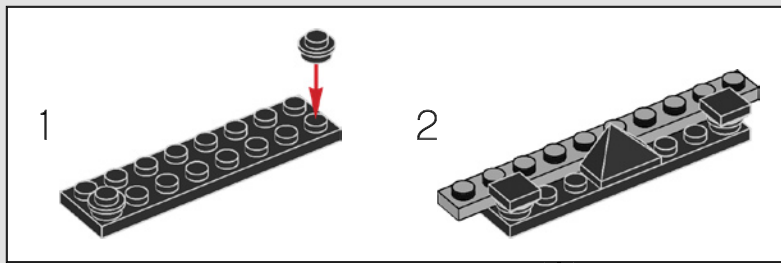
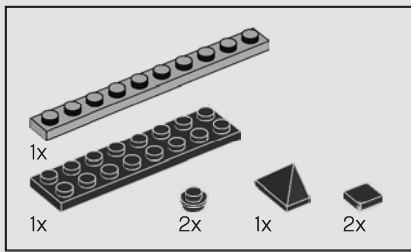

8

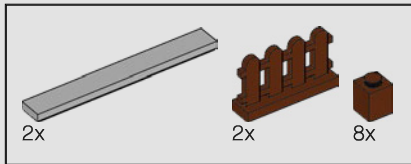
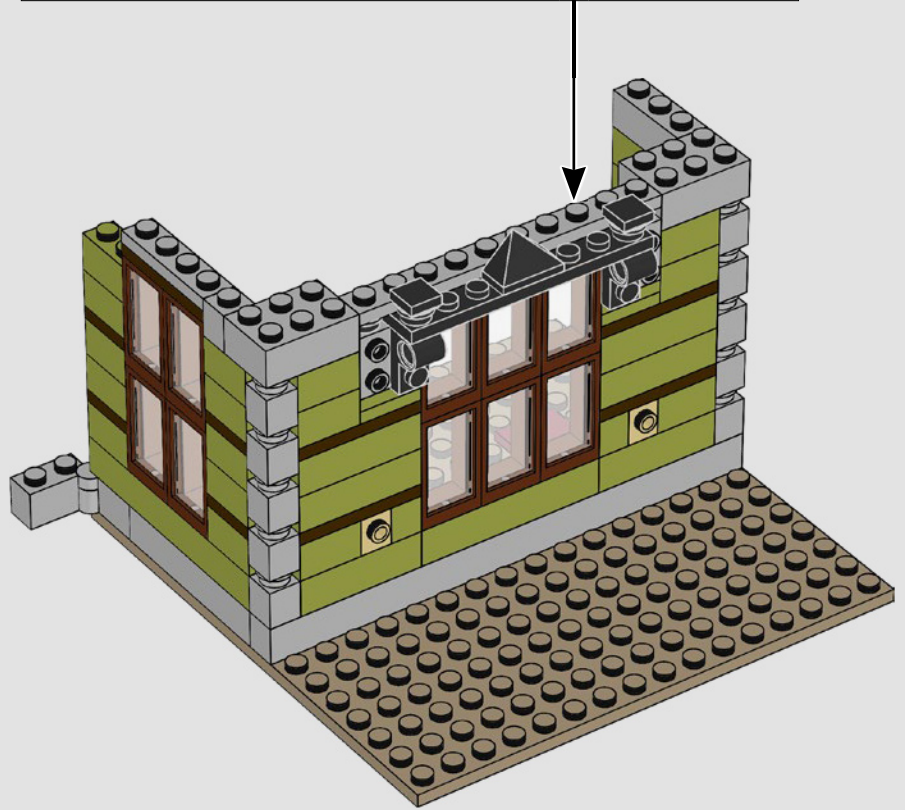

9

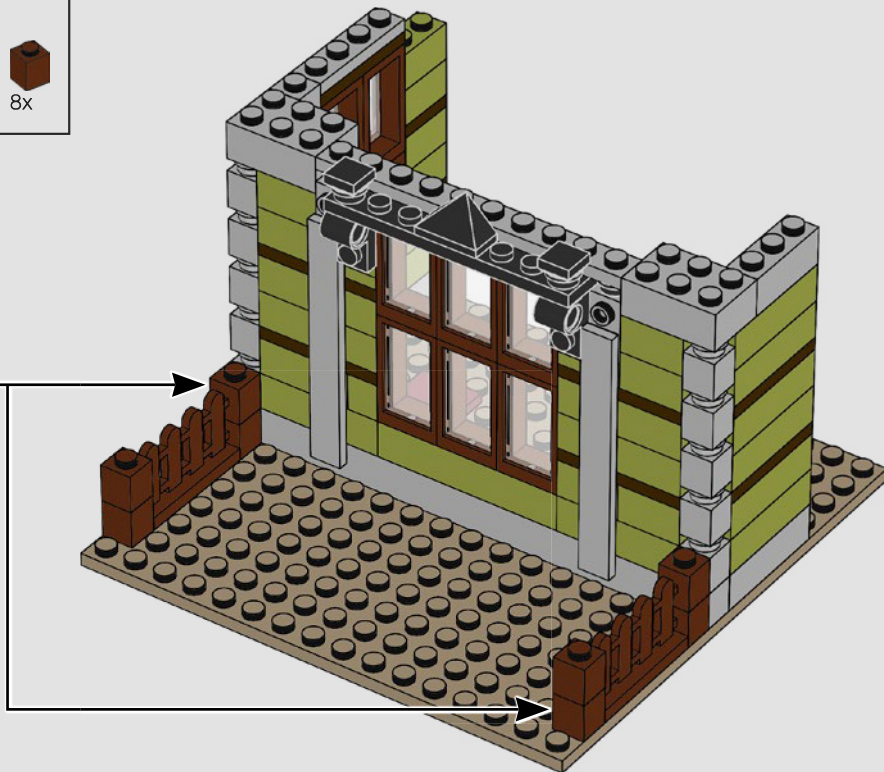
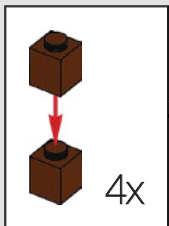

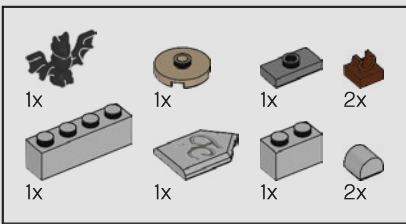

10

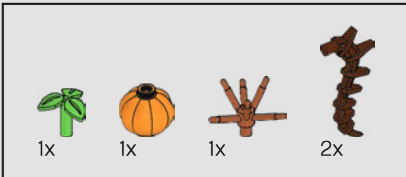
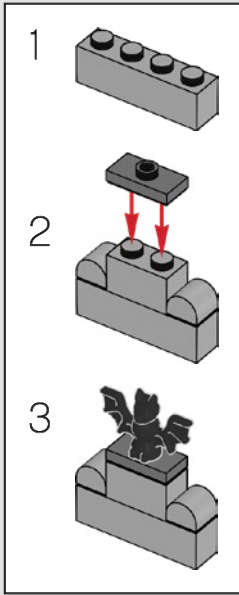

11

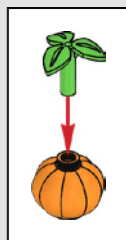

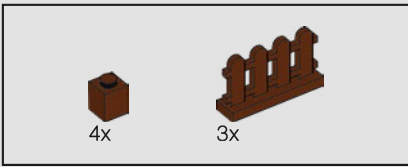

12

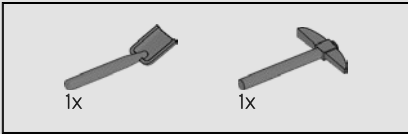
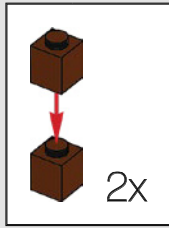

13

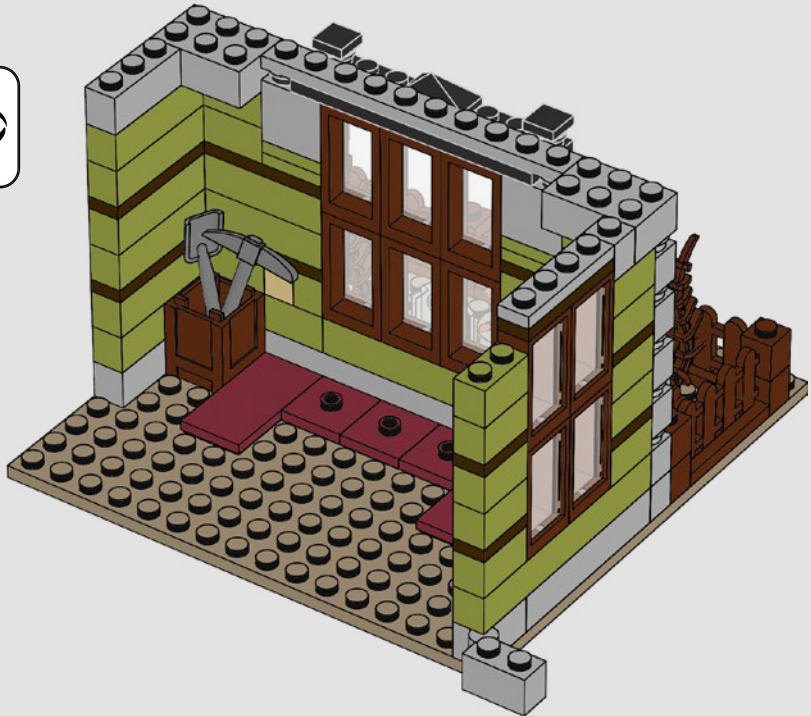

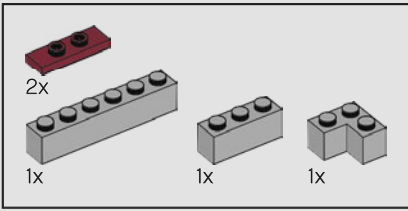
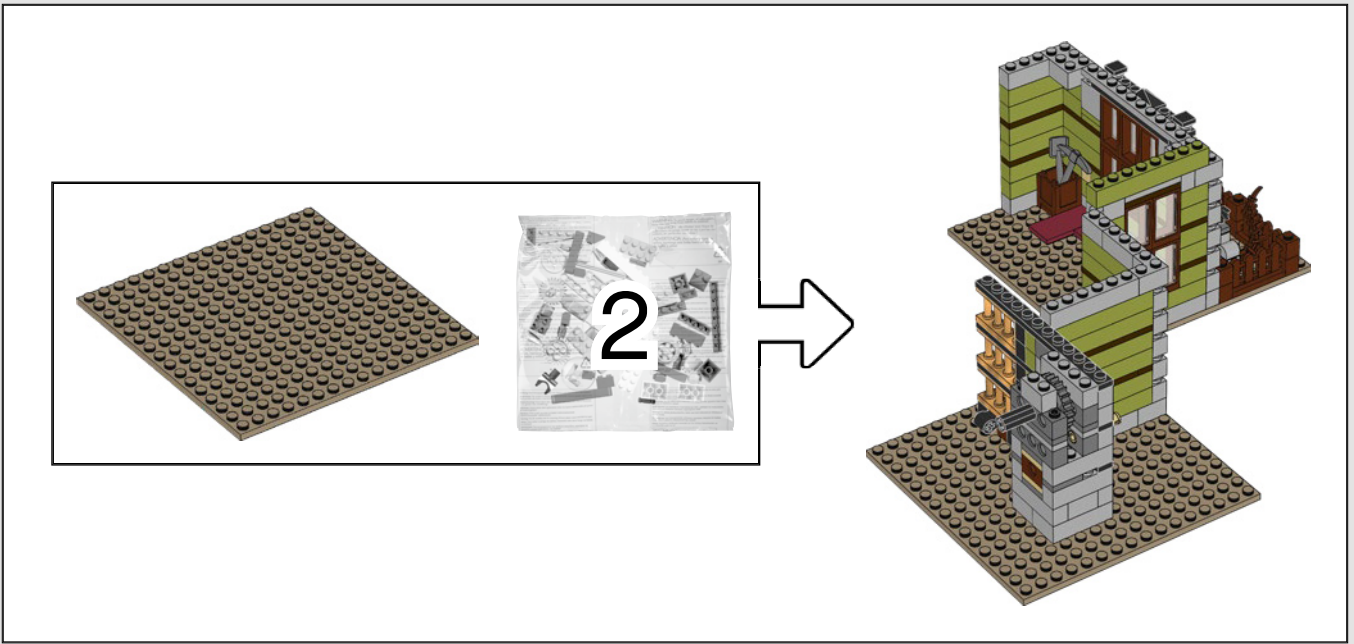

14

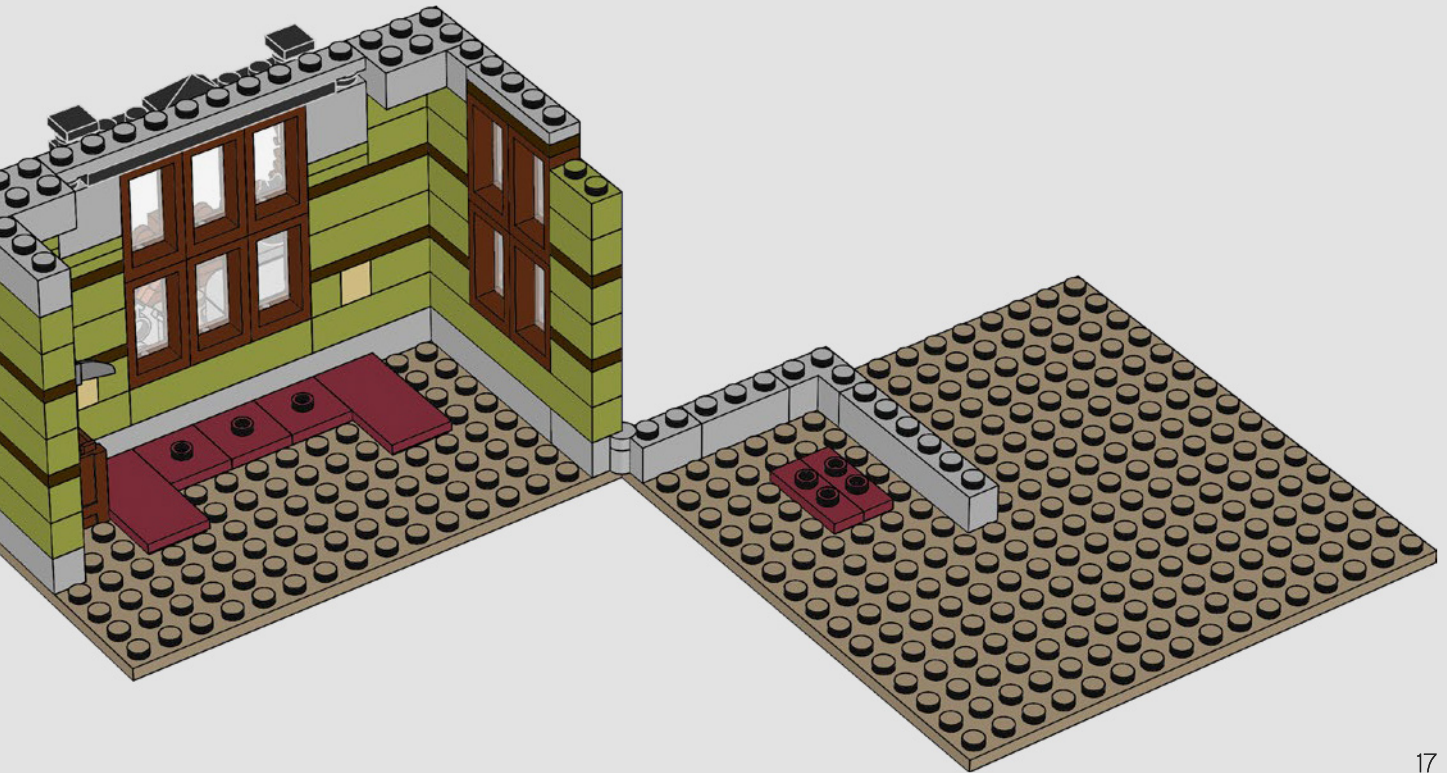

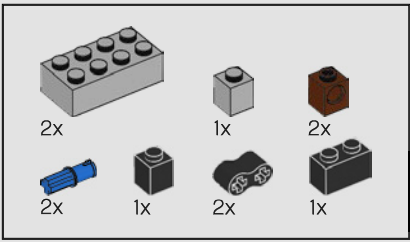

15

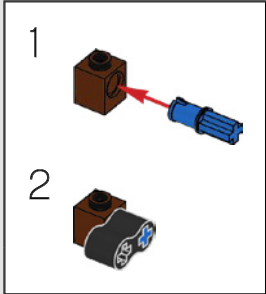
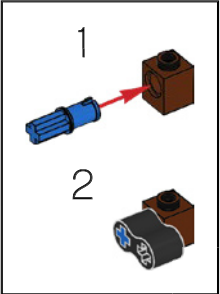
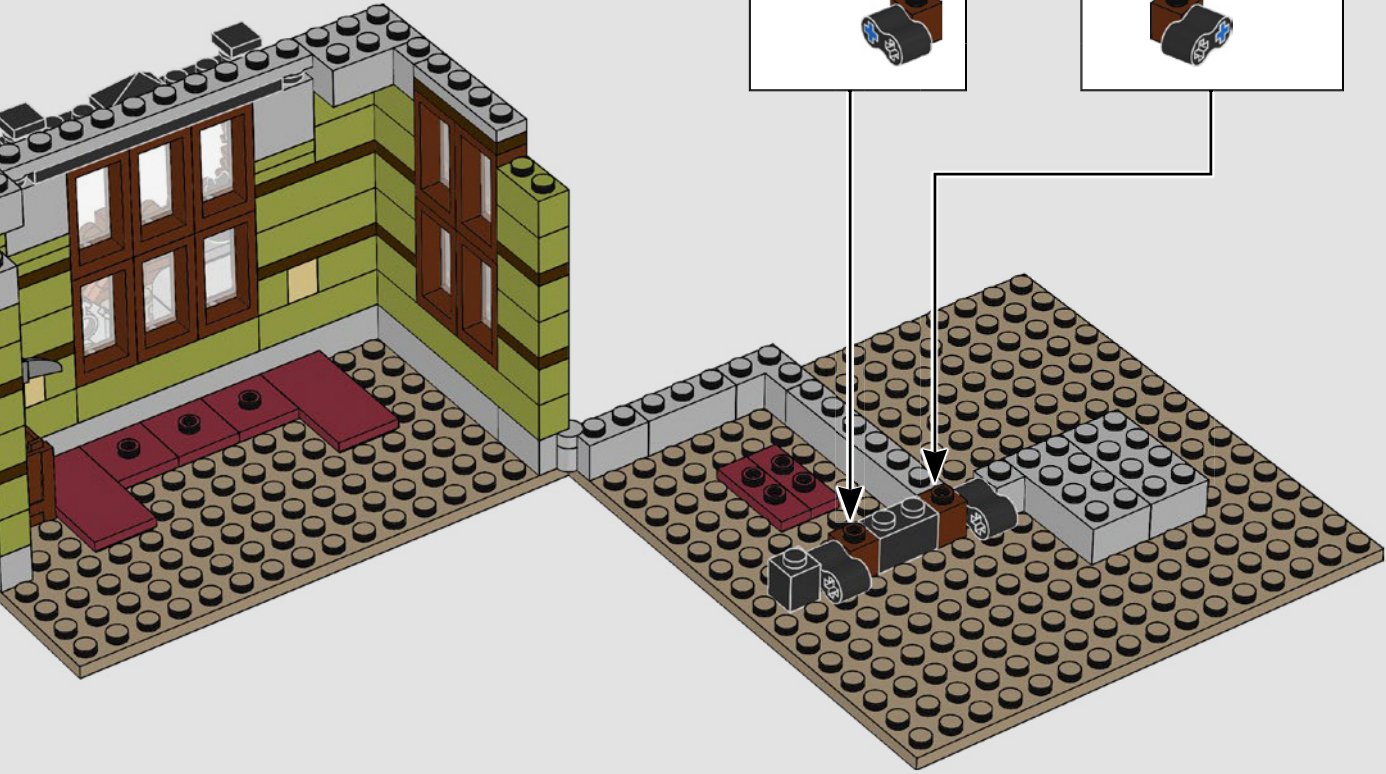

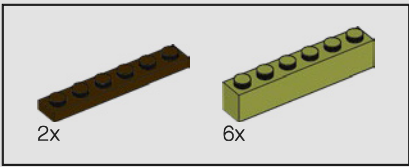

16

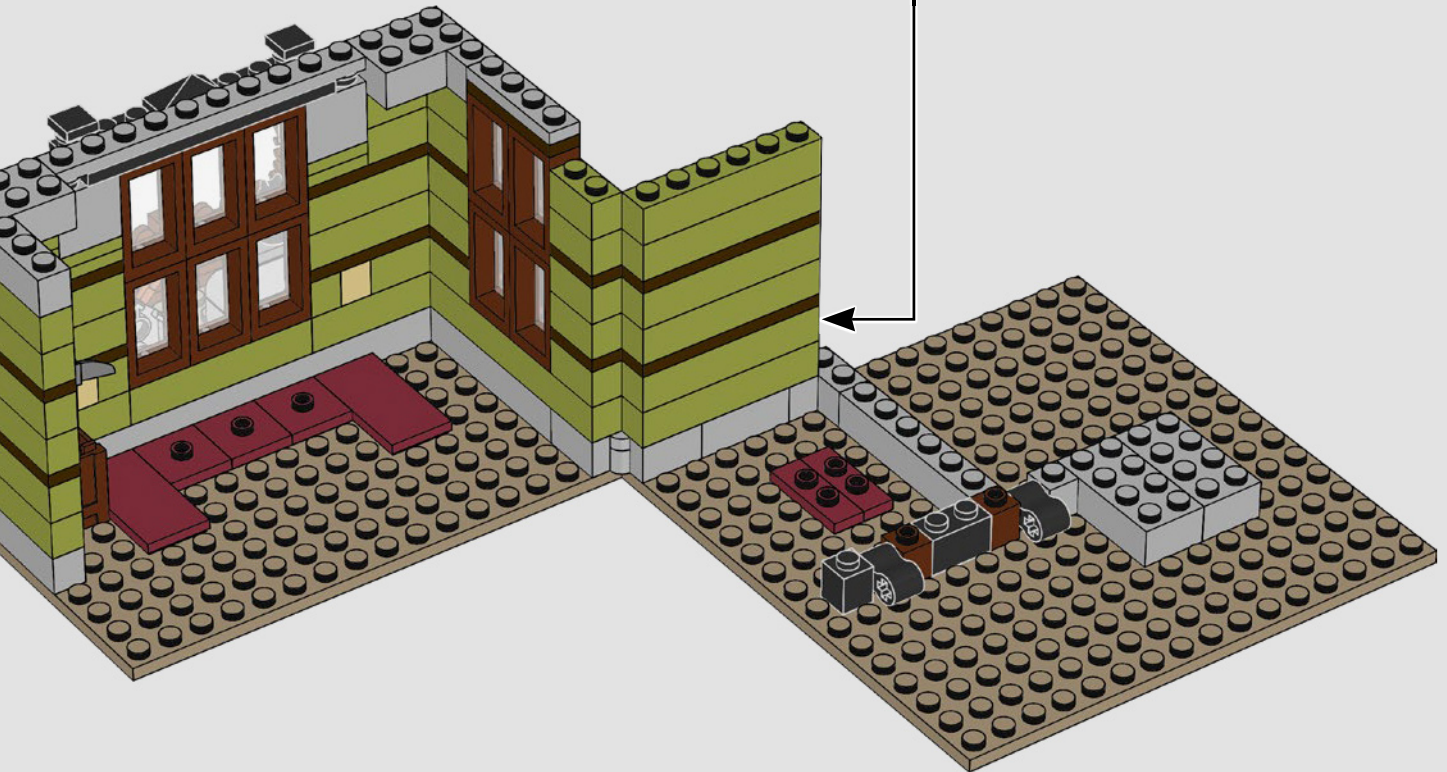
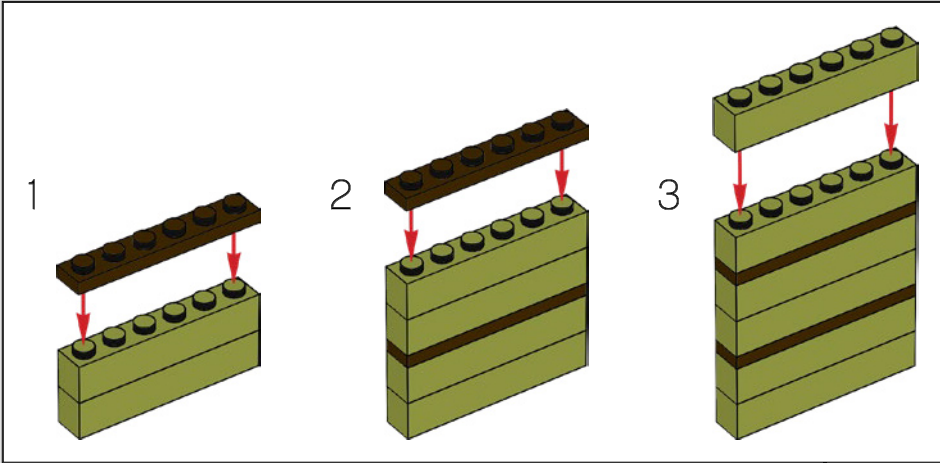

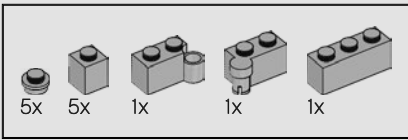

17

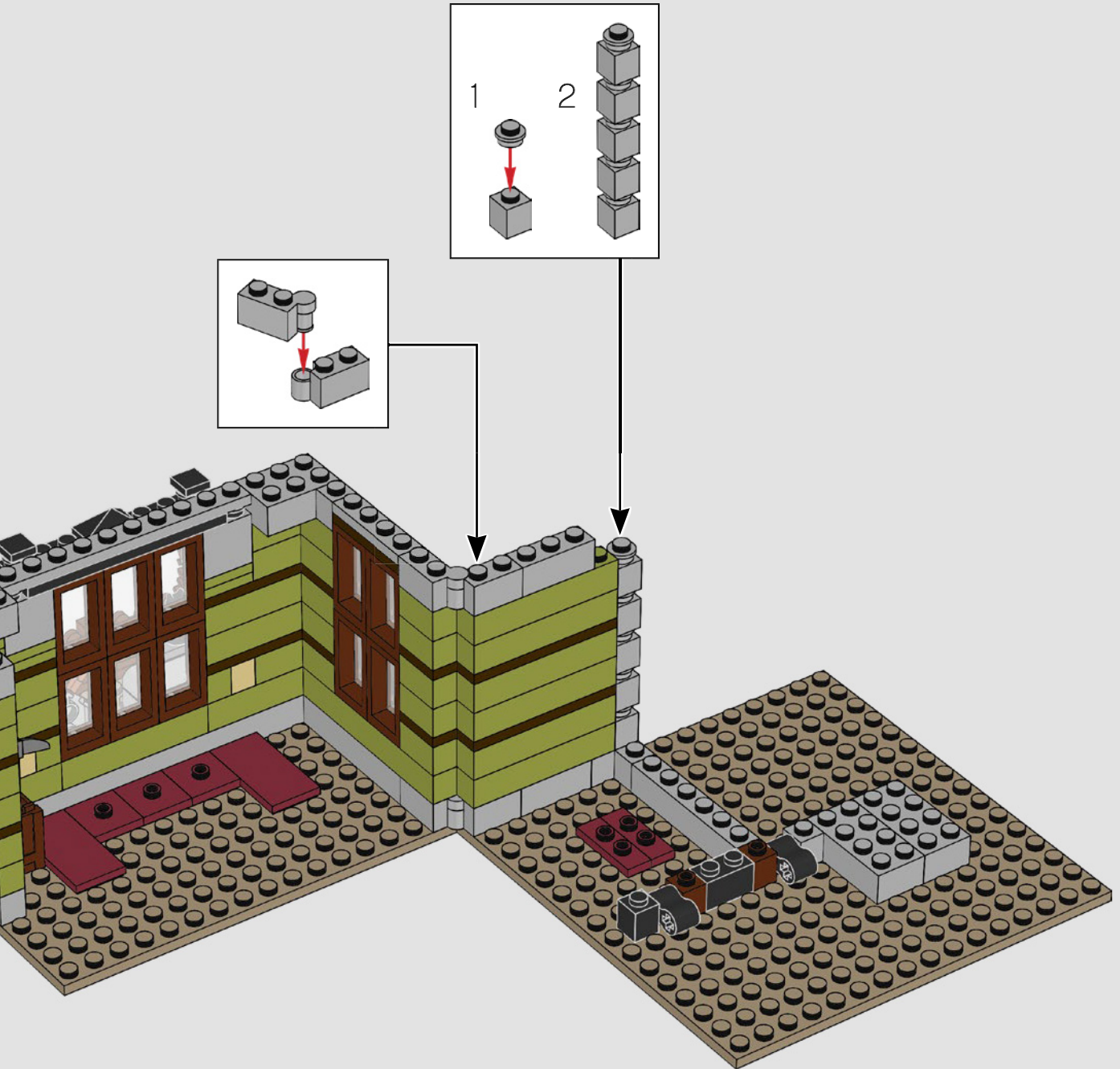

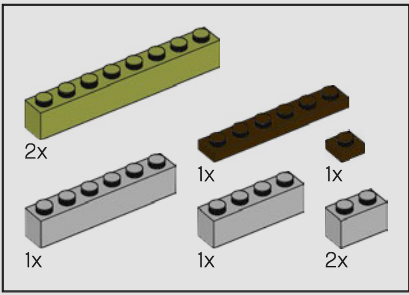

18

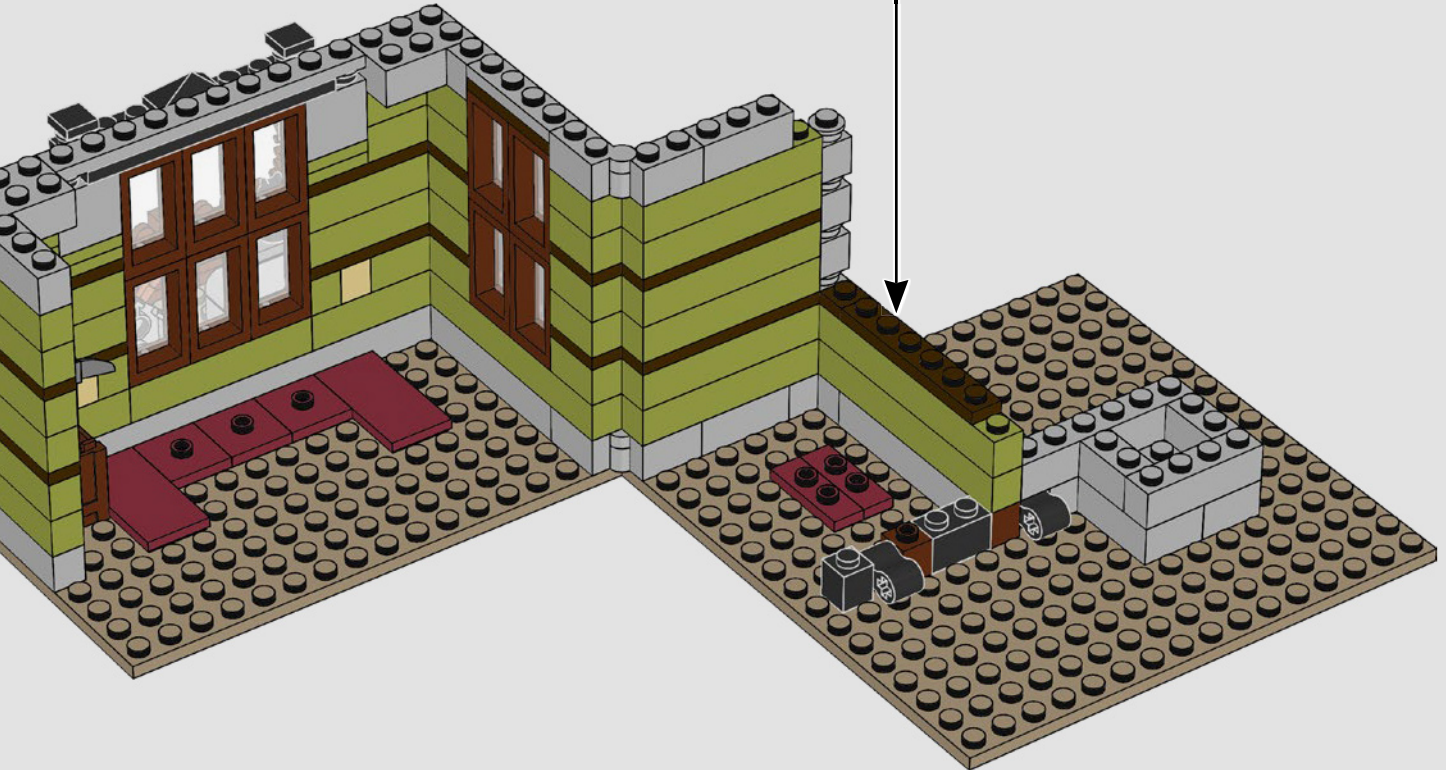
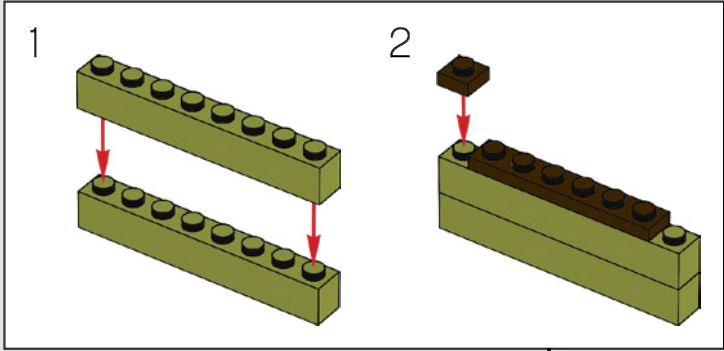

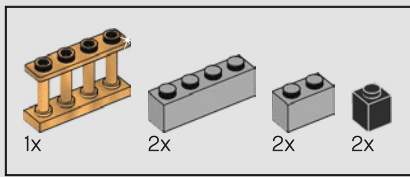

19

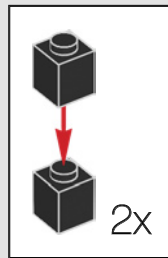

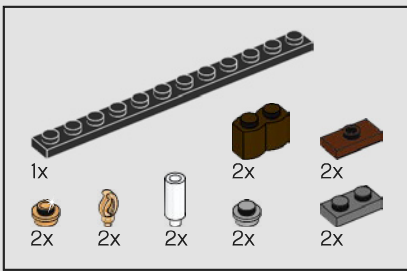

20

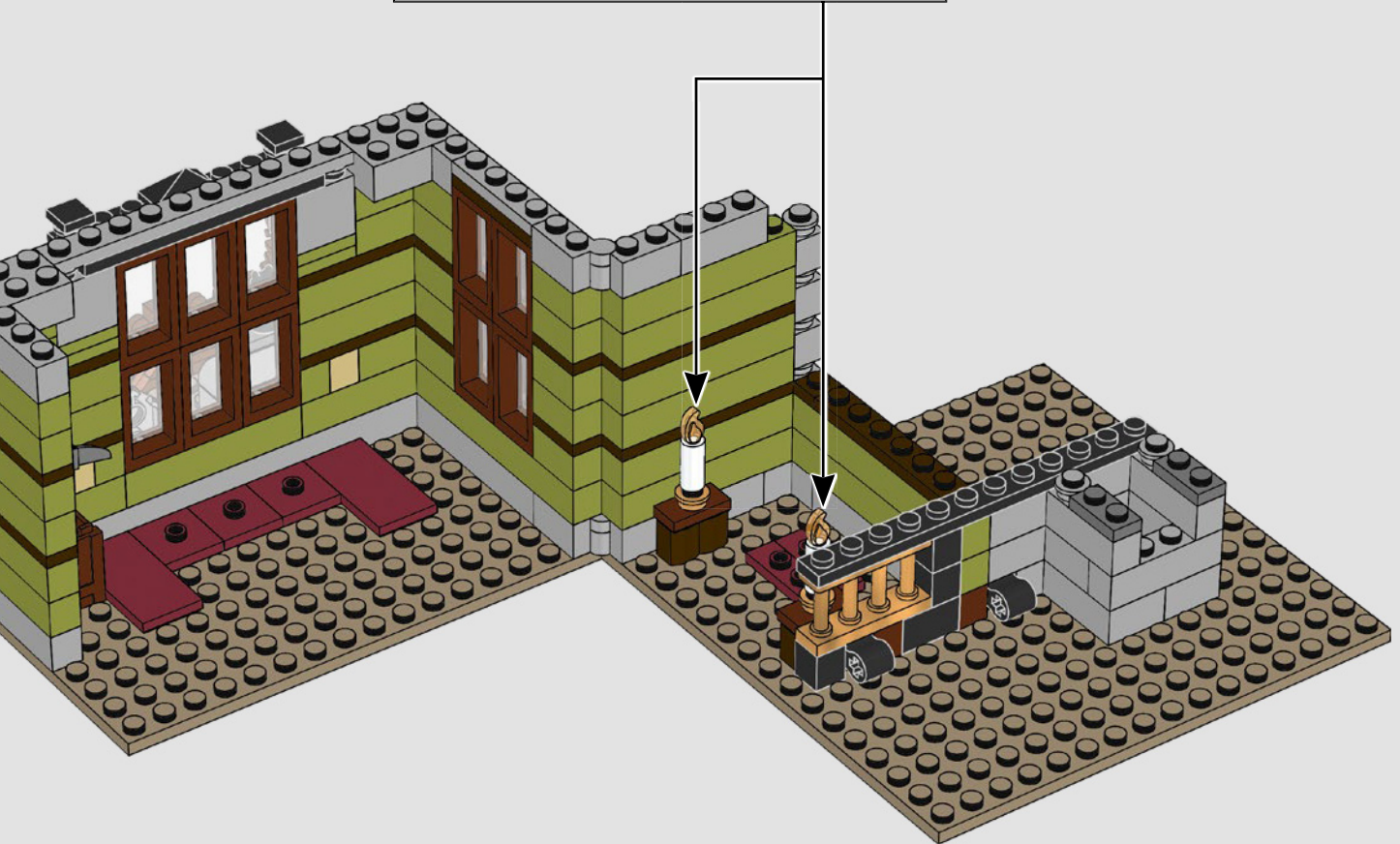
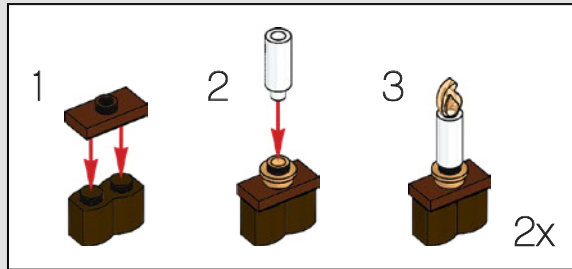

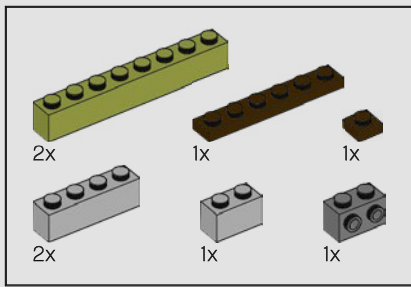

21

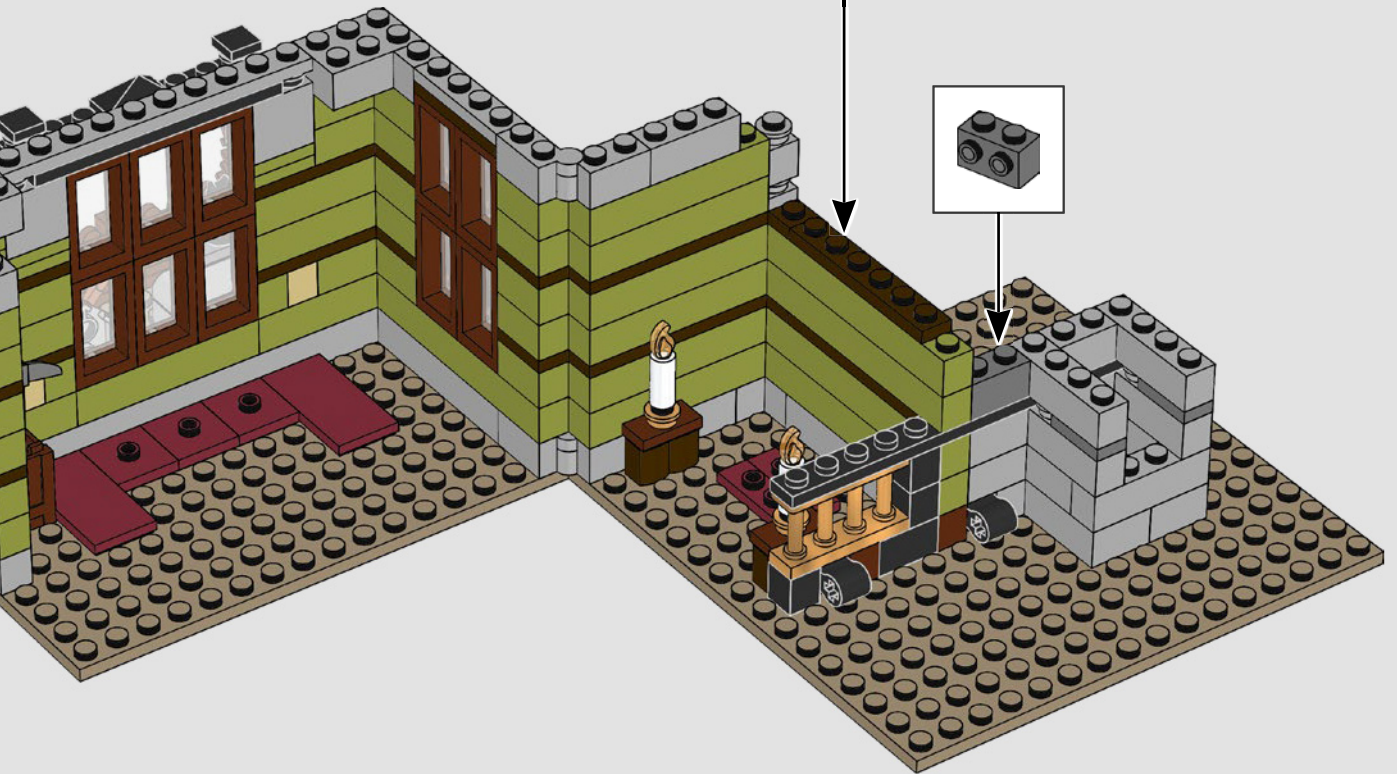
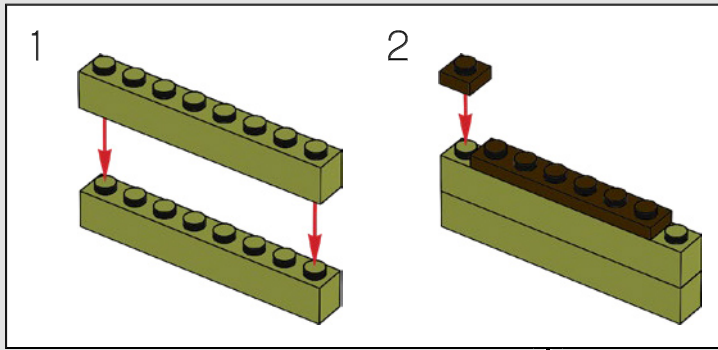

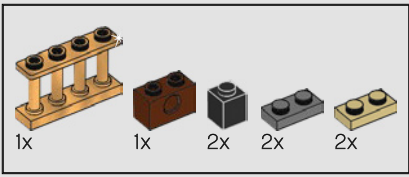

22

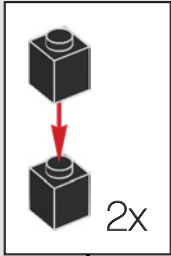
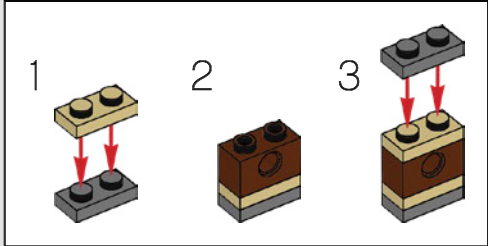

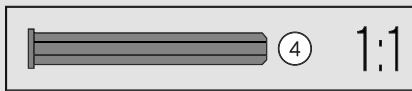
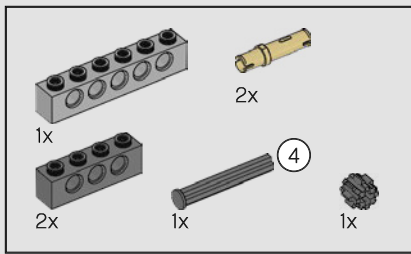

23

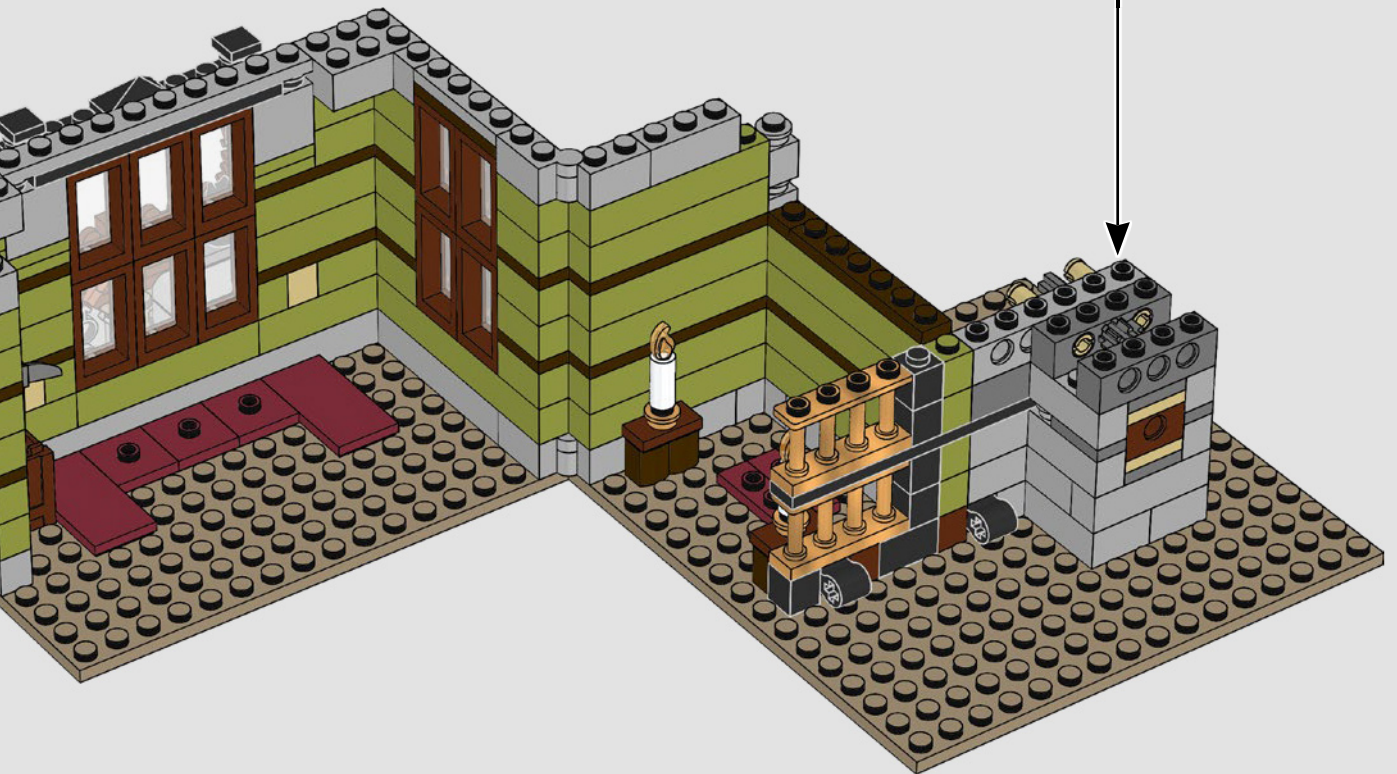
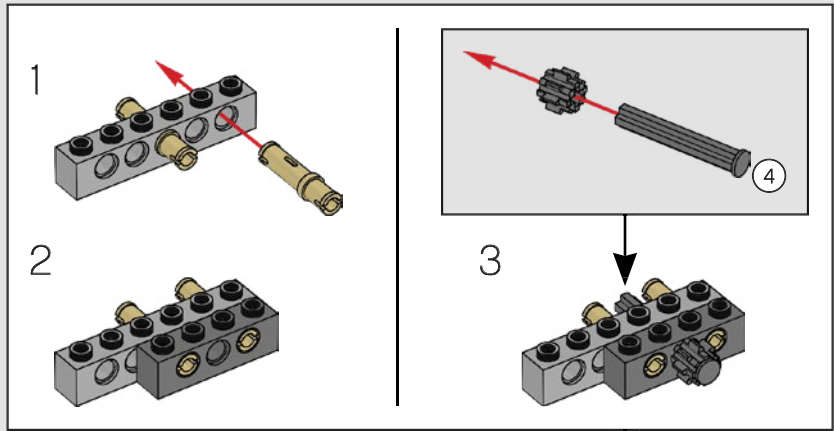

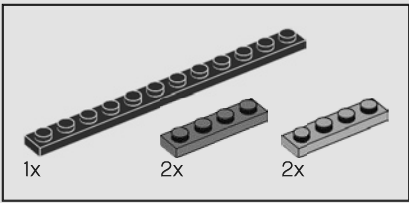

24



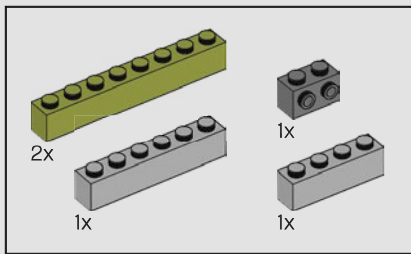

25

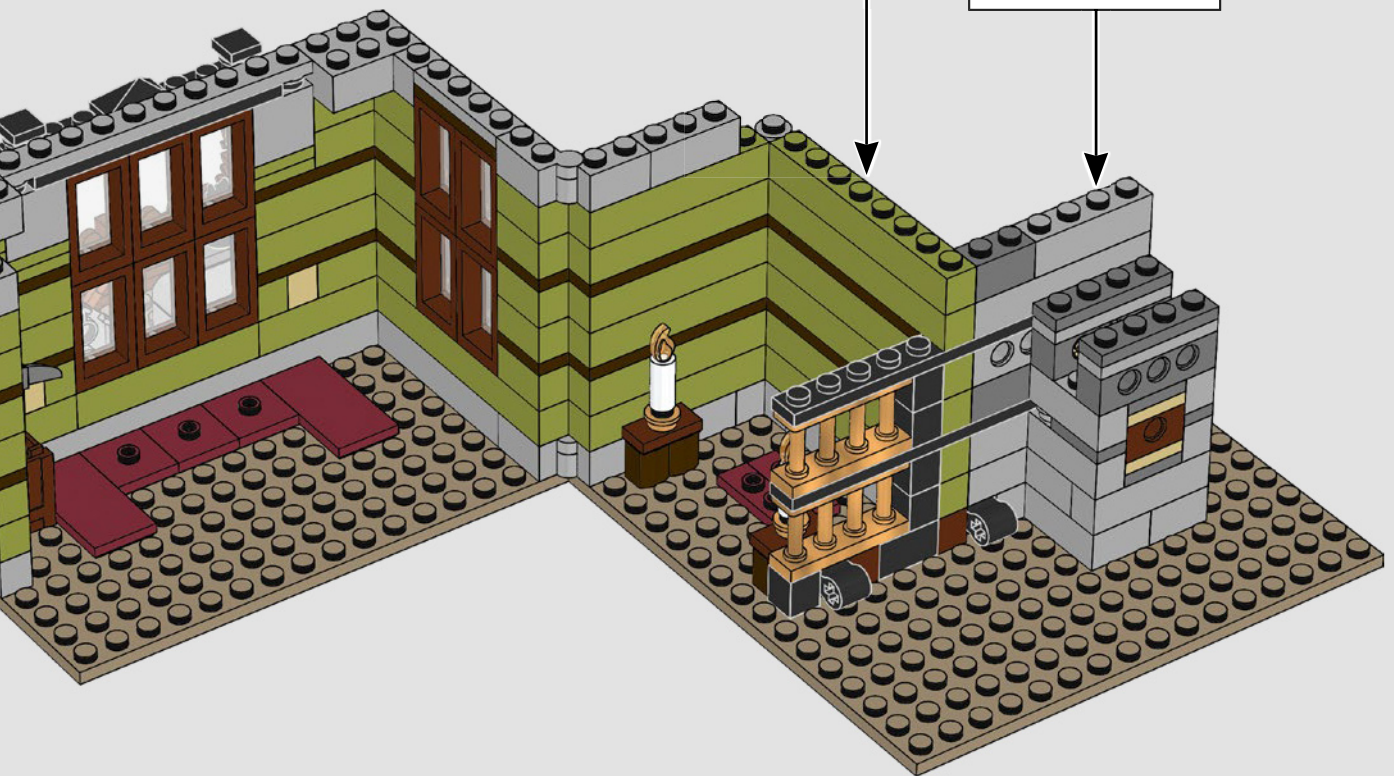
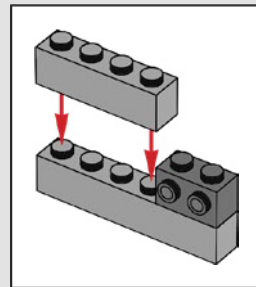
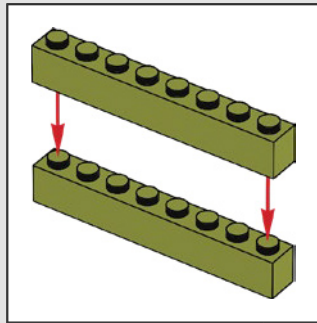

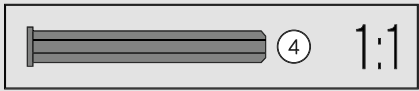
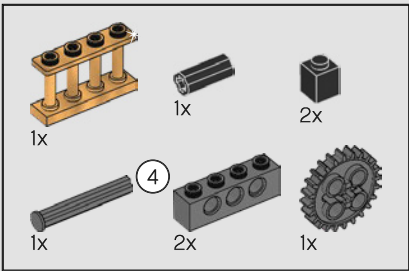

26

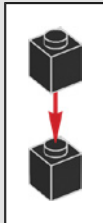
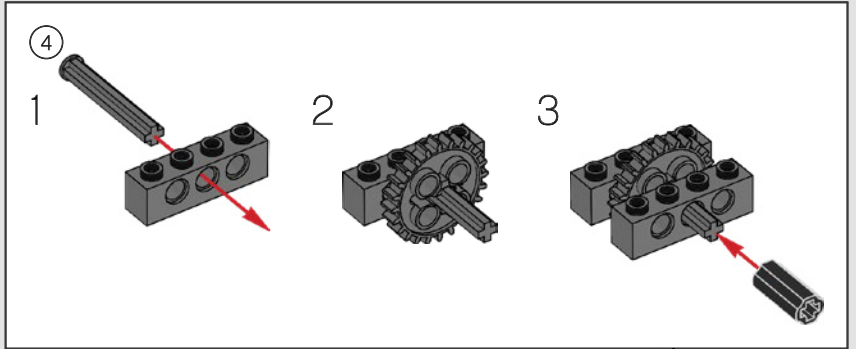

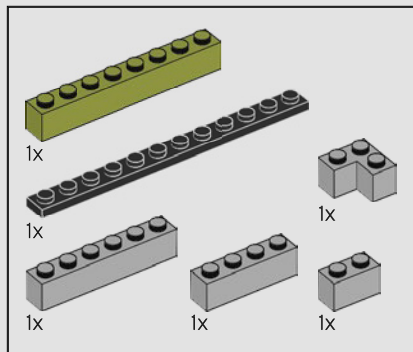

27

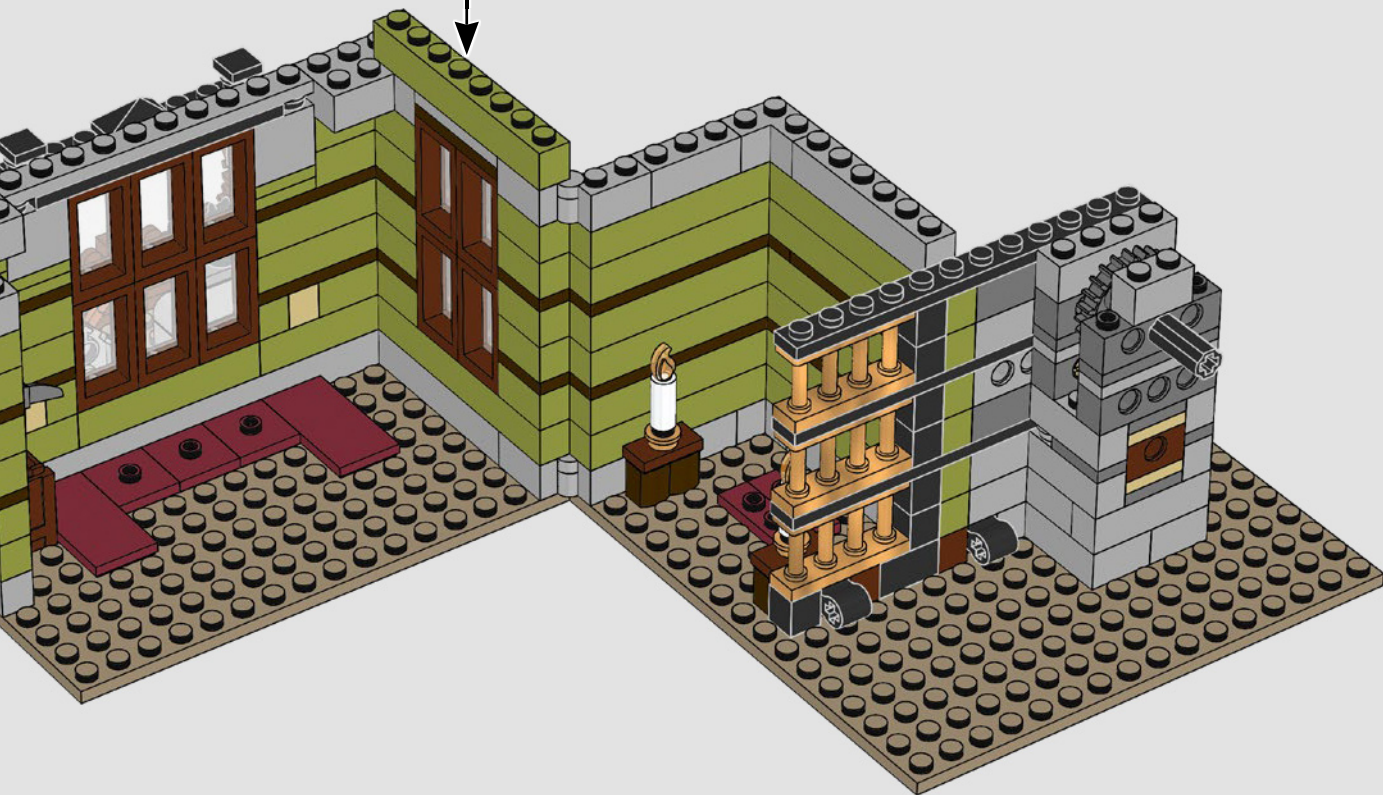
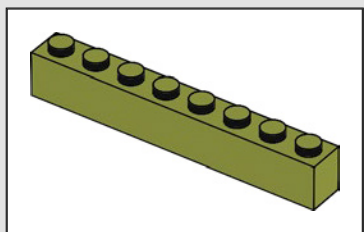

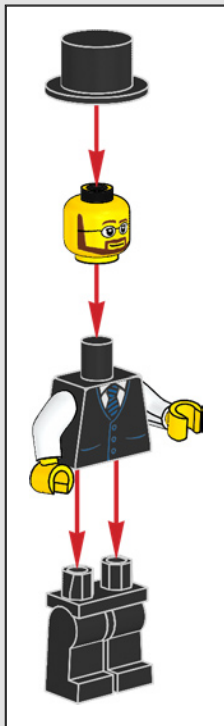
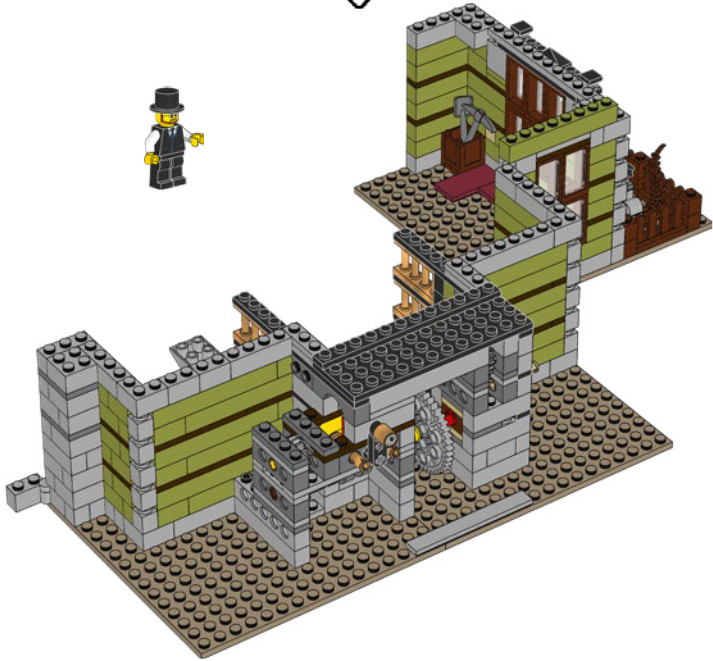
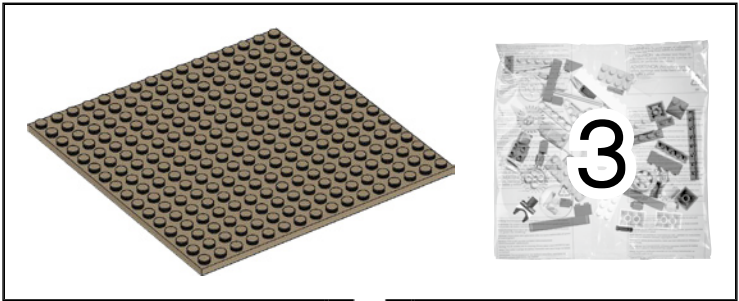

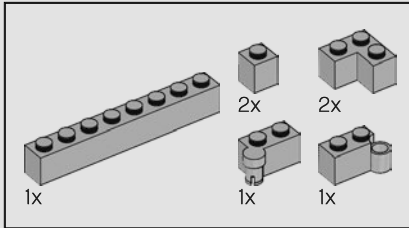
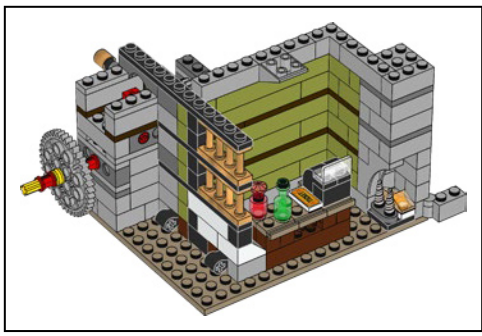

28

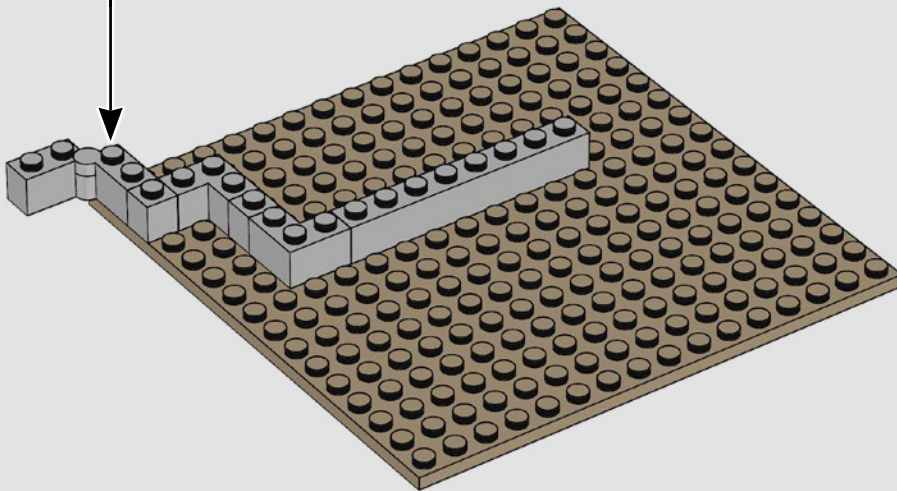
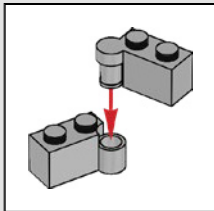

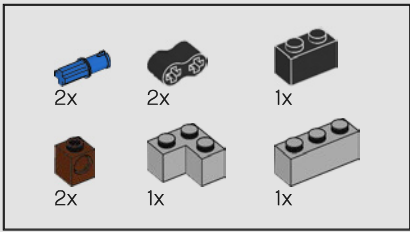

29

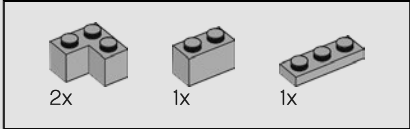
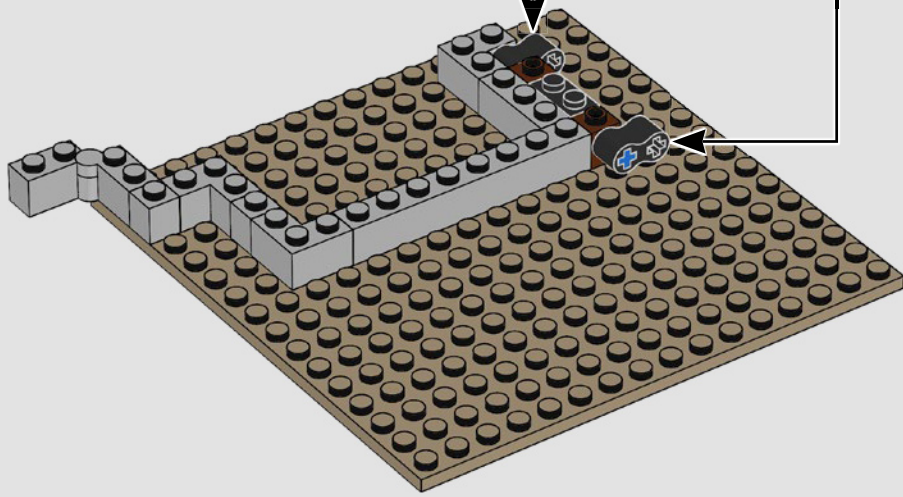
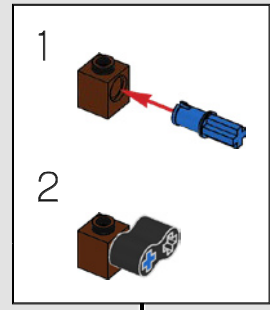
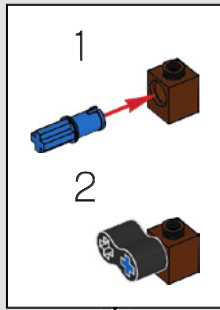

30

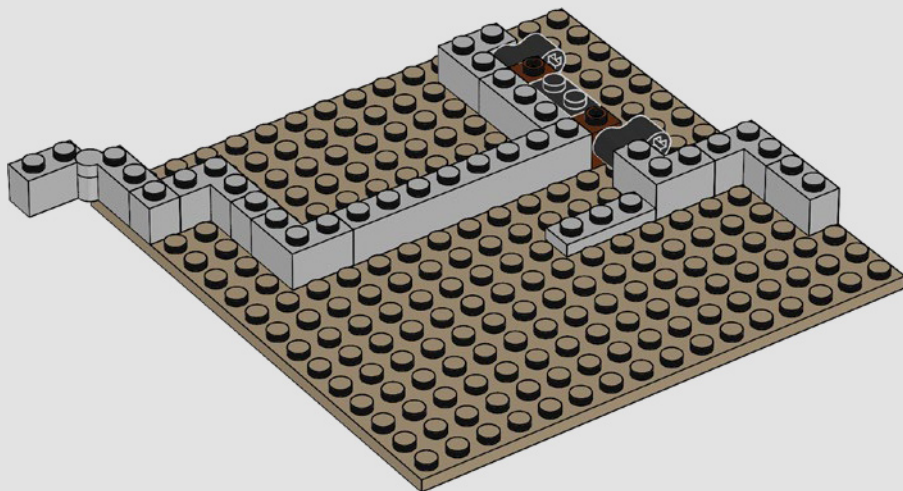

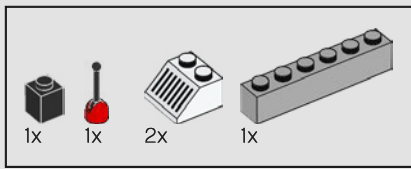

31

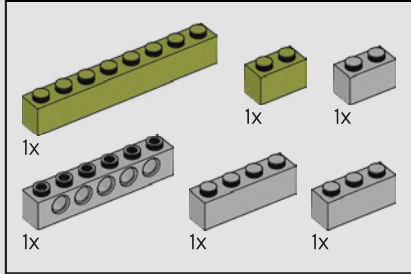
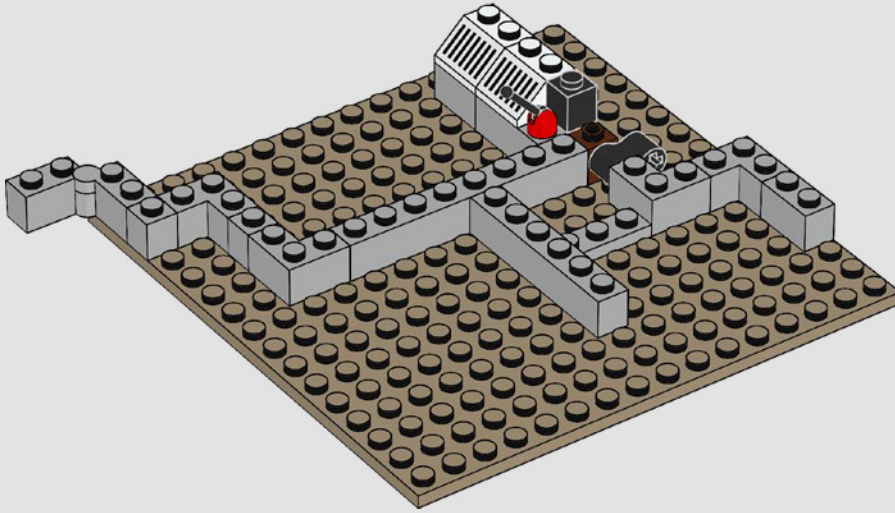

32

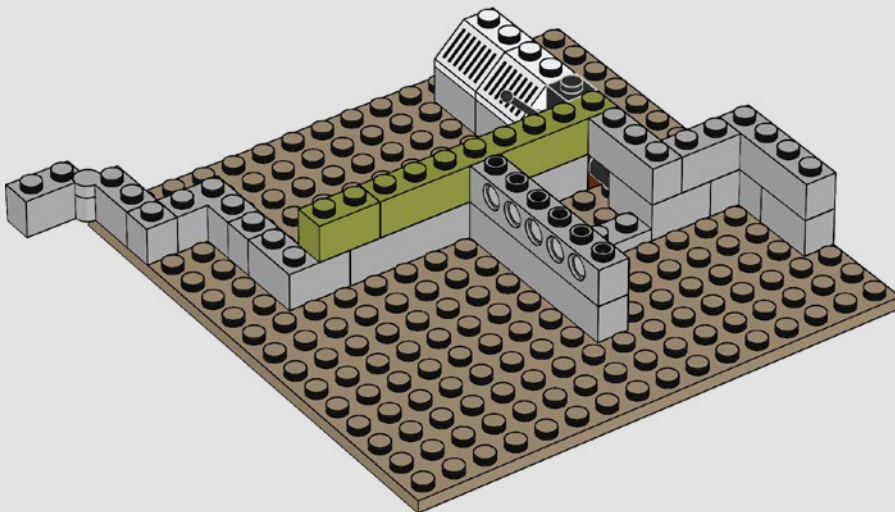

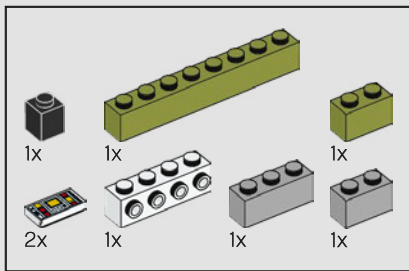

33

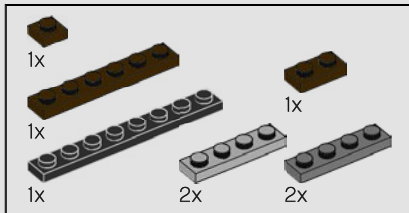
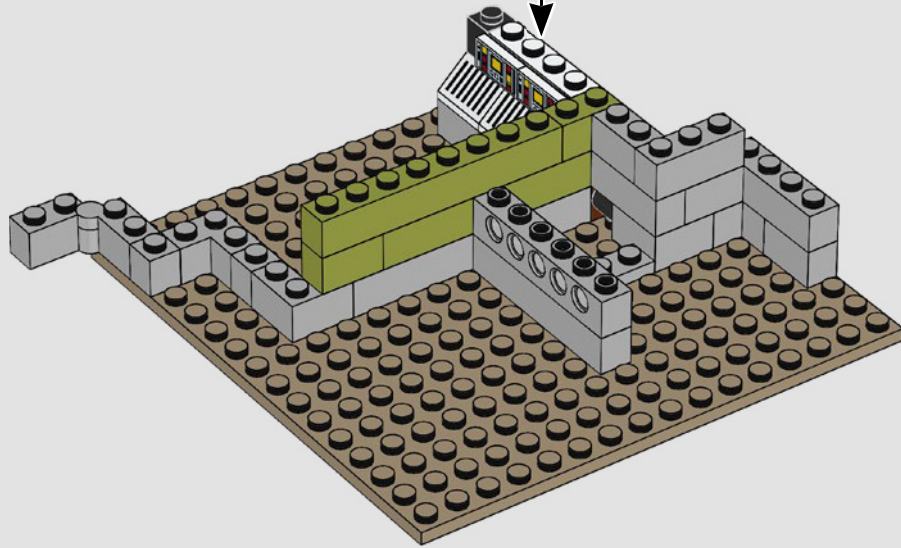
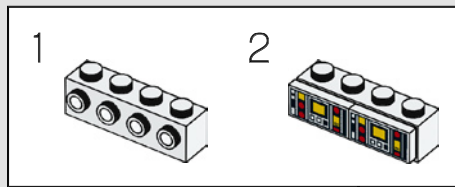

34

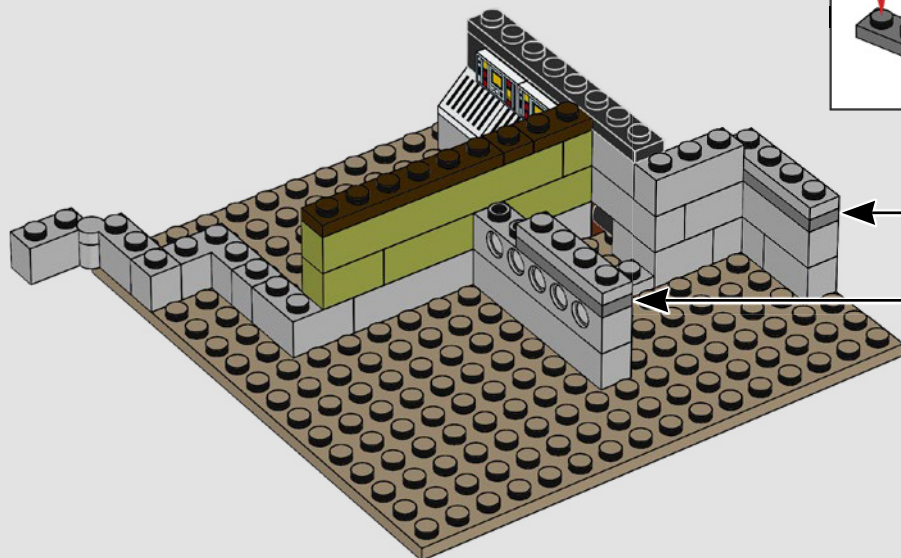
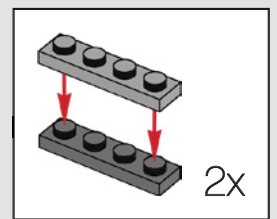

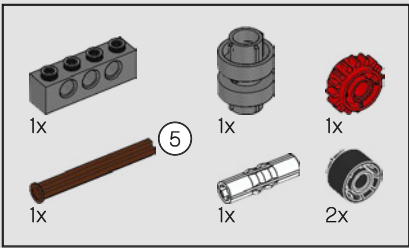

36

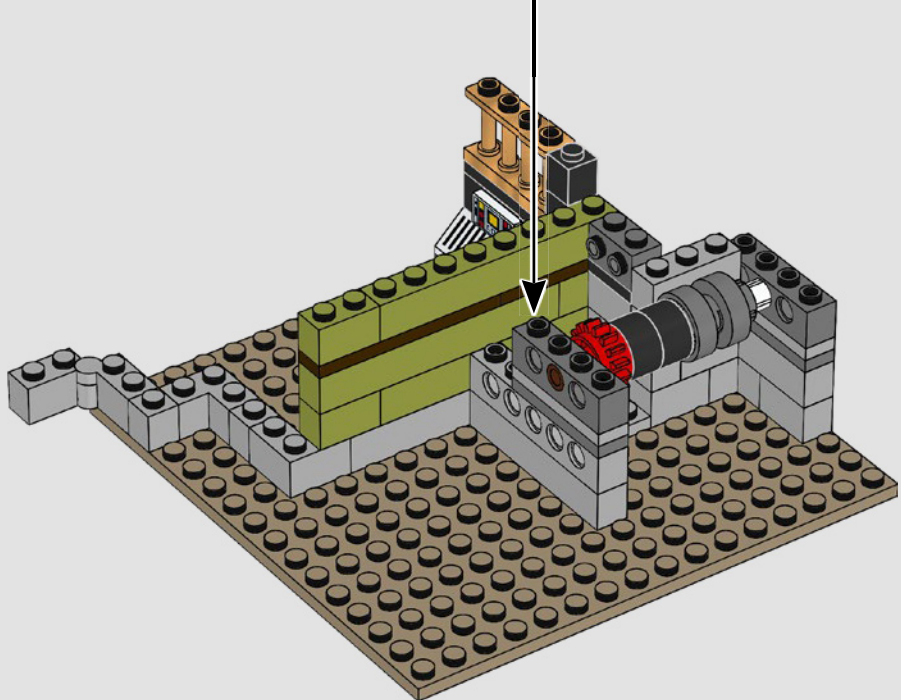
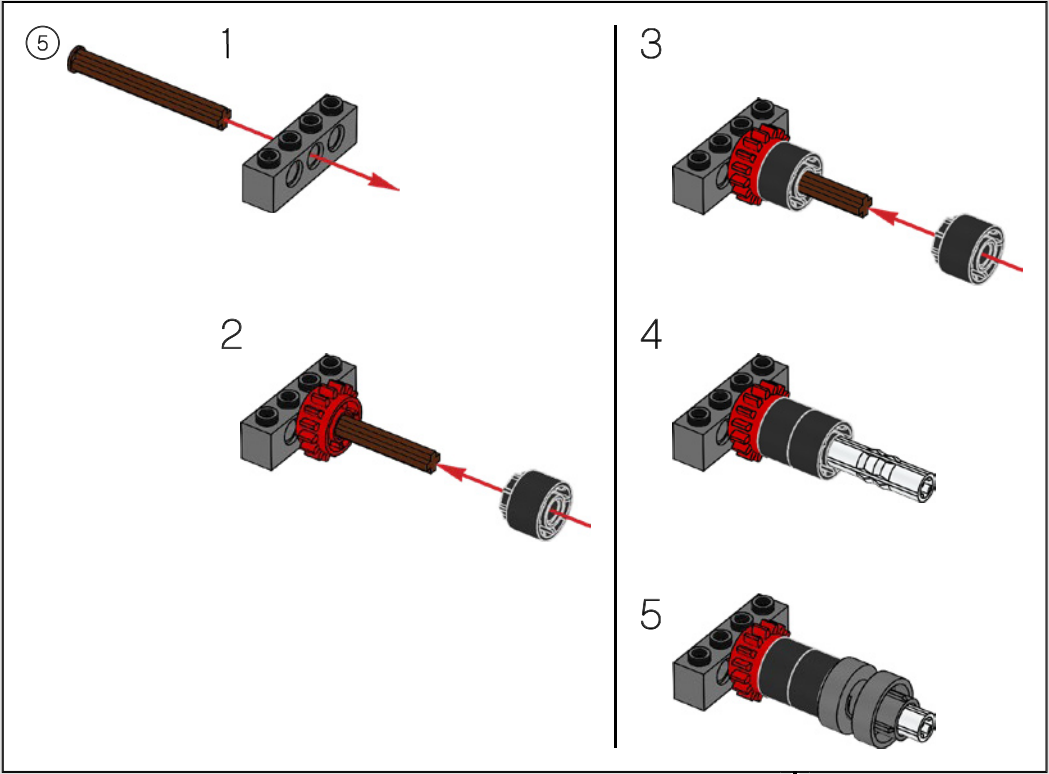

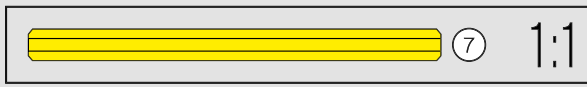
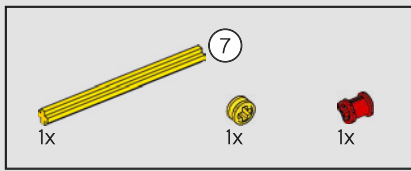

37

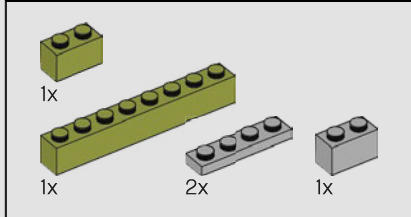
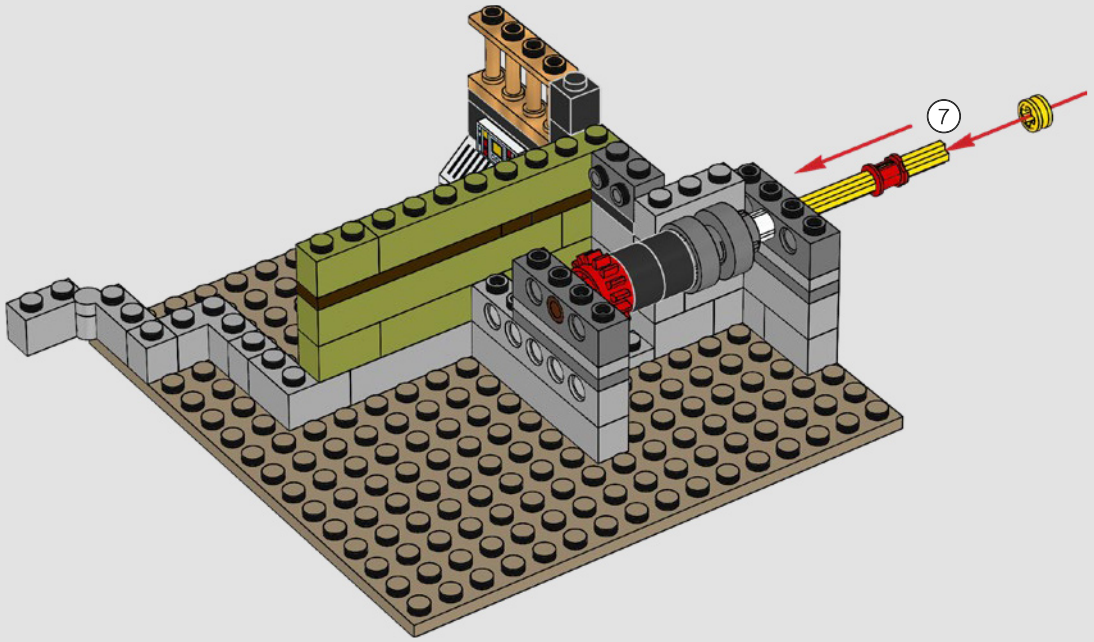

38

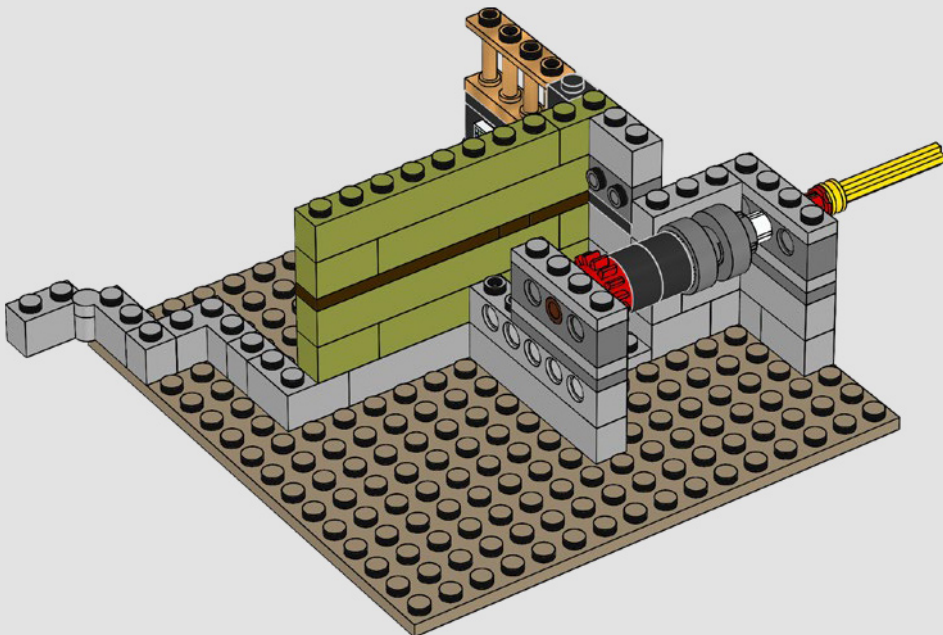

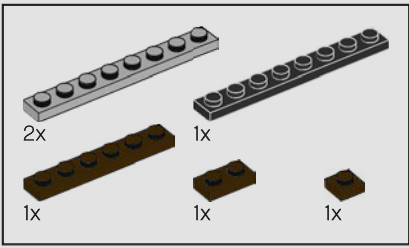

39

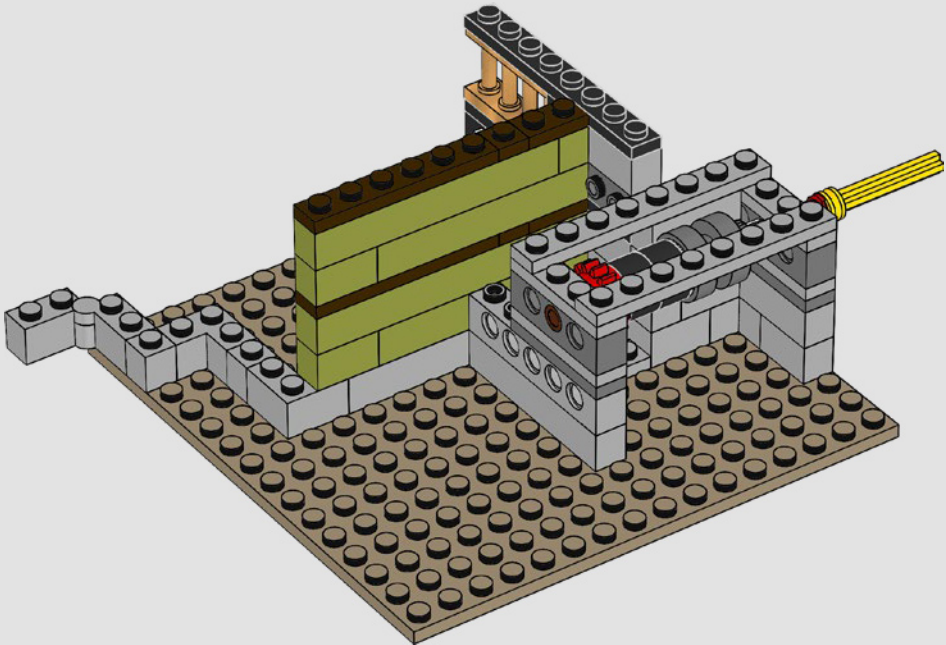

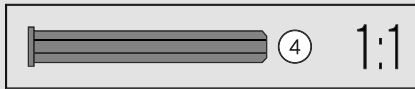
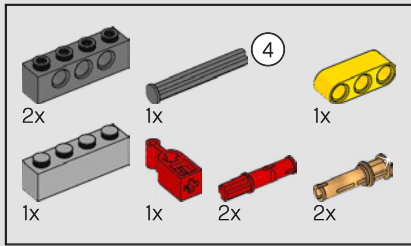

40

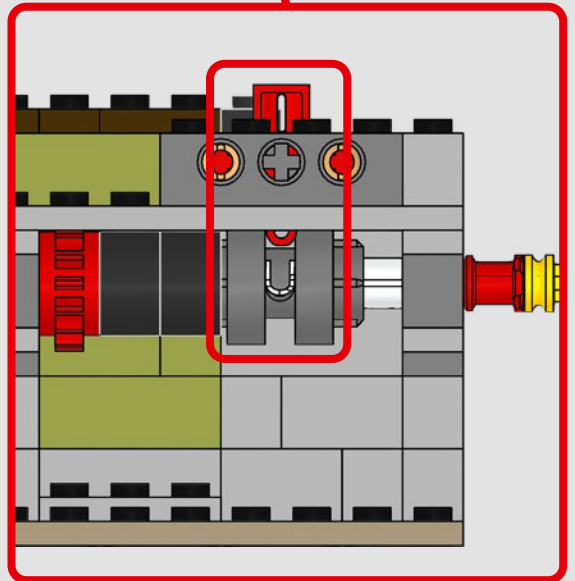
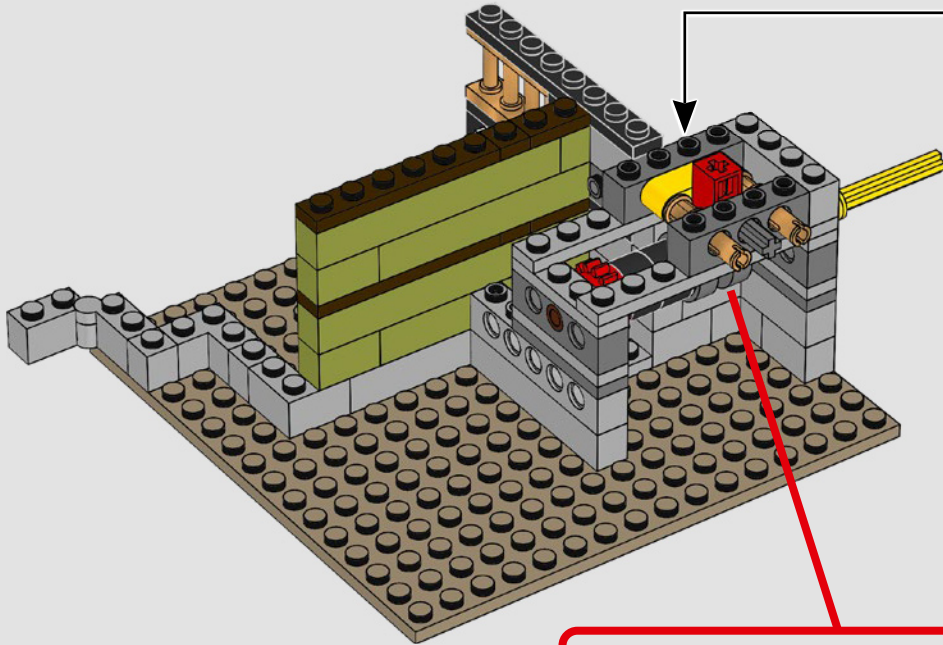
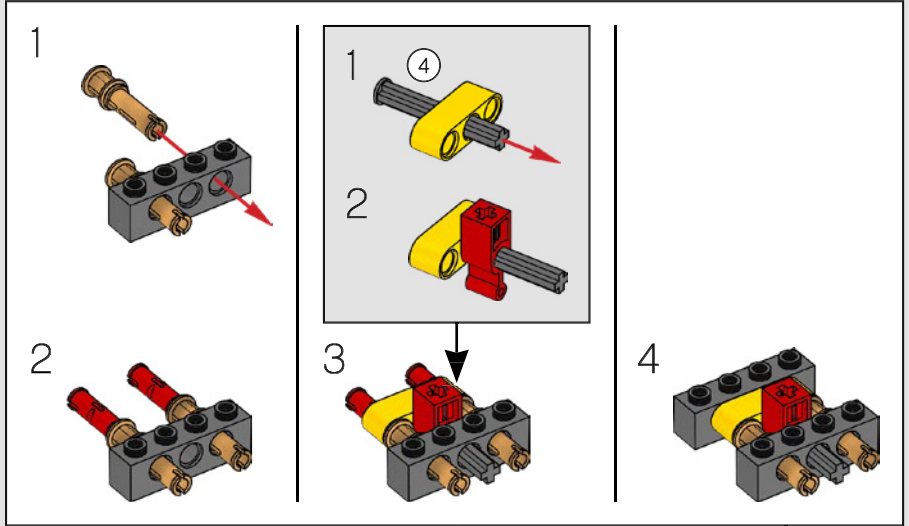

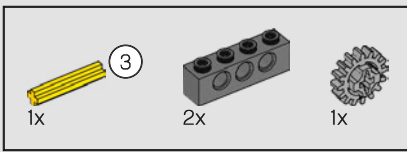

41

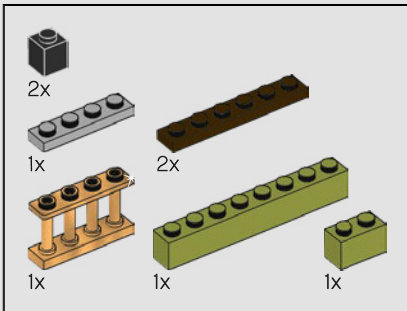
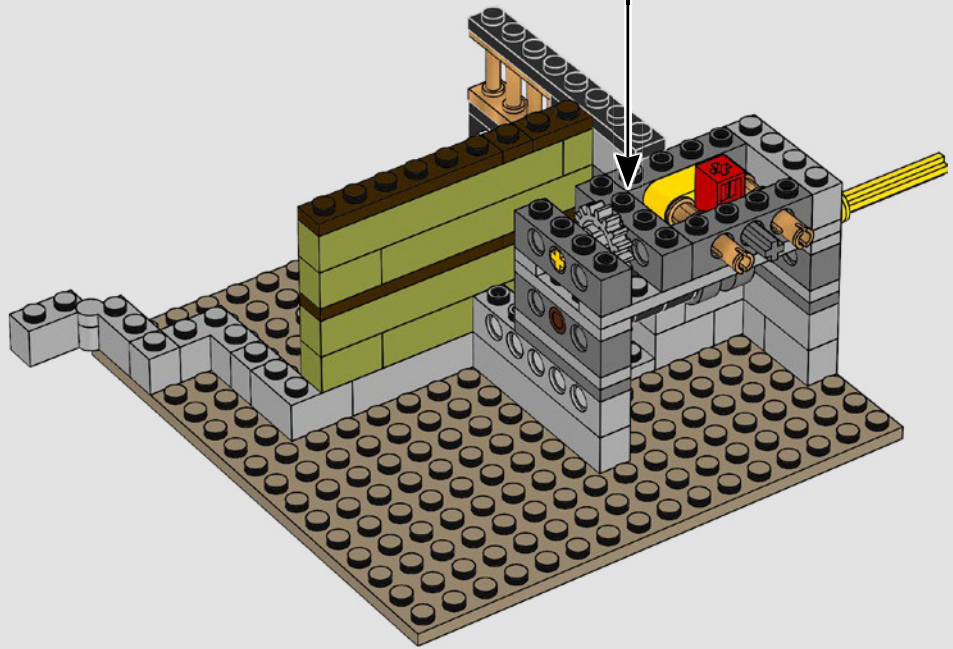
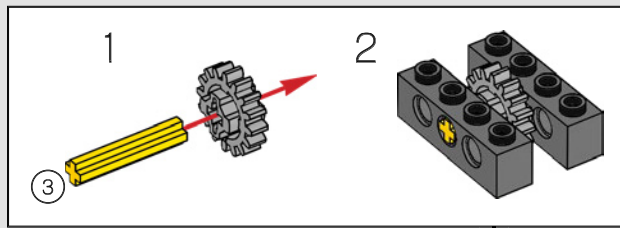

42

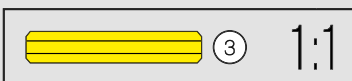
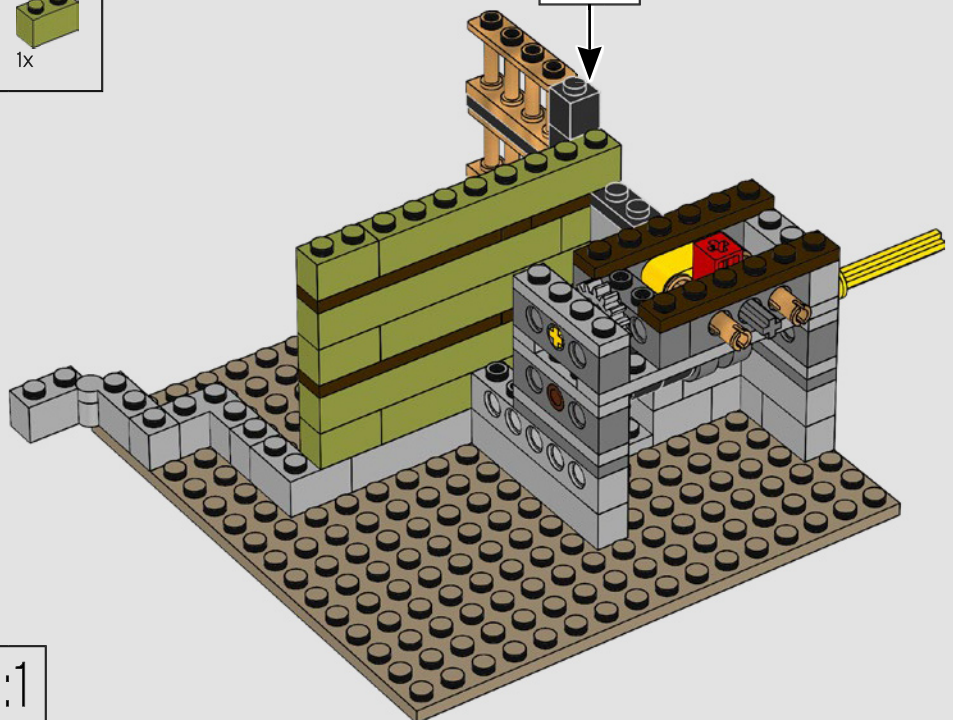
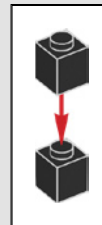

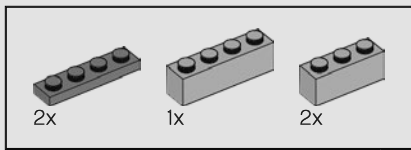

43

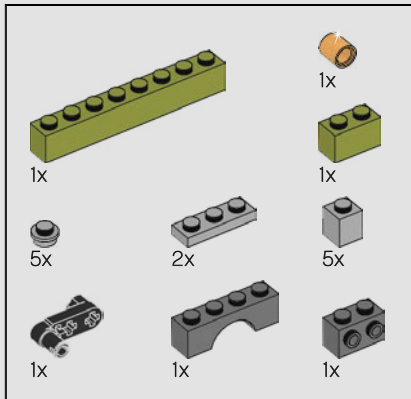
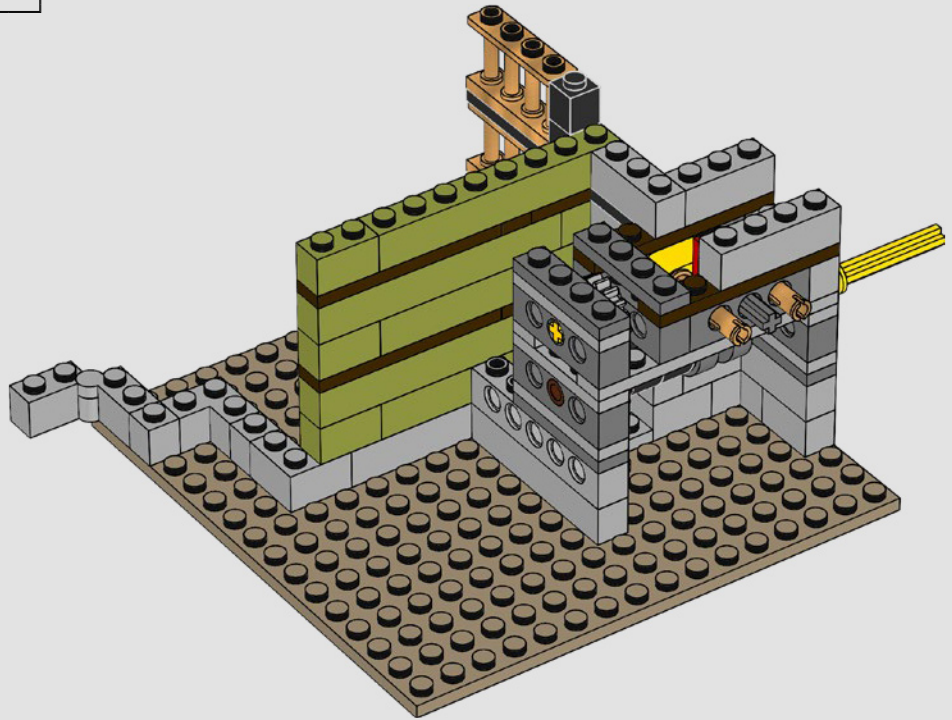

44

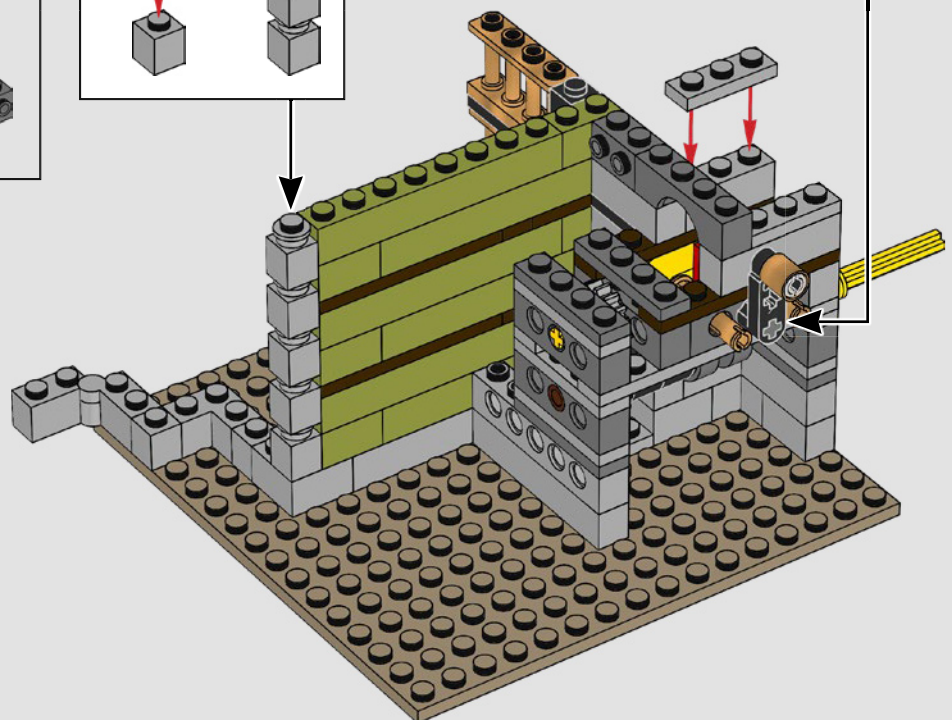
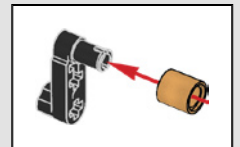
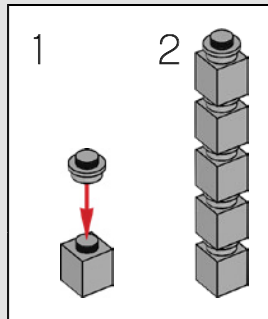

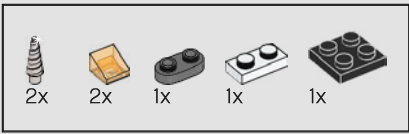

45

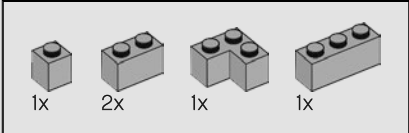
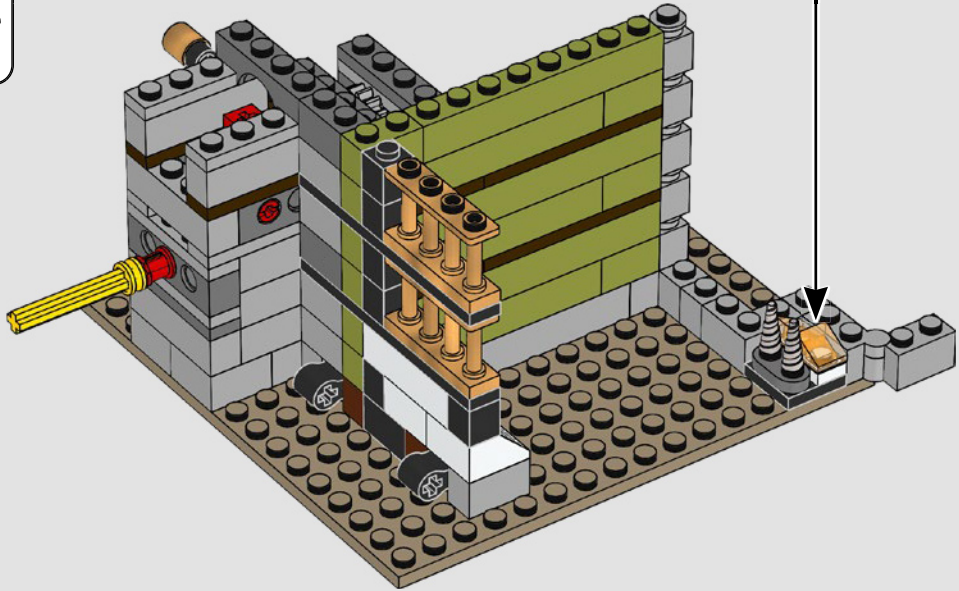
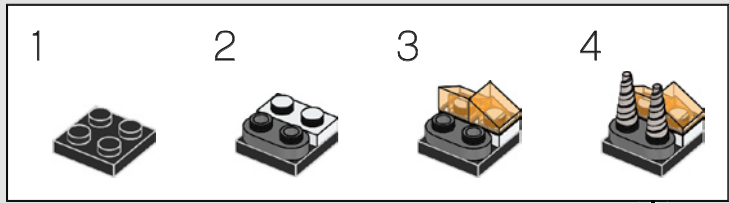

46

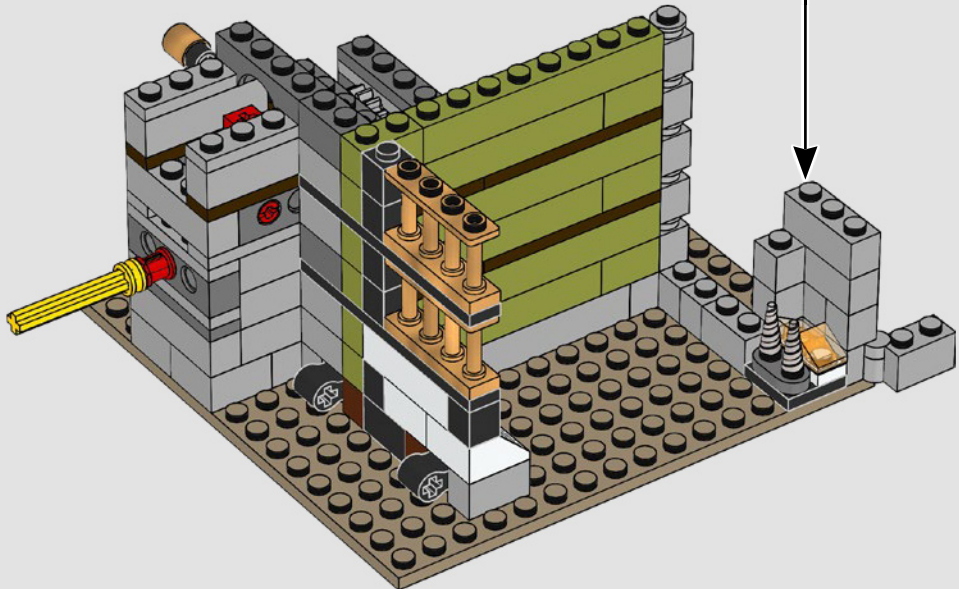
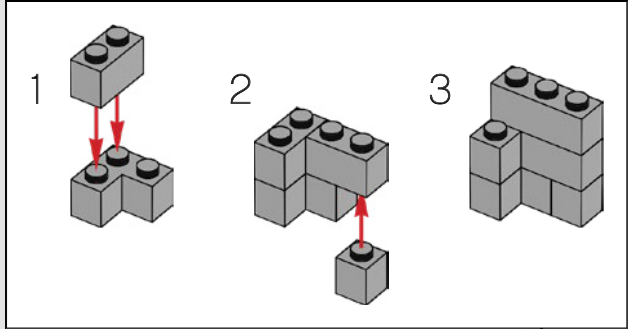

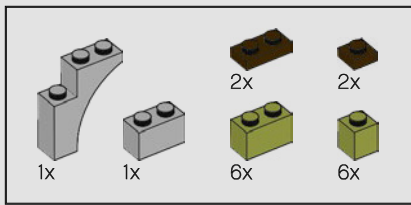

47

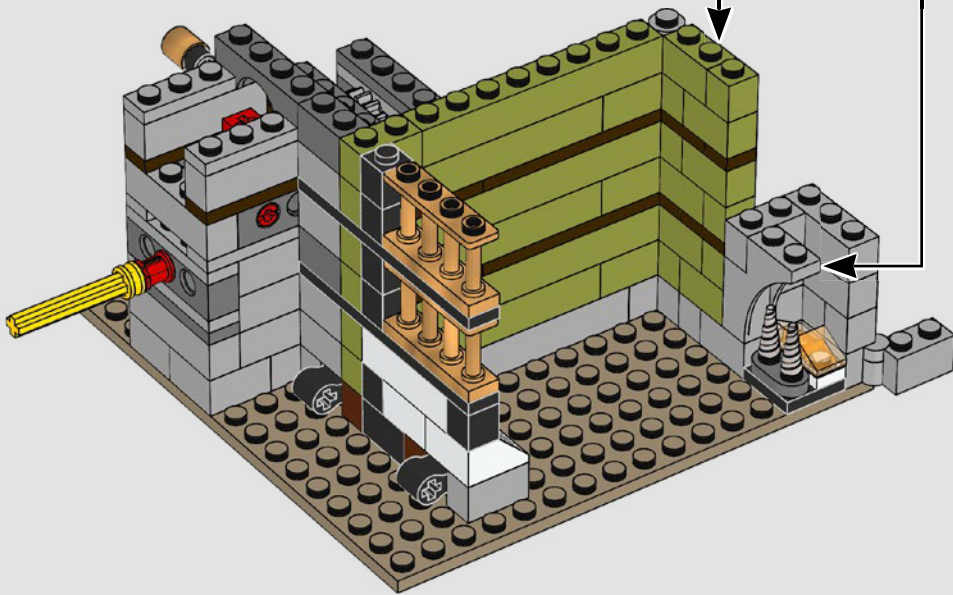
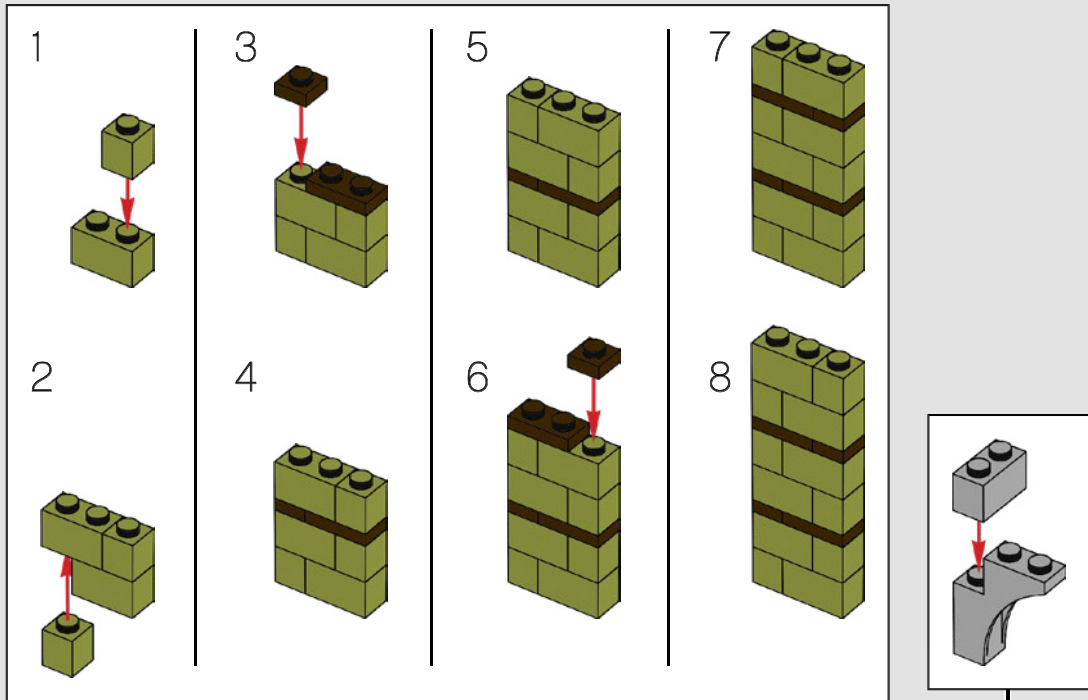

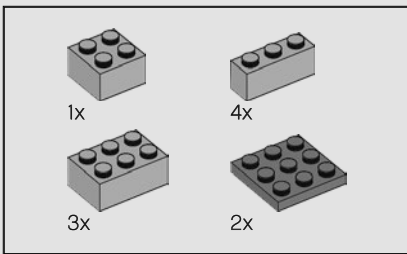

48

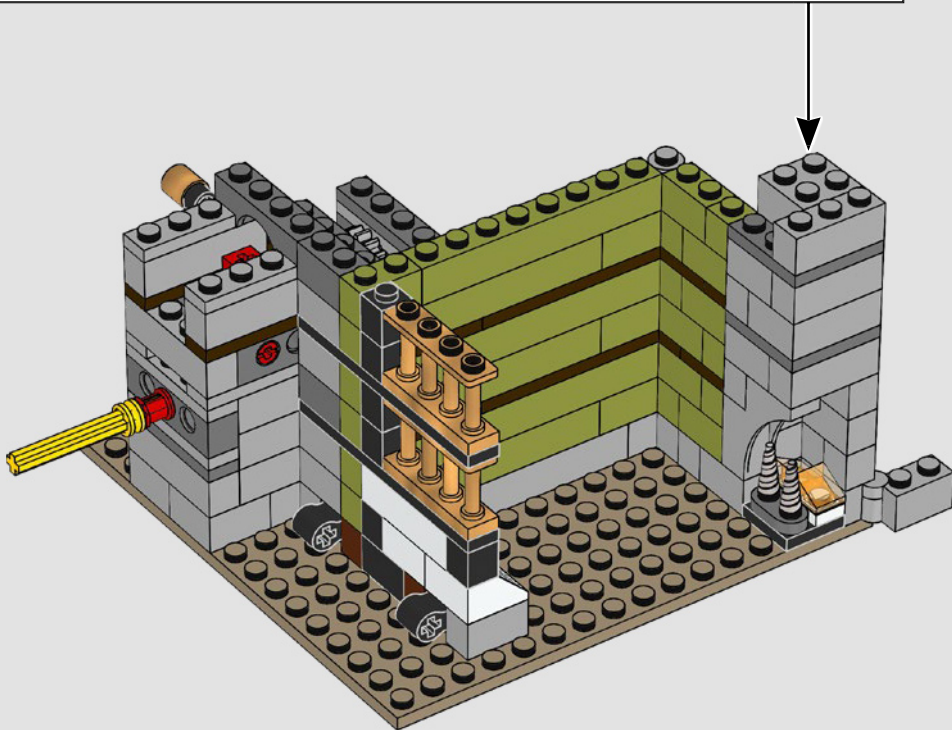
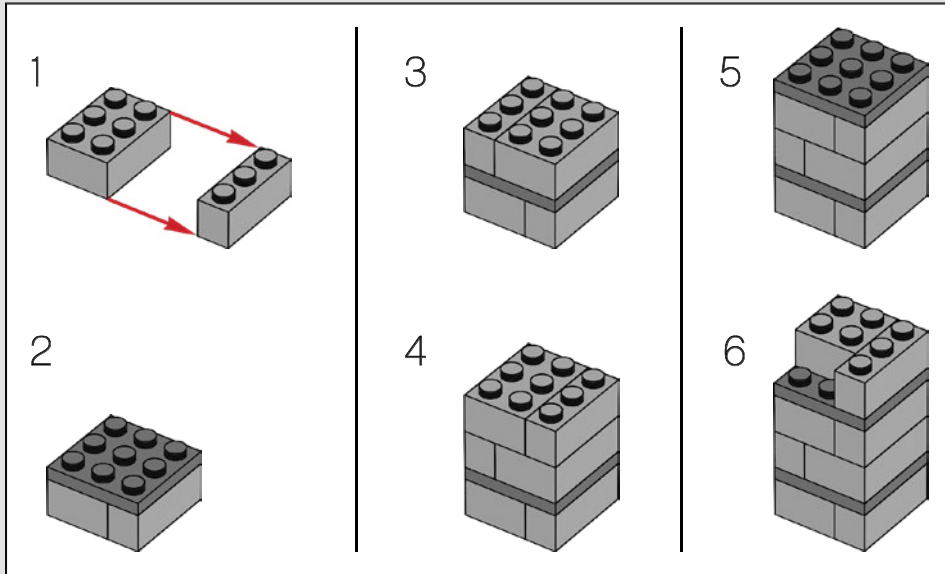

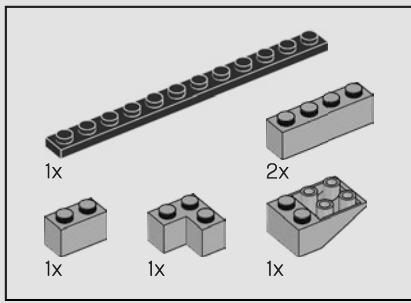

49

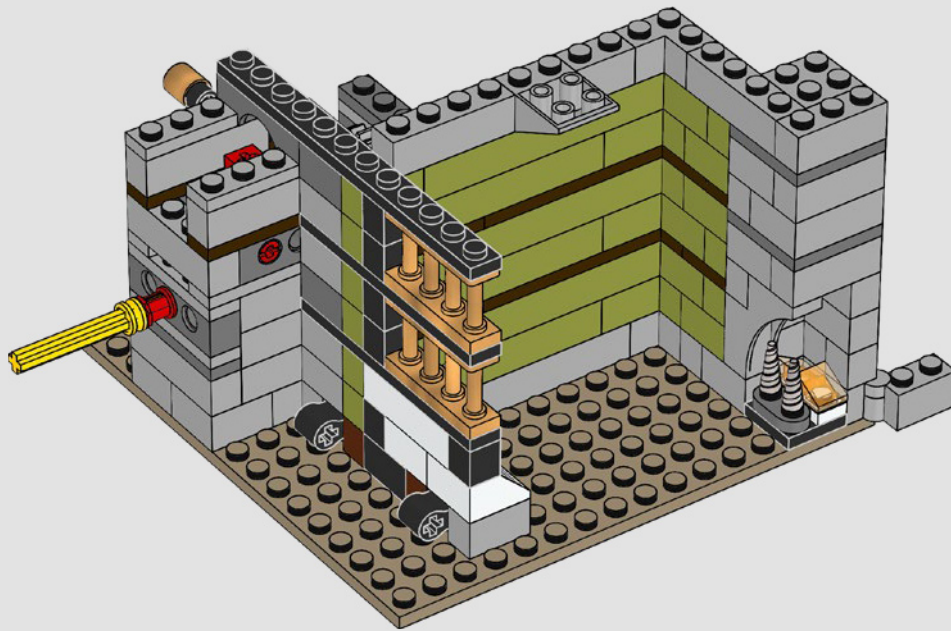

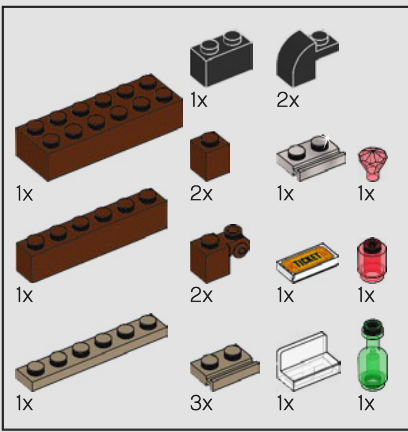

50

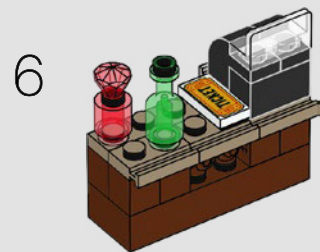
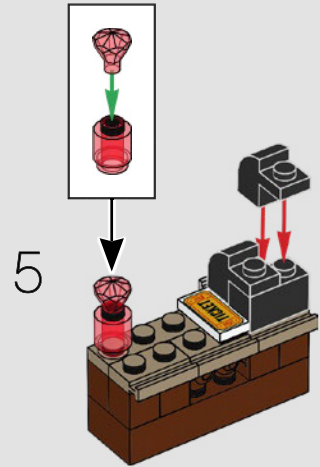
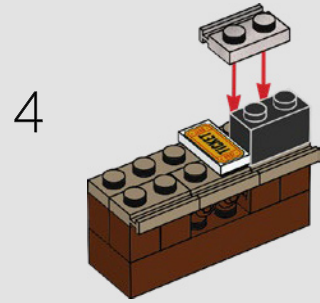
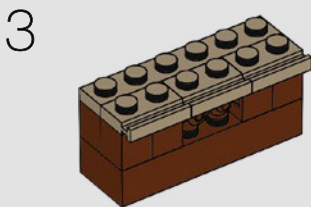
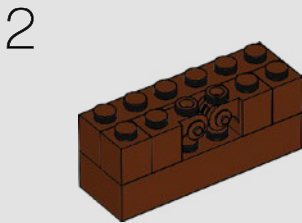
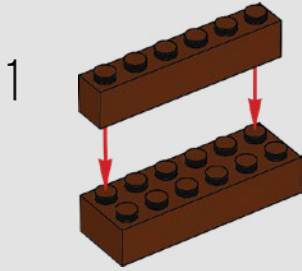

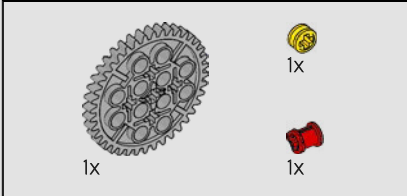
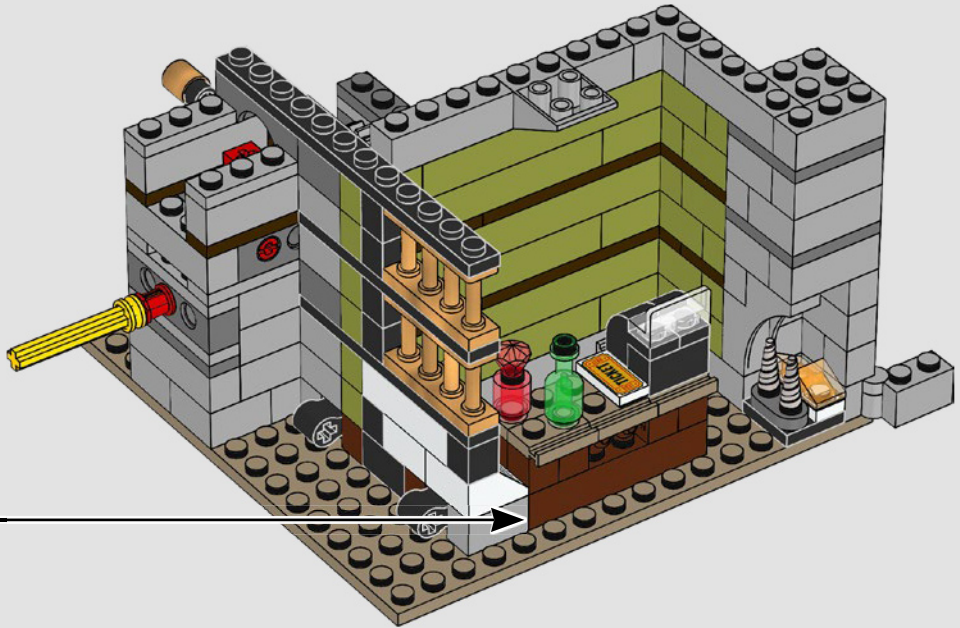

51

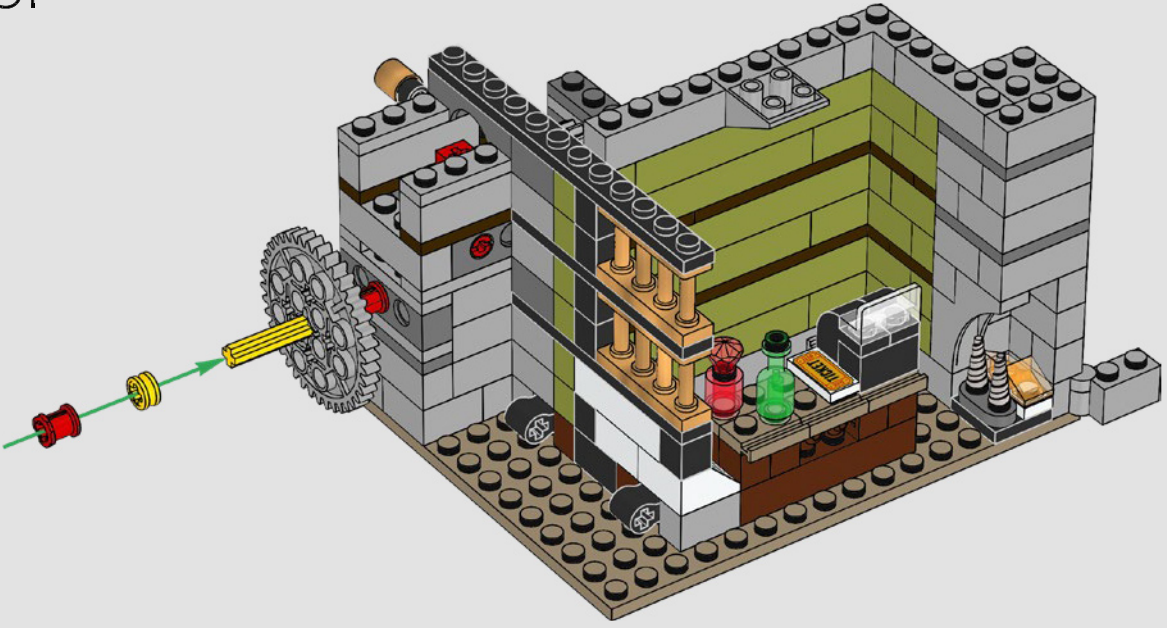

52

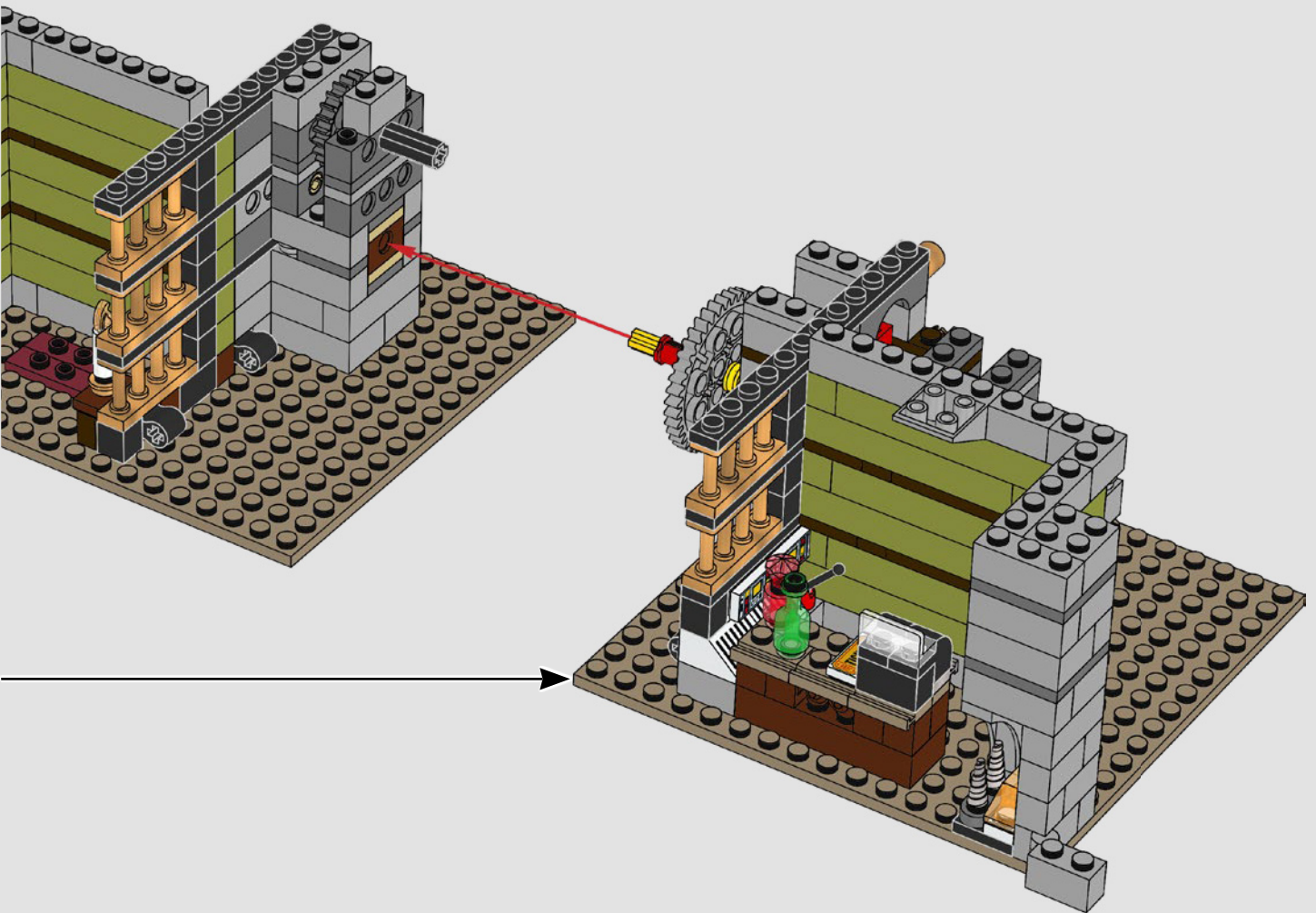

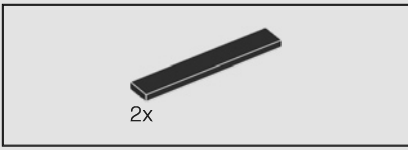

53



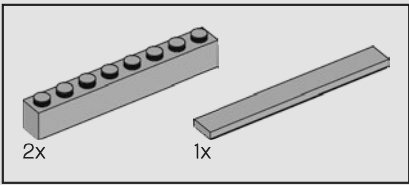

54

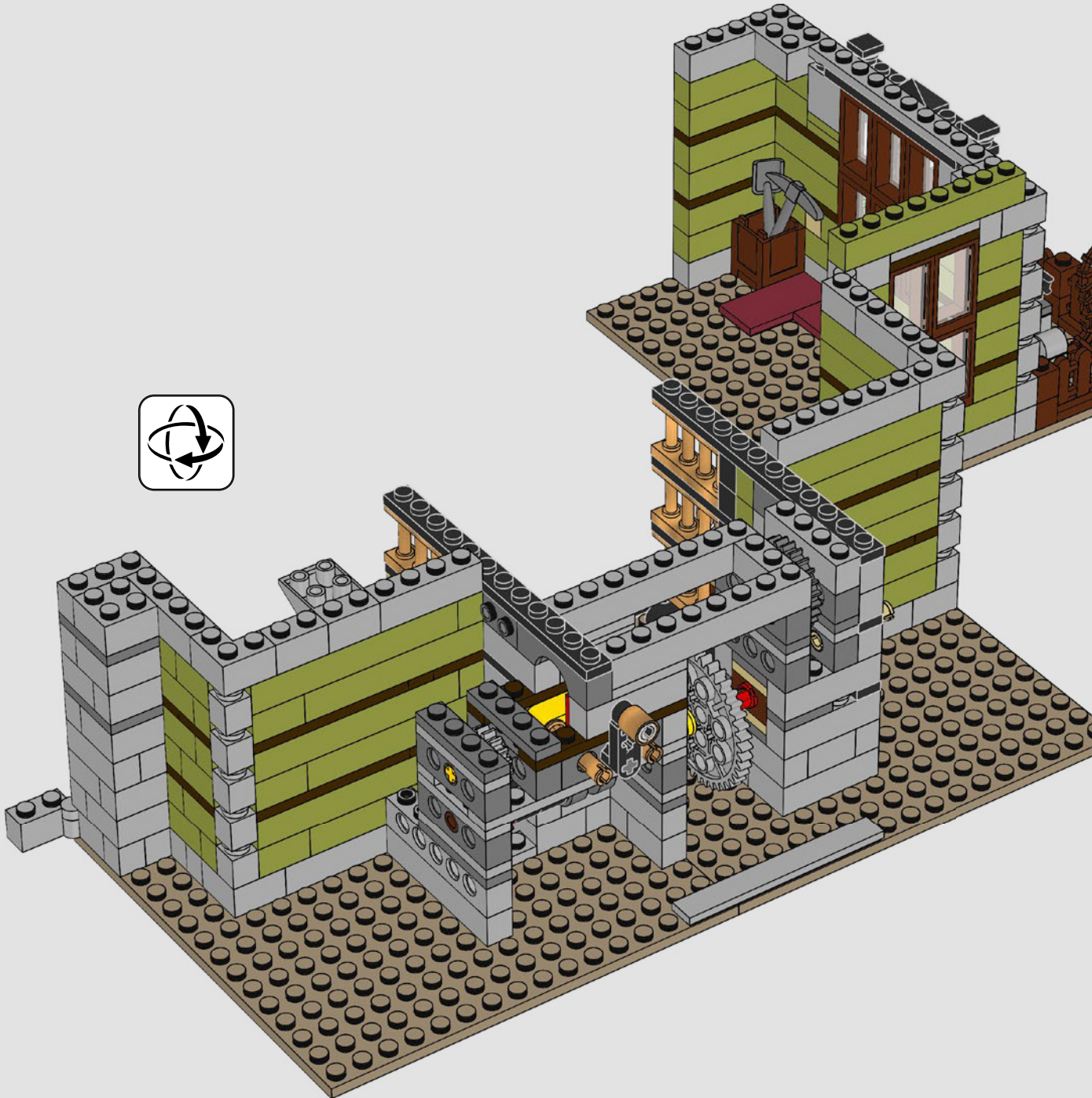

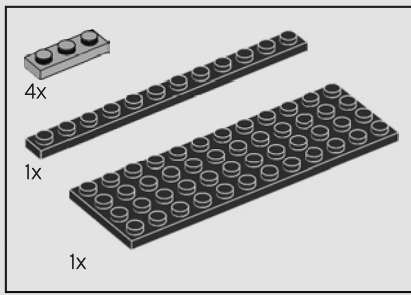

55

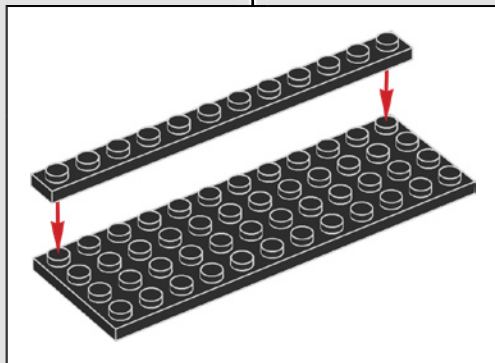
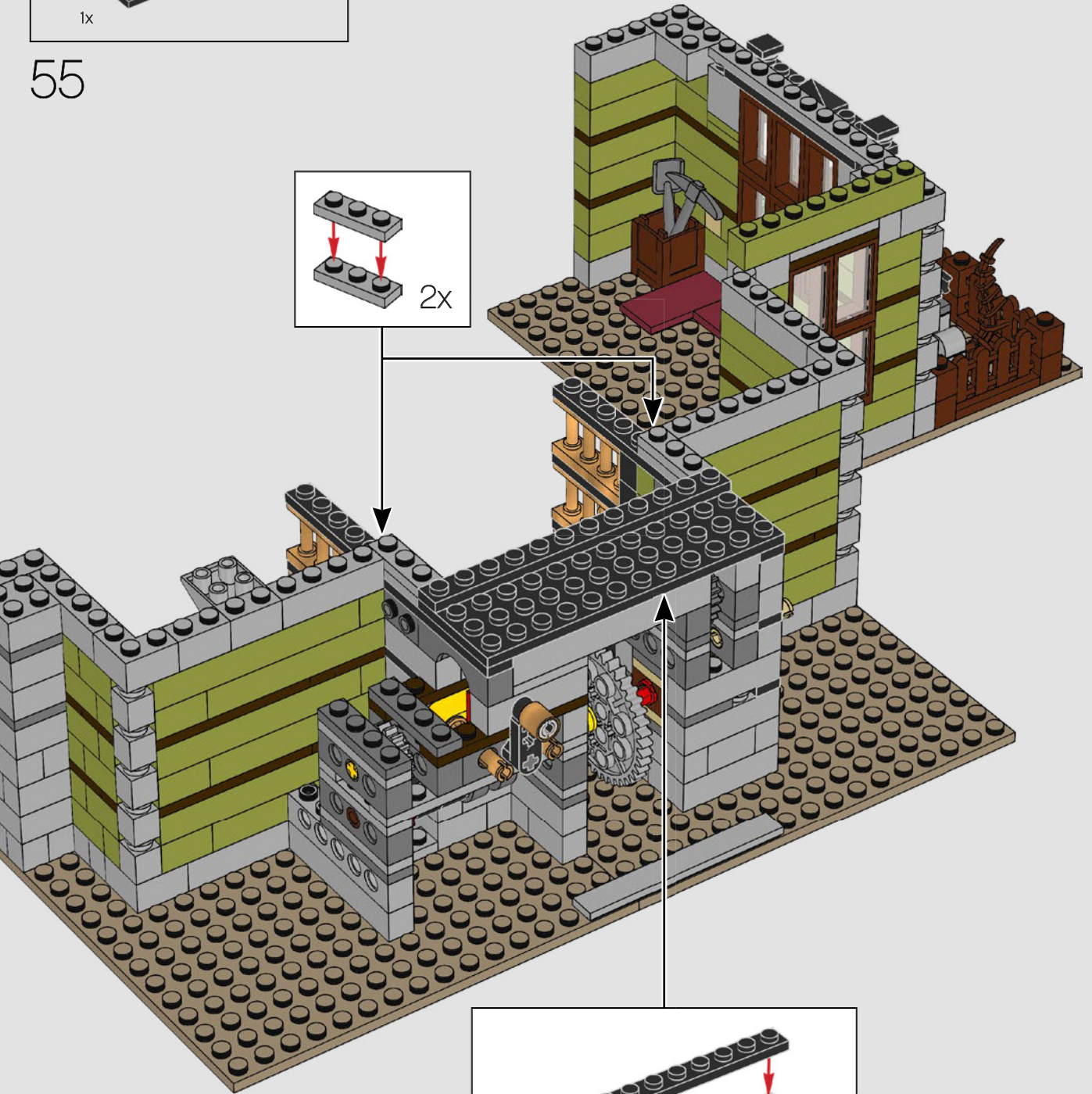
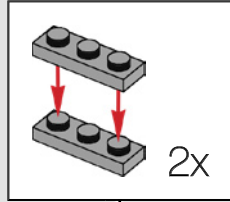

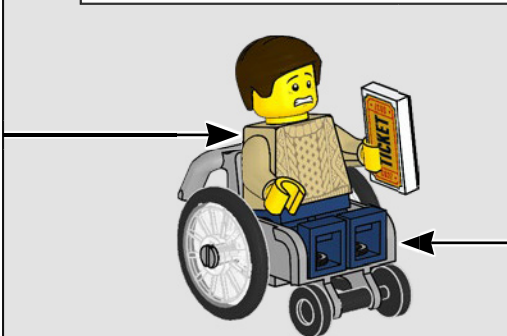
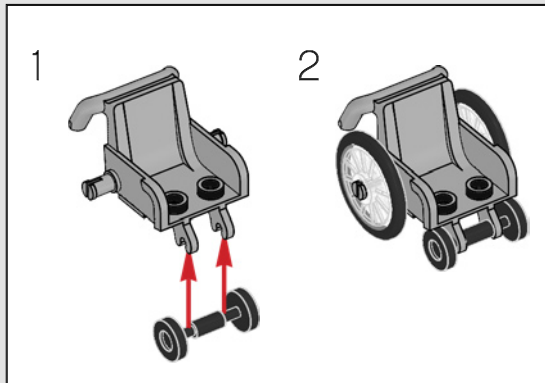
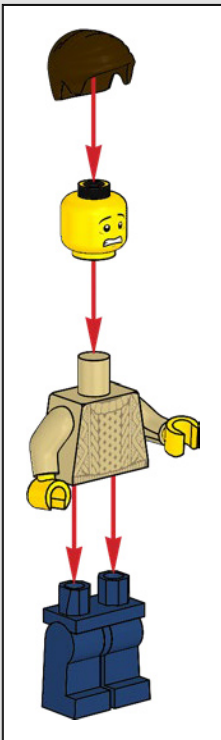
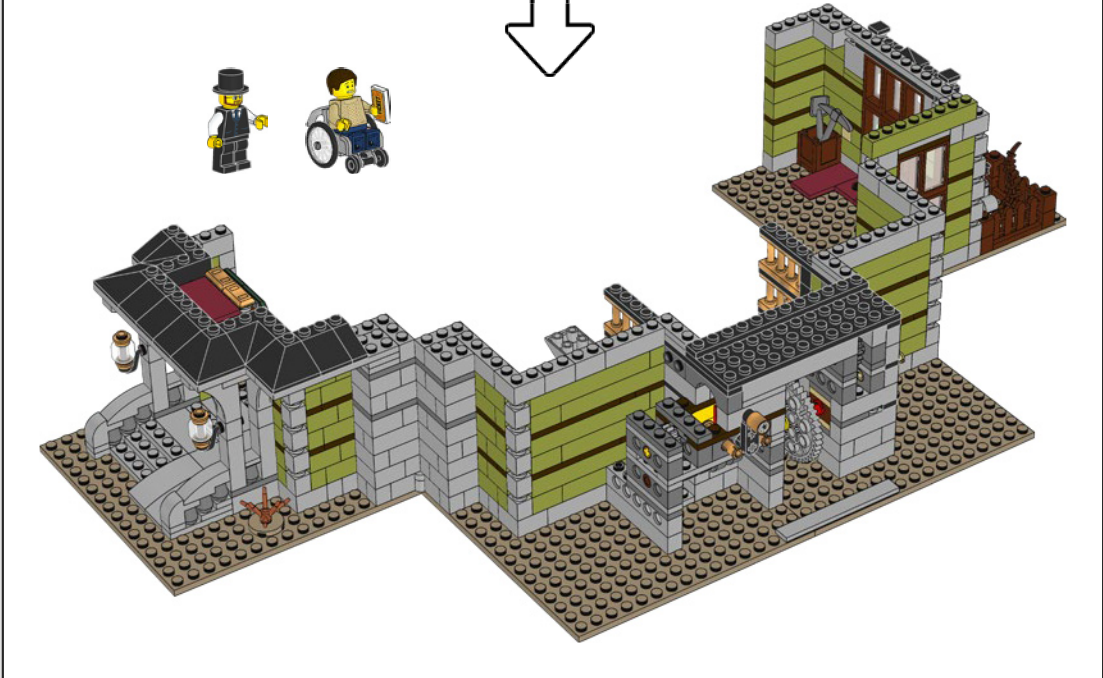
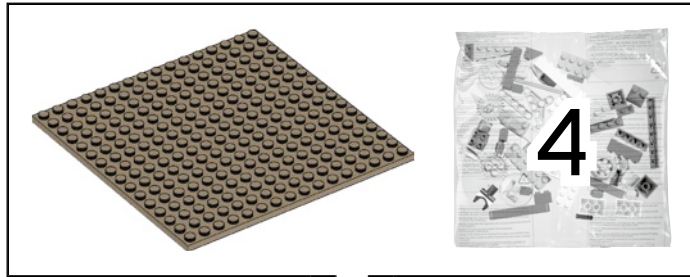

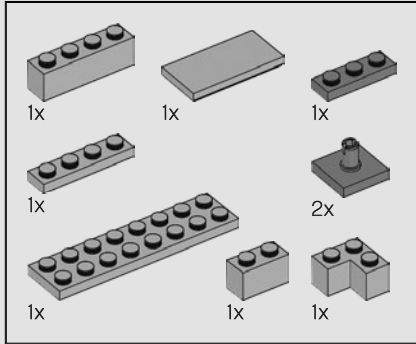
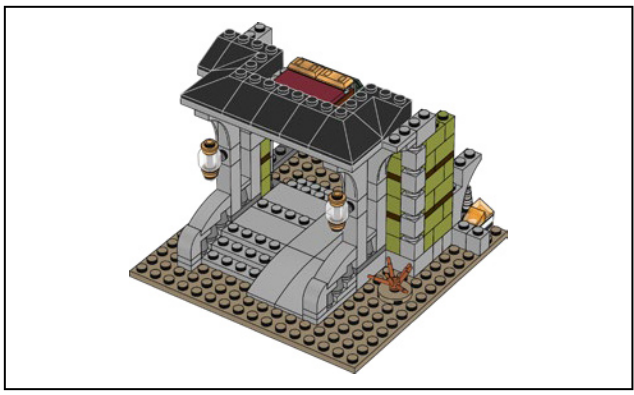

56

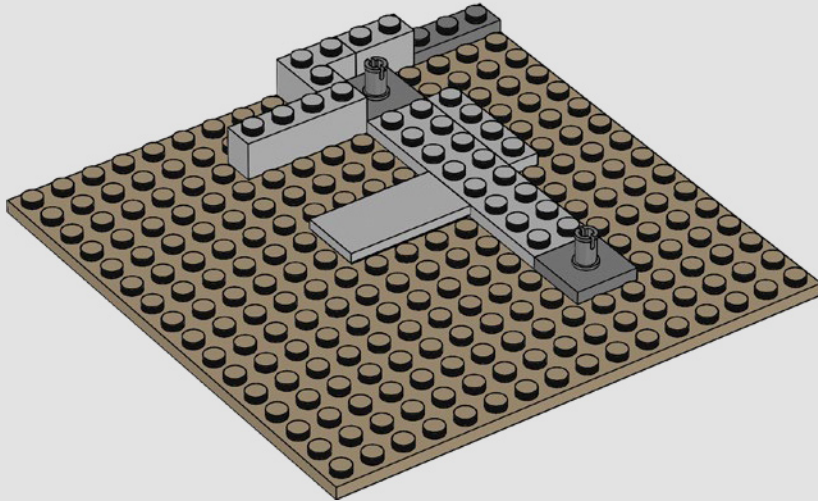

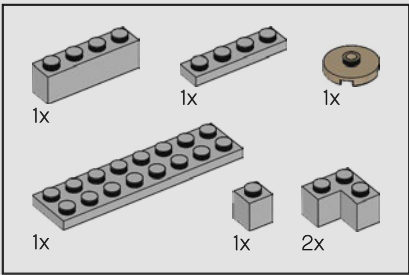

57

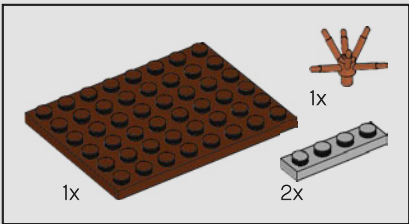
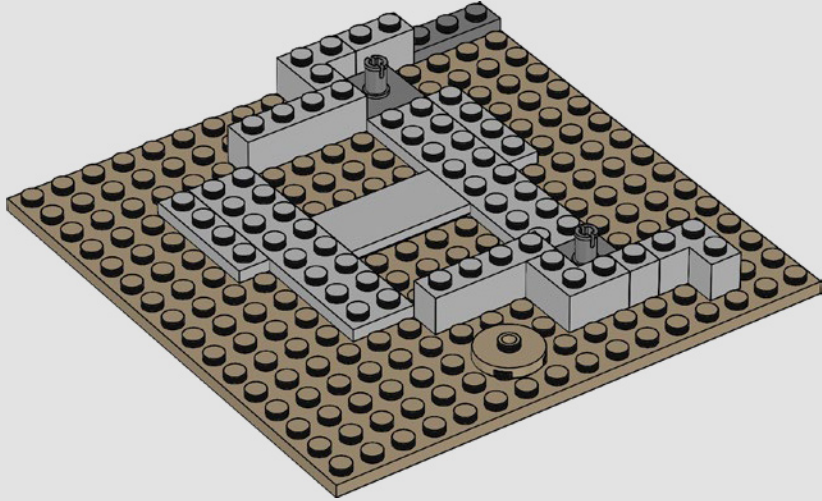

58

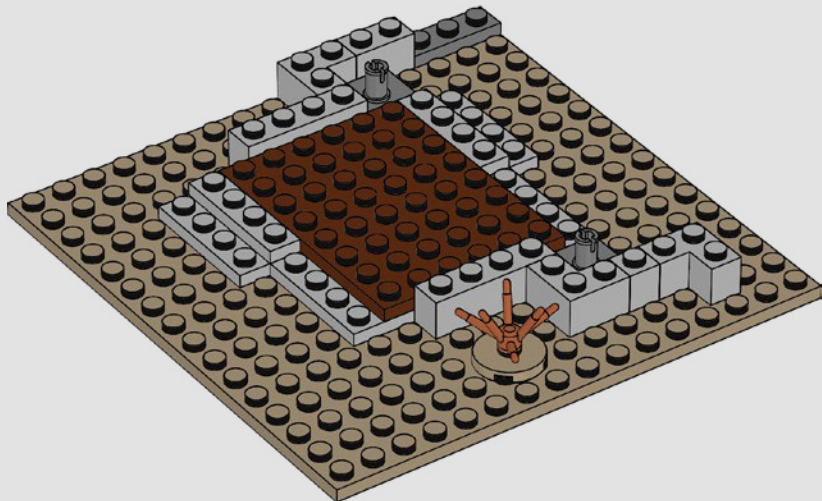

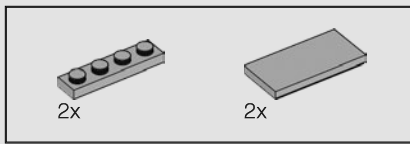

59

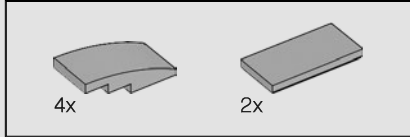
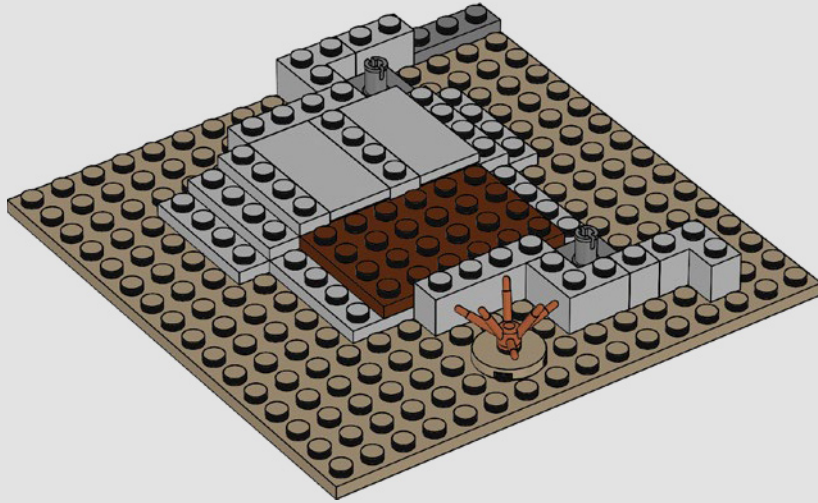

60

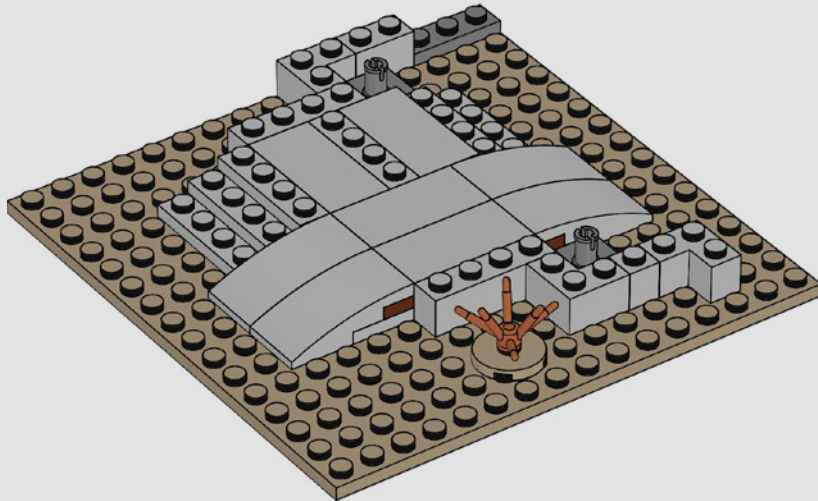

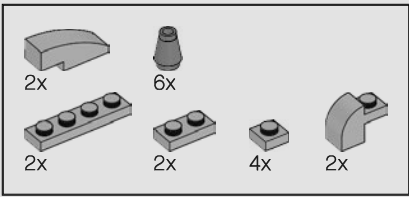

61

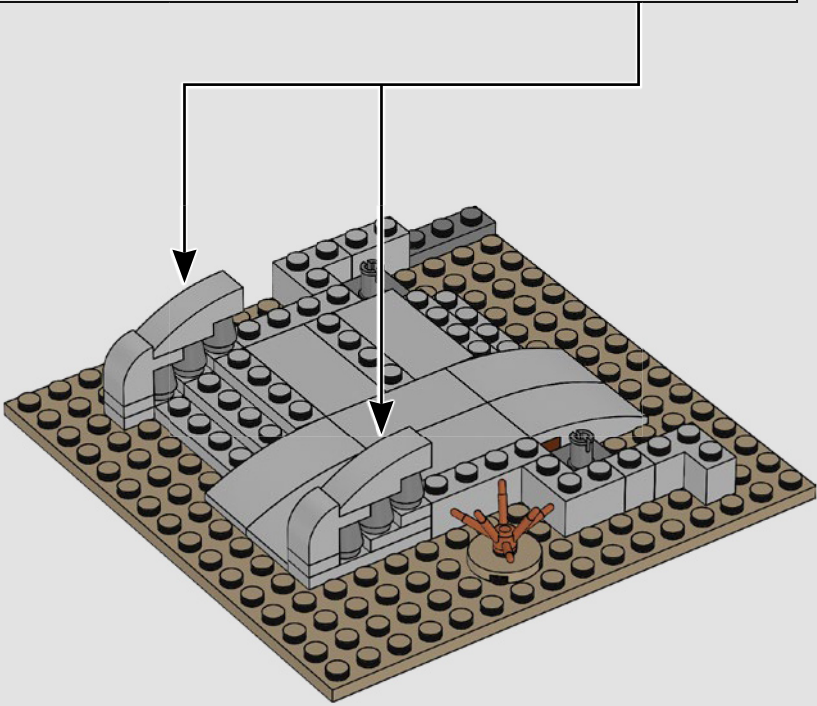
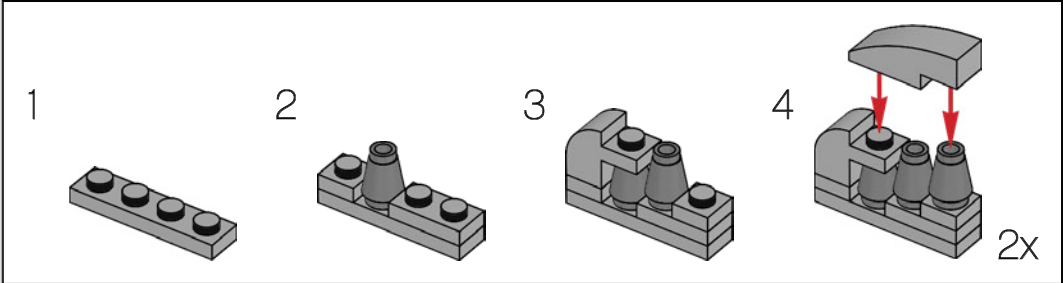

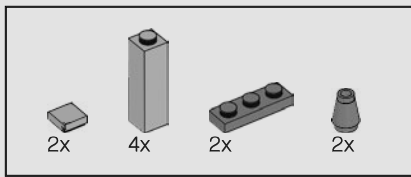

62

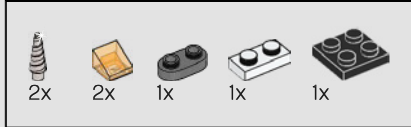
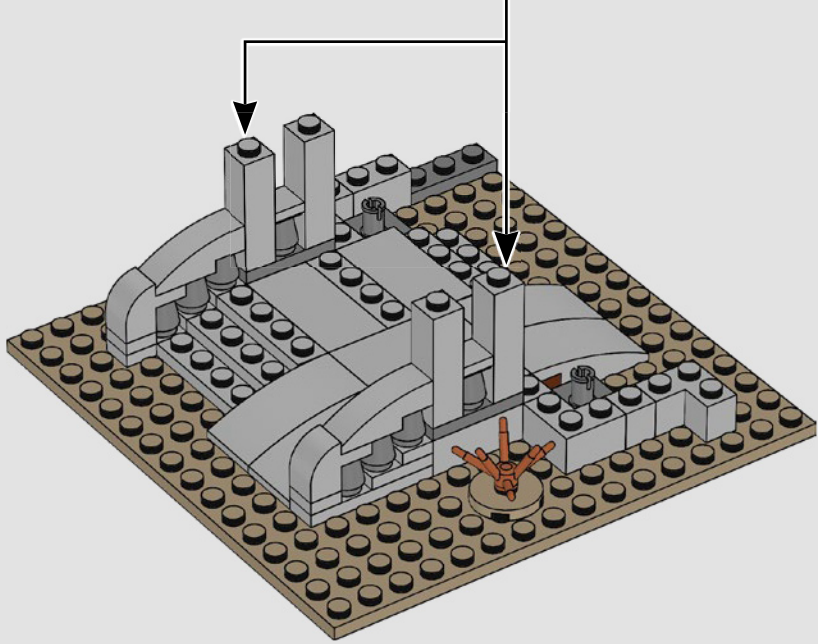
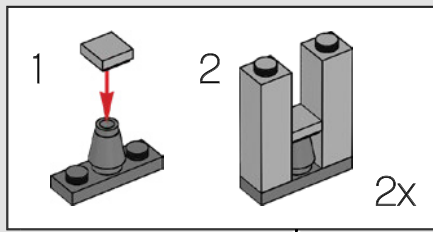

63

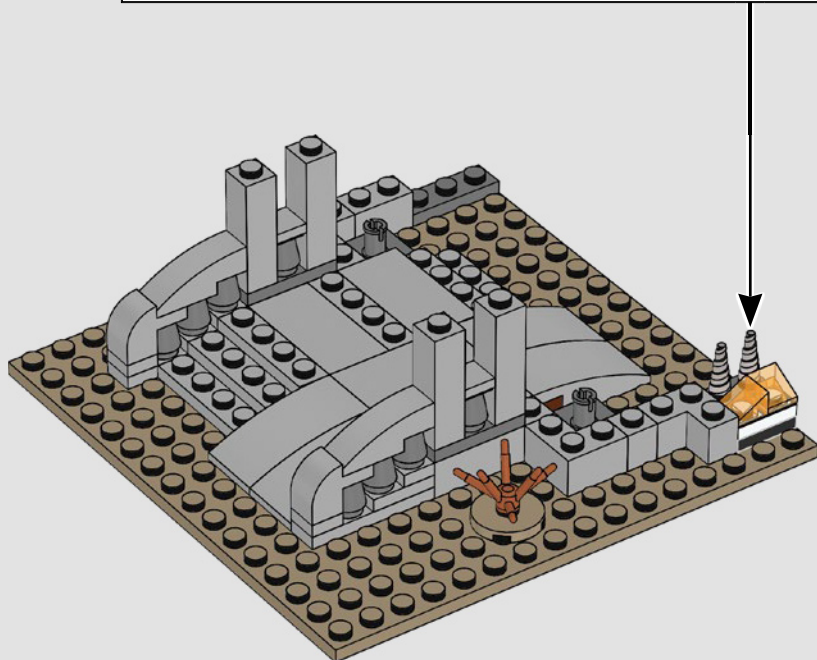
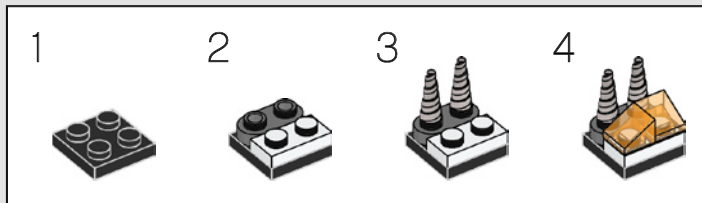

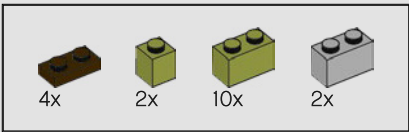

64

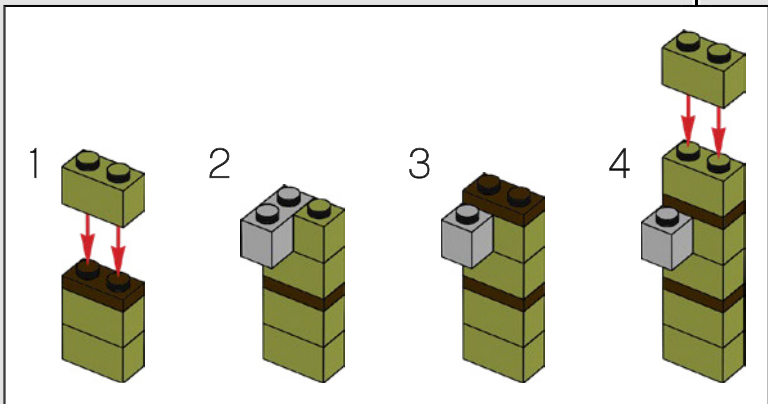
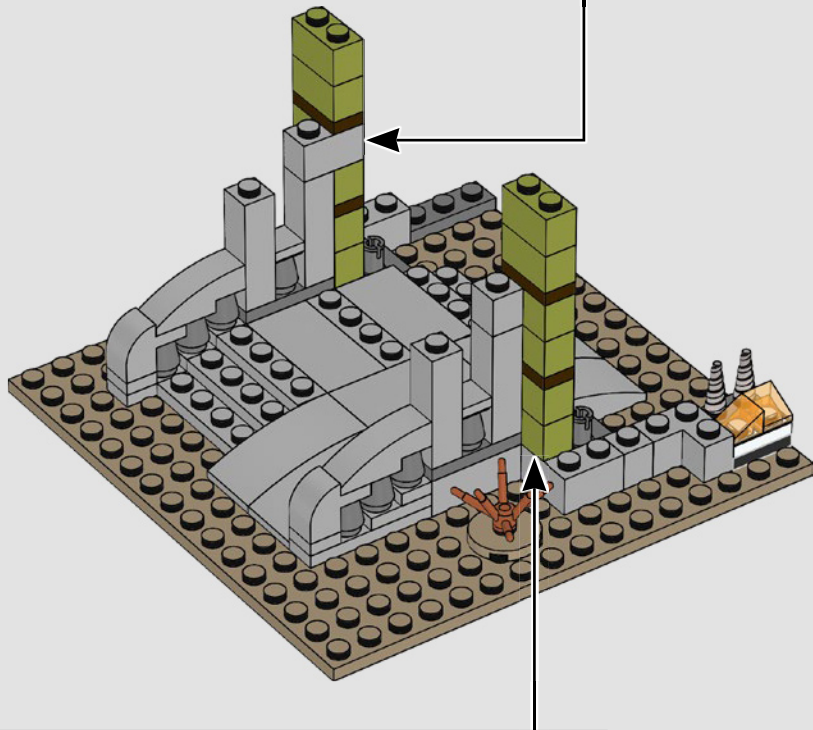
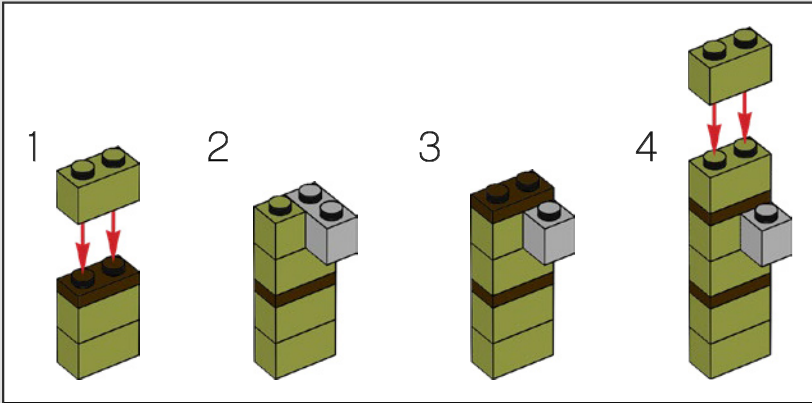

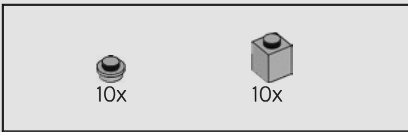

65

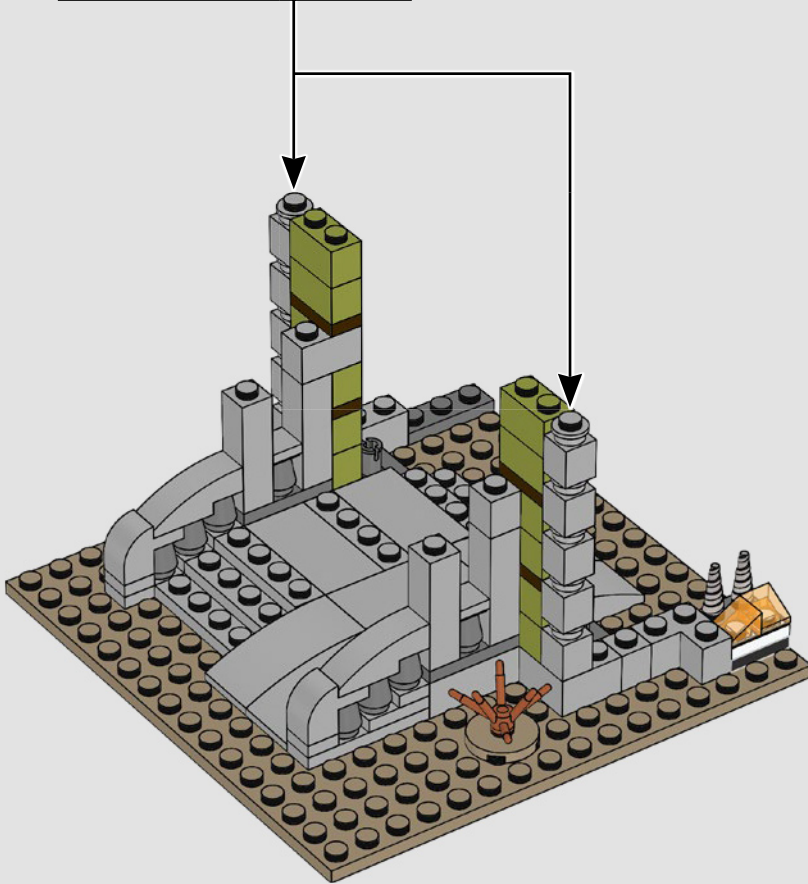
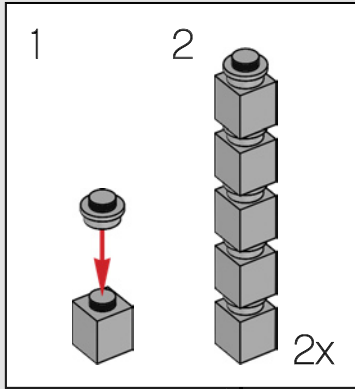

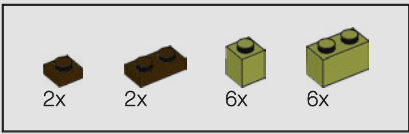

66

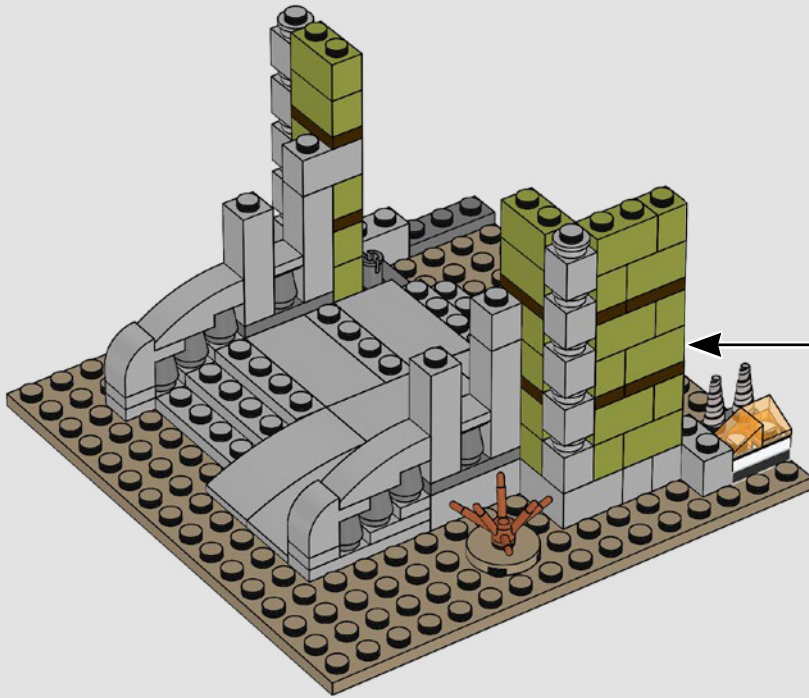
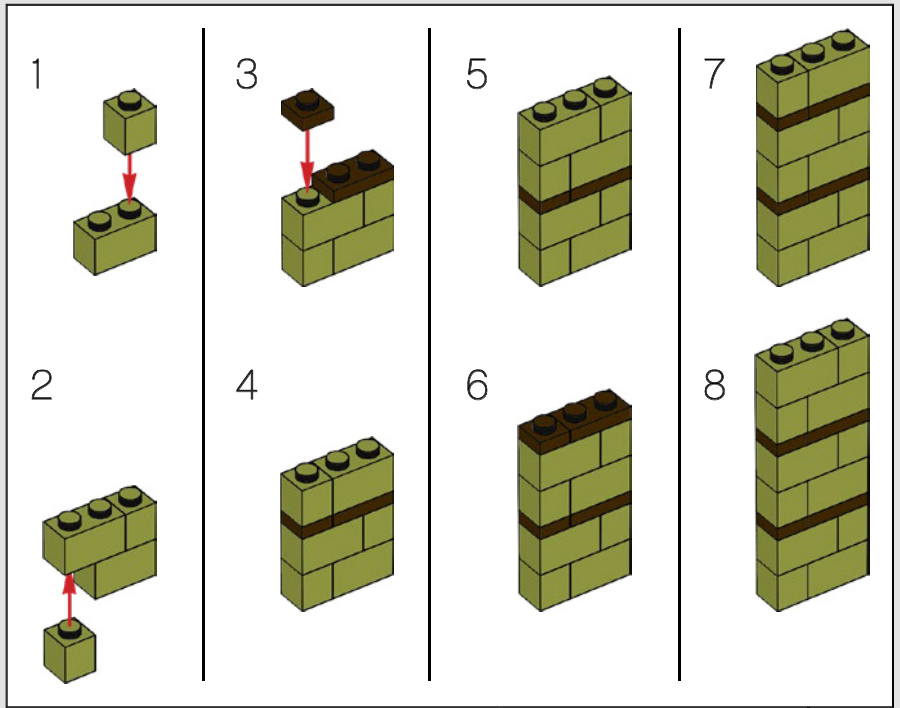

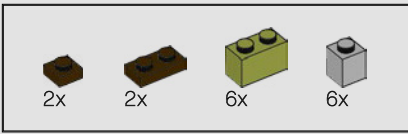

67

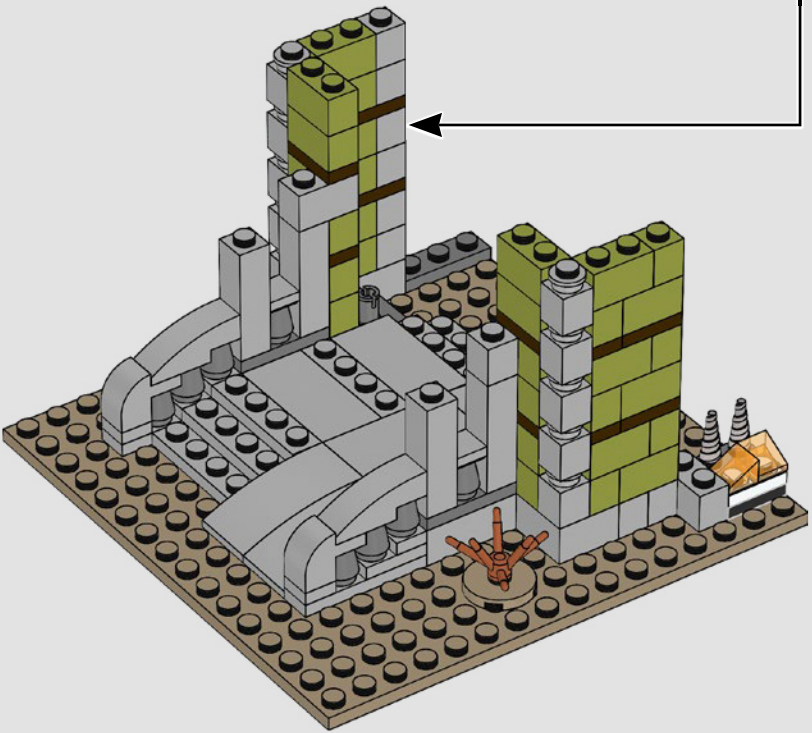
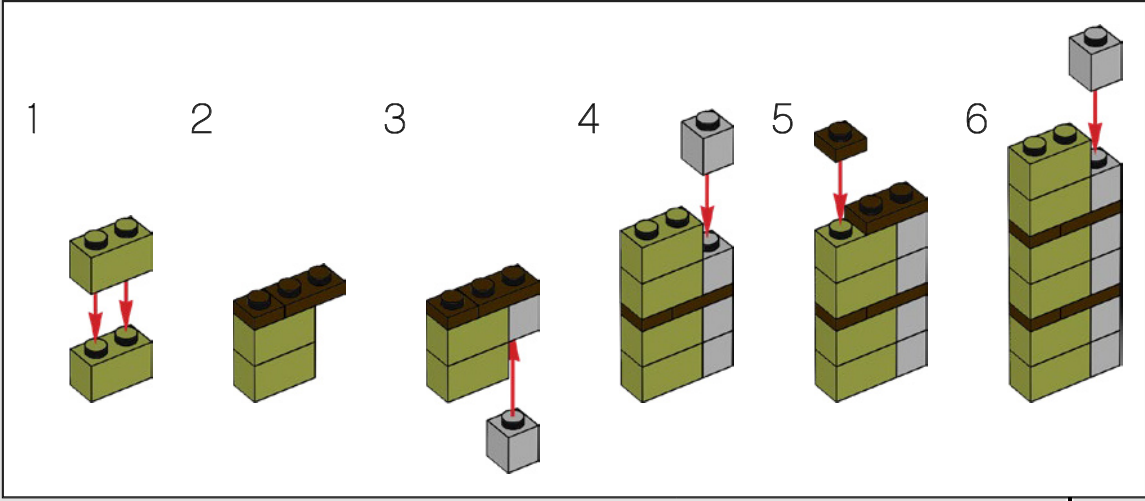

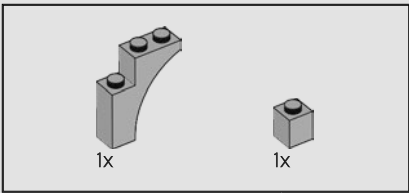

68

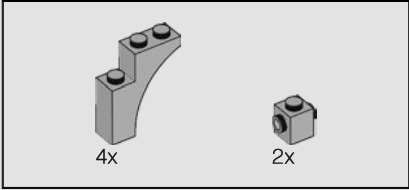
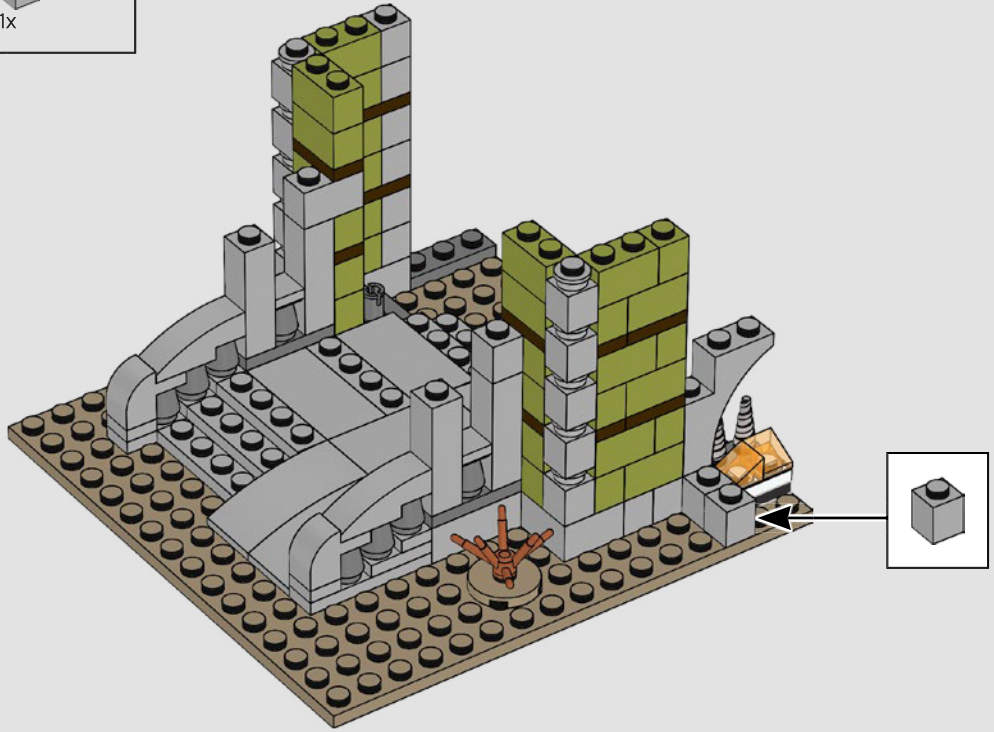

69

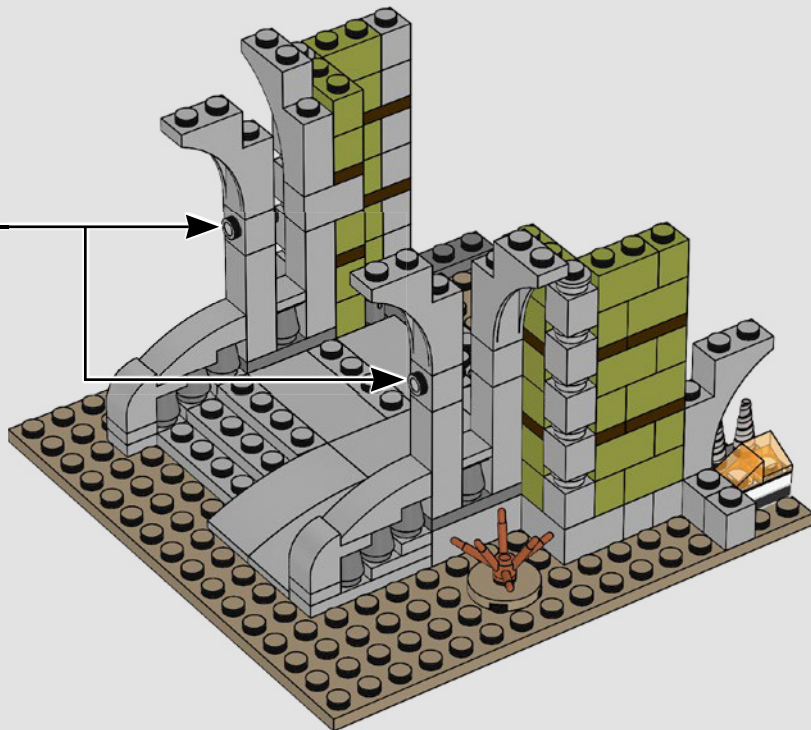
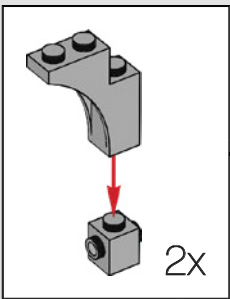

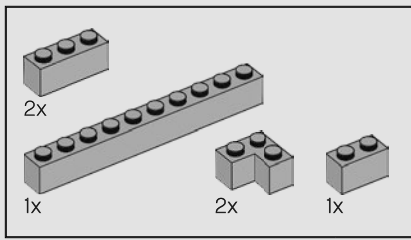

70

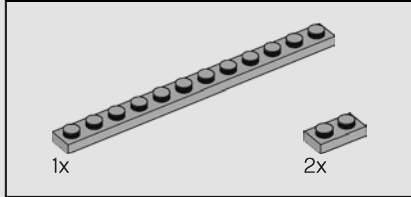
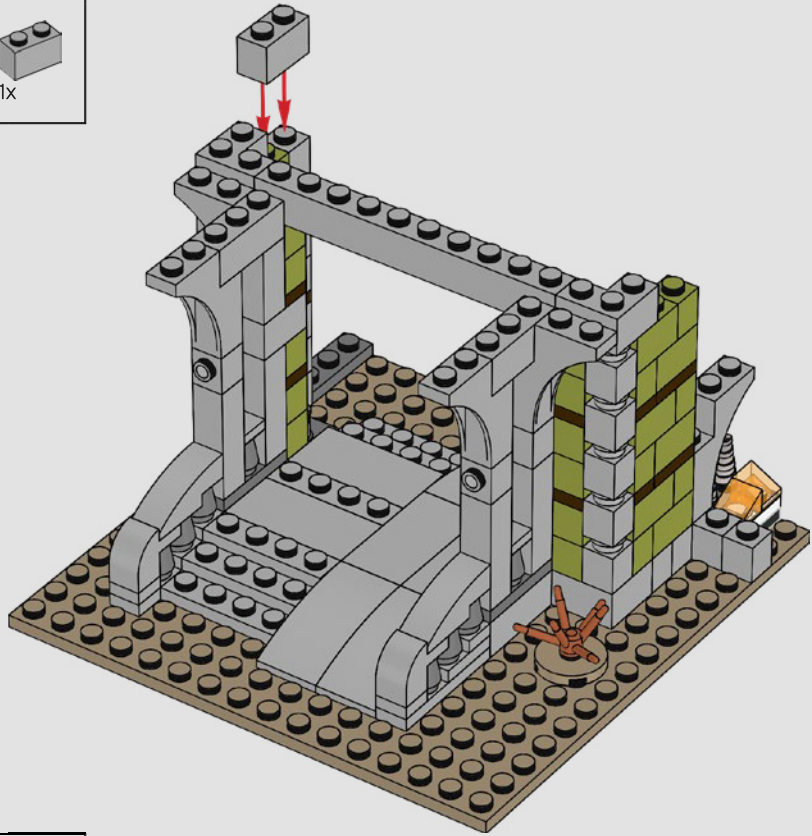

71

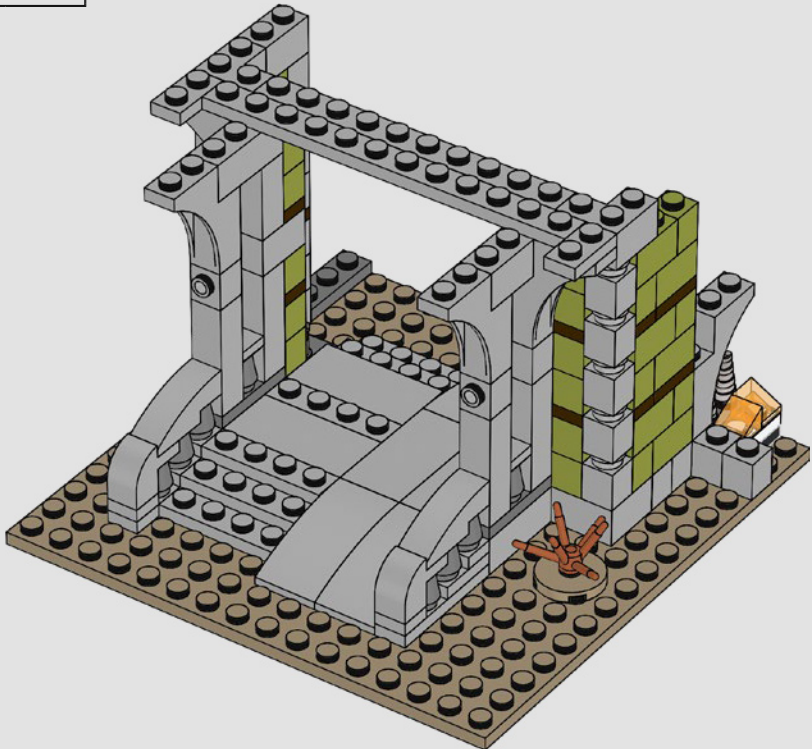

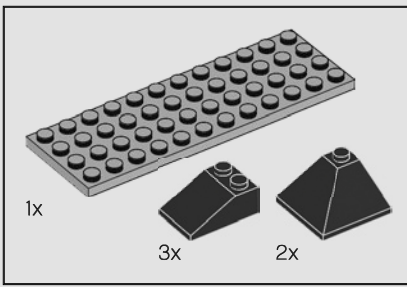

72

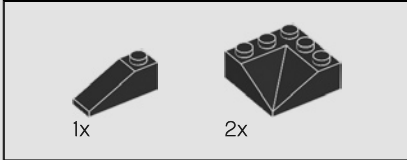
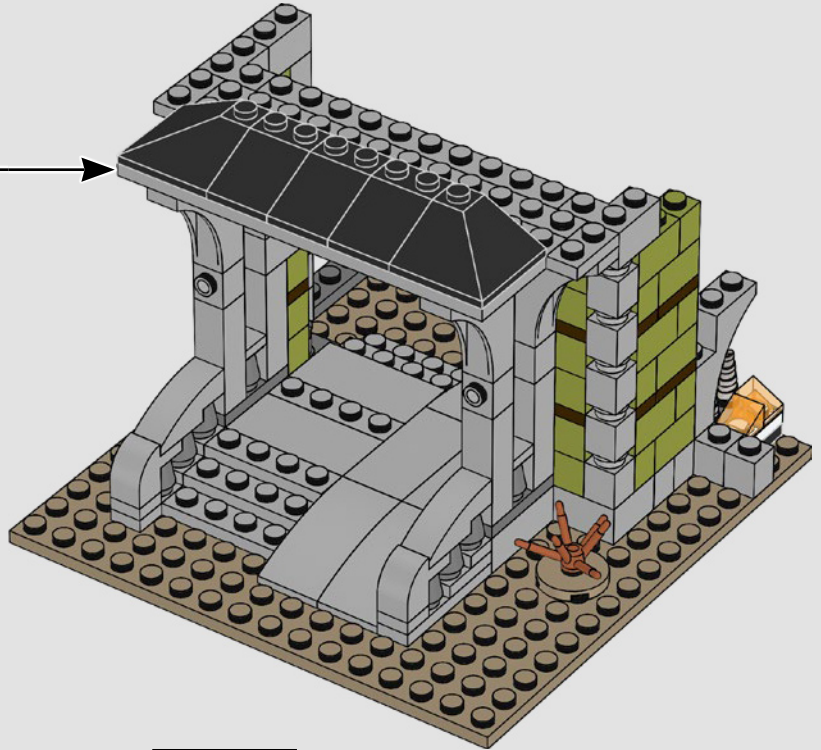
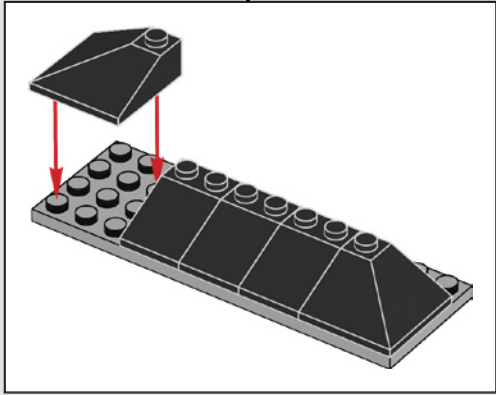

73

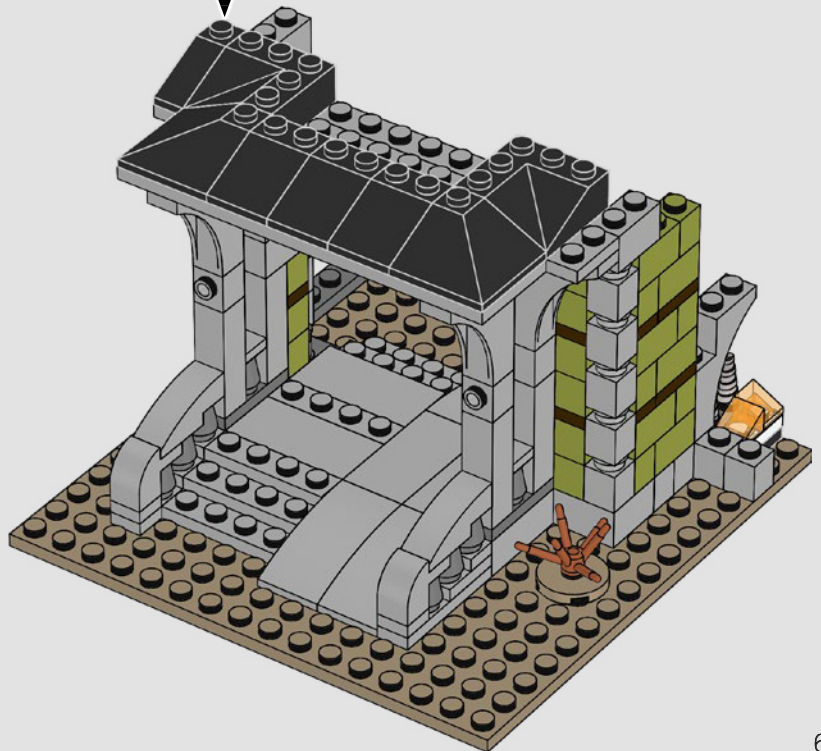
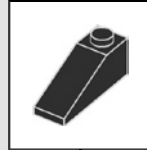

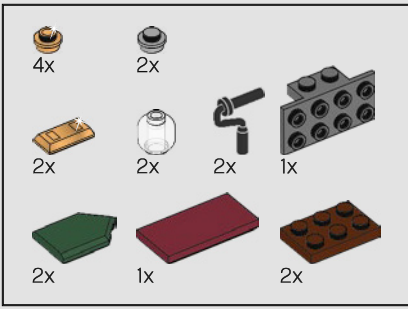

74

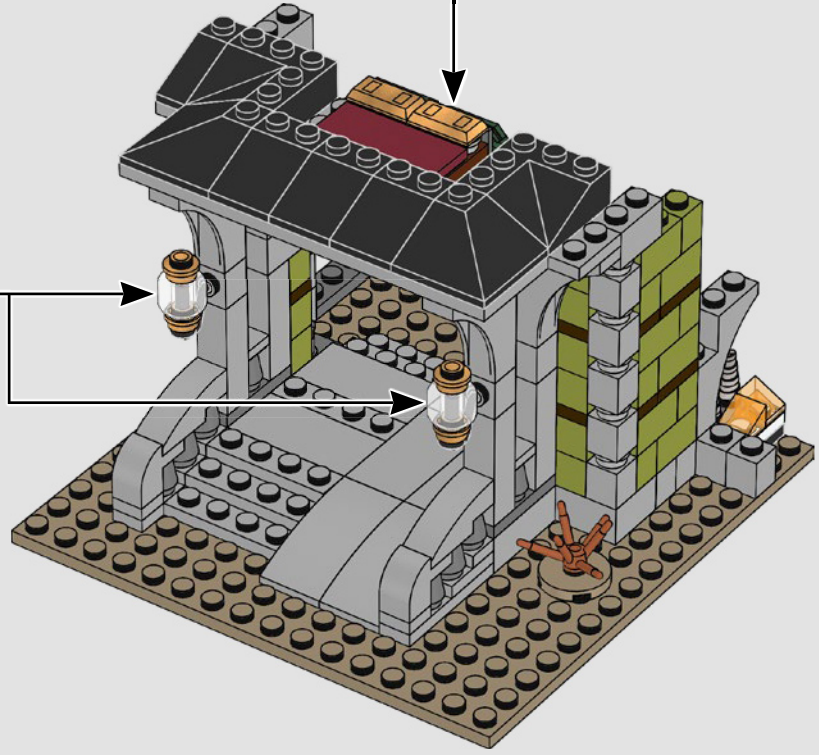
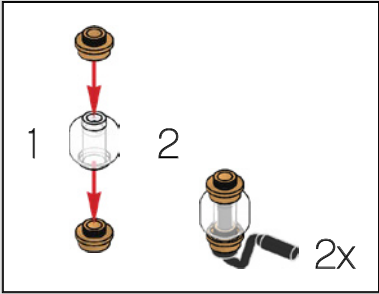
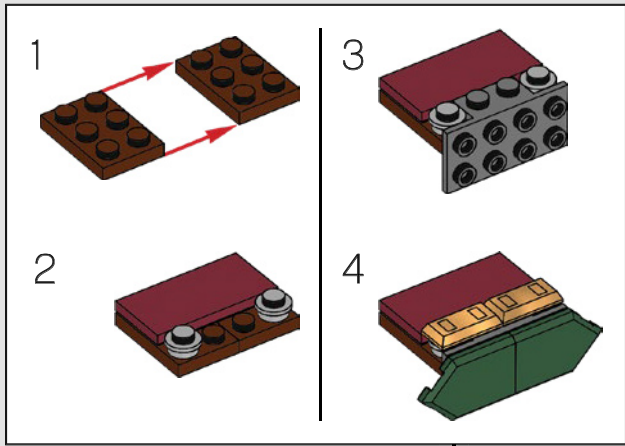

75

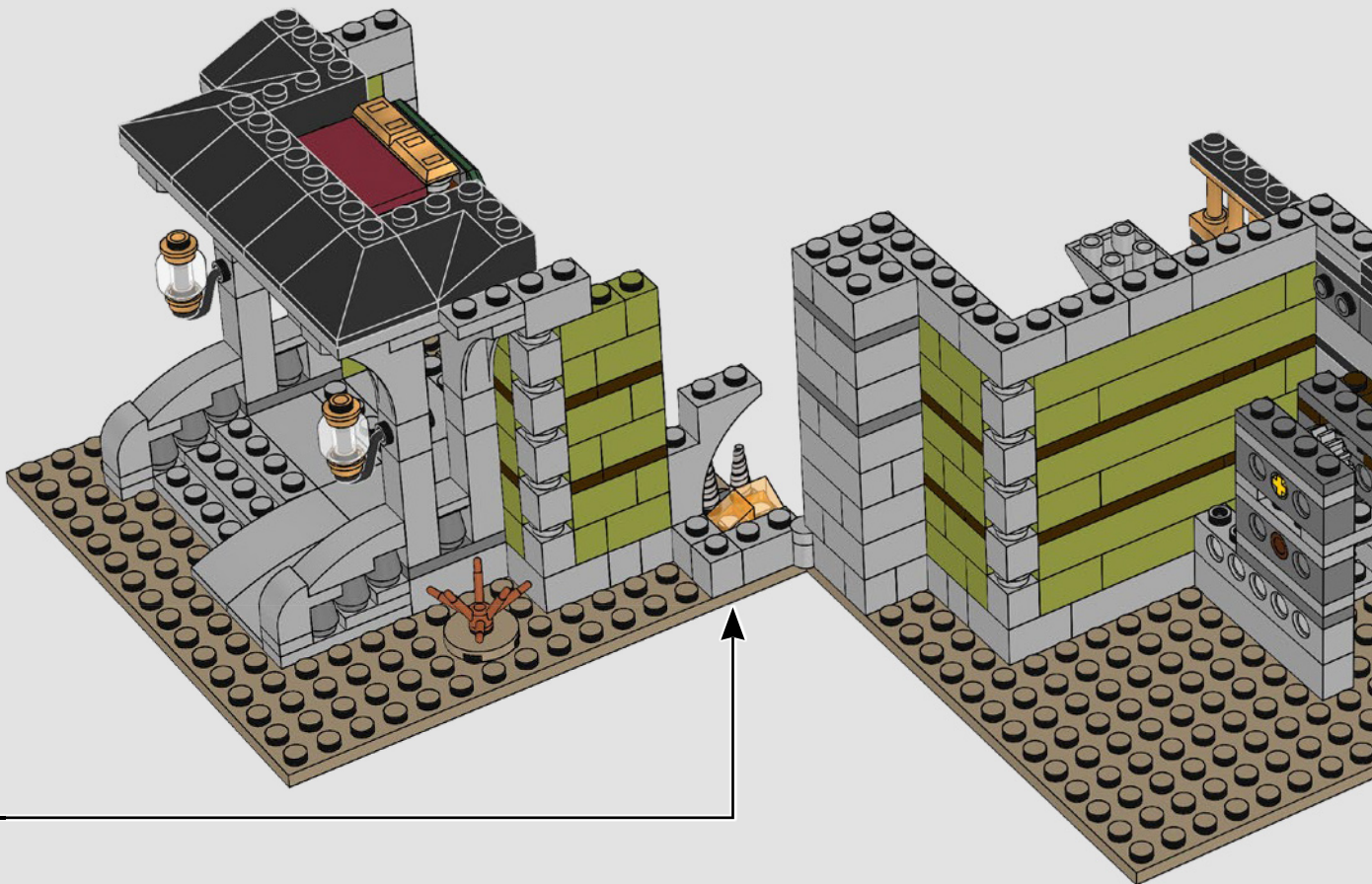

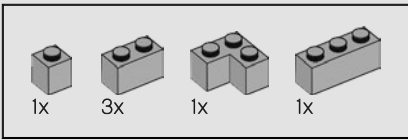

76

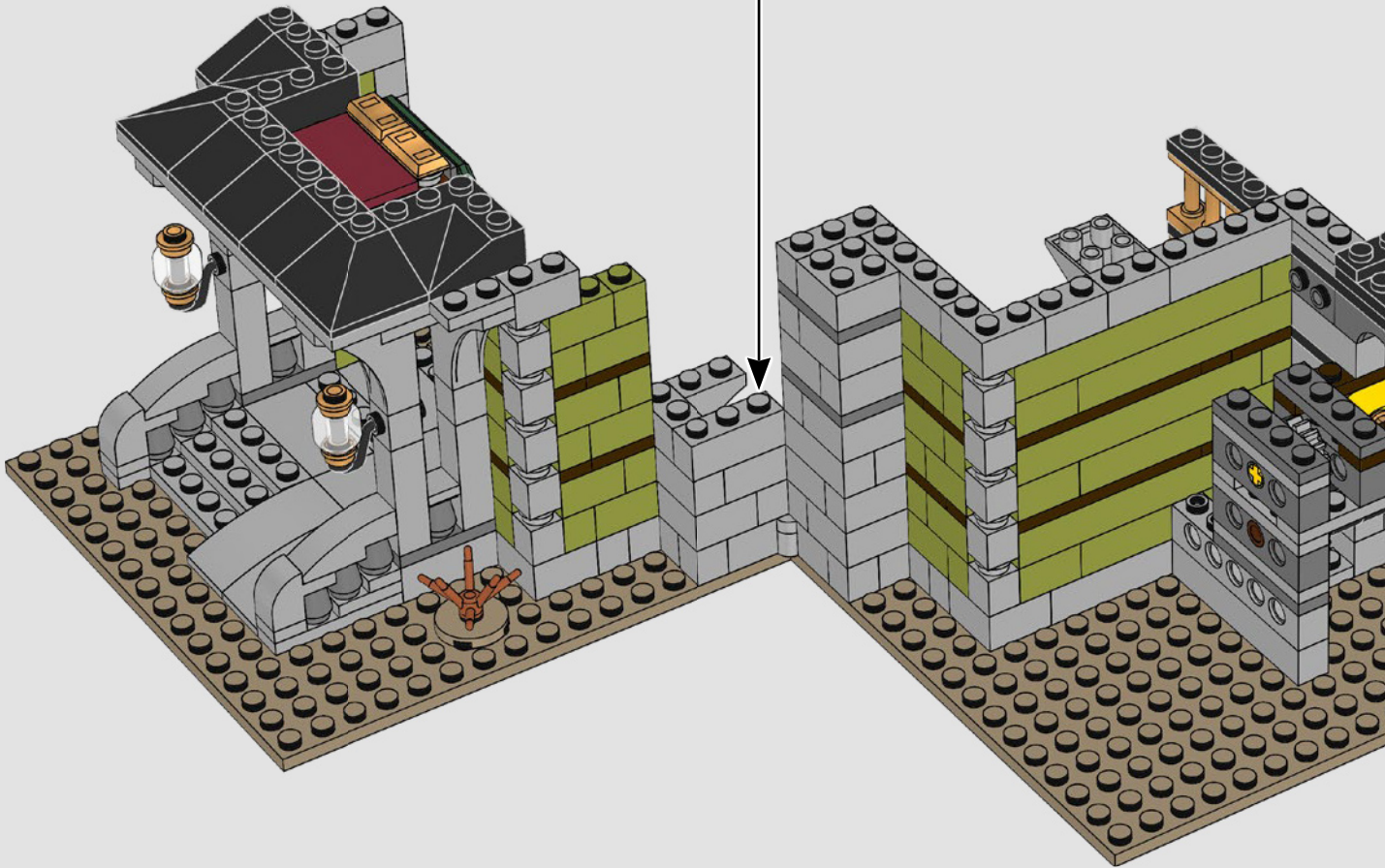
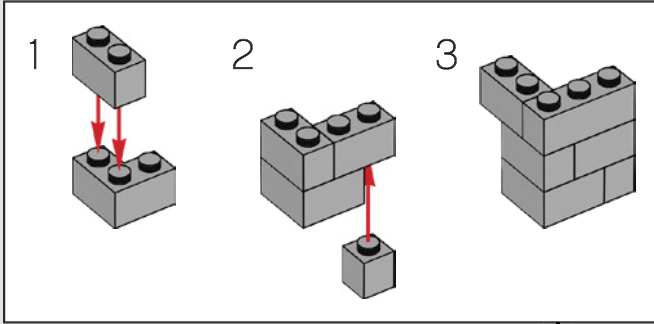

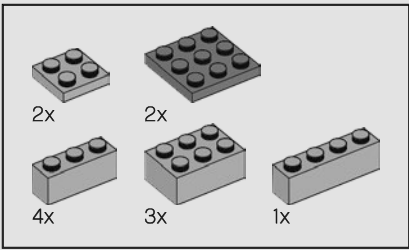

77

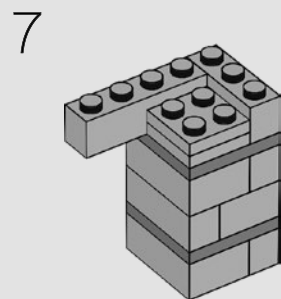
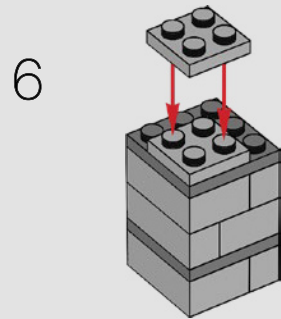
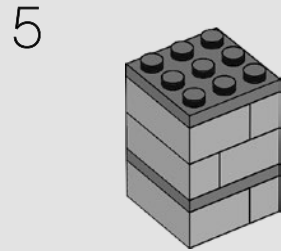
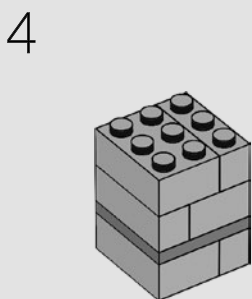
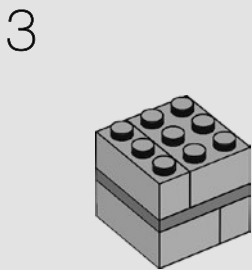
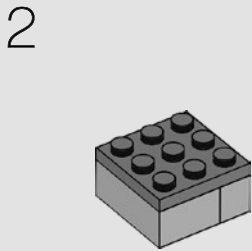
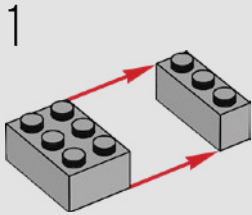

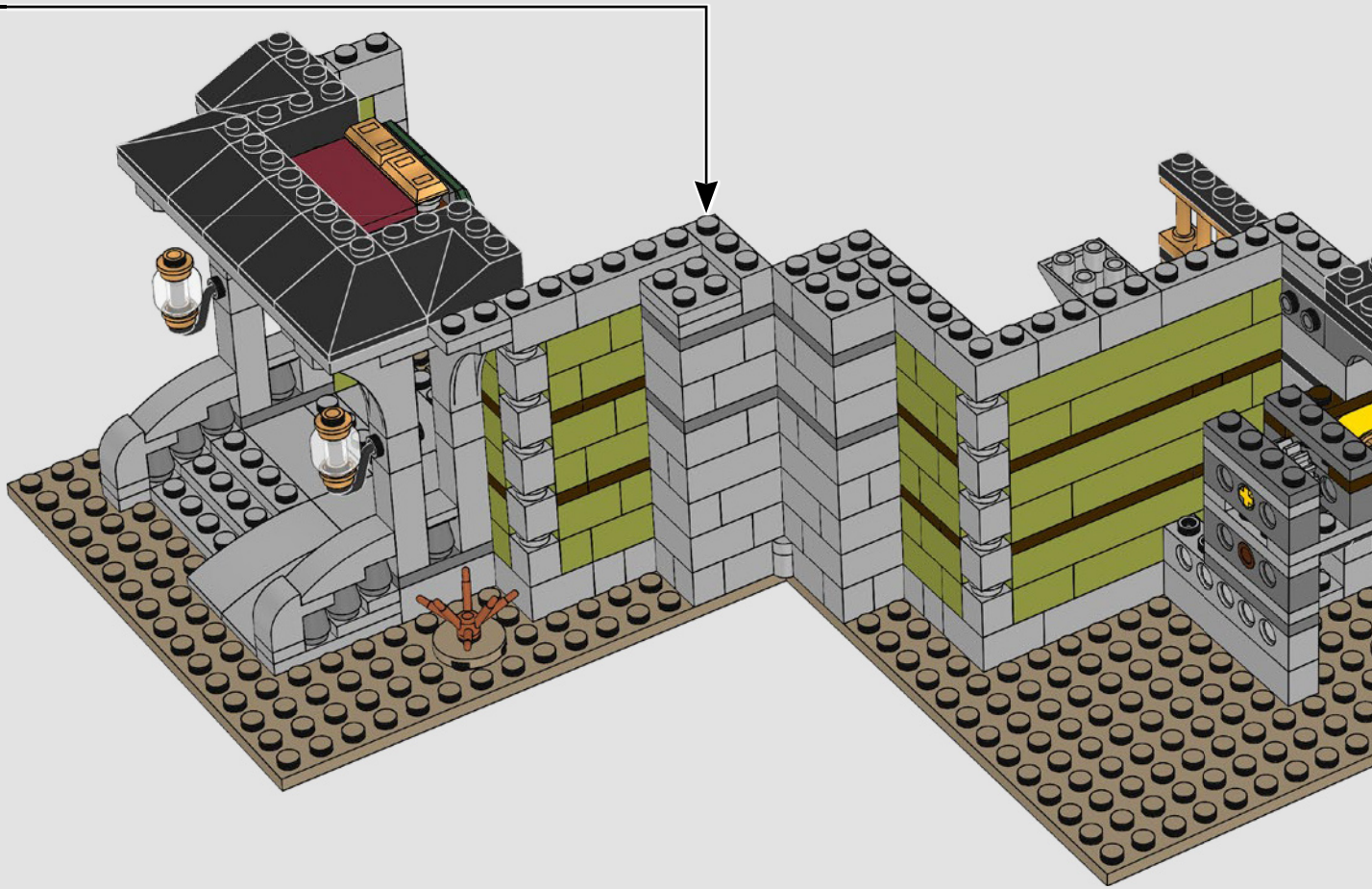

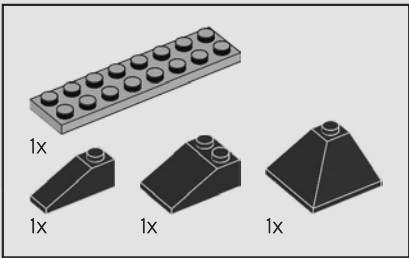

78

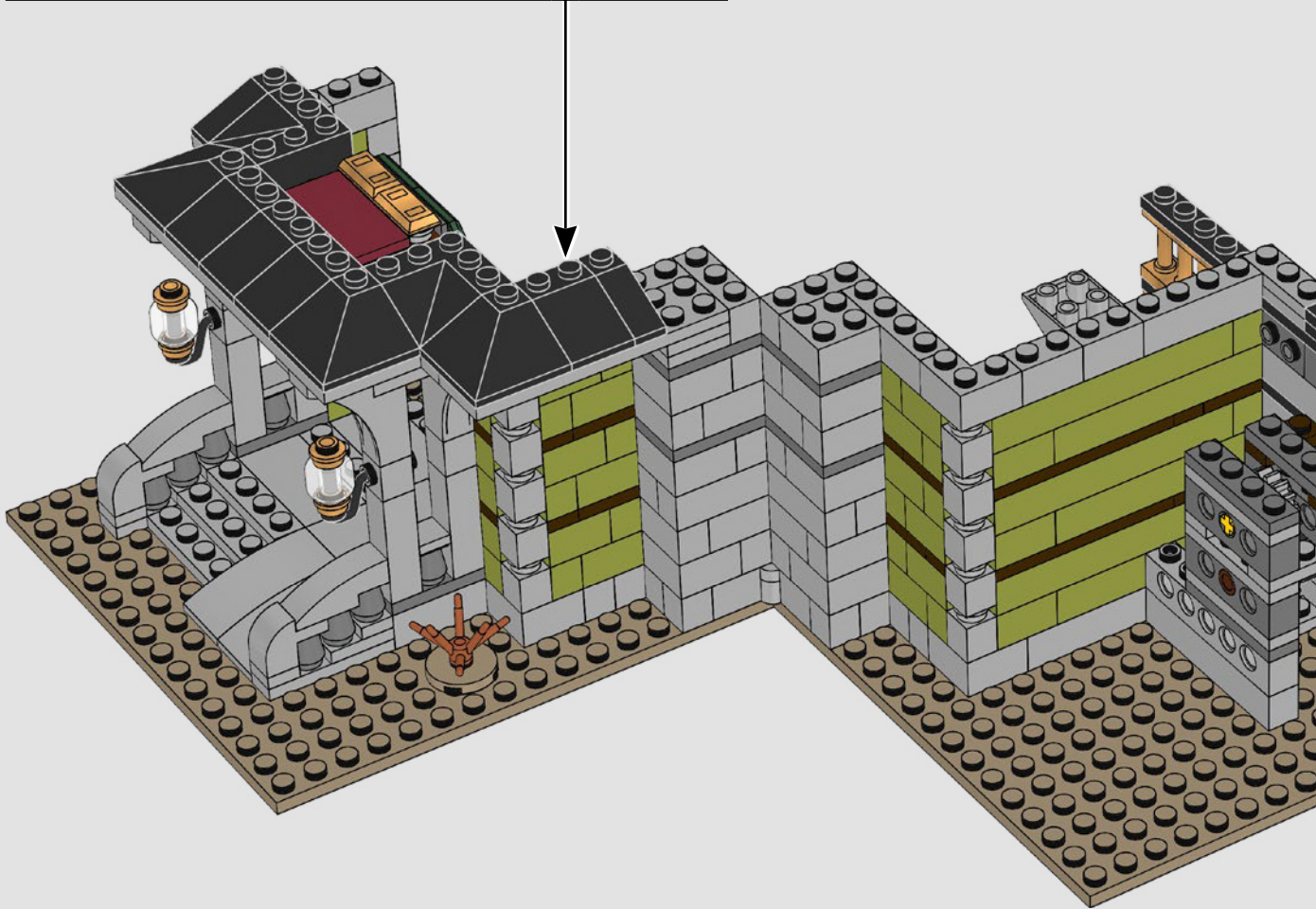
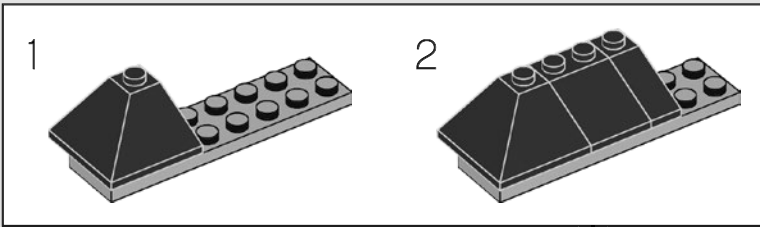

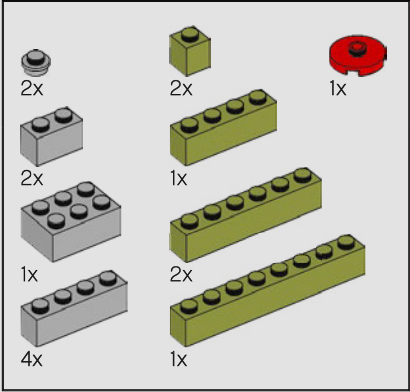

79

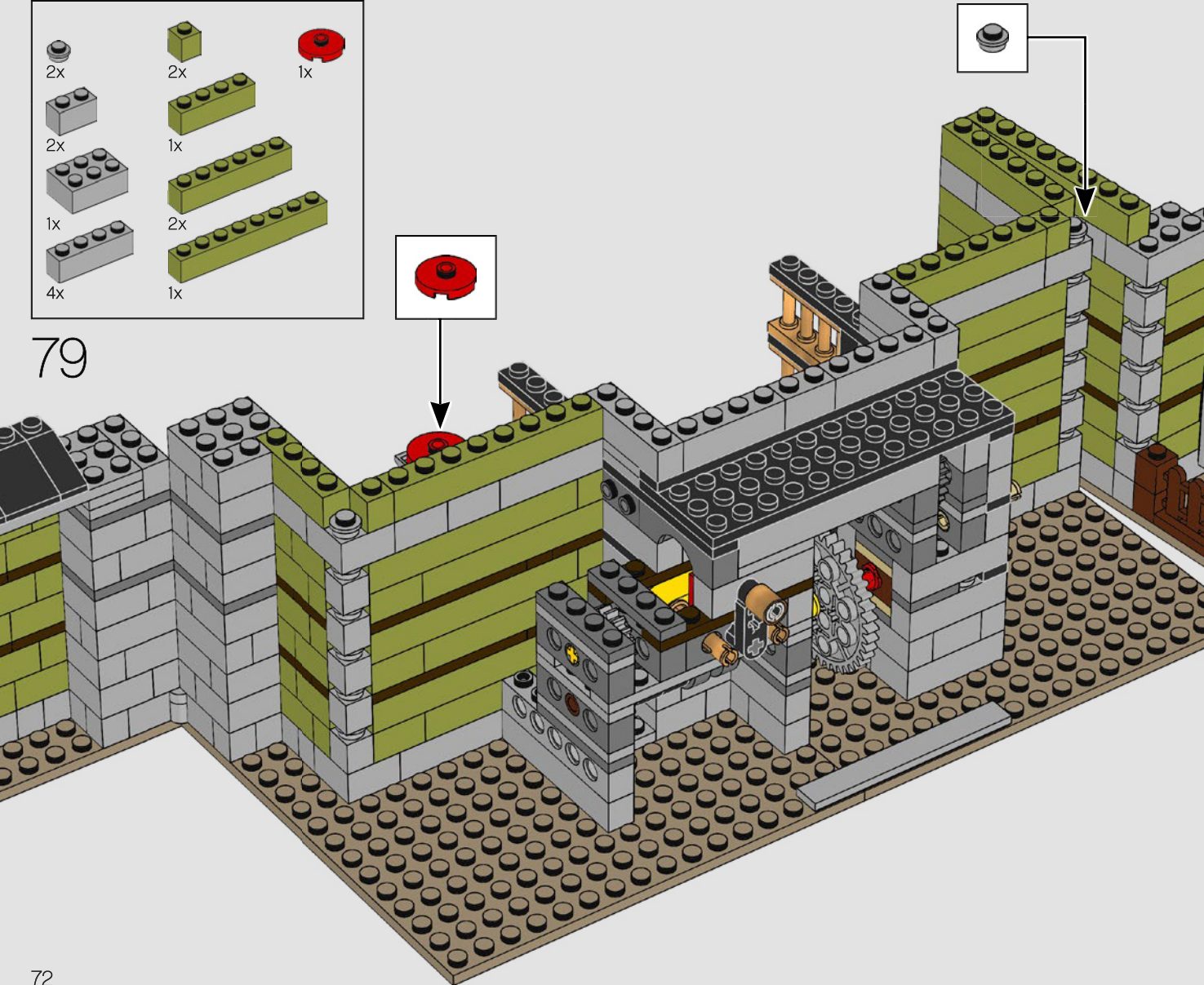

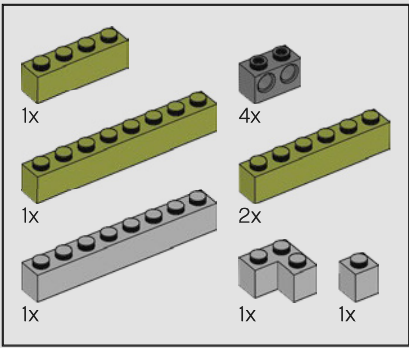

80

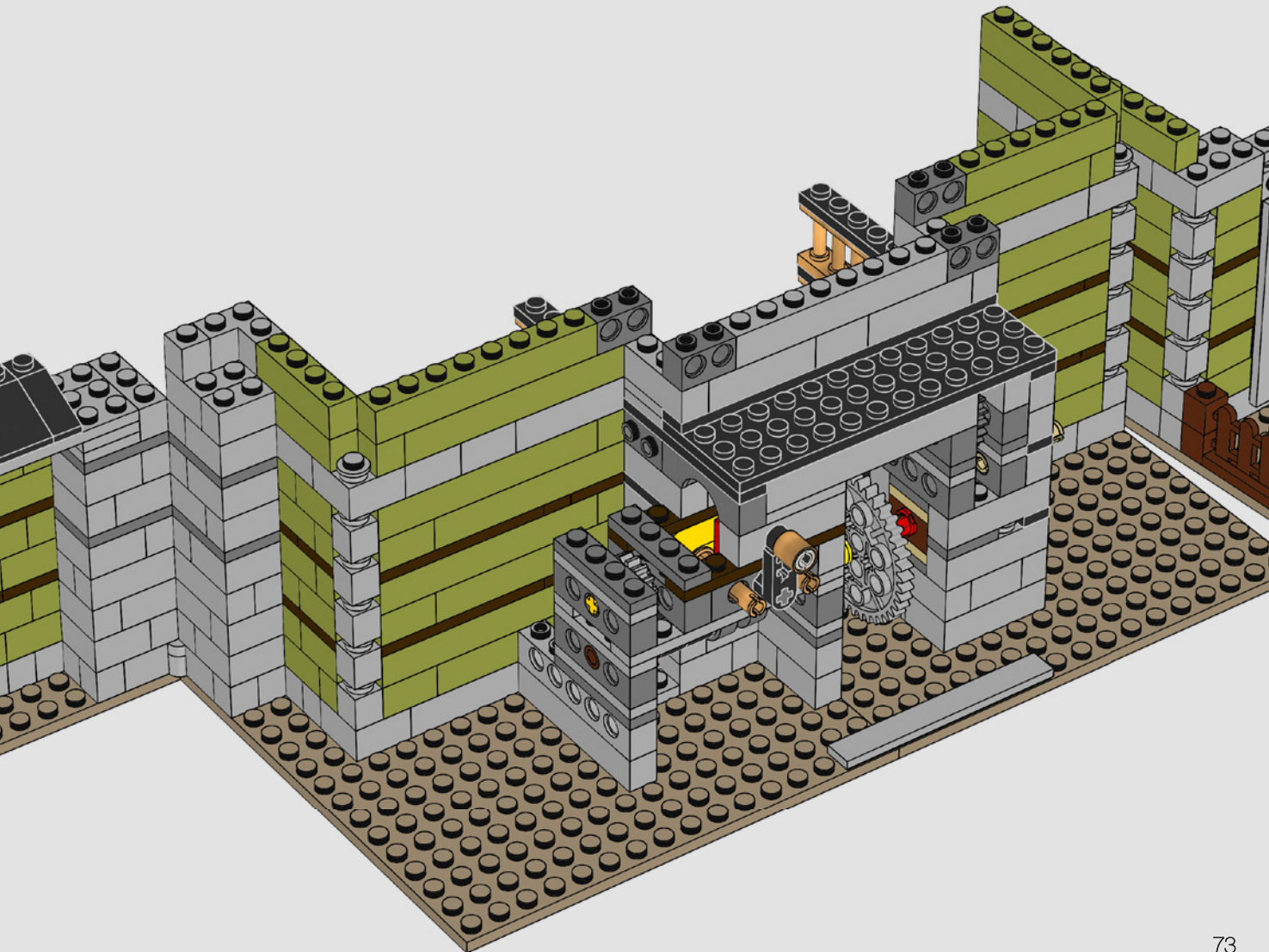

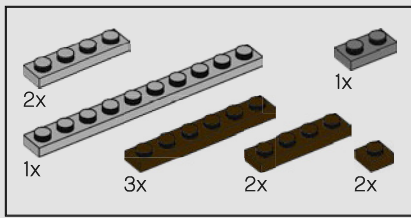

81

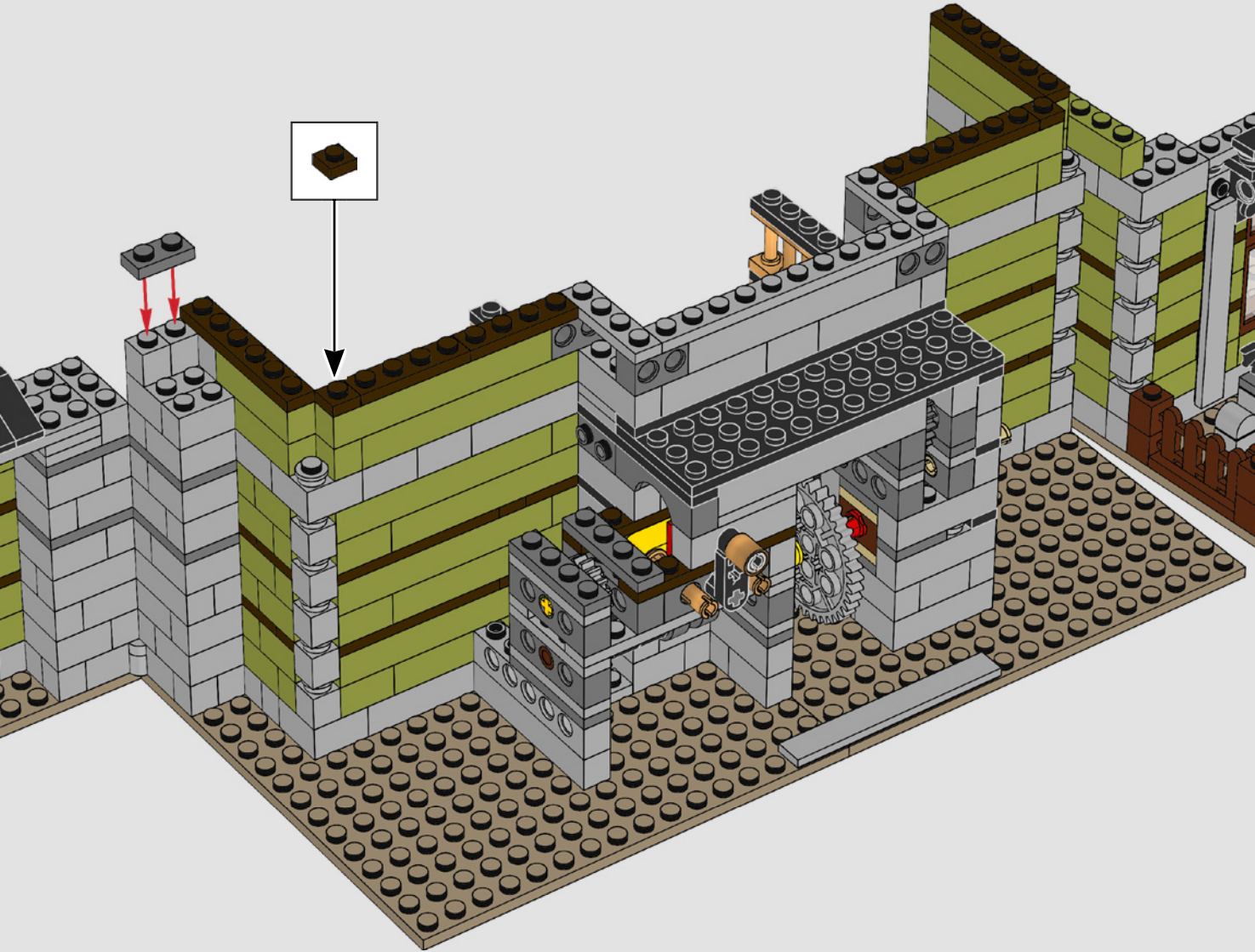

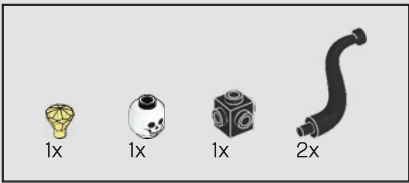

82

El ídolo del Everest
Sustraído de un templo en el monte Everest, se dice que sus largos apéndices conectan con lo desconocido. También funciona muy bien como perchero.

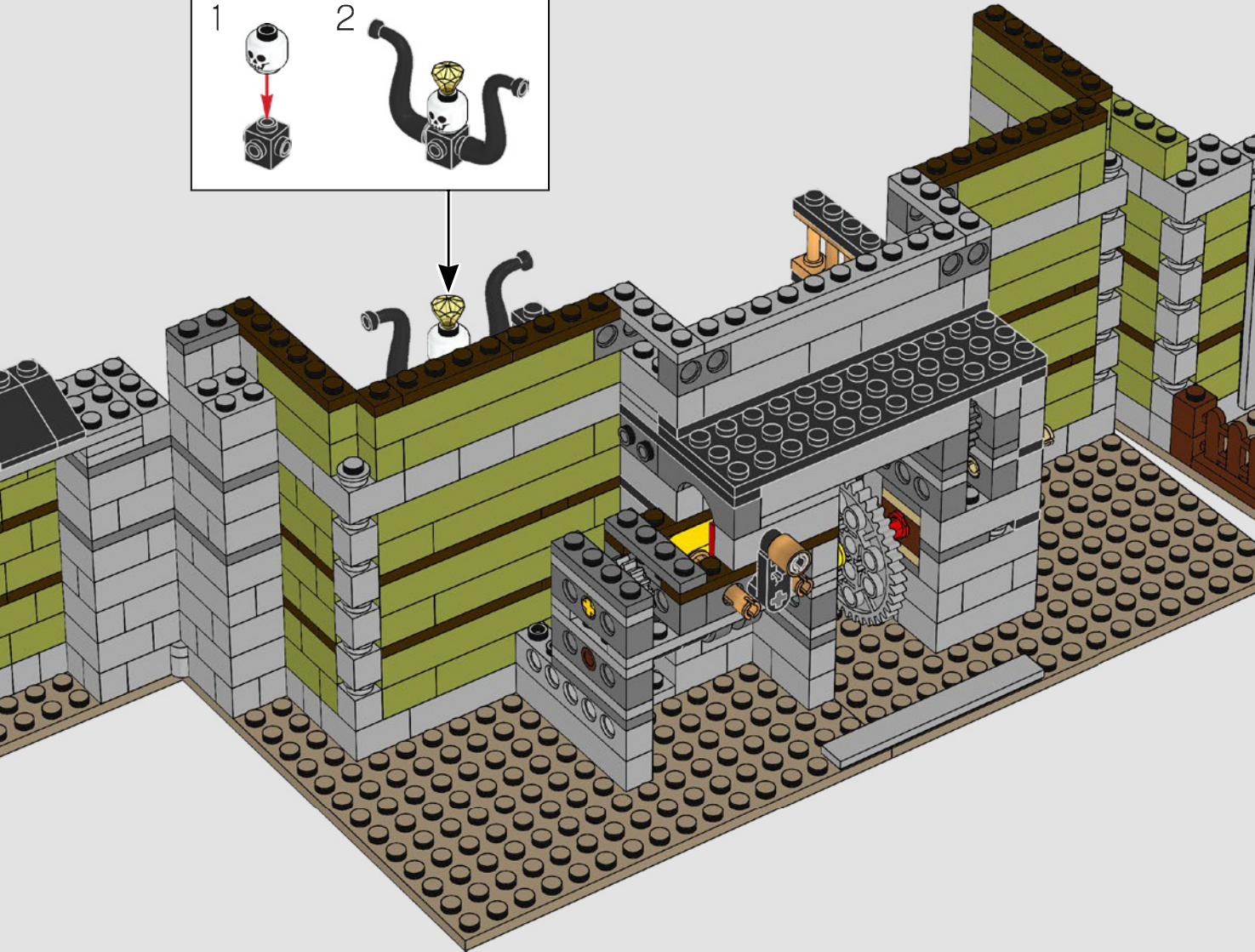
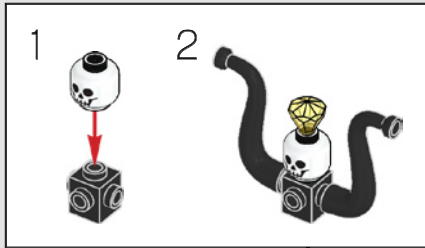

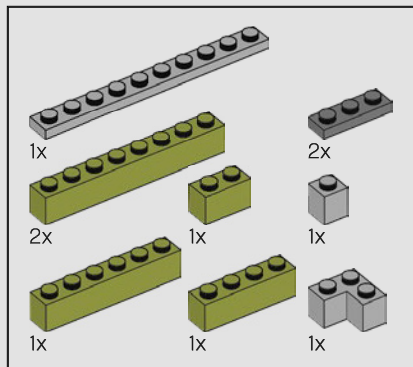

83

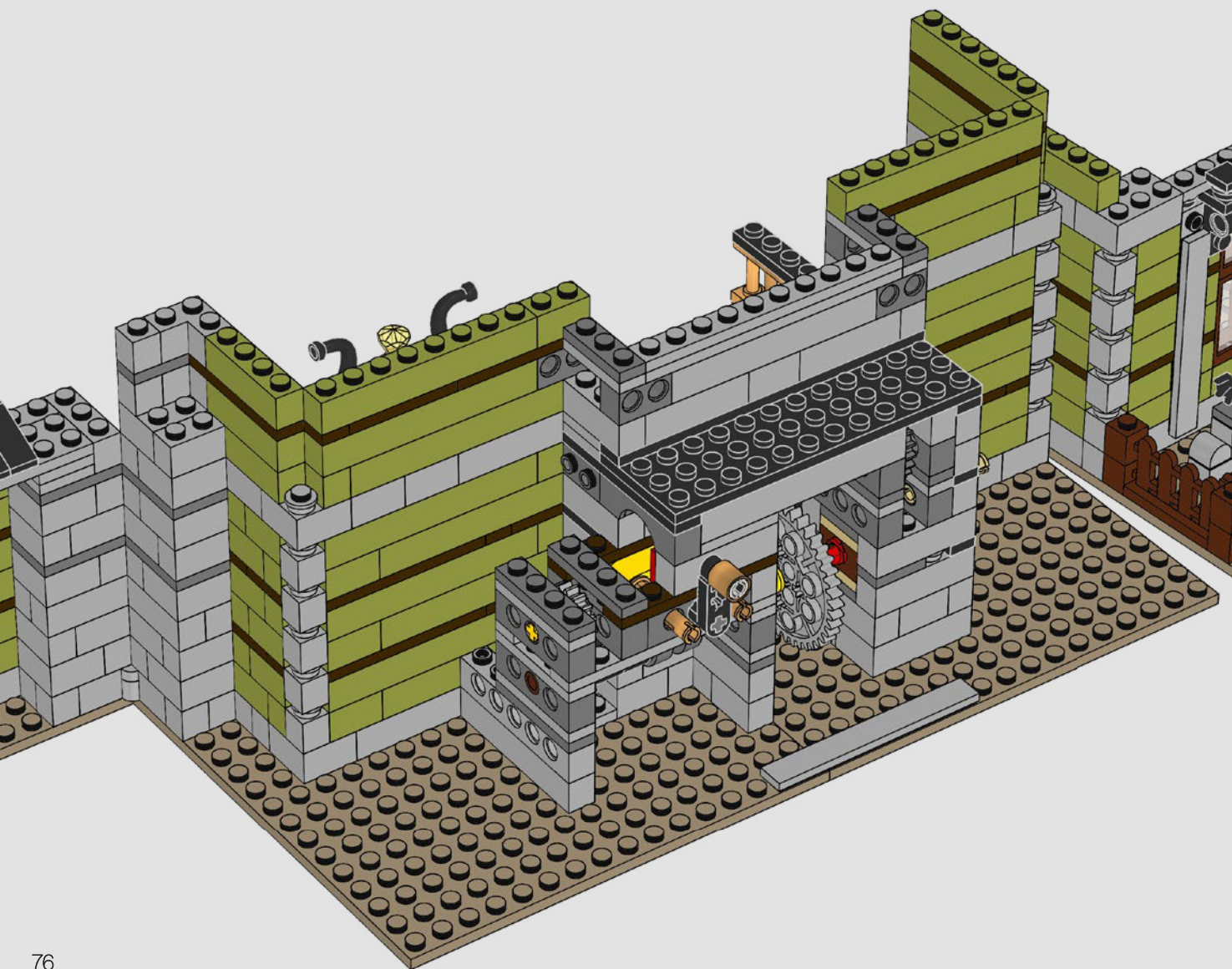

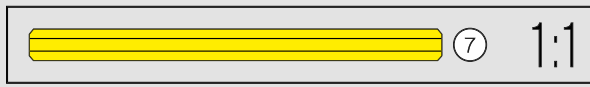
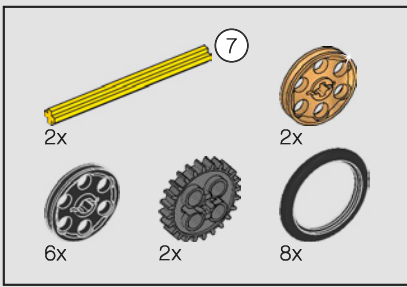

84

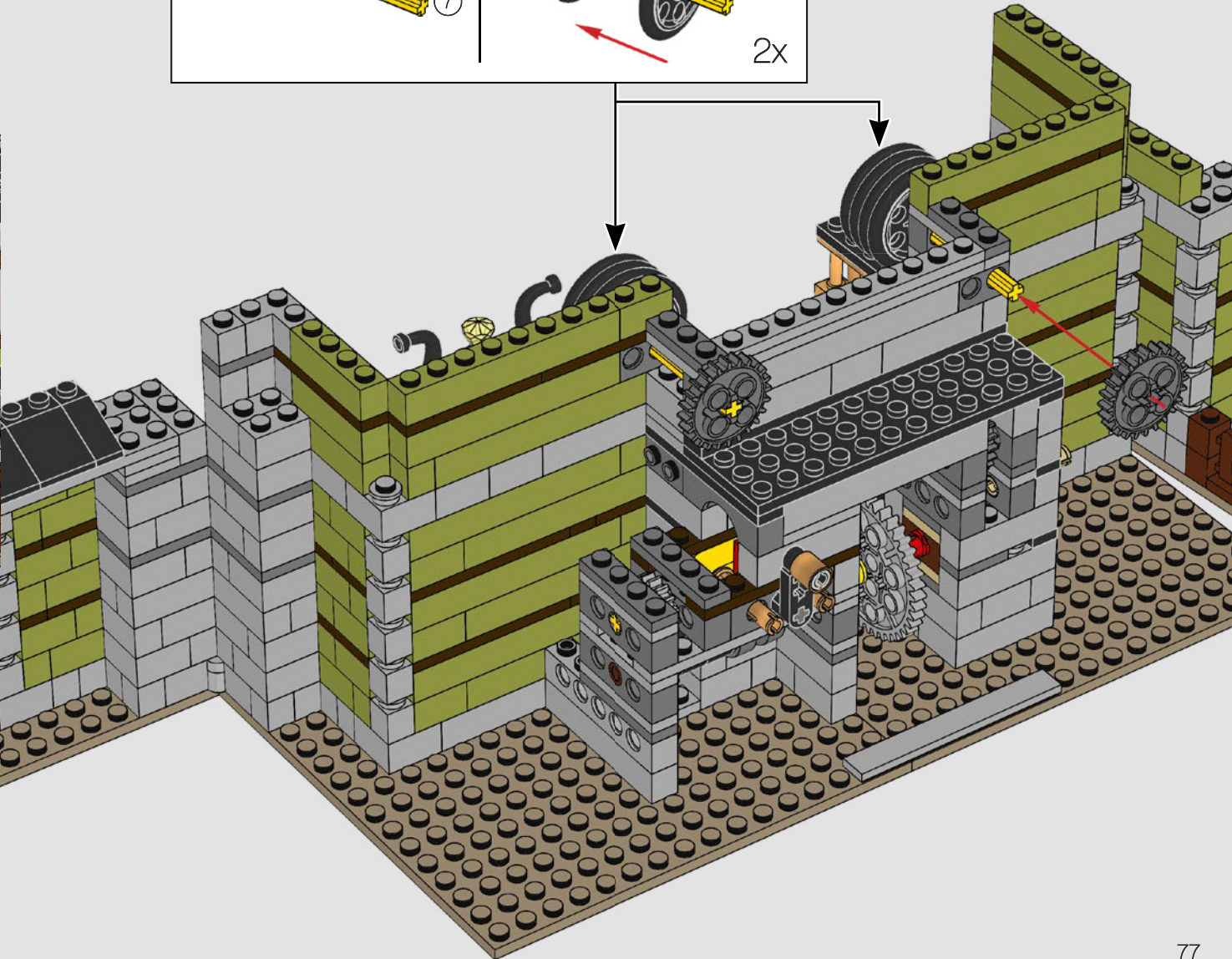
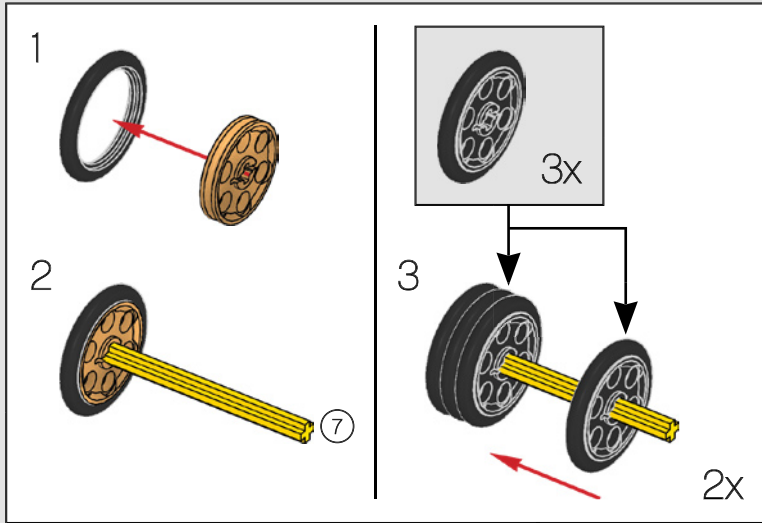

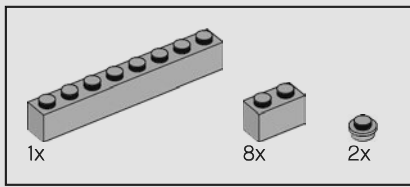

85

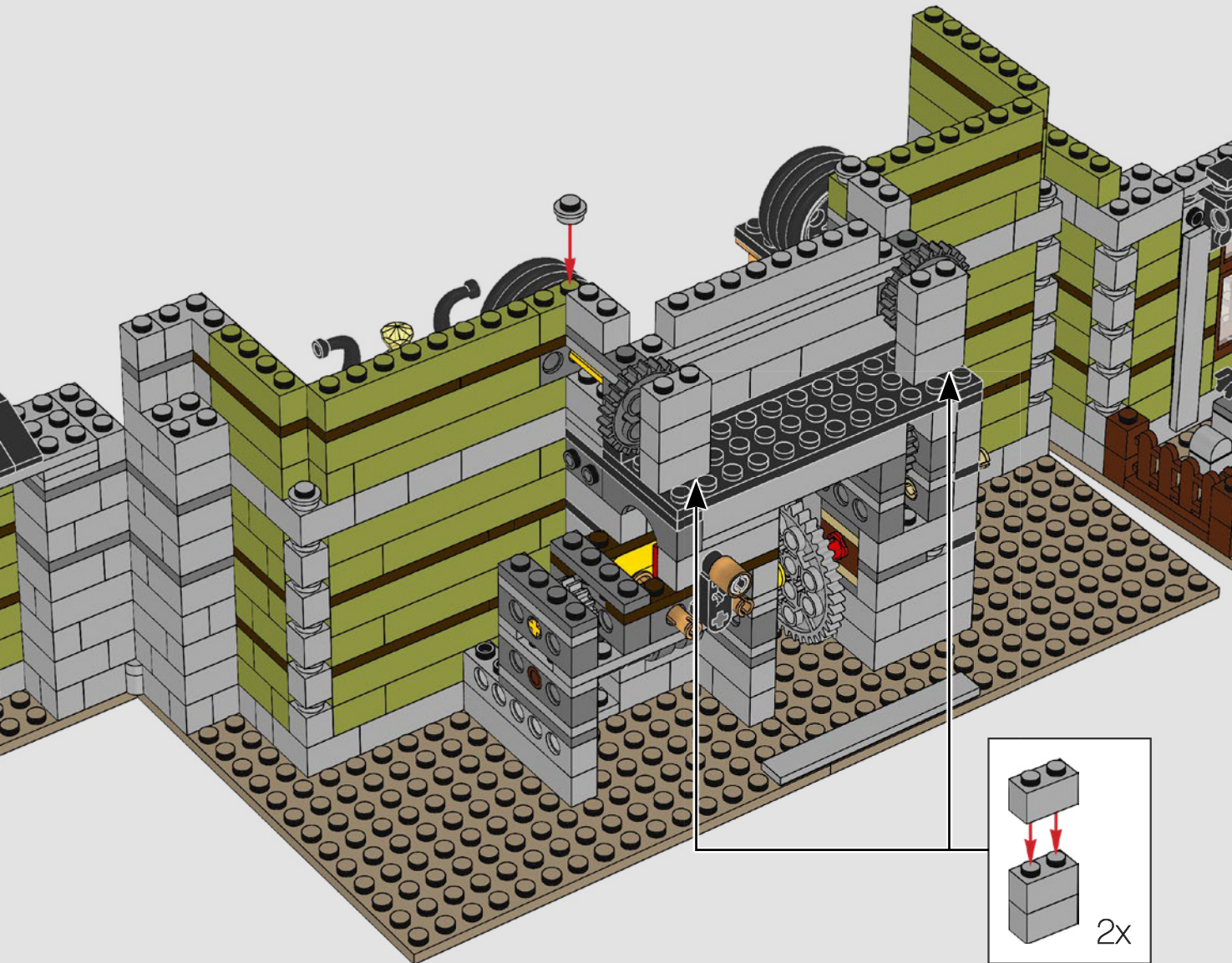

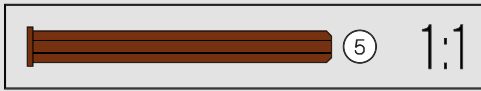
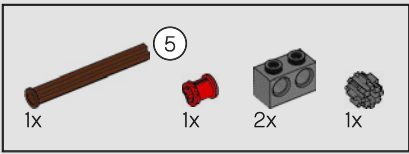

86

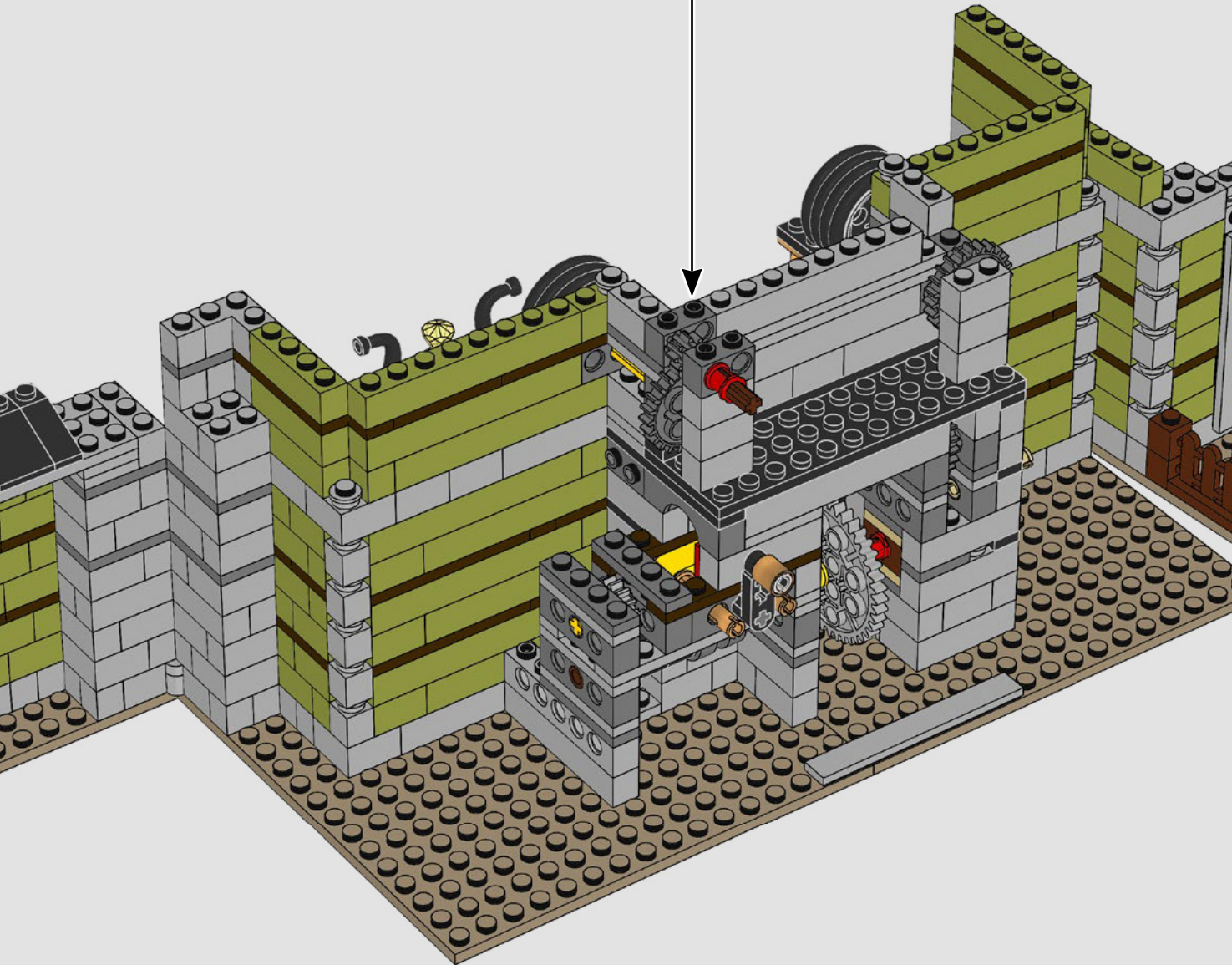
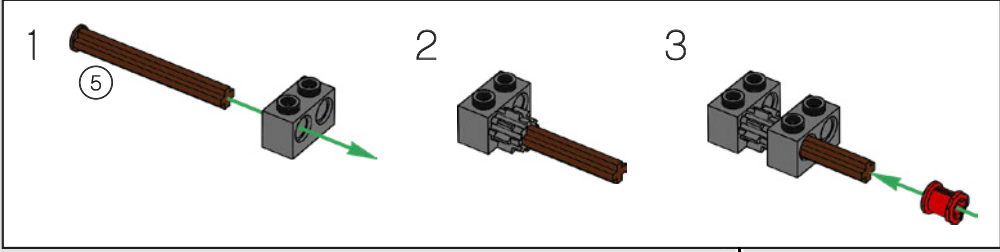

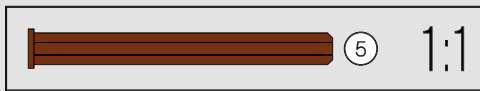
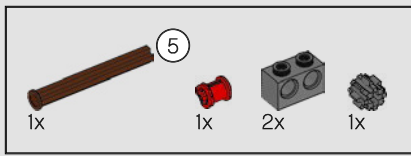

87

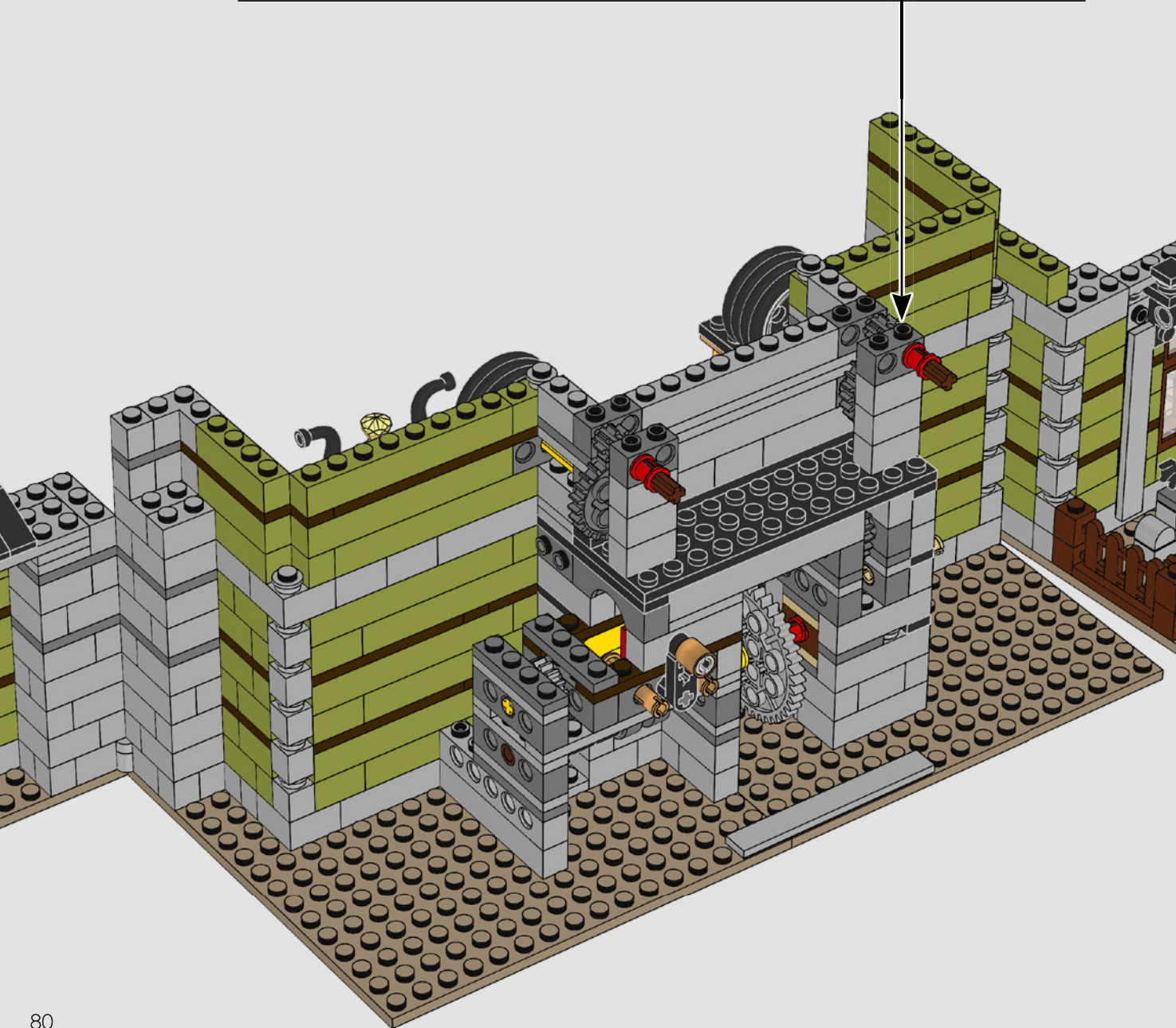
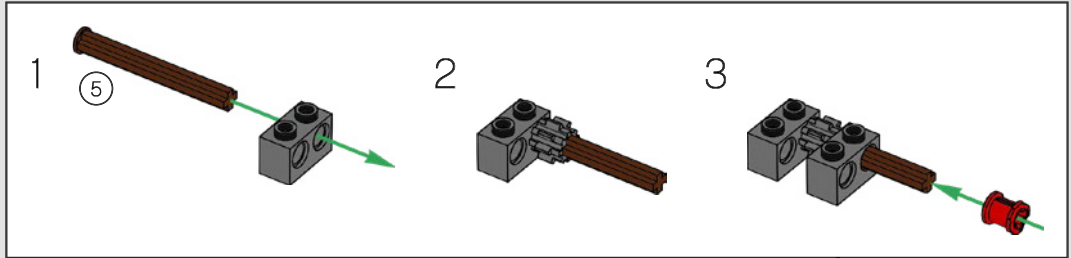

80

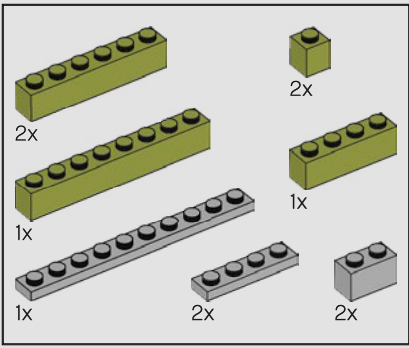

88

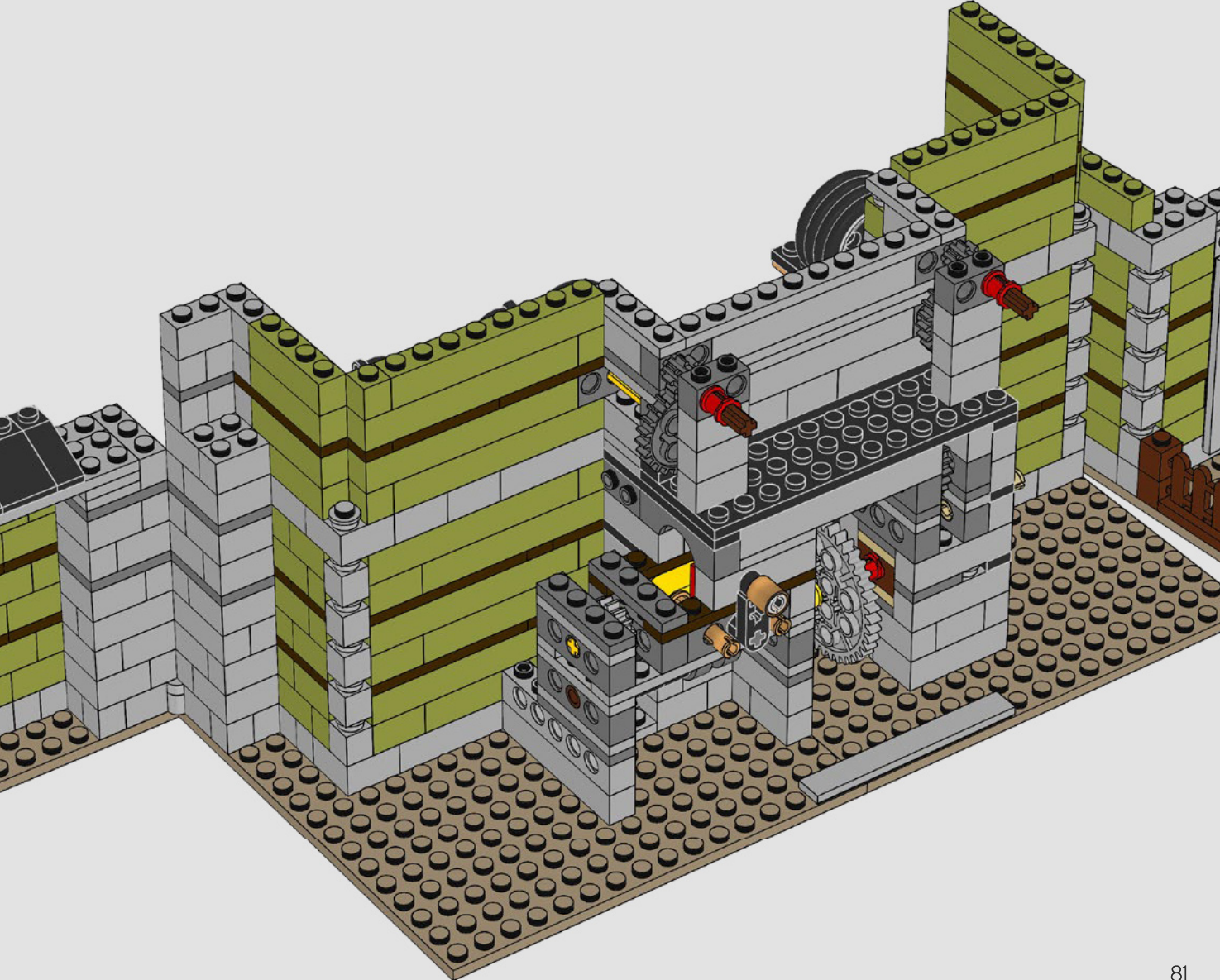

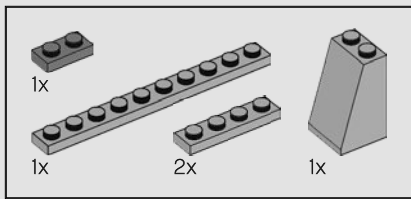

89

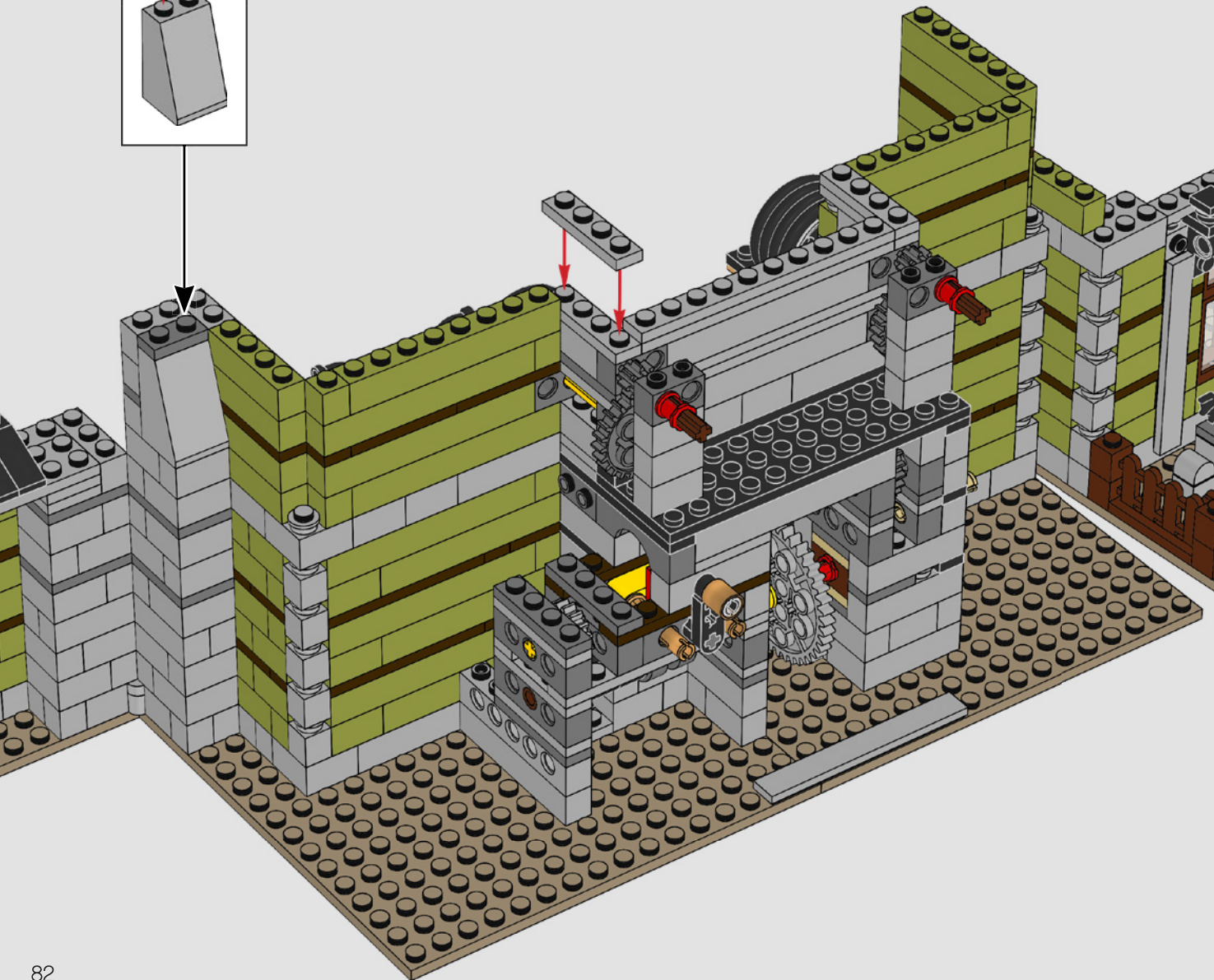
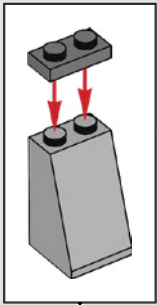

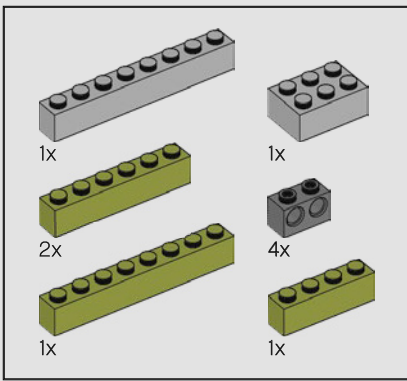

90

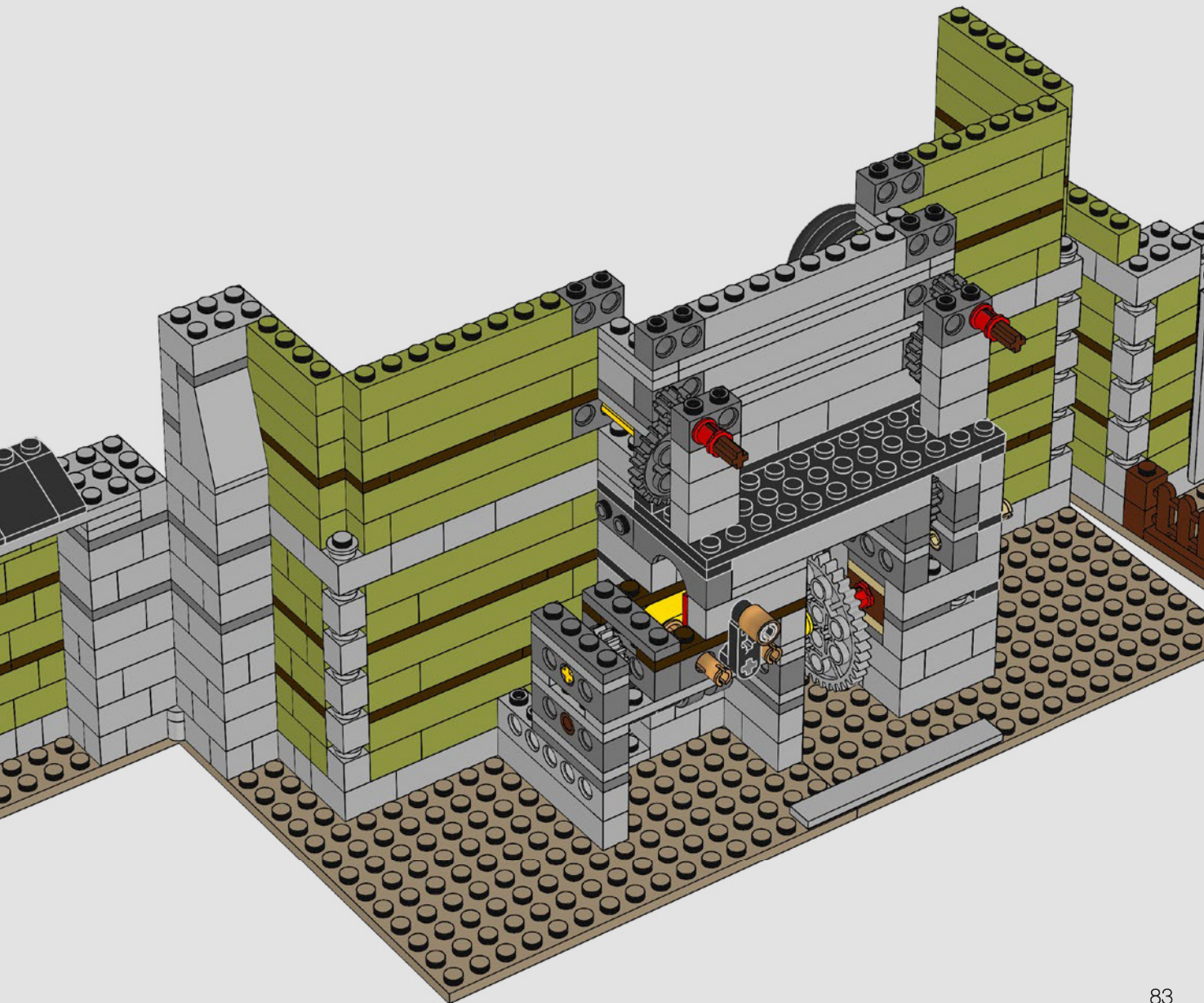

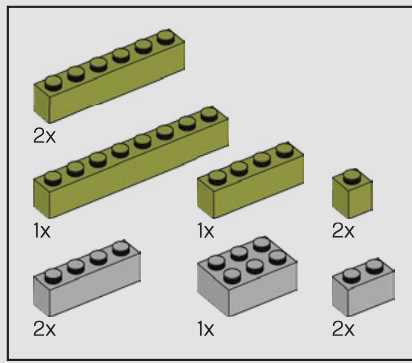

91

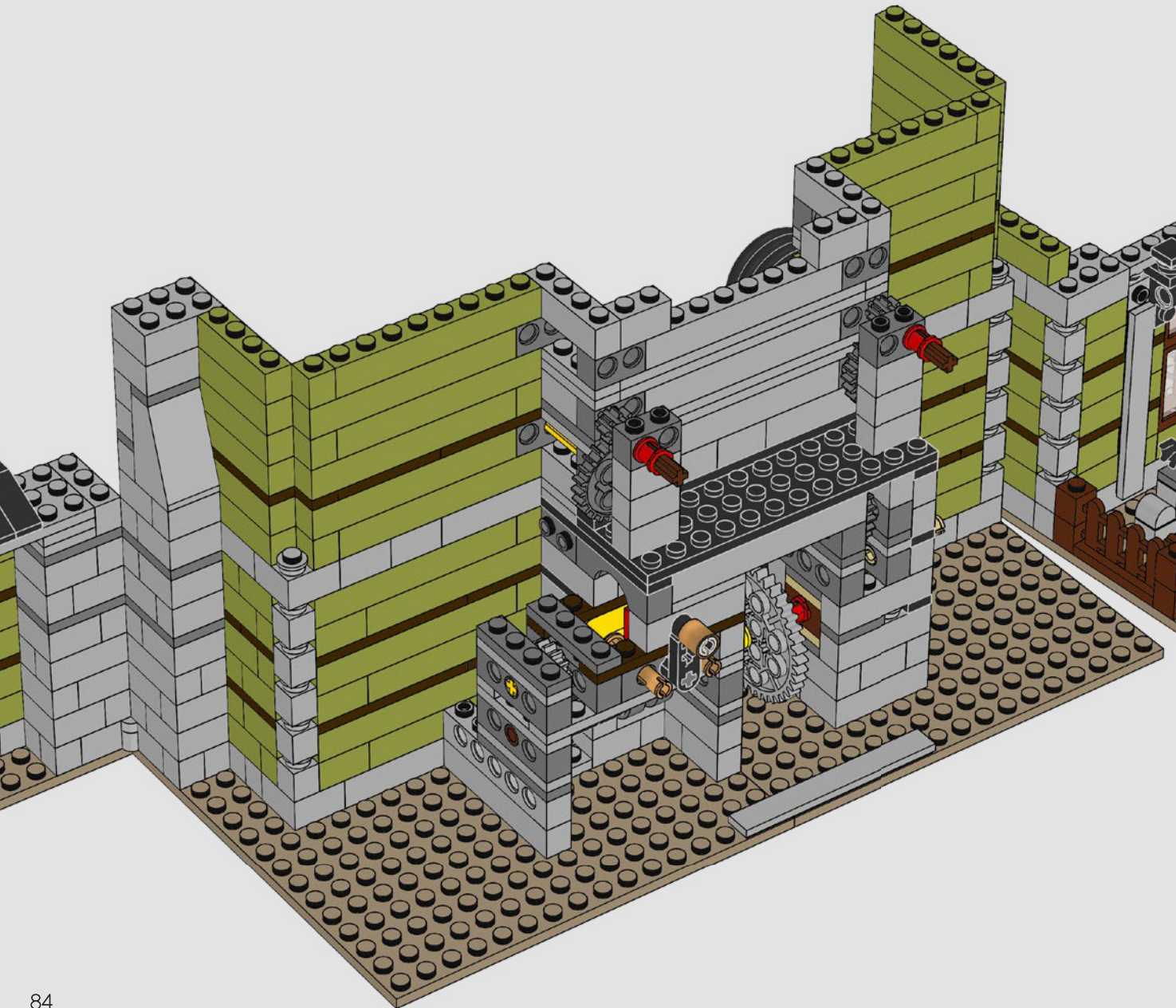

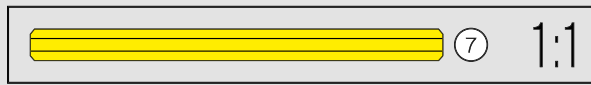
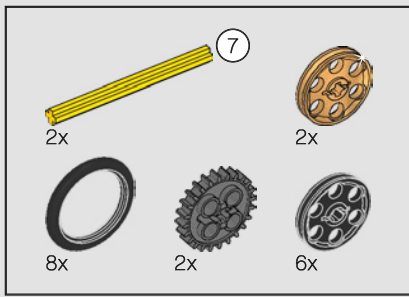

92

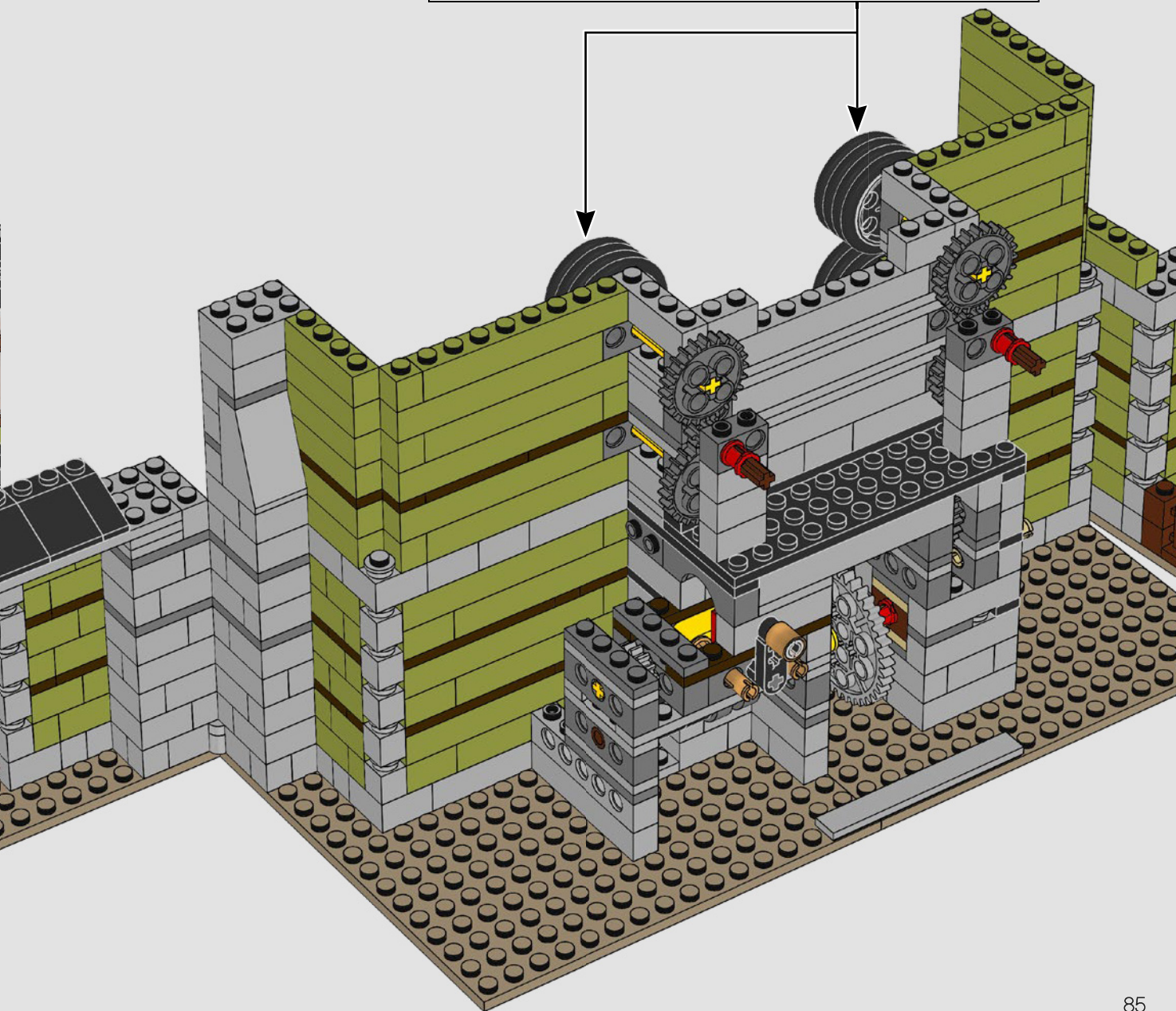
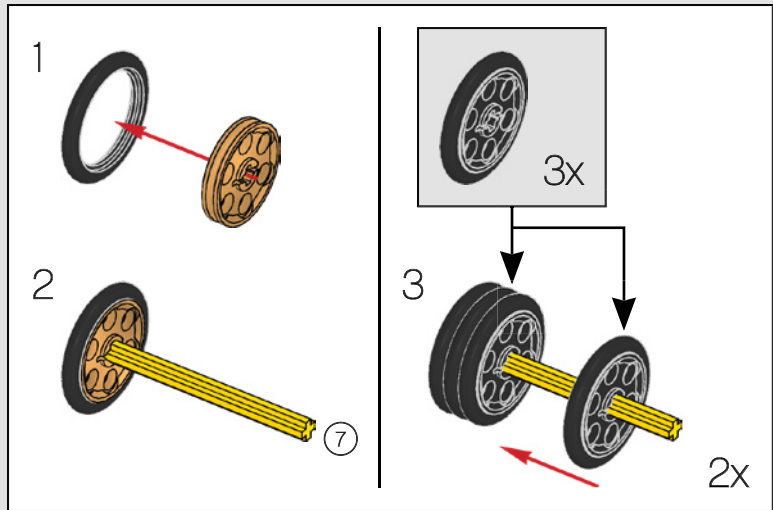

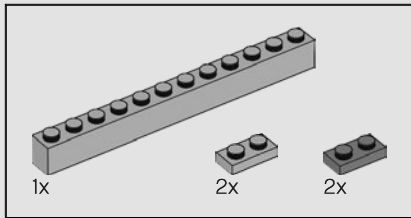

93

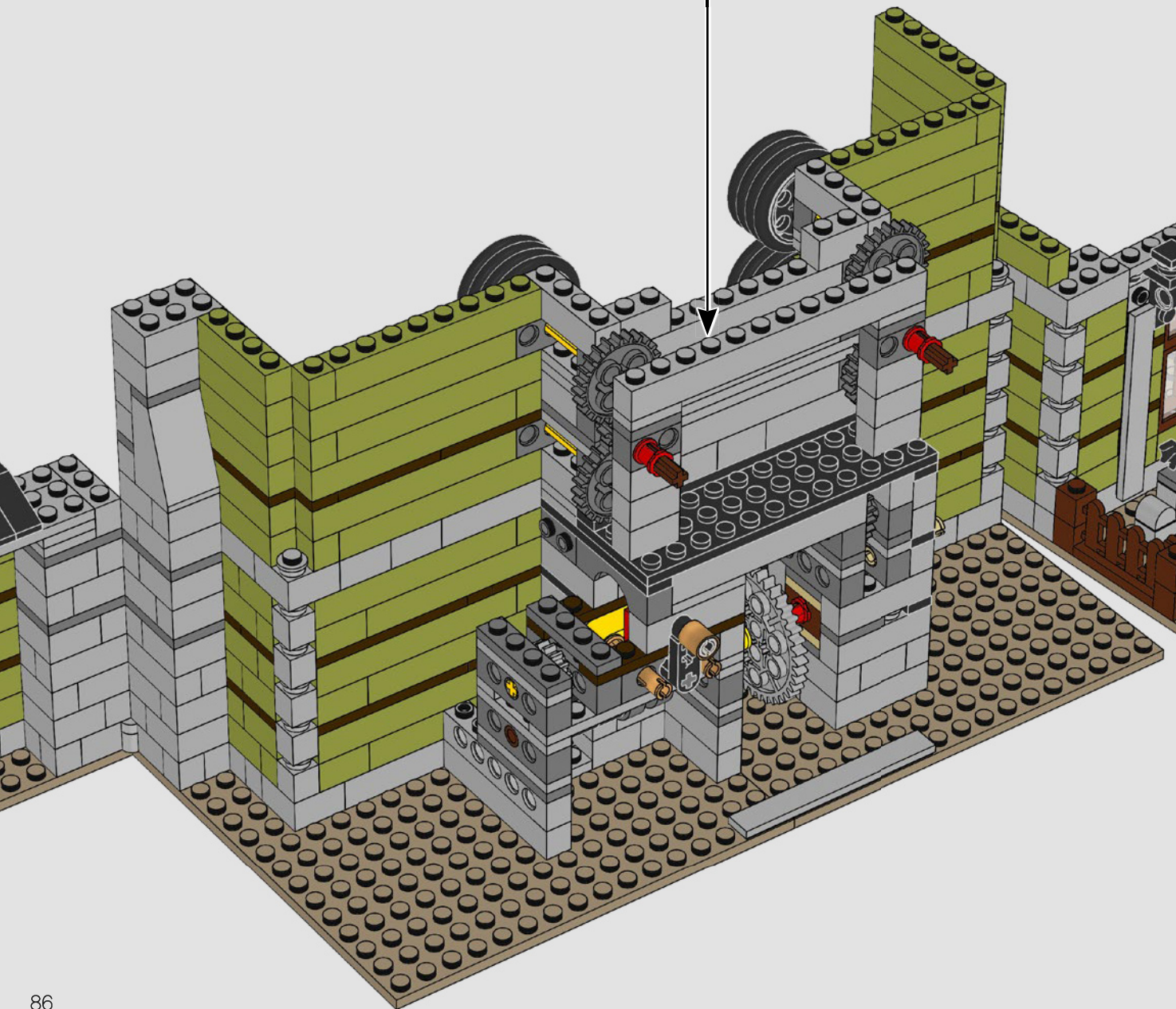
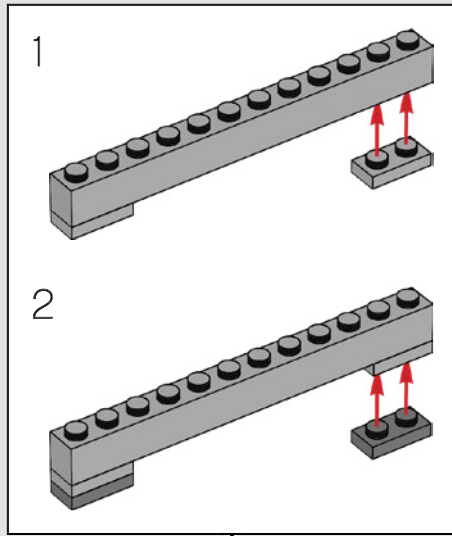

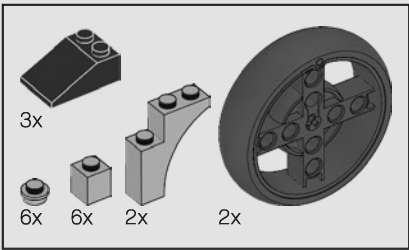

94

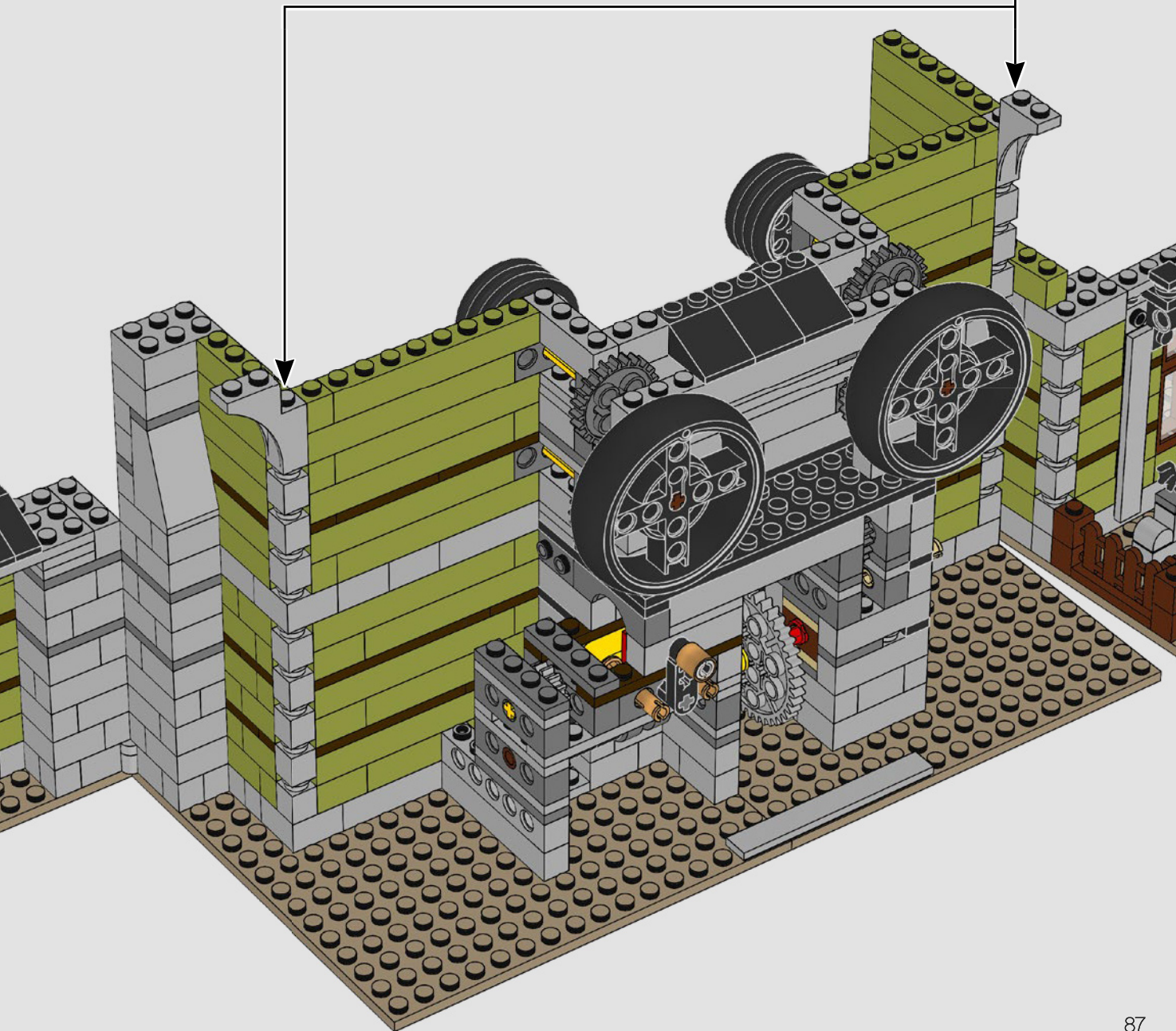
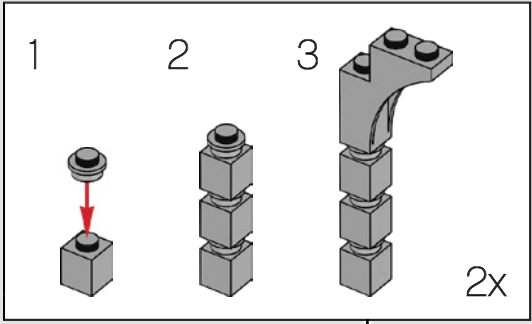

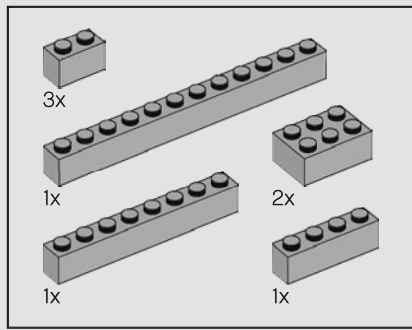

95

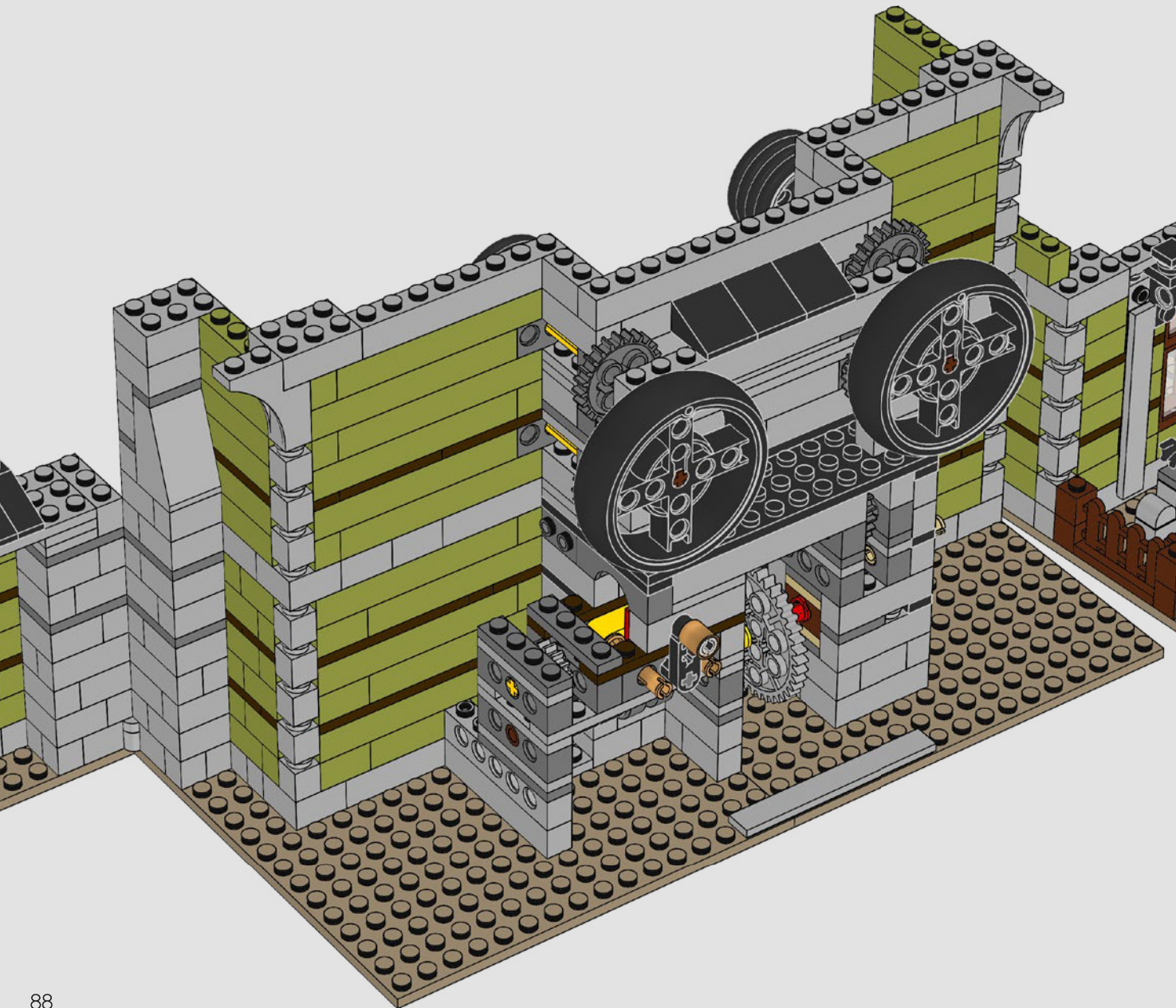



6

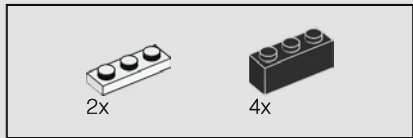
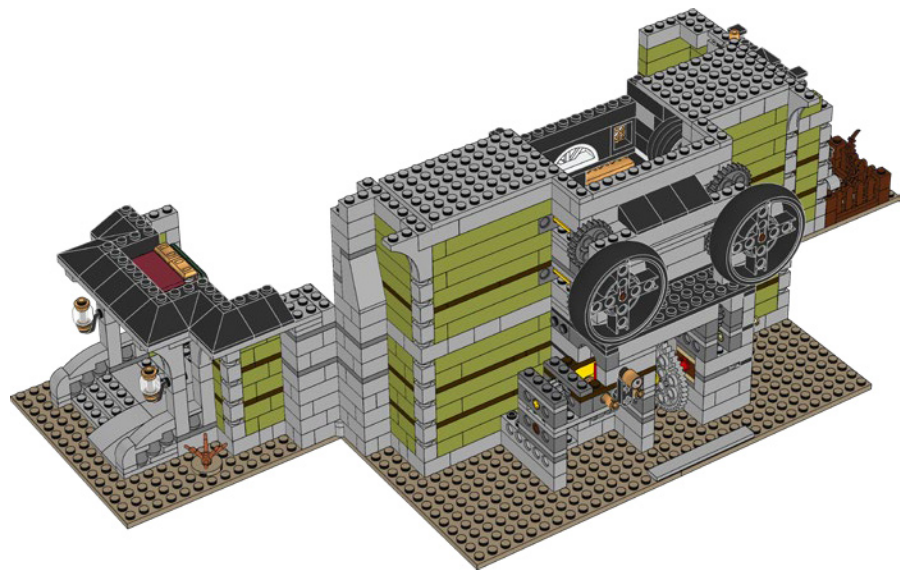

96

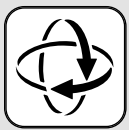
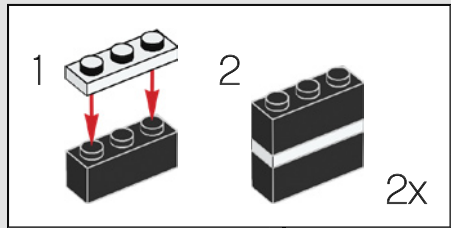

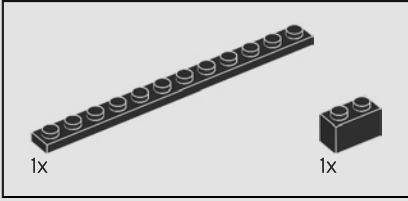
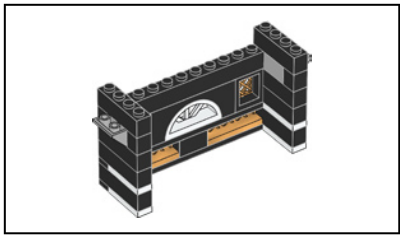

97

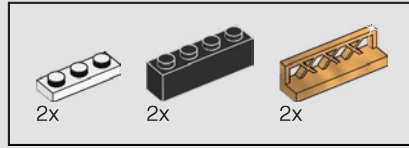
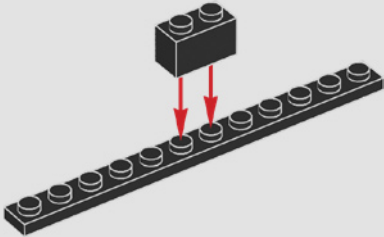

98

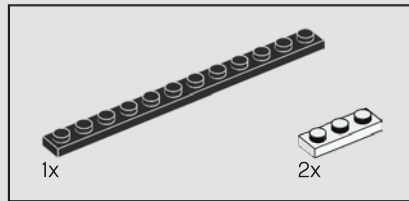
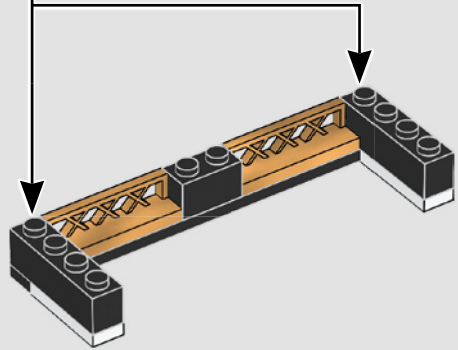
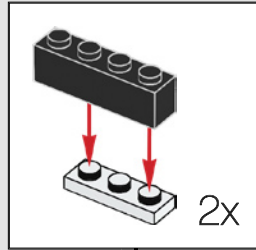

99

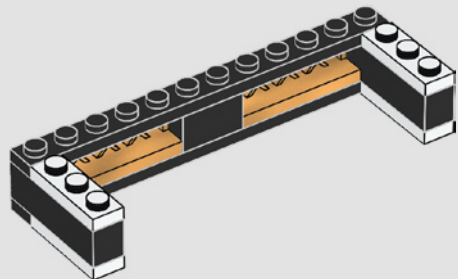

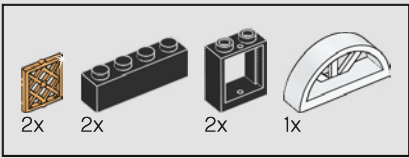

100

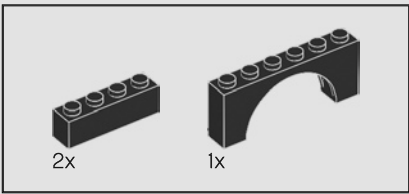
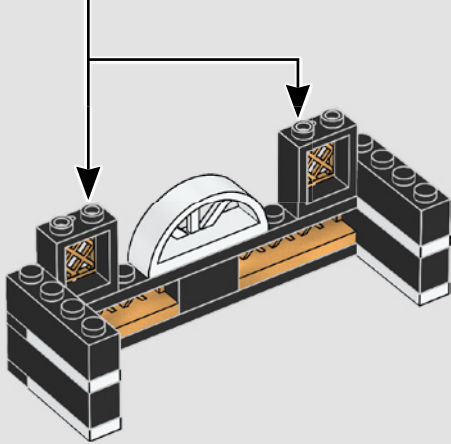
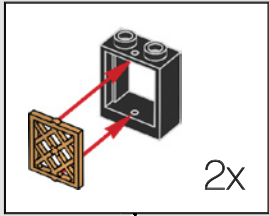

101

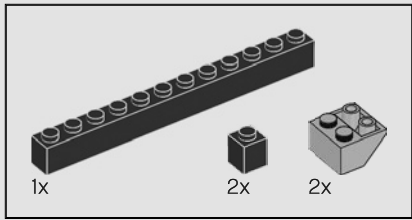
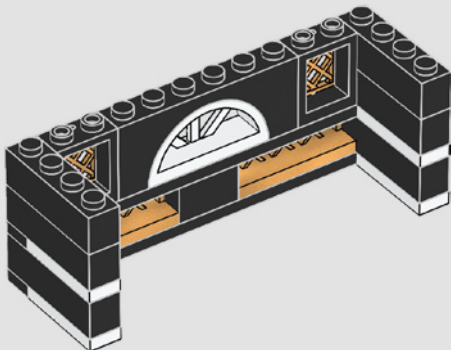

102

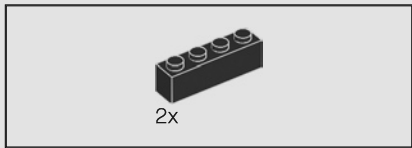
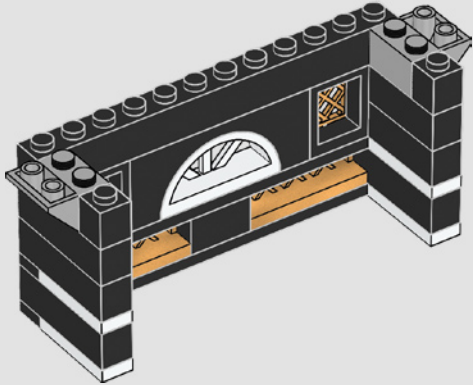

103

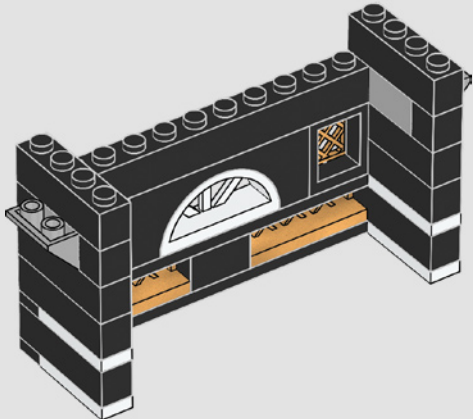



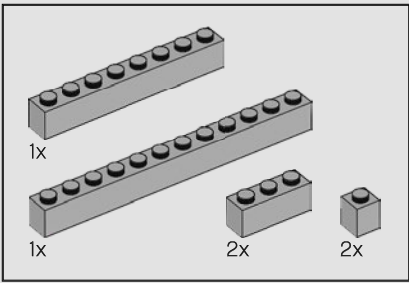

105



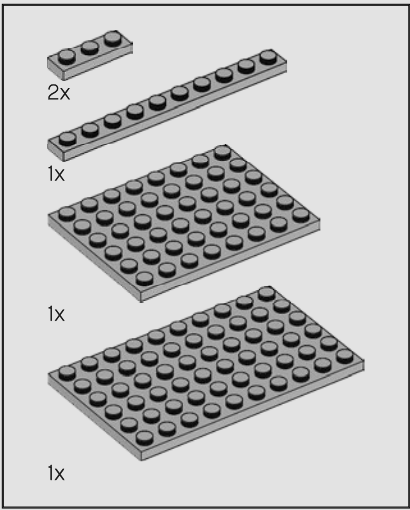

El Obelisco del Mal
Von Barron robó este obelisco porque tenía inscrito el mensaje más malvado que jamás había visto.

106



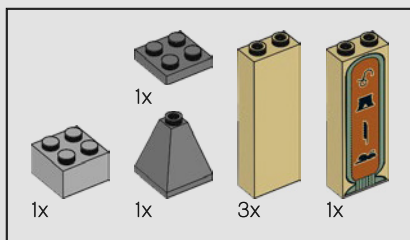

107

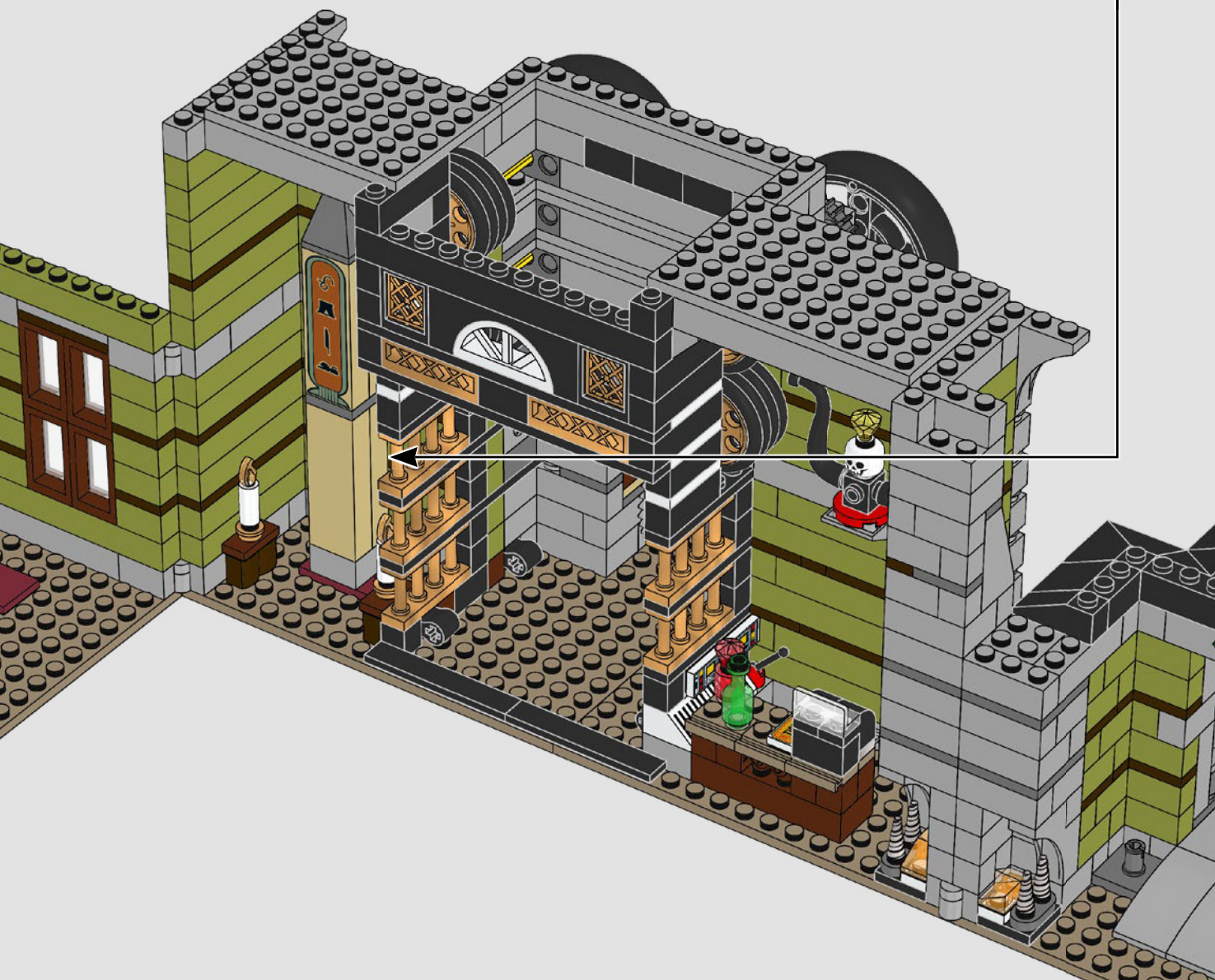
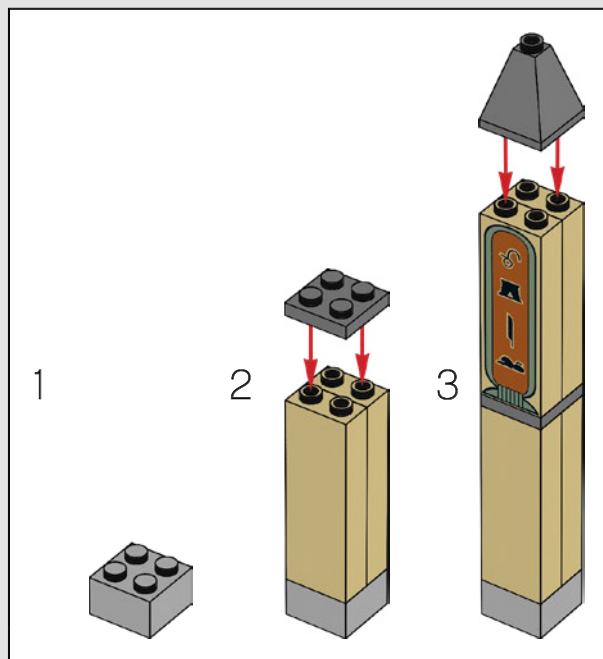

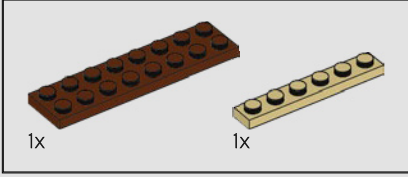
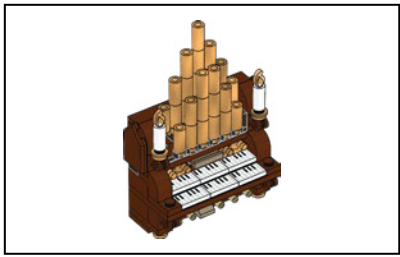

108

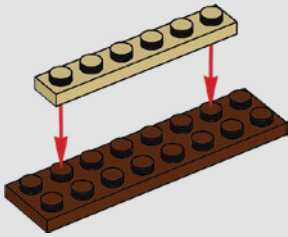

109

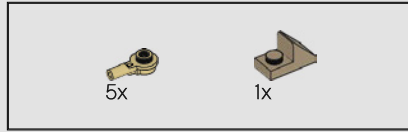
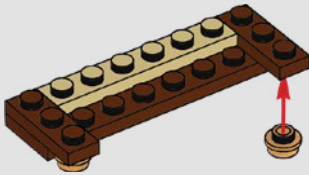

110

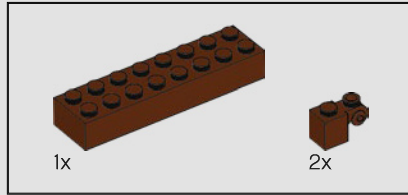
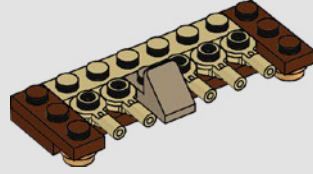

111

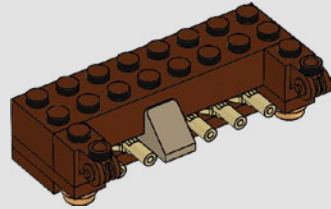

112

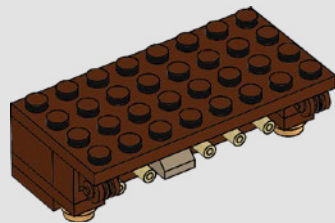

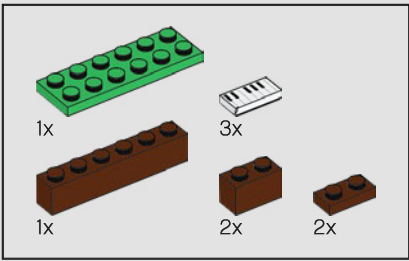

113

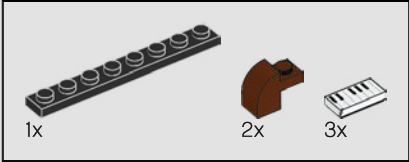
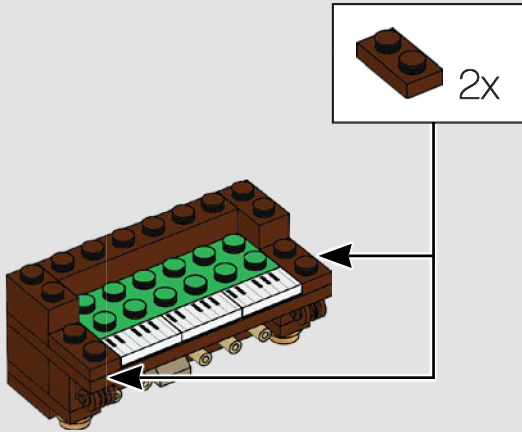

114

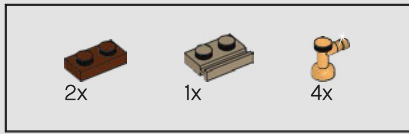
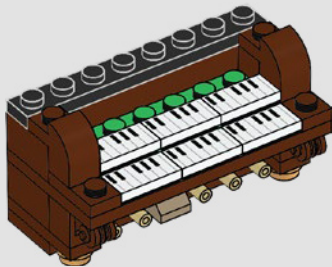

115

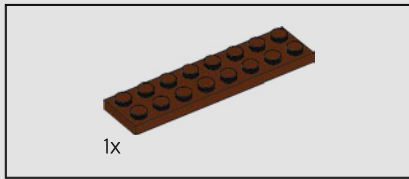
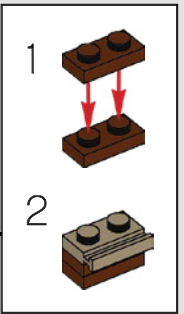
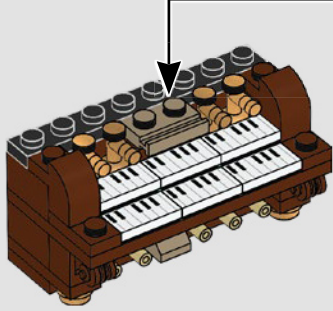

116

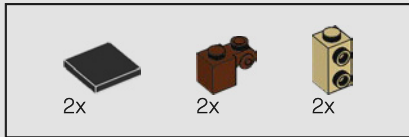
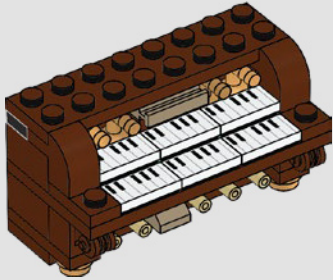

117

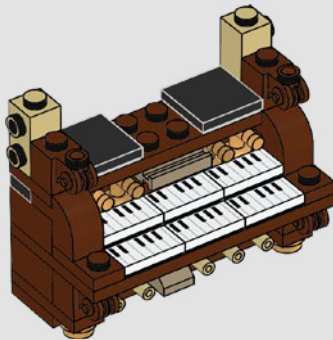

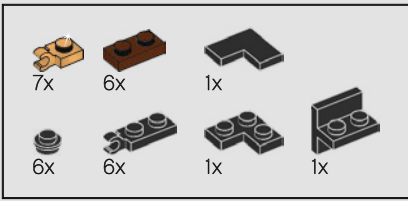

118

1



2

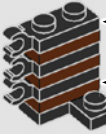
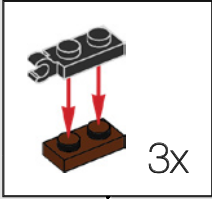

3

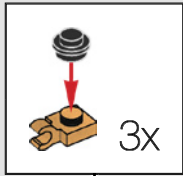

4

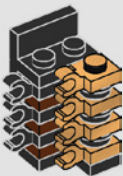

5

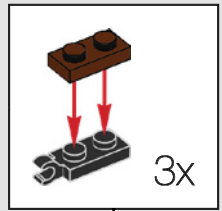

6

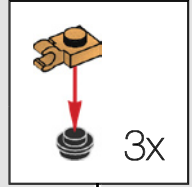

7

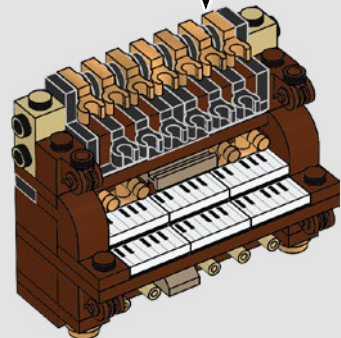

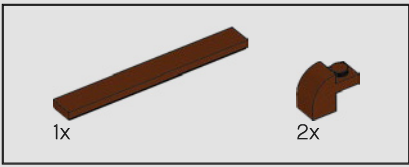

119

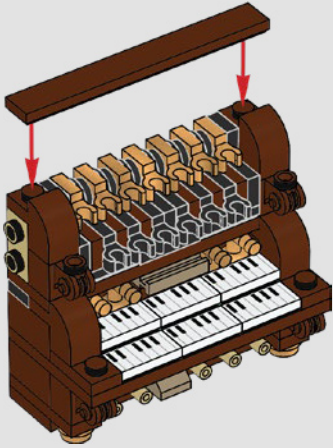

120

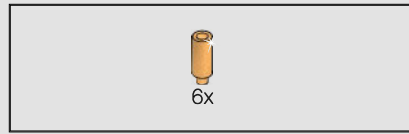
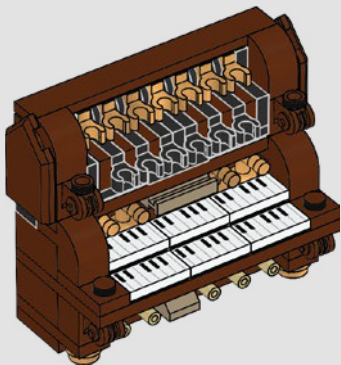

121

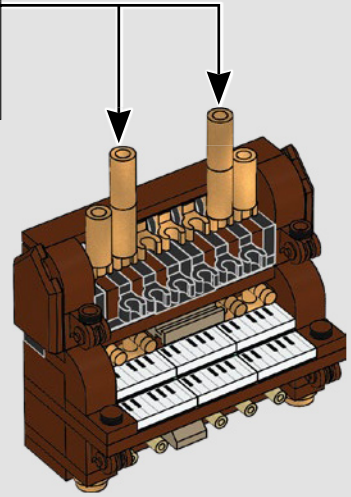
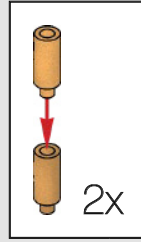

122

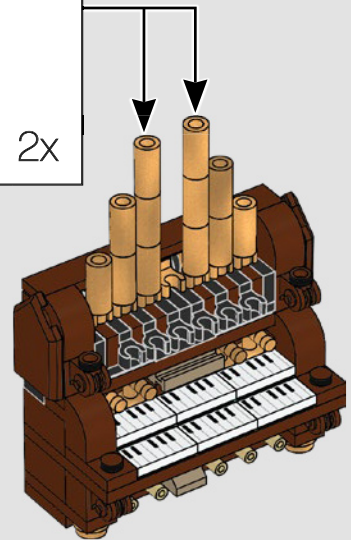
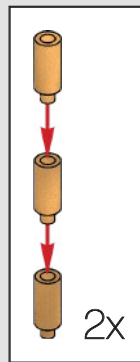

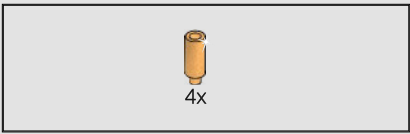

123

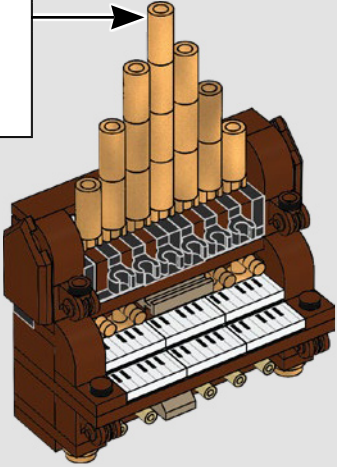
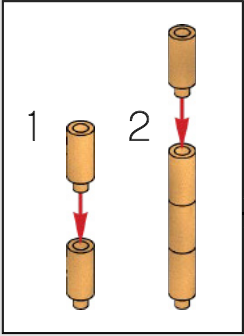

125

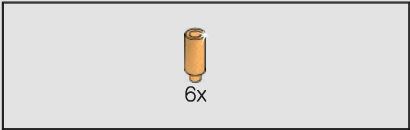
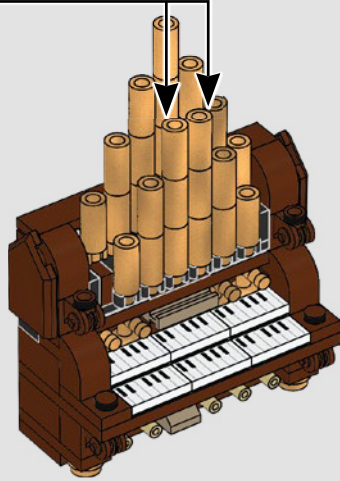
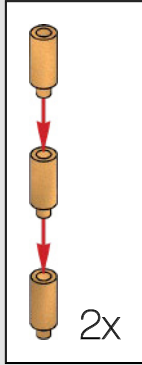

124

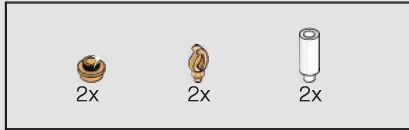
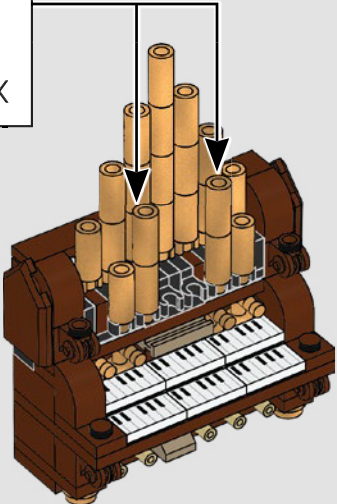
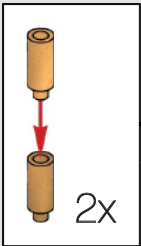

126

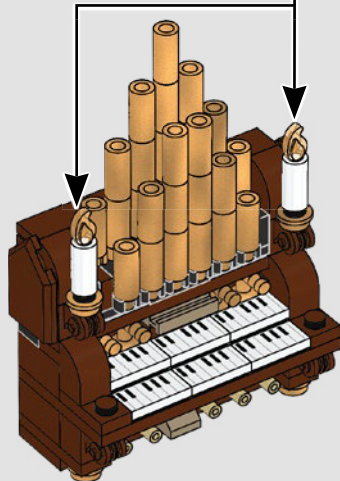
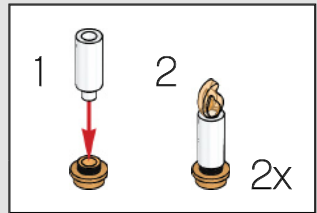

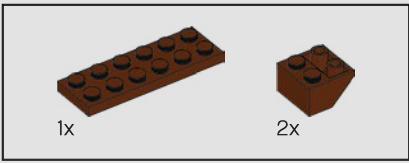

127

El Órgano de Catarino

Von Barron encargó que le construyeran este órgano en Portugal. Casi siempre lo usaba para interpretar los temas musicales de sus series favoritas de la tele.



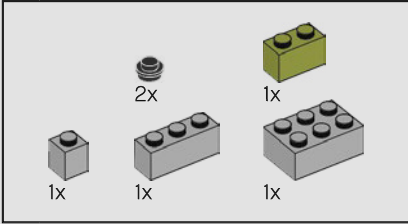

128

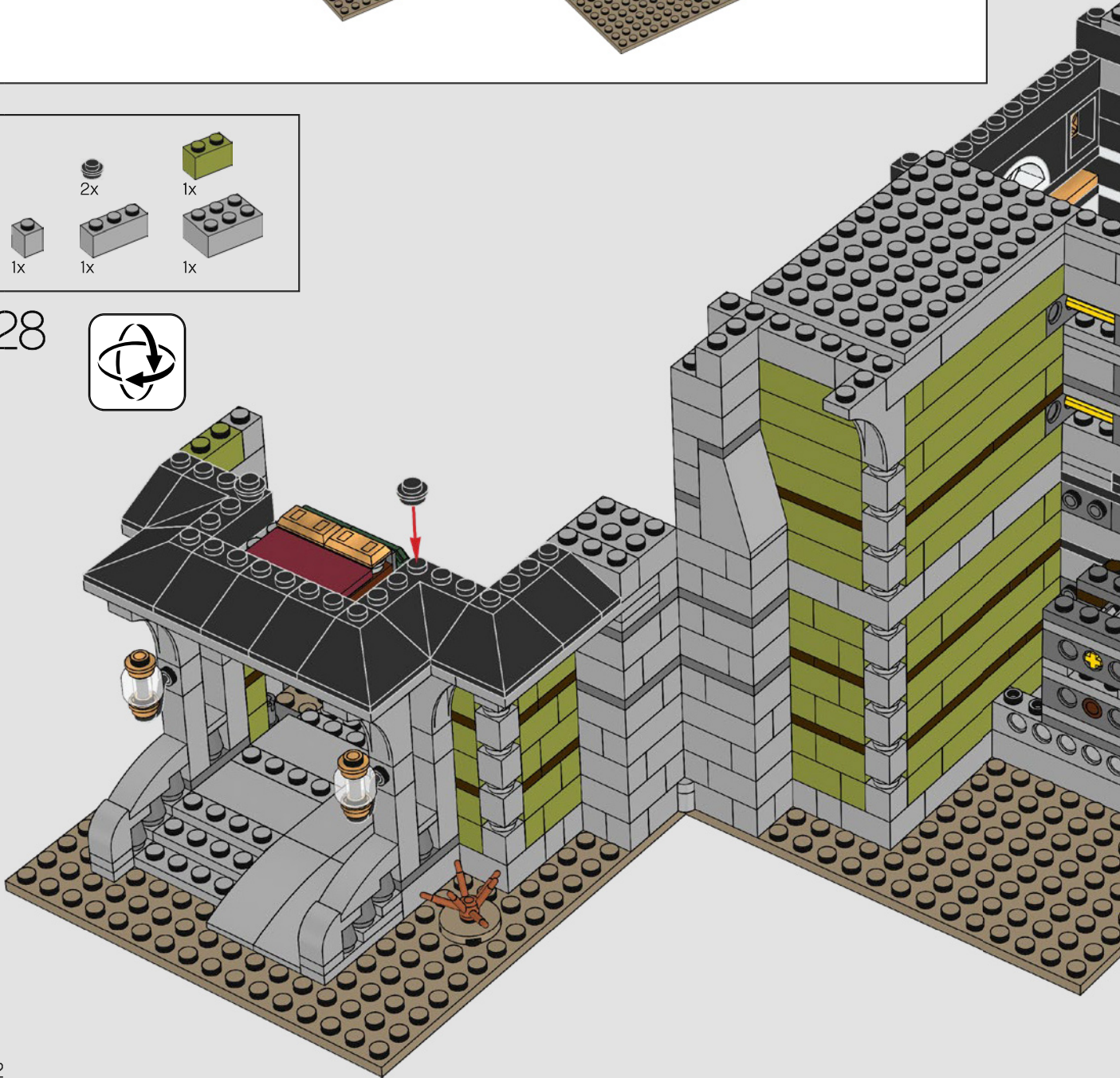

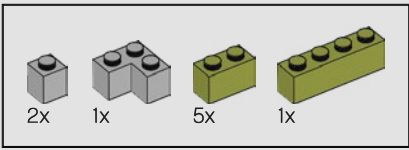

129

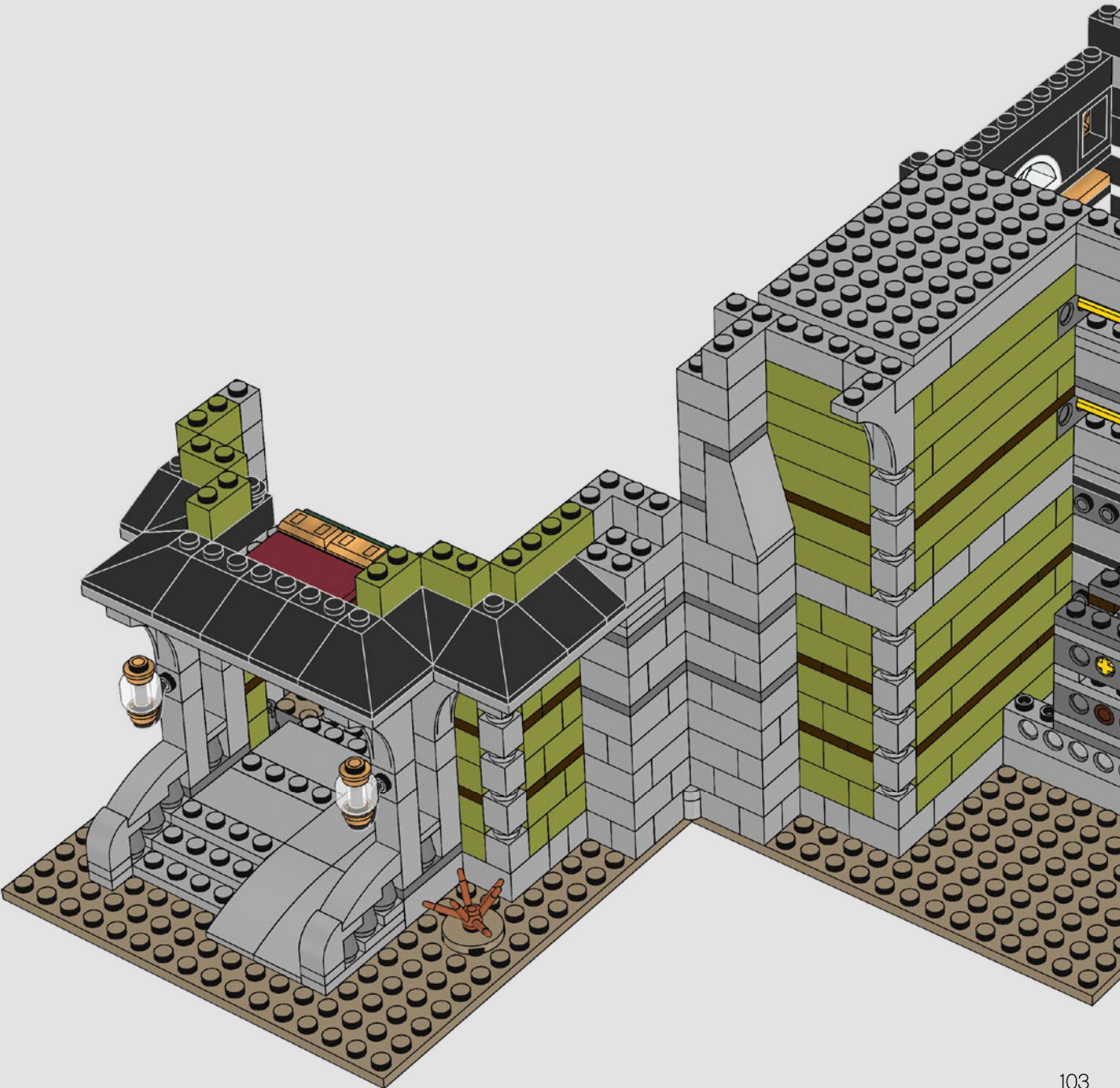

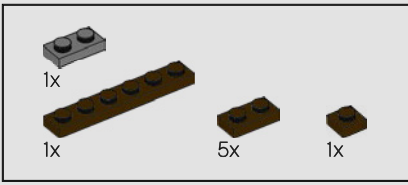

130

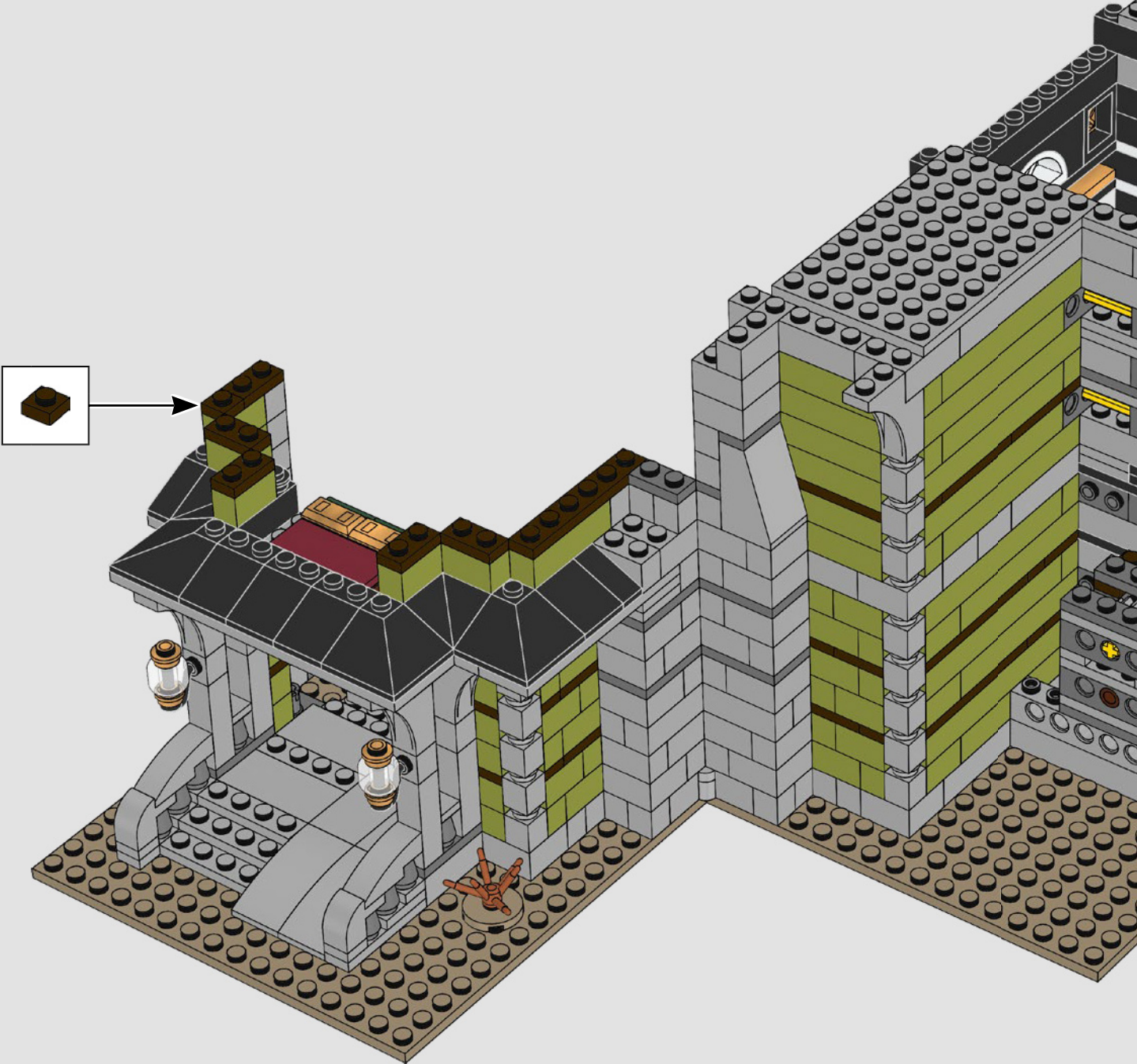

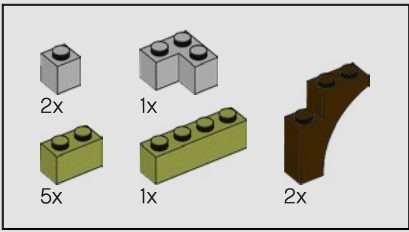

131

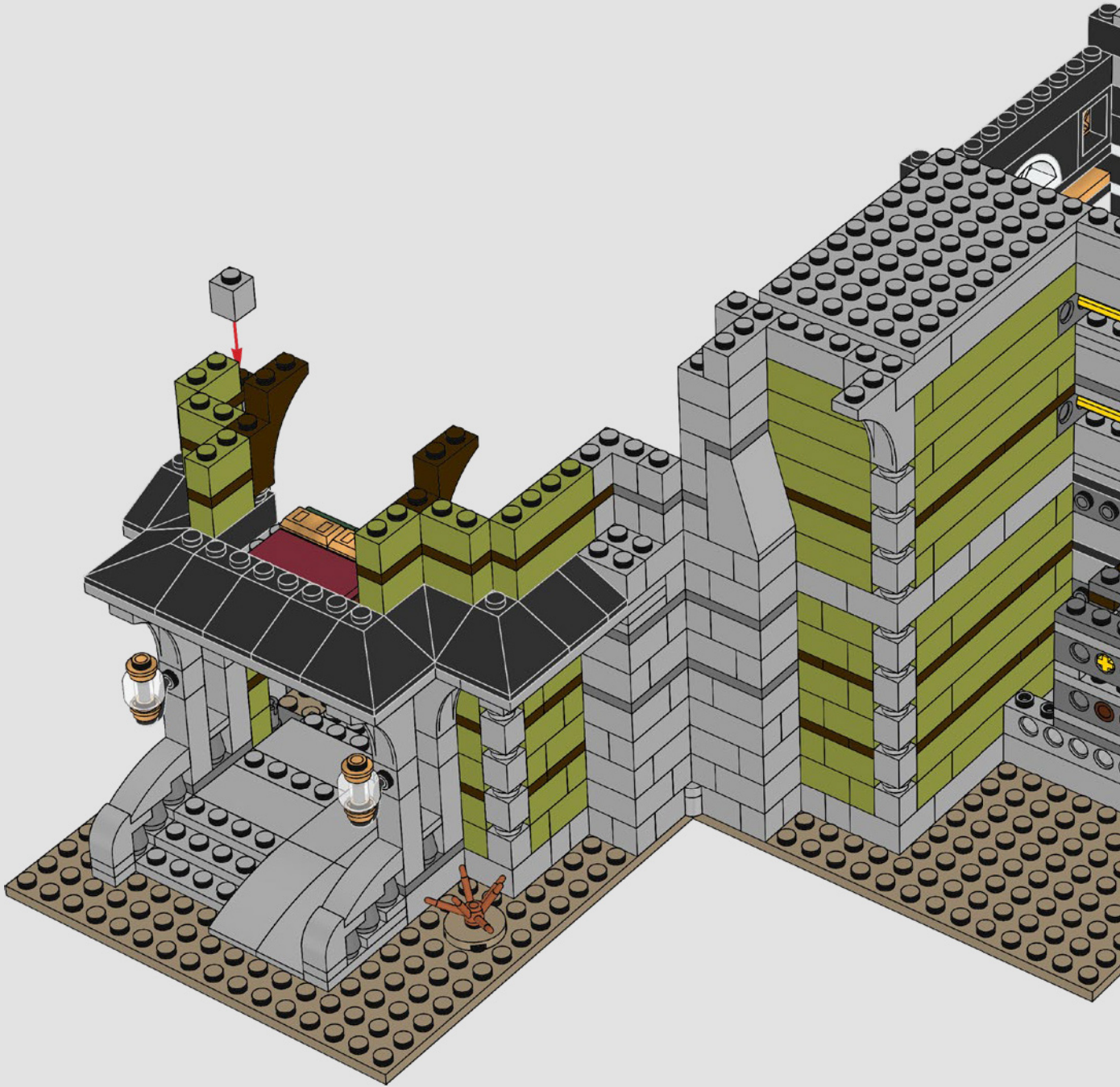

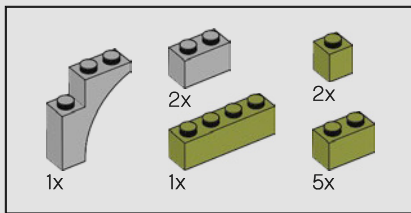

132



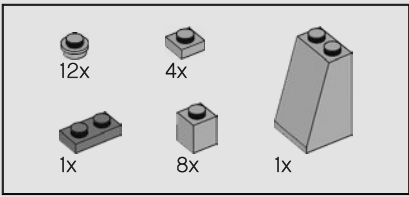

133

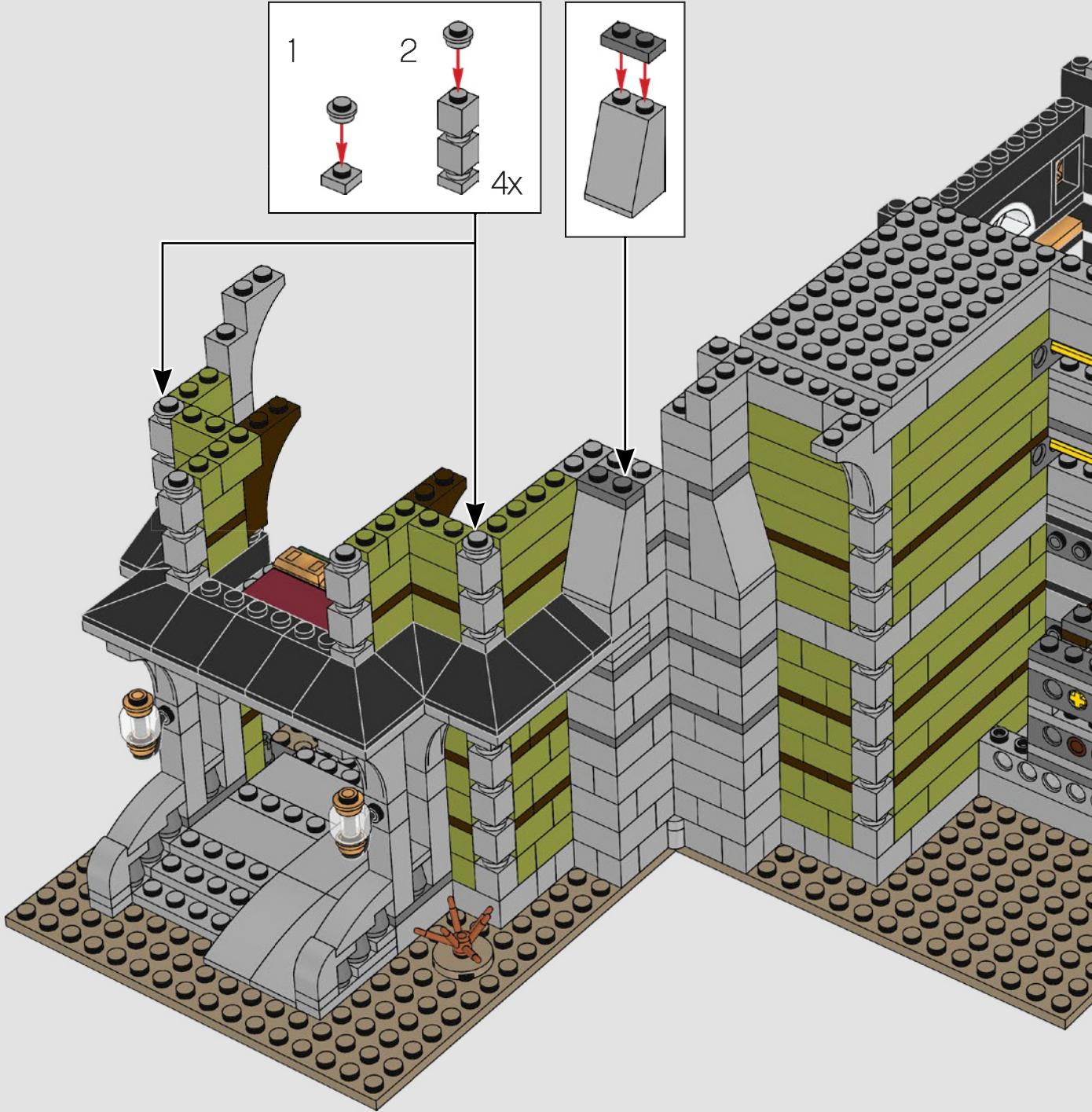
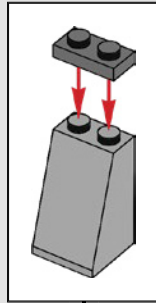
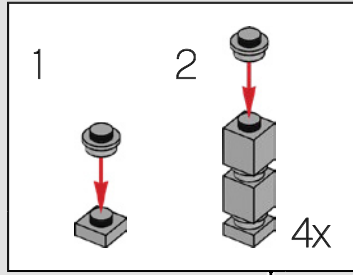

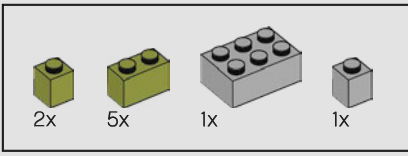

134

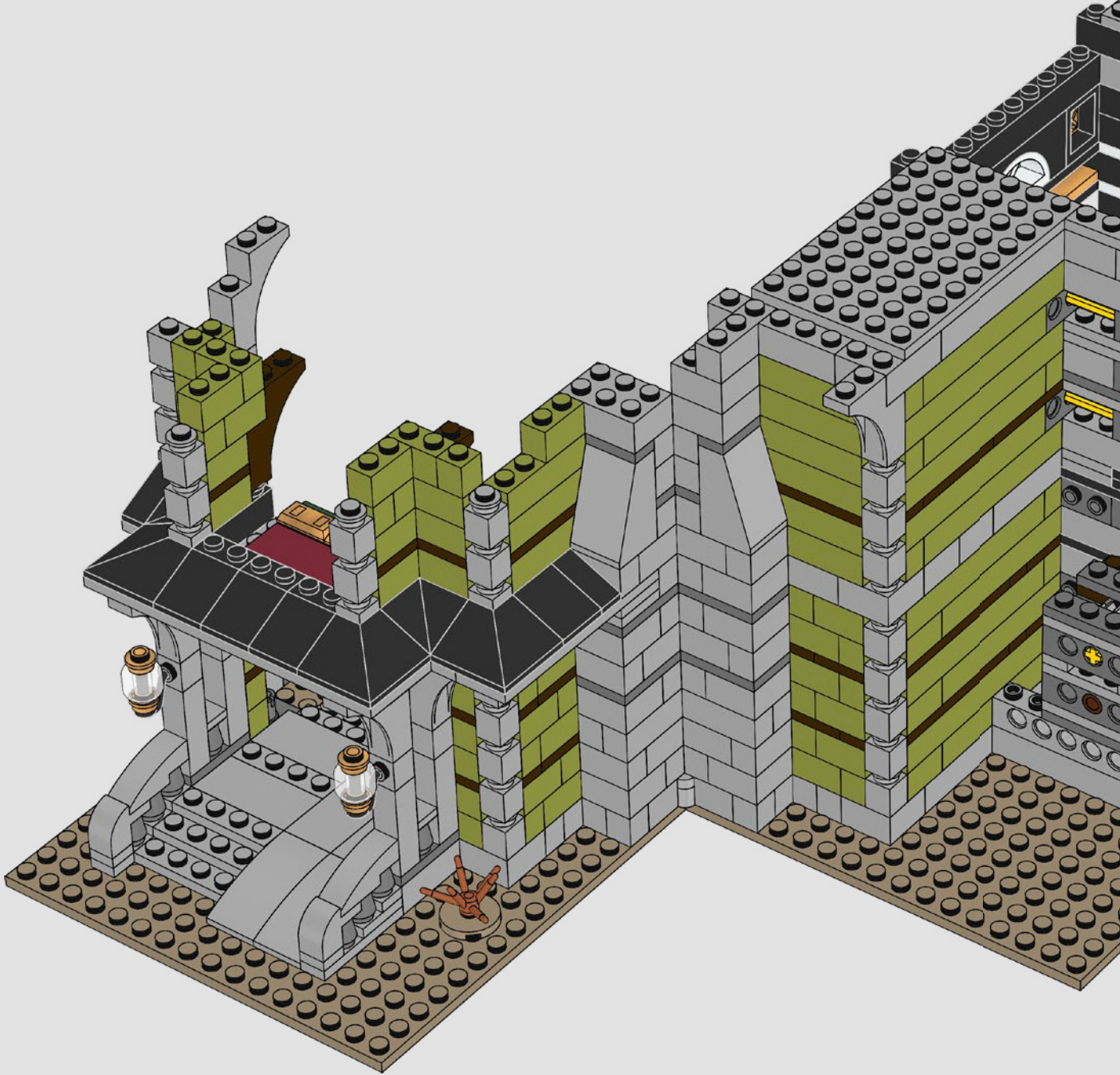

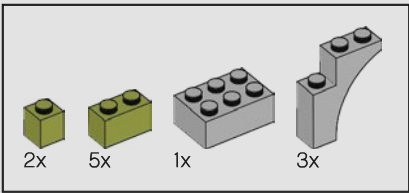

135

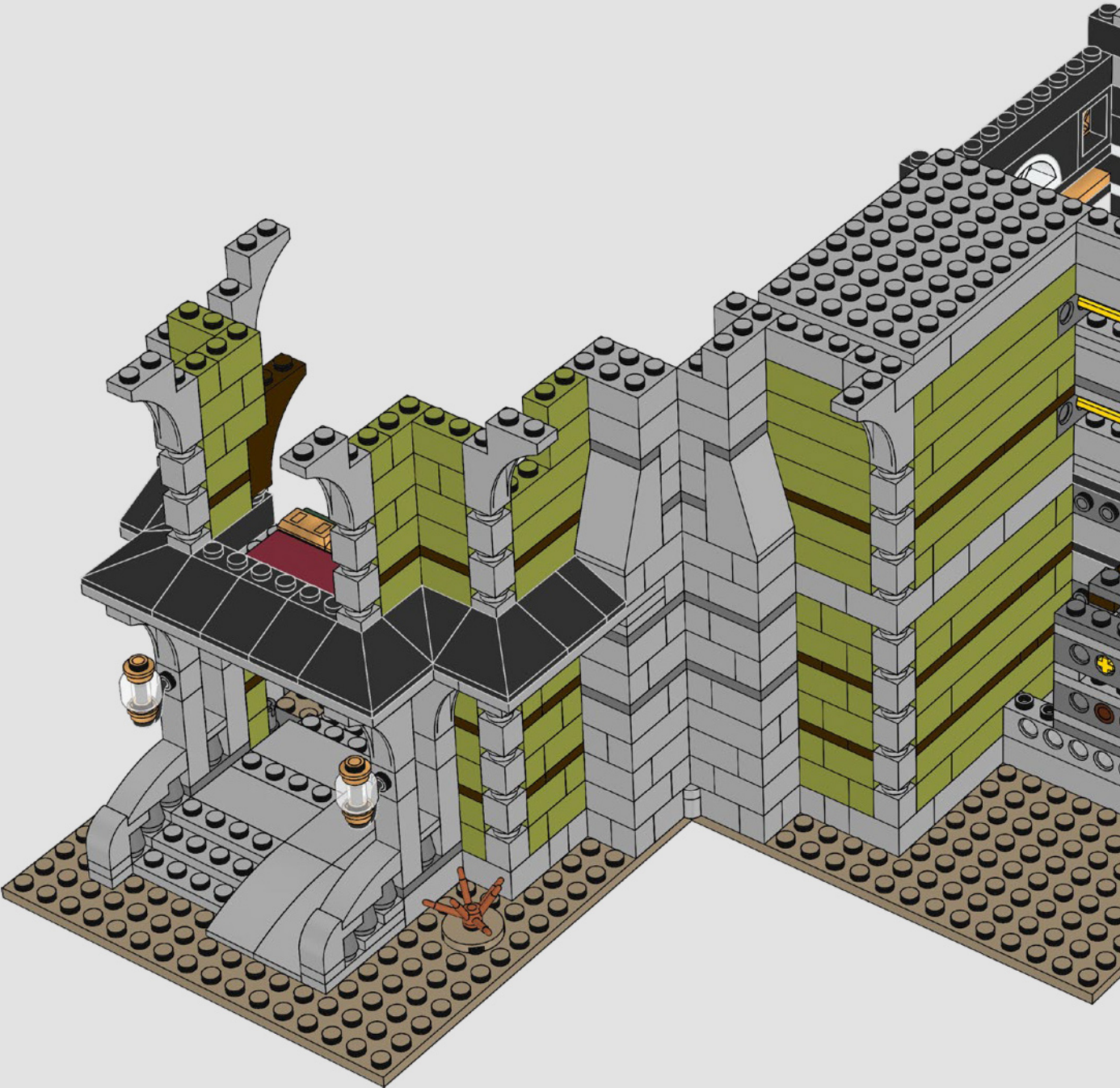

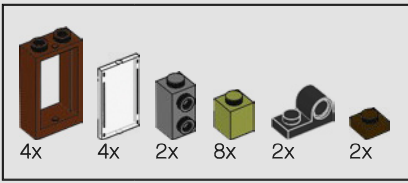

136

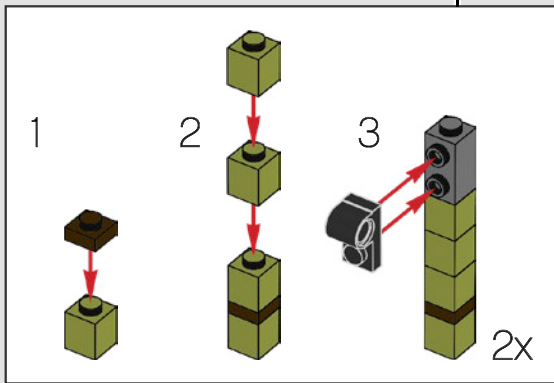
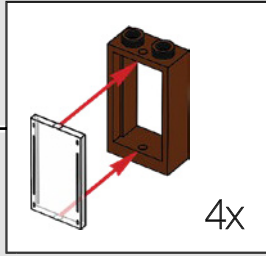

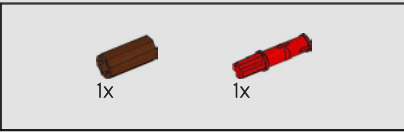
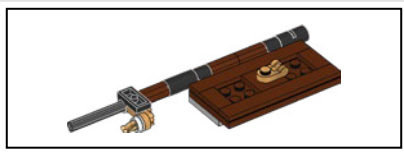

137

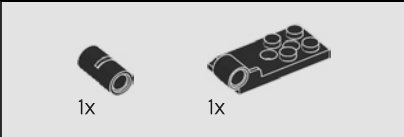
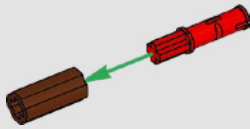

138

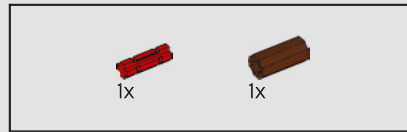
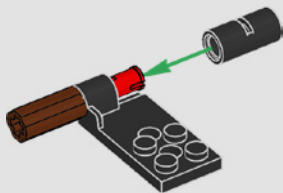

139

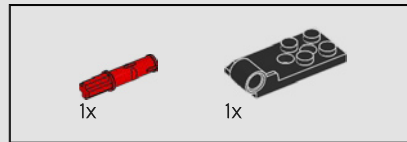
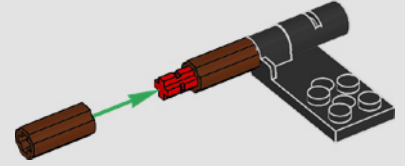

140

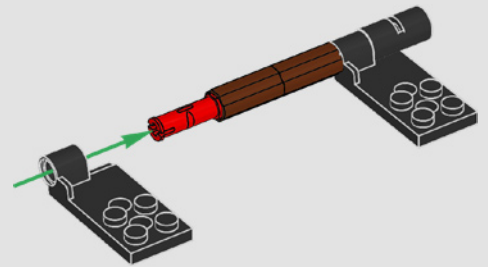

141

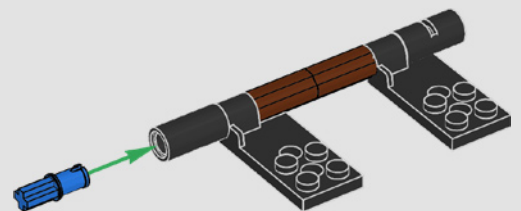

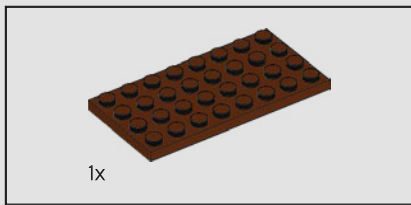

142

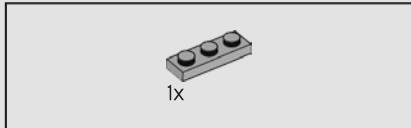
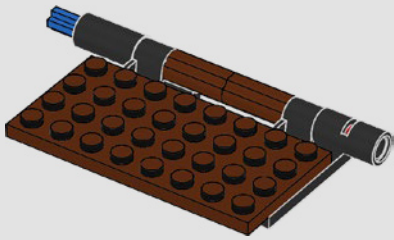

143

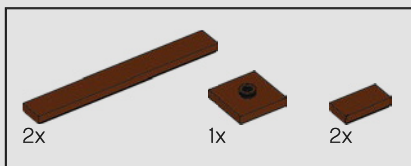
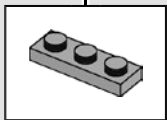
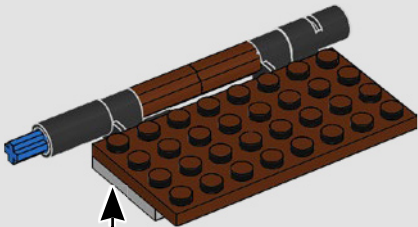

144

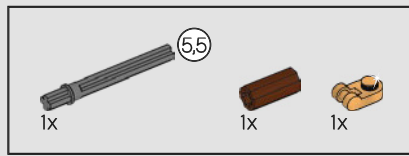
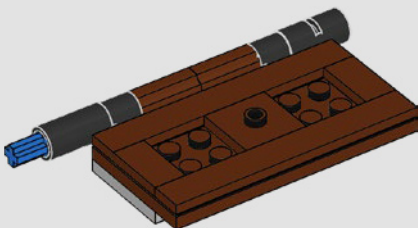

145

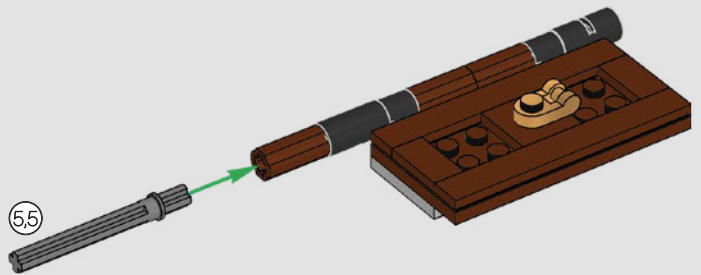

146

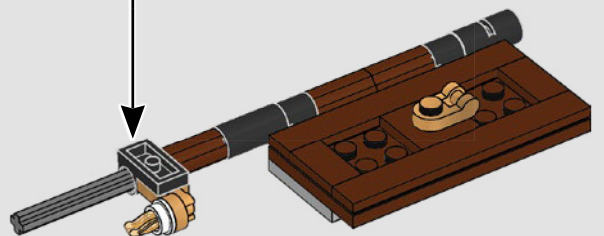
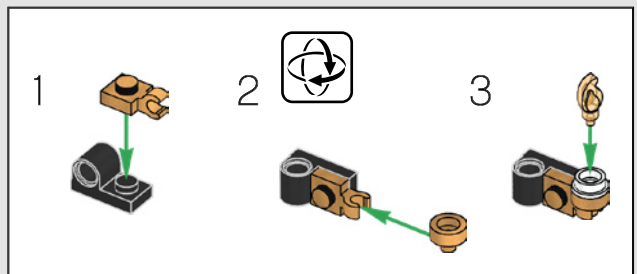

147



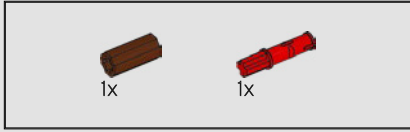
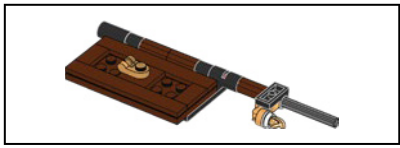

148

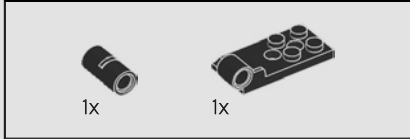
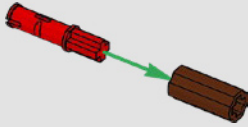

149

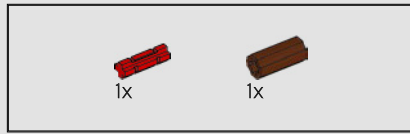
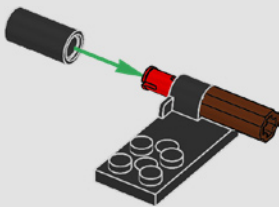

150

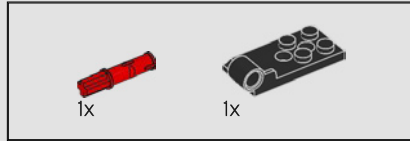
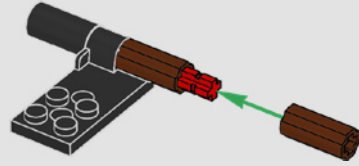

151

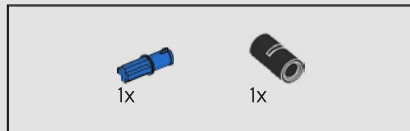
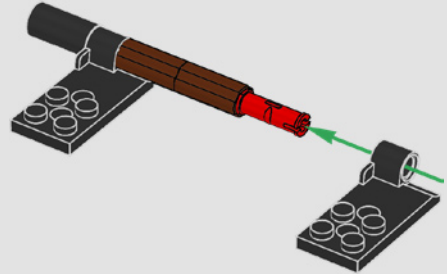

152

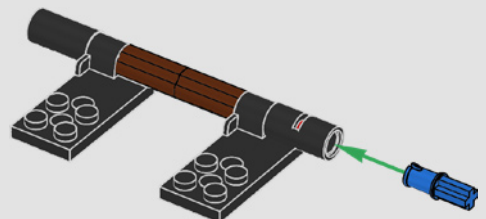

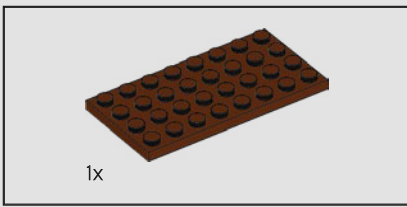

153

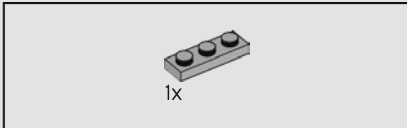
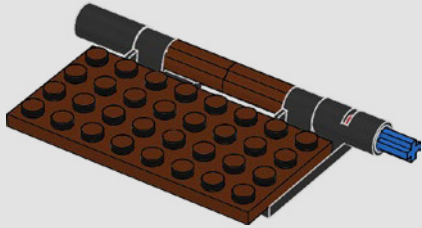

154

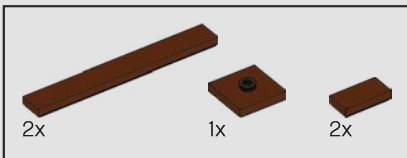
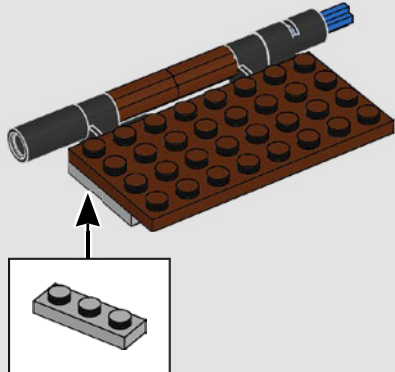

155

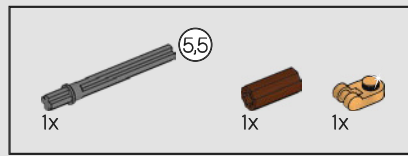
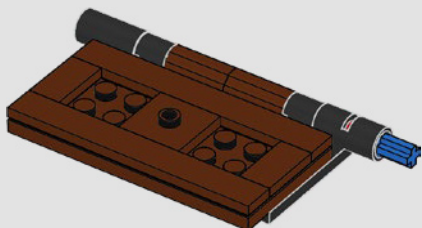

156

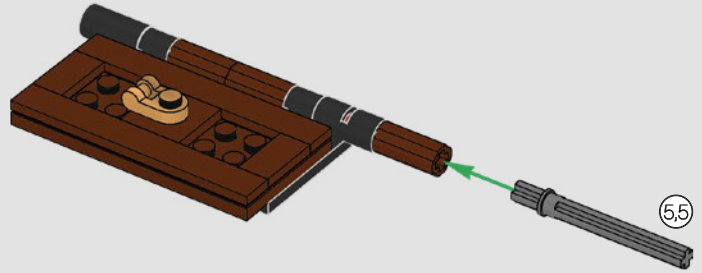

157

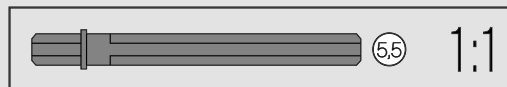
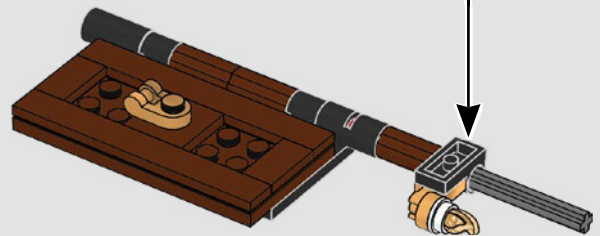
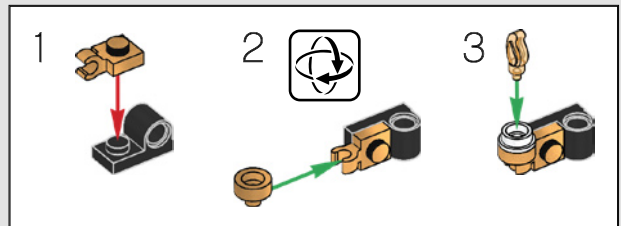

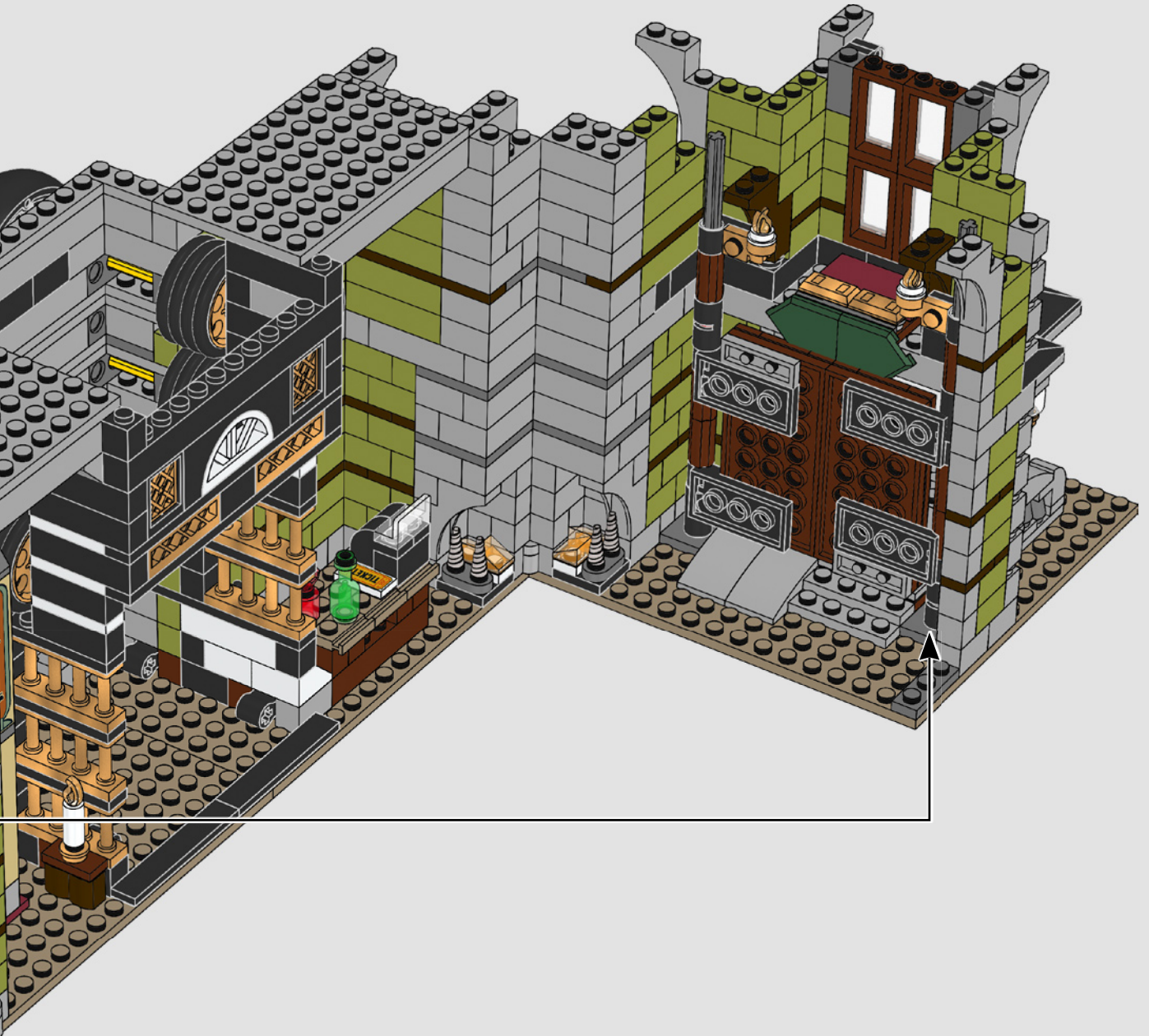

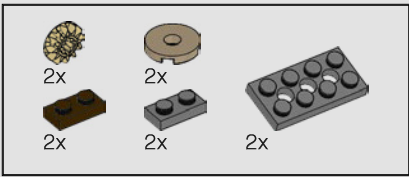

159

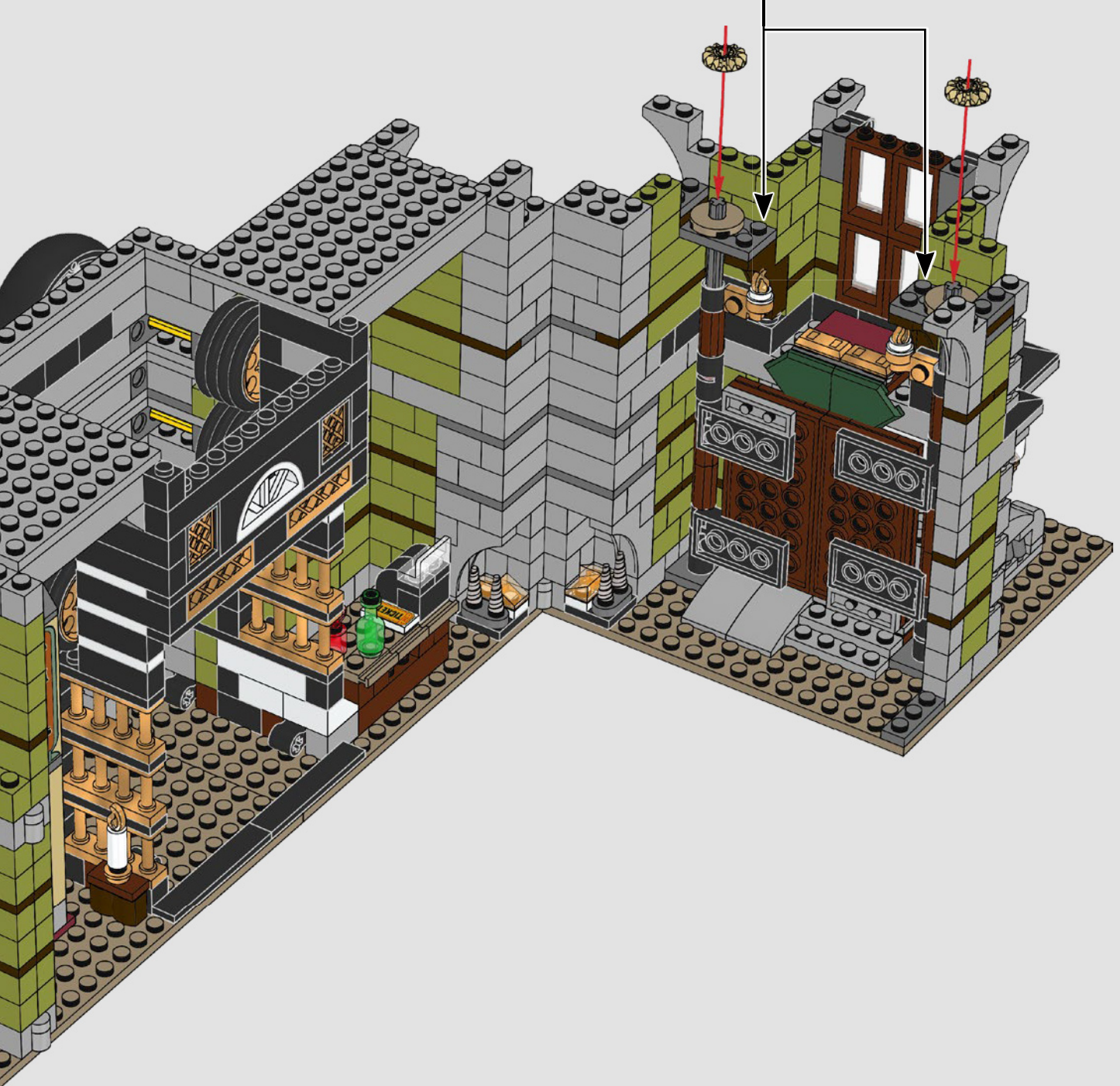
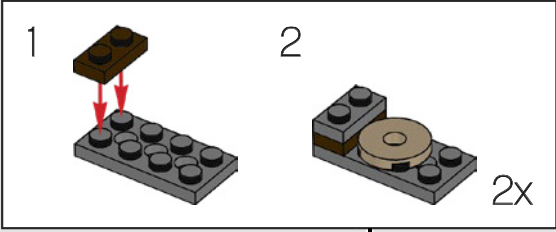

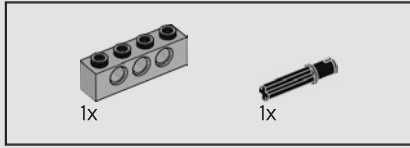
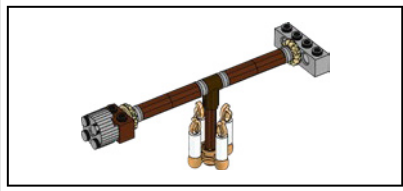

160

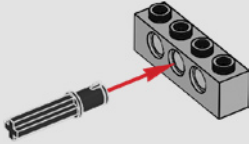

161

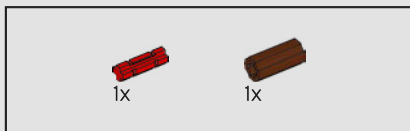
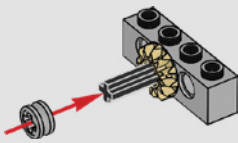

162

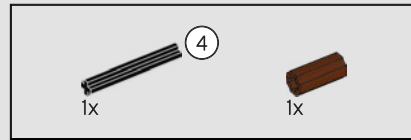
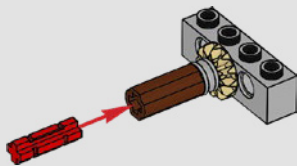

163

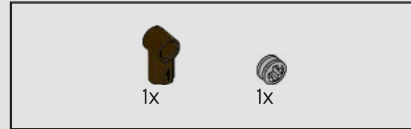
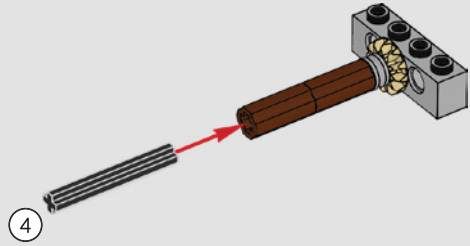

164

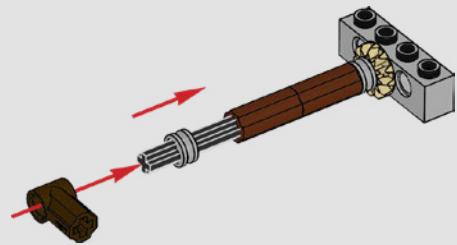

165

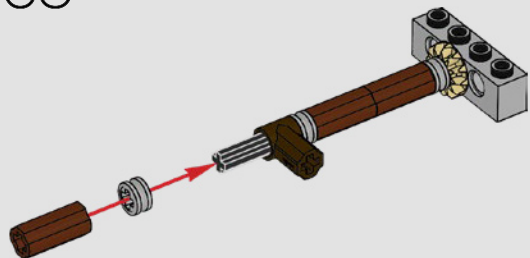

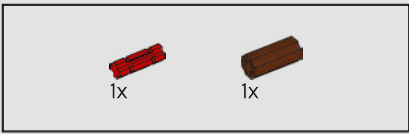

166

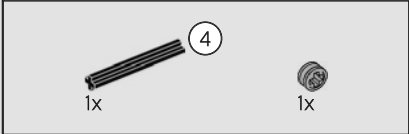
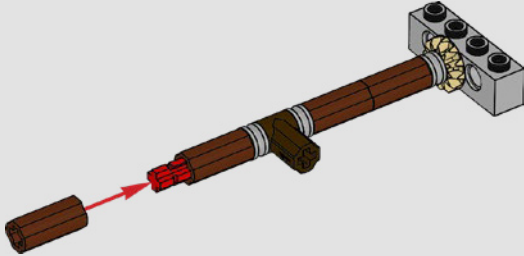

167

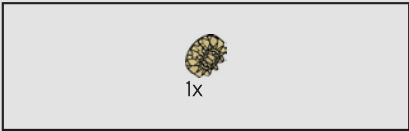
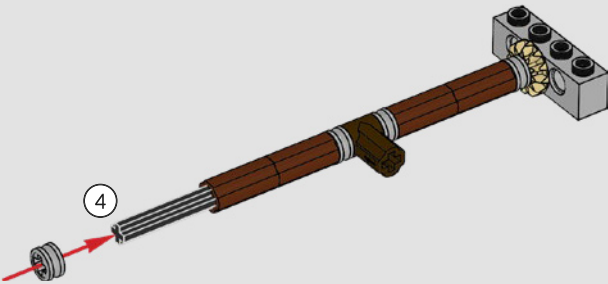

168

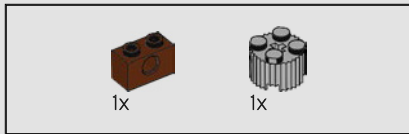
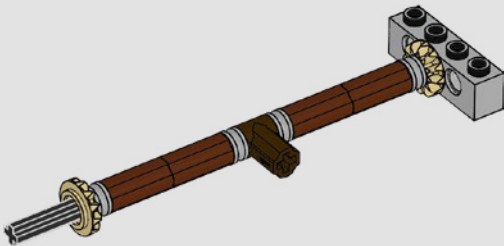

169

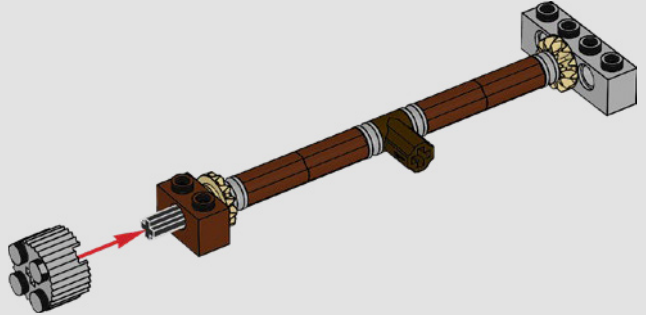

170

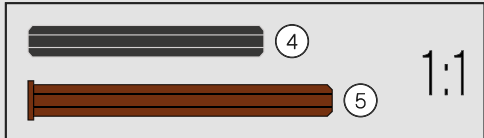
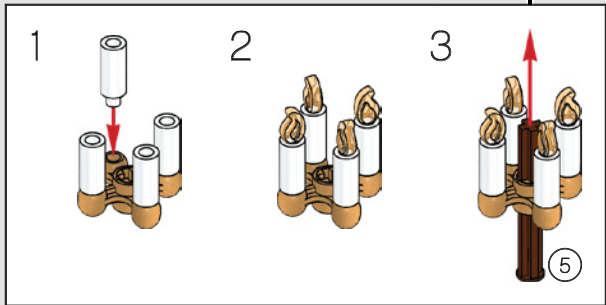
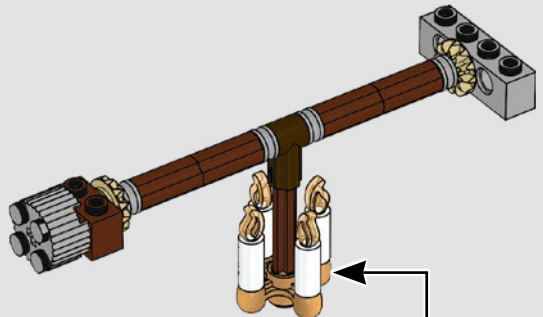

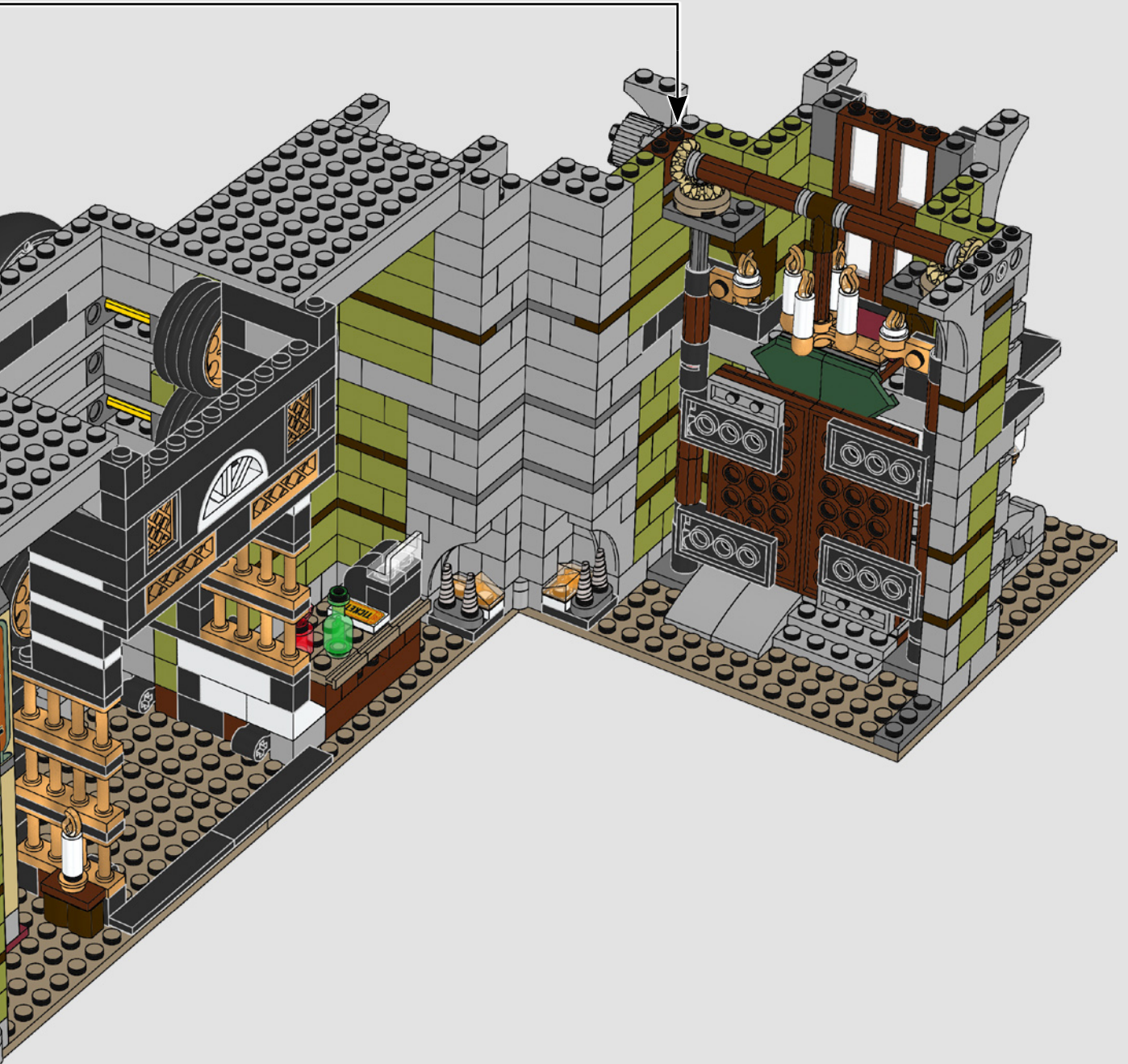

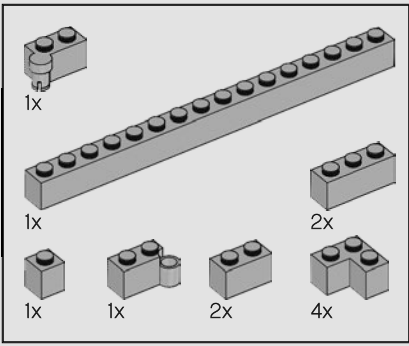

172

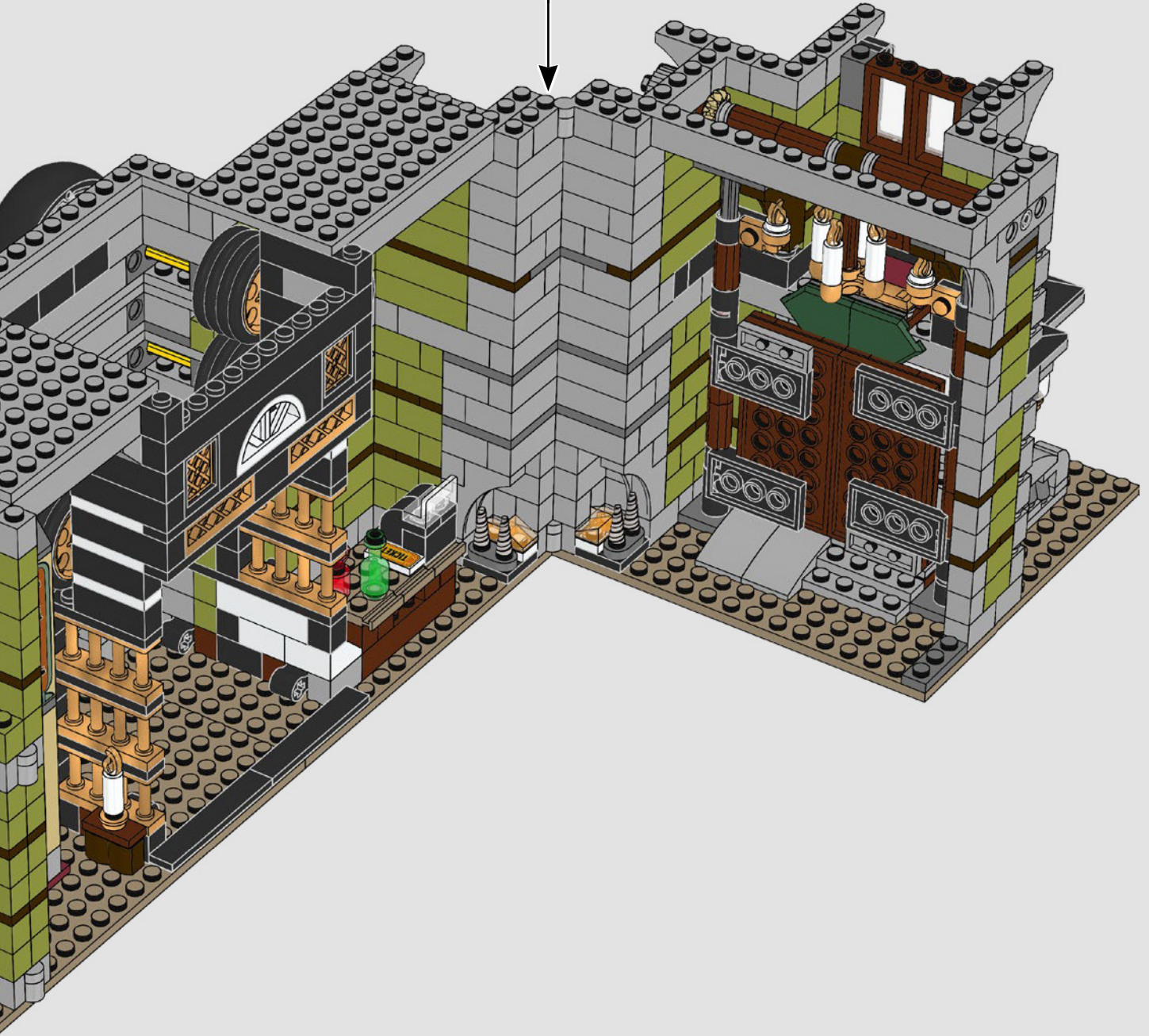
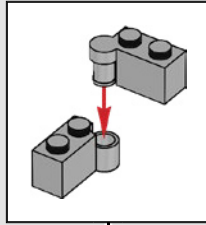

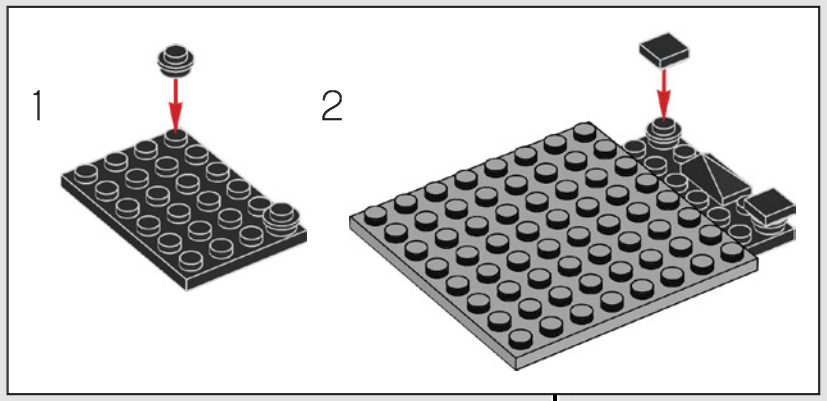
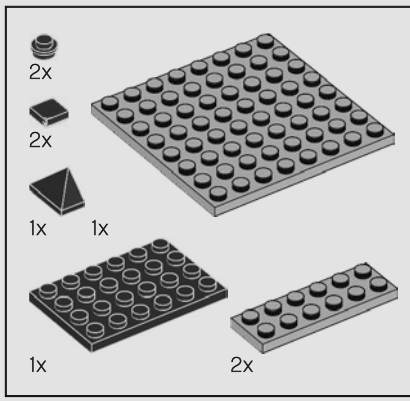

173

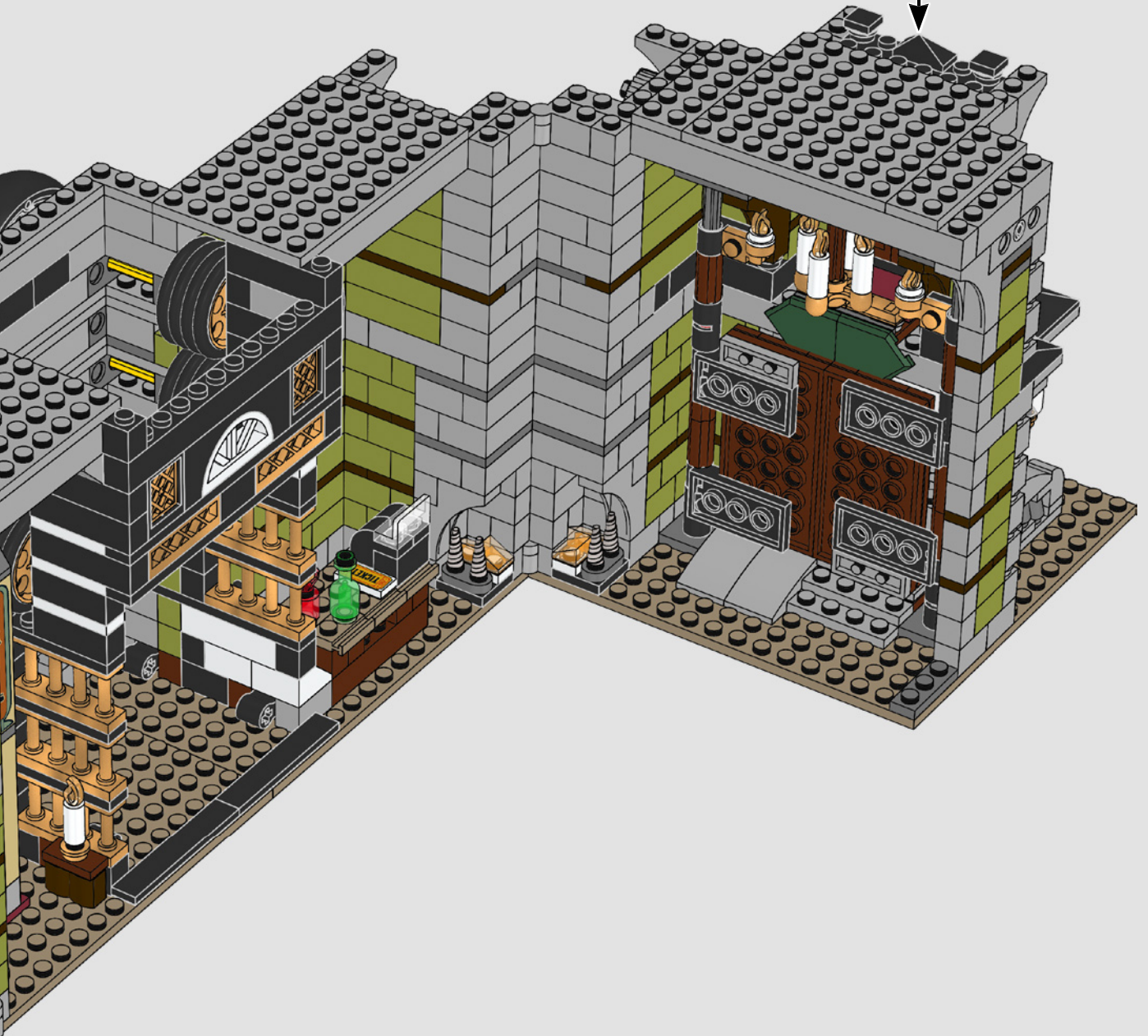

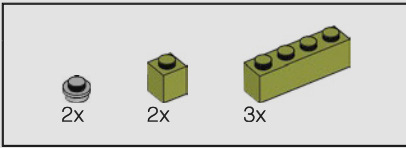
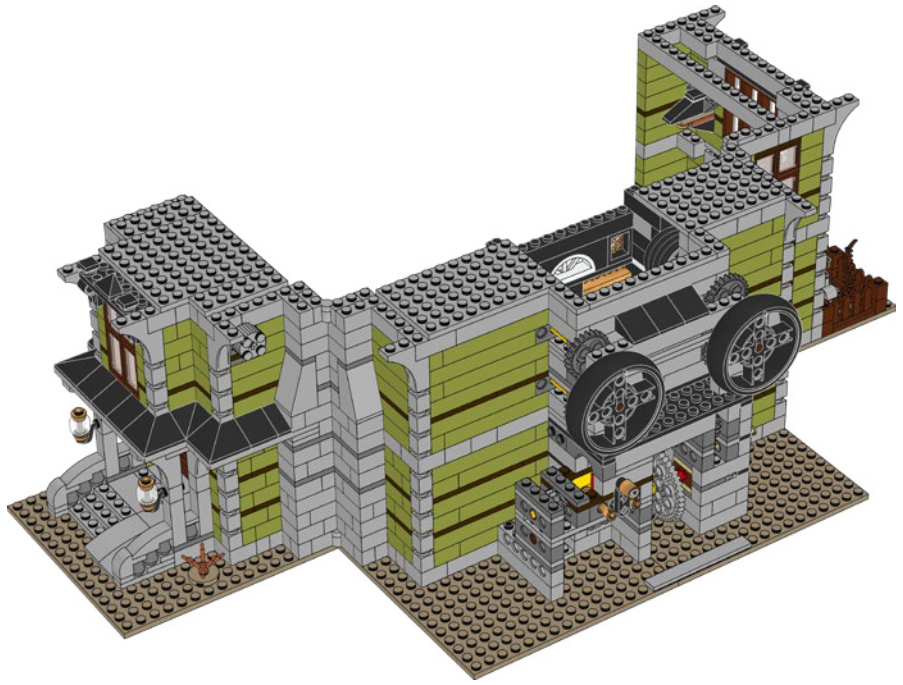

174

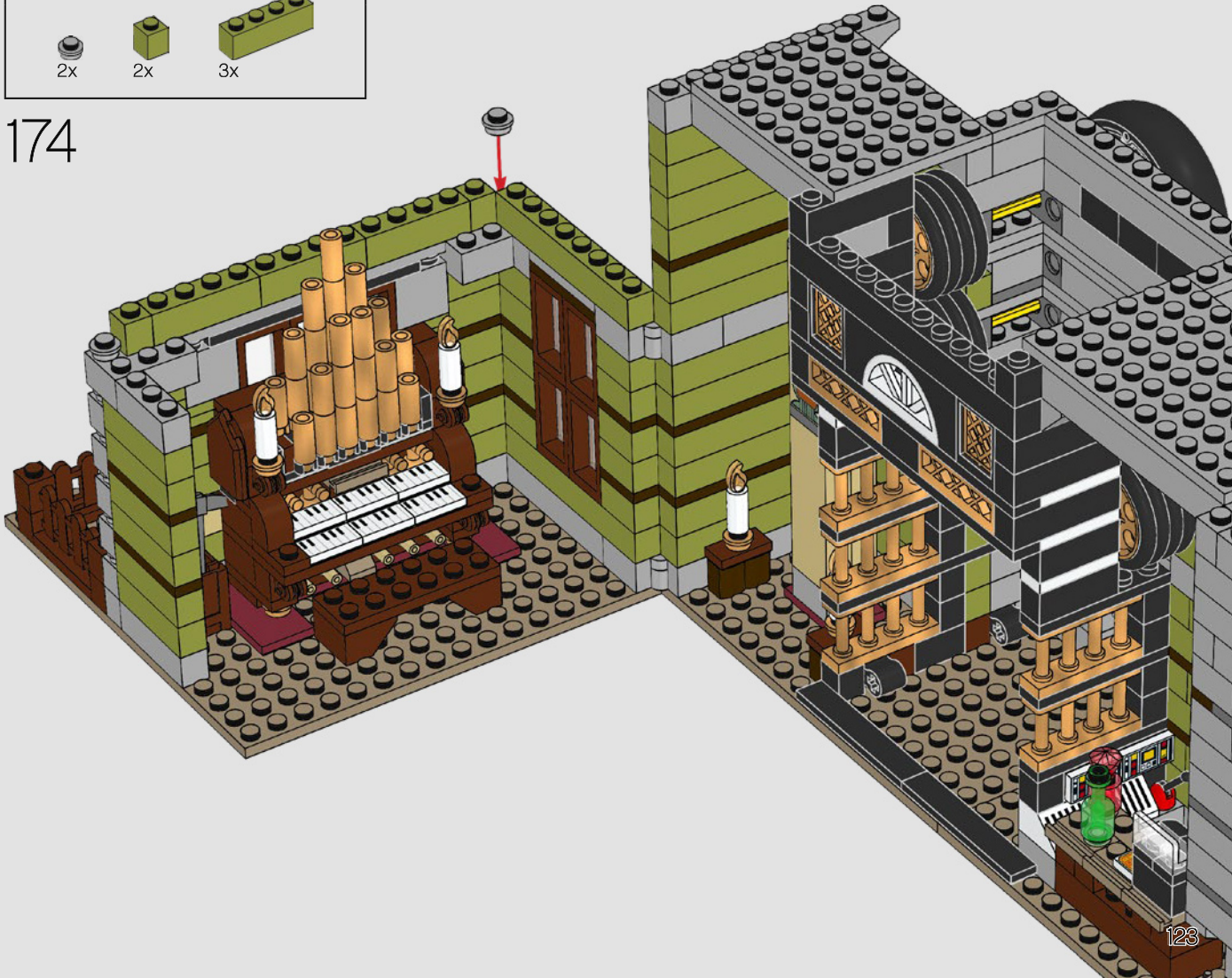

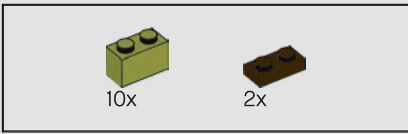

175

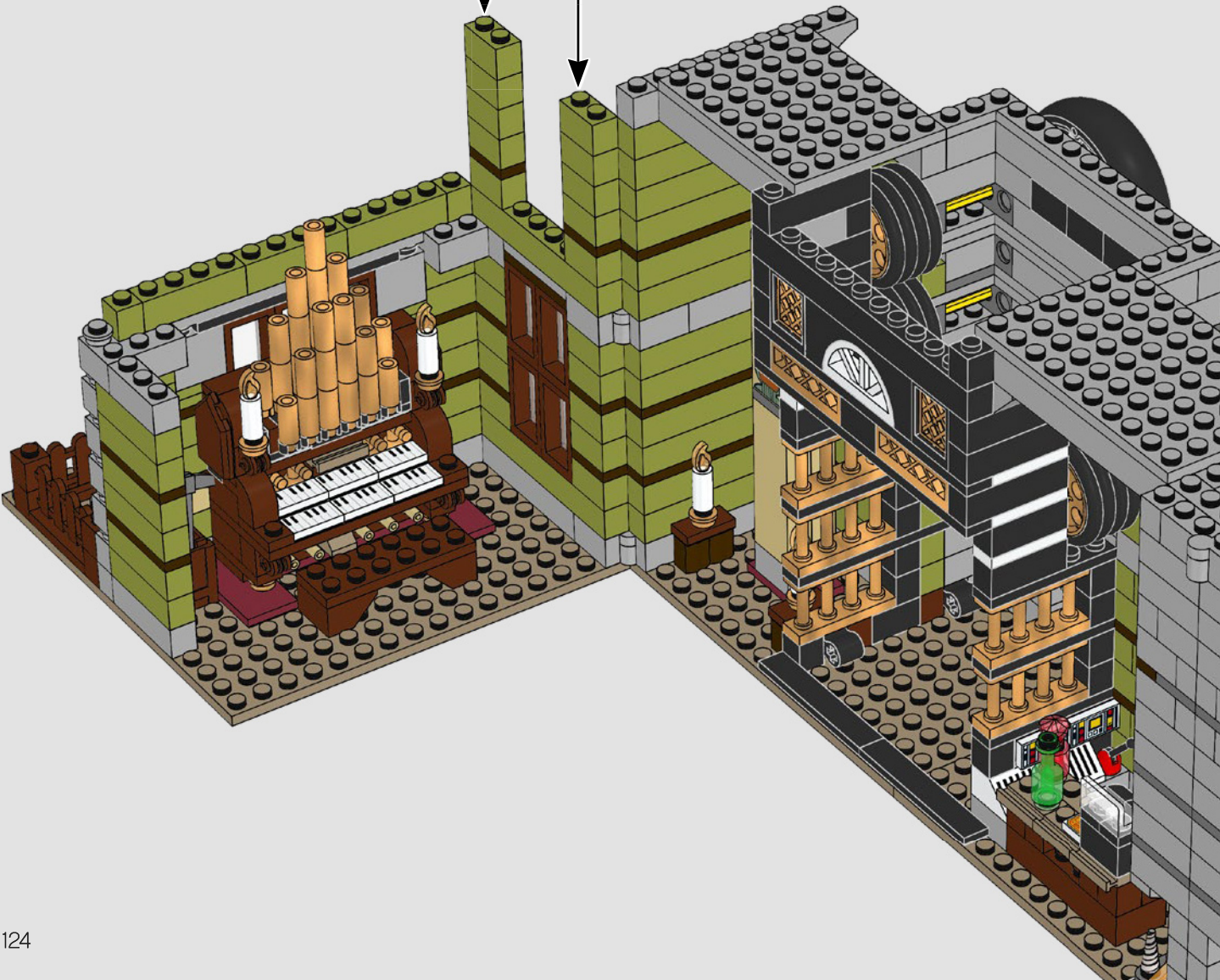
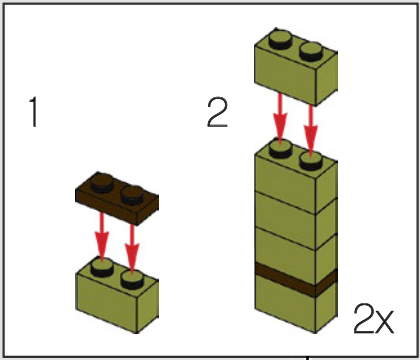

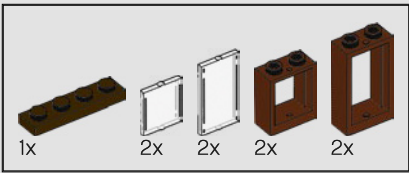

176

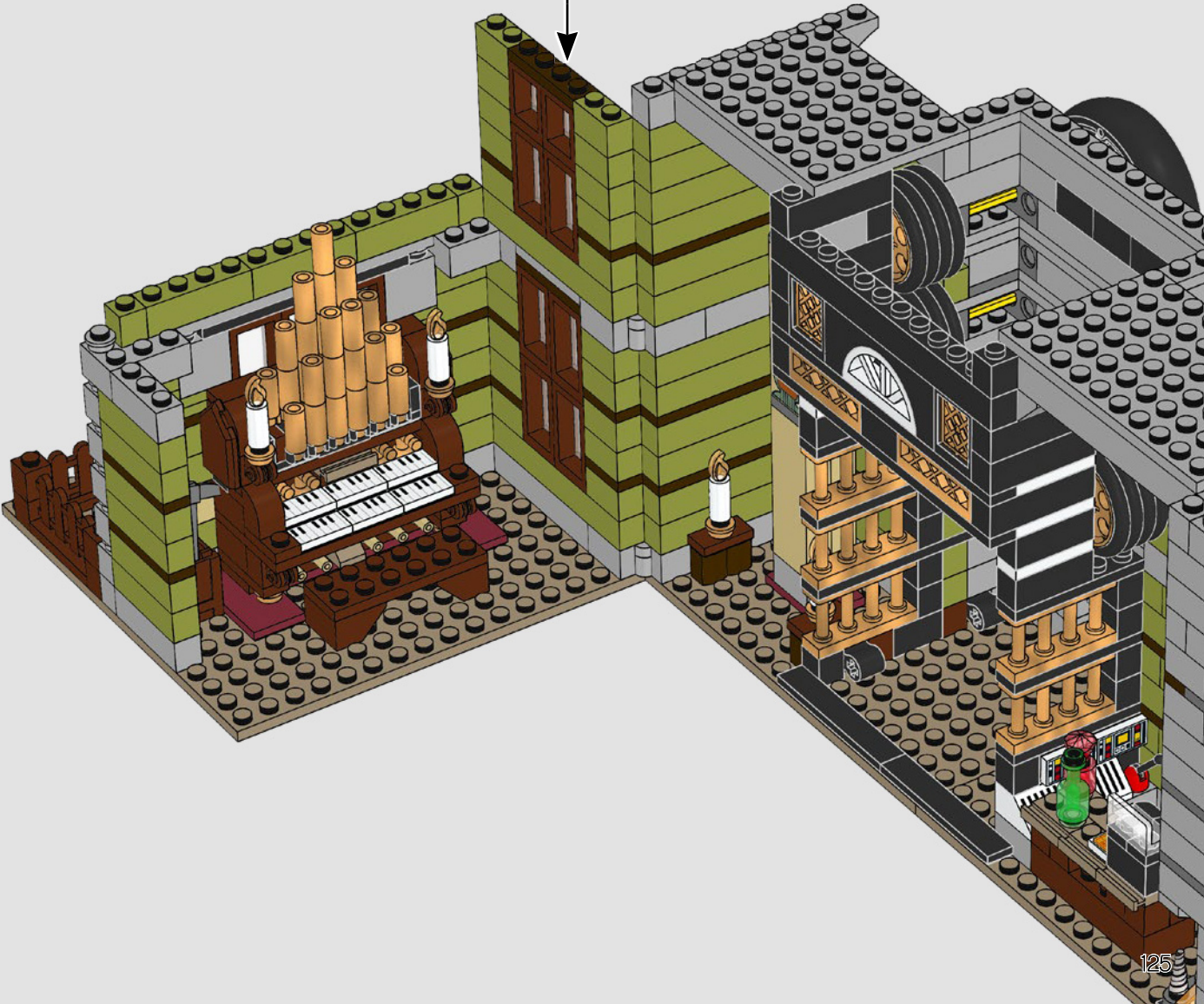
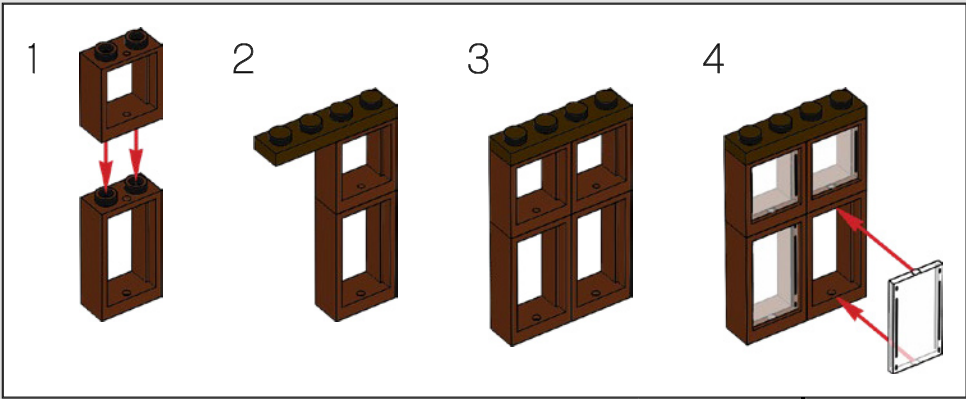

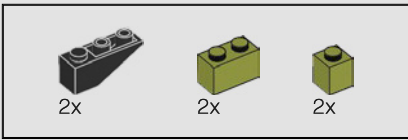

177

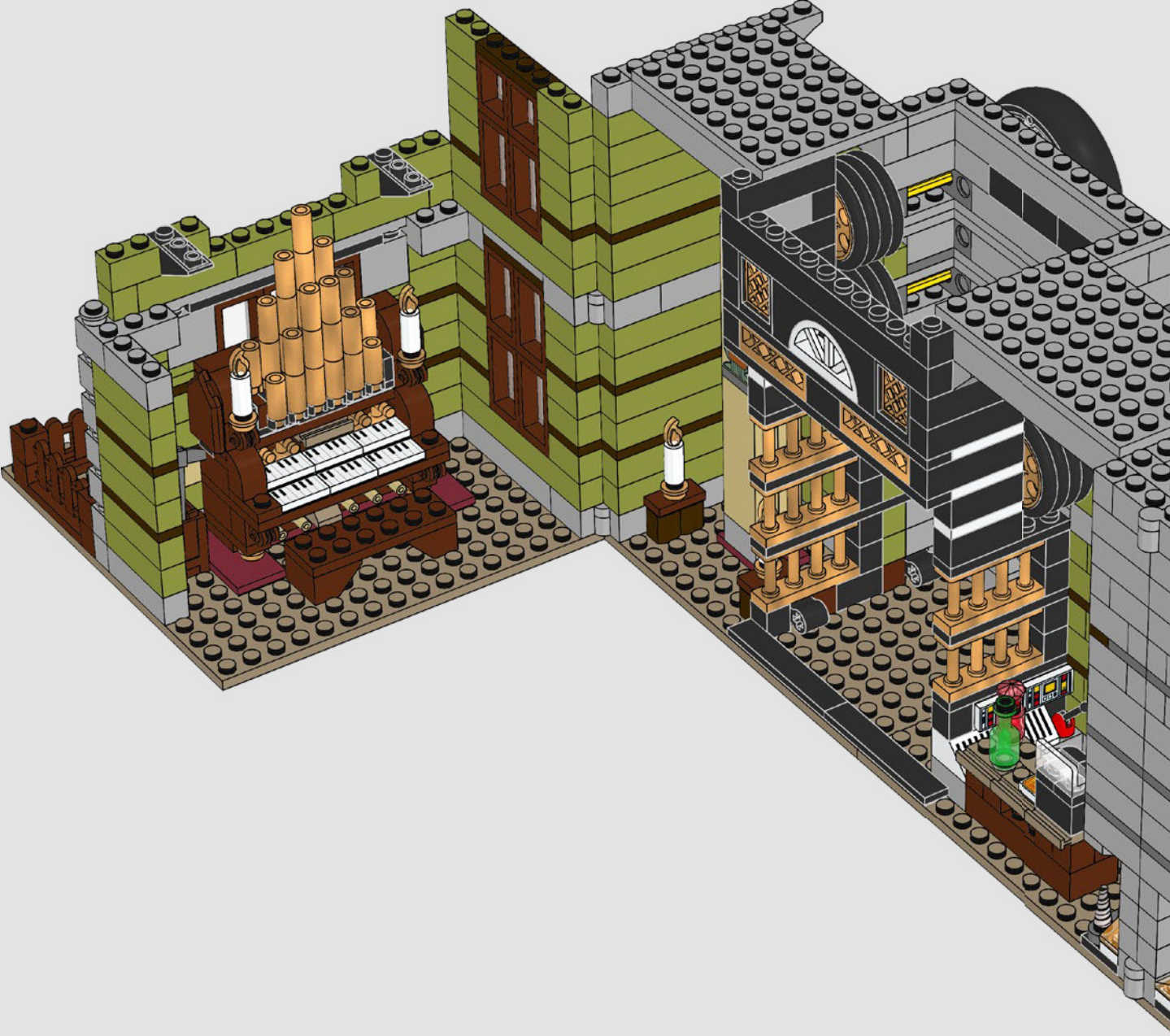

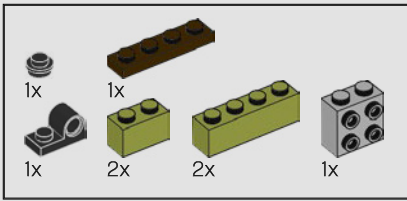

178

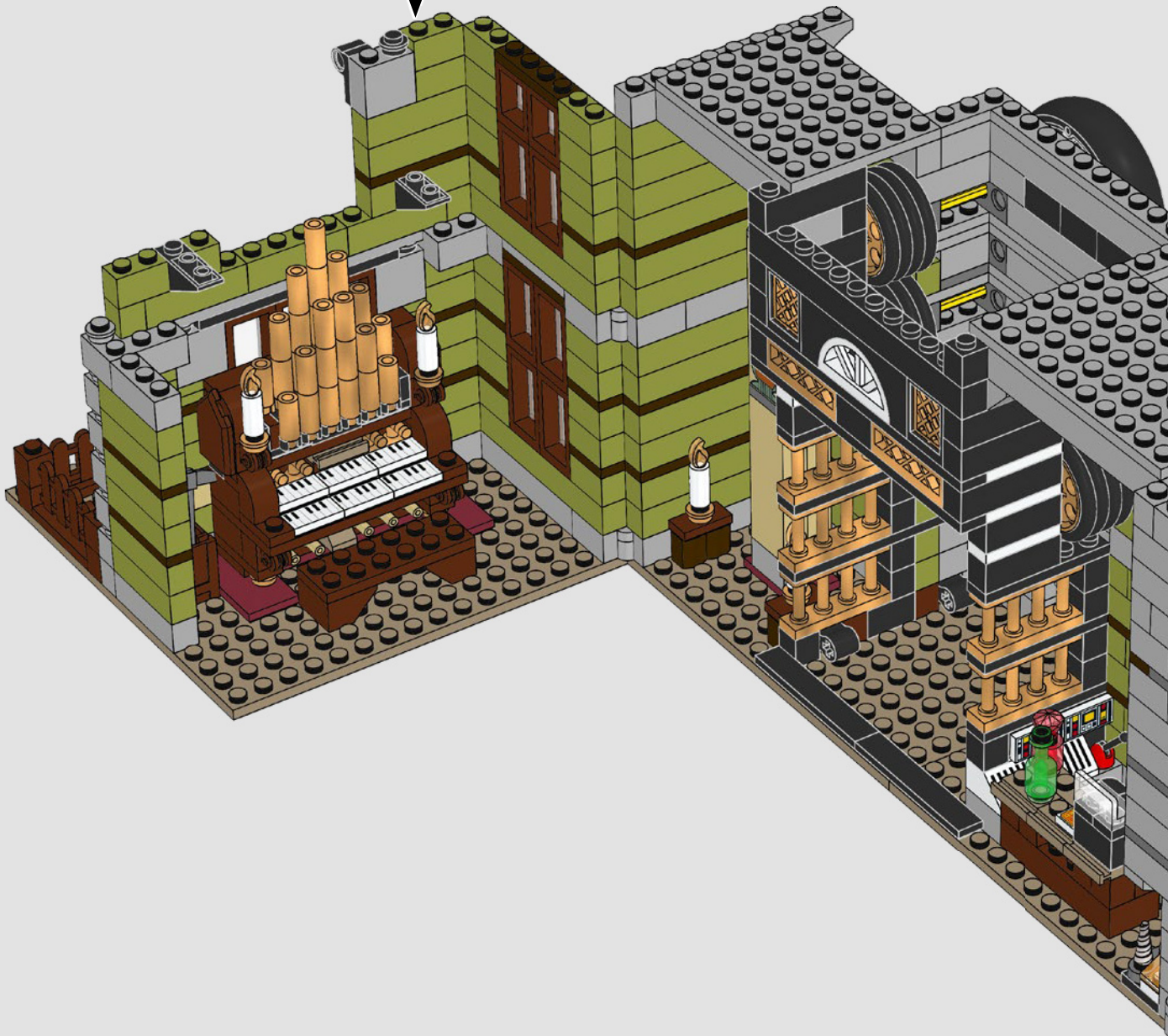
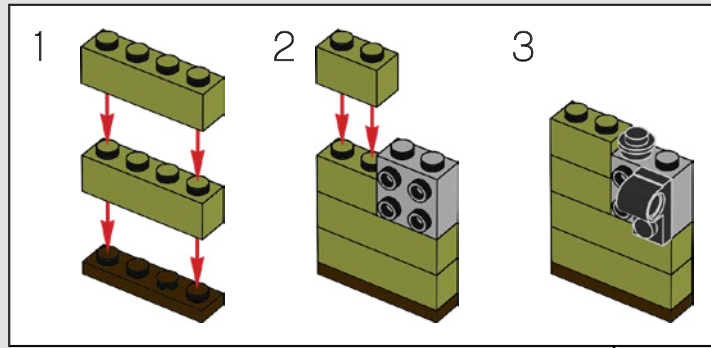

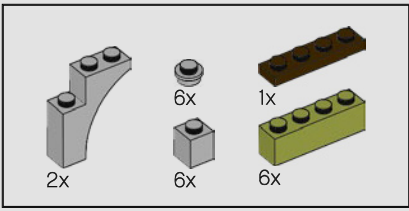

180

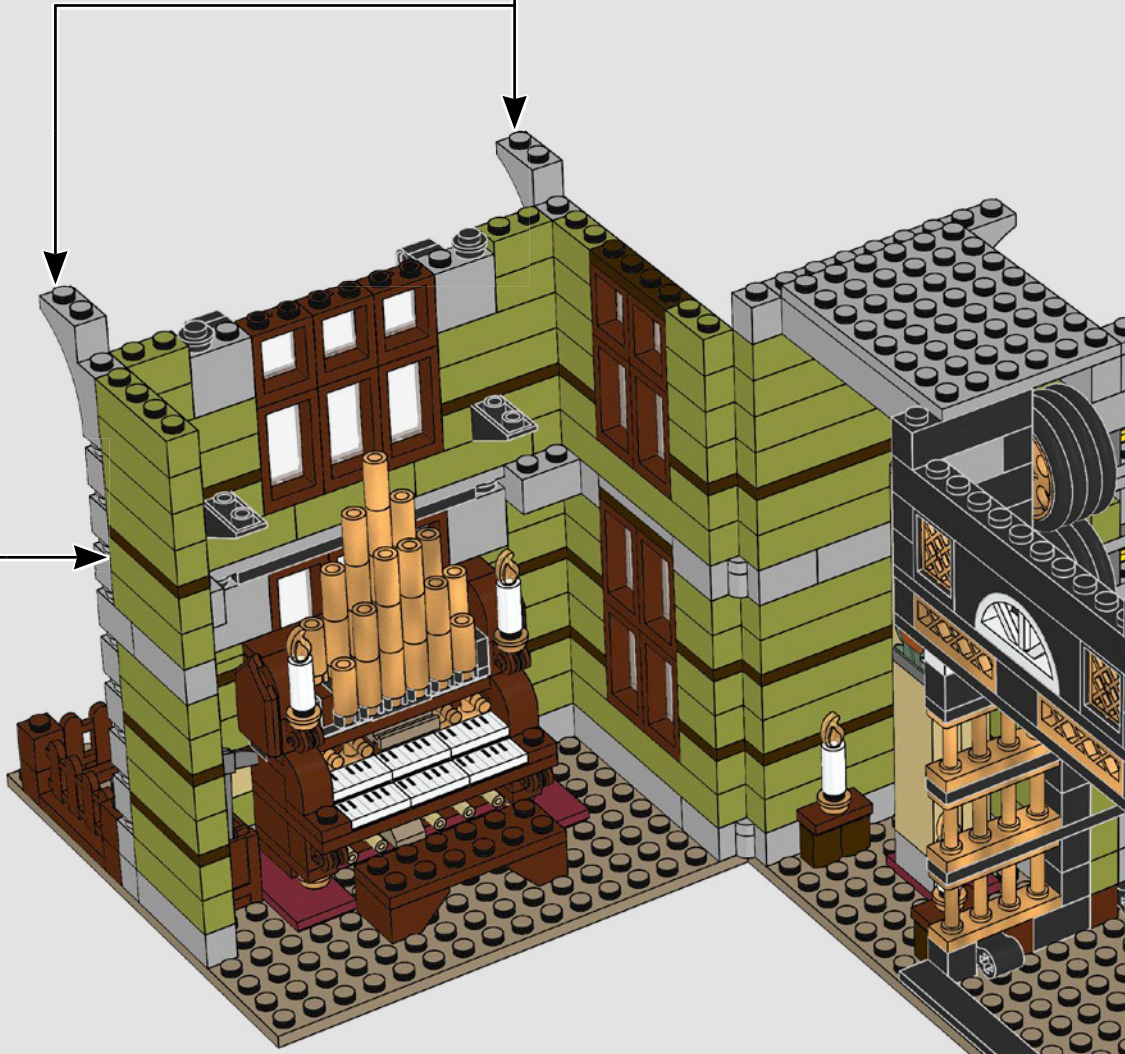
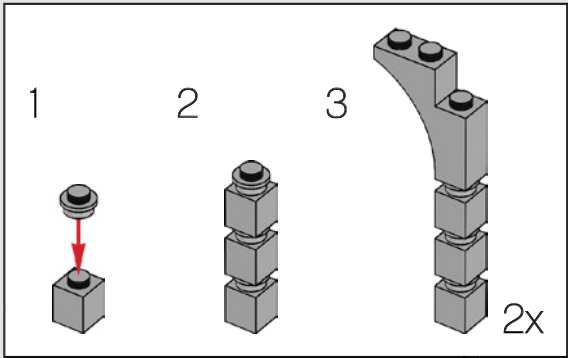
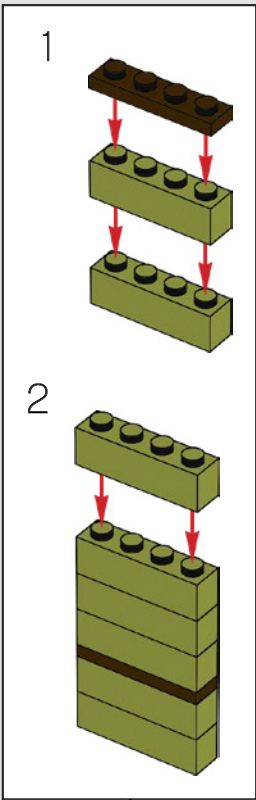

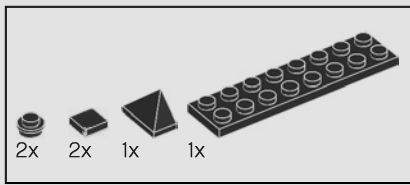

181

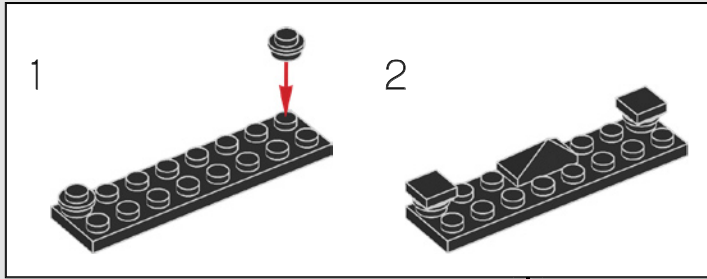

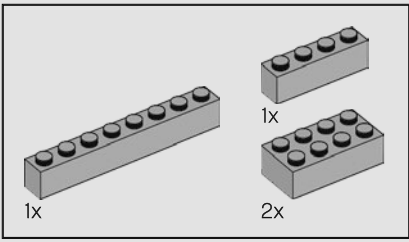

182



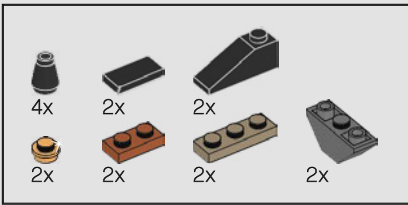

Las Cabezas de Anubis
 Sacadas por vía aérea del templo de Anubis, supuestamente son "solo para decoración; para eso y nada más".

183

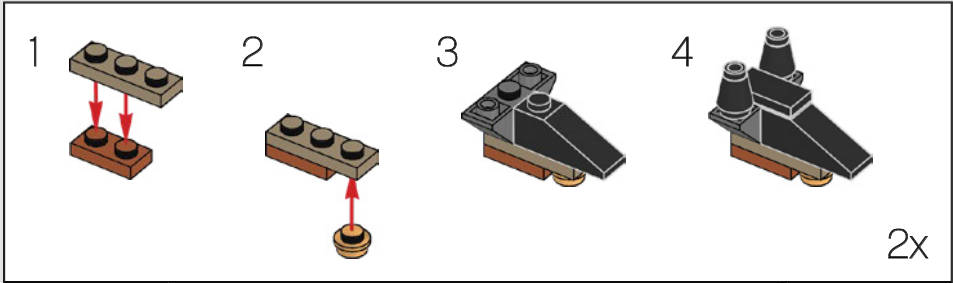

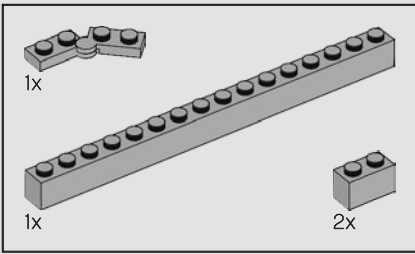

184

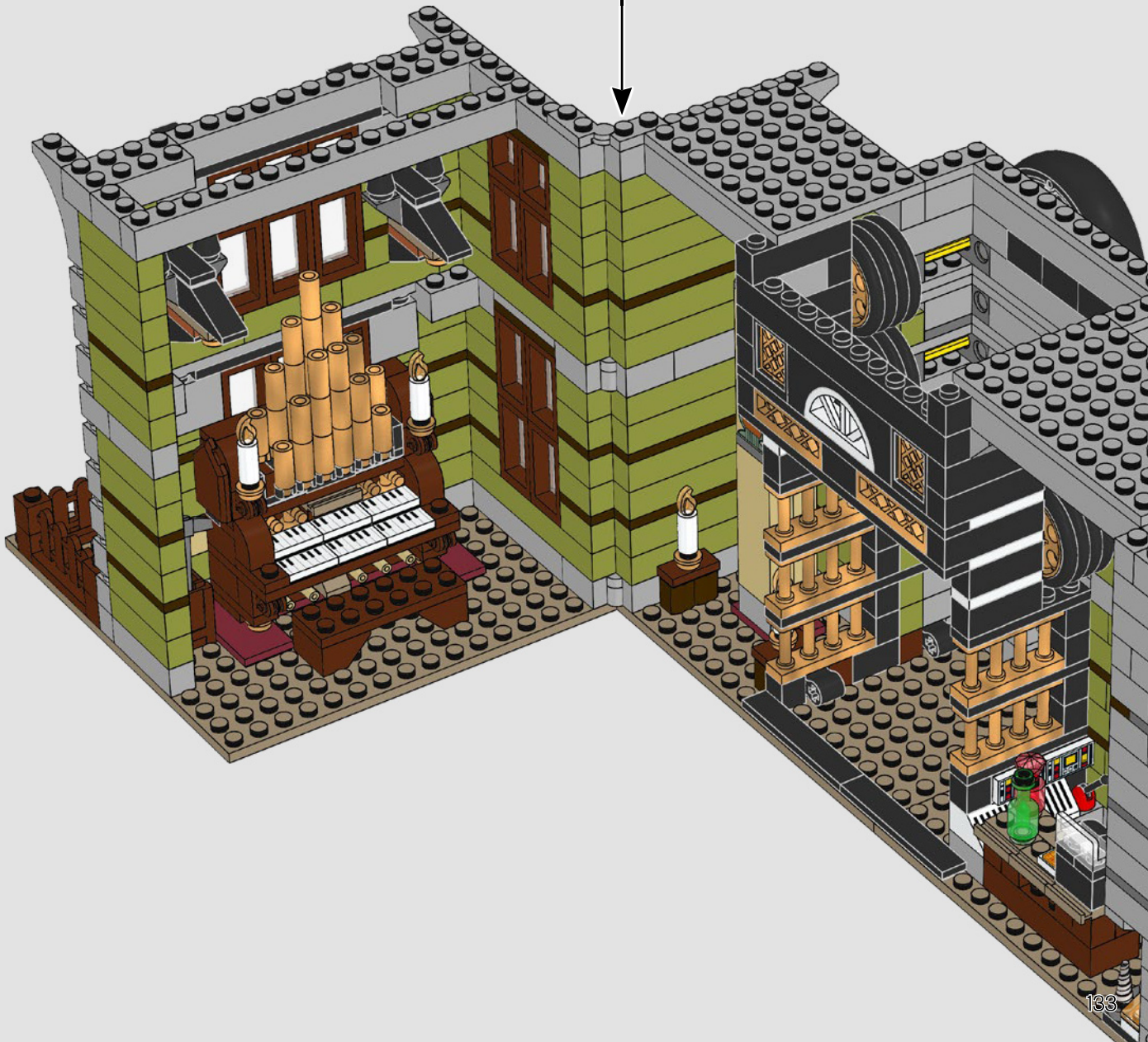
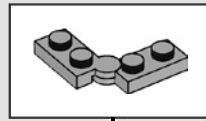

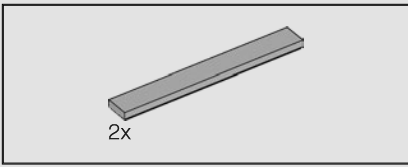

185



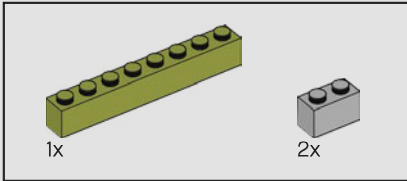
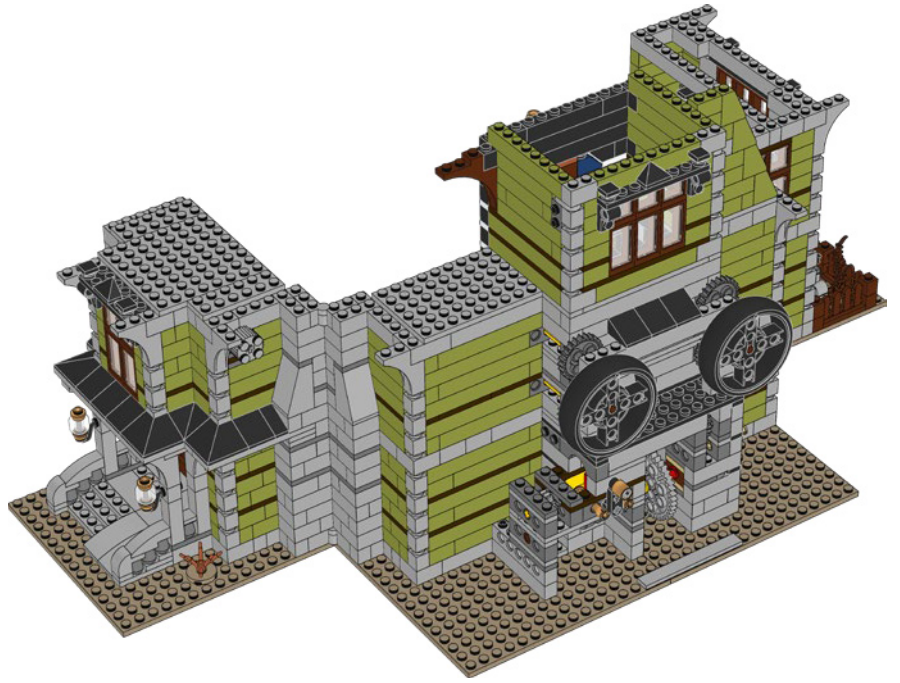

186



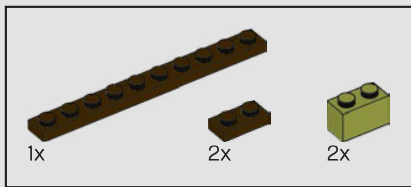

187

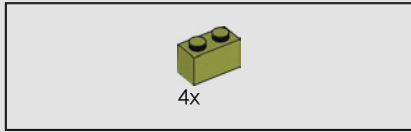
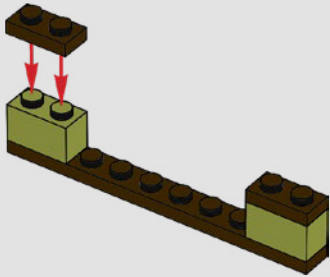

188

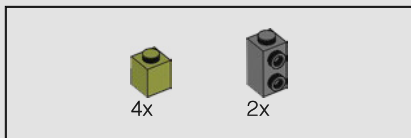
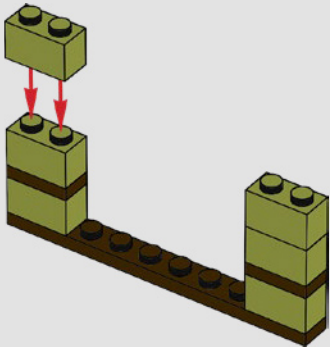

189

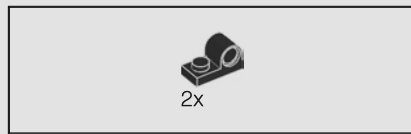
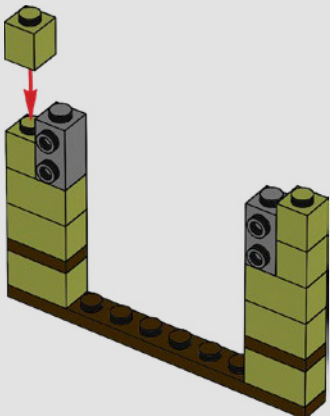

190

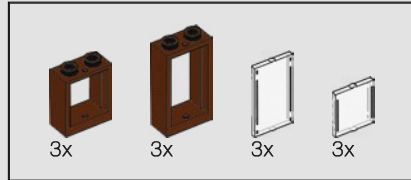
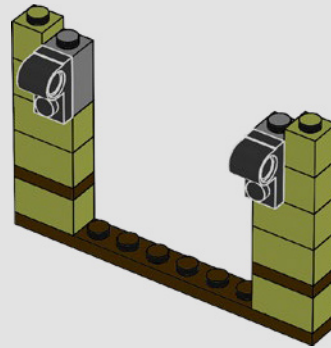

191

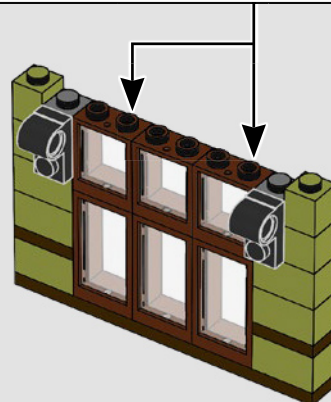
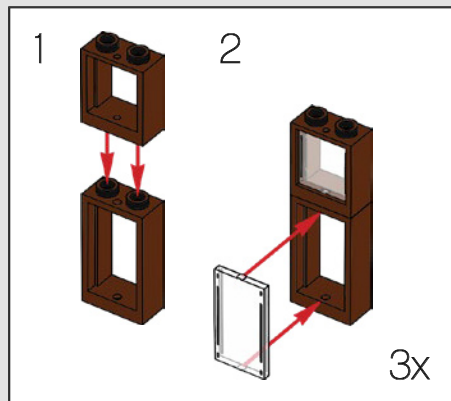

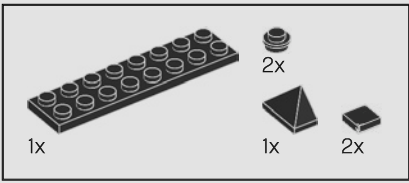

192

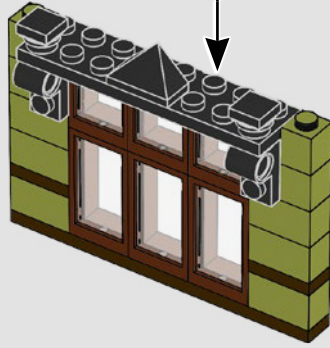
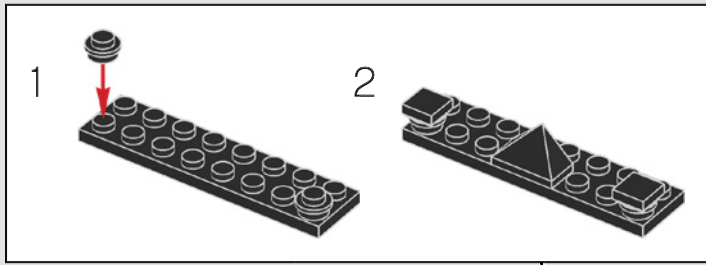

193





8x



8x

194

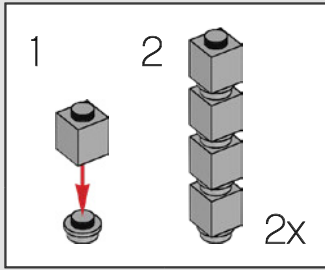

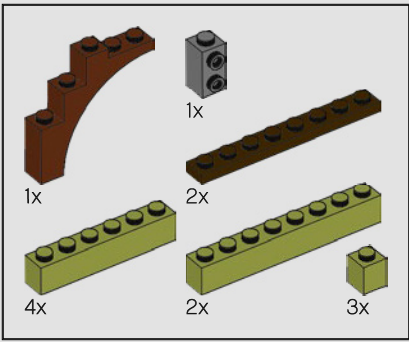

195

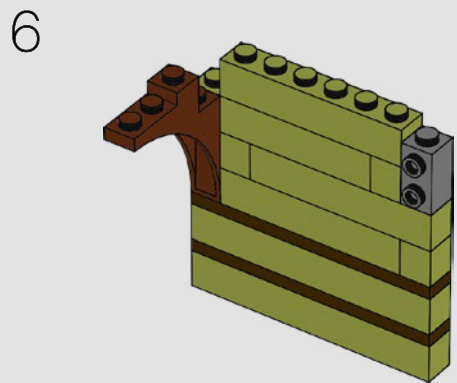
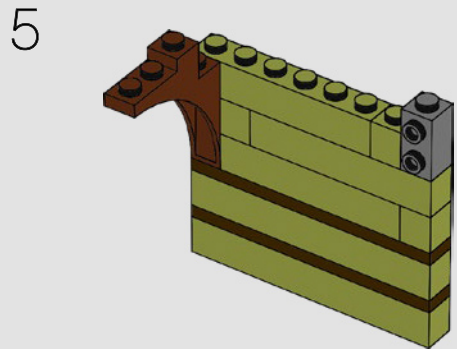
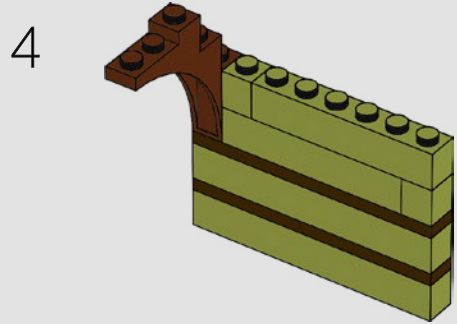
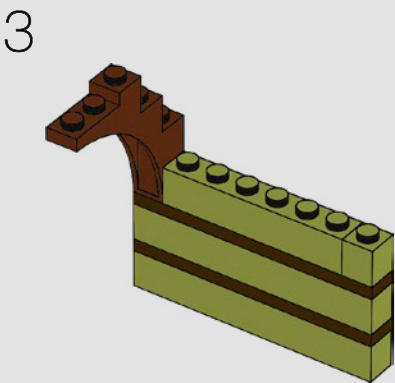
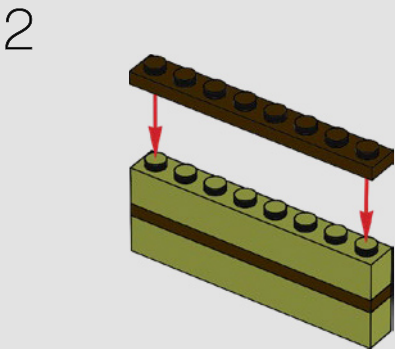
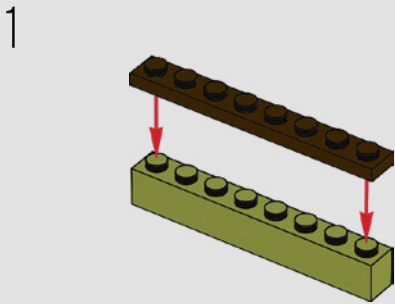



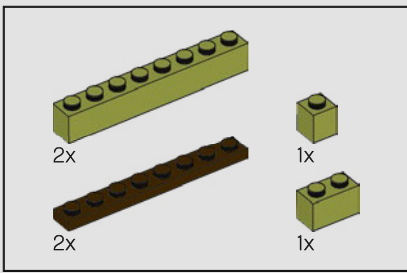

196

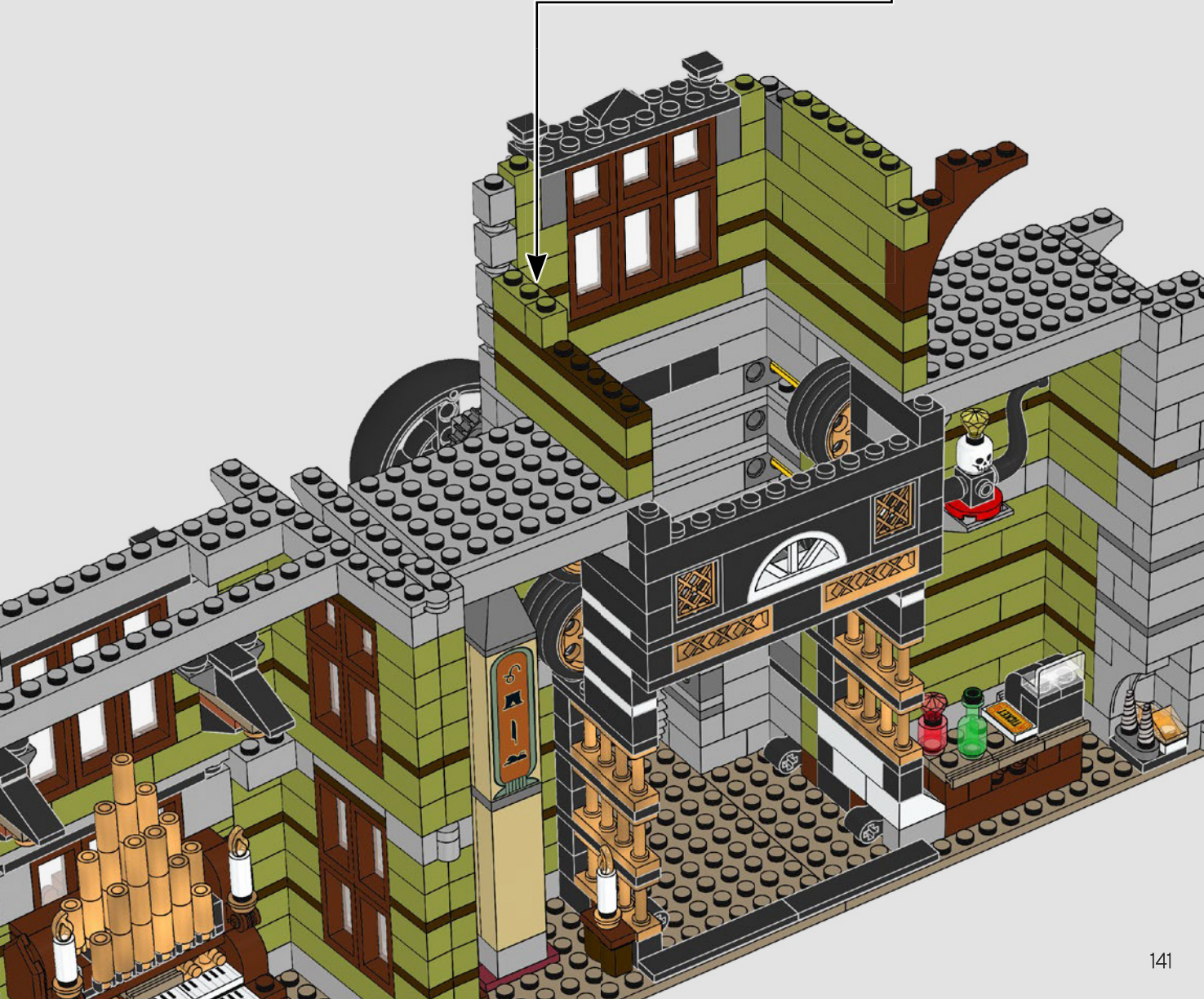
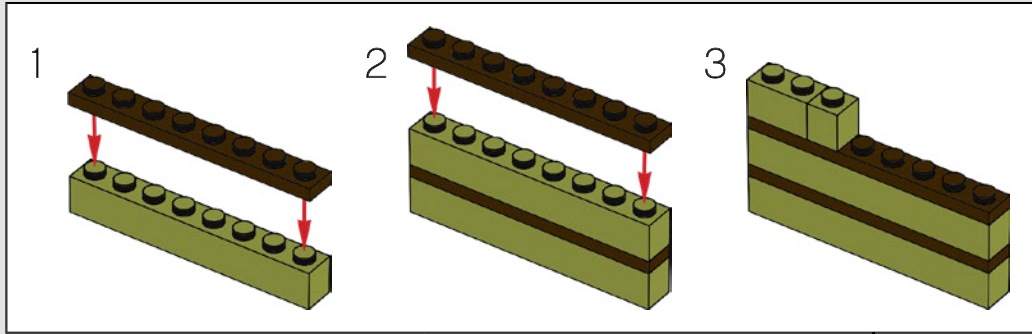

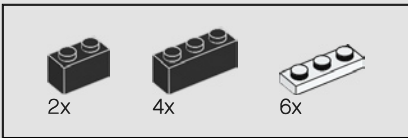

197

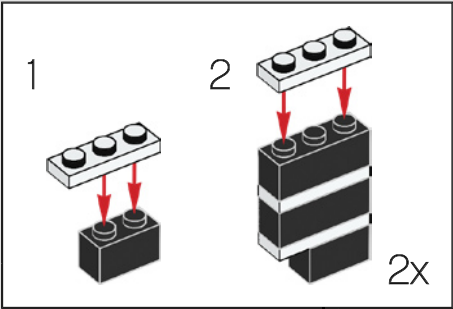

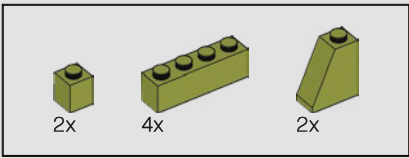

198

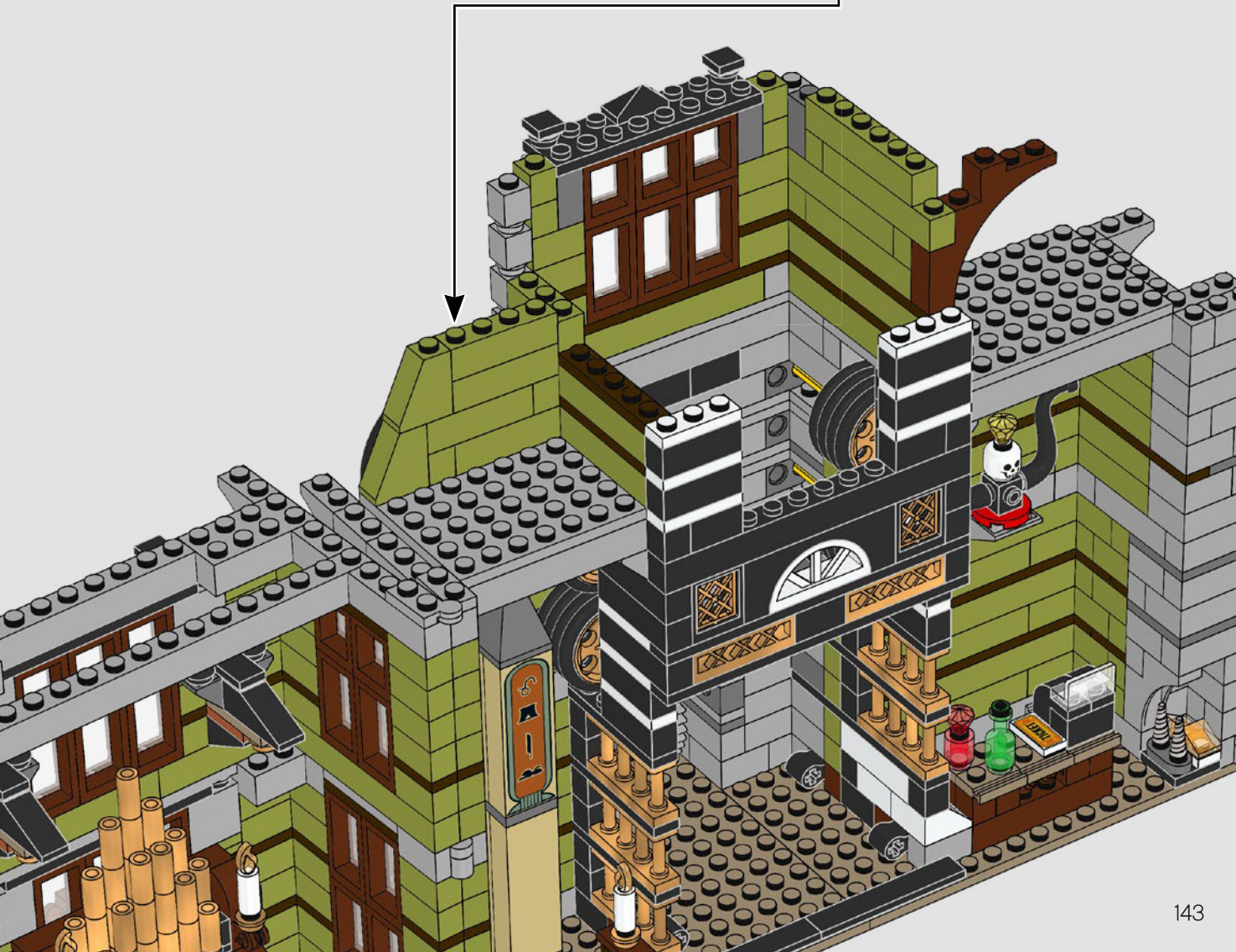
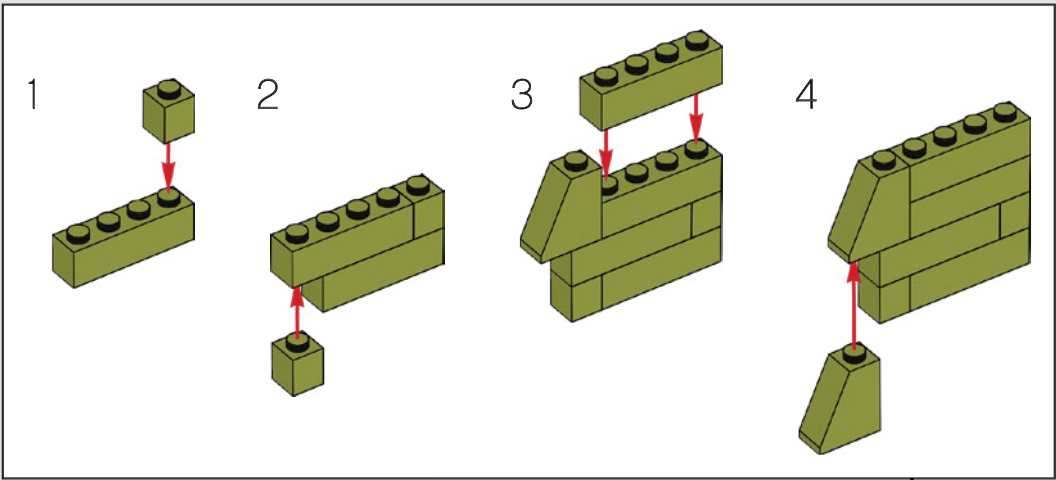

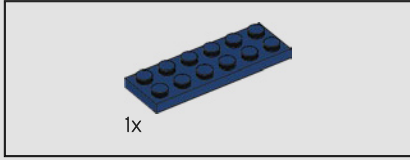
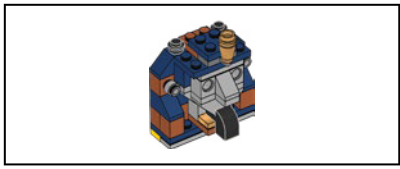

199

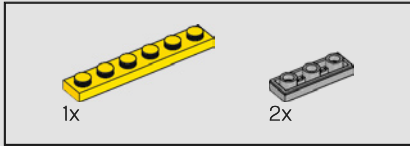
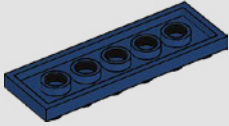

200

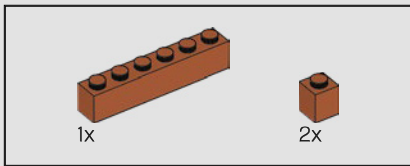
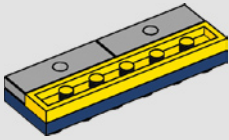

201

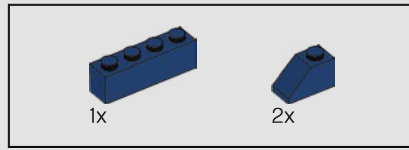
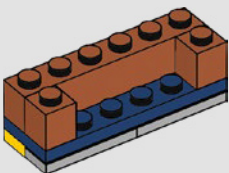

202

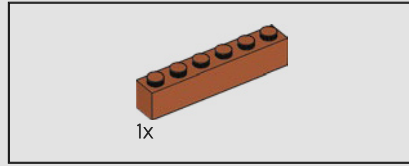
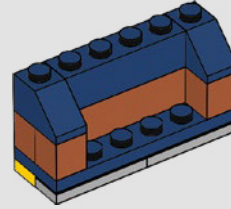

203

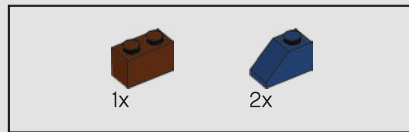
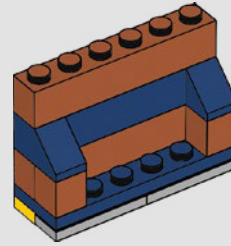

204

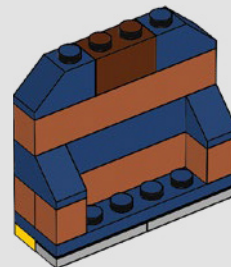

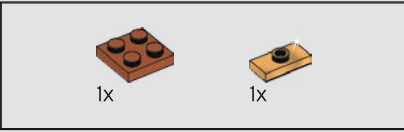
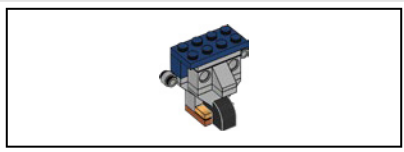

205

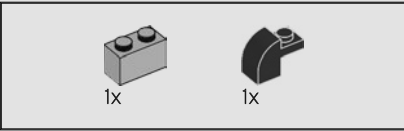
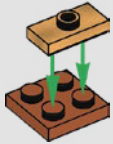

206

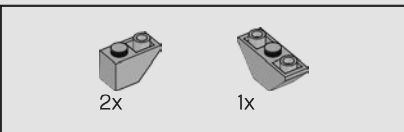

207

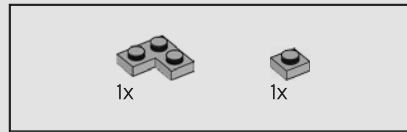
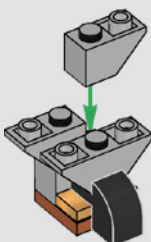

208

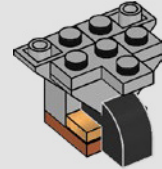

209

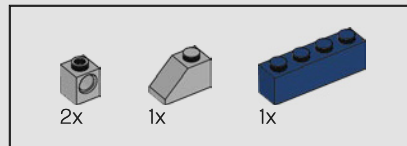
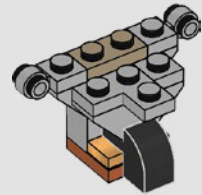

210

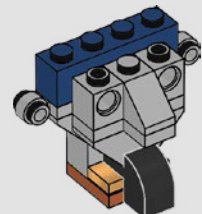

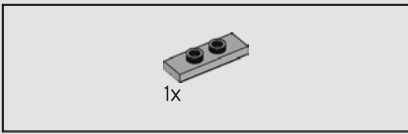

211

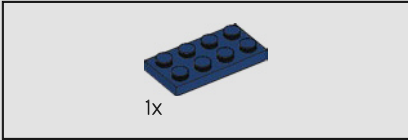
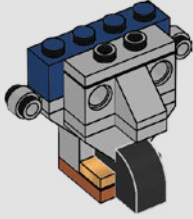

212

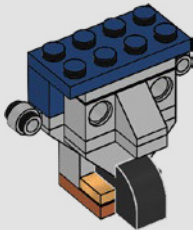

213

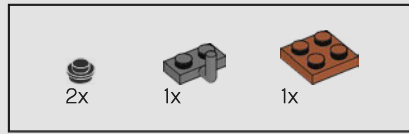
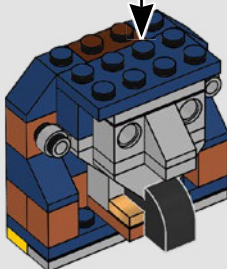

214

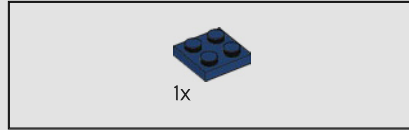
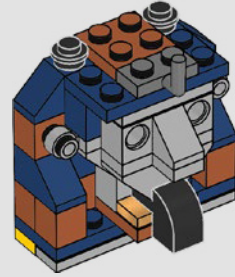

215

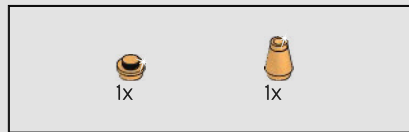
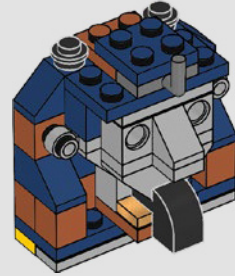

216

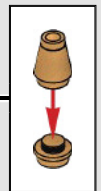
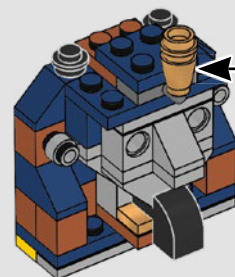

El Rostro de la Esfinge

El primer objeto egipcio que robó el barón.
 Toda la mansión está construida a su alrededor.

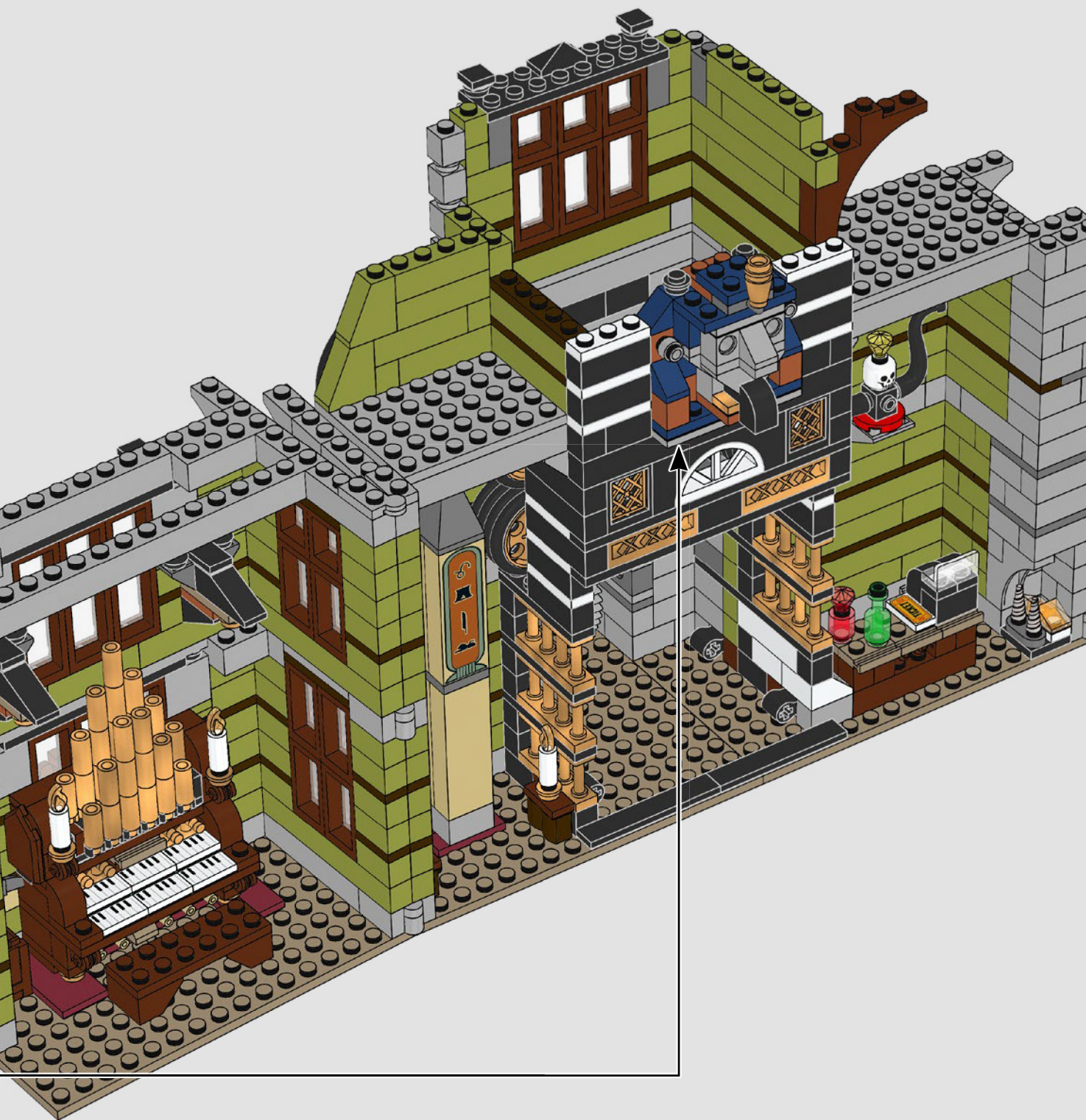

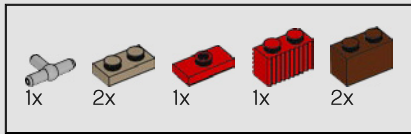

El Plan de Fuga
Von Barron forró el Rostro de la Esfinge con dinamita por si venía con alguna maldición incluida.

218

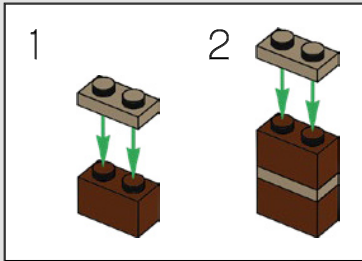
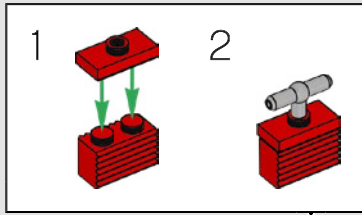

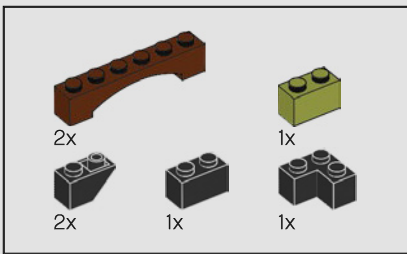

219

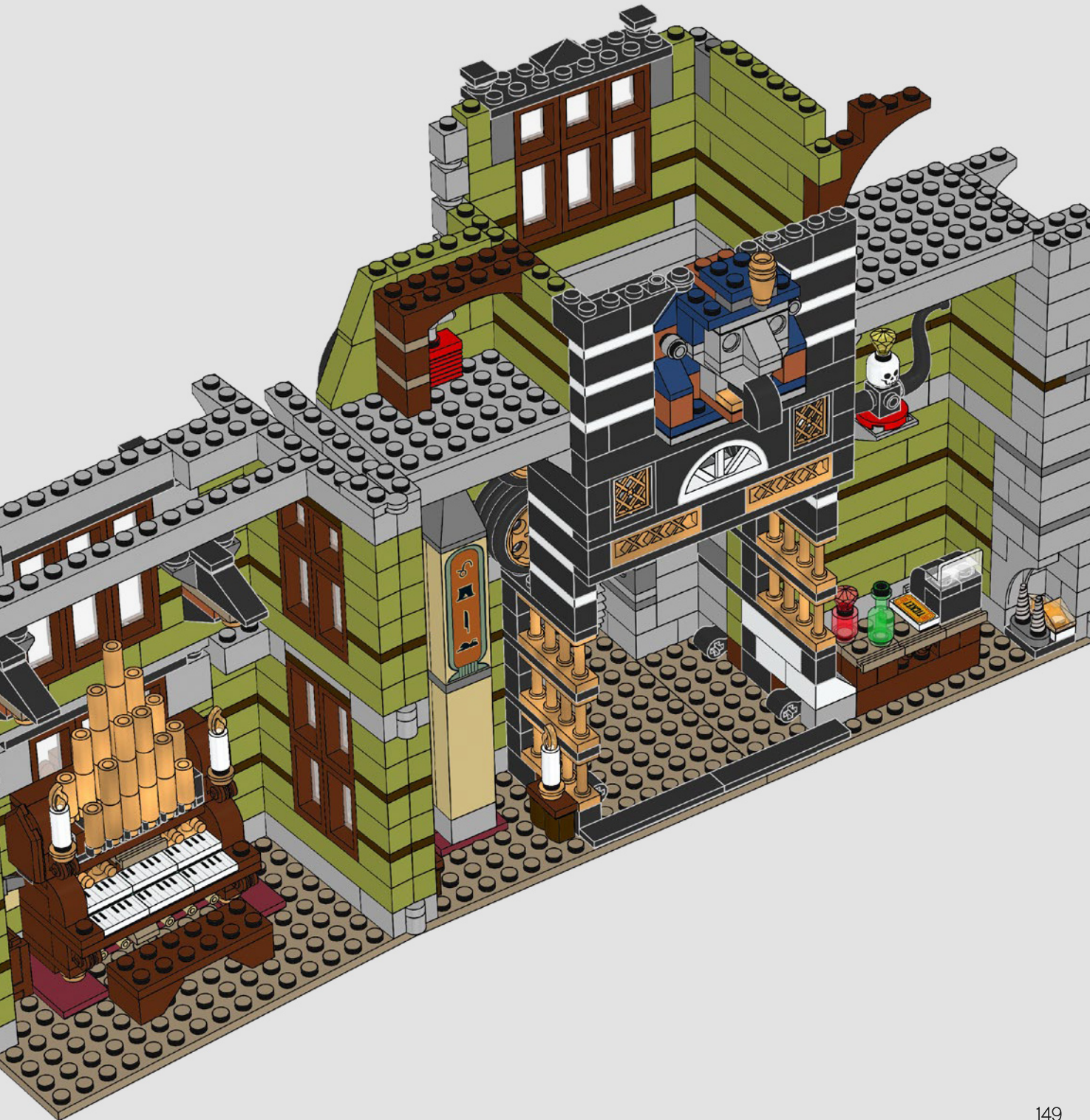

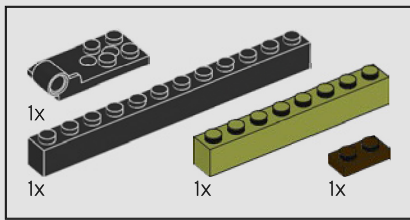

220



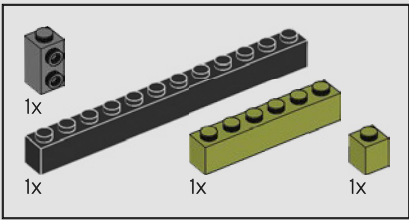

221



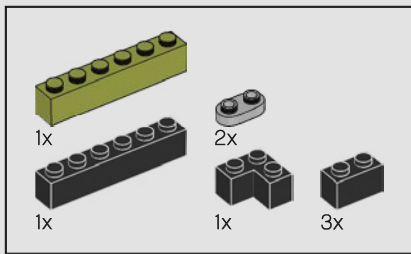

222



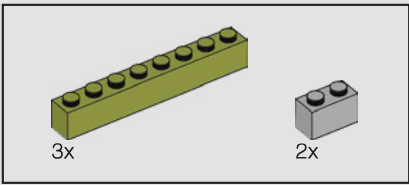

223

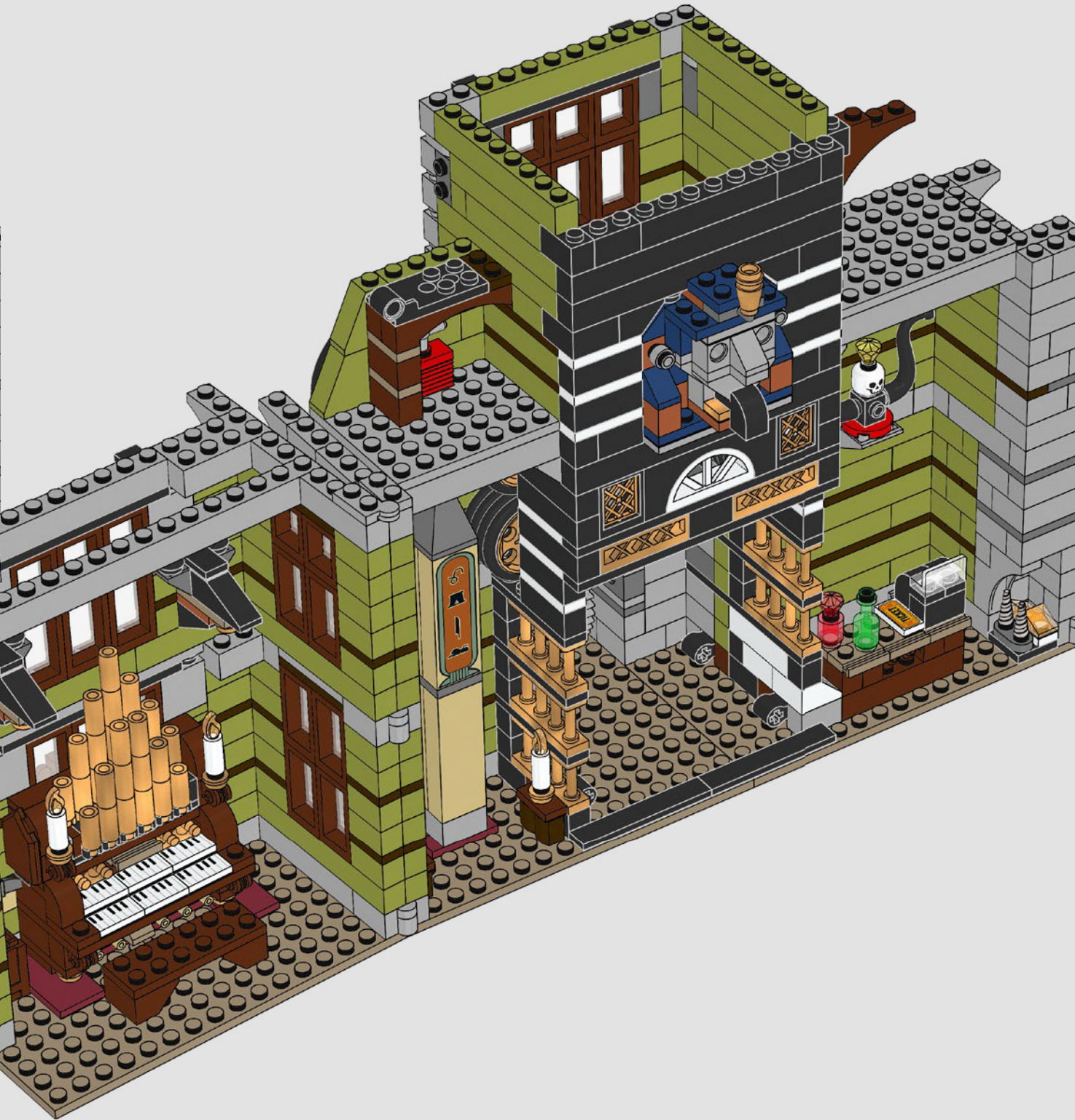

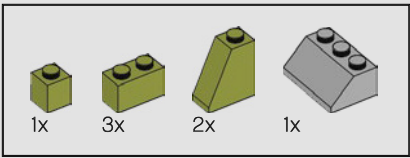

224

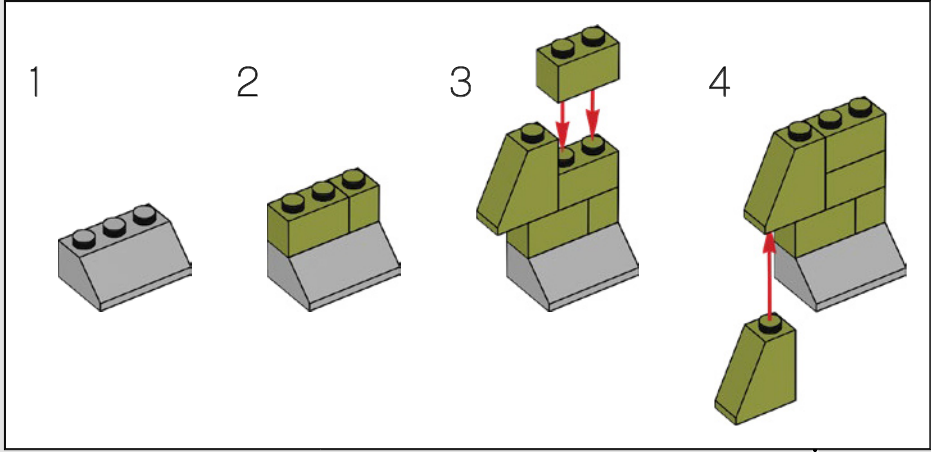

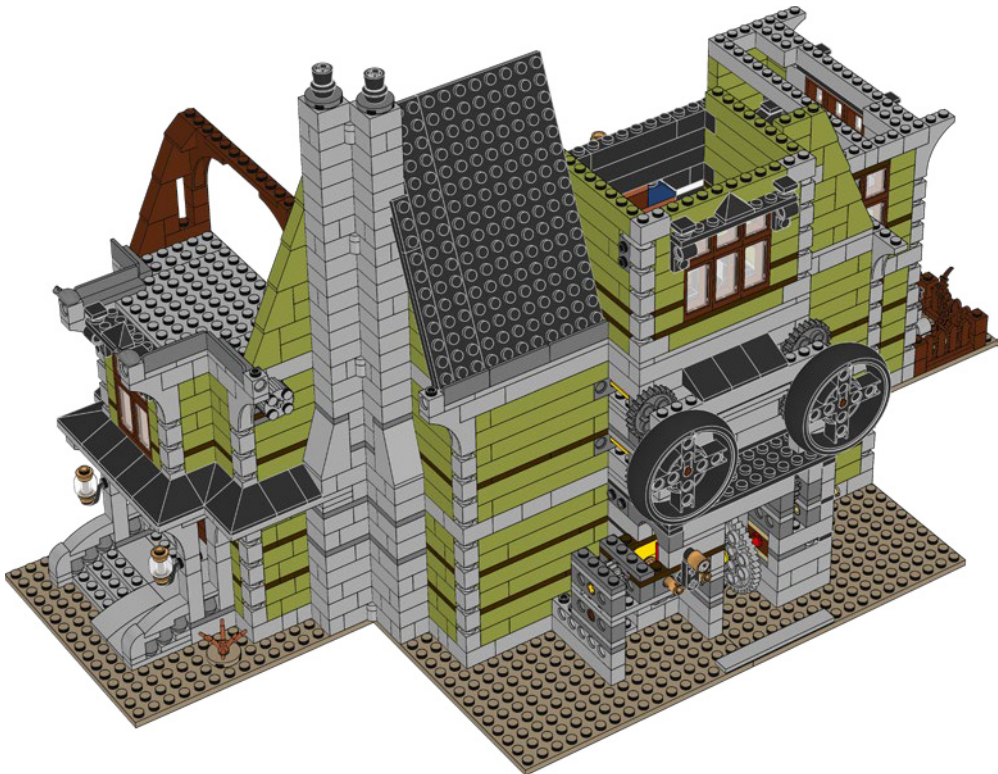
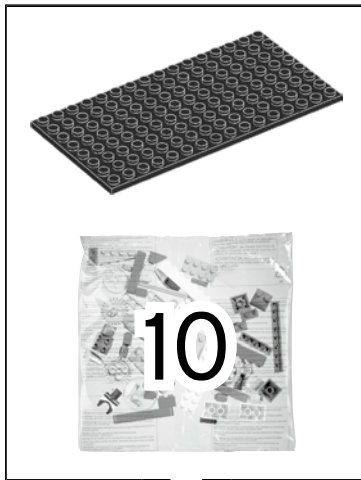

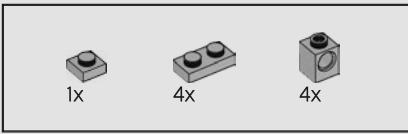

225



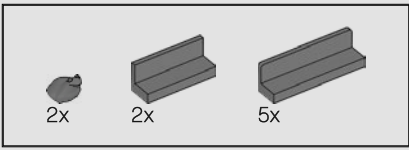

226

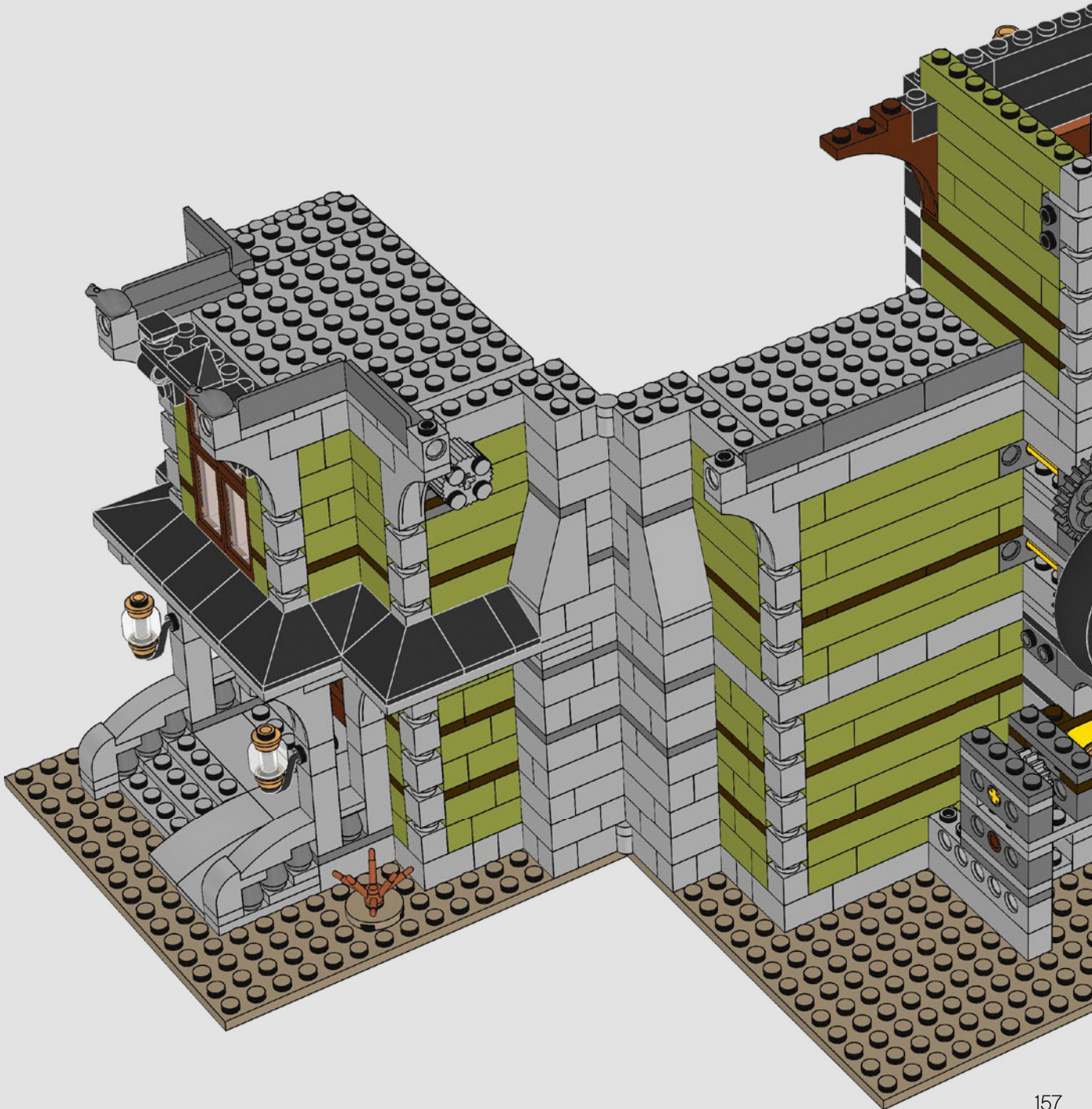

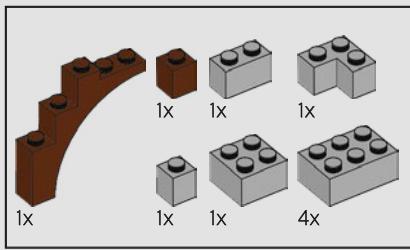

227

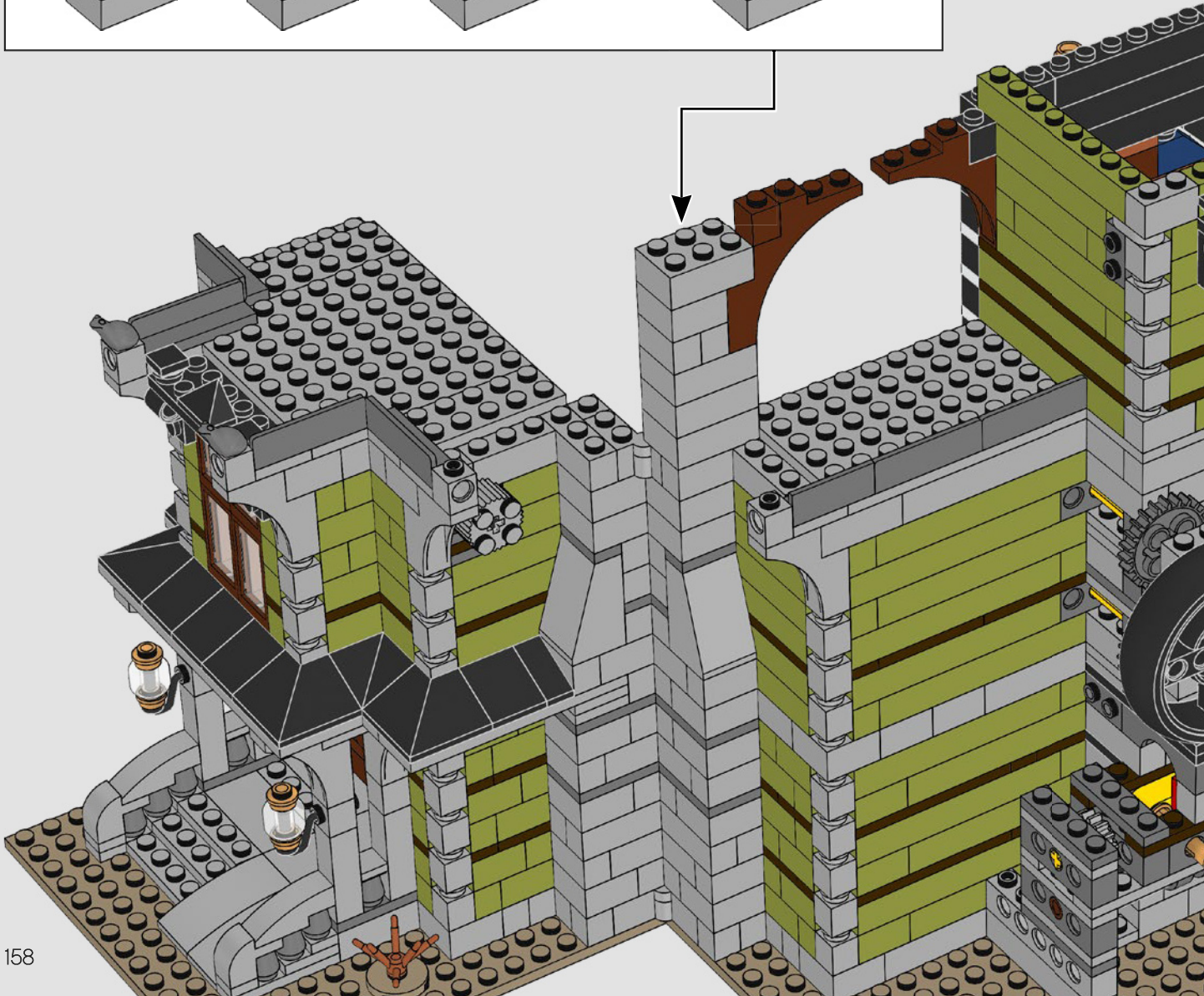
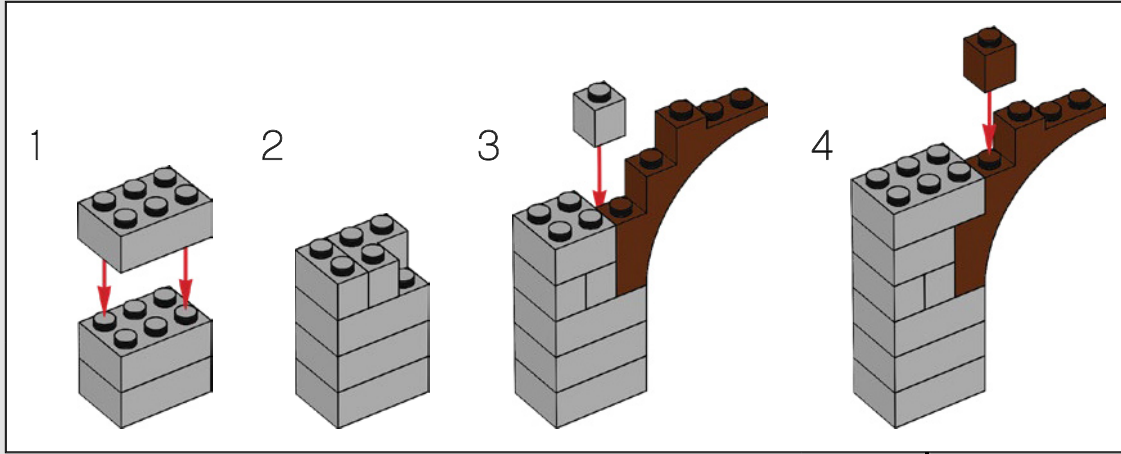

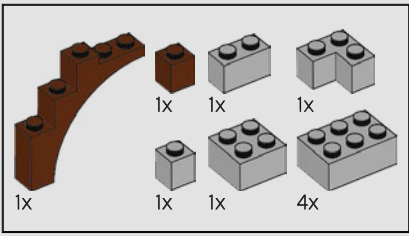

228

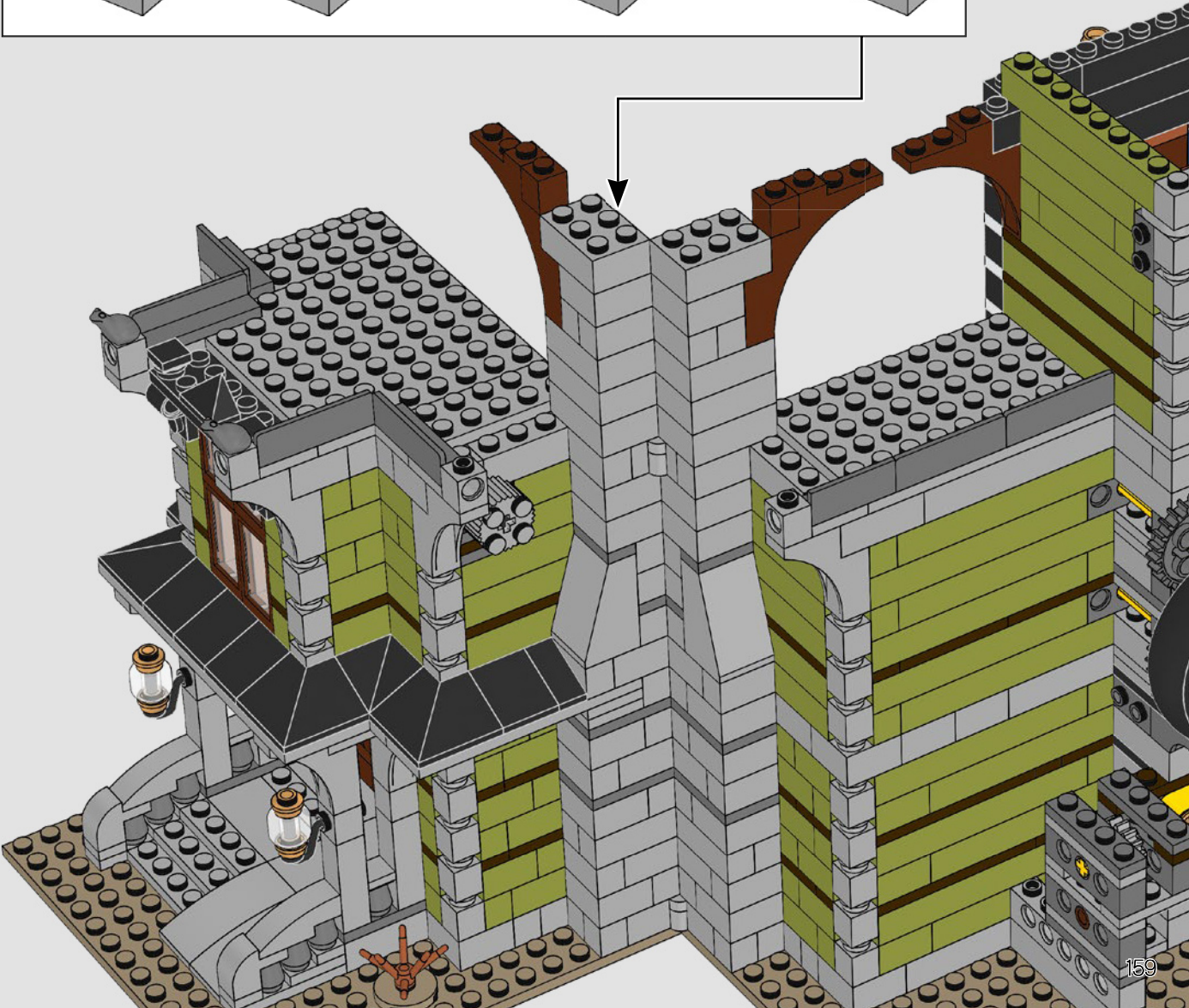
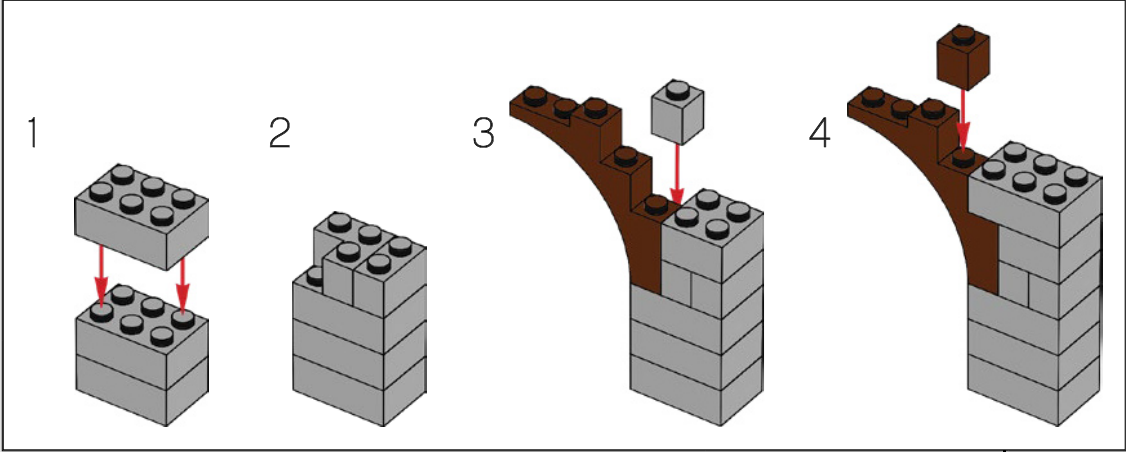

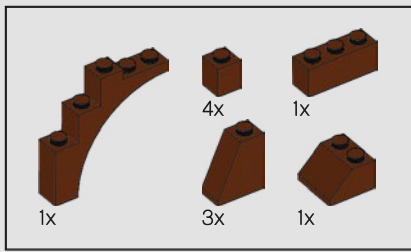

229

1

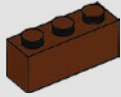

2

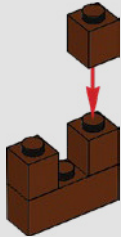

3

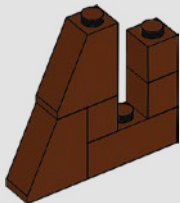

4

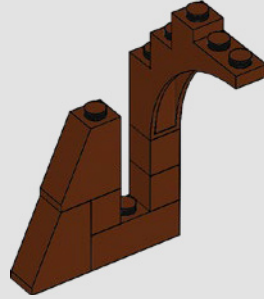

5

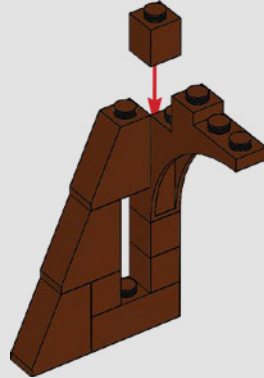

6

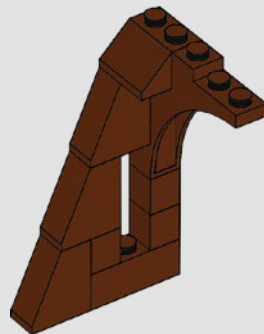

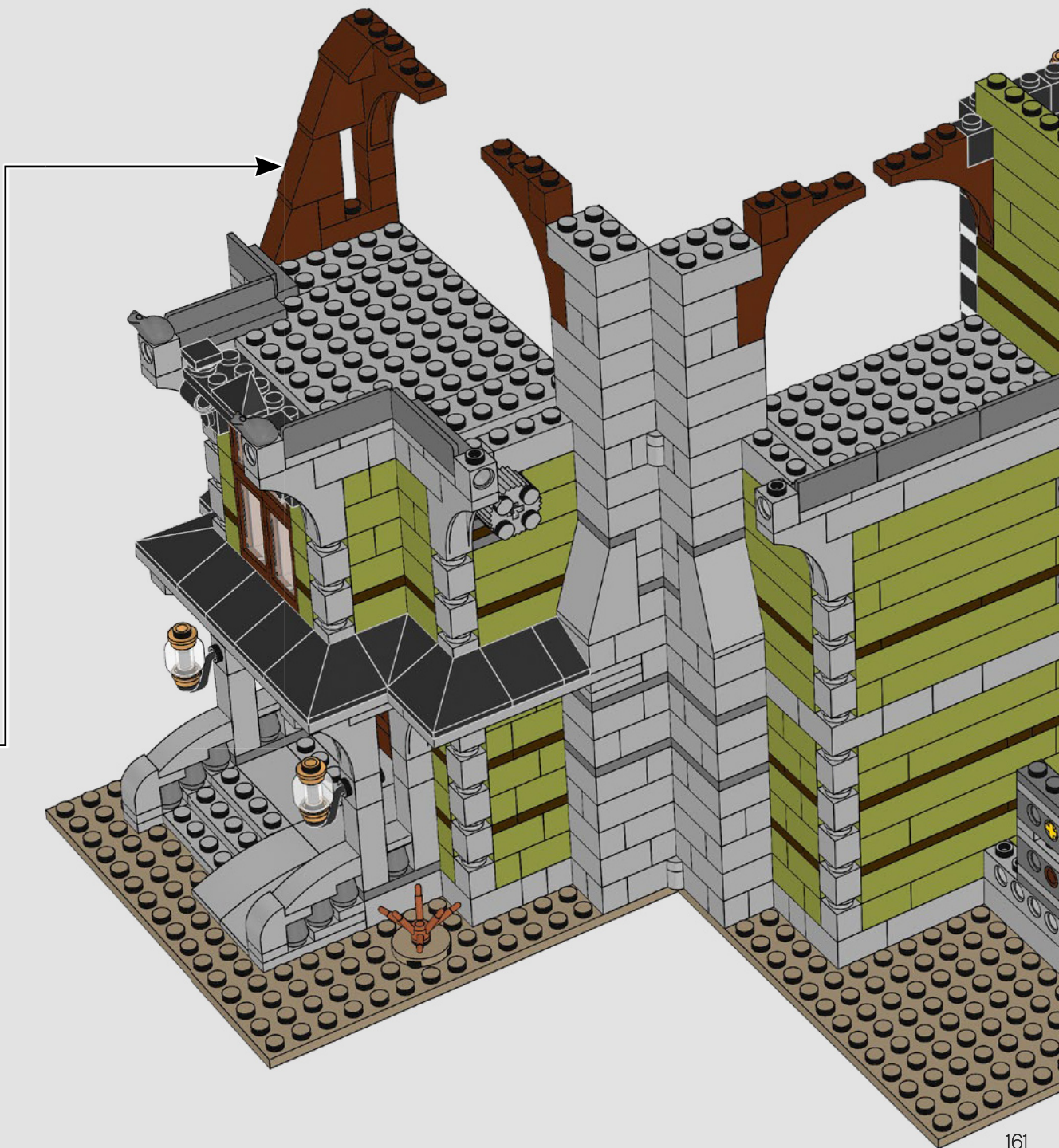

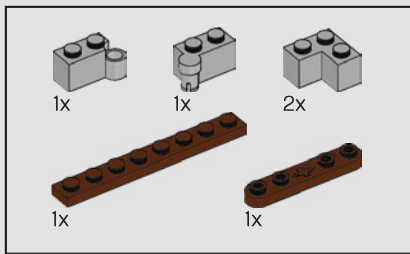

230

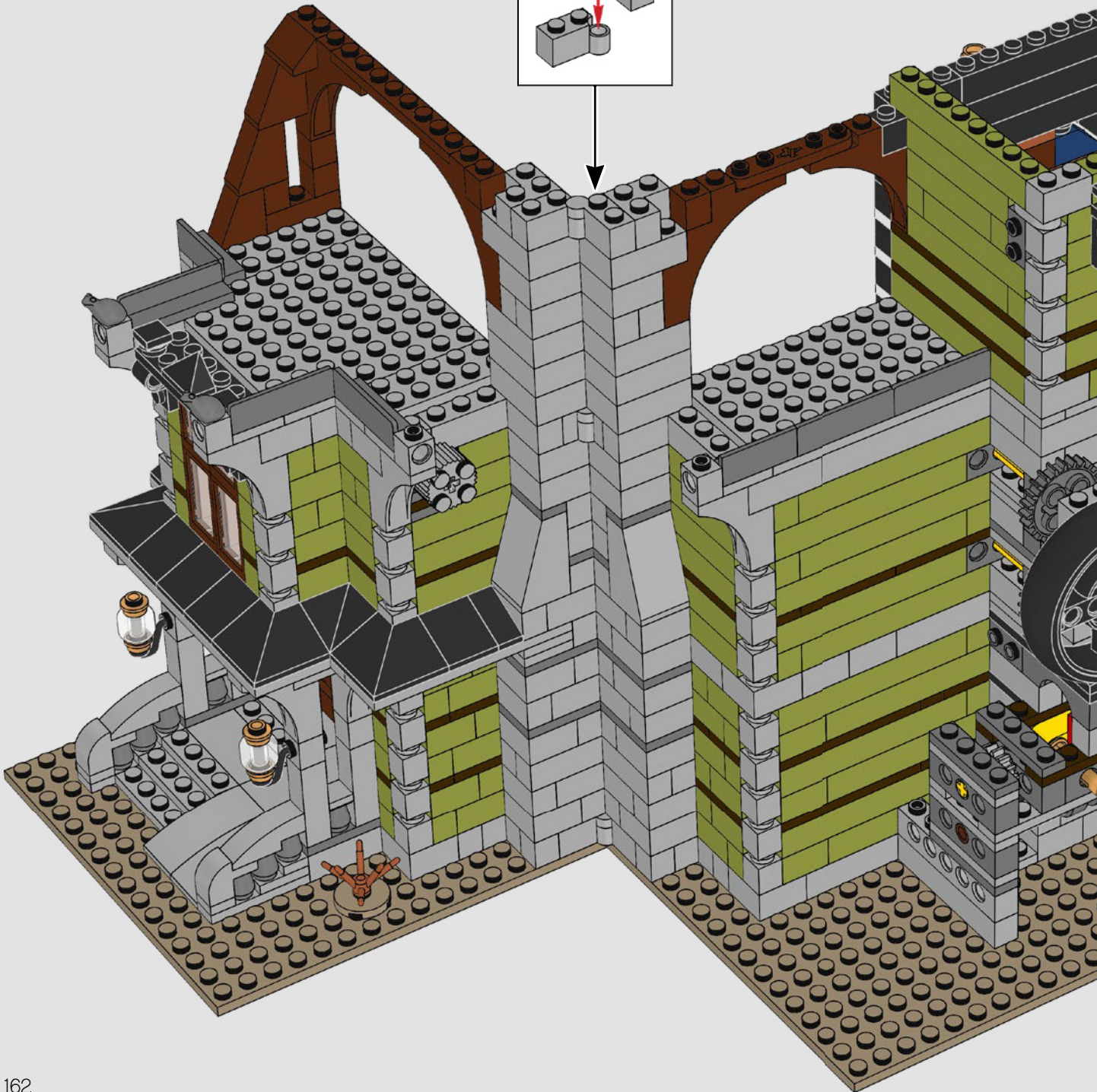
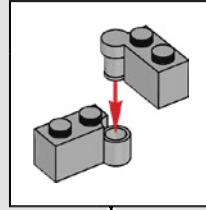

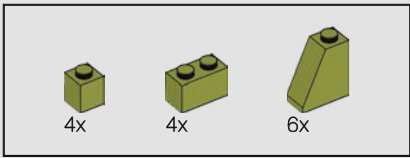

231

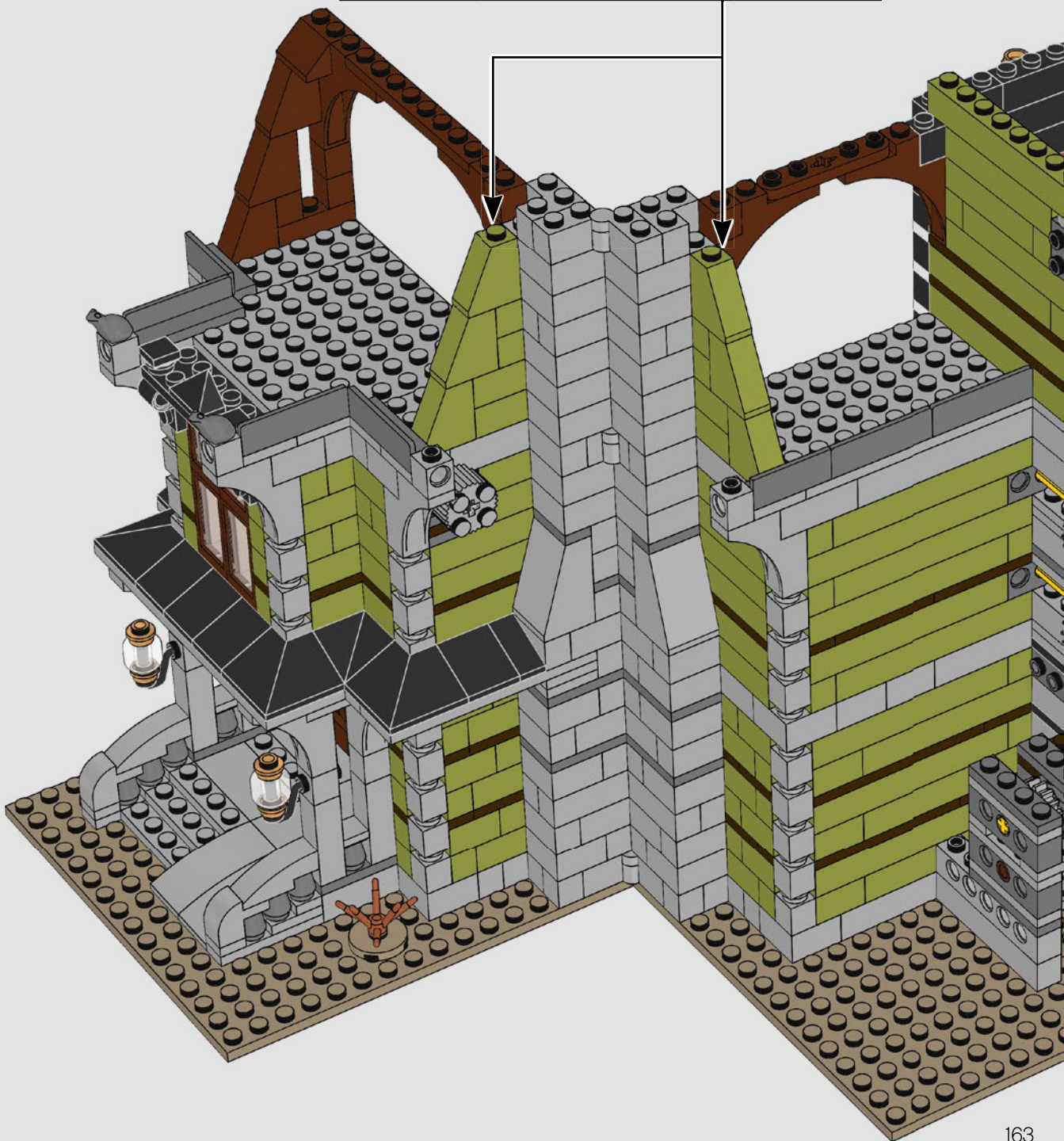
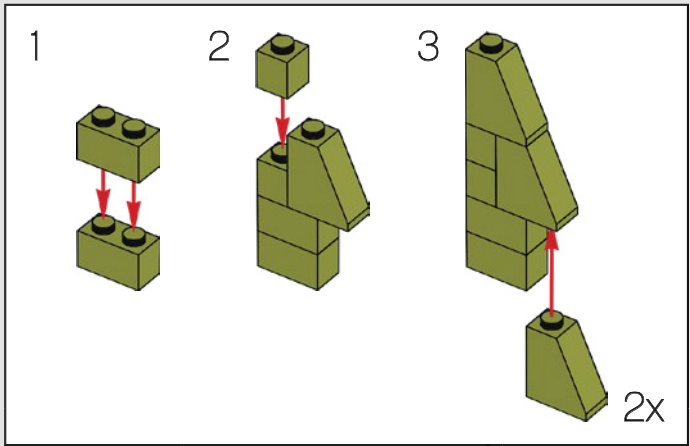

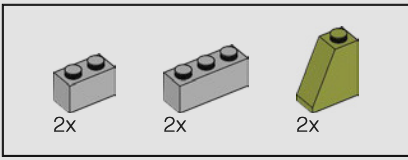

232



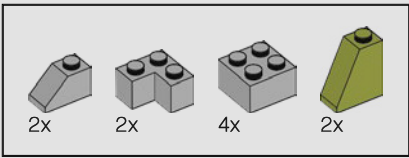

233

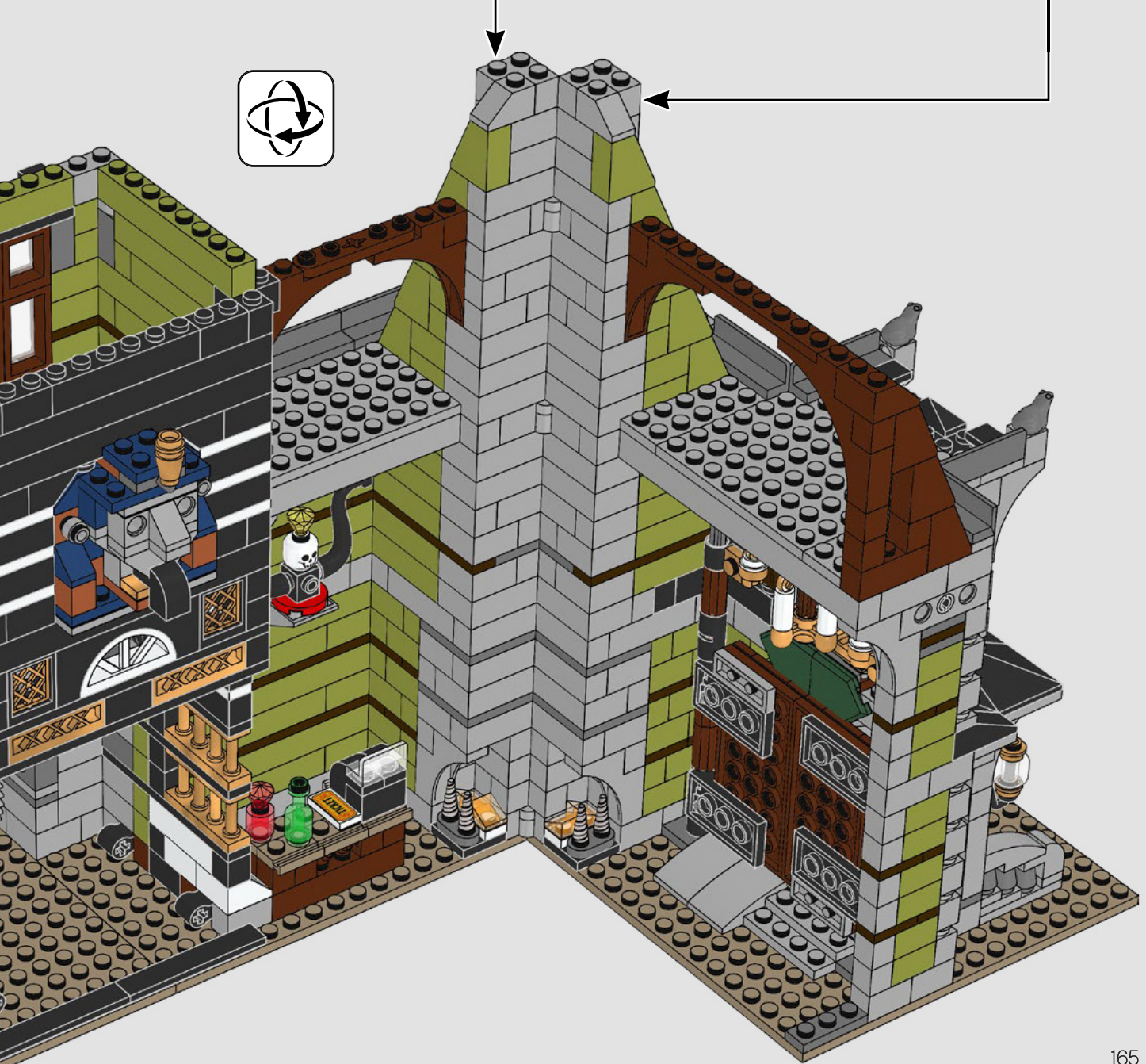
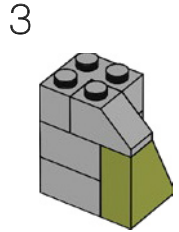
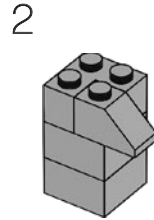
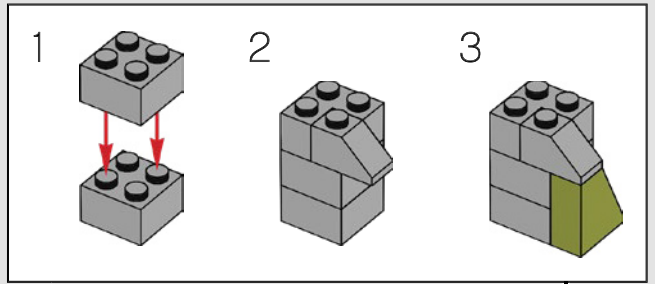
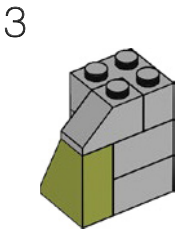
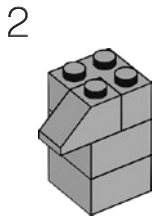
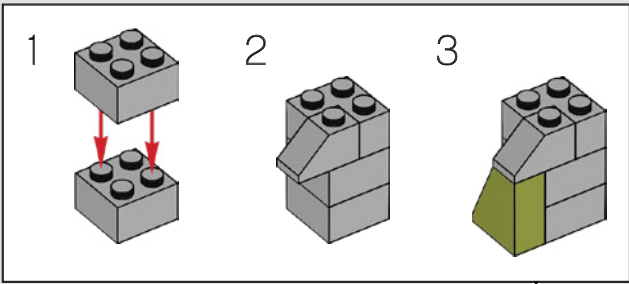

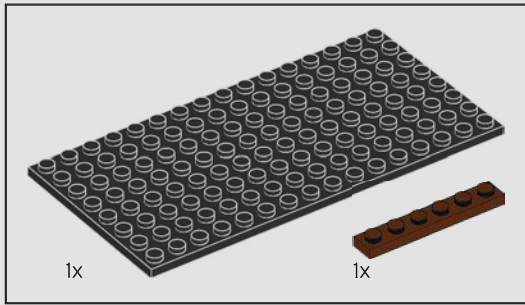
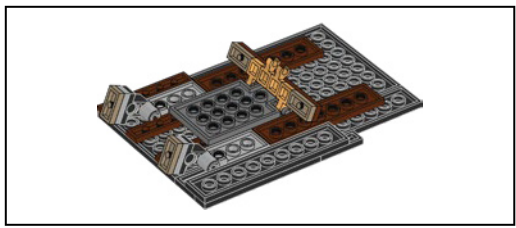

234

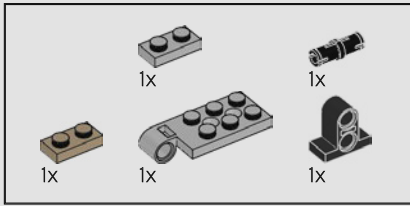
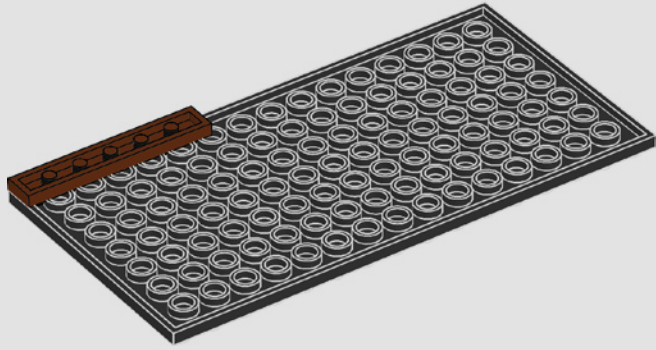

235

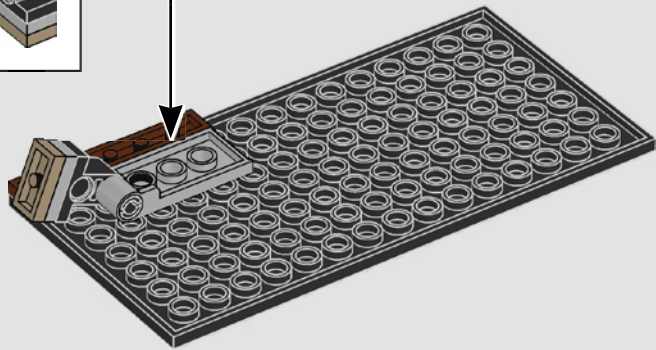
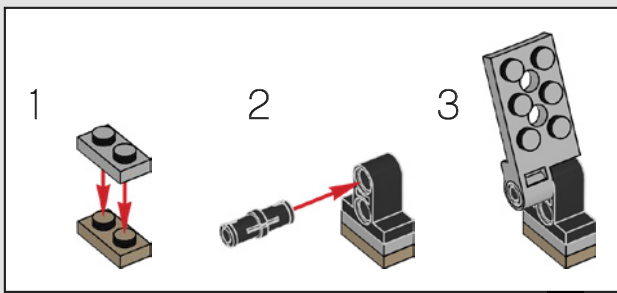

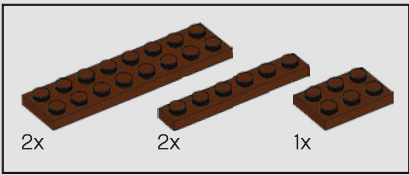

236

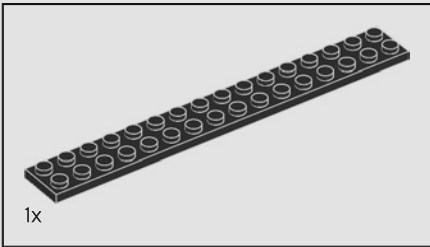
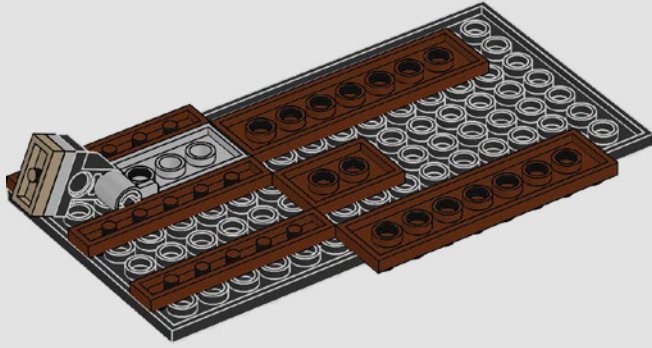

237

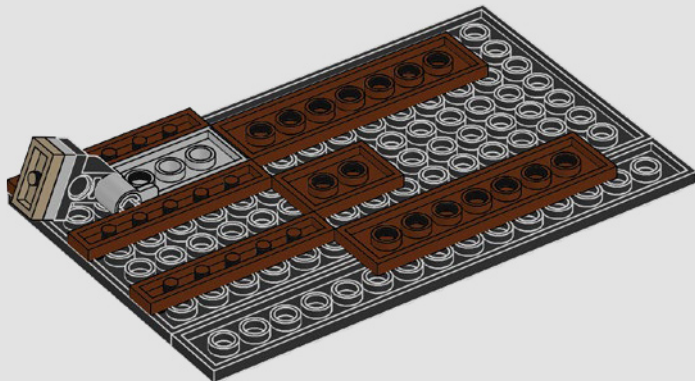

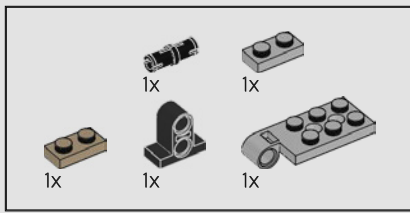

238

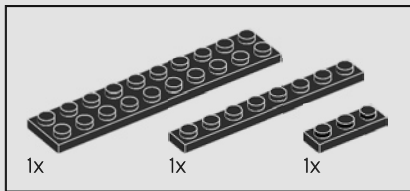
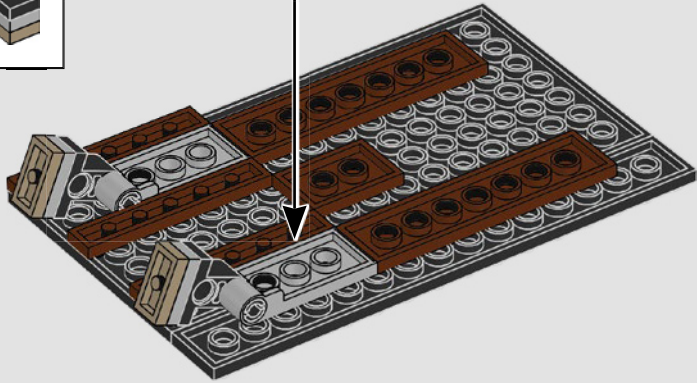
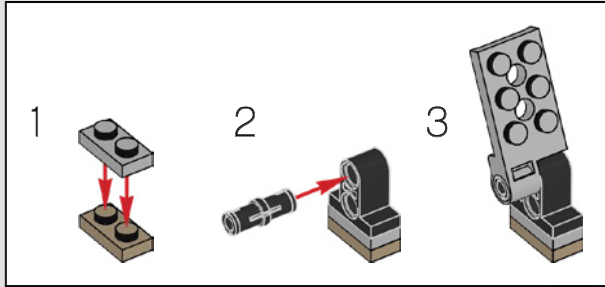

239

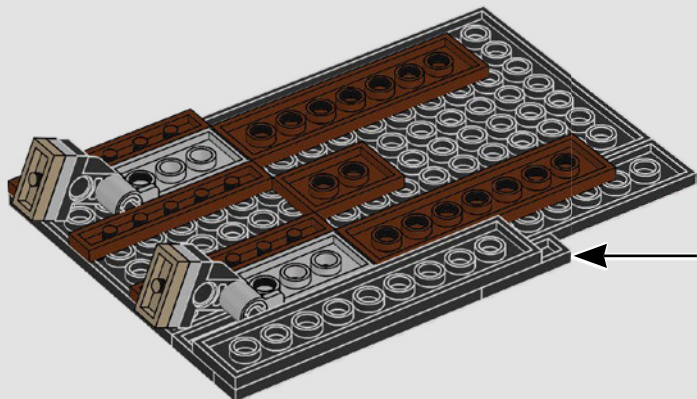
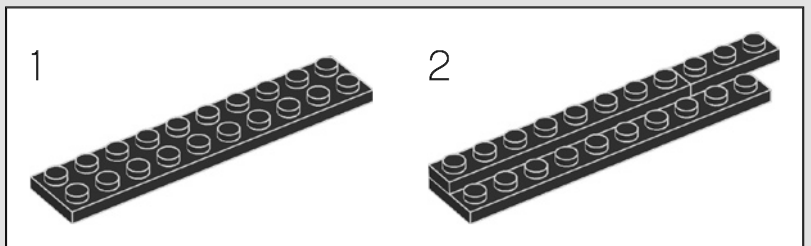

242

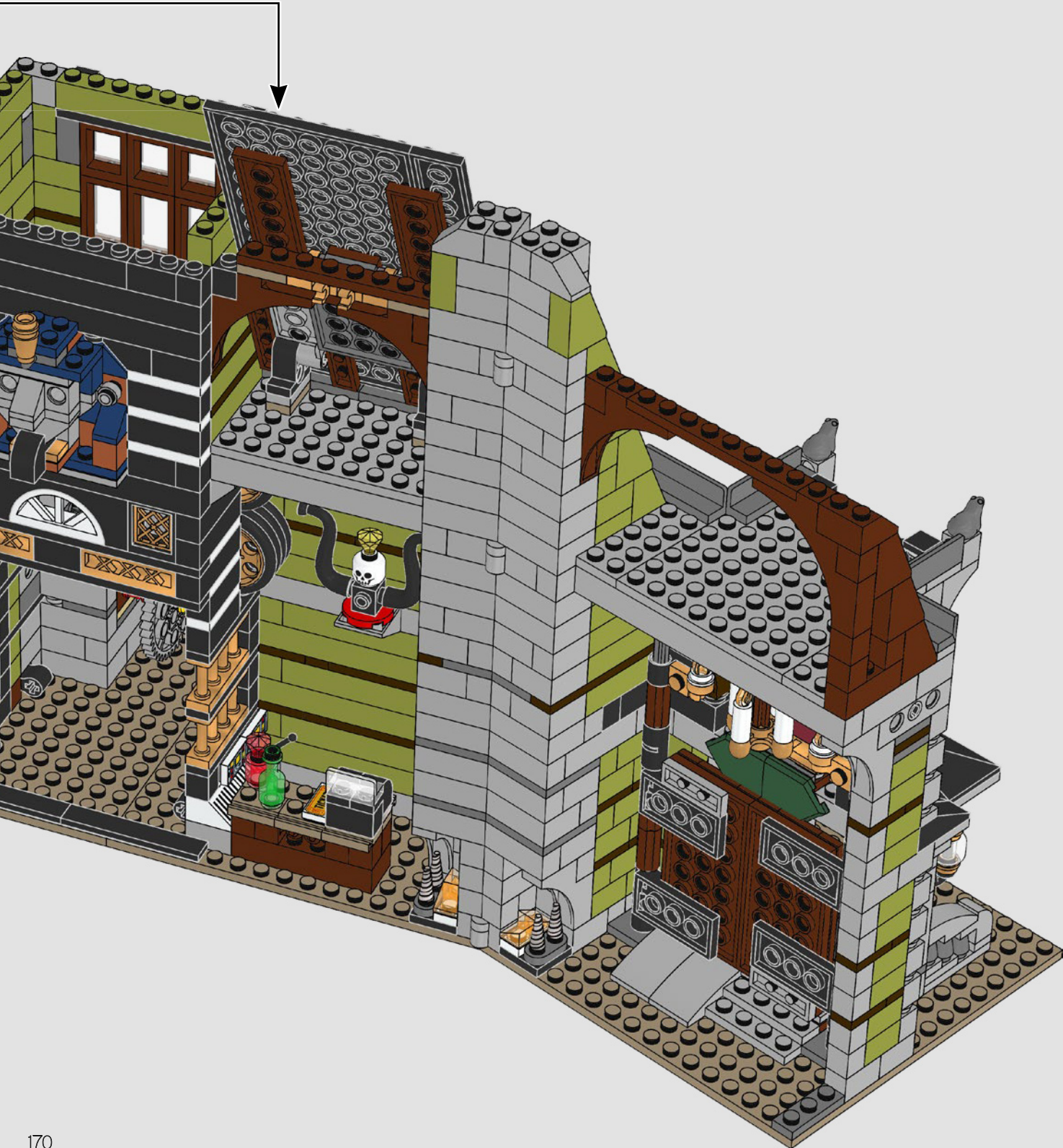

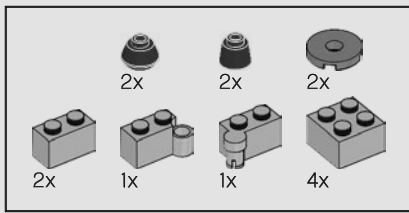

243

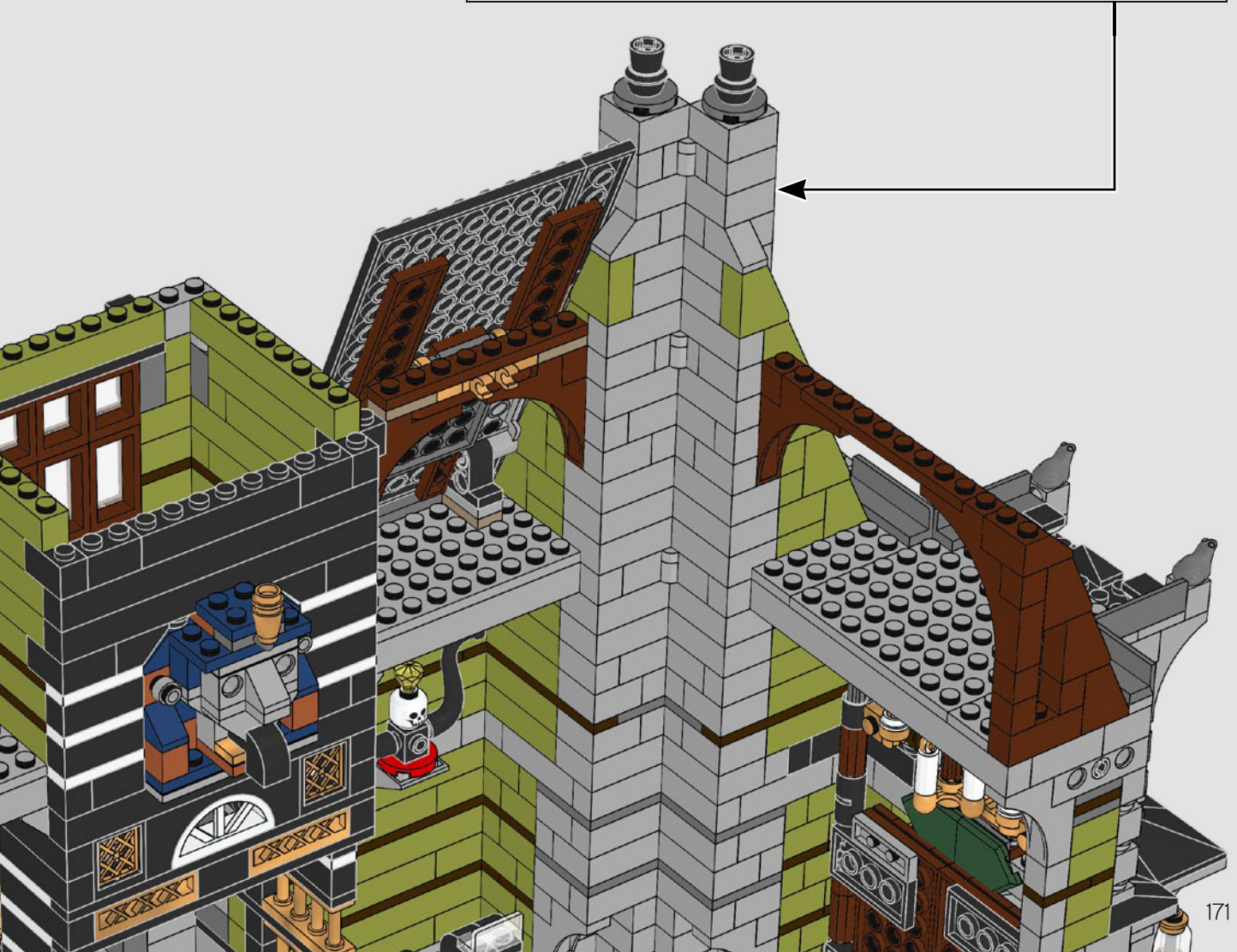
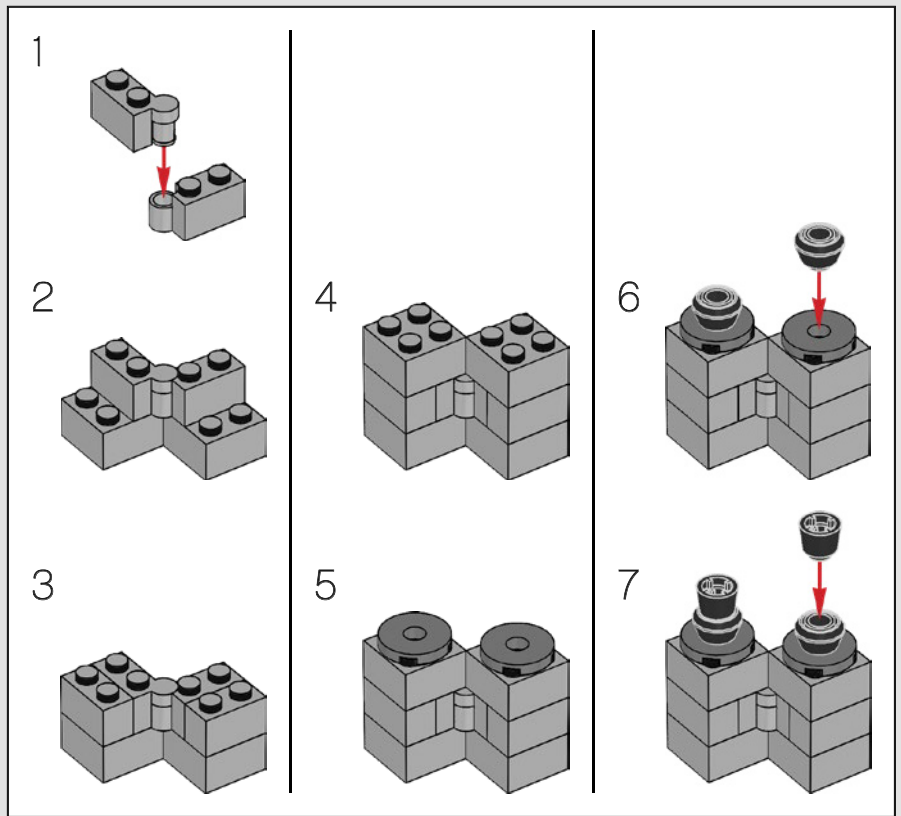

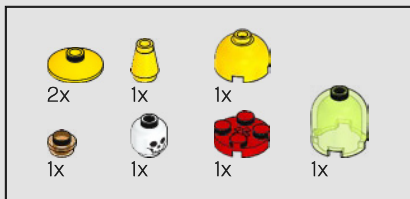

El Orbe de OGEL
 Un prototipo de la superarma de control mental que usó el malvado Imperio OGEL.
 Von Barron lo tenía siempre a mano para los días lluviosos.

La Cosa Dorada
 Cuando Von Barron extendió el brazo para coger la Cosa Dorada, ¡un yeti salió de la nada y se comió su mano izquierda! Sin embargo, como ya tenía un garfio por mano izquierda, solo tuvo que cambiarlo por otro.

244

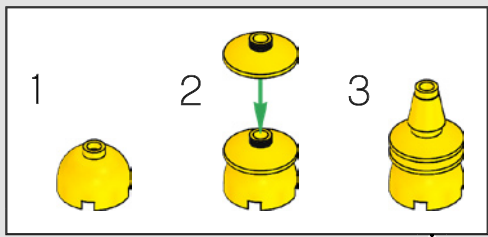
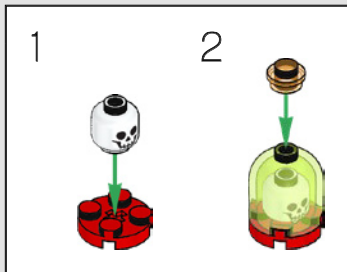

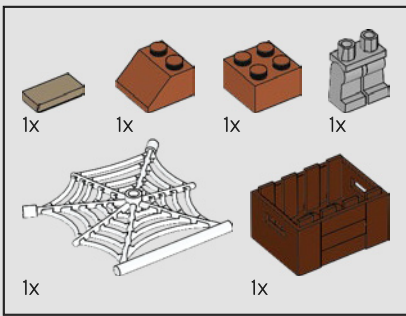

245

La Caja de Trastos

Una pesada y polvorienta caja de trastos.
 En una vieja pegatina puede leerse el
 mensaje: "I Love Trash" ("Adoro los trastos").

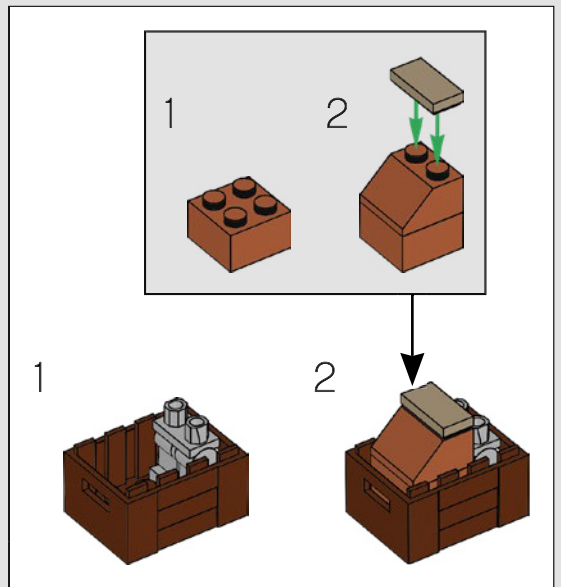

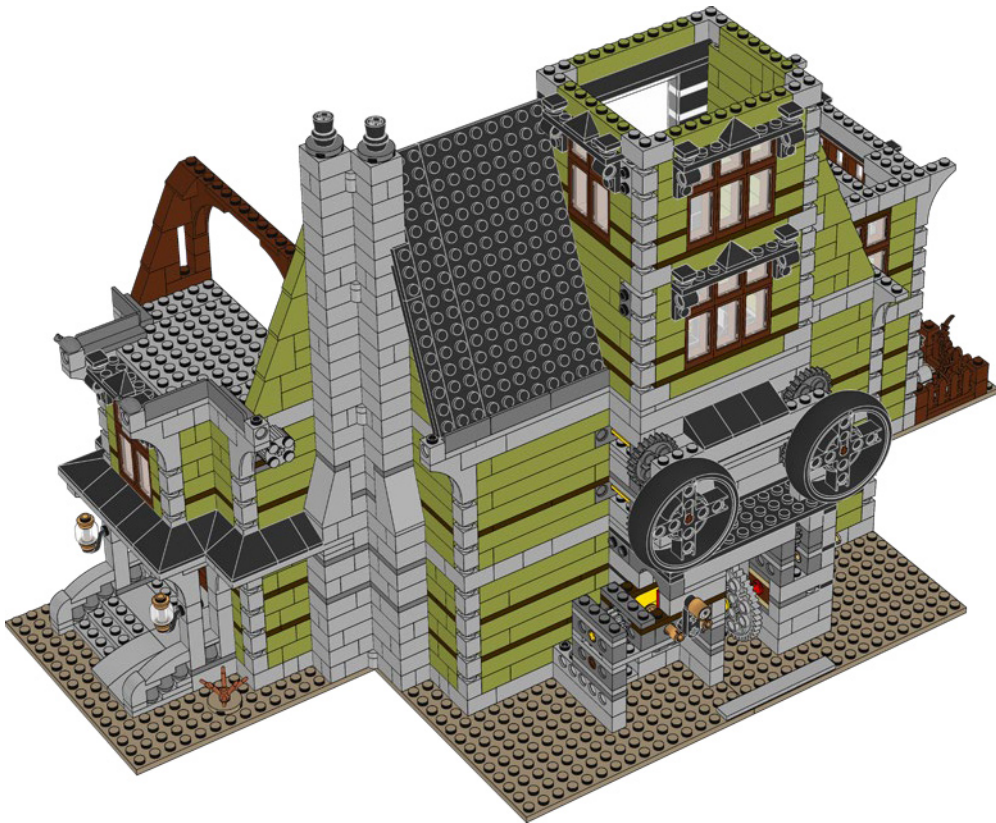
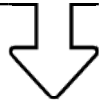

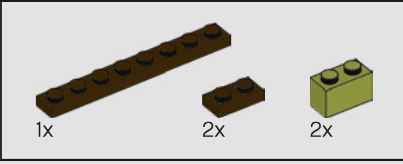
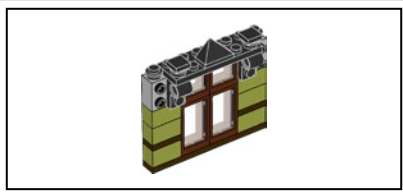

246

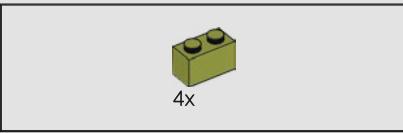
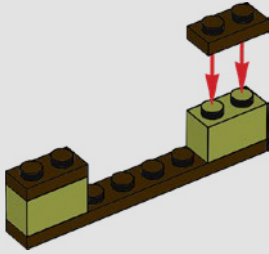

247

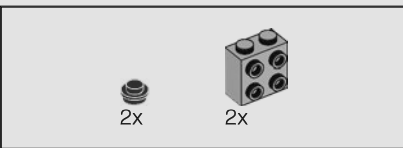
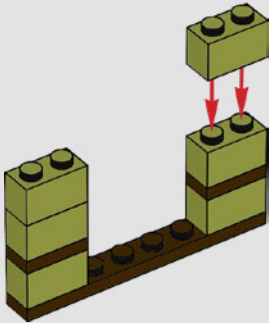

248

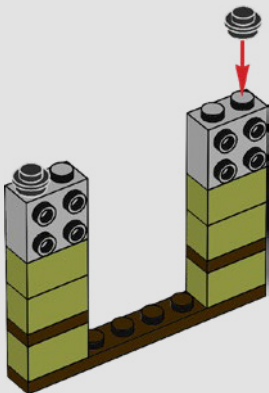

249

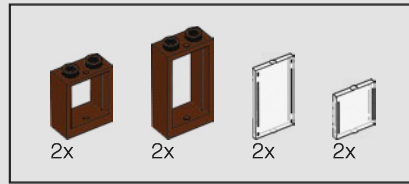
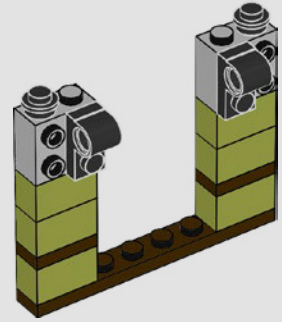

250

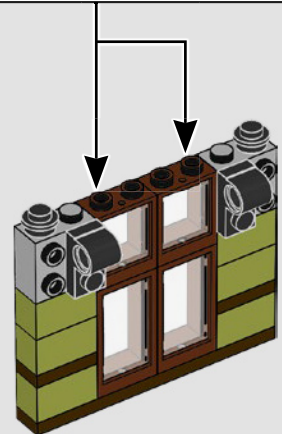
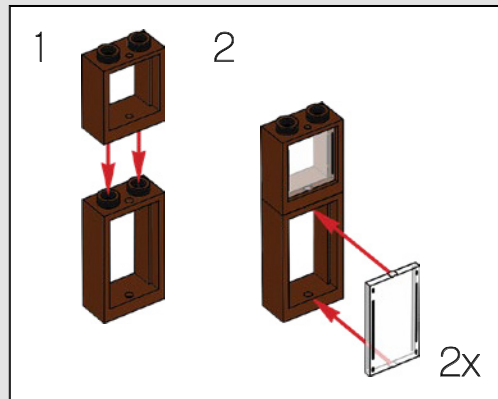

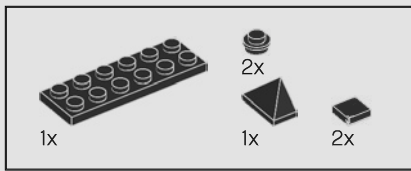

251

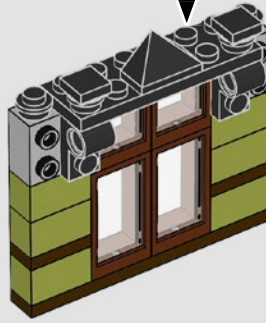
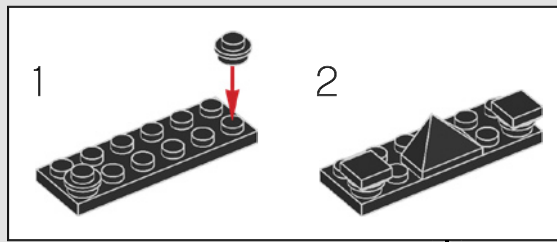

252



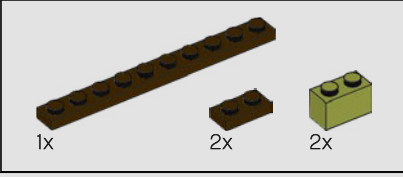
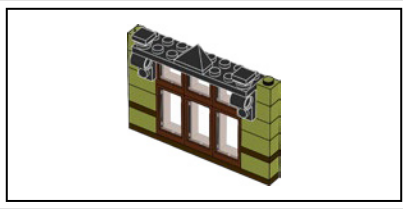

253

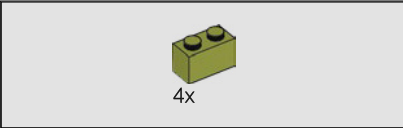
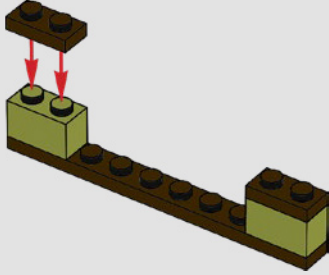

254

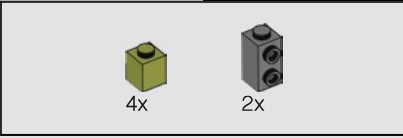
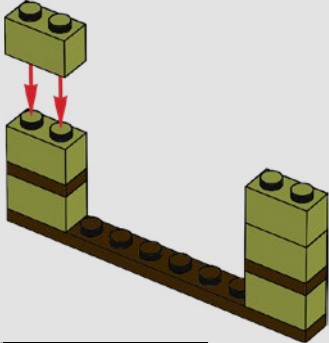

255

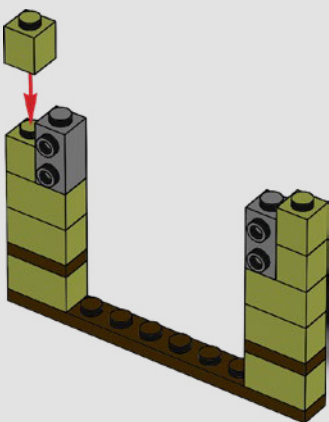

256

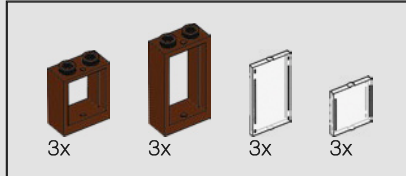
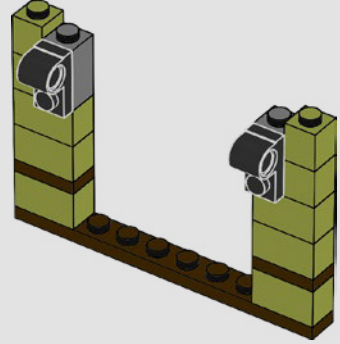

257

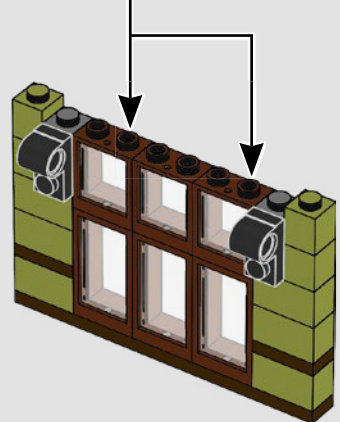
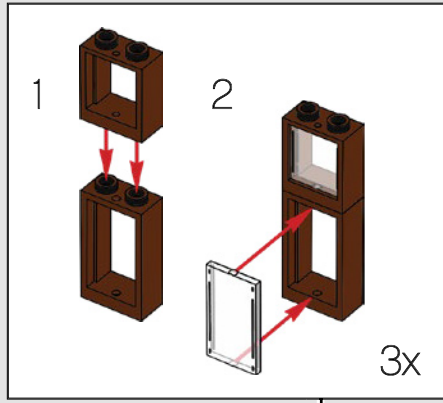

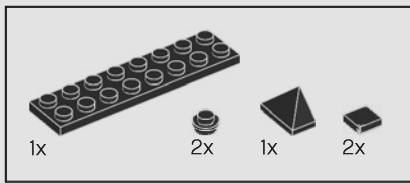

258

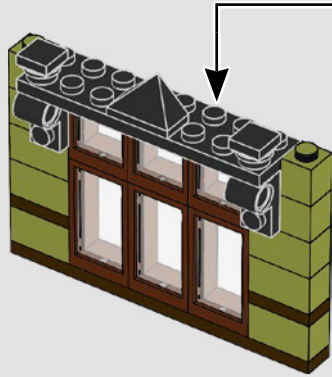
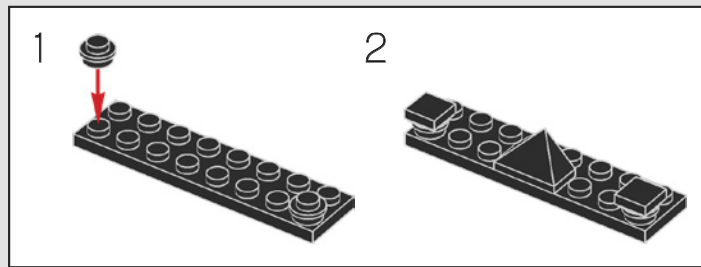

259





8x



10x

260

1



2



2x



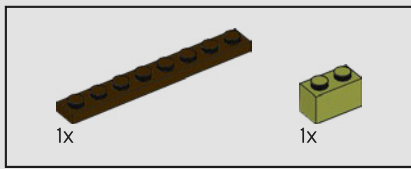

261

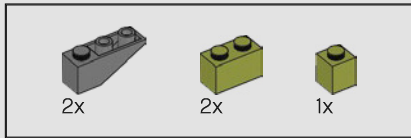
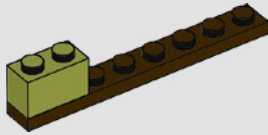

262

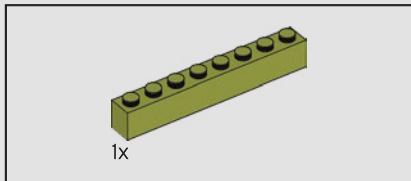
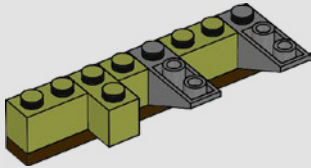

263

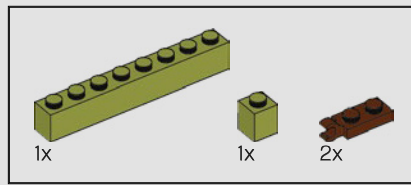
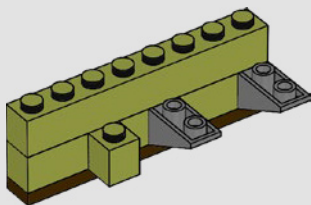

264

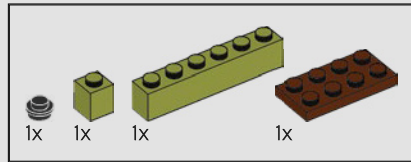
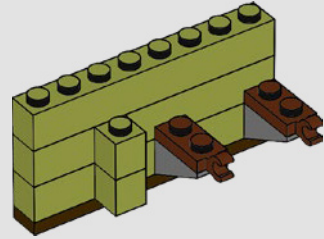

265

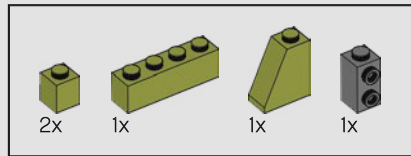
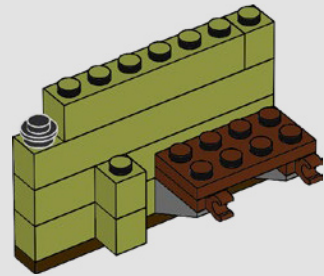

266

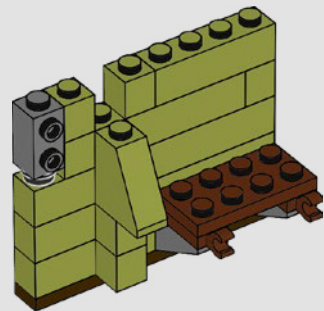

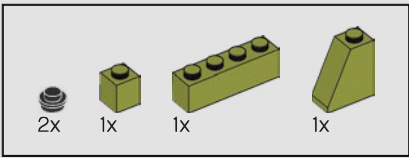

267

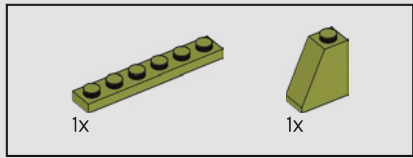
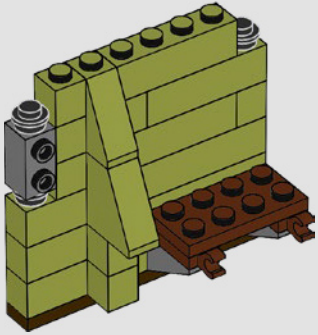

268

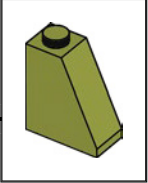
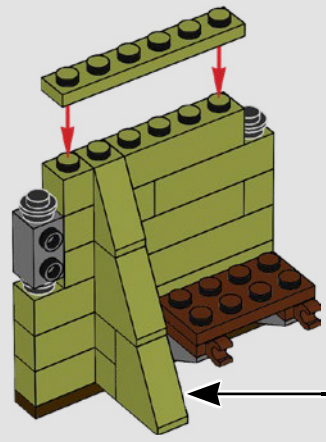

269



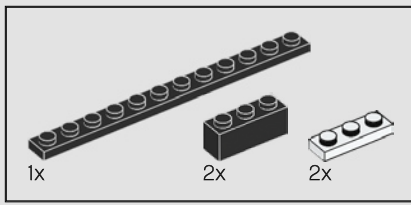

270

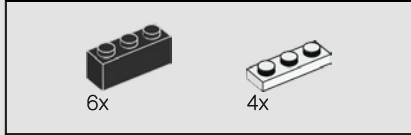
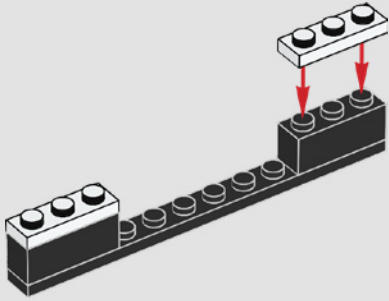

271

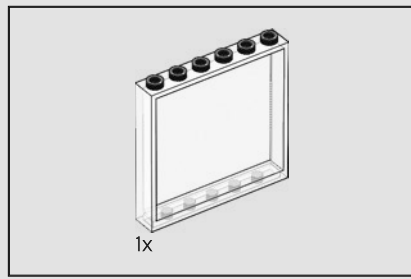
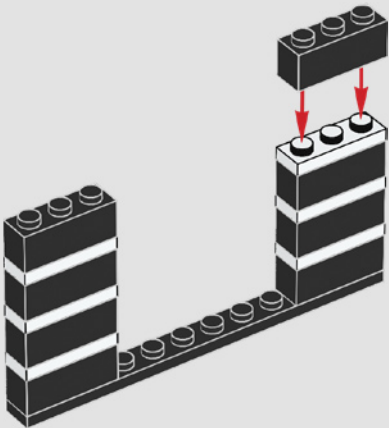

272

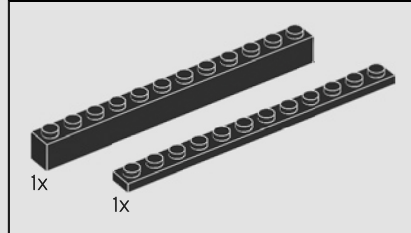
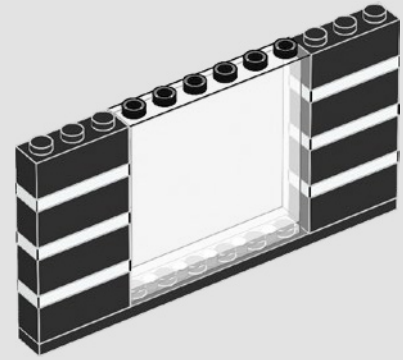

273

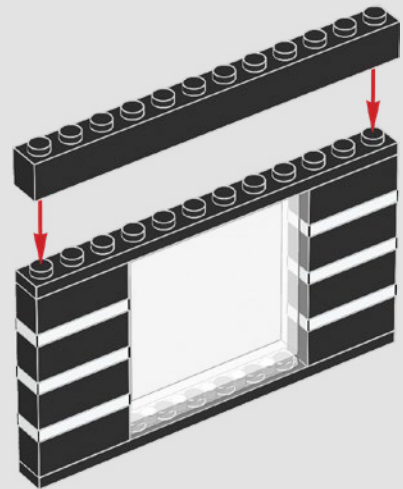

274



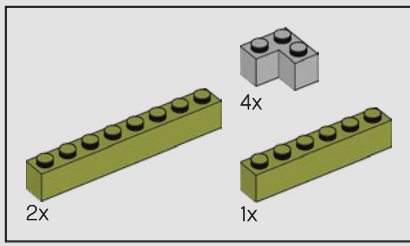

275

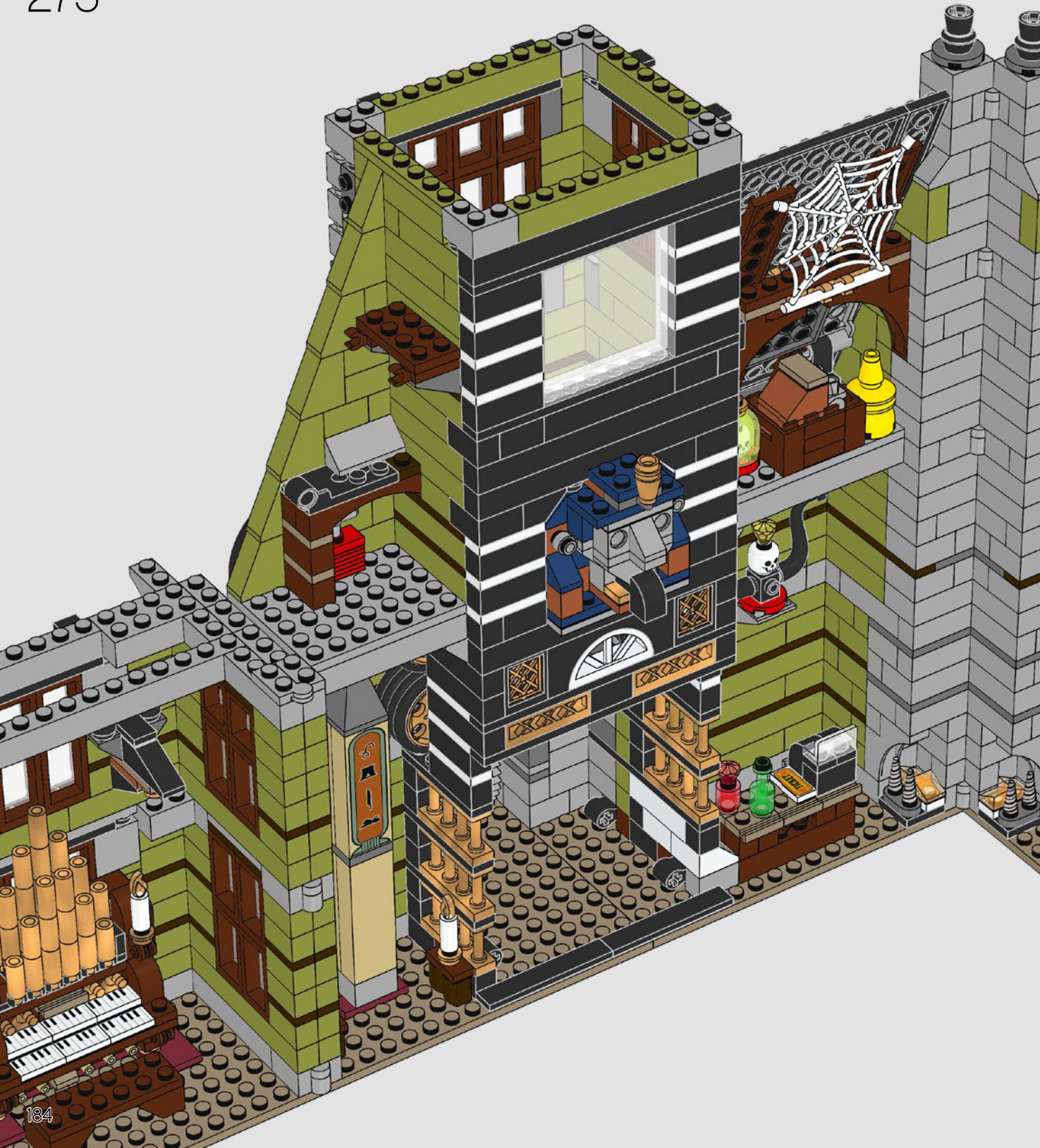

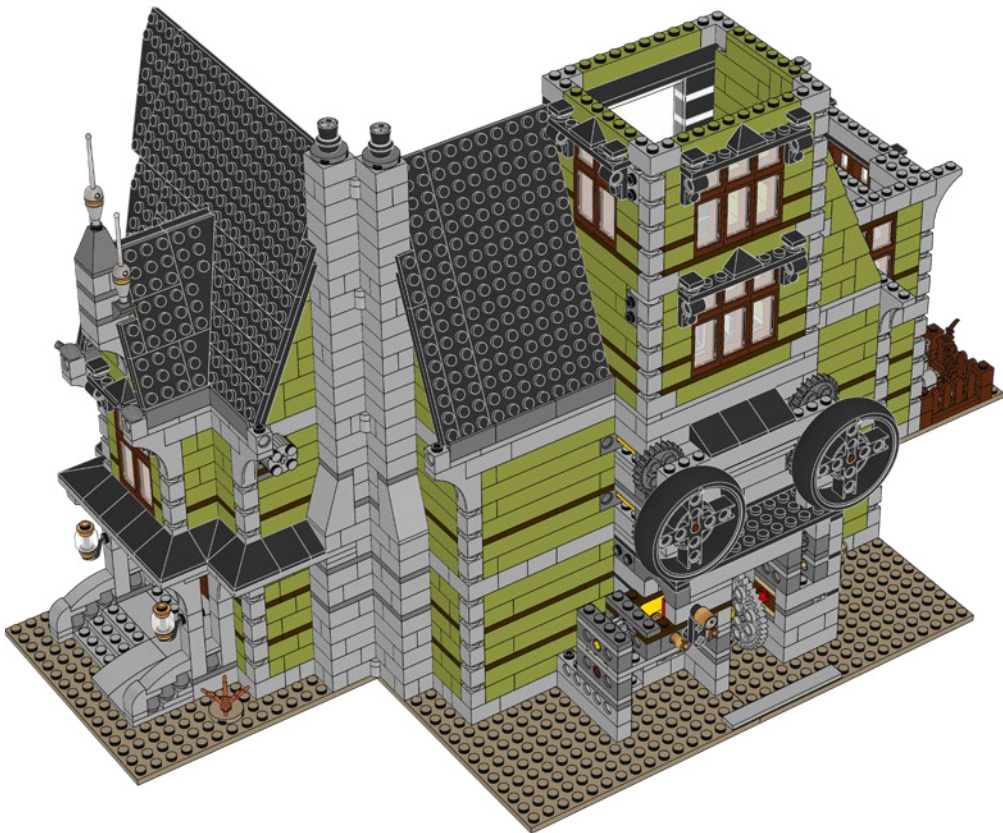
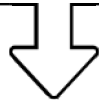
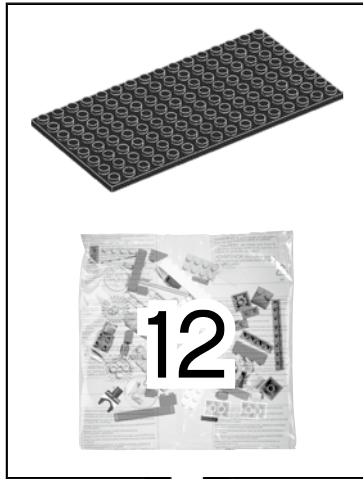

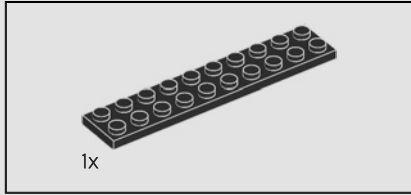
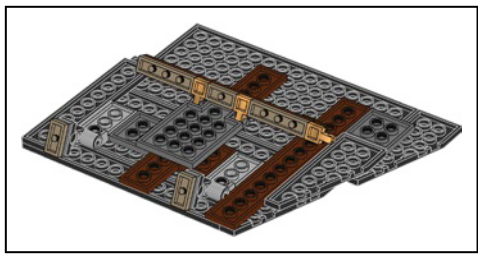

276

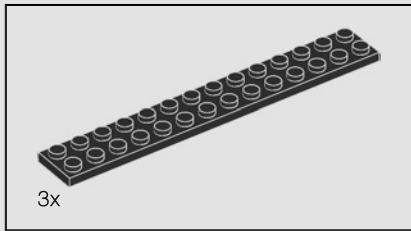
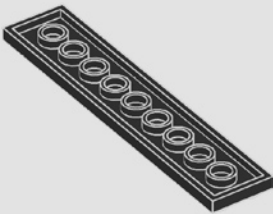

277

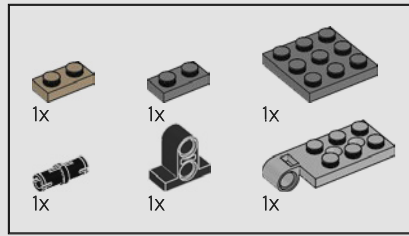
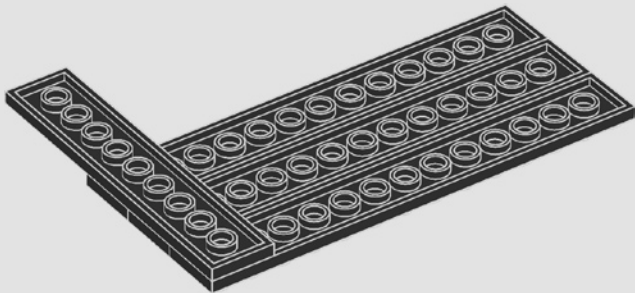

278

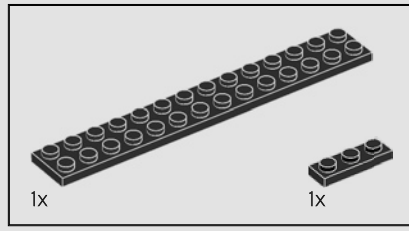
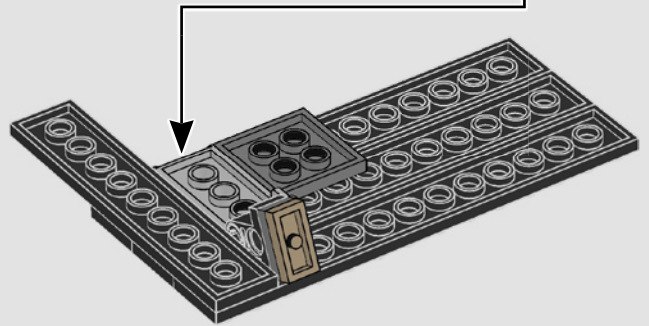
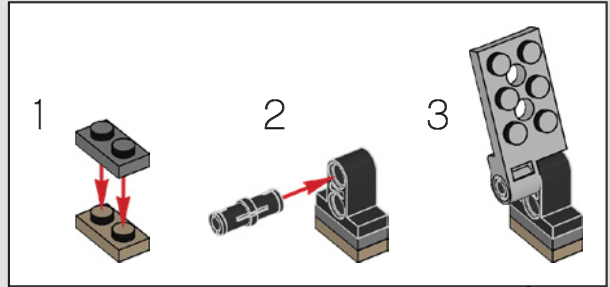

279

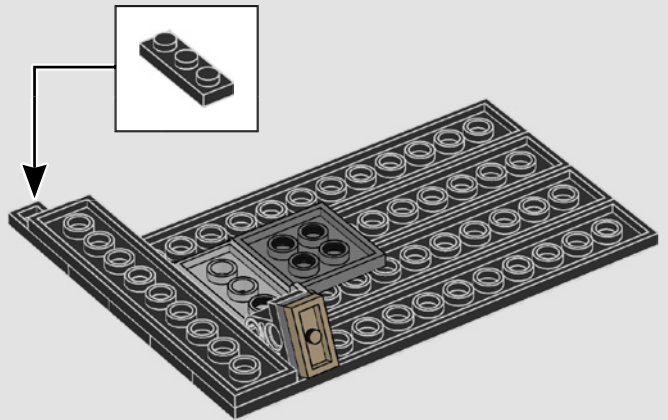

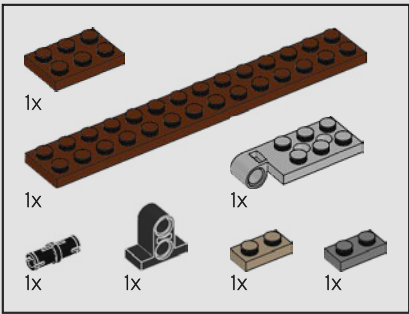

280

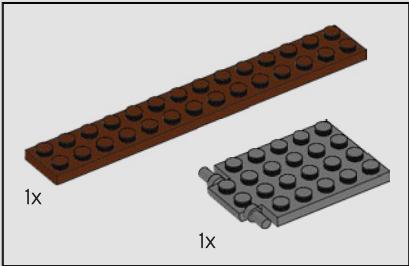
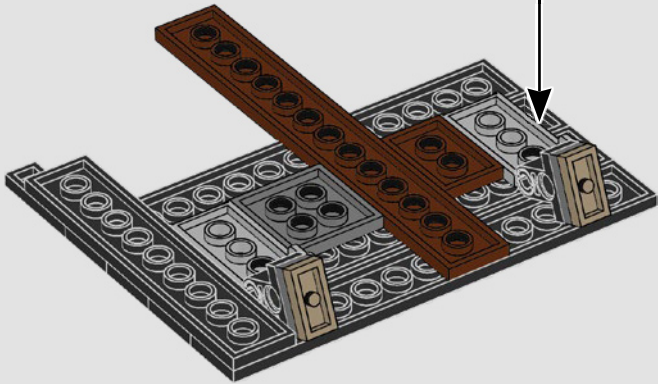
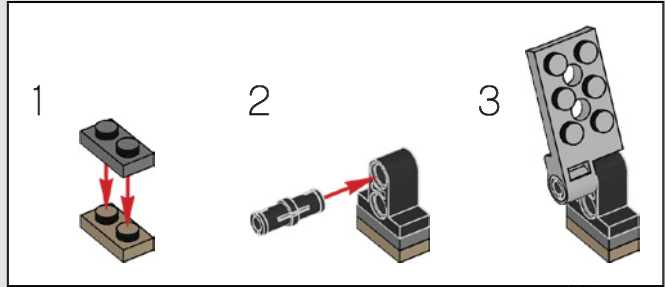

281

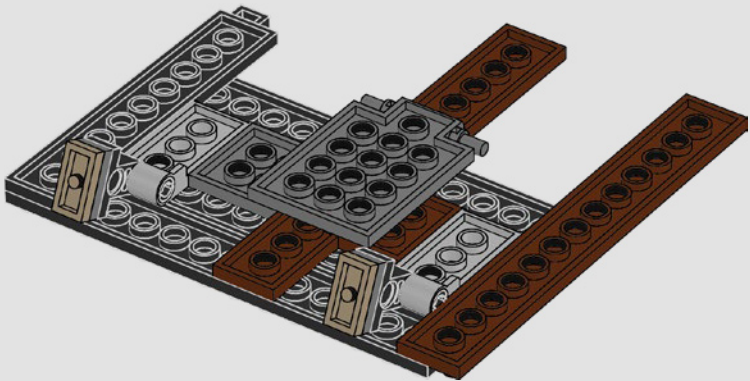

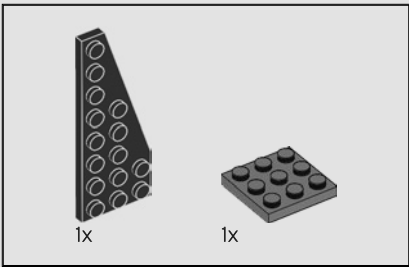

284

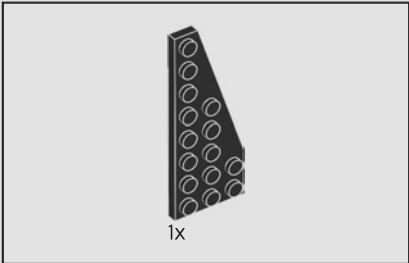
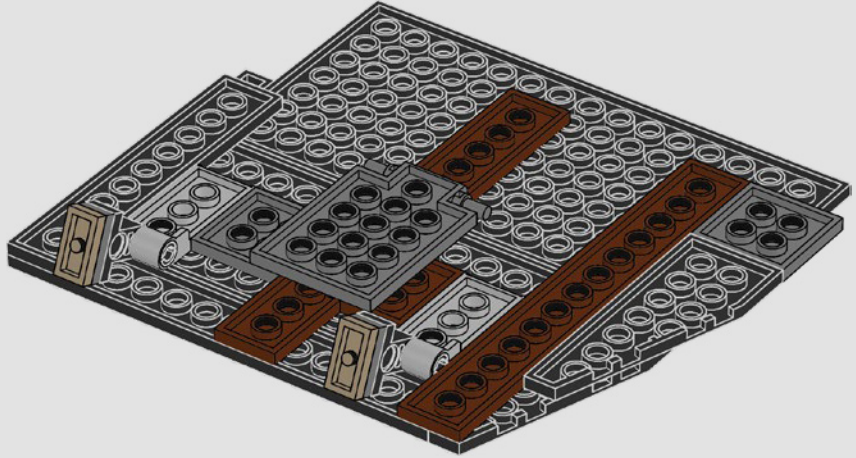

285

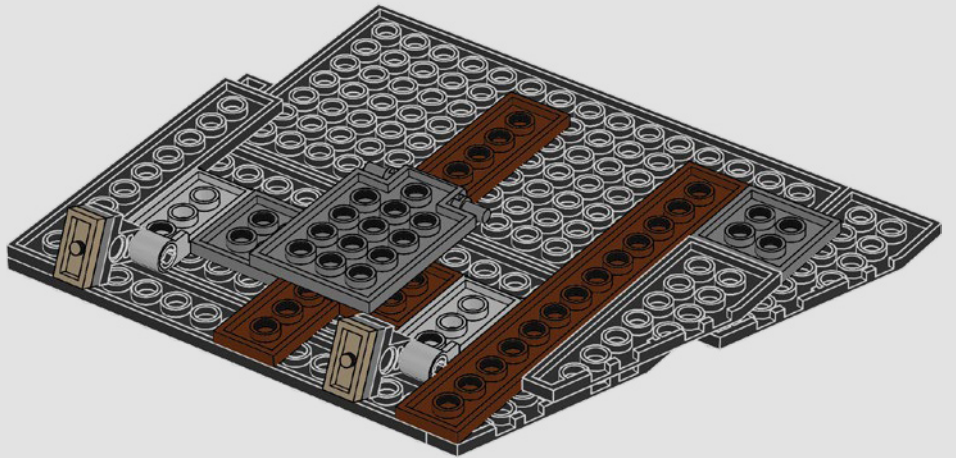

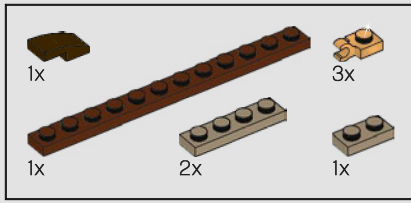

286

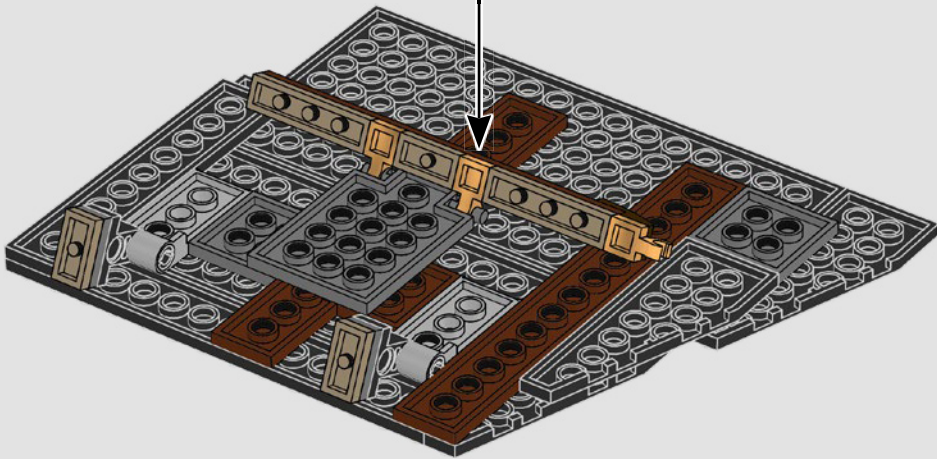
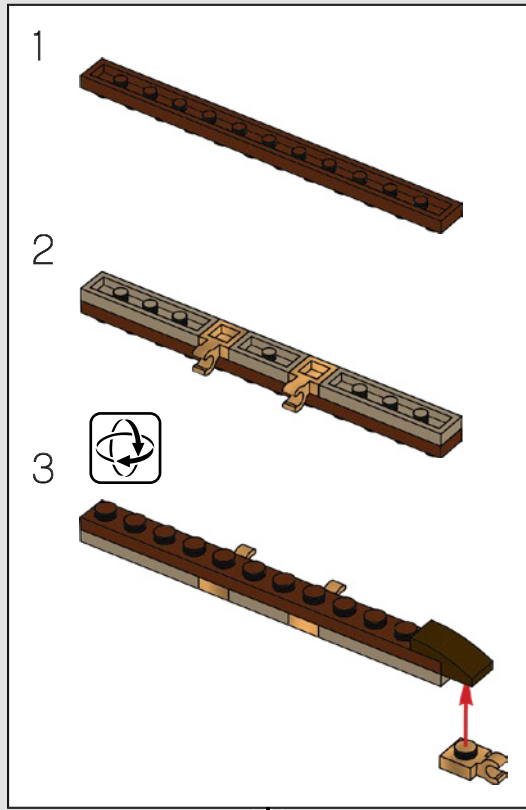

287





288

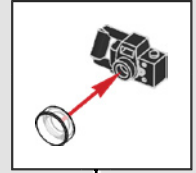
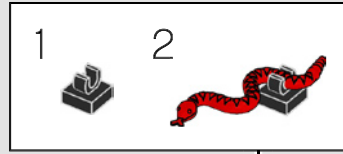

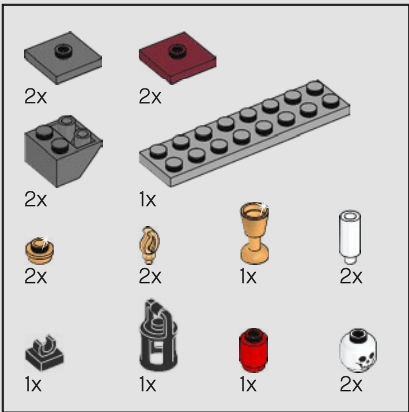

289

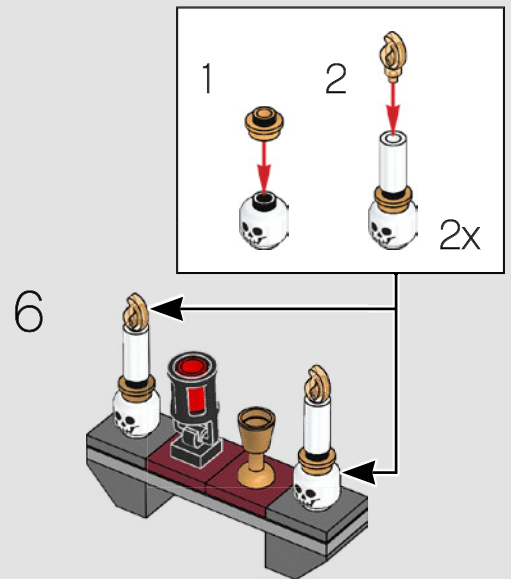
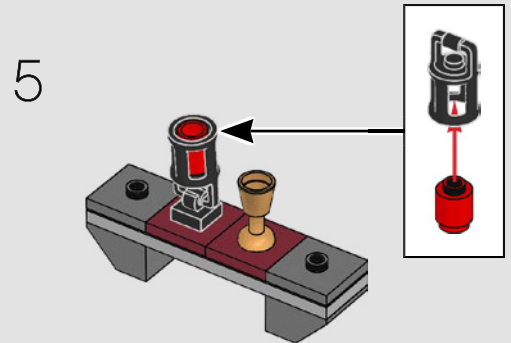
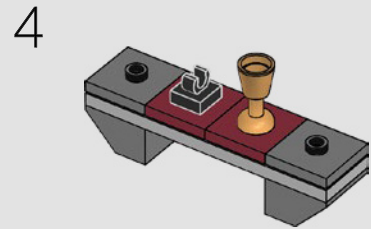
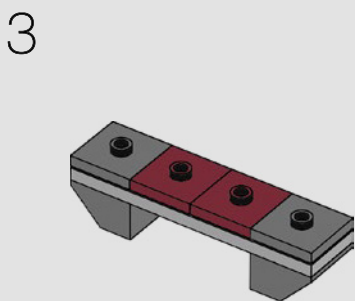
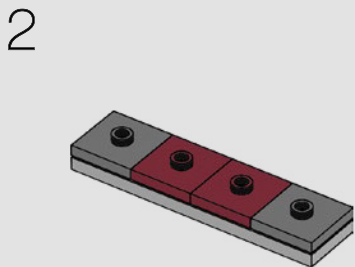
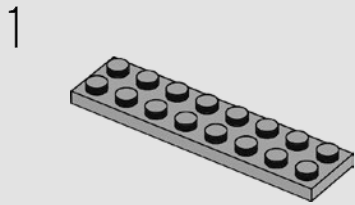

El Altar de Alhazred

Se desconocen los ritos oscuros para los que se construyó originalmente esta pesada mesa de piedra. El barón la usaba los días de lluvia, para entretenerse leyendo.



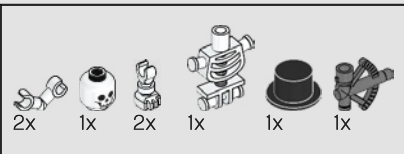

290

El Esqueleto Prohibido

Hay quien dice que el coche de Sam Sinister explotó mientras escapaba de la ley, dejando atrás nada más que su esqueleto y una chistera. Otros cuentan que una vez hubo un tercer mayordomo gemelo. Nadie lo sabe a ciencia cierta.

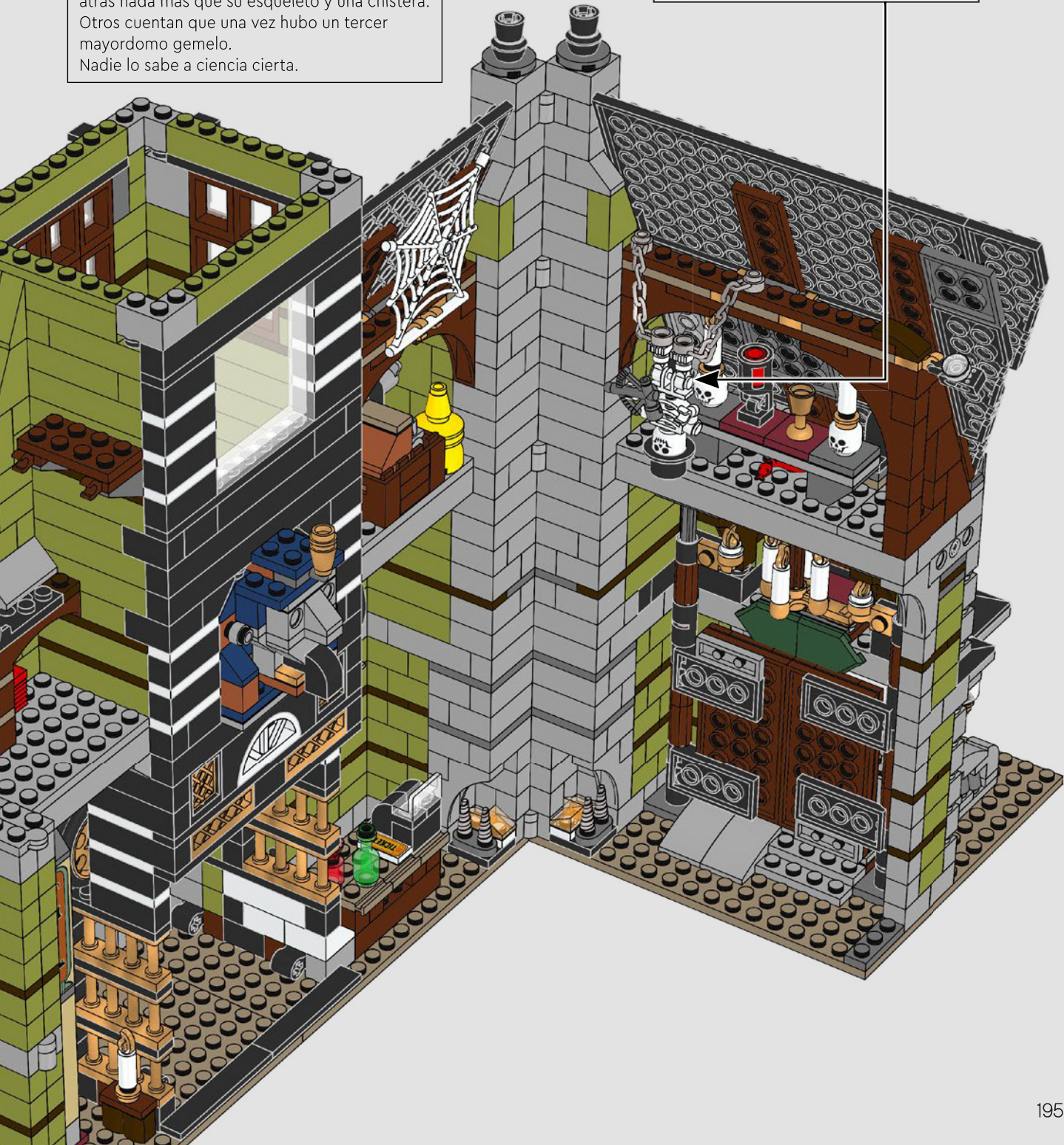
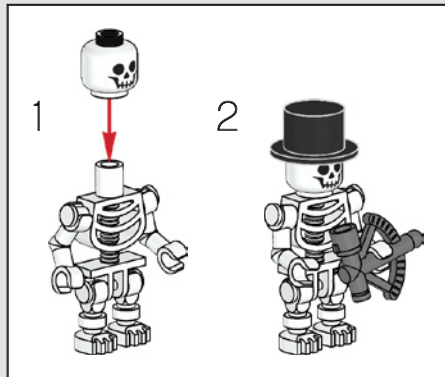

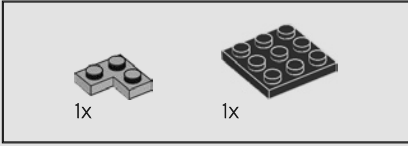
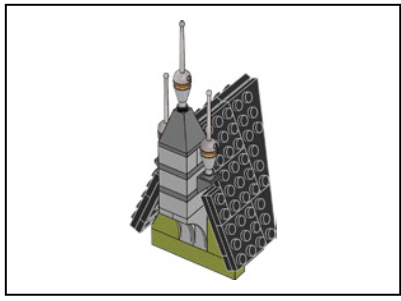

291

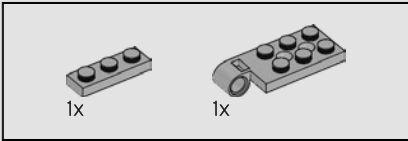
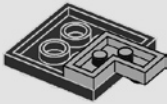

292

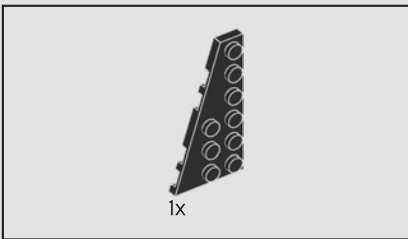
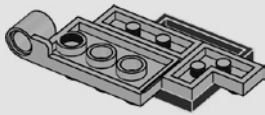

293

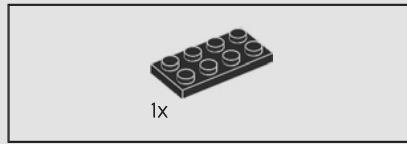
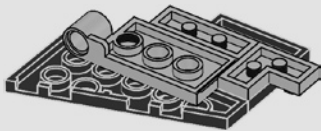

294

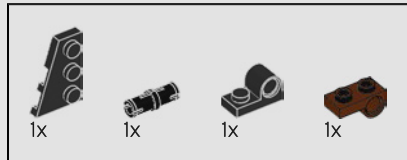
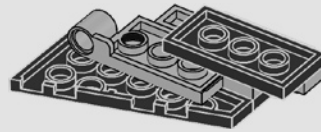

295

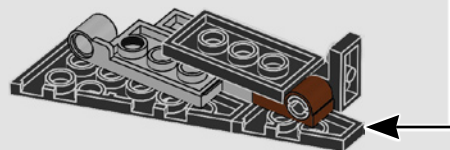
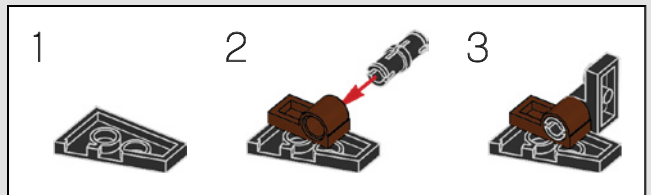

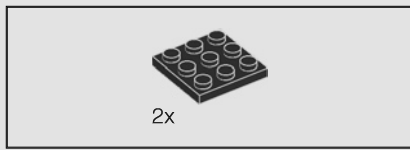

296

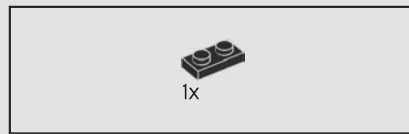
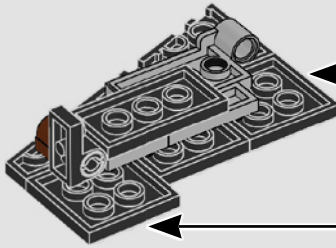
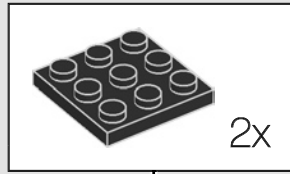

298

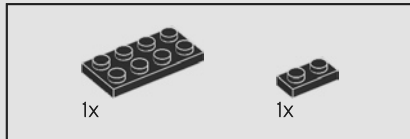
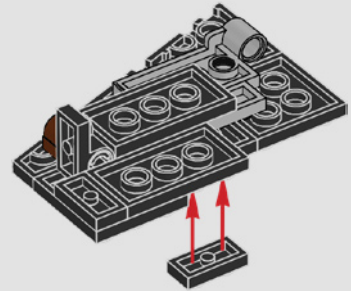

297

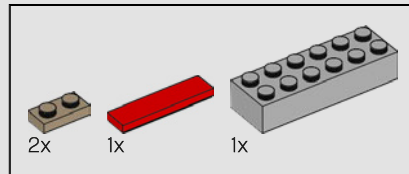
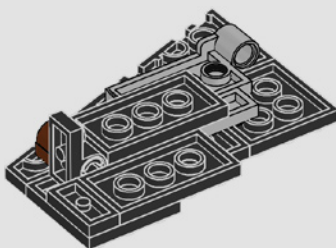

299

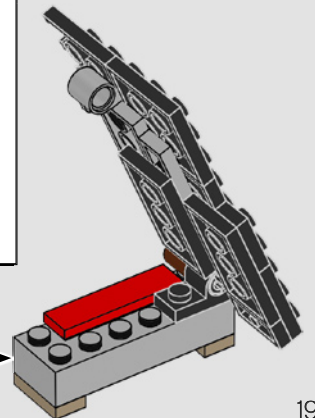
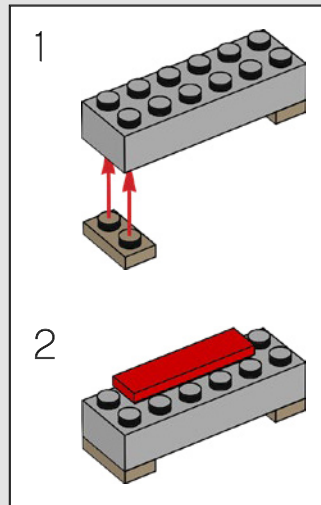

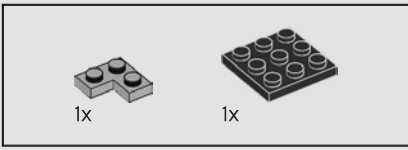

300

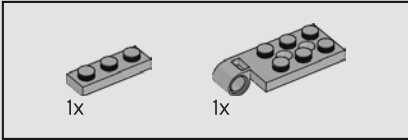
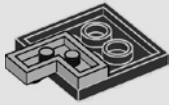

301

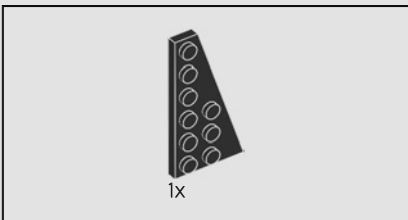
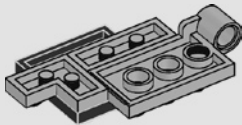

302

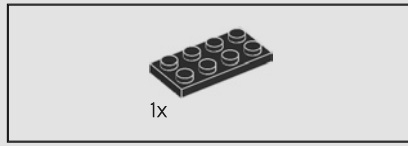
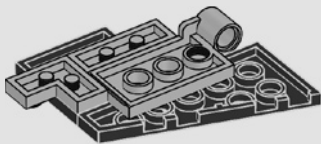

303

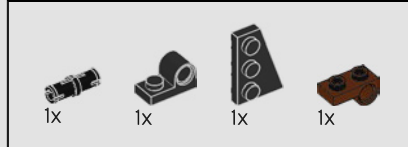
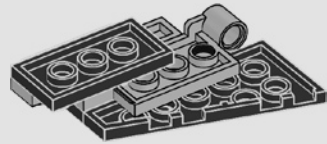

304

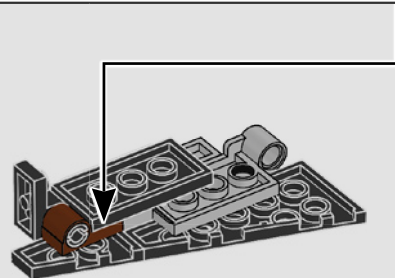
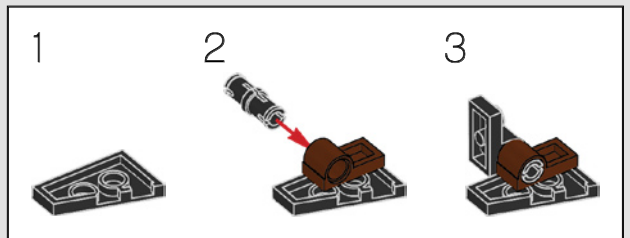

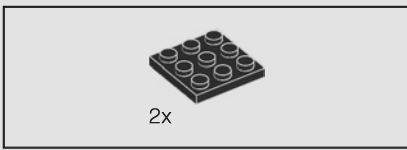

305

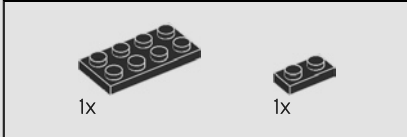
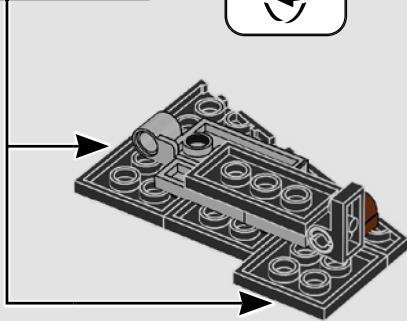
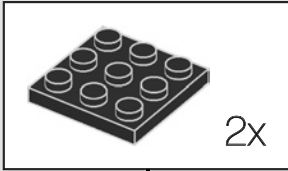

306

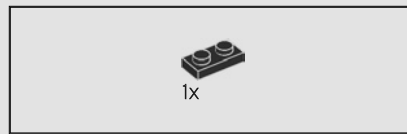
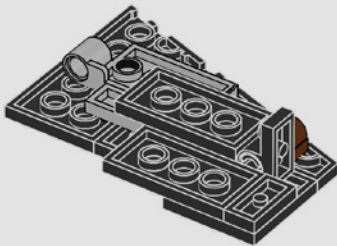

307

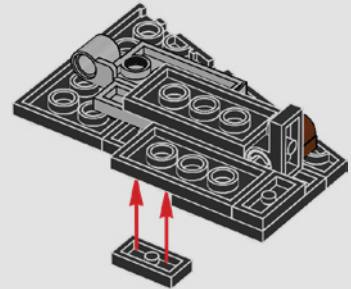

308

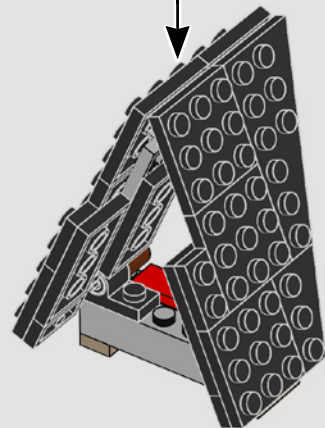

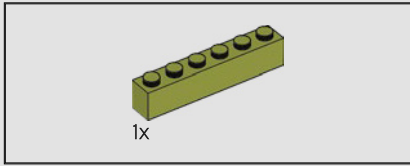
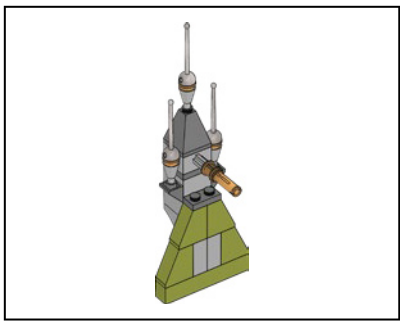

309

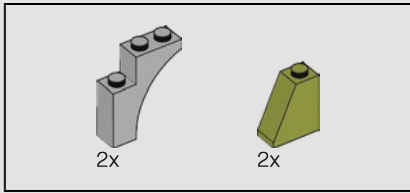
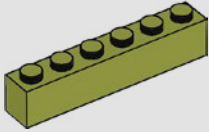

310

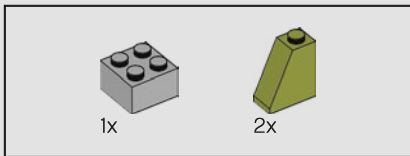
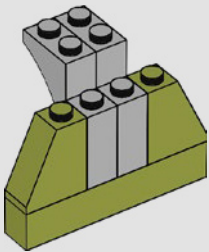

311

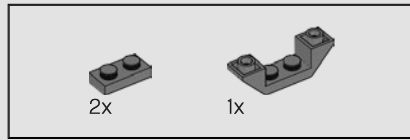
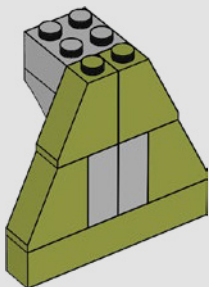

312

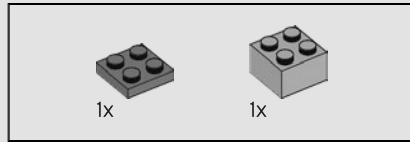
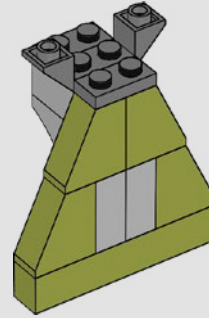

313

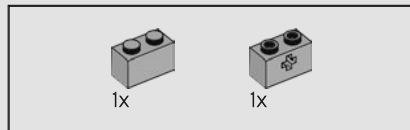
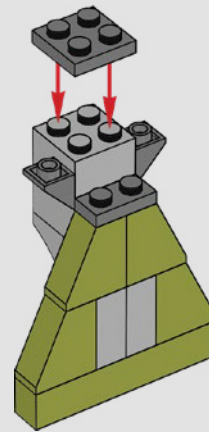

314

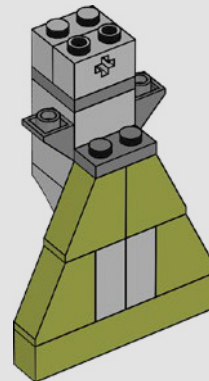

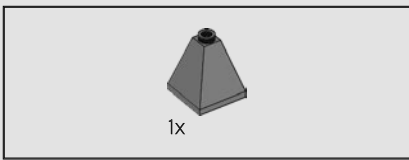

315

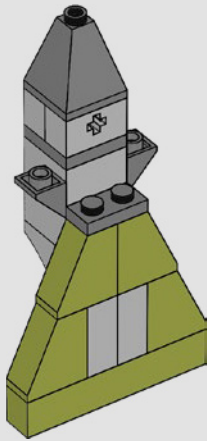

316

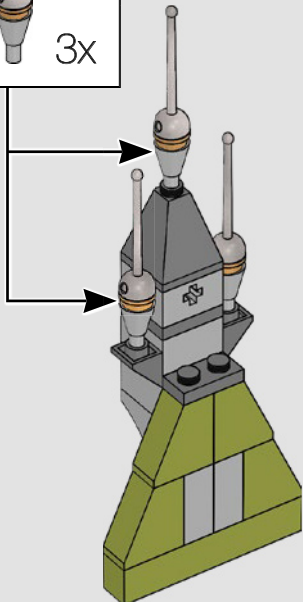
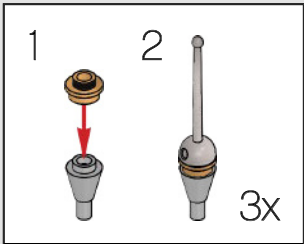

317

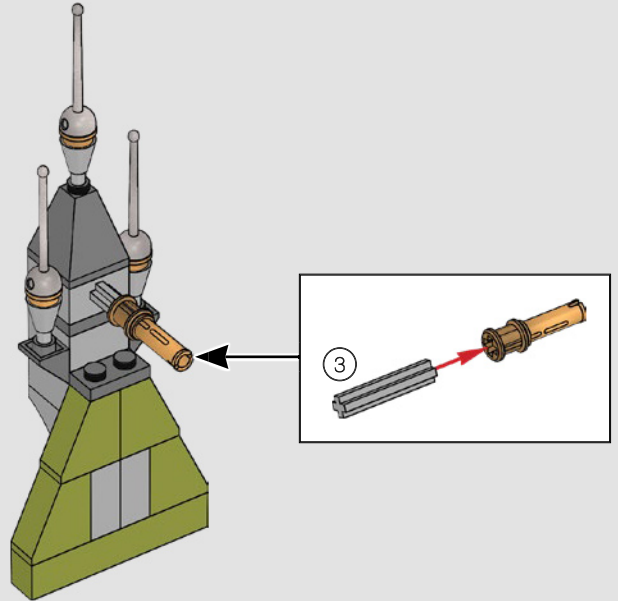

318

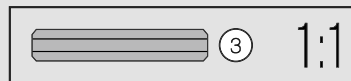
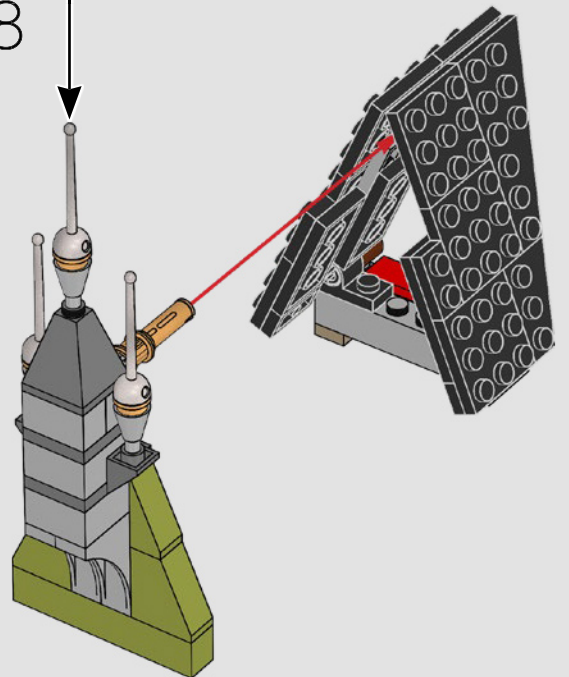

319

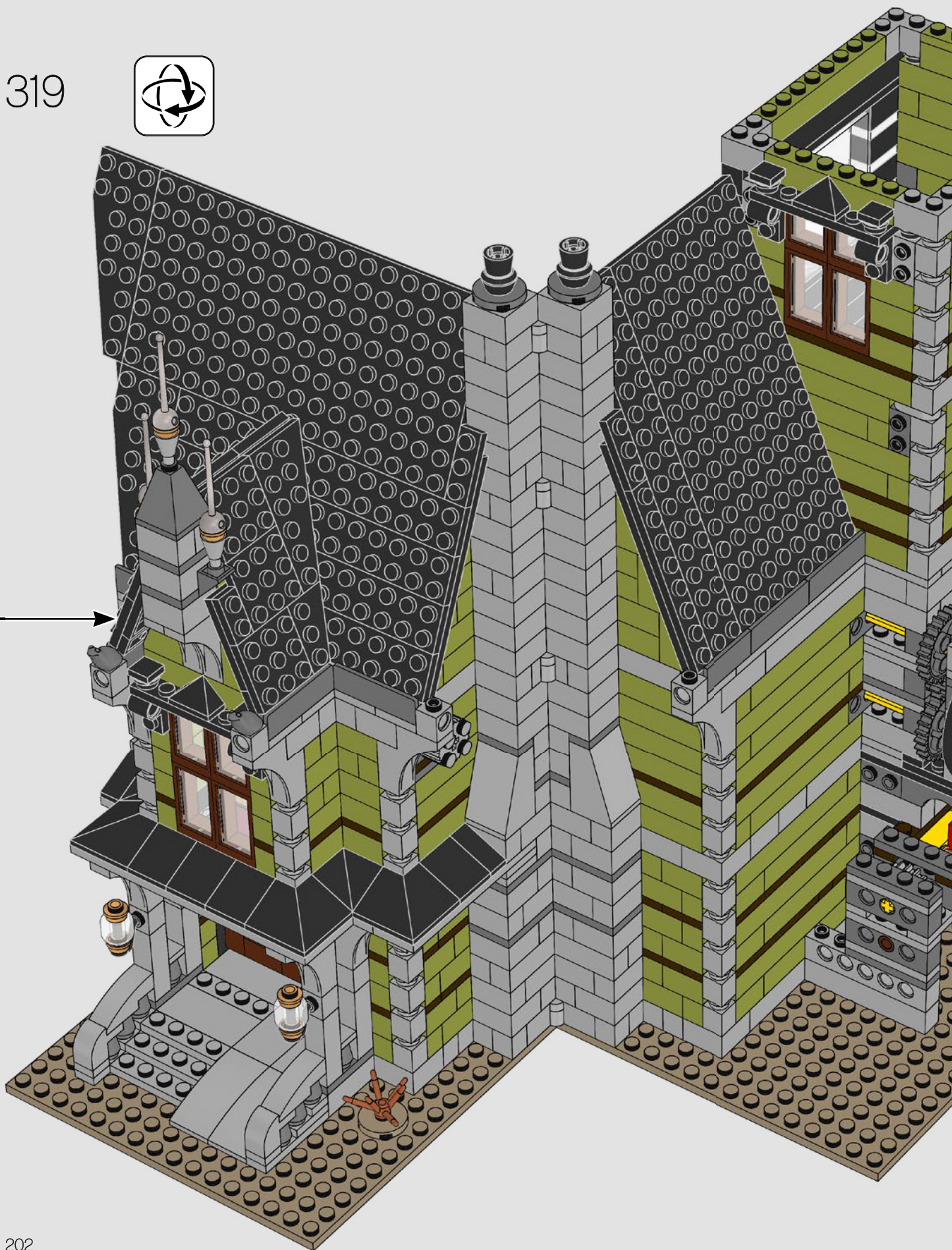

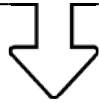

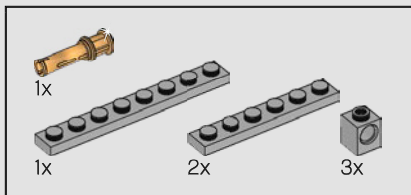

320

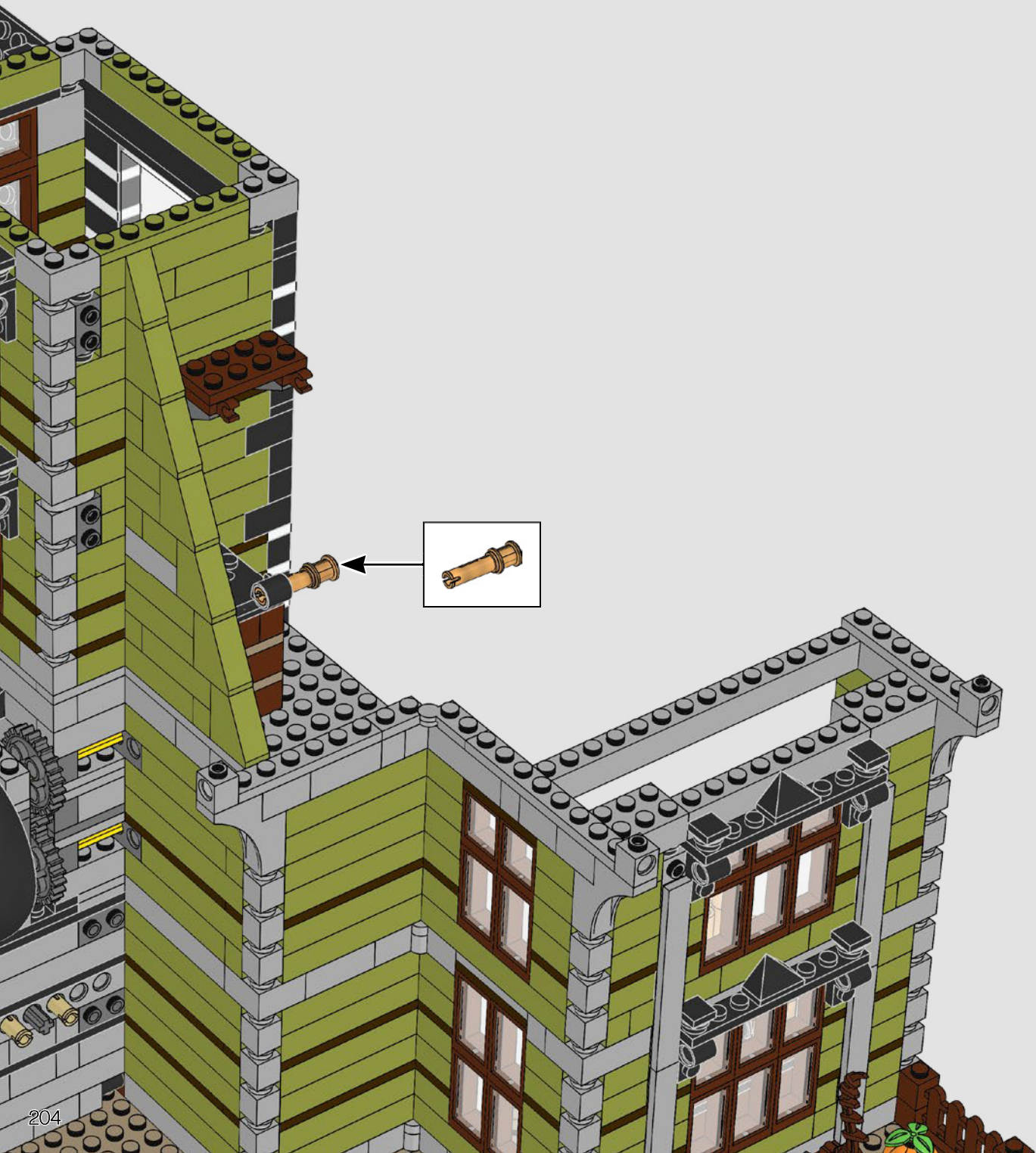

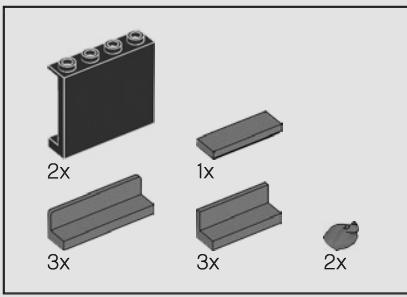

321

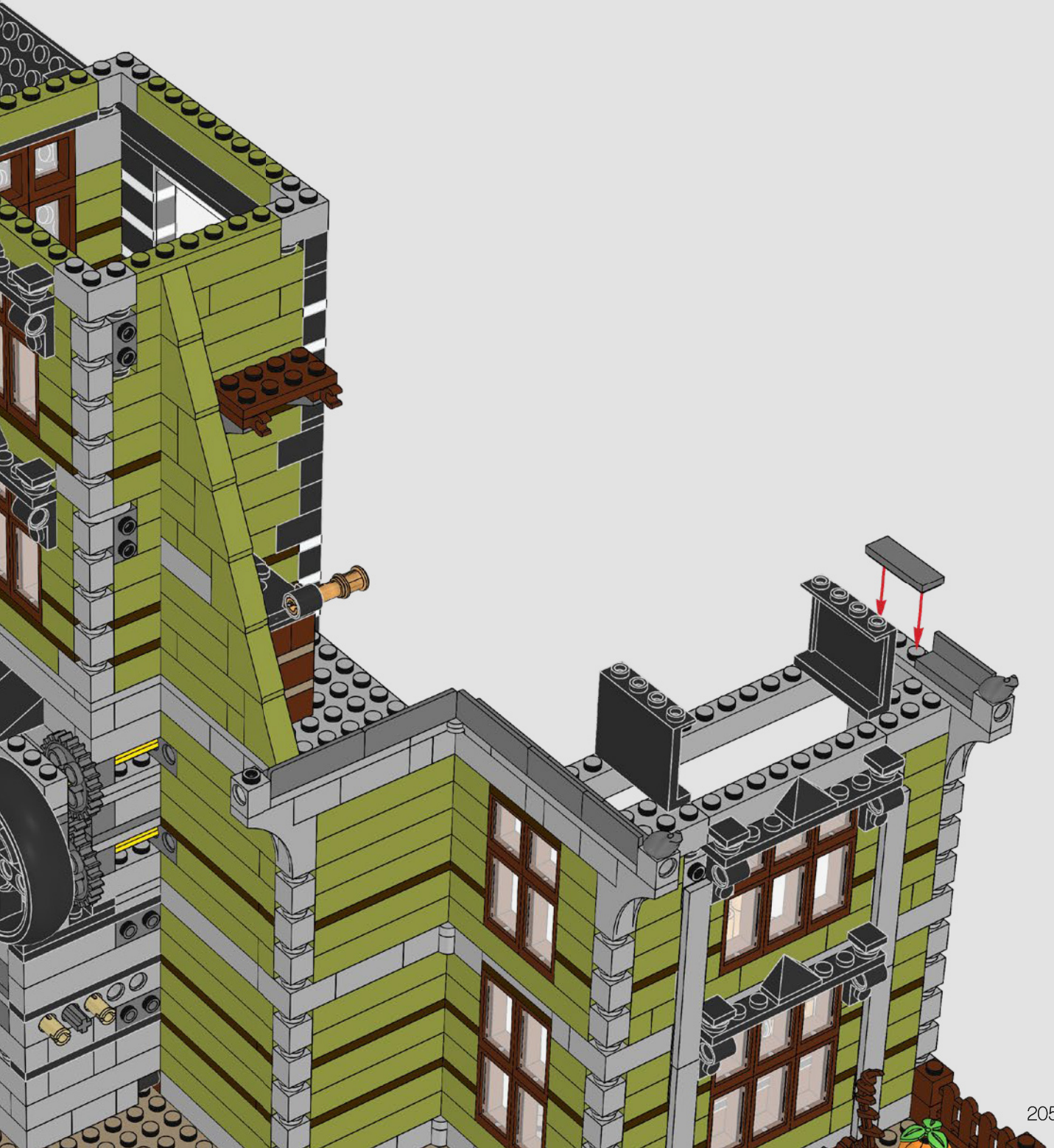

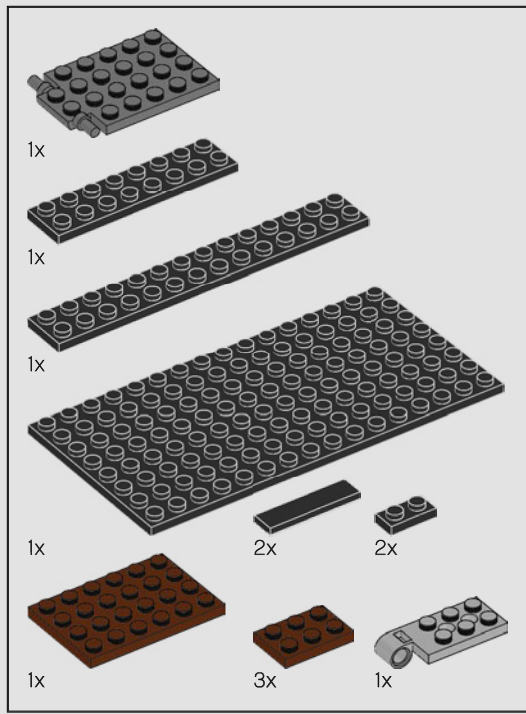

322

1



2

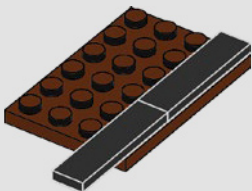

3

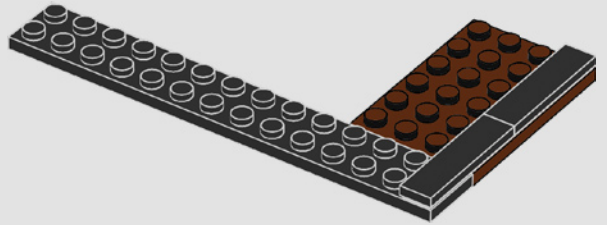

4

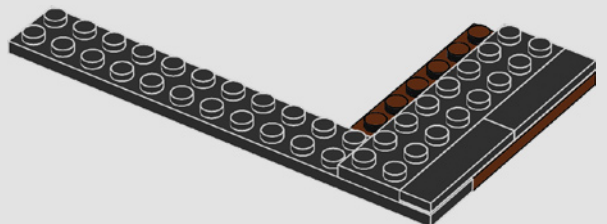

5

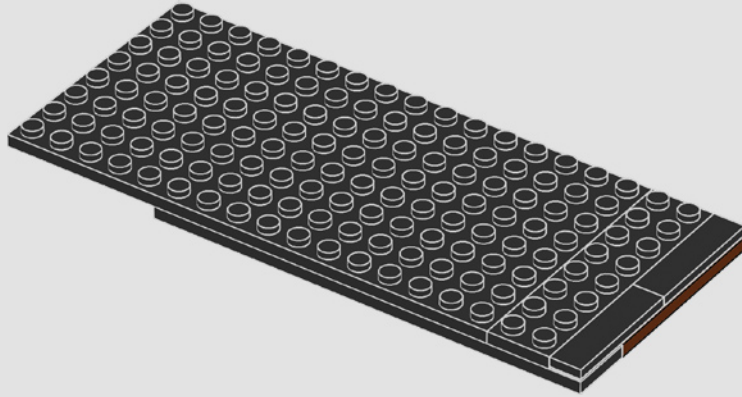

6

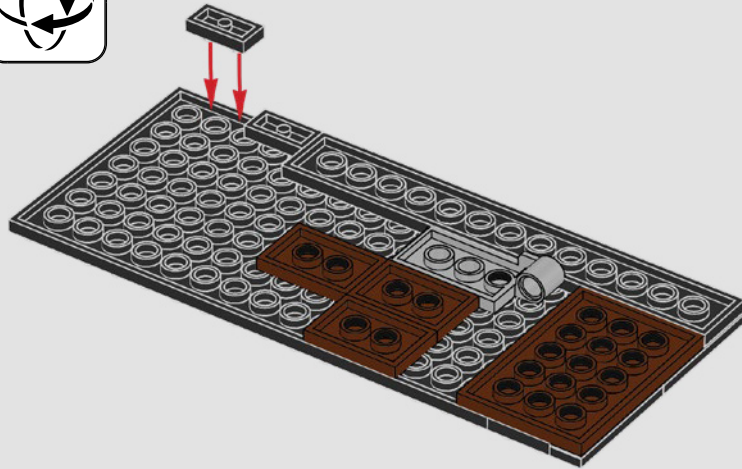

7

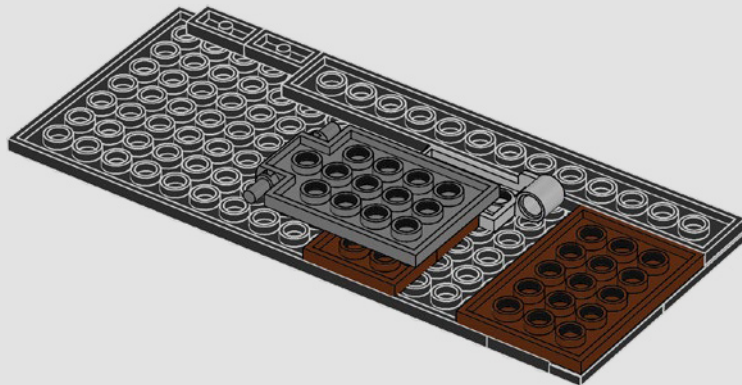



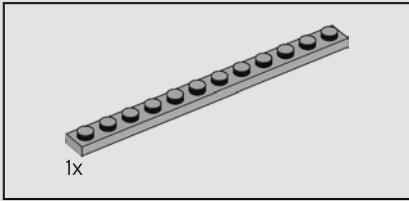
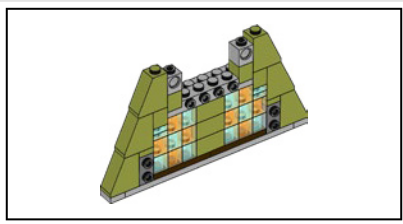

323

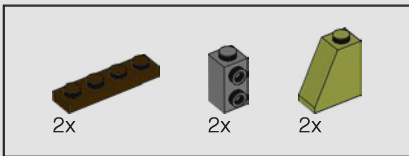
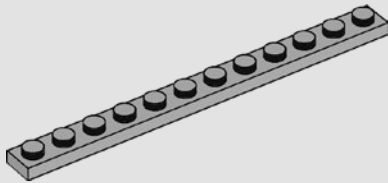

324

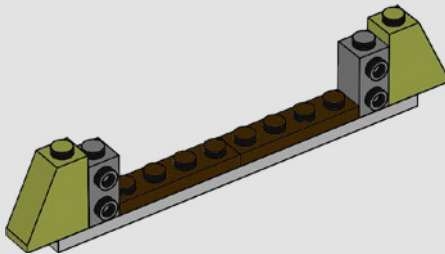

325

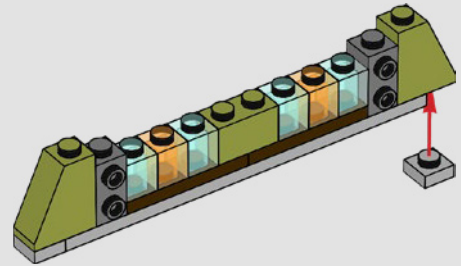

326

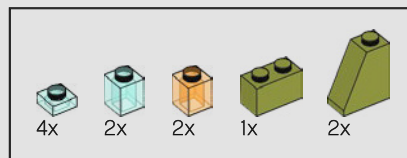
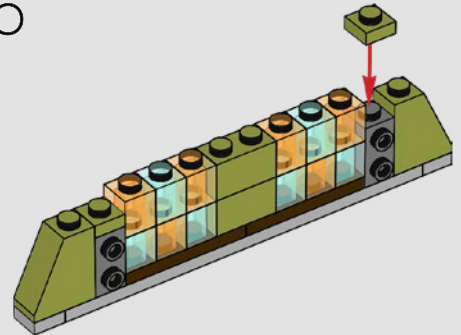

327

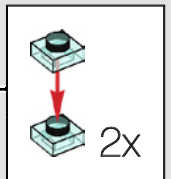
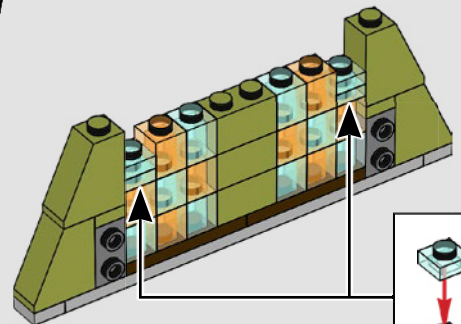

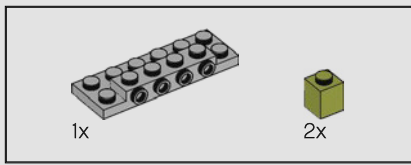

328

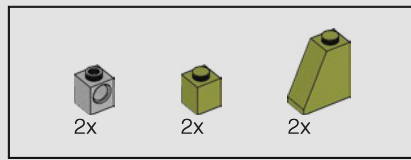
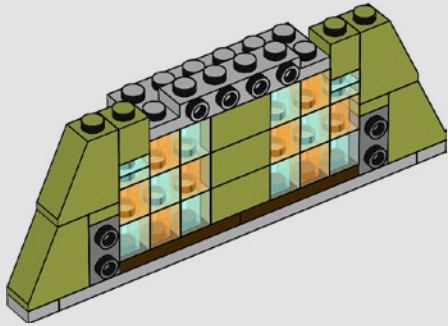

329

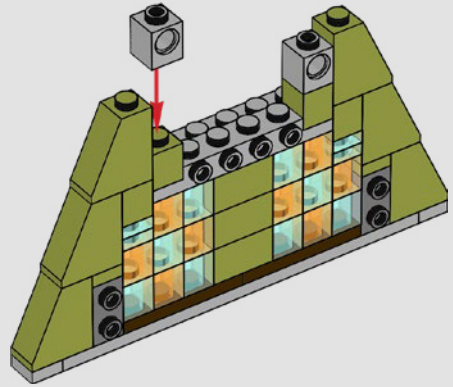

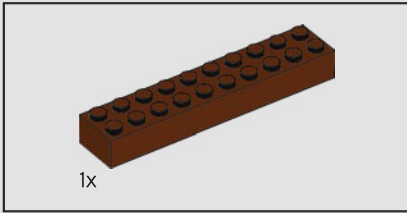
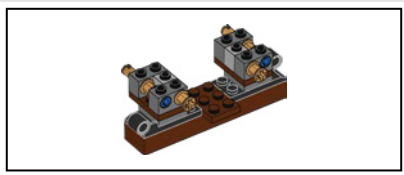

1x

330

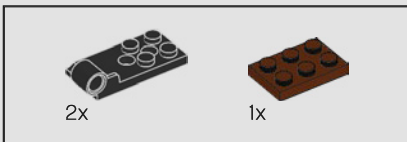
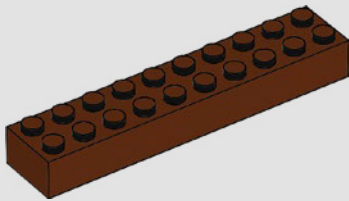

2x

1x

331

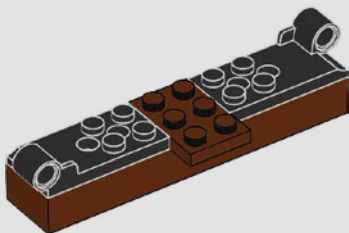

2x

332

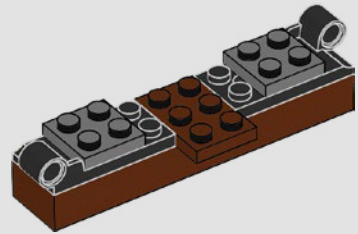

2x

333

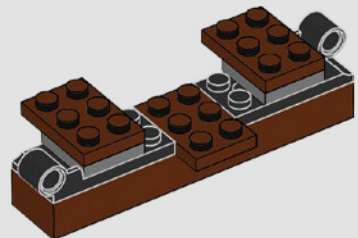

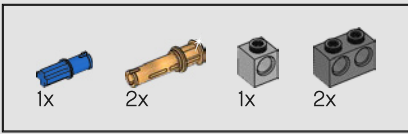

334

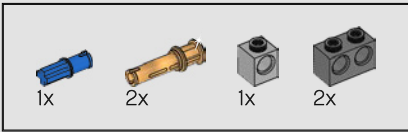
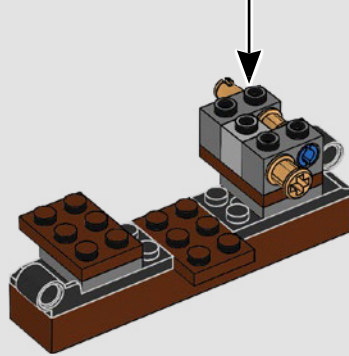
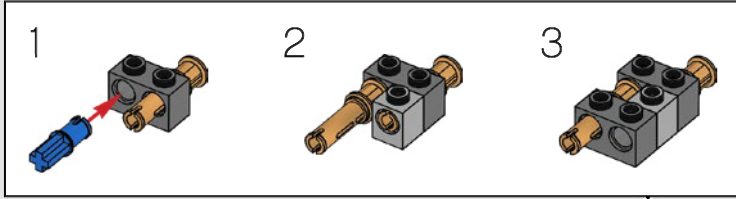

335

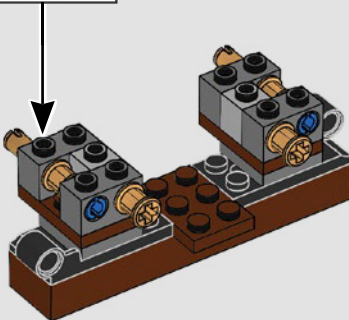
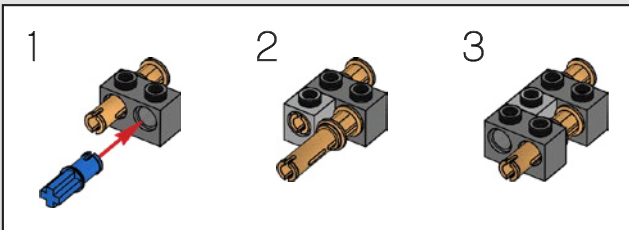

336



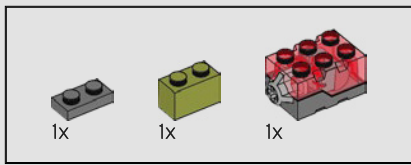

337

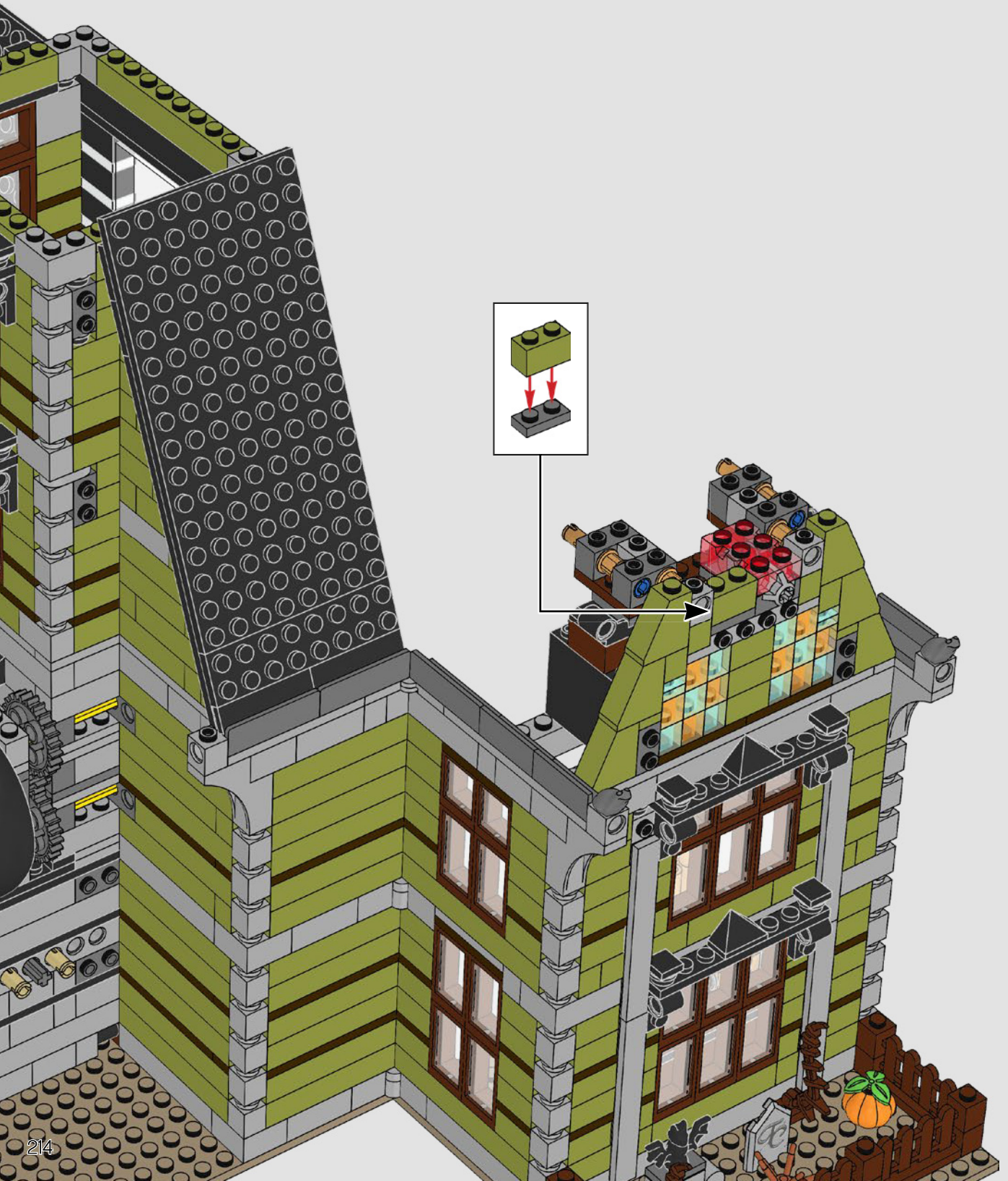
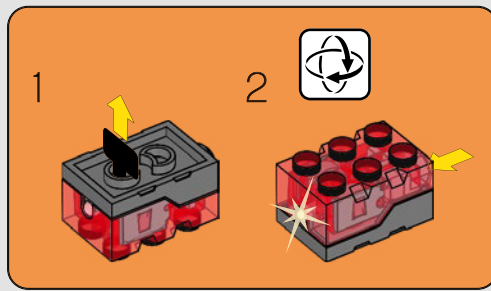

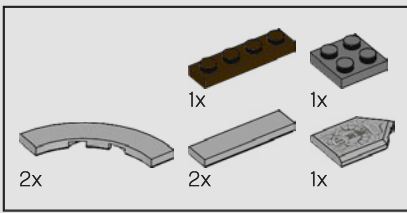

338

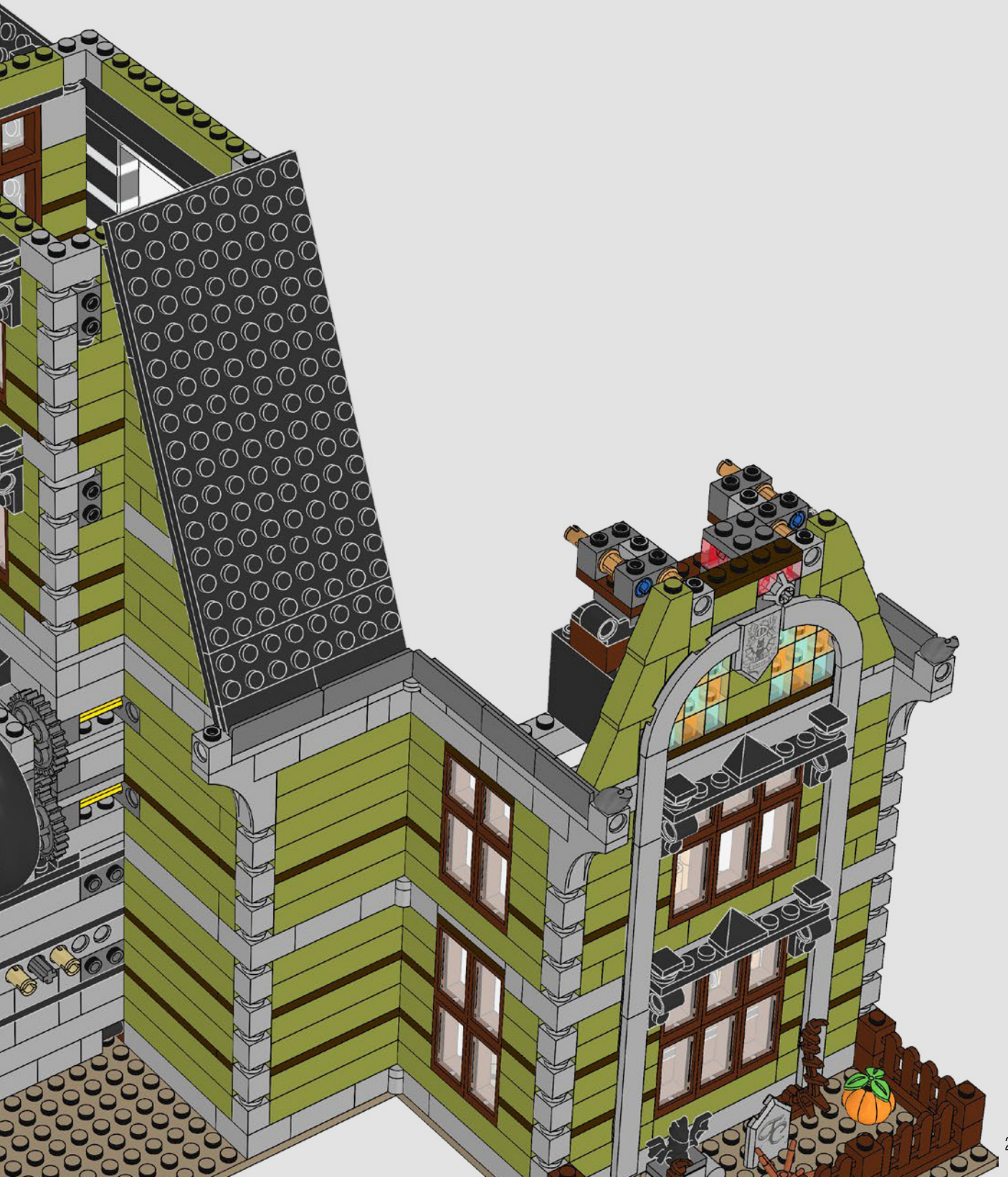

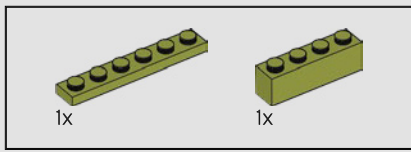

339

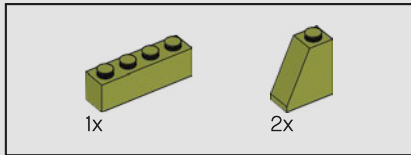
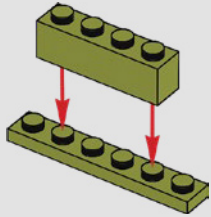

340

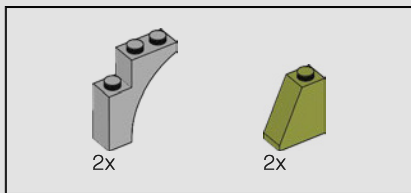
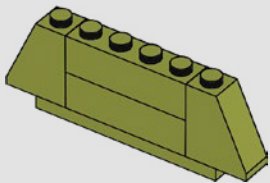

341

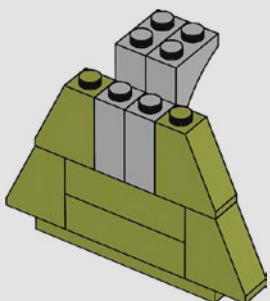

342

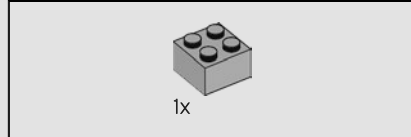
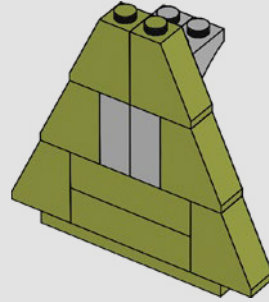

343

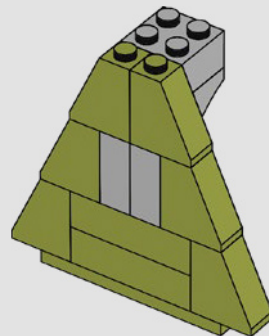

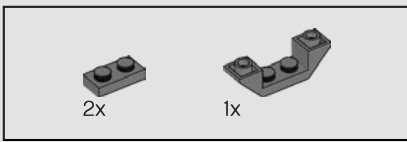

344

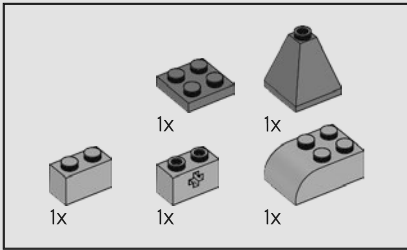
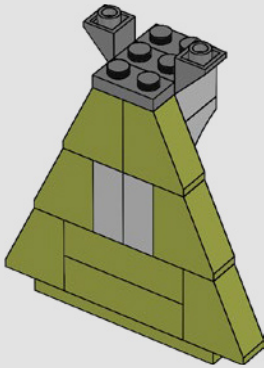

345

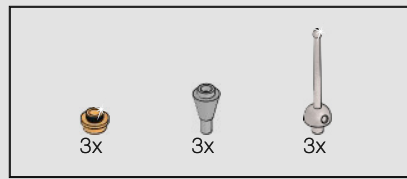
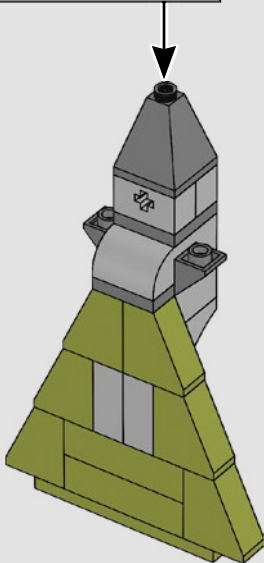
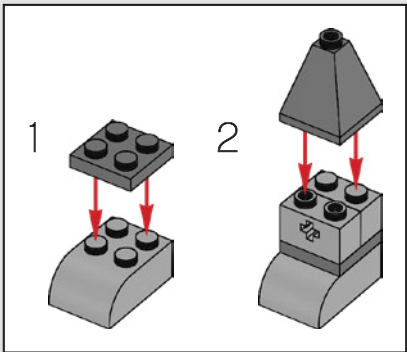

346

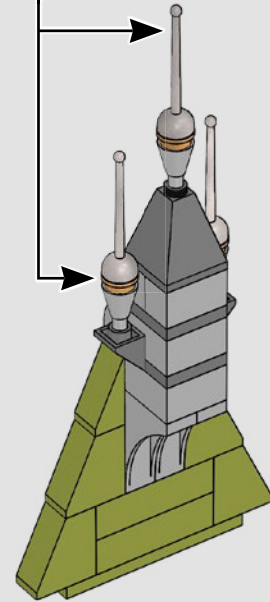
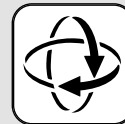
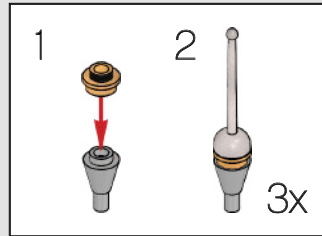

347

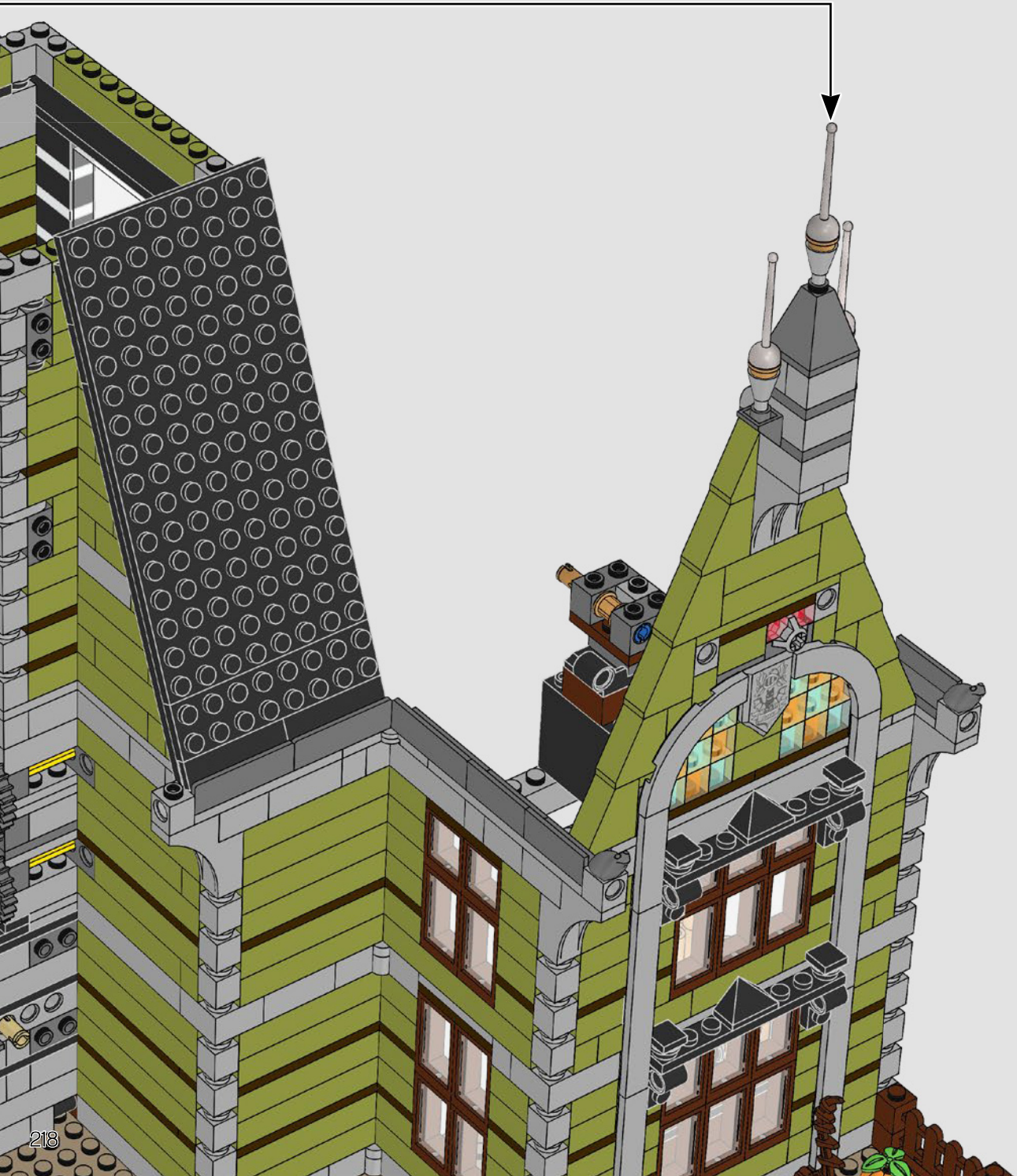

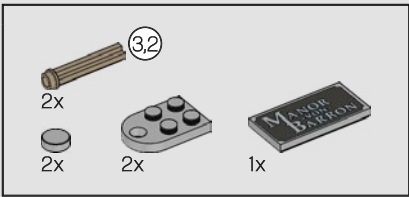

348

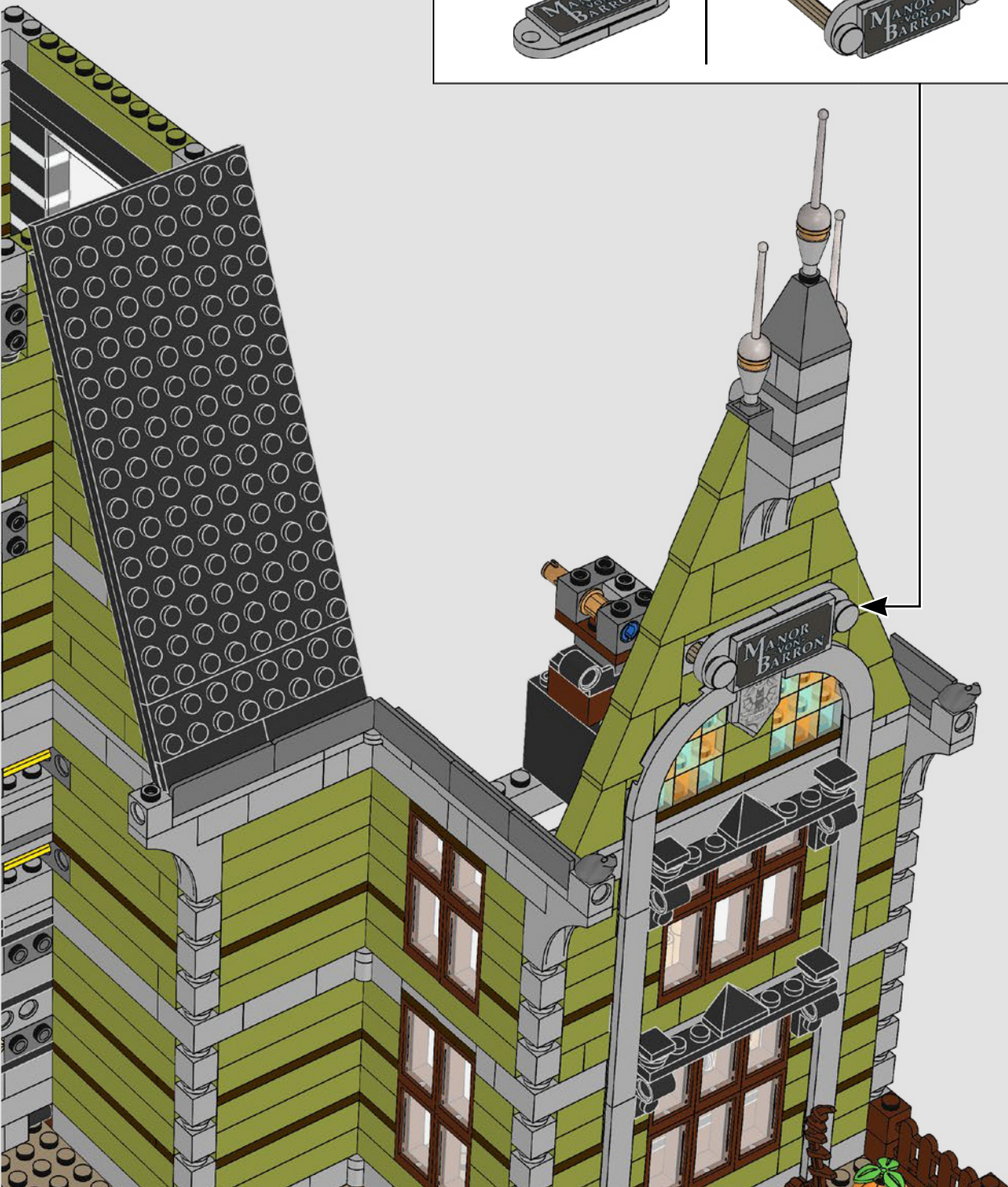
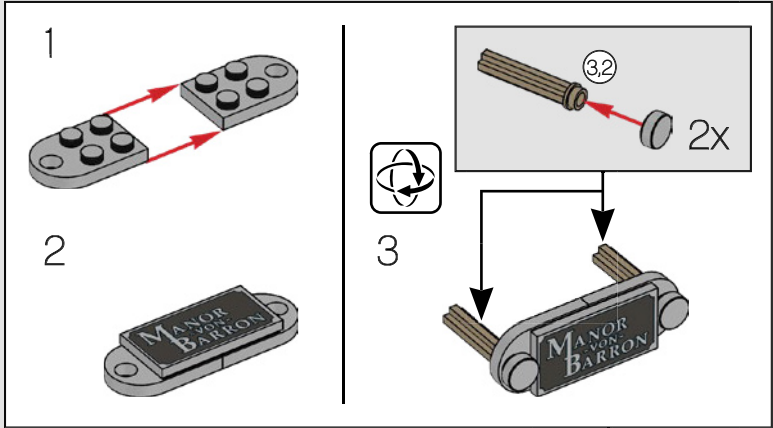
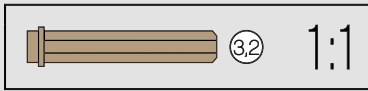

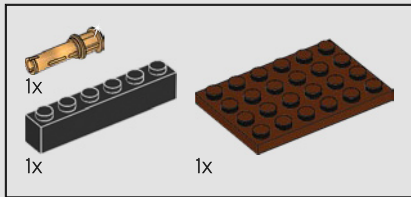

349

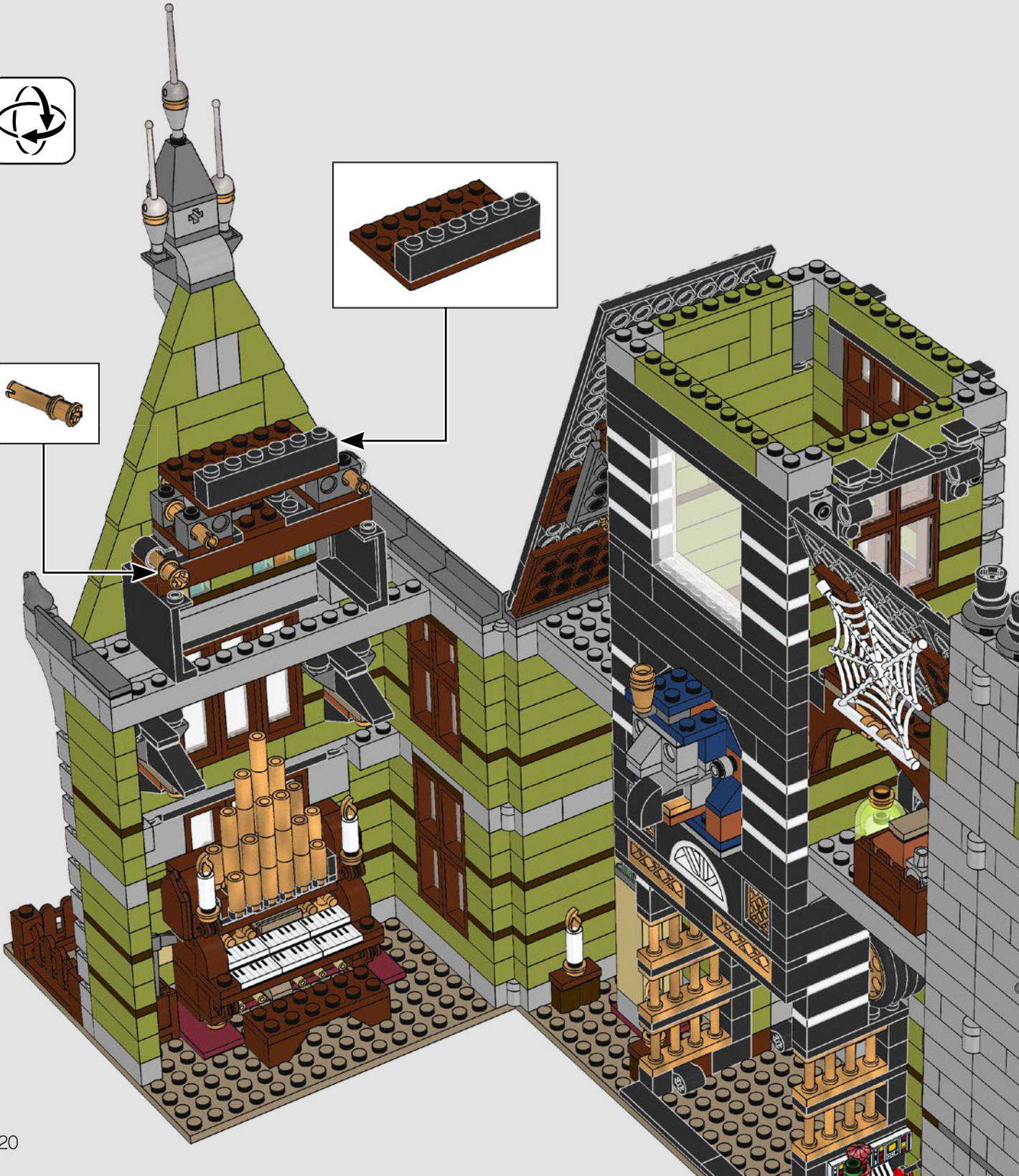
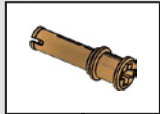
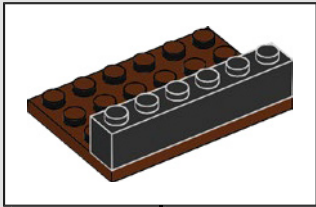

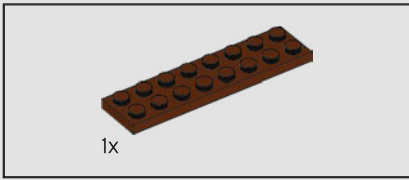
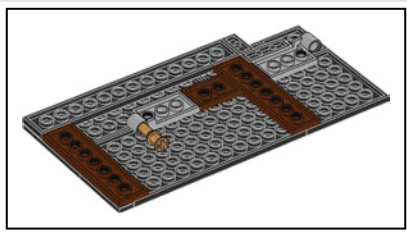

350

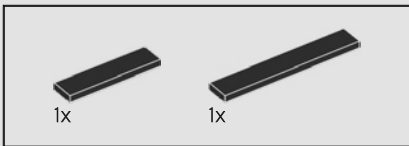
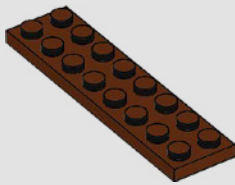

351

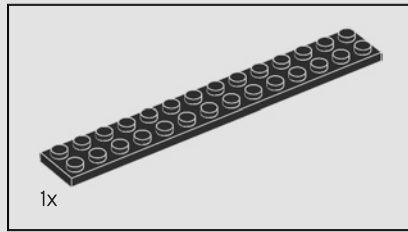
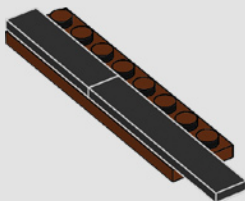

352

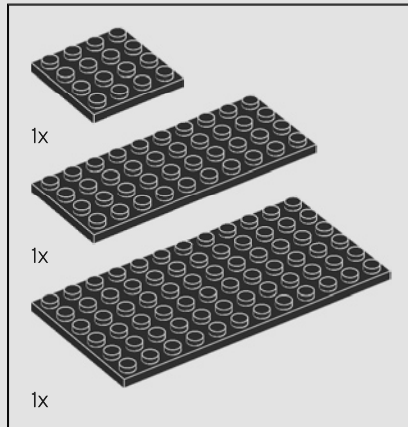
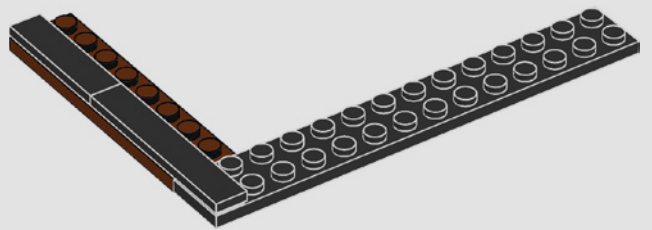

353

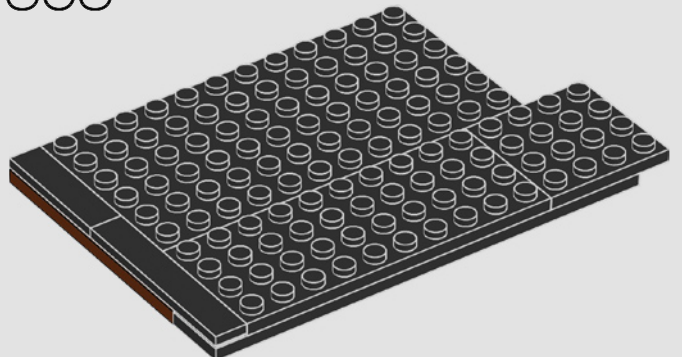

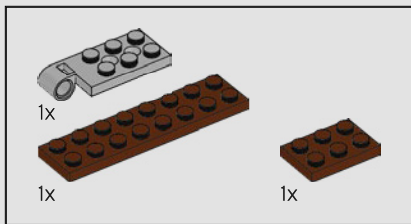

354

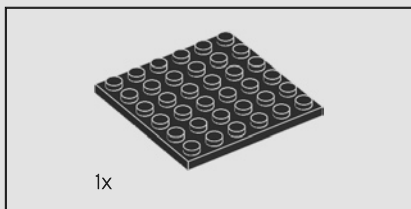
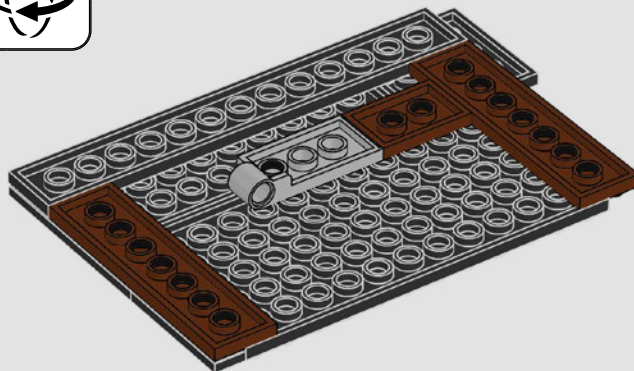

355

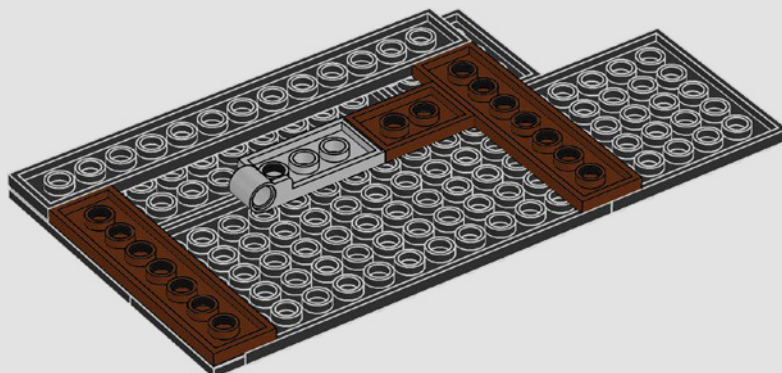

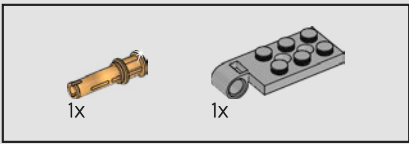

356

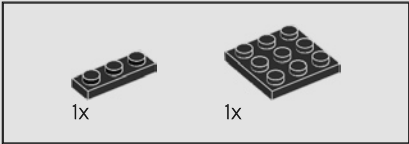
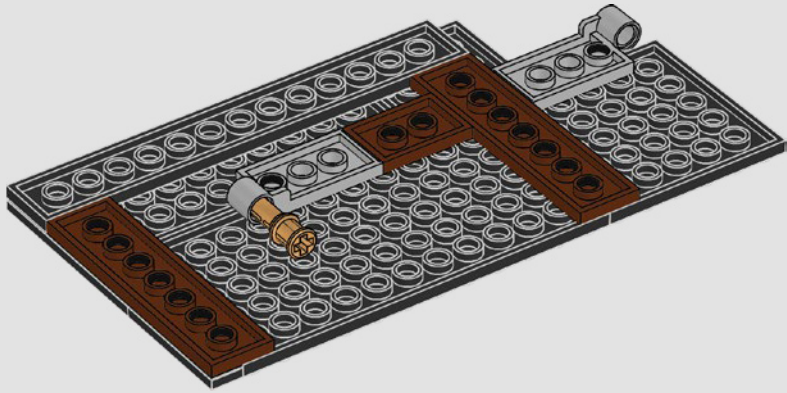

357

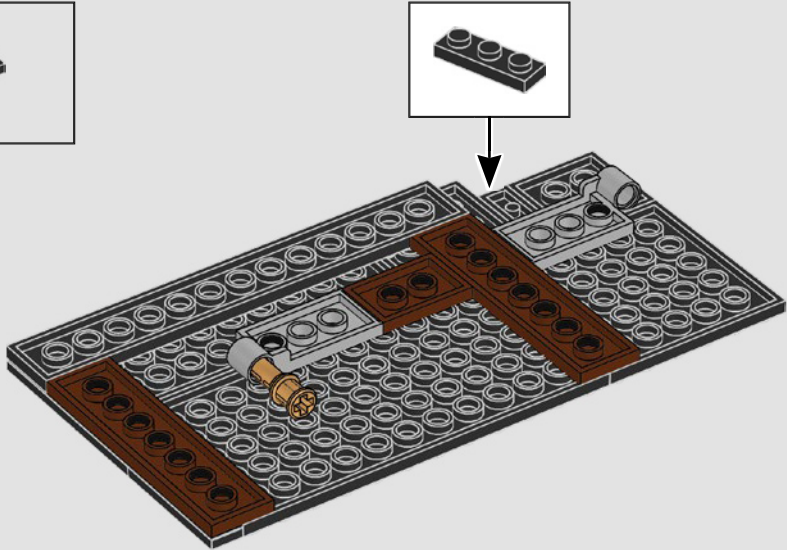

358

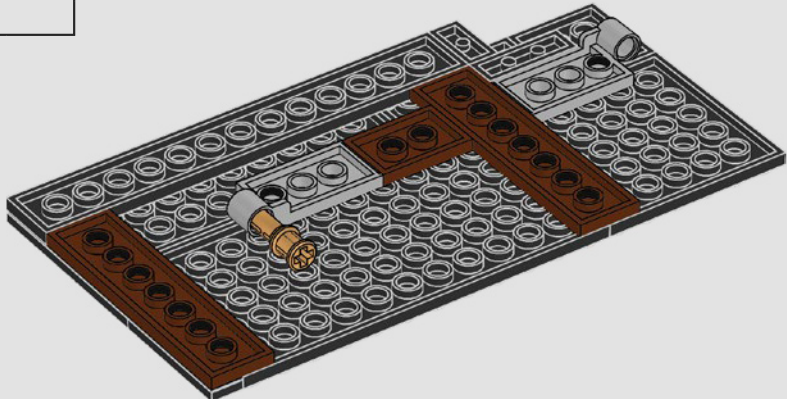

359

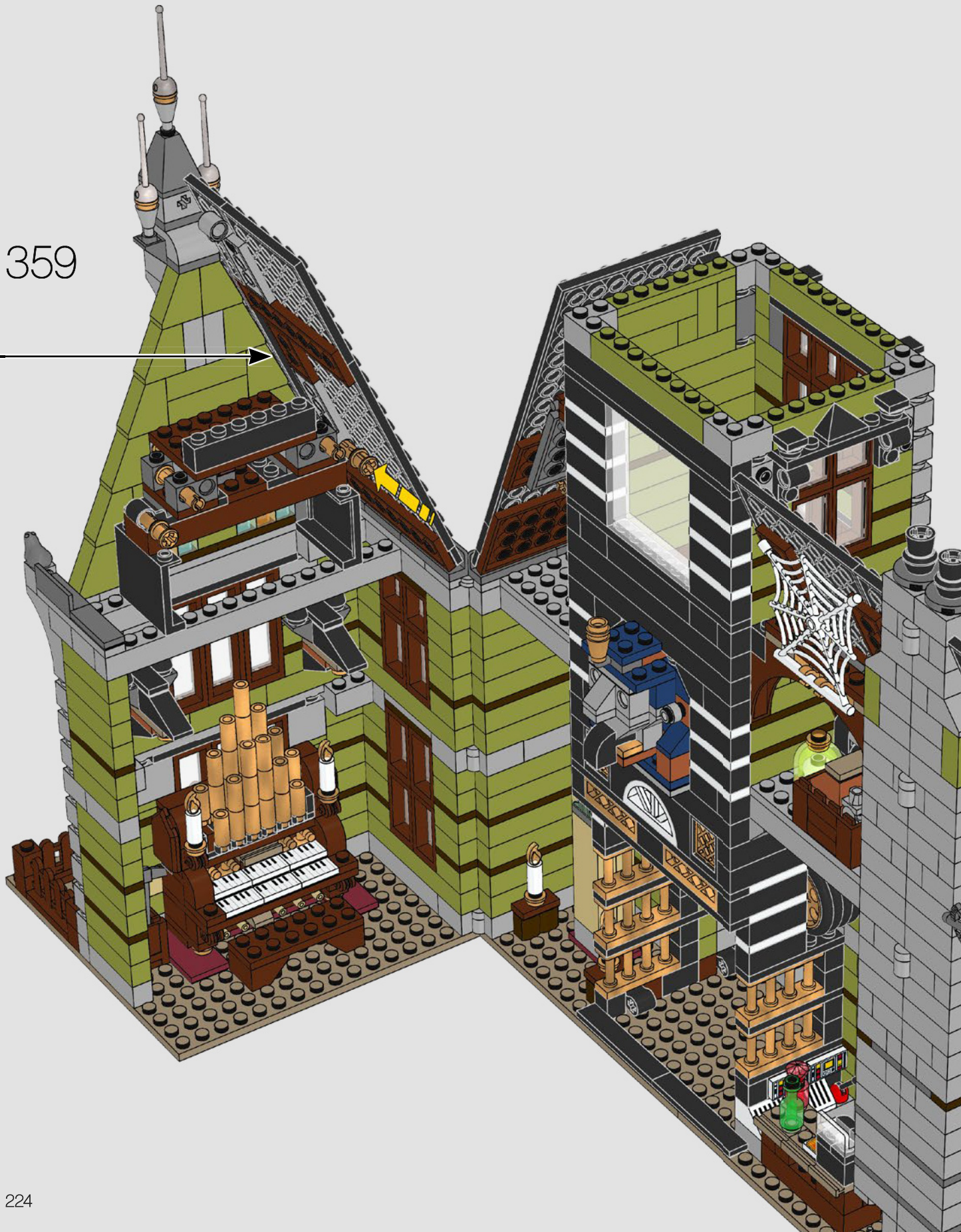



1x

365

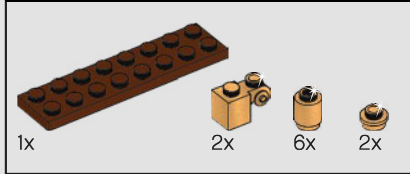

1x

2x

6x

2x

366

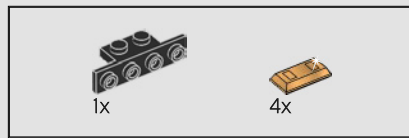
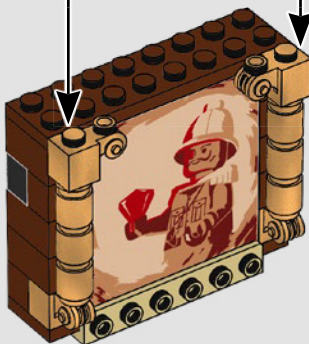
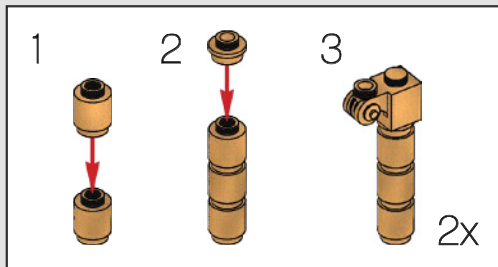

1x

4x

367

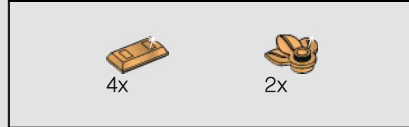
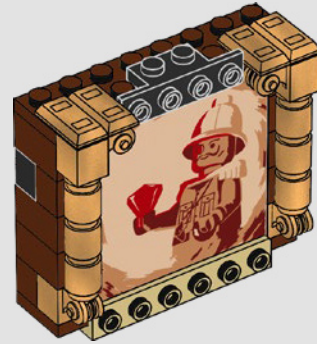

4x

2x

368

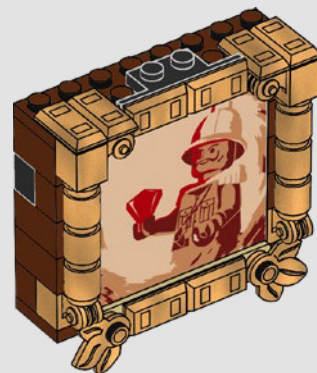

El Retrato de Samuel von Barron

Cuando el pintor acabó el retrato, un extraño resplandor comenzó a emanar del rubí. Atormentado por la Maldición de la Momia, los malísimos chistes del faraón Hotep volvieron loco a Von Barron.

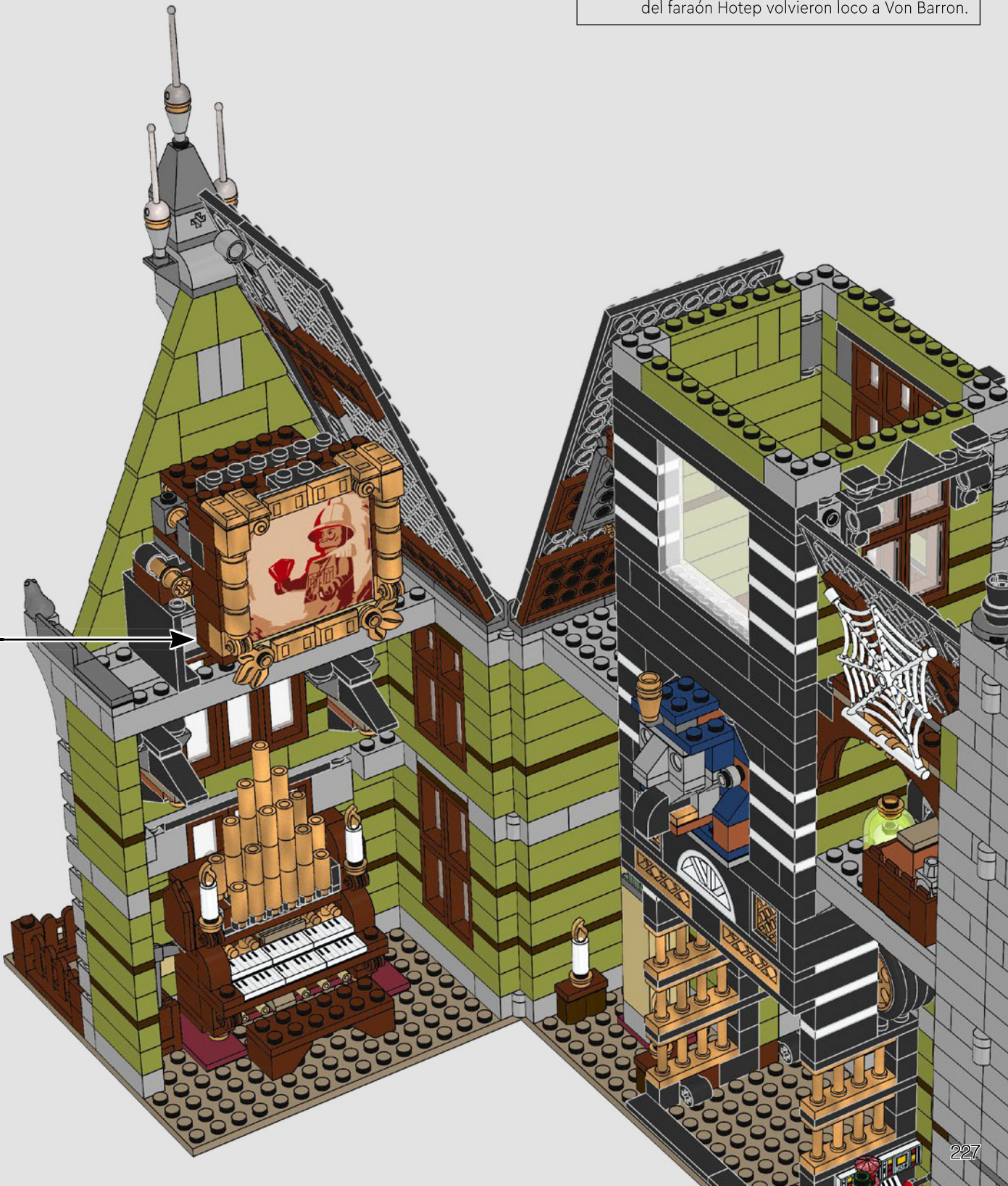

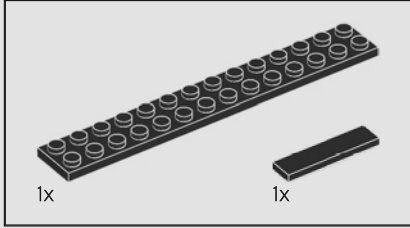
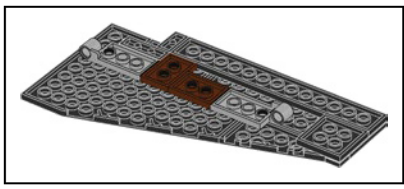

370

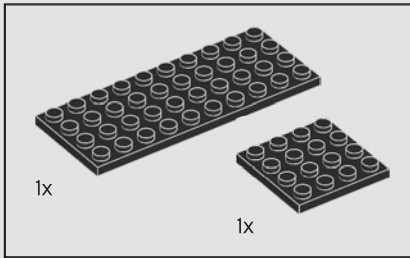
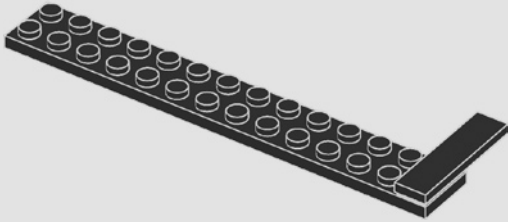

371

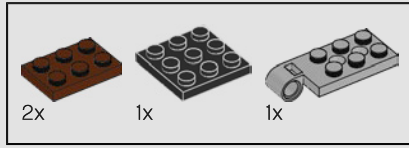
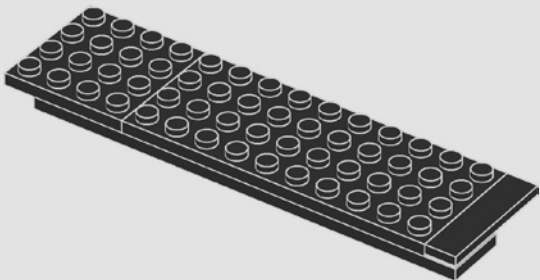

372

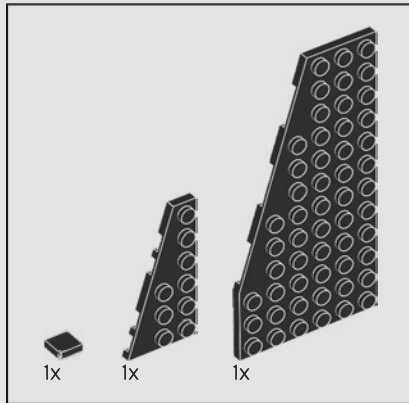
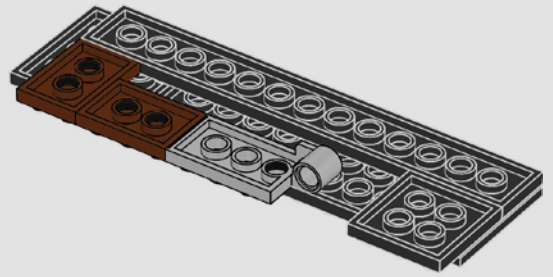

373

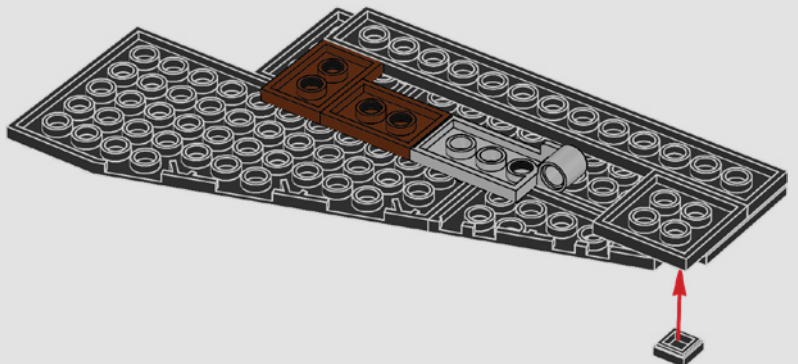

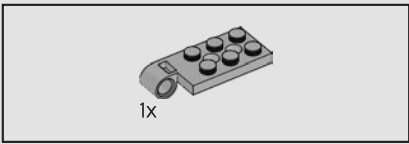

374

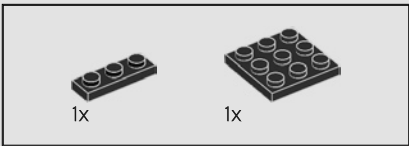
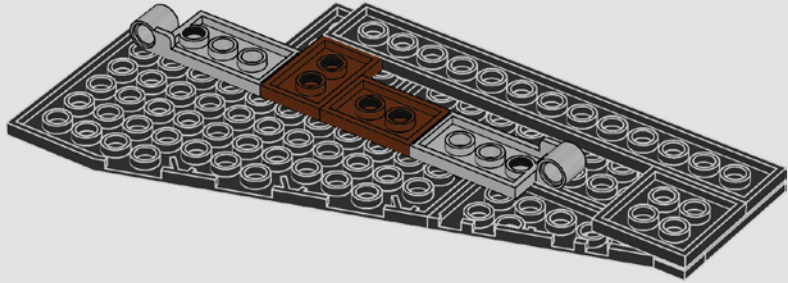

375

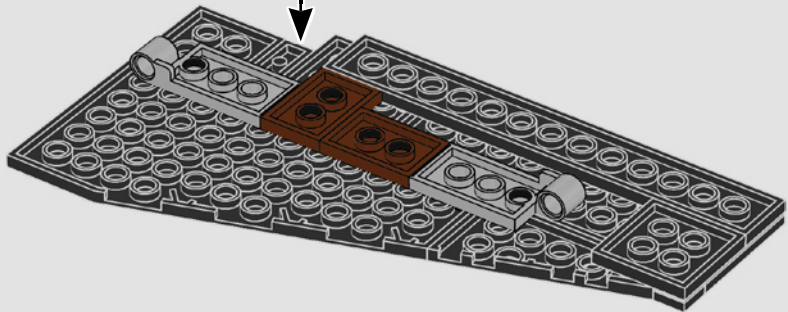
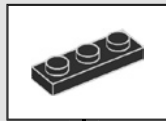

376

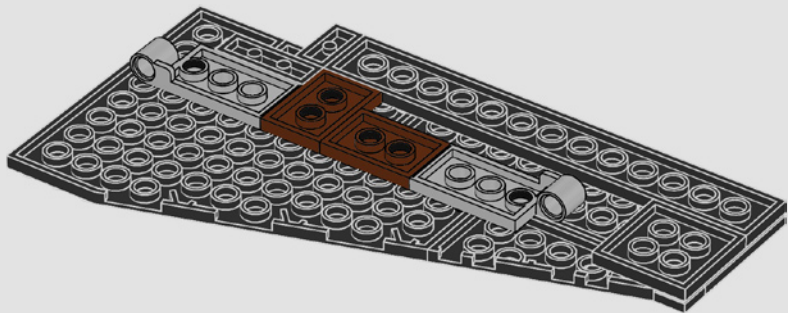

377

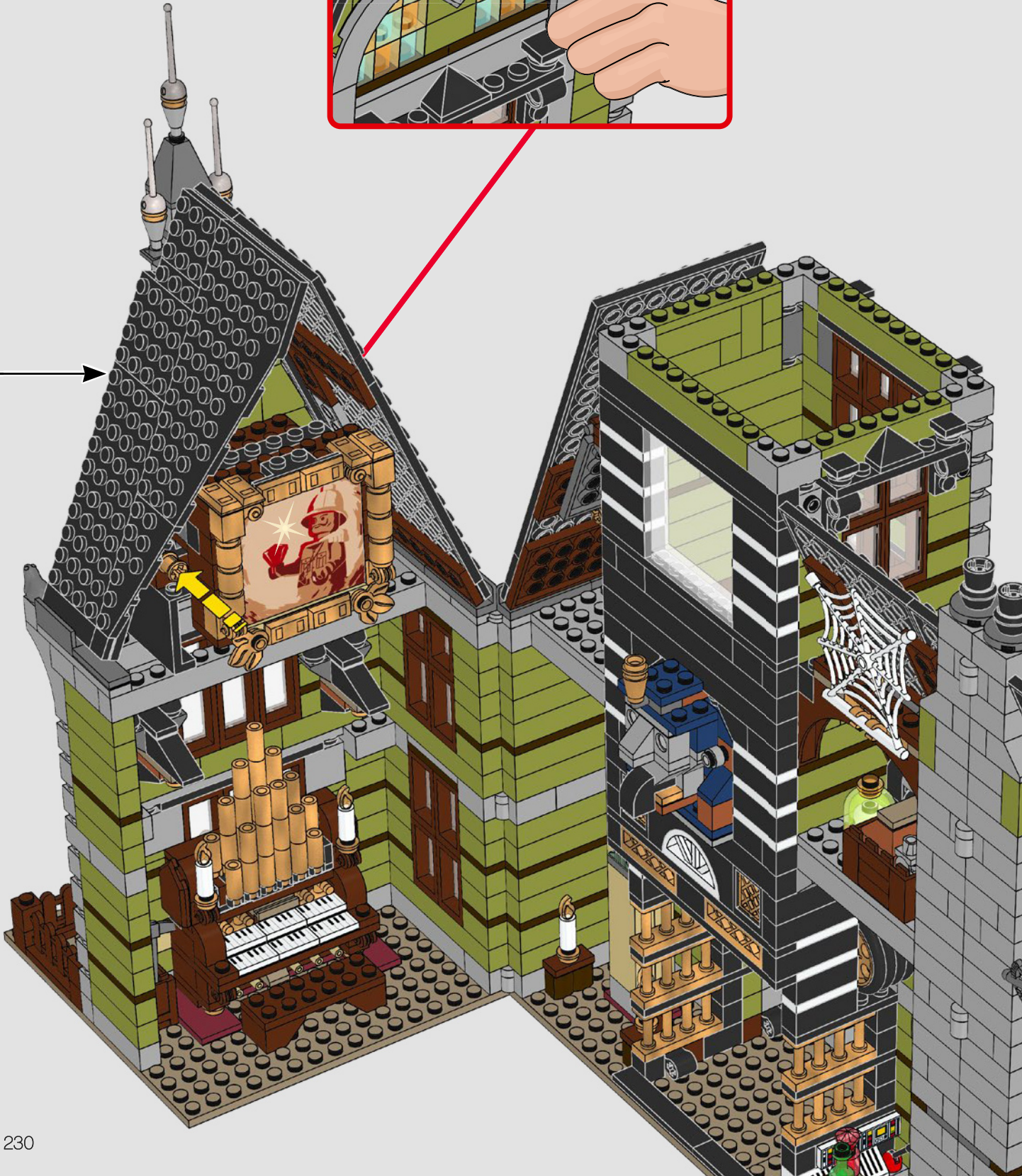
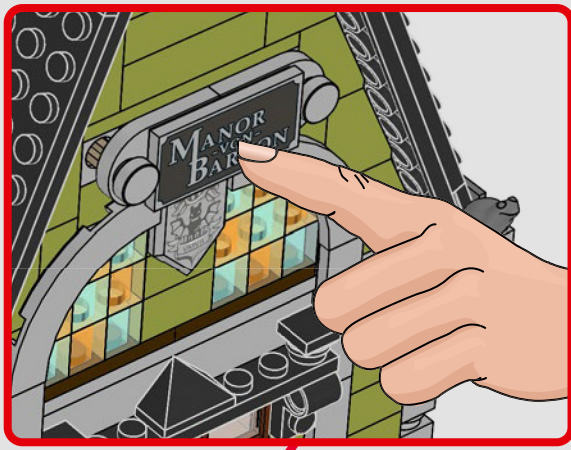

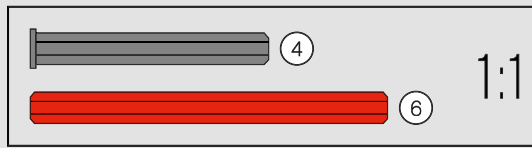
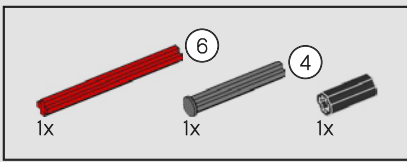

378

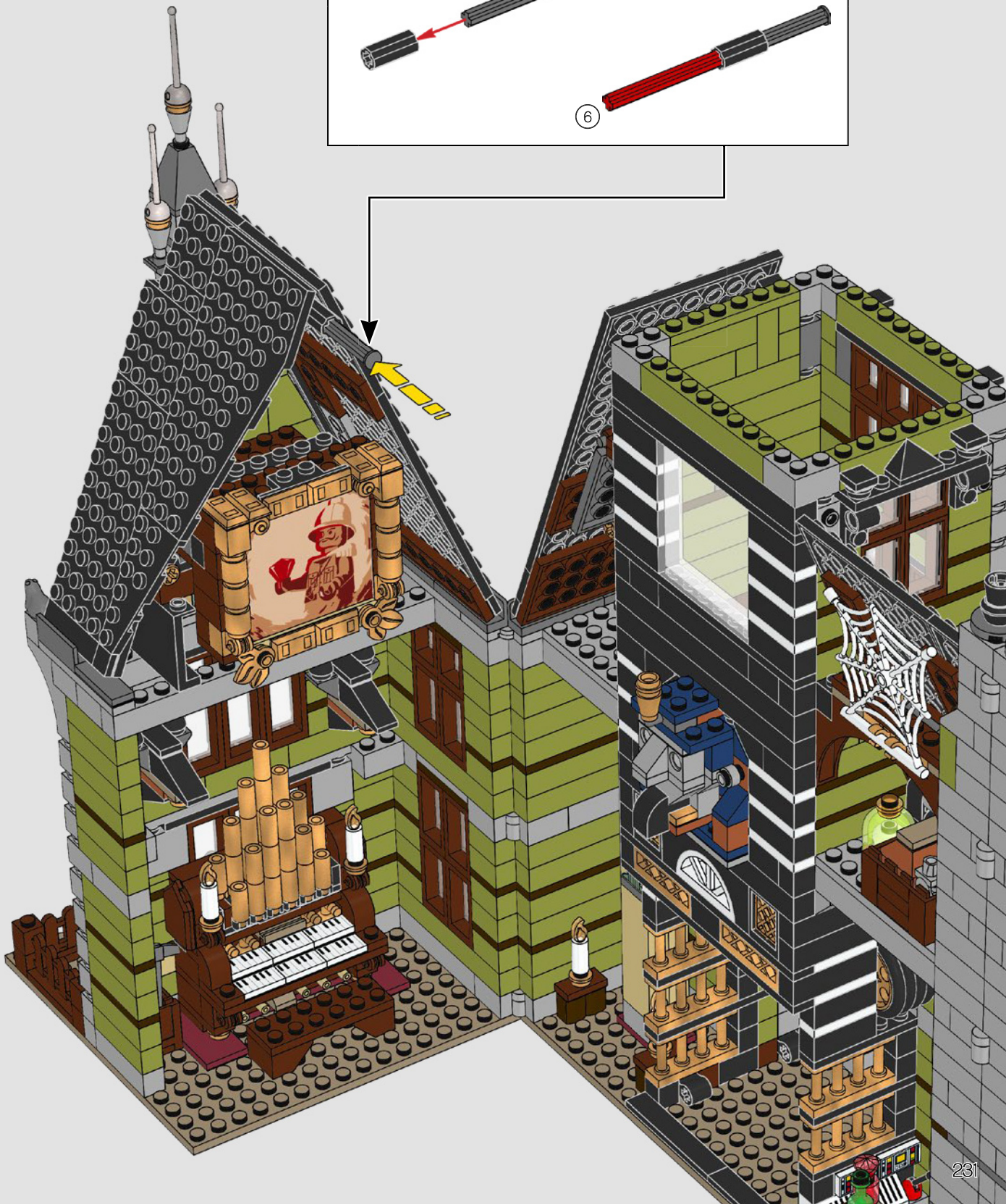
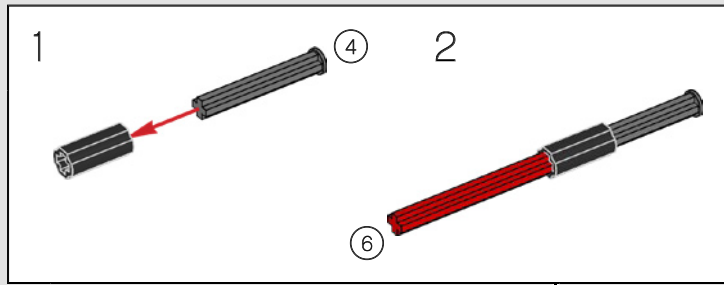

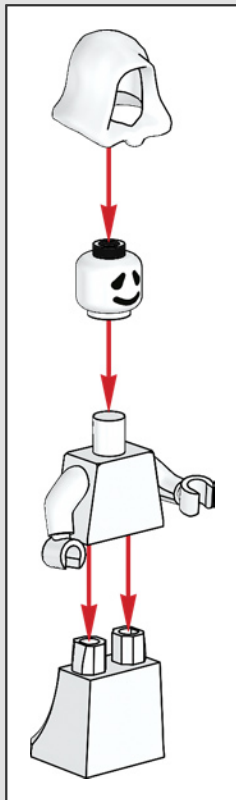
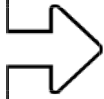

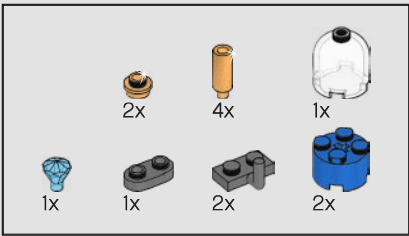

379

1

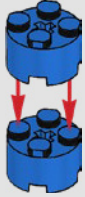

2

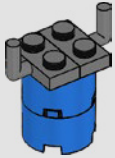

3

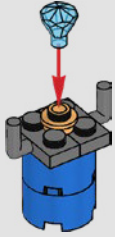

4



5

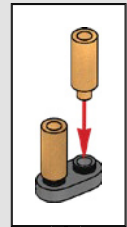

6



El Resonador

En un fallido intento por amplificar el poder del rubí Re-Gou mediante este dispositivo, Von Barron invocó accidentalmente a dos simpáticos espíritus del más allá.



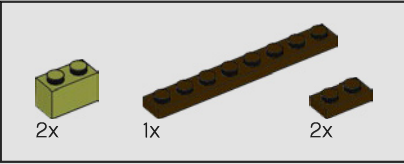
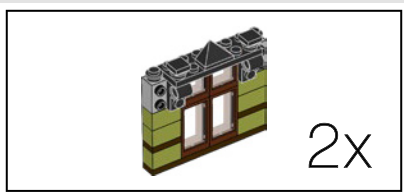

380

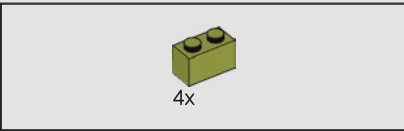
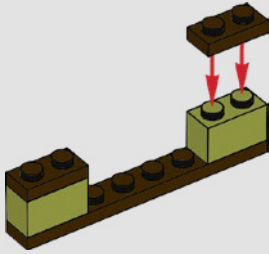

381

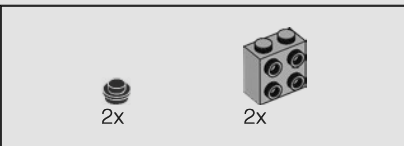
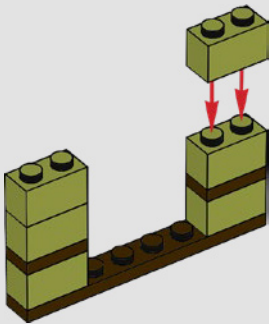

382

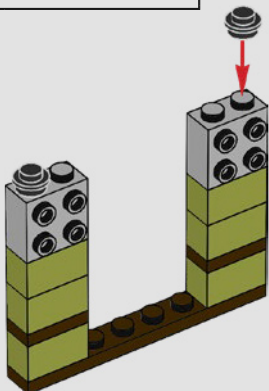

383

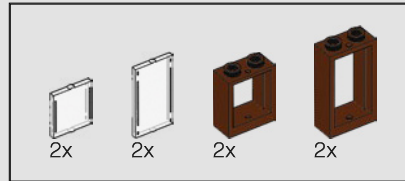
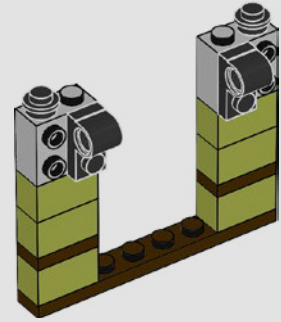

384

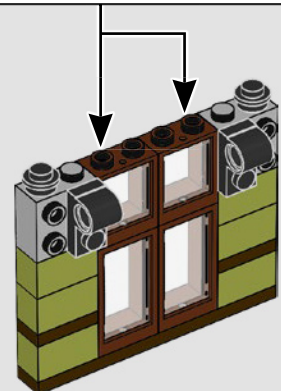
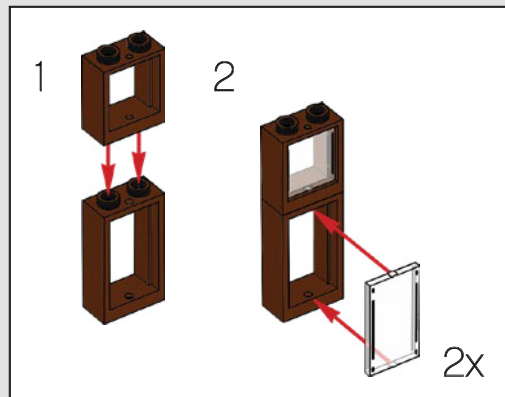

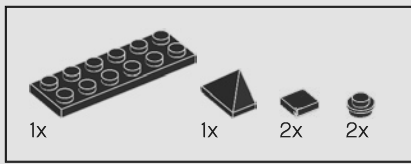

385

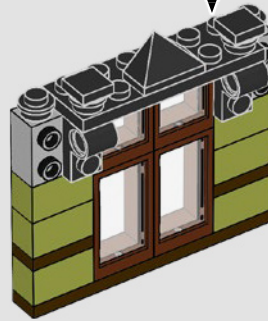
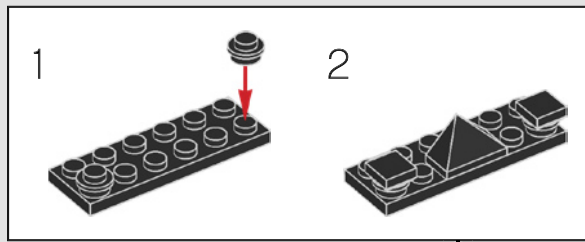

2x

386



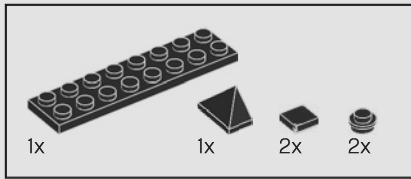

392

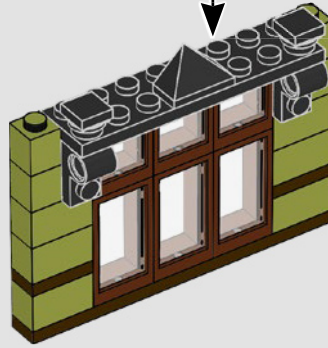
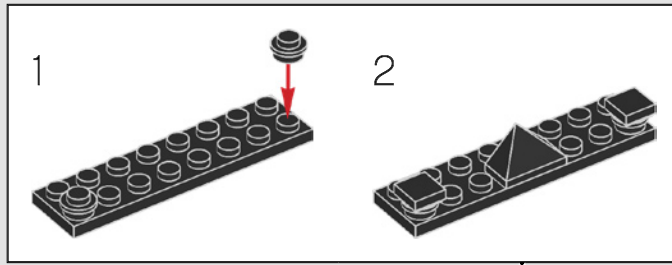

2x

393



20x

16x

394

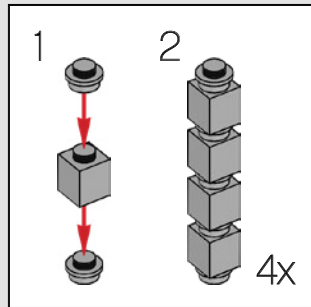

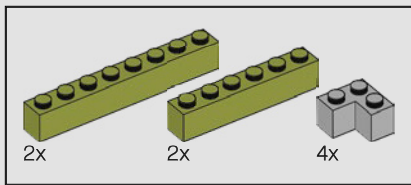

395

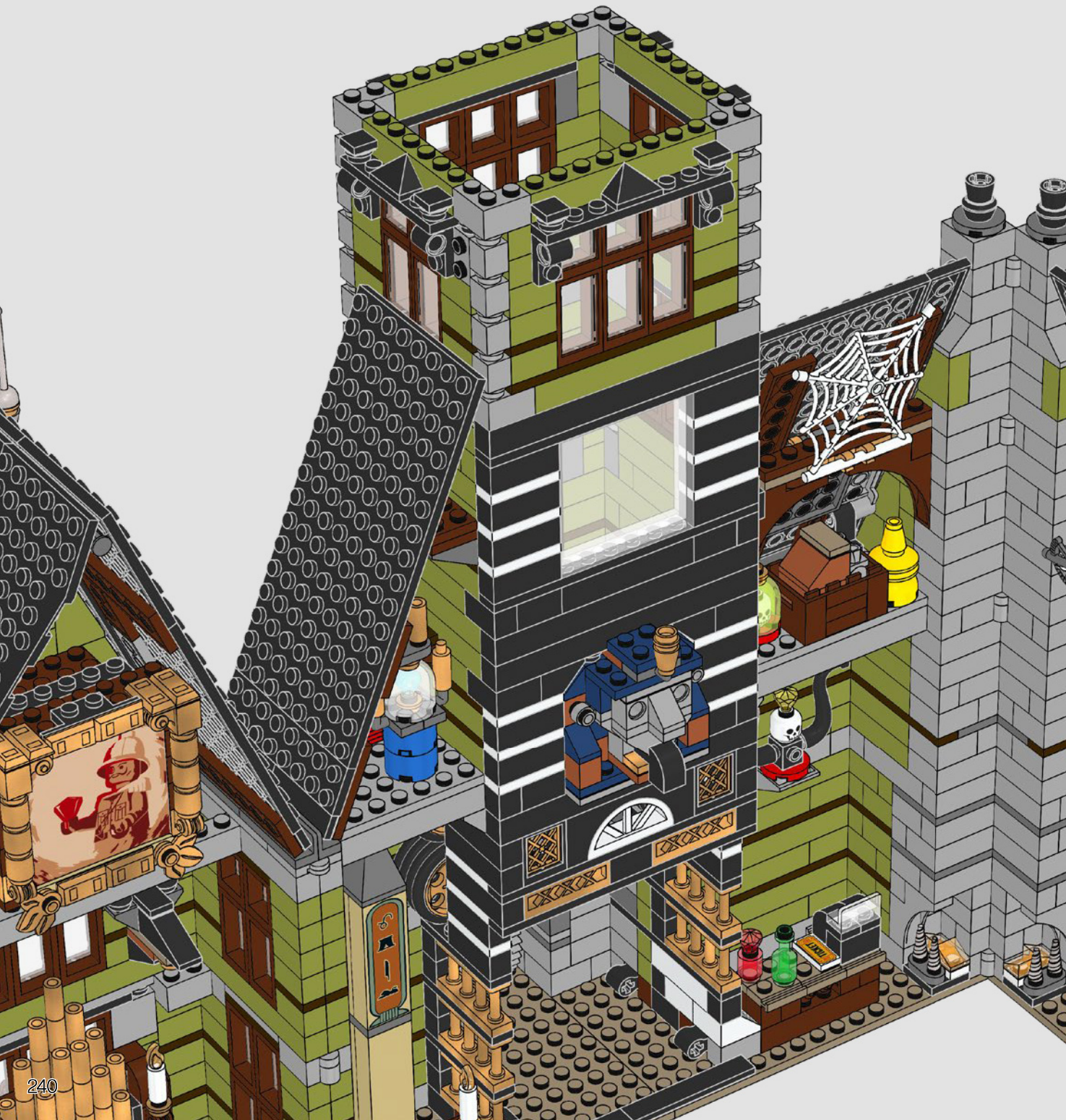



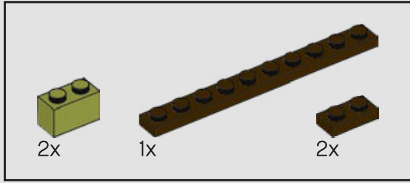
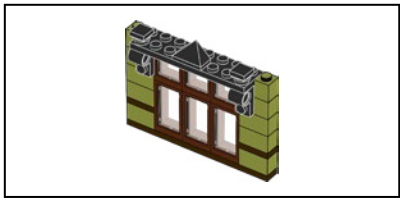

396

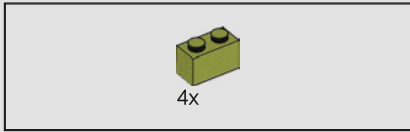
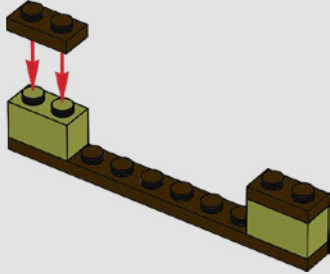

397

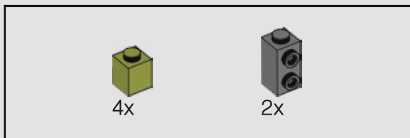
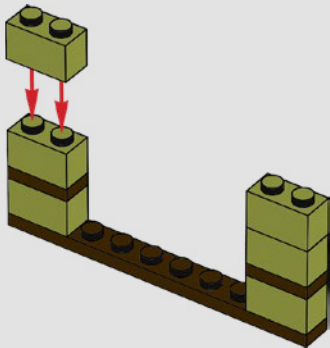

398

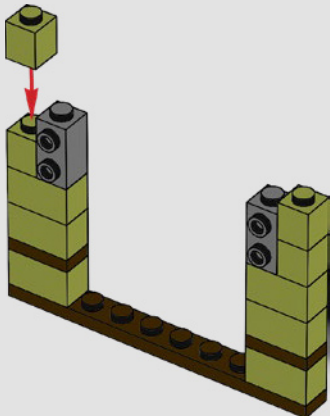

399

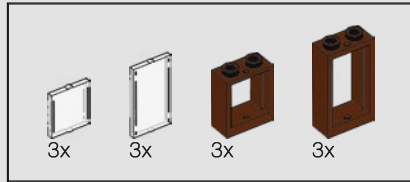
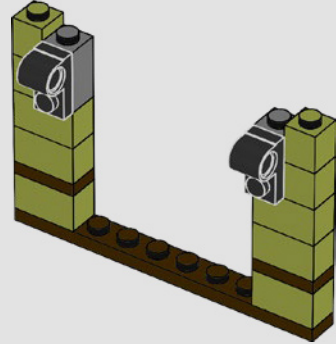

400

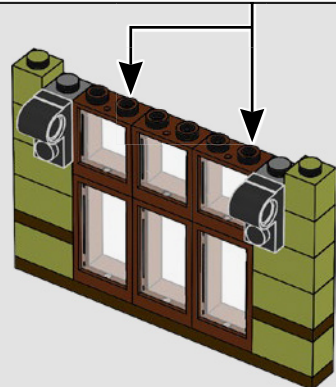
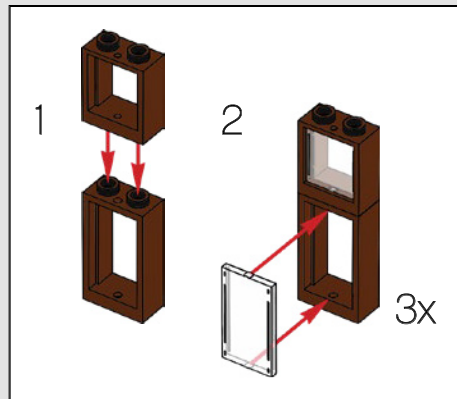

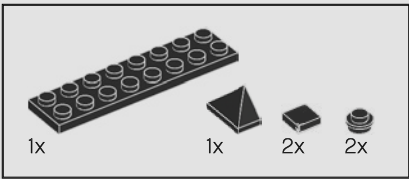

401

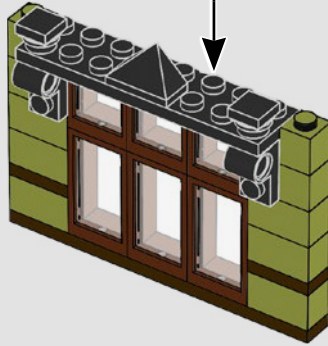
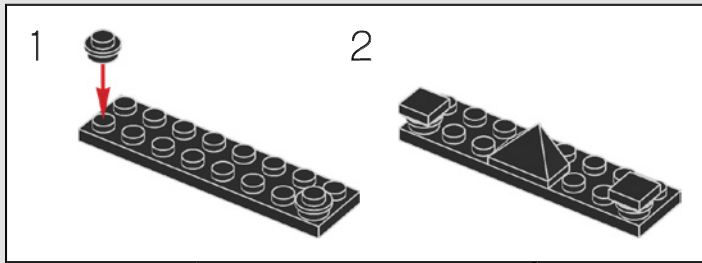

402

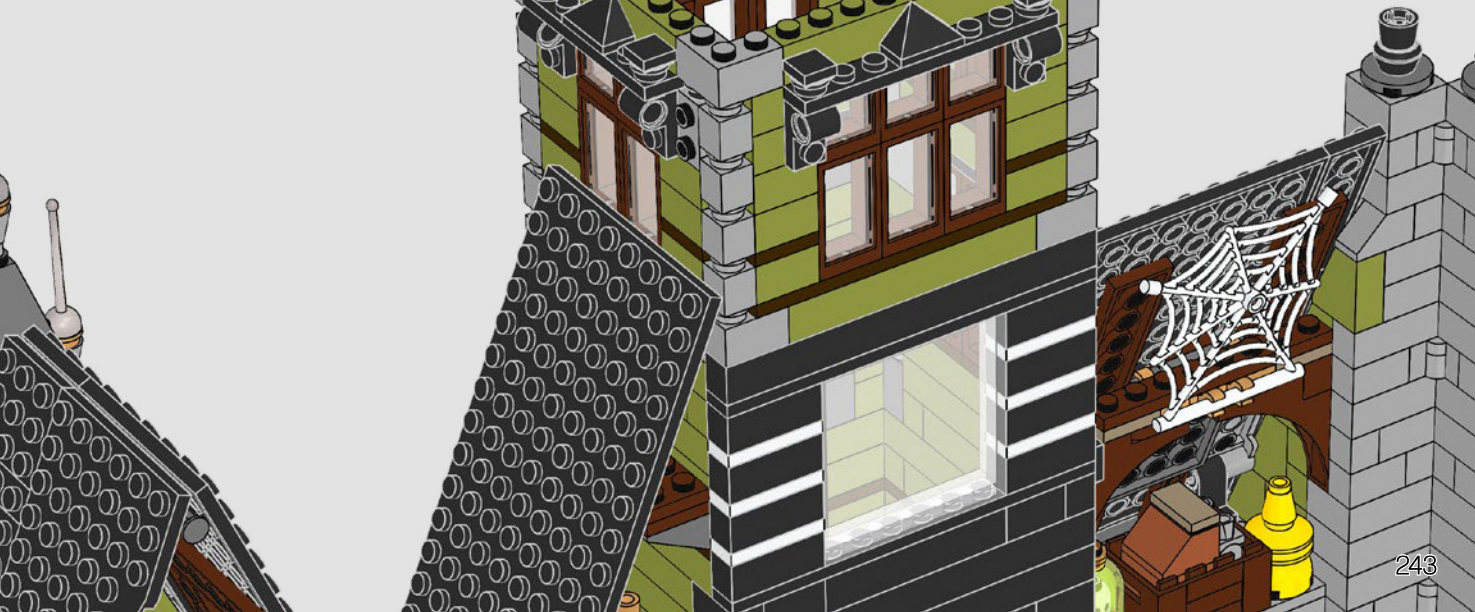
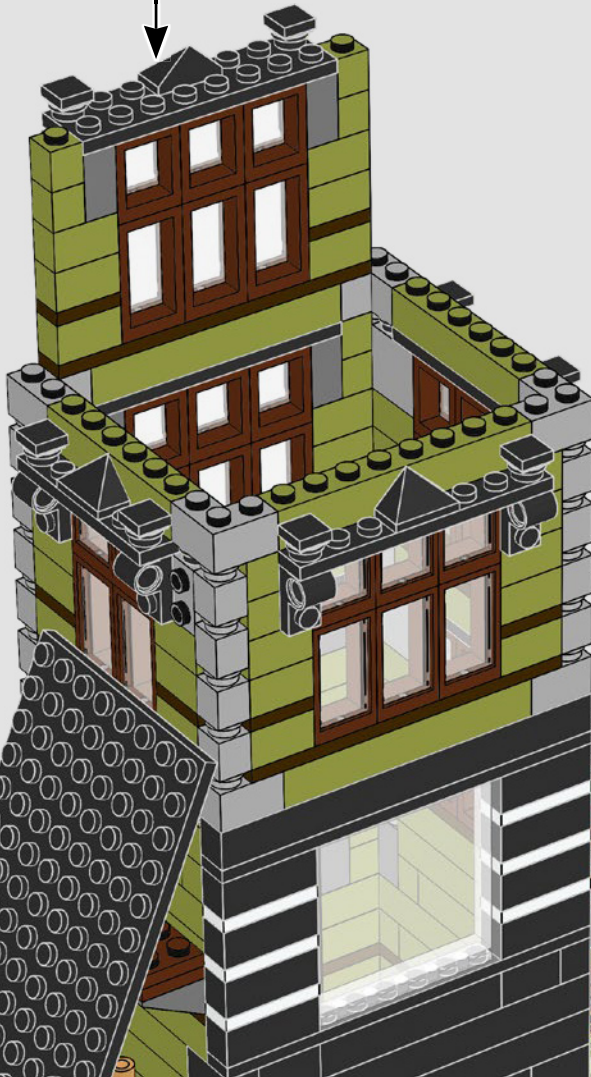



403

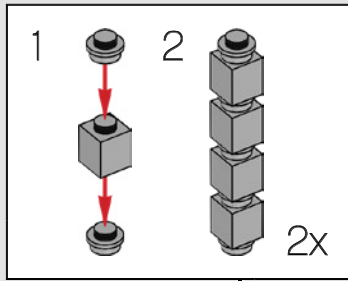

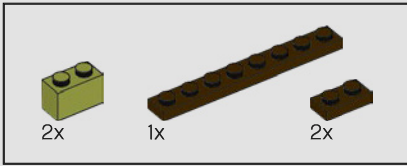
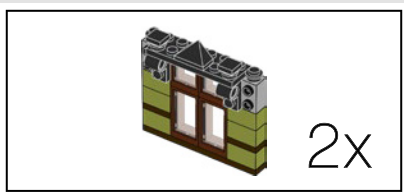

404

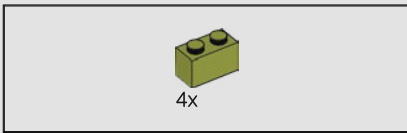
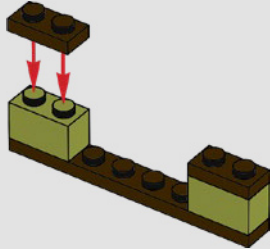

405

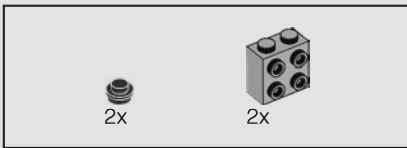
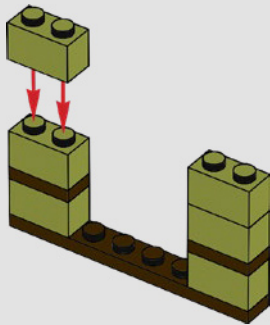

406

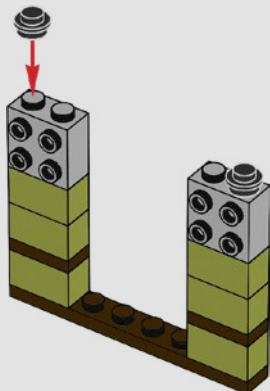

407

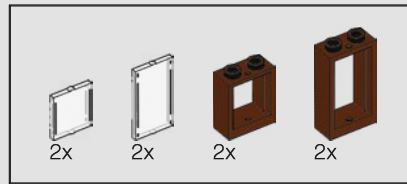
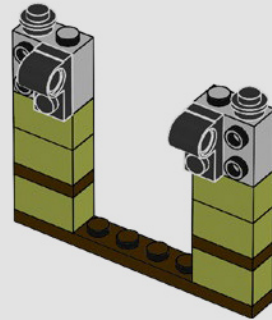

408

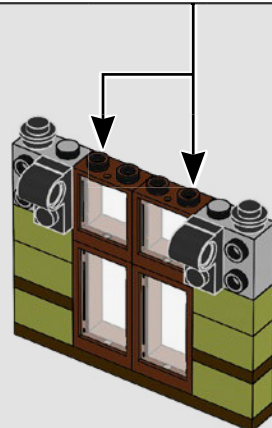
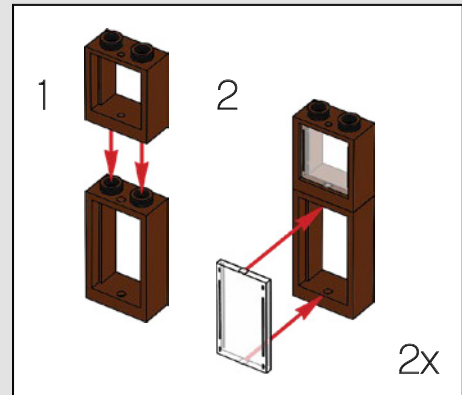

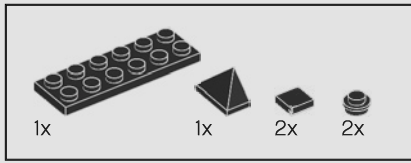

409

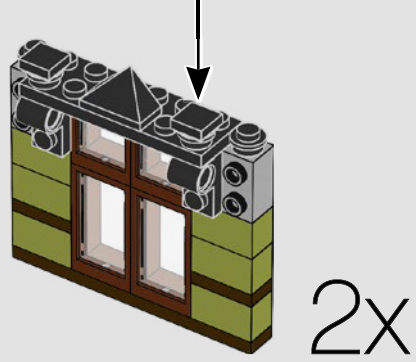
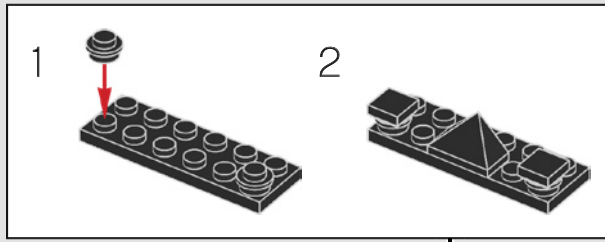

410



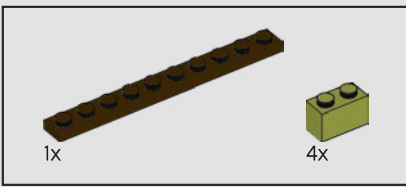

411

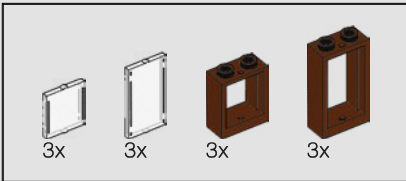
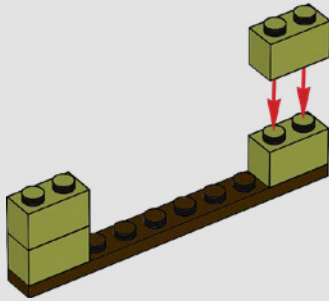

412

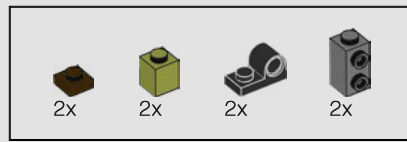
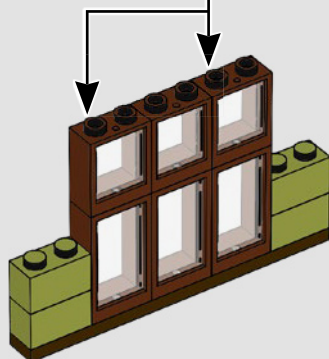
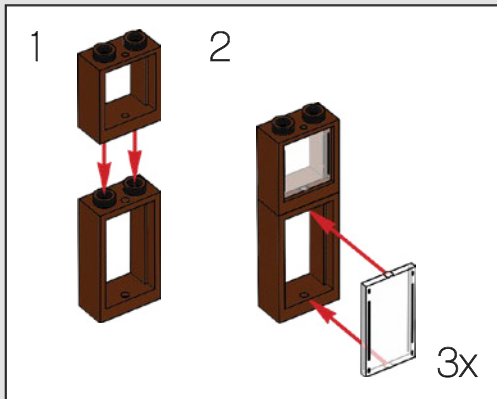

413

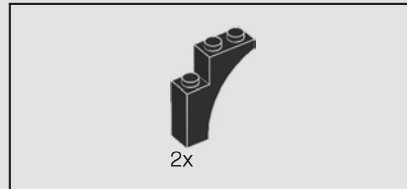
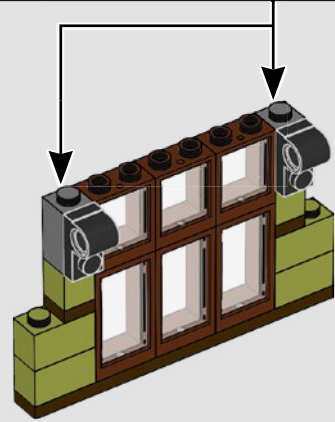
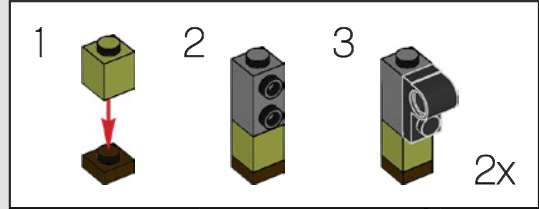

414

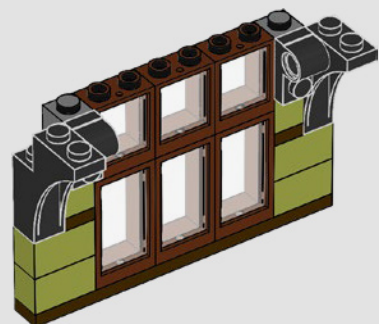



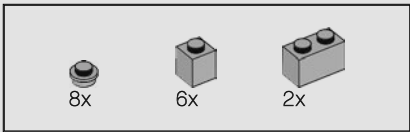

416

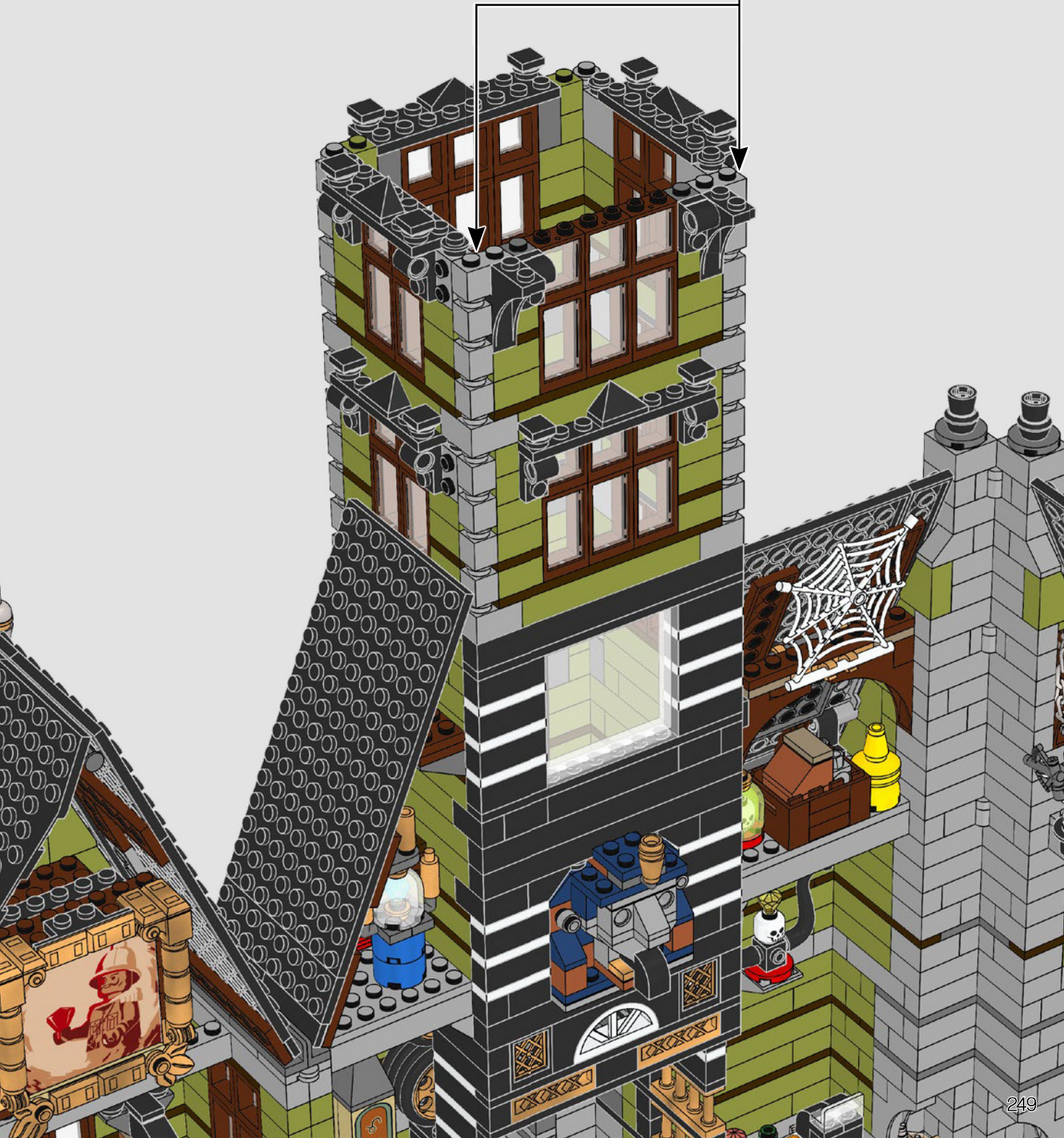
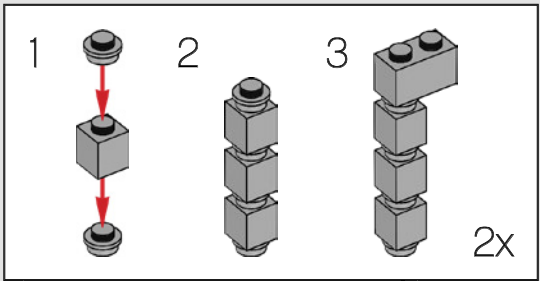

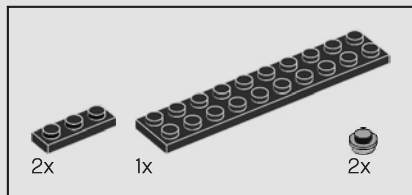

417



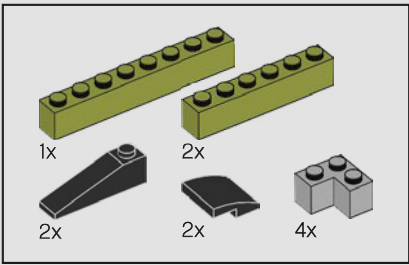

418



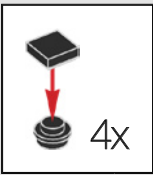

419

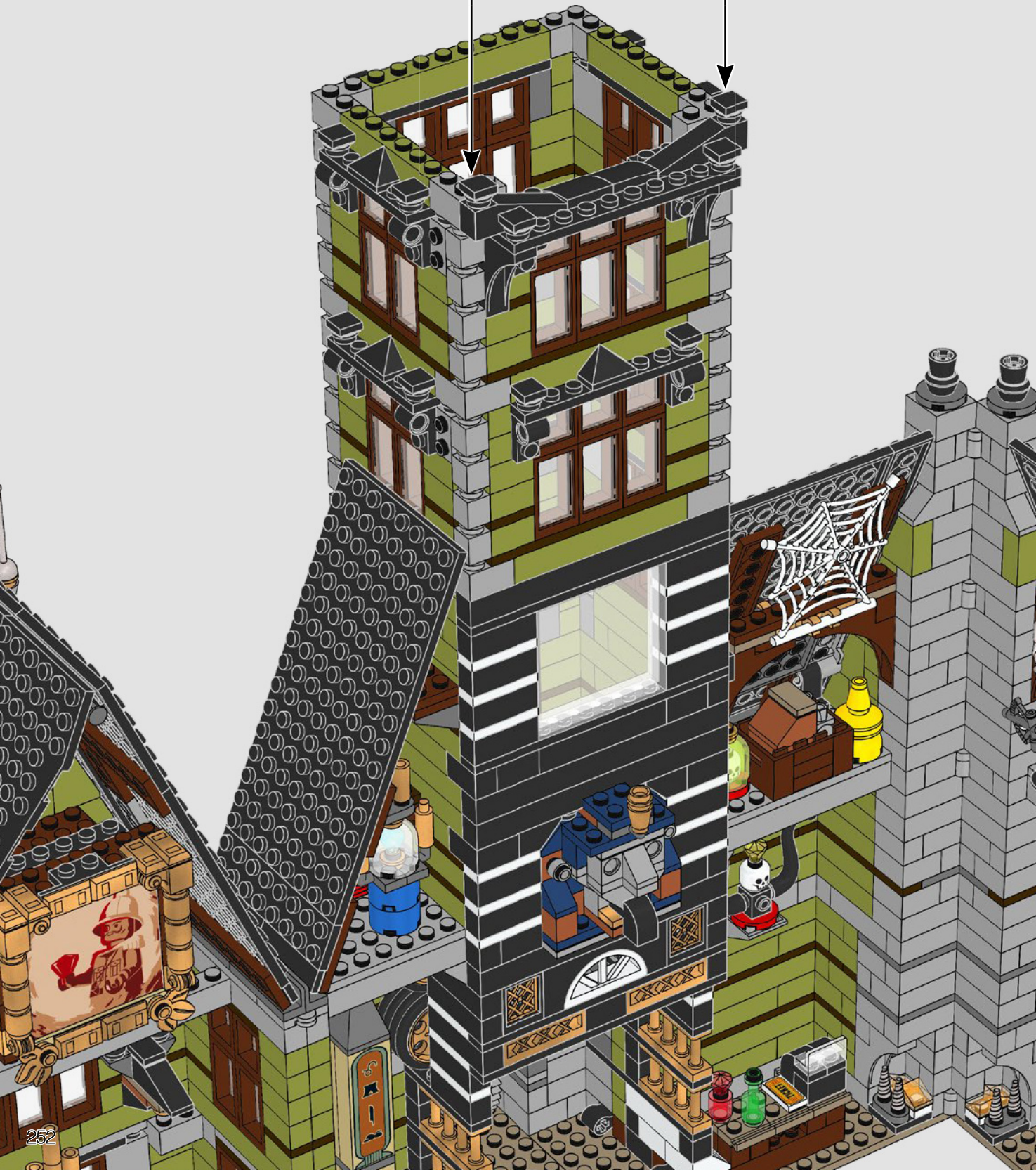



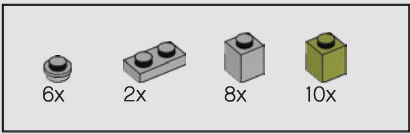

420

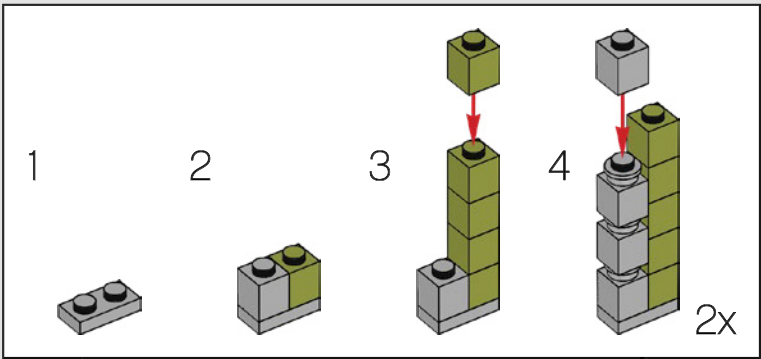

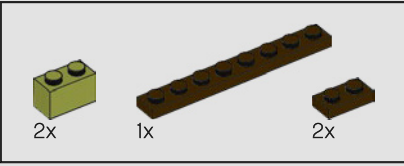
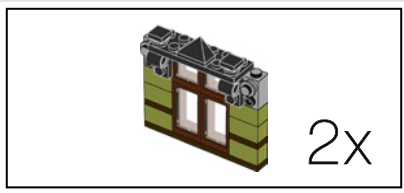

421

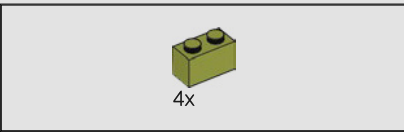
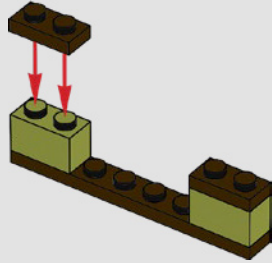

422

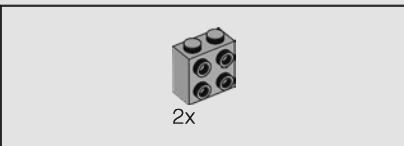
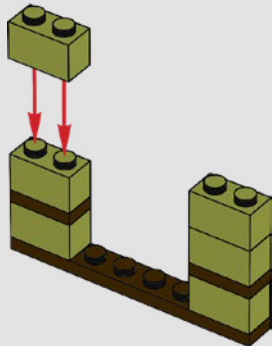

423

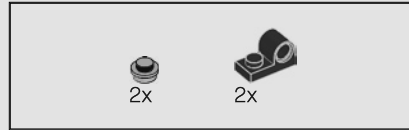
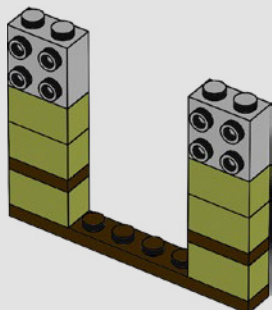

424

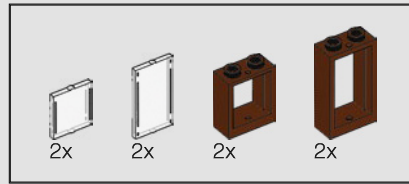
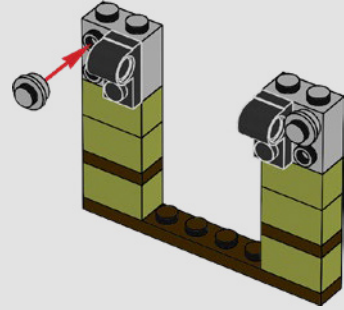

425

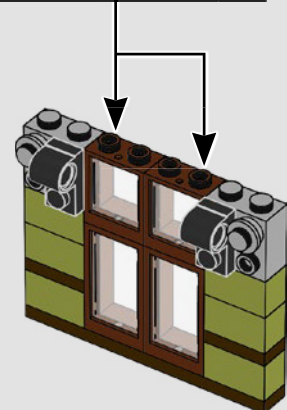
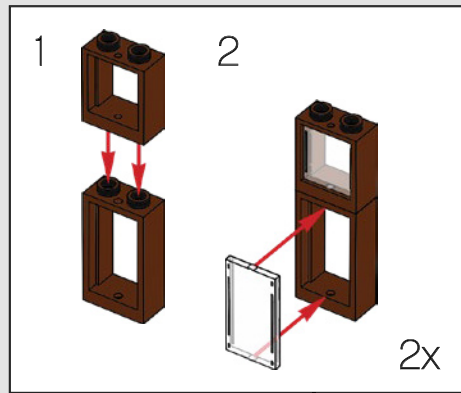

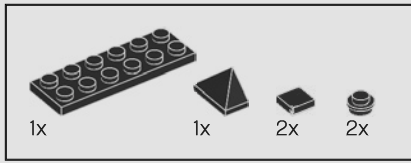

426

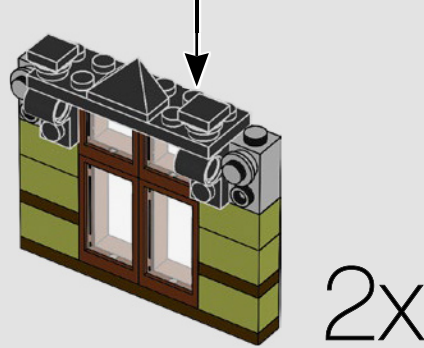
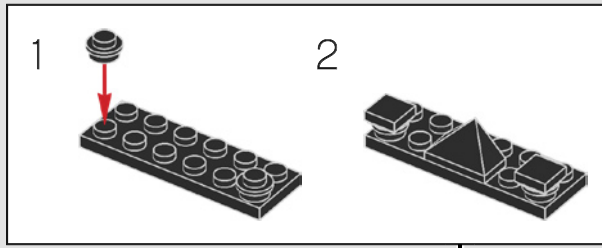

427

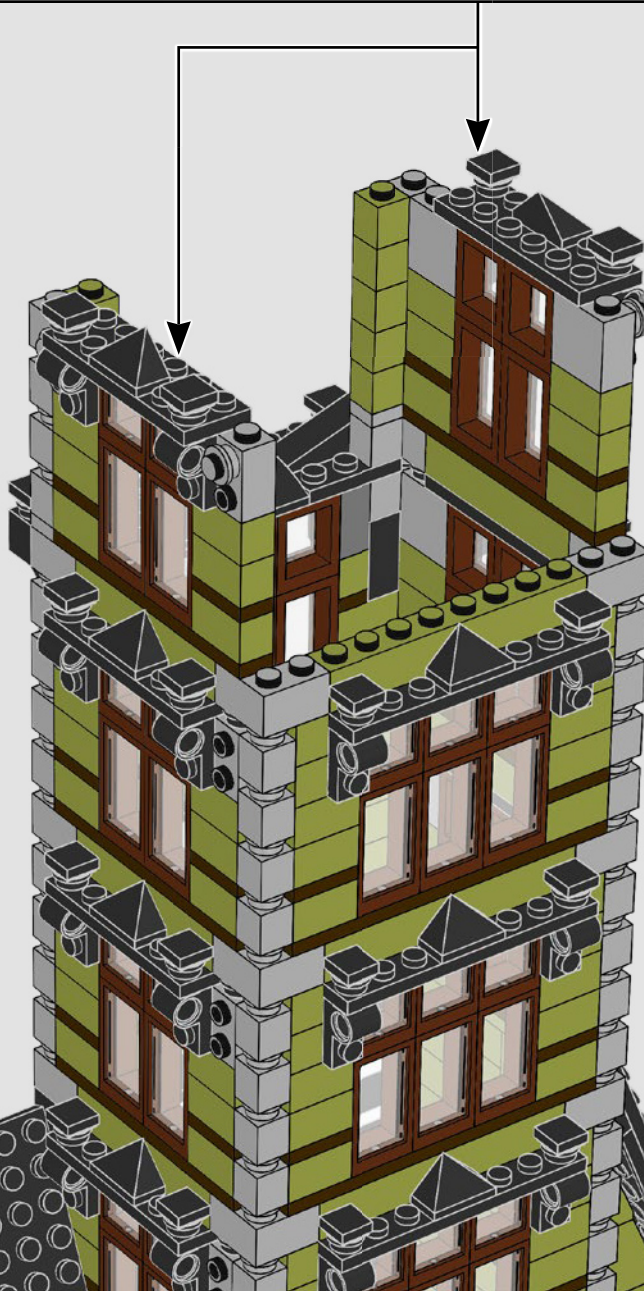

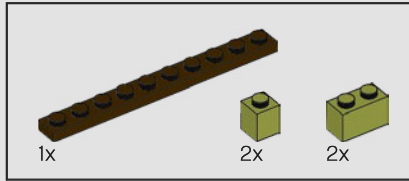
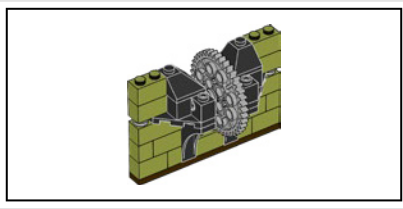

428

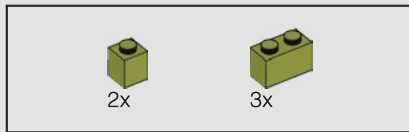
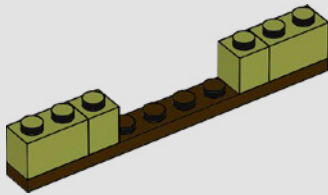

429

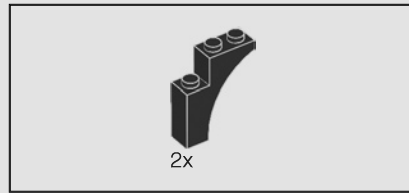
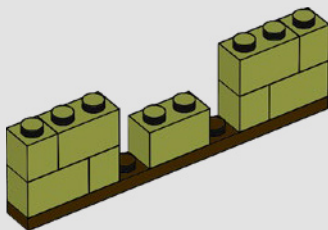

430

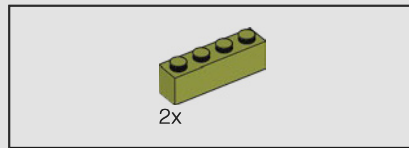
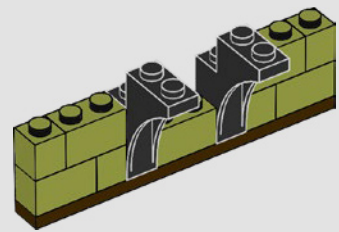

431

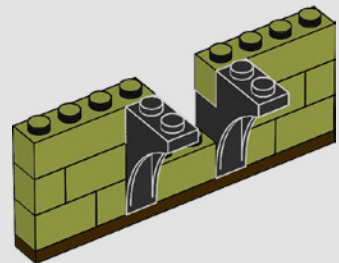



432

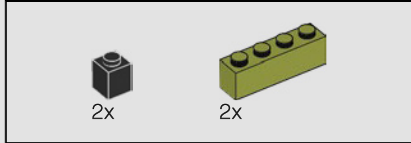
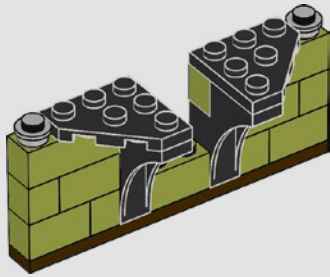

433

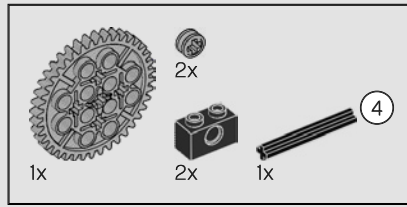
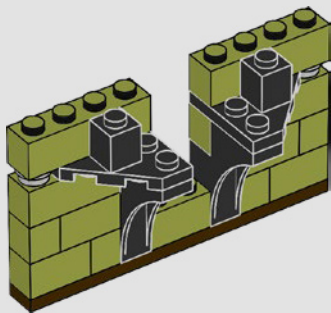

434

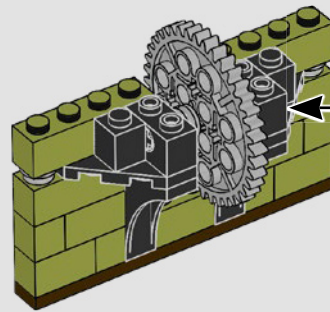
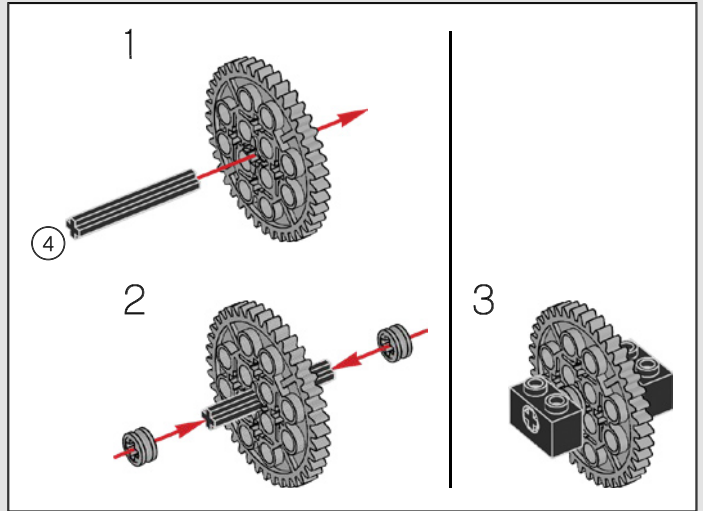

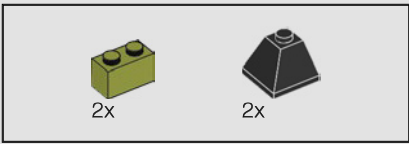

435

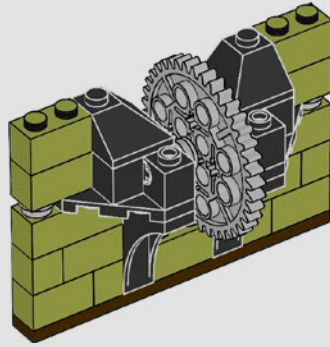

436



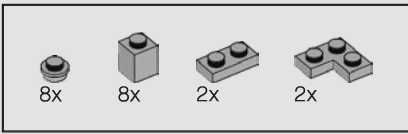

437

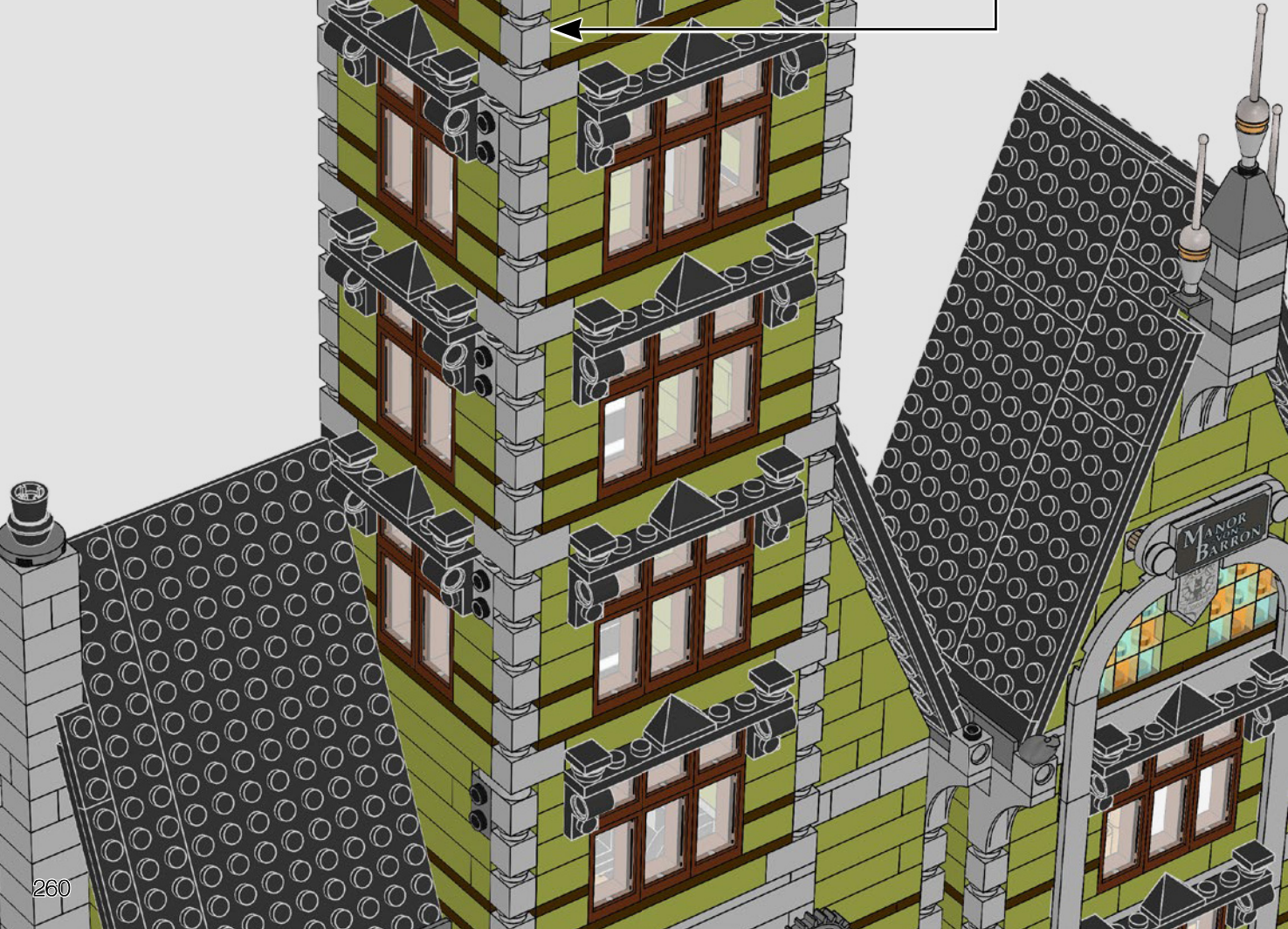
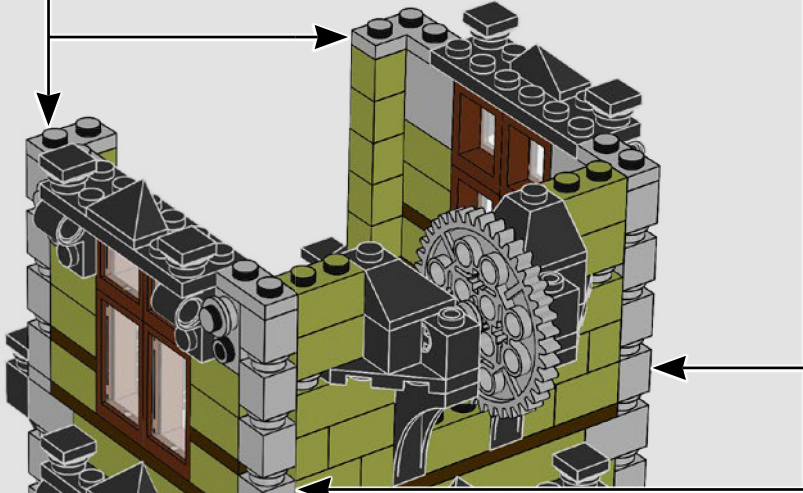
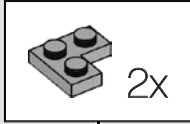
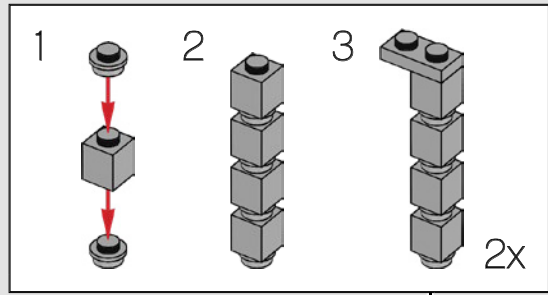

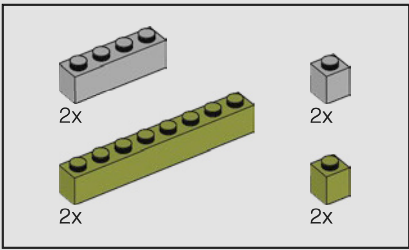

438

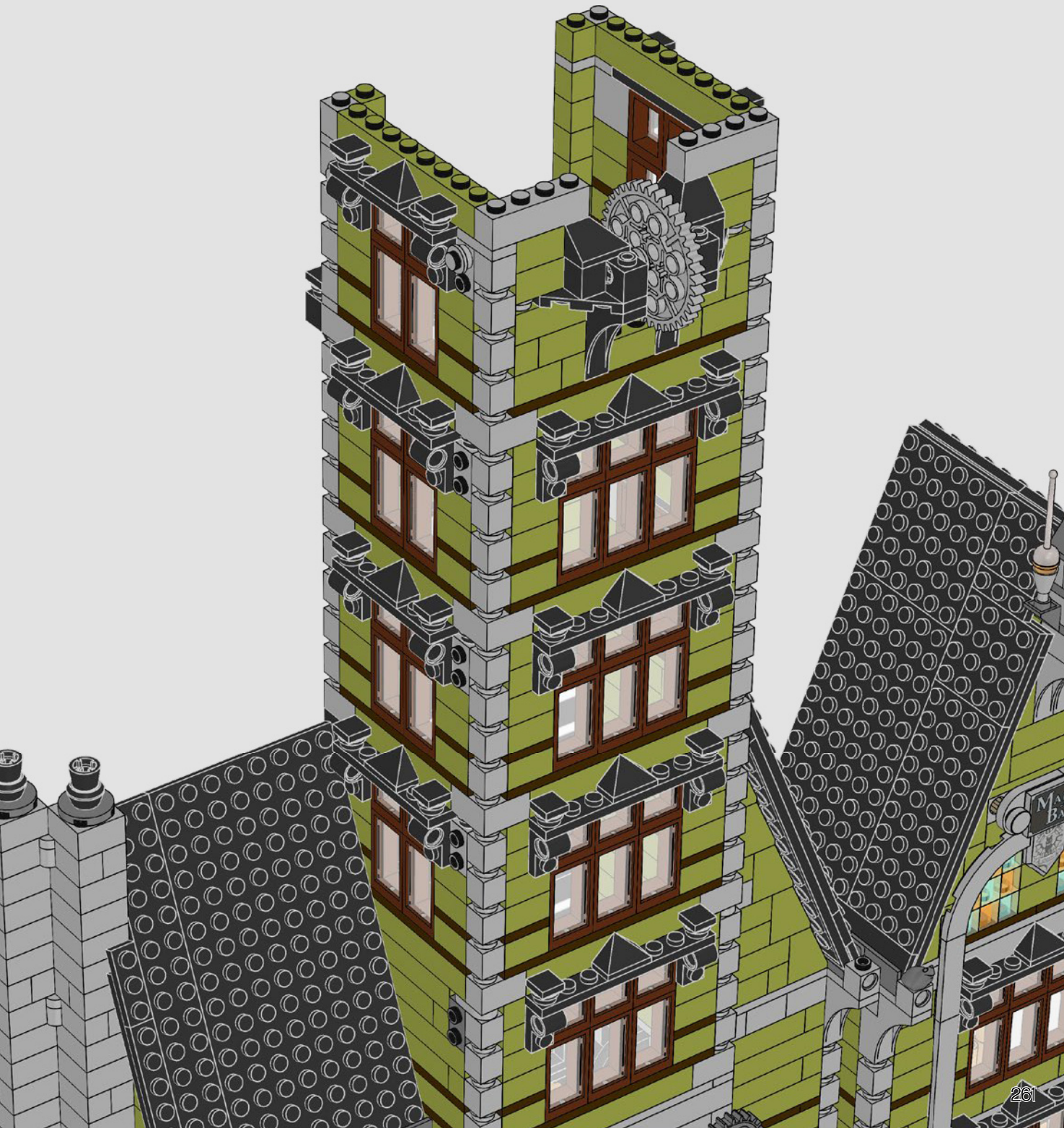

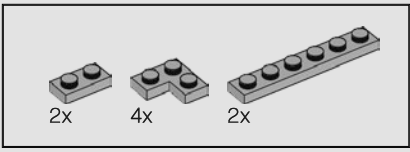

439

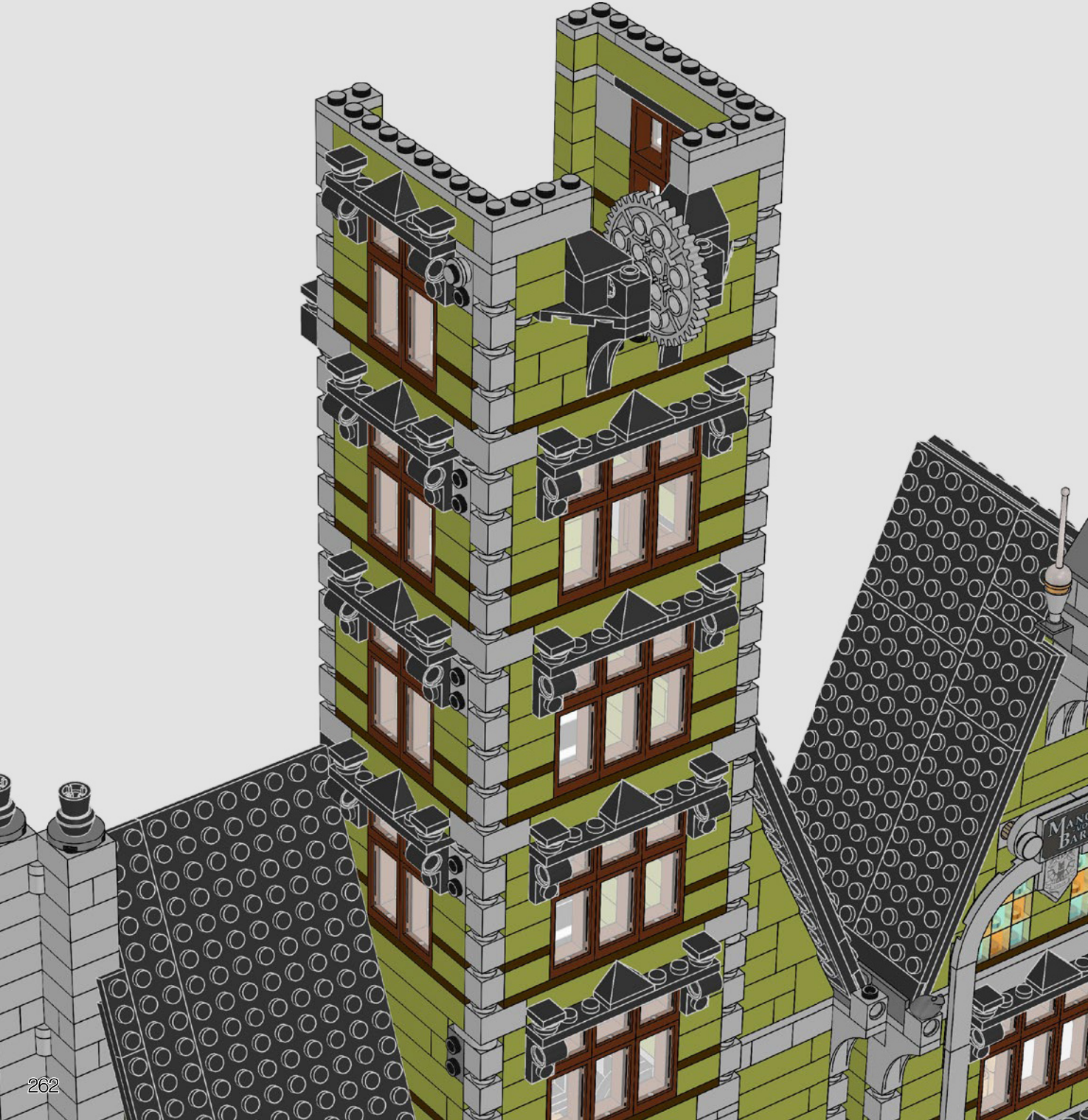

149x



2x

440

1



74x

2

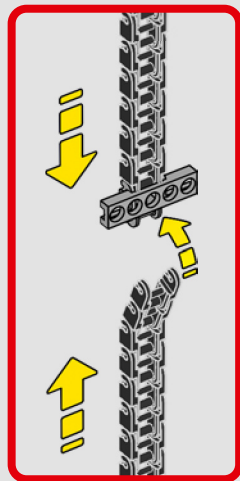
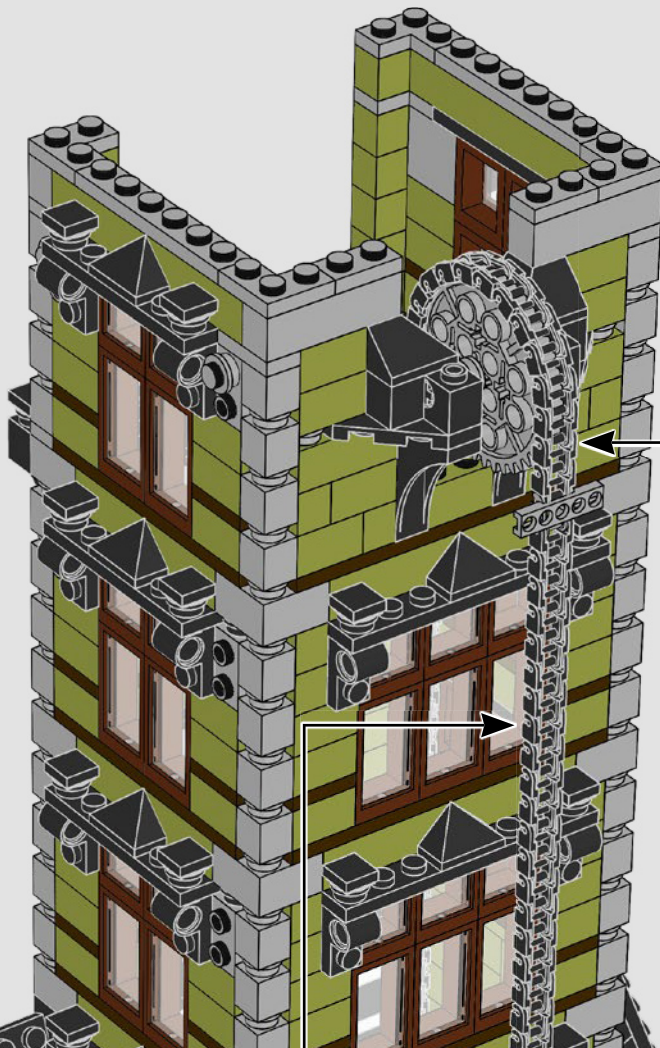
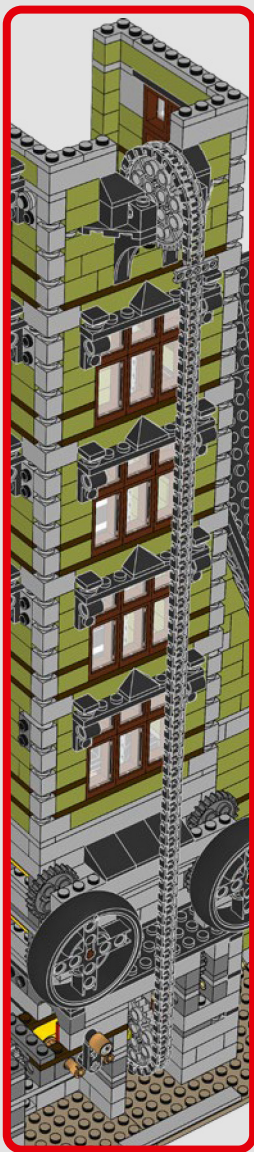
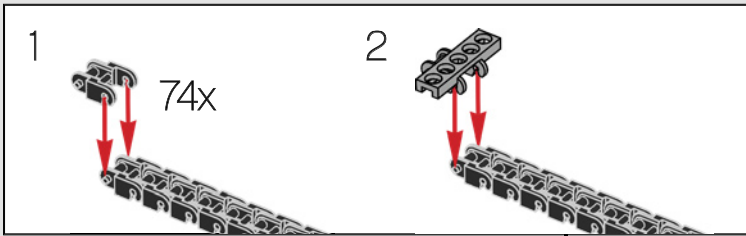

1



75x

2

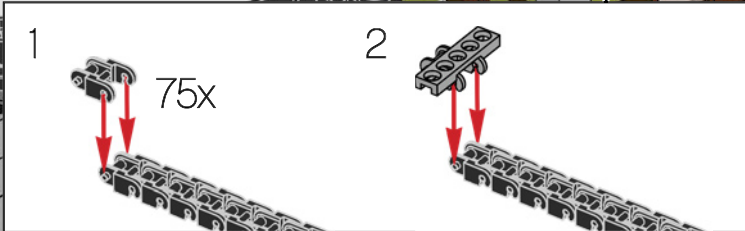

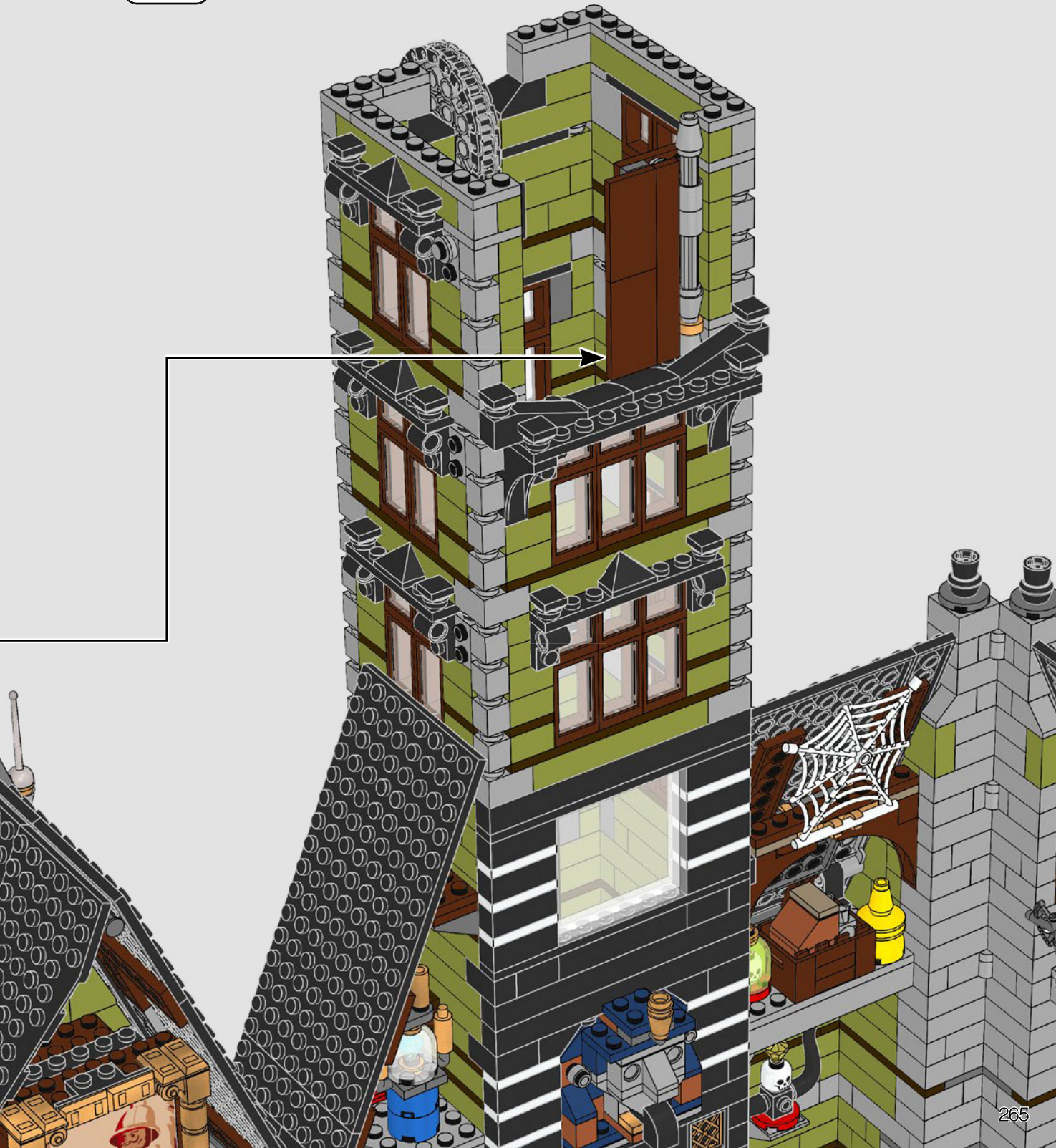

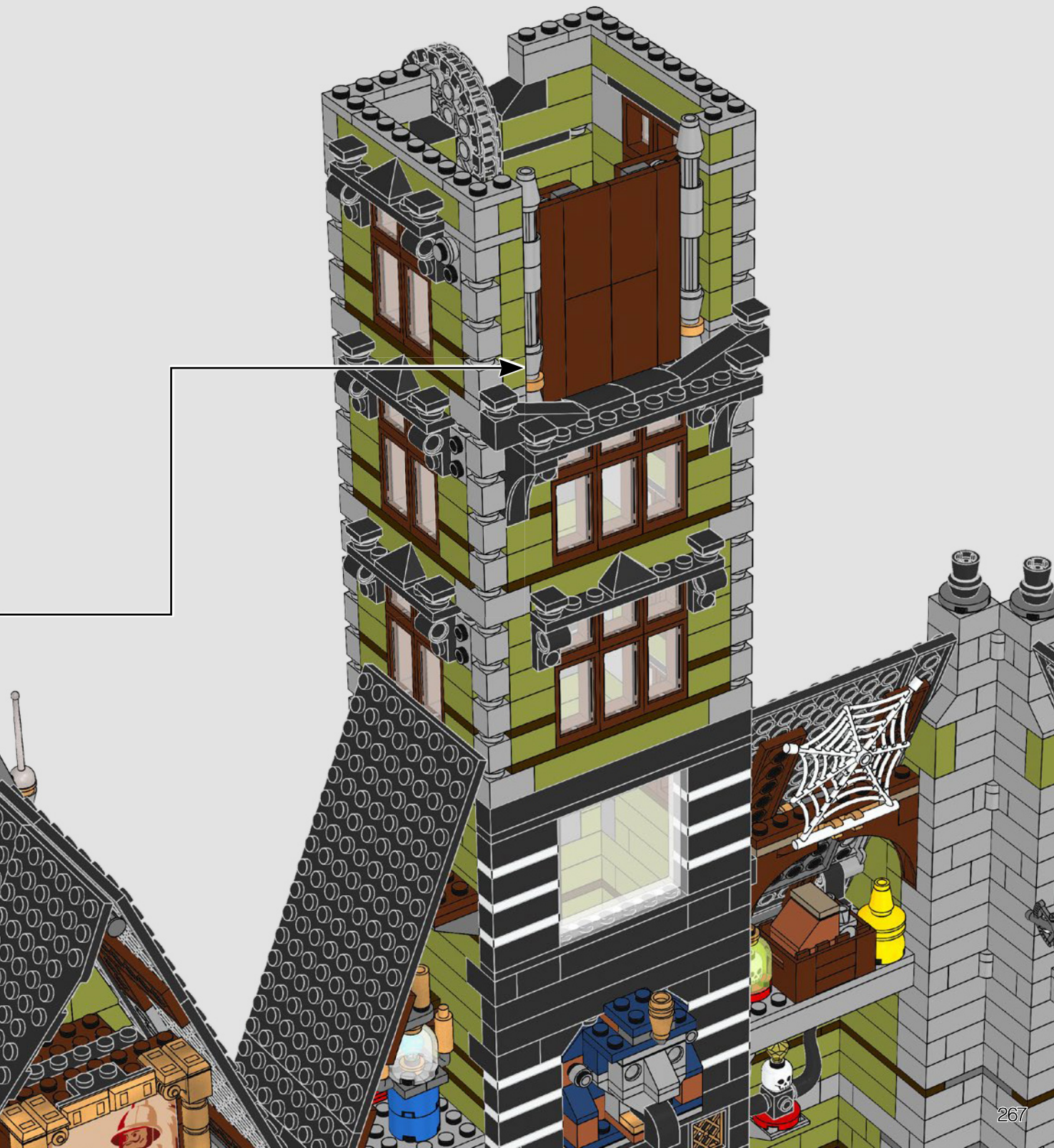



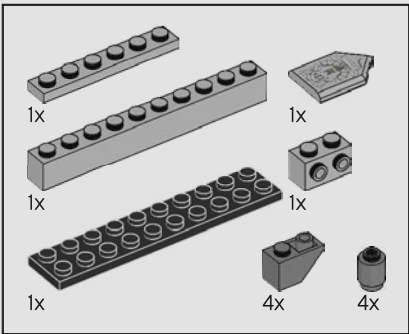

443

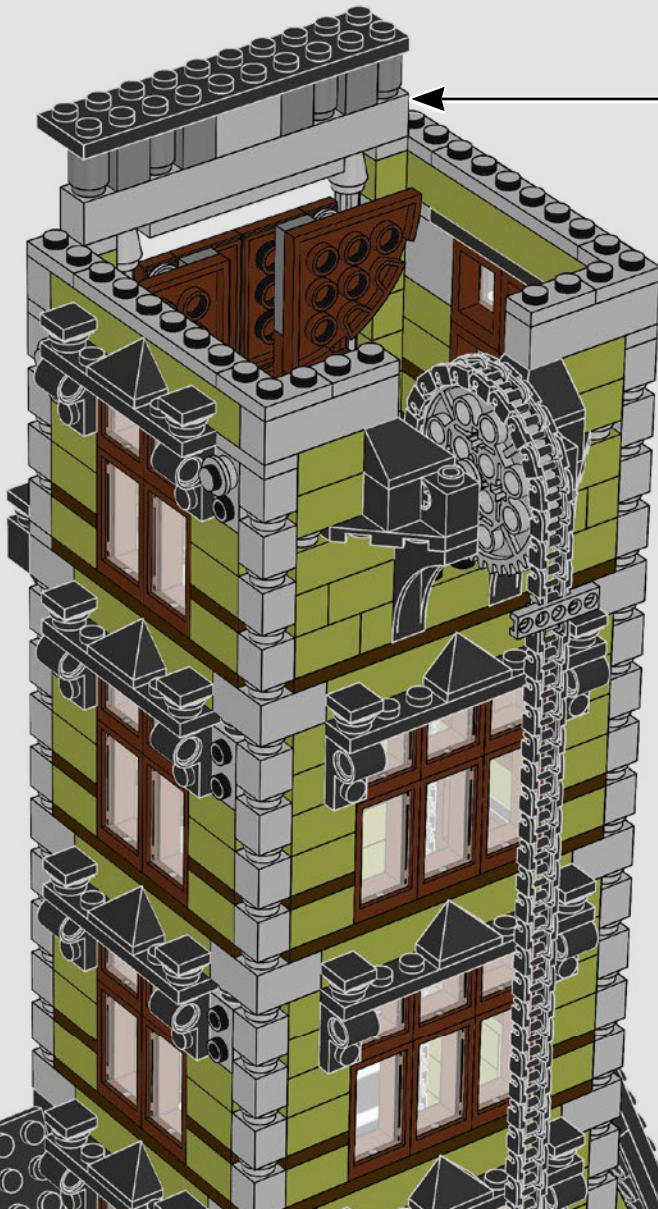
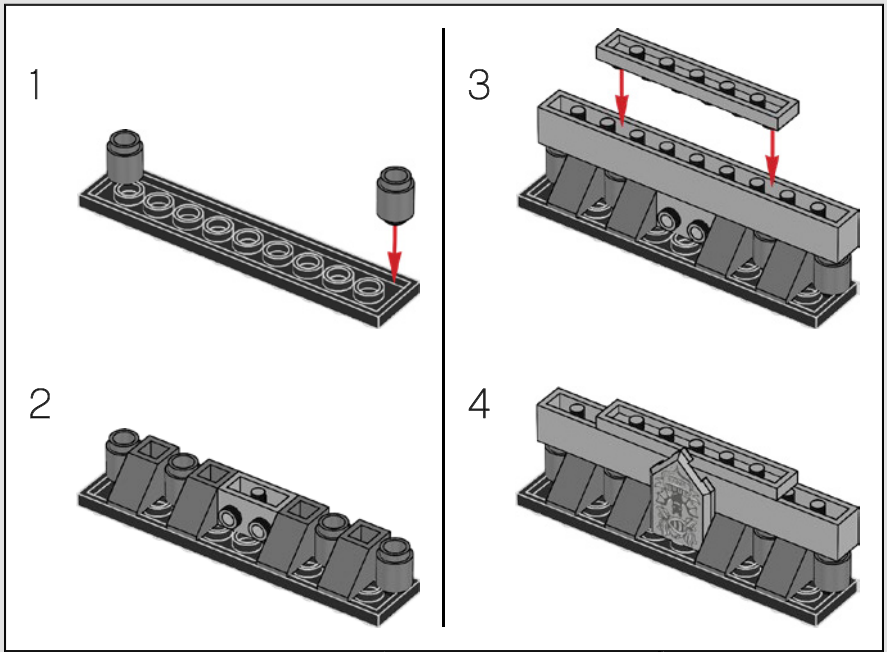

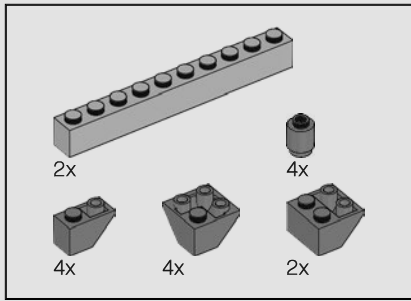

444

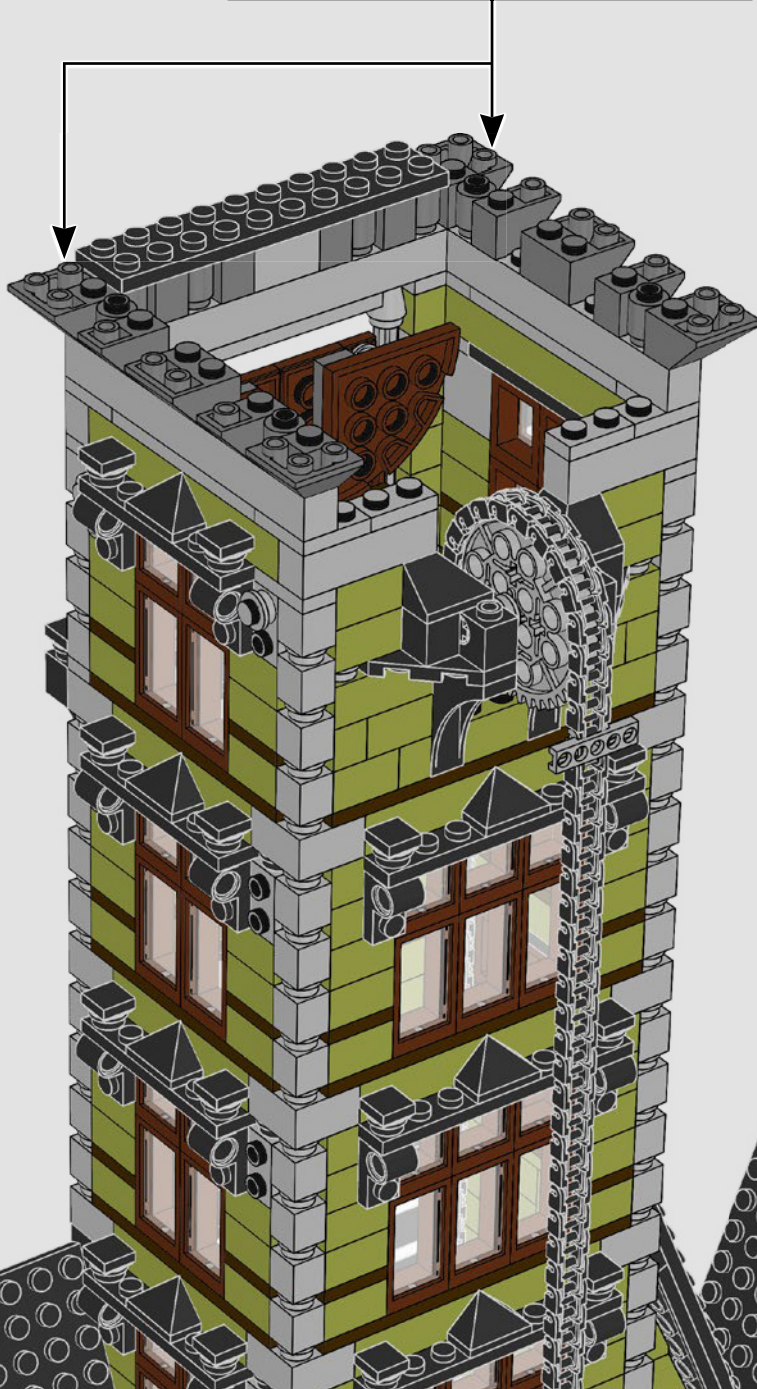
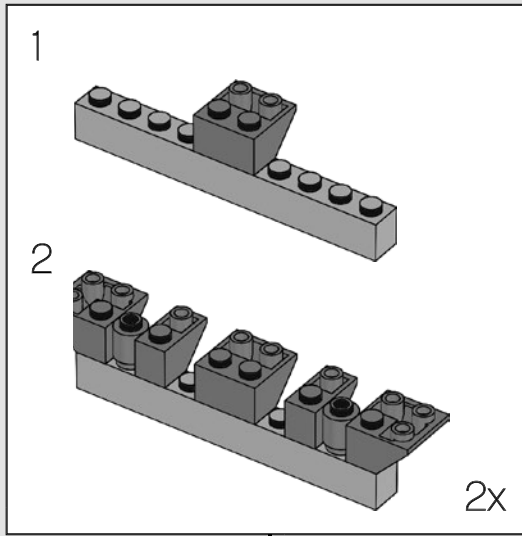

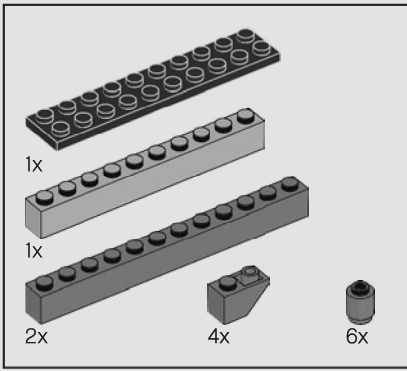

445

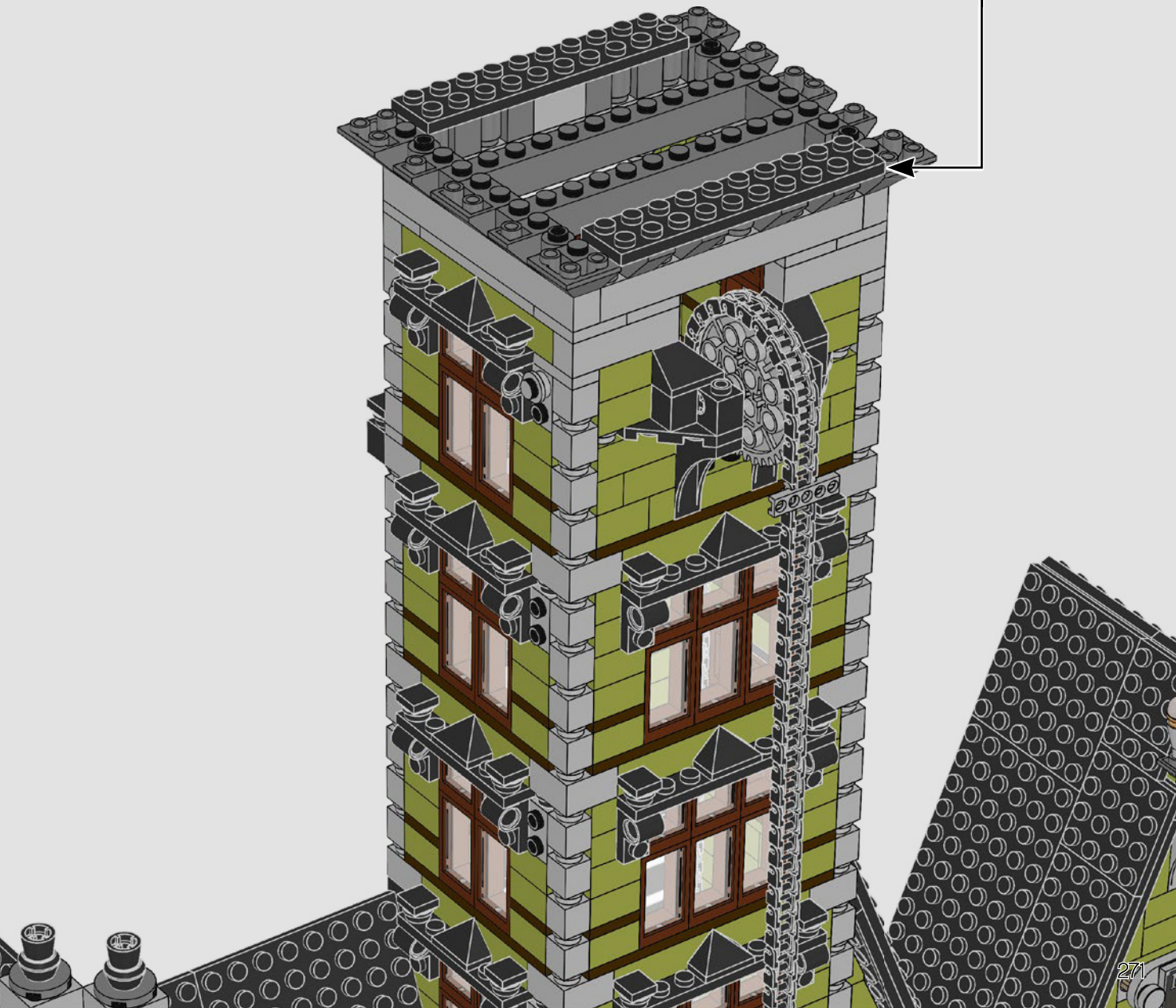
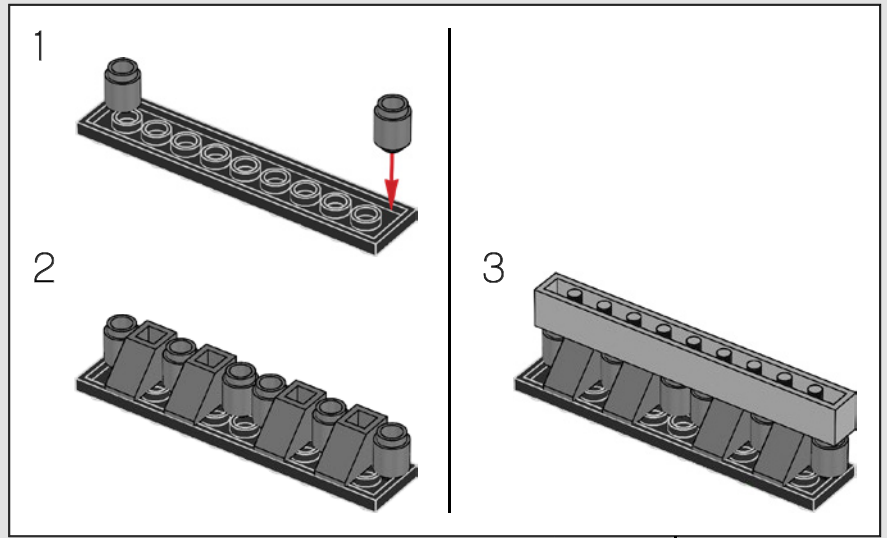

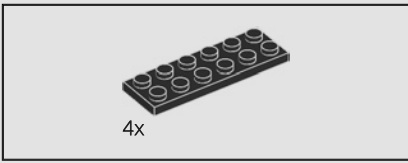

446



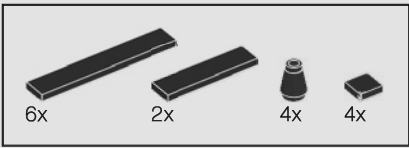

447

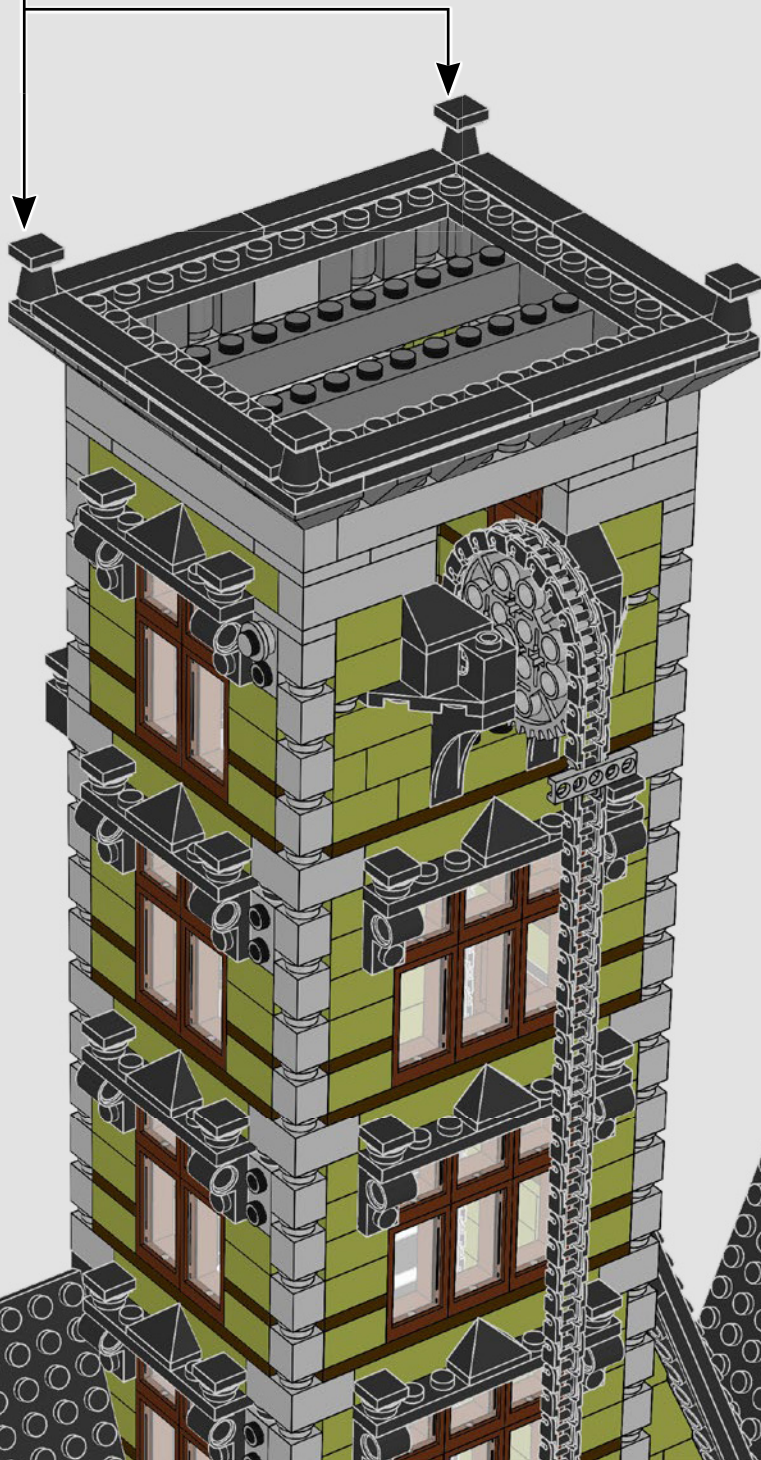
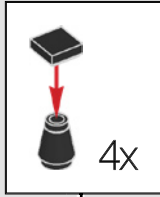

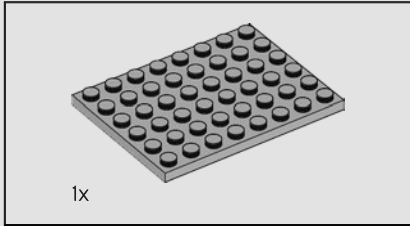
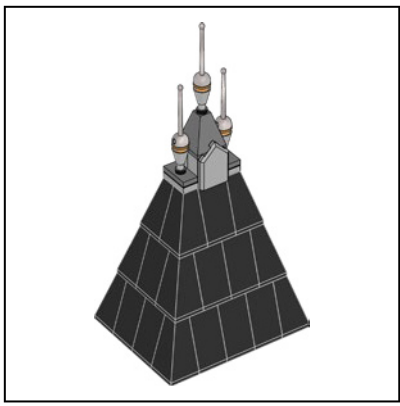

448

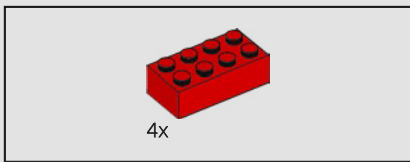
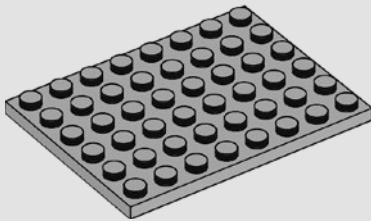

449

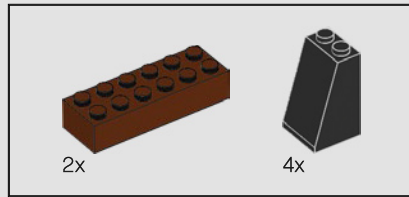
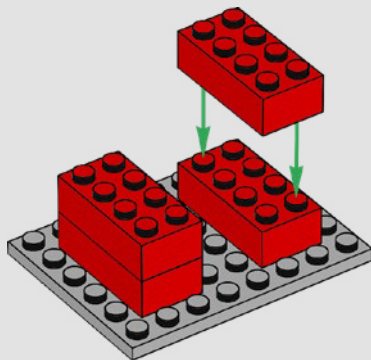

450

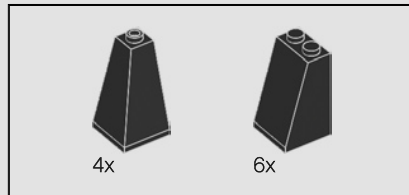
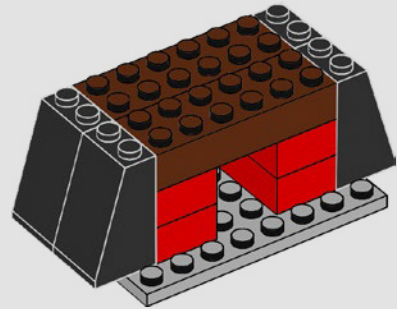

451

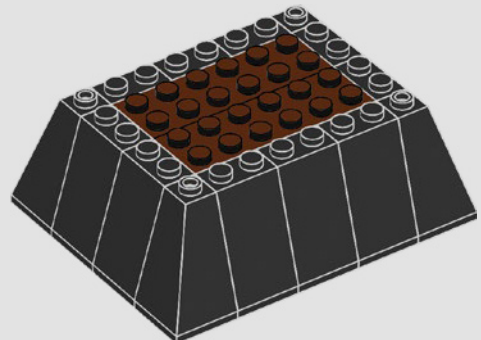

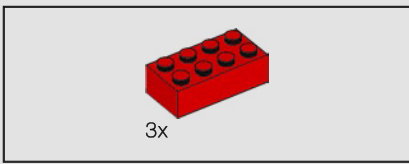

452

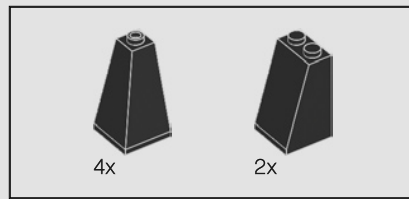
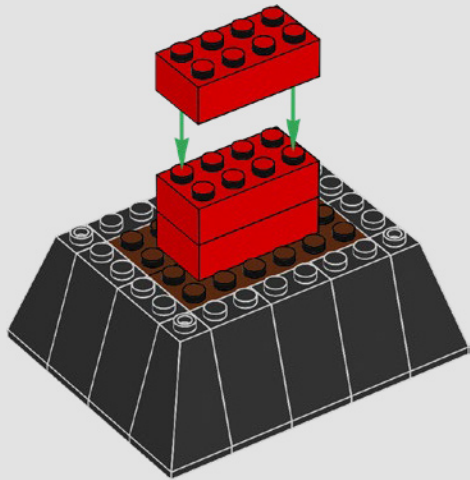

454

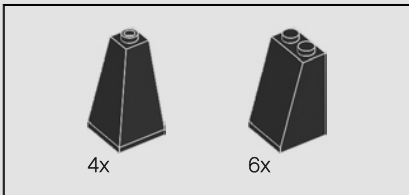
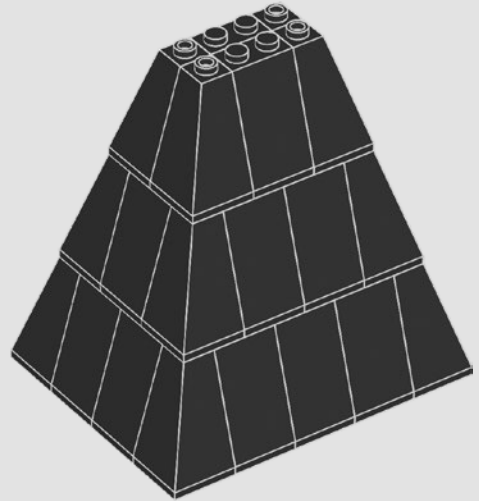

453

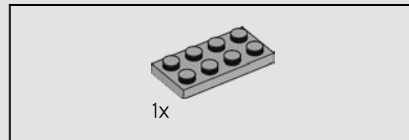
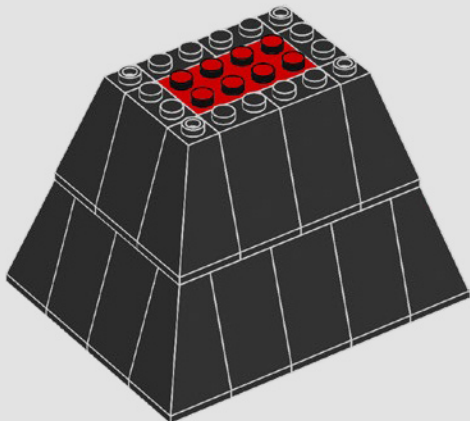

455

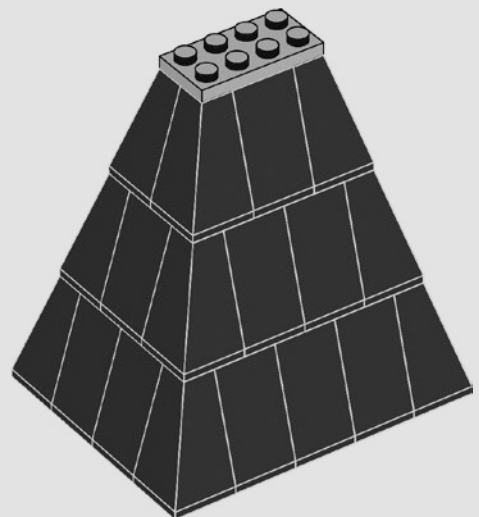

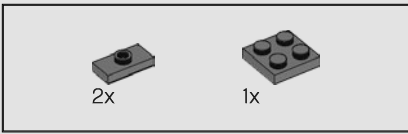

456

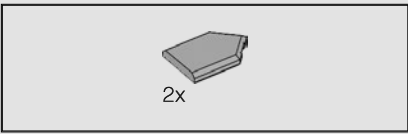
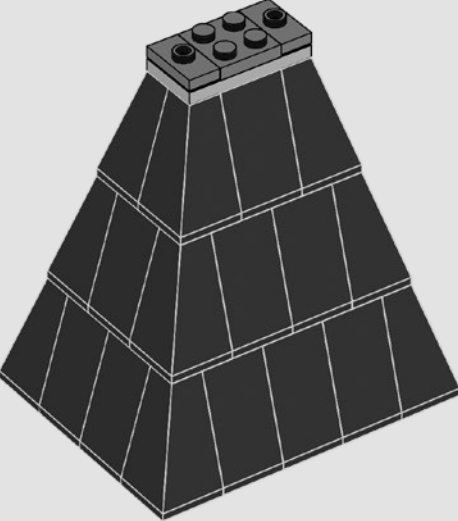

458

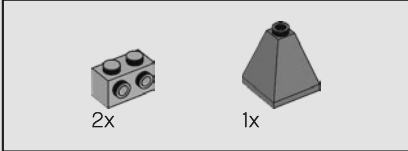
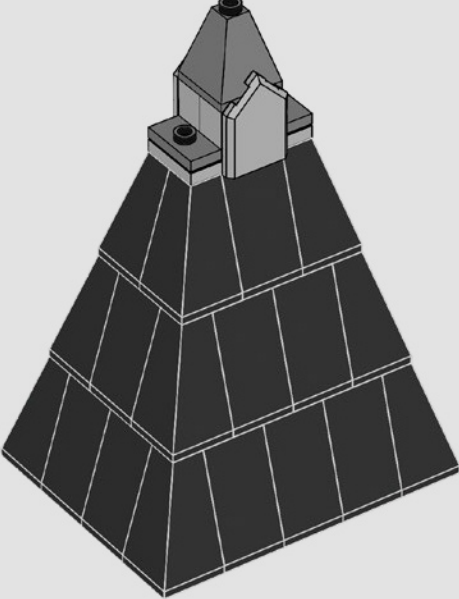

457

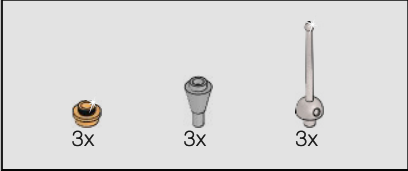
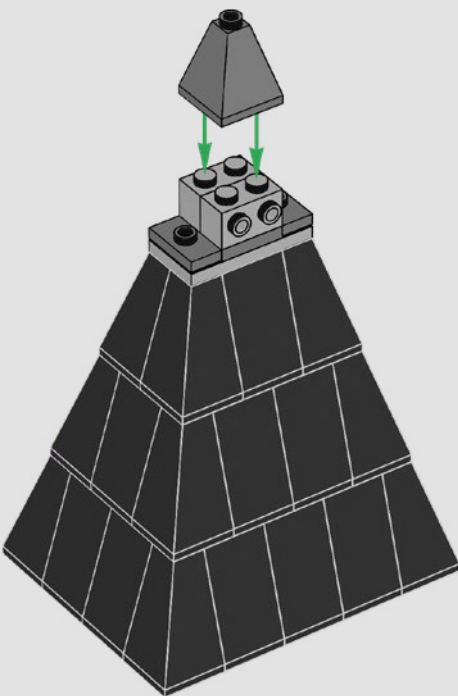

459

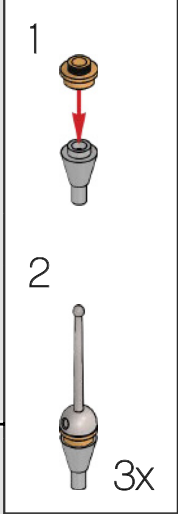
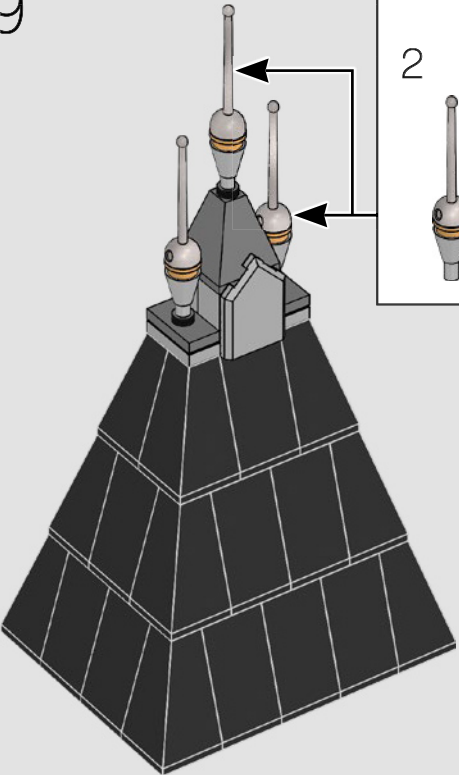

460

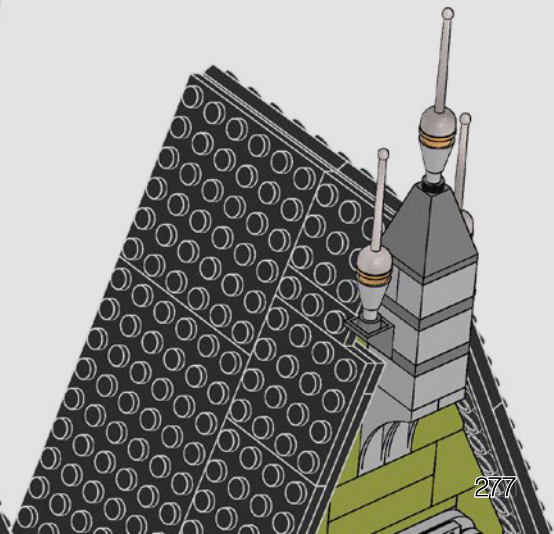
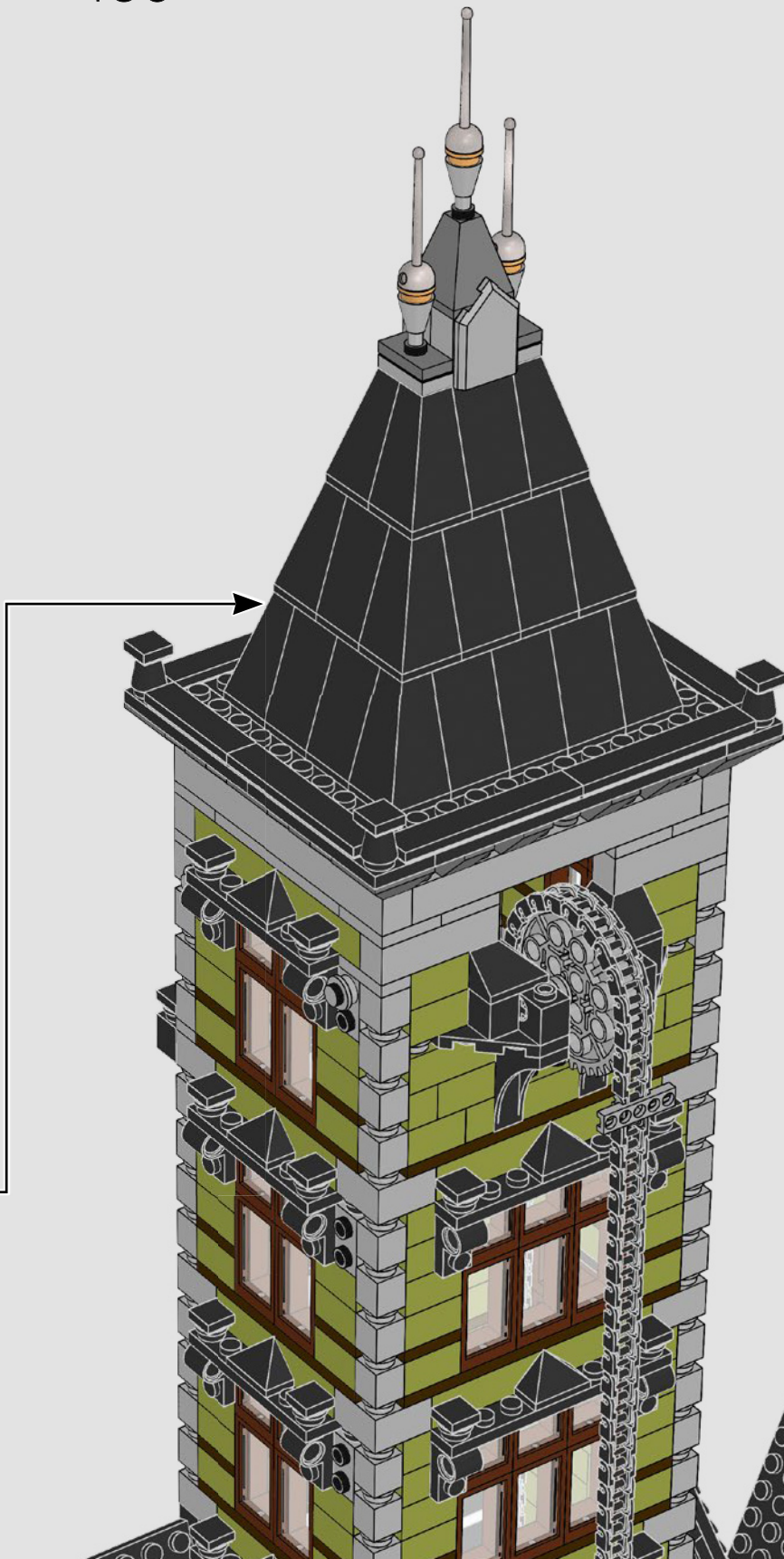

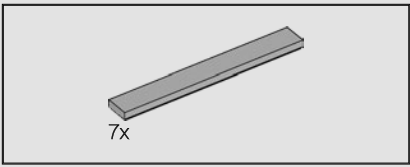

461



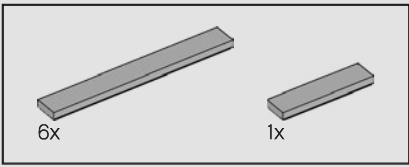

462

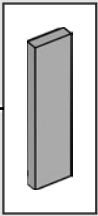

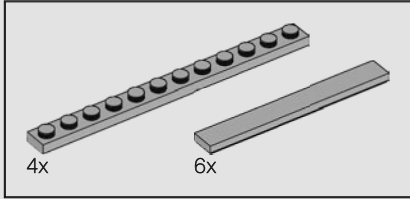
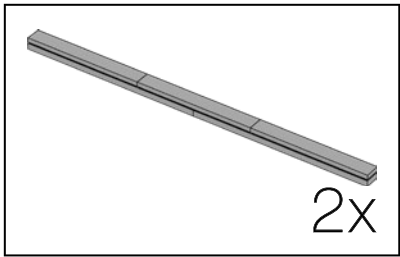

463

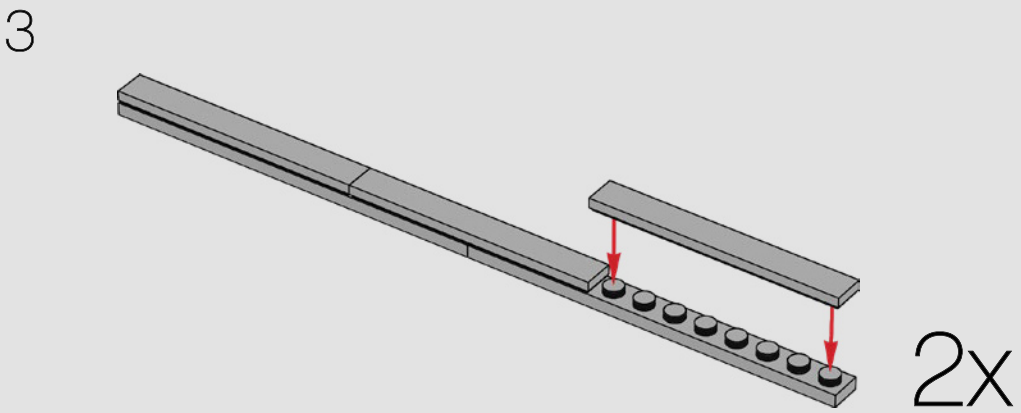
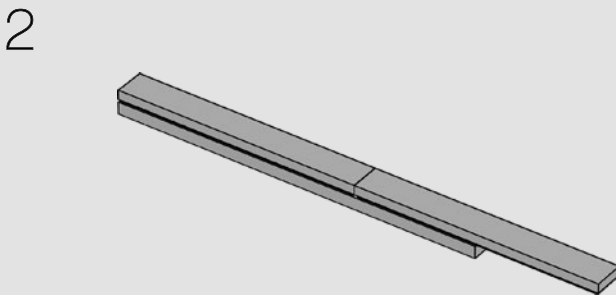
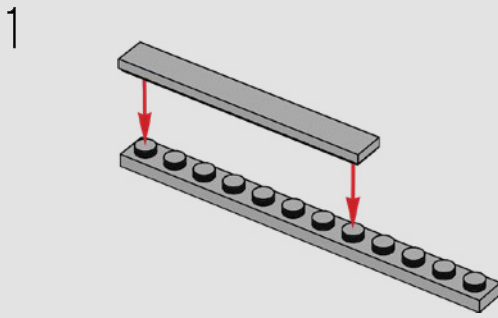

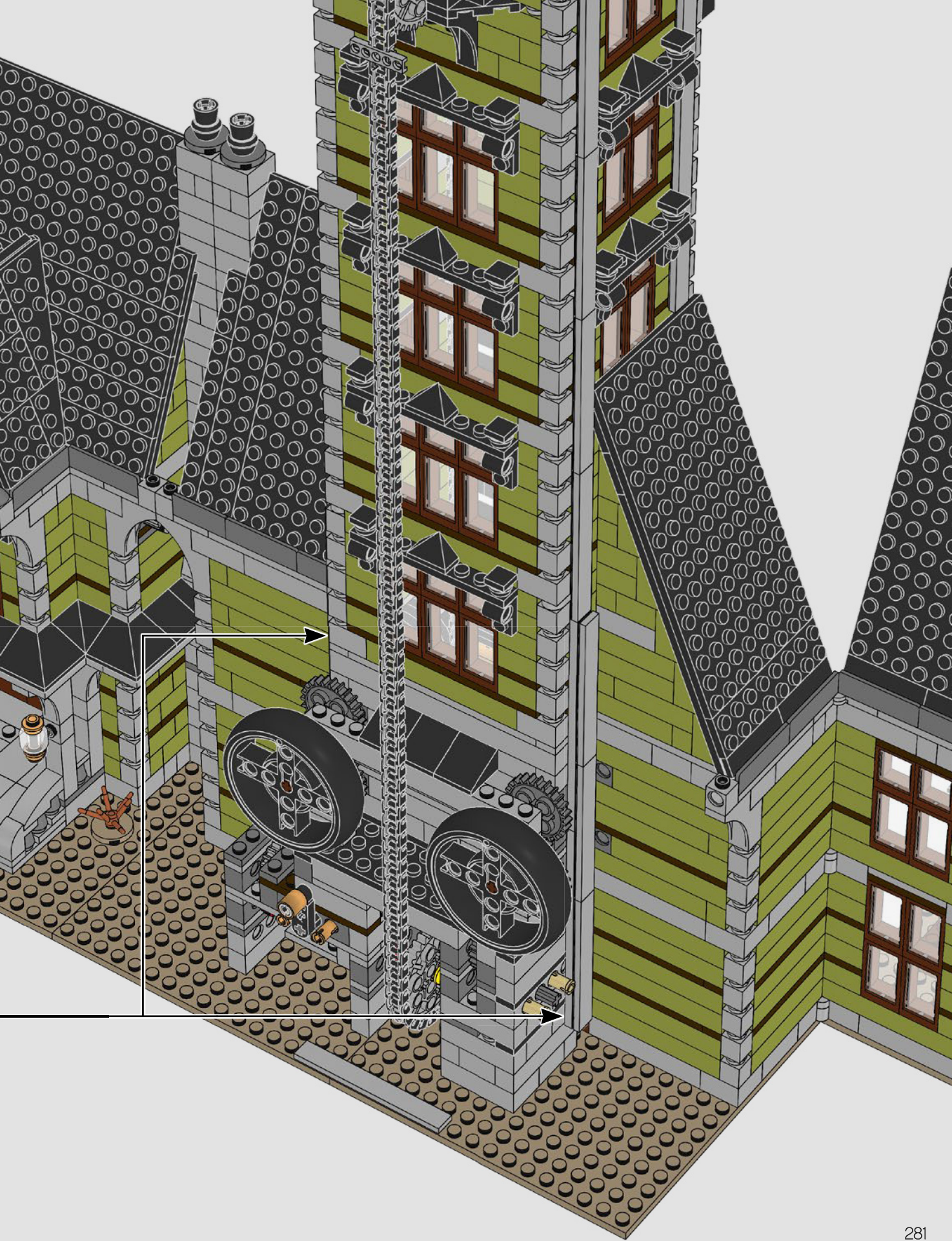

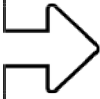



4x

464

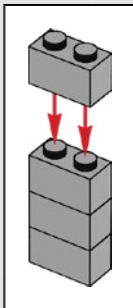

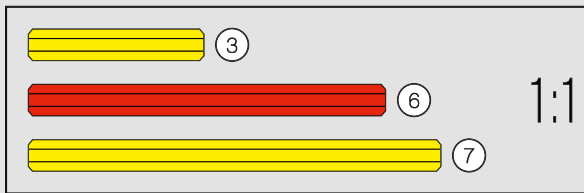
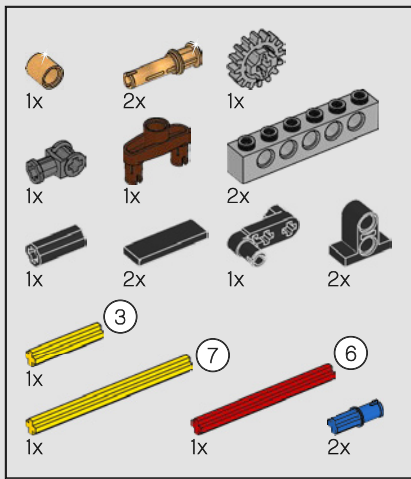

465

1

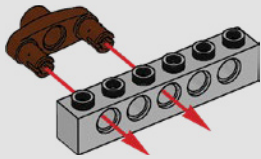

2

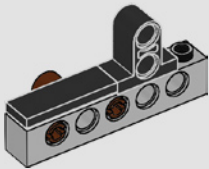

3

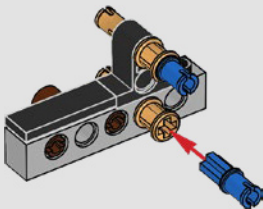

4

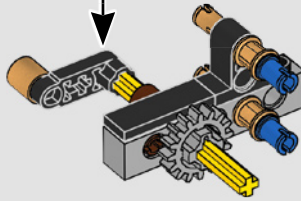

5

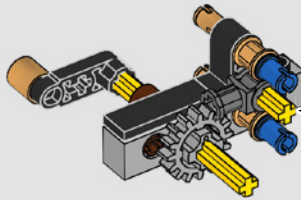

6

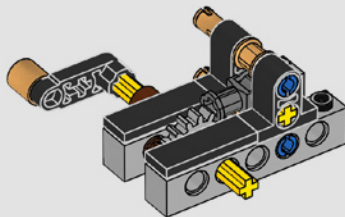

7

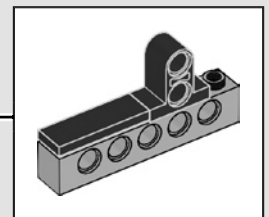
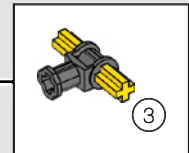
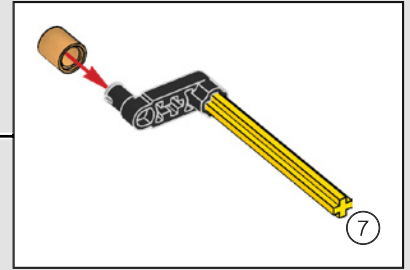
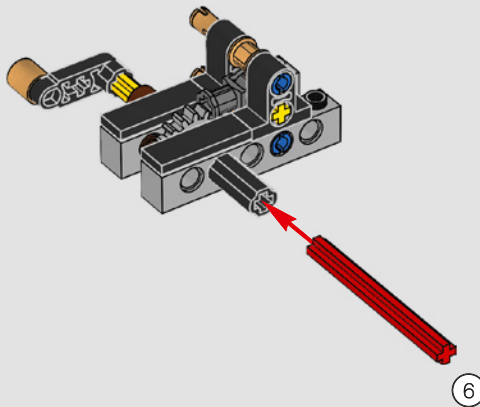

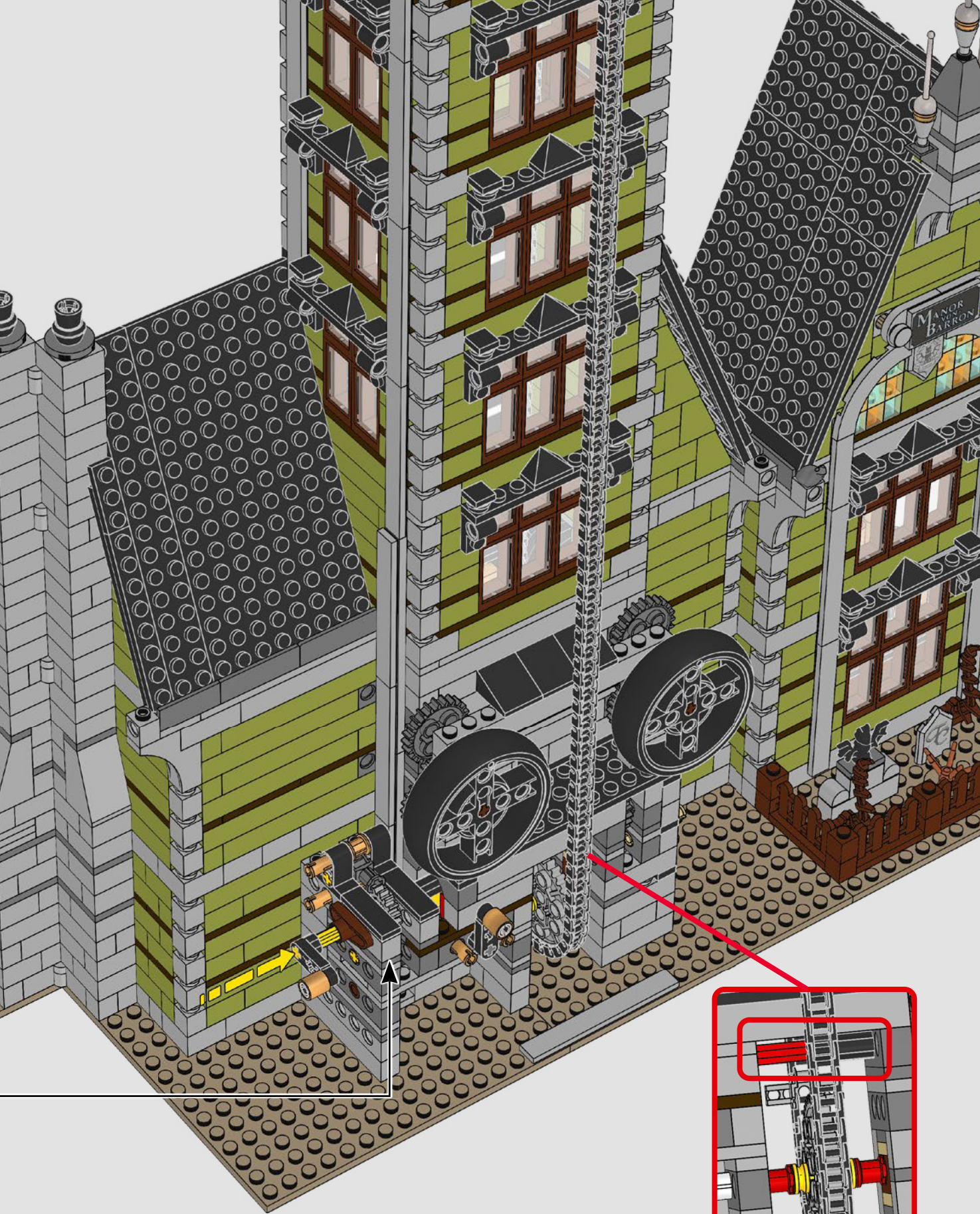

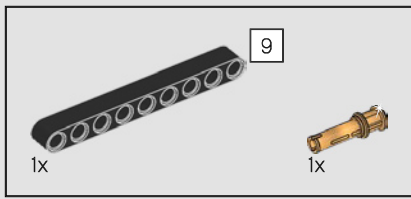

466

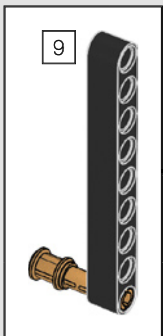
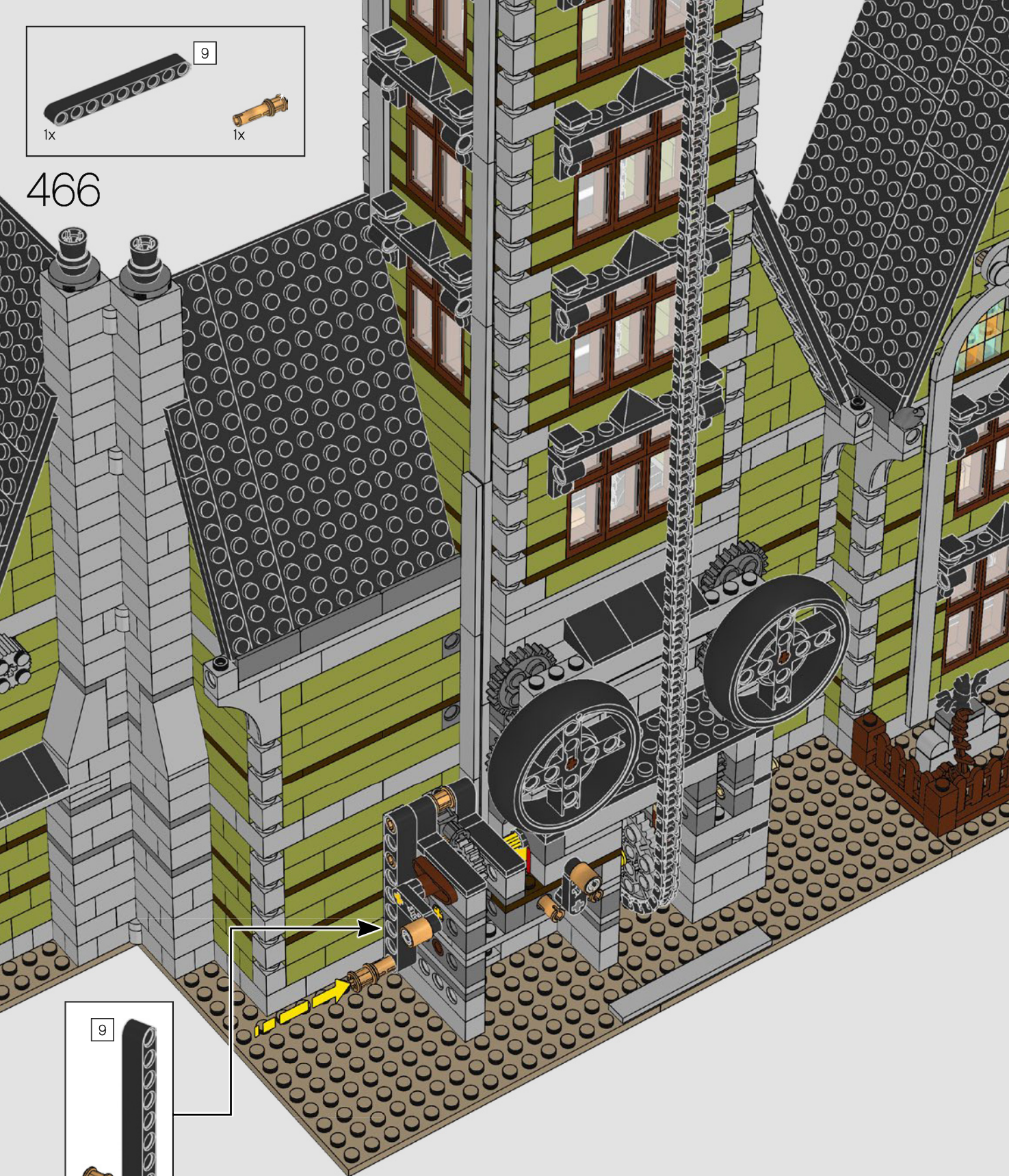

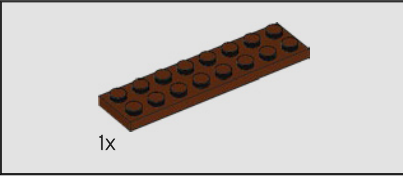
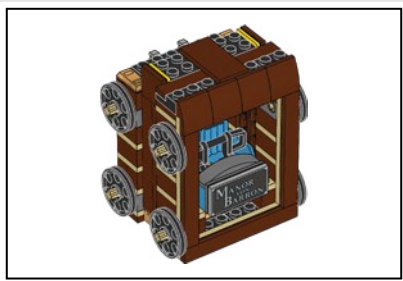

467

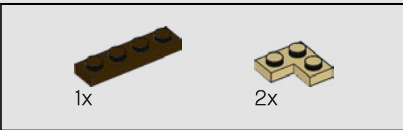
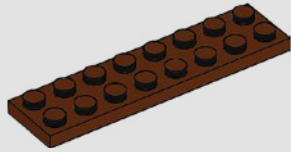

468

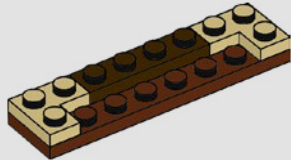

469

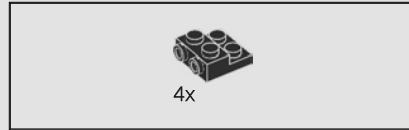
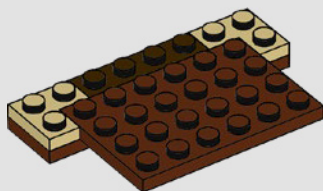

470

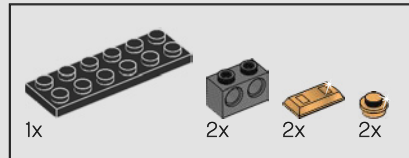
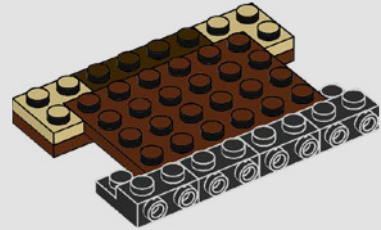

471

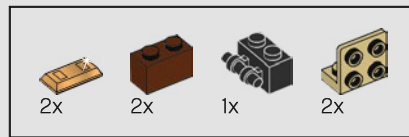
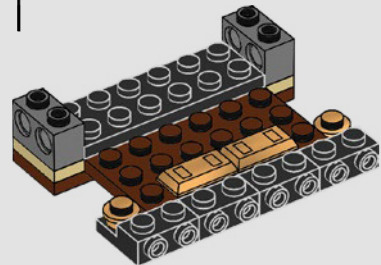

472

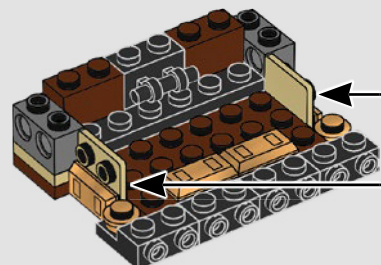
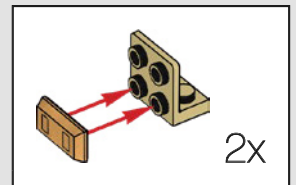

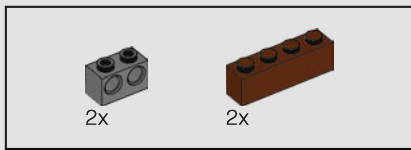

473

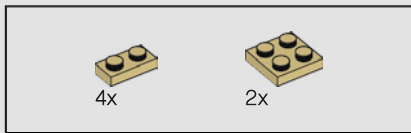
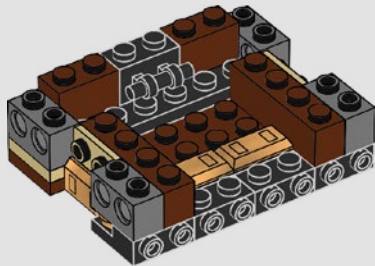

474

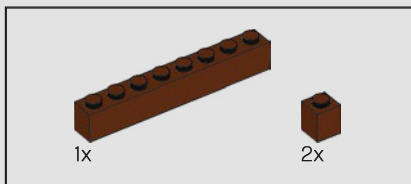
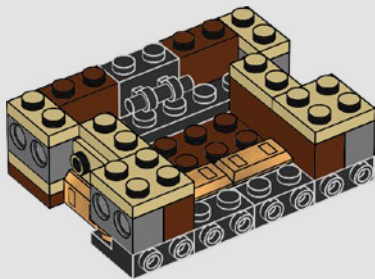

475

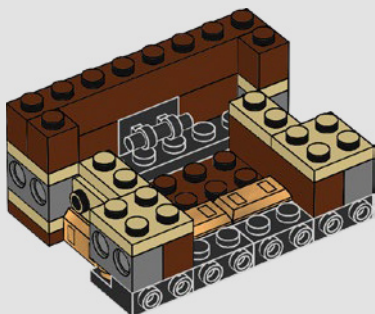

476

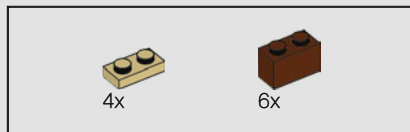
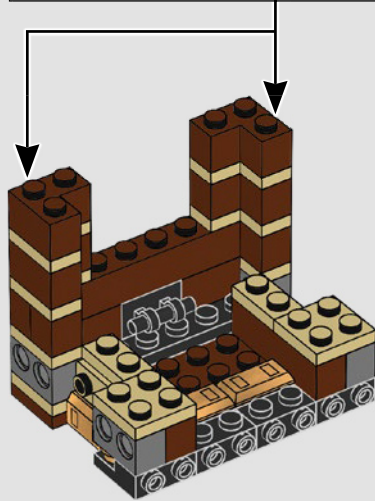
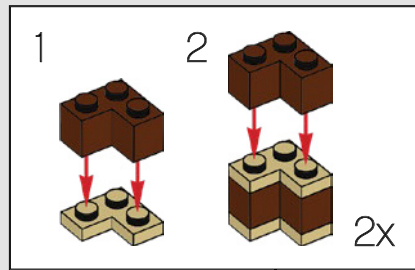

477

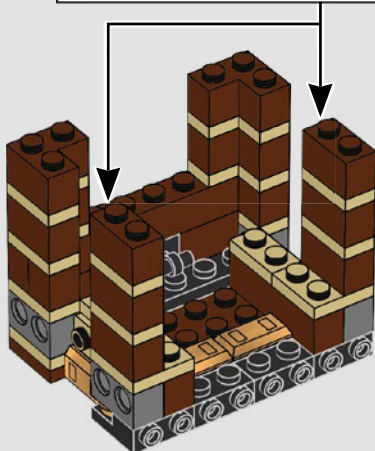
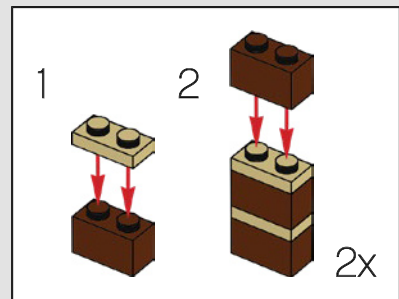



478

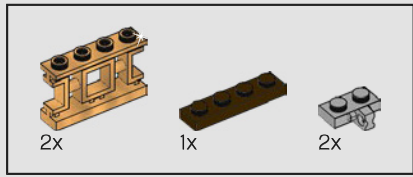
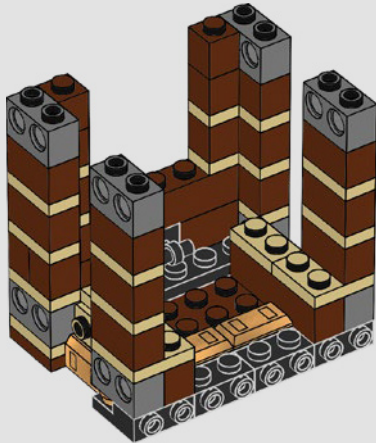

479

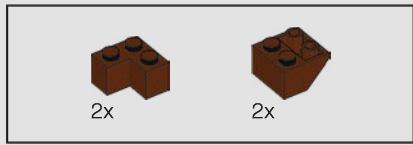
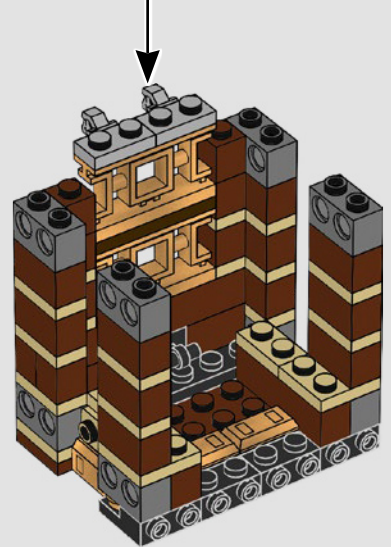
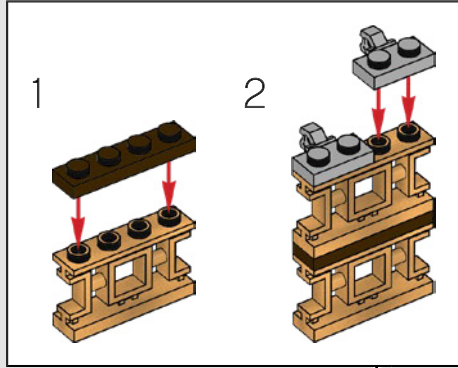

480

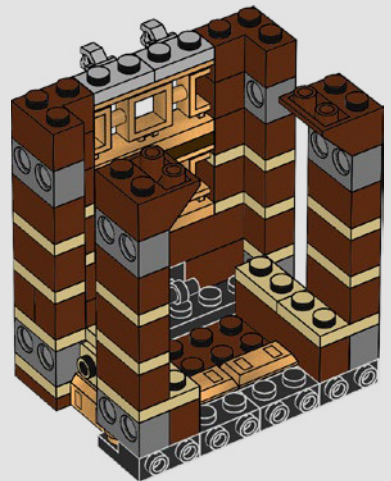

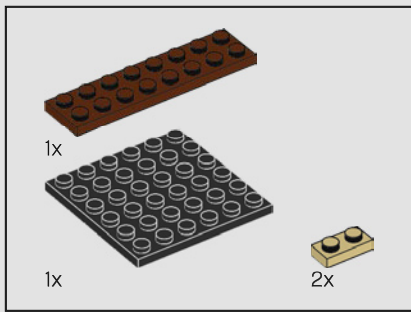

481

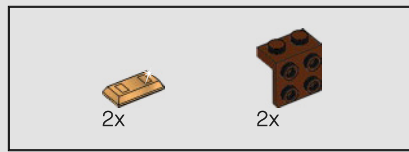
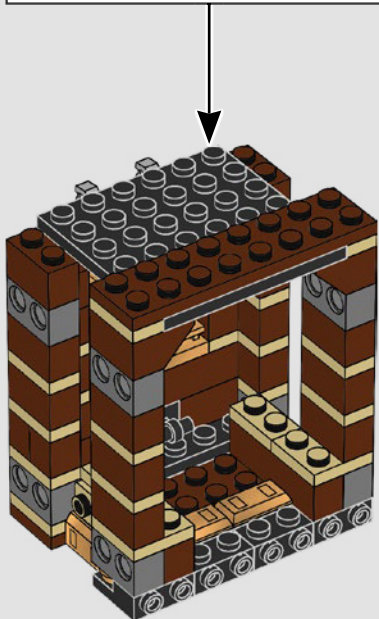
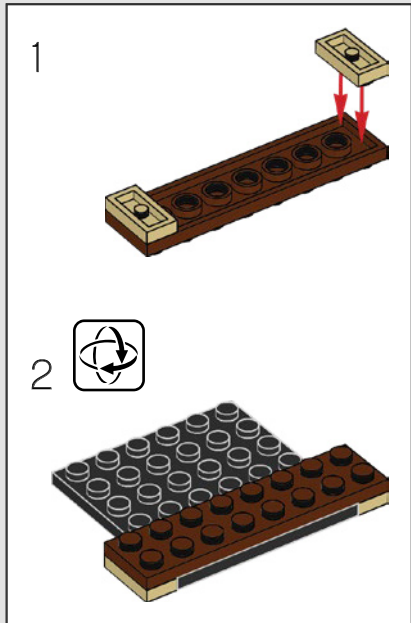

482

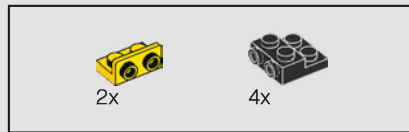
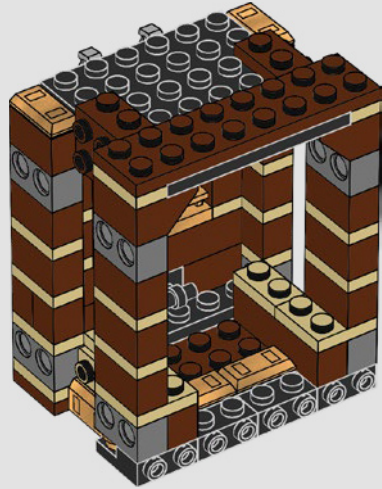

483

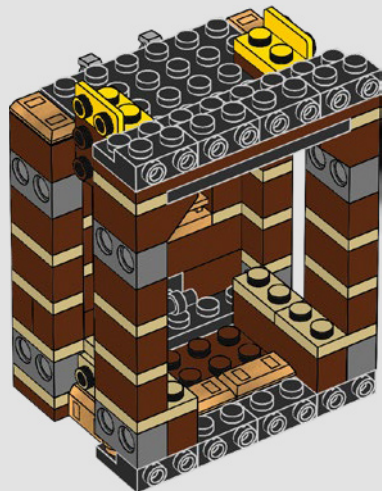

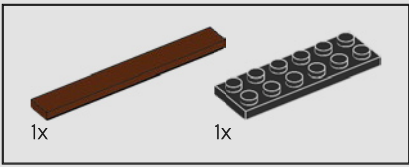

484

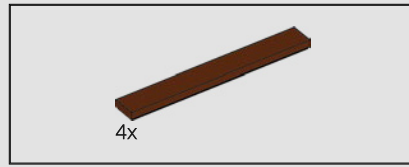
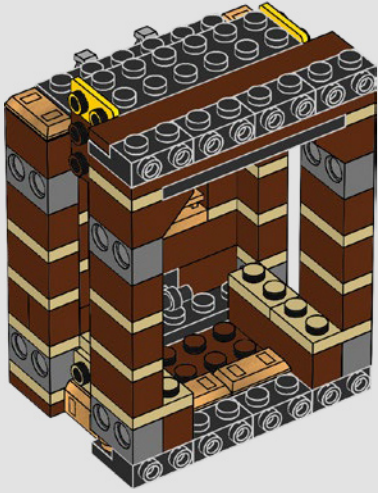

486

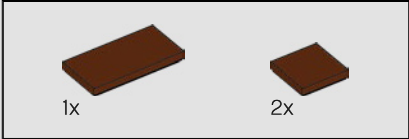
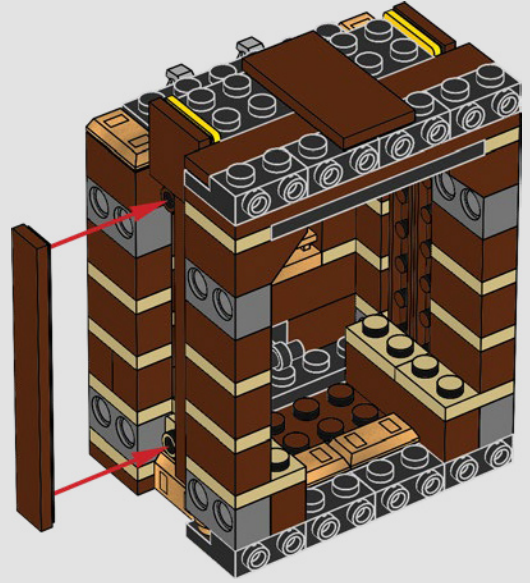

485

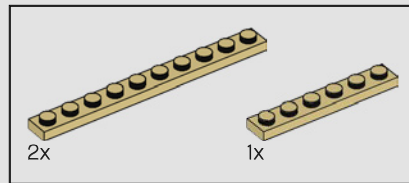
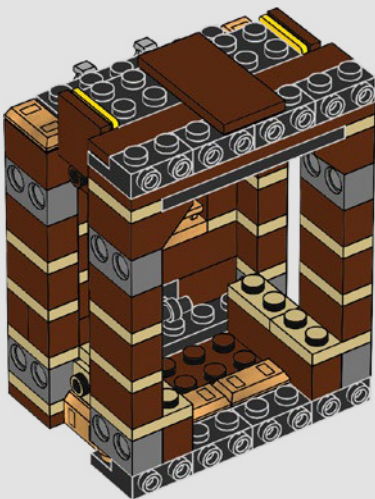

487

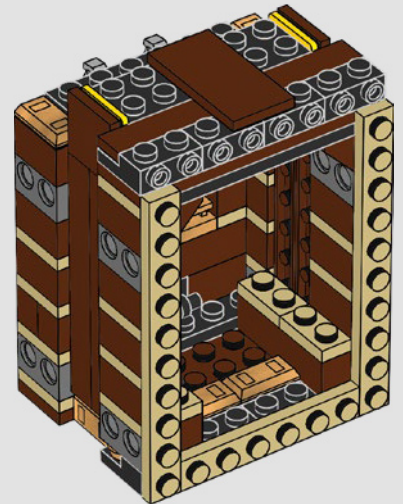

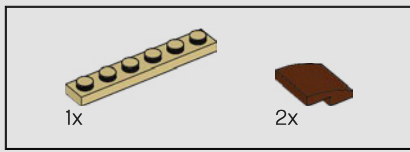

488

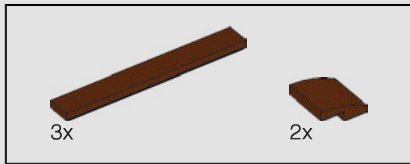
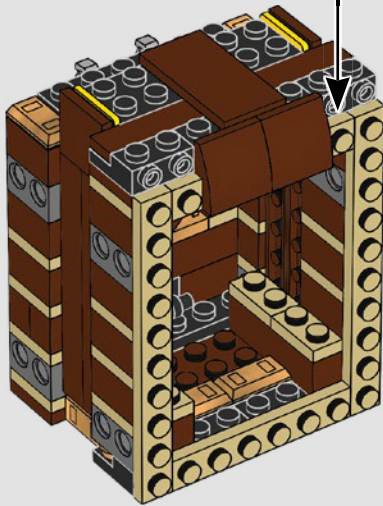
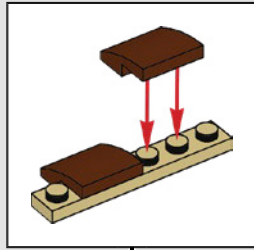

489

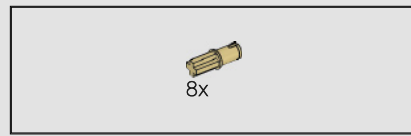
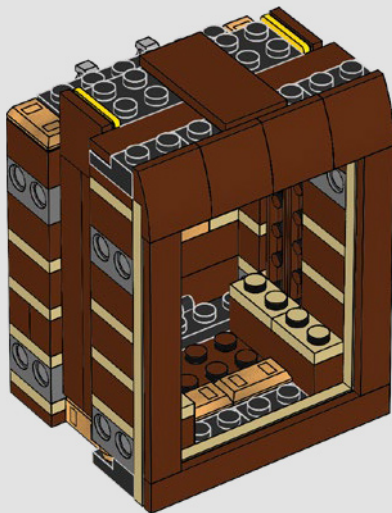

490

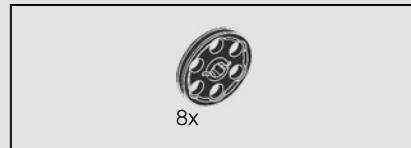
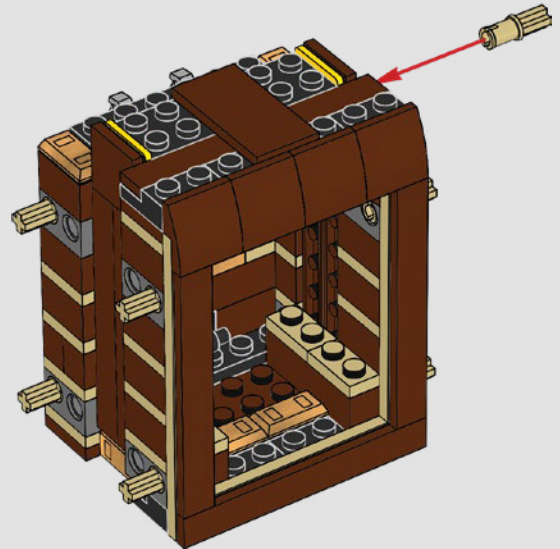

491

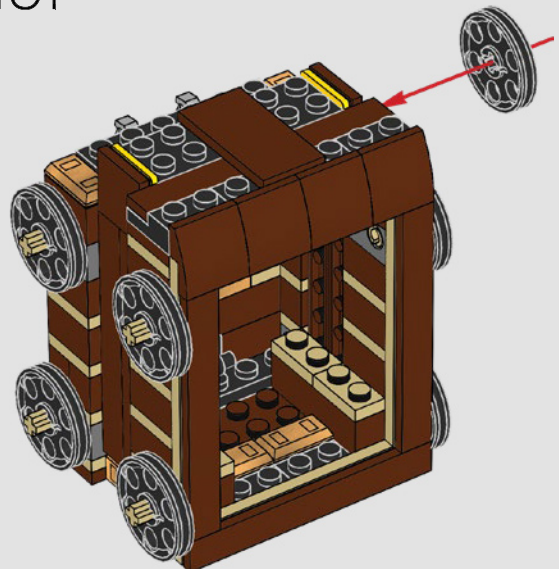

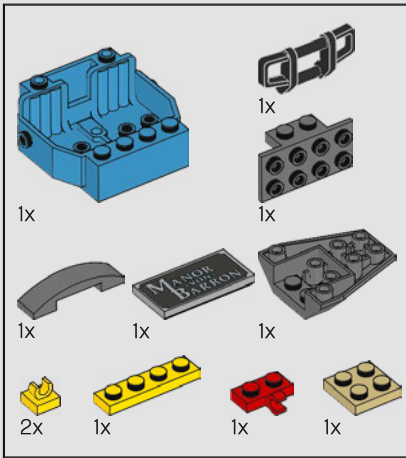
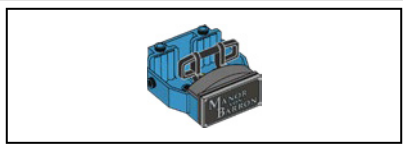

492

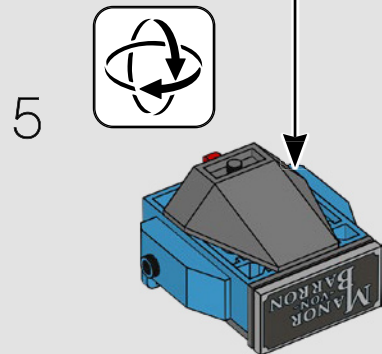
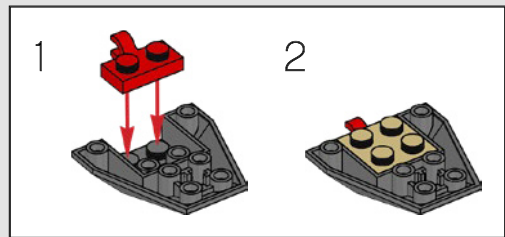
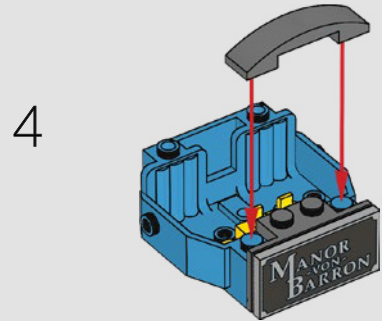
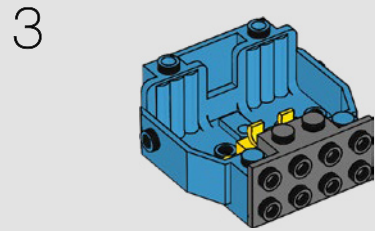
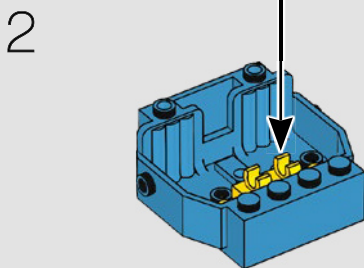
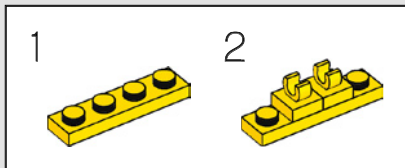
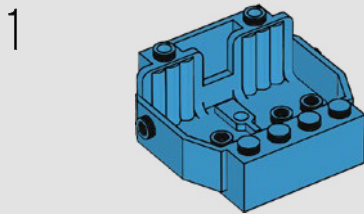

El Ascensor del Hombre Loco

"¿Preguntas por mi ascensor a ninguna parte?
Tiene subidas y bajadas. ¡Aaah, ja, ja, ja!"
- El Barón Loco

6

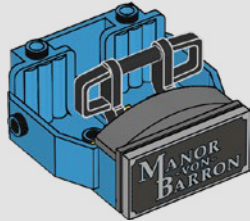

7

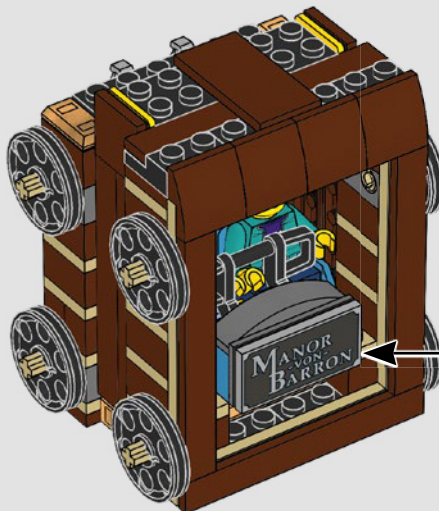

493



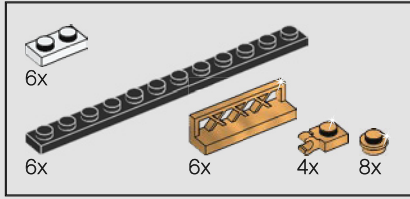
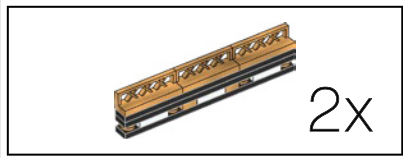

494

1

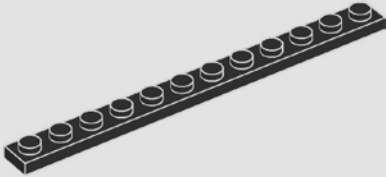

2

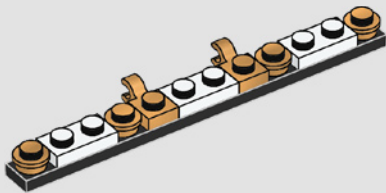

3

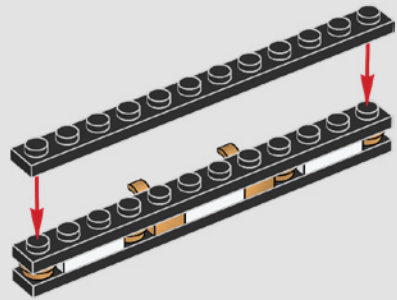

4

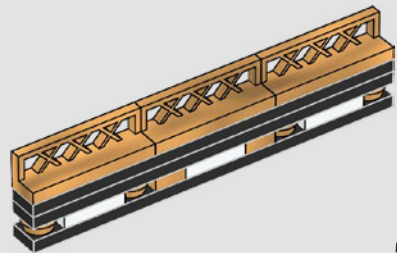



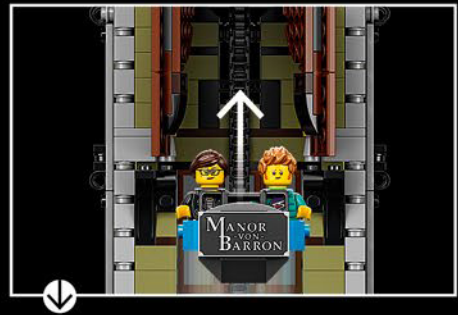
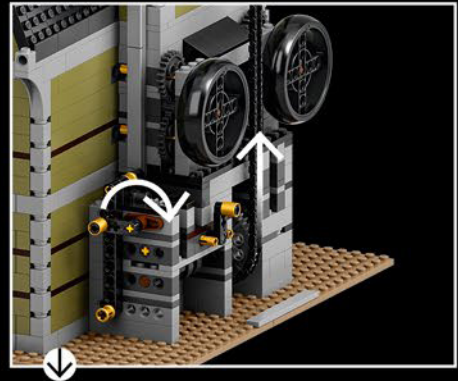
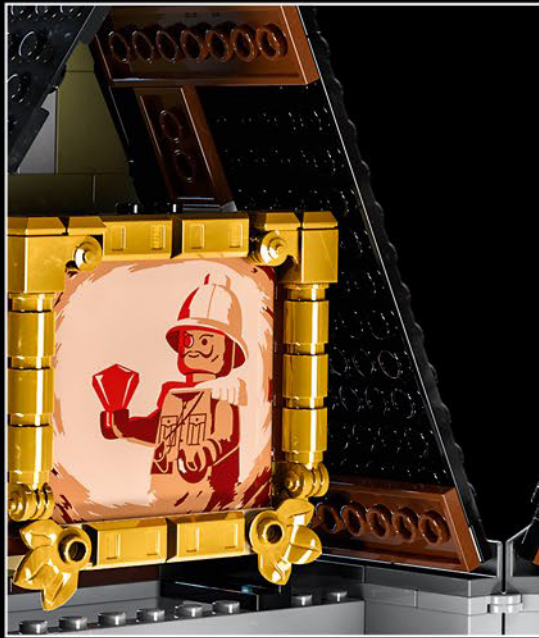

Compatible con Powered Up



10273

+



88009

+



88008 x2

+



LEGO® Powered Up
LEGO.com/apps

=



DESCARGA GRATIS LA APP

MOTORES ELÉCTRICOS

SE REQUIERE UN DISPOSITIVO INTELIGENTE
(NO INCLUIDO).

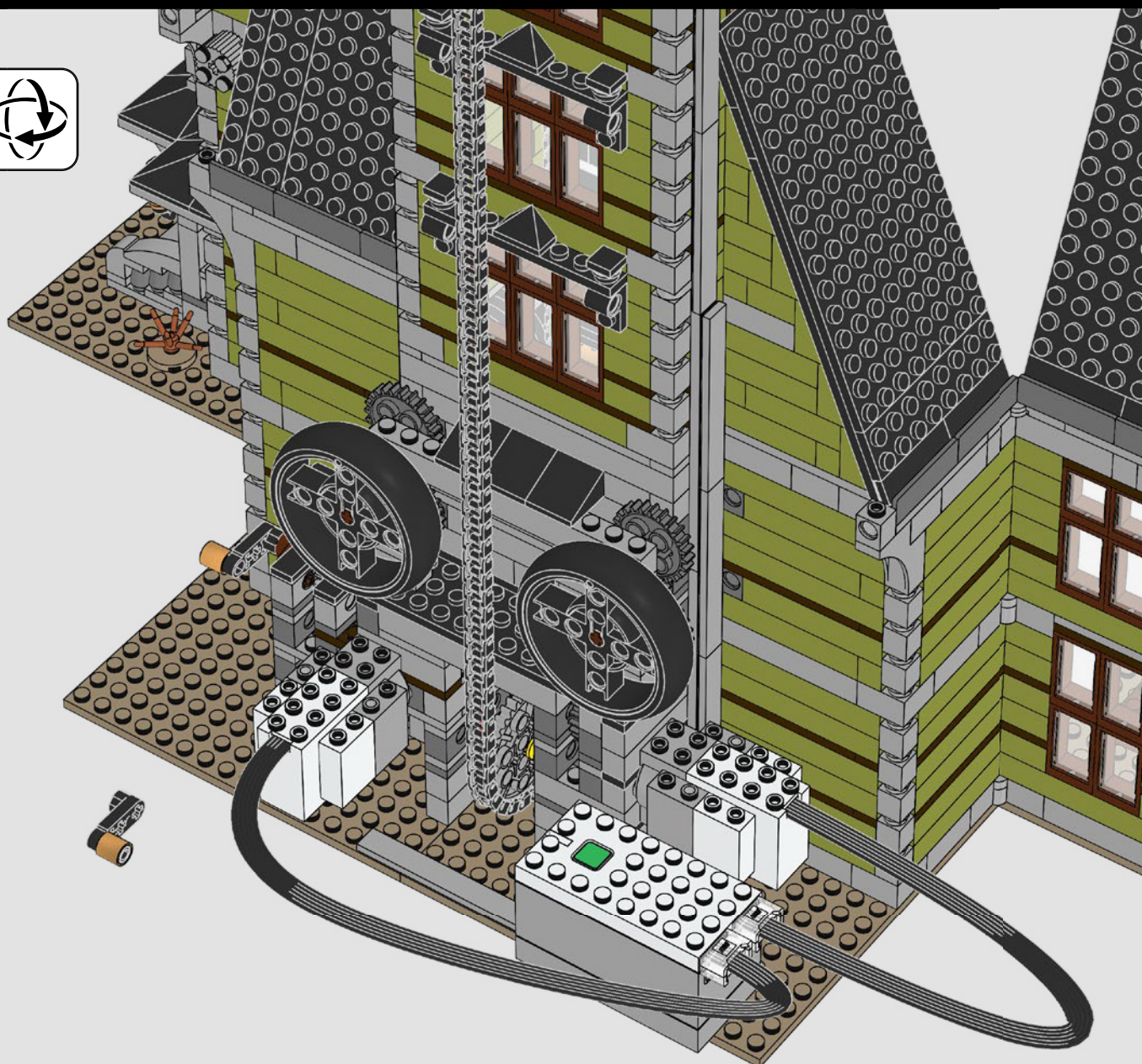

EN

Important information about batteries

Never use different types of batteries together, or a combination of old and new batteries. Always remove the batteries if the product is not to be used for a long time or if the batteries have run down. Never use damaged batteries. Only use alkaline type batteries. Insert the batteries so that the poles are correctly positioned. Never attempt to recharge non-rechargeable batteries. Never short-circuit the battery holder.

DE

Wichtige Informationen zu Batterien

Benutzen Sie niemals unterschiedliche Arten von Batterien oder alte und neue gleichzeitig. Nehmen Sie stets die Batterien heraus, wenn mit dem Modell längere Zeit nicht gespielt wird oder wenn die Batterien leer sind. Verwenden Sie niemals beschädigte Batterien. Verwenden Sie ausschließlich Alkali-Batterien. Achten Sie beim Einsetzen der Batterien auf die richtige Polung. Versuchen Sie unter keinen Umständen, „normale“ Batterien wieder aufzuladen. Schließen Sie das Batteriefach niemals kurz.

FR

Informations importantes concernant les piles

Ne jamais utiliser un mélange de différents types de piles, ou de piles neuves et de piles anciennes ou déjà utilisées. Toujours retirer les piles si le produit n'est pas utilisé durant une période prolongée ou si les piles sont vides. Ne jamais utiliser de piles endommagées. N'utiliser que des piles alcalines. En insérant les piles, respecter scrupuleusement le sens d'orientation des pôles (+/-). Ne jamais essayer de recharger des piles non rechargeables. Ne jamais court-circuiter le compartiment des piles.

IT

Importanti informazioni sulle batterie

Non usare mai contemporaneamente batterie di tipo diverso o batterie nuove e usate insieme. Rimuovere sempre le batterie qualora il prodotto non venga utilizzato per periodi prolungati, oppure se le batterie sono esauste. Non utilizzare mai batterie danneggiate. Utilizzare solo batterie di tipo alcalino. Inserire le batterie avendo cura che la loro polarità sia corretta. Non tentare mai di ricaricare batterie non ricaricabili. Non cortocircuitare mai il portabatterie.

NL

Belangrijke informatie over batterijen

Gebruik nooit verschillende soorten of een combinatie van oude en nieuwe batterijen tegelijkertijd. Verwijder de batterijen altijd als je het product lange tijd niet wilt gebruiken of als batterijen leeg zijn. Gebruik nooit beschadigde batterijen. Gebruik alleen alkalinebatterijen. Plaats de batterijen met de polen in de juiste richting. Probeer nooit niet-oplaadbare batterijen opnieuw op te laden. Laat de batterijhouder nooit kortsluiten.

ES

Información importante acerca de las pilas

No use pilas de diferentes tipos ni pilas nuevas y antiguas para alimentar el producto. Extraiga las pilas del producto si este va a permanecer sin uso durante un período prolongado de tiempo o aquellas se han agotado. No use pilas dañadas. Use solo pilas alcalinas. Inserte las pilas de modo que los polos queden situados en las posiciones correctas. No trate de cargar pilas no recargables. No cortocircuite el compartimento de las pilas.

DA

Vigtige oplysninger om batterier

Brug aldrig forskellige batterityper sammen eller en kombination af gamle og nye batterier. Fjern altid batterierne, hvis produktet ikke skal bruges i lang tid, eller hvis batterierne er flade. Brug aldrig beskadigede batterier. Brug kun alkaliske batterier. Sæt batterierne i, så polerne vender den rigtige vej. Forsøg aldrig at oplade ikke-genopladelige batterier. Kortslut aldrig batteriholderen.

IS

Mikilvægar upplýsingar um rafhlöður

Aldrei skal nota mismunandi gerðir rafhlaðna samtímis, né nýjar og eldri rafhlöður samtímis. Ef ekki á að nota tækði í lengri tíma eða ef rafhlöðurnar eru orðnar tómar skal fjarlægja rafhlöðurnar. Aldrei skal nota rafhlöður sem hafa skemmt. Eingöngu má nota alkaline-rafhlöður. Setja skal rafhlöðurnar í þannig að plús- og mínusskaut þeirra snúi rétt. Aldrei skal reyna að endurhlaða rafhlöður sem ekki eru endurhlaðanlegar. Aldrei ætti að valda skammhlaupi í rafhlöðuhöfðinu.

FI

Tärkeää tietoa paristoista

Älä koskaan käytä erityyppisiä paristoja yhdessä. Älä myöskään käytä samassa laitteessa sekä vanhoja että uusia paristoja. Poista paristot tuotteesta aina, kun se on pitemmän aikaa käyttämättä, tai kun paristot ovat tyhjentyneet. Älä koskaan käytä viiallisia paristoja. Käytä vain alkaliparistoja. Aseta paristot siten, että navat osoittavat oikeaan suuntaan. Älä koskaan aiheuta oikosulkua pariston kosketinten välillä.

SV

Viktig information om batterier

Använd aldrig olika sorters batterier samtidigt, och inte heller en kombination av gamla och nya batterier. Ta alltid ur batterierna om produkten inte ska användas under en längre tid eller om batterierna är slut. Använd aldrig skadade batterier. Använd endast alkaliska batterier. Sätt i batterierna så att polerna hamnar i rätt läge. Försök aldrig ladda icke-laddningsbara batterier. Kortslut aldrig batteriutrymmets kontaktytor.

NO

Viktig informasjon om batterier

Bruk aldri ulike typer batterier sammen og heller aldri gamle og nye batterier sammen. Ta alltid ut batteriene hvis produktet ikke skal brukes på lang tid, eller hvis batteriene er brukt opp. Bruk aldri skadde batterier. Bruk bare alkaliske batterier. Sett inn batteriene med polene vendt riktig vei. Forsøk aldri å lade opp ikke-oppladbare batterier. Kortslett aldri batteriholderen.

PT

Informação importante sobre as pilhas

Nunca use diferentes tipos de pilhas em simultâneo, ou uma combinação de pilhas usadas e novas. Retire sempre as pilhas se o produto não for usado durante muito tempo ou se as pilhas já não tiverem carga. Nunca use pilhas danificadas. Use apenas pilhas alcalinas. Insira as pilhas de forma a que os polos fiquem corretamente posicionados. Nunca tente recarregar pilhas não recarregáveis. Nunca deixe o compartimento das pilhas entrar em curto-circuito.

EL

Σημαντικές πληροφορίες για τις μπαταρίες

Μην χρησιμοποιείτε ποτέ διαφορετικούς τύπους μπαταριών μαζί και μην συνδυάζετε παλιές και καινούργιες μπαταρίες. Αφαιρείτε πάντα τις μπαταρίες αν δεν σκοπεύετε να χρησιμοποιήσετε το προϊόν για αρκετό καιρό ή αν οι μπαταρίες έχουν αδειάσει. Ποτέ μην χρησιμοποιείτε μπαταρίες που έχουν φθορές. Χρησιμοποιείτε μόνο αλκαλικές μπαταρίες. Τοποθετήστε τις μπαταρίες με τους πόλους στη σωστή θέση. Μην επιχειρήσετε ποτέ να επαναφορτίσετε μη επαναφορτιζόμενες μπαταρίες. Ποτέ μην βραχυκυκλώνετε τη θήκη των μπαταριών.

JA

電池取扱いに関する重要事項

異なるタイプの電池や古い電池を混ぜて使用しないでください。商品を長時間使用しないときや電池が切れたときは、電池を必ず取り外してください。不具合のある電池は絶対に使用しないでください。アルカリタイプの電池のみを使用してください。電極を確認して電池を正しい向きに入れてください。充電式ではない電池は絶対に充電しないでください。電池ホルタをショートさせないでください。

ZH

电池使用注意事项

请勿同时使用不同类型的电池，或把新旧程度不同的电池混合使用。如果产品将有很长时间不会使用，或者电池已经没电，请注意取出电池。切勿使用已破损的电池。仅可使用碱性电池。装入电池时请注意正负极。请勿尝试给非充电电池充电。切勿对电池仓进行短路连接。

KO

배터리 사용 시 주의사항

다른 종류의 배터리를 함께 사용하거나, 새 전지와 오래된 전지를 혼용하지 마세요. 배터리가 방전되었거나 장기간 제품을 작동하지 않을 때에는 반드시 배터리를 분리하세요. 파손된 배터리는 사용하지 마세요. 알칼라인 타입의 배터리만을 사용하세요. 양극과 음극의 위치를 잘 맞춰서 넣으세요. 일반 배터리는 충전해서 사용할 수 없습니다. 배터리 홀더의 접촉부에 배터리를 정확히 끼워서 사용하세요.

RU

Необходимая информация об элементах питания

Ни в коем случае не используйте одновременно элементы питания различных типов, а также элементы питания с разным сроком годности. В обязательном порядке вынимайте элементы питания из терминалов в случае, если вы не пользуетесь прибором в течение долгого времени, либо в случае, если в элементах питания закончился заряд. Ни в коем случае не используйте поврежденные элементы питания. Используйте только элементы питания щелочного типа. Установите элементы питания, соблюдая указанную полярность. Ни в коем случае не пытайтесь подзаряжать непerezаряжаемые элементы питания. Ни в коем случае не пытайтесь замкнуть полюса в устройстве для элементов питания.

PL

Ważne informacje dotyczące baterii

Nigdy nie należy stosować razem różnych rodzajów baterii ani stosować równocześnie starych i nowych baterii. Jeżeli produkt nie jest używany przez dłuższy czas lub jeżeli baterie się wyczerpały, należy wyjąć baterie. Nigdy nie należy stosować uszkodzonych baterii. Należy używać wyłącznie baterii alkalicznych. Przy wkładaniu baterii należy zwrócić uwagę na właściwe położenie biegunów. Nigdy nie należy próbować ładowania baterii jednorazowych. Nigdy nie należy doprowadzać do zwarcia w gnieździe baterii.

CZ

Důležitá informace o bateriích

Nikdy nepoužívejte najednou různé typy baterií nebo kombinaci starých a nových baterií. Nebude-li se výrobek delší dobu používat nebo jsou-li baterie vybité, vždy je vyjměte z výrobku. Nikdy nepoužívejte poškozené baterie. Používejte pouze alkalické baterie. Baterie instalujte se správnou orientací pólů. Nikdy se nesnažte nabíjet baterie, které nejsou nabíjitelné. Nikdy nezkratuje kontakty v prostoru pro baterie.

SK

Dôležitá informácia o batériách

Nikdy nepoužívajte naraz odlišné typy batérií ani nekombinujte staré batérie s novými. Batérie vždy vyberte, ak sa výrobok nebude dlhšie používať, alebo ak sa batérie vybili. Nikdy nepoužívajte poškodené batérie. Používajte iba alkalické batérie. Batérie vkladajte so správnou orientáciou pólov. Nikdy sa nesnažte nabíjať batérie, ktoré nie sú nabíjateľné. Nikdy neskratuje kontakty v priestore pre batérie.

HU

Fontos tudnivalók az elemekről

Soha ne használjon különböző típusú elemeket, illetve ne használjon vegyesen új és használt elemeket. Mindig távolítsa el az elemeket, ha a készülék előre láthatóan hosszabb ideig nem fogják használni, vagy ha az elemek lemerültek. Soha ne használjon megrongálódott elemeket. Csak alkáli elemeket használjon! Az elemeket helyesen helyezze be, a polaritásuknak megfelelően. Soha ne próbálja meg feltölteni a nem tölthető elemeket. Soha ne hozzon létre rövidzárlatot az elemtartó kivezetésén.

UA

Необхідна інформація про батареї

Ніколи не використовуйте одночасно батареї різних типів або батареї з різними терміном придатності. Обов'язково вилучайте батареї з приладу, якщо довго не користуєтесь ним, або якщо в батареях уже скінчився заряд. Ніколи не використовуйте пошкоджені батареї. Використовуйте лише лужні батареї. Вставляйте батареї, враховуючи задану полярність. У будь-якому випадку не намагайтеся підзарядити батареї, що не підлягають підзарядці. У будь-якому випадку не намагайтеся зробити коротке замикання в приладі для батарей.

HR

Važne obavijesti o bateriji

Nikada nemoj koristiti različite vrste baterija zajedno, isto tako ni kombinaciju starih i novih baterija. Uvijek izvadite baterije ako dugo nećeš koristiti proizvod ili ako su one potrošene. Nikada nemoj koristiti oštećene baterije. Upotrebļjavajte samo alkalne baterije. Umetni baterije pazeći da dobro okreneš polove. Nikada ne pokušavaj puniti baterije koje nisu predviđene za punjenje. Nikada ne izazivaj kratki spoj u držaču baterija.

SR

Важне информације о батеријама

Nikada ne koristite različite tipove baterija zajedno niti kombinaciju starih i novih baterija. Uvek izvadite baterije ukoliko proizvod neћete dјue vreme koristiti ili ukoliko su baterije prazne. Nikada ne koristite ošteћene baterije. Koristite samo alkalne baterije. Stavite baterije tako da su o polovima pravilno pozicionirani. Nikada ne pokušavajte da punitе baterije koje ne mogu da se pune. Nikada ne izazivajte kratak spoj u kuћишту za baterije.

MK

Важни информации за батериите

Nikoгаш не користете различни типови батерији заедно или комбинацију од стари и нови батерији. Секогаш отстранувајте ги батериите доколку не го користите производот подолго време или доколку се потрошиле. Никогаш не користете оштетени батерији. Користете само алкални батерији. Вметнете ги батериите така што точно ќе ги наместите половите. Никогаш не обидувајте се да ги полните батериите за еднократна употреба. Никогаш не предизвикувајте краток spoj на држачот за батерији.

SL

Pomembne informacije o baterijah

Nikoli ne uporabljajte skupaj različnih baterij ali kombinacije starih in novih baterij. Vedno odstranite baterije, če izdelka dlje časa ne boste uporabljali ali če so iztrošene. Nikoli ne uporabljajte poškodovanih baterij. Uporabljajte le alkalne baterije. Baterije vstavite tako, da so njihovi poli pravilno obrnjeni. Nikoli ne poskušajte polniti baterij, ki niso akumulatorske. Pazite, da ležišč za baterije ne boste spravili v kratek stik.

RO

Informații importante despre baterii

Nu folosiți niciodată împreună tipuri diferite de baterii, sau o combinație de baterii vechi și noi. Îndepărtați întotdeauna bateriile dacă produsul nu este folosit timp îndelungat sau dacă bateriile s-au epuizat. Nu folosiți niciodată baterii deteriorate. Utilizați numai baterii de tip alcalin. Introduceți bateriile astfel ca poli să fie poziționați corect. Nu încercați niciodată să reincercați baterii nereîncercabile. Nu scurcircuitați niciodată suportul bateriei.

BG

Важна информация за батериите

Nikoга не използвайте едновременно различни типове батерији или комбинация от стари и нови батерији. Винаги изваждайте батериите, ако изделието няма да се използва продължително време или ако батериите са се изтозили. Никога не използвайте повредени батерији. Използвайте само алкални батерији. Поставете батериите така, че полюсите да са разположени правилно. Никога не опитвайте да зареждате батерији, които не са акумулаторни. Никога не свързвайте на късо контактите на отделението за батериите.

LV

Svarīga informācija par baterijām

Nekad vienlaikus nelietojiet dažādu tipu, kā arī vecas un jaunās baterijas. Vienmēr izņemiet baterijas, ja tās ir izlādējušās vai ja produkts ilgāku laiku netiek lietots. Nekad nelietojiet bojātas baterijas. Izmantojiet tikai sārna tipa baterijas. Ievērojiet pareizu polaritāti. Nekad nemeģiniet uzlādēt baterijas, kas nav uzlādējamas. Nepieļaujiet īssavienojumu bateriju nodalījumā.

ET

Oluline teave patareide kohta

Ära kunagi kasuta koos erinevat tüüpi patareisid, samuti vanu ja uusi patareisid. Kui mänguasja ei kasutata pika aja jooksul, võta patarei sellest välja. Ära kunagi kasuta kahjustatud patareisid. Kasuta ainult leelis-patareisid. Pane patareid mänguasja sisse nii, et pluss- ja miinusleemi asend oleks õige. Ära kunagi proovi akulaadijaga laadida tavalisi patareisid. Patareipesa klemmide vahel ei tohi tekkida lühis.

LT

Svarbi informacija apie elementus

Vienu metu nenaudokite skirtingų elementų, taip pat su naujais elementais nenaudokite senų. Jei nenaudosite gaminio ilgesnį laiką arba jei elementai išsekę, visuomet išimkite juos iš gaminio. Niekada nenaudokite pažeistų elementų. Naudokite tik šarminius elementus. Elementus dėkite atsižvelgdami į jų poliškumą. Niekada nebandykite įkrauti vienkartinį elementų. Saugokitės, kad elementų dėklė nesukeltumėte trumpojo jungimo.

TR

Piller hakkında önemli bilgiler

Hiçbir zaman farklı tipte pilleri ya da eski pillerle yeni pilleri bir arada kullanmayın. Ürün uzun süre kullanılmayacaksa ya da piller bitmişse, pilleri ürünün içinden çıkarın. Hiçbir zaman zedelenmiş piller kullanmayın. Sadece alkalın piller kullanın. Pilleri kutularını doğru konumda olacak şekilde yerleştirin. Hiçbir zaman, şarj edilebilir olmayan pilleri şarj etmeye çalışmayın. Hiçbir zaman pil kutusuna kısa devre yaptırmayın.

AR

معلومات مهمة عن البطاريات

يحظر استخدام أنواع مختلفة من البطاريات معا أو مزيج من البطاريات القديمة والجديدة. احرص دائما على نزع البطاريات في حال عدم استخدام المنتج لفترة طويلة أو إذا نفذت طاقة البطاريات. تجنب استخدام البطاريات التالفة. لا تستخدم إلا البطاريات القلوية فقط. قم بتكيب البطاريات بحيث تكون الأقطاب في موضعها الصحيح. يحظر إعادة شحن البطاريات غير القابلة لإعادة الشحن. تجنب إحداث دائرة قصر في حامل البطارية.

ID

Informasi penting tentang baterai

Jangan gunakan baterai yang jenisnya berlainan, atau mencampur baterai lama dan baterai baru. Lepas baterai jika produk tidak akan digunakan untuk waktu lama atau jika baterai sudah lemah. Jangan gunakan baterai yang rusak. Gunakan hanya baterai alkali. Masukkan baterai dengan posisi kutub yang tepat. Jangan pernah coba mengisi ulang baterai biasa. Jangan pernah membuat arus pendek pada dudukan baterai.

MS

Maklumat penting tentang bateri

Jangan guna jenis bateri yang berbeza bersama-sama, atau gabungan bateri baharu dan lama. Tanggalkan bateri jika produk tidak akan digunakan untuk tempoh masa yang lama atau jika bateri telah kehabisan kuasa. Jangan guna bateri yang rosak. Guna bateri jenis alkali sahaja. Selitkan bateri supaya paksi berada pada kedudukan yang betul. Jangan cuba untuk mengecap semula bateri yang tidak boleh dicaskan semula. Jangan pintas litar pemegang bateri.



EN
Protect the environment by not disposing of this product with your household waste.
Check with your local authority for recycling advice and facilities.

DE
Schützen Sie die Umwelt und entsorgen Sie dieses Produkt nicht mit Ihrem Hausmüll.
Informationen zu Recycling-Möglichkeiten erhalten Sie bei den örtlichen Behörden.

FR
Protégez l'environnement : ne jetez pas ce produit avec vos autres déchets ménagers.
Contactez les autorités locales pour obtenir des informations sur le recyclage et connaître les points de collecte.

IT
Proteggi l'ambiente! Non smaltire questo prodotto con i rifiuti domestici.
Per consulenza sul riciclaggio dei rifiuti e le strutture di riciclaggio, rivolgersi alle proprie autorità locali.

NL
Bescherm het milieu: gooi dit product niet samen met het andere huisvuil weg.
Raadpleeg de plaatselijke instanties voor locaties van milieustations en advies over hergebruik.

ES
Proteja el medio ambiente no deshaciéndose de este producto junto con sus residuos domésticos.
Solicite asesoramiento e información sobre instalaciones de reciclaje a las autoridades locales.

DA
Beskyt miljøet! Smid ikke dette produkt ud sammen med husholdningsaffaldet.
Få vejledning om genbrug og genbrugsstationer hos din kommune.

IS
Stuðlið að umhverfisvernd með því að farga þessari vöru ekki með heimilissorpi.
Leitið upplýsinga um endurvinnslu- og förgunarstaði hjá yfirvöldum á hverjum stað.

FI
Tämä tuote on hävitettävä ympäristöstävällisesti ja erillään muusta talousjätteestä.
Tietoja kierrätyksestä ja keräyspisteiden sijainnista saat paikkakuntasi teknisestä virastosta.

SV
Skydda miljön genom att inte kasta denna produkt bland ditt hushållsavfall.
Kontakta din kommun för frågor om återvinning och miljöstationer.

NO
Beskytt miljøet. Ikke kast dette produktet i husholdningsavfallet.
Kontakt kommunen for veiledning om gjenbruk og miljøstasjoner.

PT
Proteja o ambiente não eliminando este produto com o seu lixo doméstico.
Consulte as autoridades locais para informação sobre reciclagem e sistemas de recolha.

EL
Προστατέψτε το περιβάλλον. Μην πετάτε αυτό το προϊόν μαζί με τα συνηθισμένα οικιακά απορρίμματα.
Επικοινωνήστε με τις τοπικές αρχές σχετικά με συμβουλές και εγκαταστάσεις ανακύκλωσης.

JA
環境保護のため、本製品は家庭ごみとは別に処分してください。
リサイクルに関する指示や施設については、お住まいの地方自治体にお問い合わせください。

ZH
注意保护环境，请勿将本产品与生活垃圾一起丢弃处理。
请咨询当地相关部门，了解与回收相关的设施与建议。

KO
환경 보호를 위해 이 제품을 생활폐기물과 함께 버리지 마십시오.
재활용 방법 및 시설에 관한 사항은 현지 관계 당국에 문의하십시오.

RU
Позаботьтесь об окружающей среде: не утилизируйте этот продукт вместе с бытовым мусором.
Узнайте в органах местного самоуправления правила вторичной переработки и утилизации таких отходов.

PL
Aby chronić środowisko naturalne, nie należy wyrzucać tego produktu wraz z odpadkami z gospodarstwa domowego.
W celu uzyskania wskazówek dotyczących recyklingu oraz adresów zakładów należy skontaktować się z lokalnym urzędem.

CZ
Nevyhazujte tento produkt do domácího odpadu, chraňte životní prostředí.
Zjistěte si prosím u místních úřadů možnosti recyklace a dostupná zařízení.

SK
Nevyhádzajte tento produkt do domáceho odpadu, chráňte životné prostredie.
Zistite si na miestnych úradoch možnosti recyklácie a dostupné zariadenia.

HU
Környezetét óvja, ha ettől a terméktől nem a háztartási hulladékkal együtt válik meg.
Érdeklődjék a lakóhelyéhez közel eső hatóságnál az újrahasznosítás módjáról és lehetőségeiről.

UA
Допоможіть захистити довкілля: не утилізуйте цей виріб разом із побутовим сміттям.
Вказівки з утилізації та відомості про пункти прийому з'ясуєте в місцевих компетентних органах.

HR
Zaštitite okoliš tako da ovaj proizvod ne odložite u otpad zajedno s kućanskim otpadom.
Od lokalnih vlasti zatražite savjet ili informacije o pogonima za recikliranje.

SR
Zaštitite životnu sredinu tako što nećete da odlažete ovaj proizvod sa kućnim otpadom.
Raspitajte se kod lokalnog nadležnog organa o načinu reciklaže i o sabirnom centru.

MK
Zaštitite ja okolinata taka što nema da se oslobodite od proizvodot co domashniot otpad.
Konultirajte se co lokalnite vlasti za da doznaete za sovetite i objektite za recikliranje.

SL
Zaščitite okolje! Okolje varujte tako, da tega izdelka ne zavržete skupaj z gospodinjiskimi odpadki.
Pri krajevni upravi preverite, kakšne možnosti in kateri obrati za recikliranje obstajajo v vaši okolici.

RO
Protejați mediul înconjurător și nu vă debarasați de acest produs împreună cu deșeurile menajere
Consultați autoritățile locale pentru îndrumări și facilități de reciclare.

BG
Защитете околната среда и не изхвърляйте този продукт заедно с битовите си отпадъци.
Свържете се с местните власти относно съвети и съоръжения за рециклиране.

LV
Lai saudzētu vidi, neizmetiet šo izstrādājumu kopā ar sadzīves atkritumiem.
Vērsties vietējās varas iestādēs, lai noskaidrotu, kur un kā tas nododams pārstrādei.

ET
Keskkonda saate kaitsta nii, et ei kõrvalda seda toodet koos olmejäätmetega.
Nõuandeid toote taaskasutusse võtmise ja ümbertöötlemispunktide kohta saate asjaomaselt kohalikult asutuselt.

LT
Saugokite aplinką: nemeskite šio produkto kartu su buitinėmis atliekomis.
Atsižvelkite į savo vietos valdžios rekomendacijas dėl pakartotinio panaudojimo ir sąlygas.

TR
Bu ürünü, evsel atıklarla birlikte atmayarak çevreyi koruyun.
Geri dönüşüm tavsiyeleri ve tesisler hakkında bilgi için yerel yönetimle iletişimi kurun.

AR
احم البيئة بعدم التخلص من هذا المنتج مع الخلفات المنزلية.
استشر السلطة المحلية لديك للحصول على نصح بخصوص إعادة تدوير الخلفات ومرافقها.

ID
Jagalang lingkungan dengan tidak membuang produk ini bersama sampah rumah tangga Anda.
Periksa peraturan pemerintah setempat tentang saran dan fasilitas daur ulang.

MS
Lindungi alam sekitar dengan tidak melupuskan produk ini bersama sisa isi rumah anda.
Rujuk pihak berkuasa tempatan anda tentang nasihat dan kemudahan kitar semula.



EN
WARNING: This product contains a Button or Coin Cell Battery.
A swallowed Button or Coin Cell battery can cause internal chemical burns in as little as two hours and lead to death. Dispose of used batteries immediately. Keep new and used batteries away from children. If you think batteries might have been swallowed or placed inside any part of the body, seek immediate medical attention.

DE
ACHTUNG: Dieses Produkt enthält eine Knopfzellenbatterie.
Eine verschluckte Knopfzellenbatterie kann innere chemische Verbrennungen verursachen und in weniger als zwei Stunden zum Tod führen. Entsorge umgehend gebrauchte Batterien. Halte neue und gebrauchte Batterien von Kindern fern. Wenn du glaubst, dass Batterien verschluckt wurden oder sich in einem Körperteil befinden, hole umgehend medizinische Hilfe.

FR
AVERTISSEMENT : Ce produit contient une pile bouton.
L'ingestion d'une pile bouton peut provoquer des brûlures chimiques internes en seulement deux heures et provoquer la mort. Jeter immédiatement les piles usagées. Conserver les piles neuves et usagées hors de portée des enfants. Si vous suspectez l'ingestion d'une pile ou sa présence où que ce soit à l'intérieur du corps, consultez immédiatement un médecin.

IT
ATTENZIONE: questo prodotto contiene una batteria a bottone.
Se inghiottita, una batteria a bottone può causare ustioni chimiche interne in sole due ore, con possibile morte. Smaltire immediatamente le batterie usate. Tenere le batterie nuove e usate lontano dai bambini. Se si pensa che una batteria sia stata inghiottita o inserita in una parte del corpo, rivolgersi immediatamente a un medico.

NL
WAARSCHUWING: dit product bevat een knoopcelbatterij.
Als een knoopcelbatterij wordt ingeslikt, kan deze binnen twee uur chemische brandwonden veroorzaken in het lichaam. Het inslikken van een dergelijke batterij kan zelfs leiden tot overlijden. Gooi gebruikte batterijen onmiddellijk weg. Bewaar nieuwe en gebruikte batterijen buiten bereik van kinderen. Als je denkt dat een kind batterijen heeft ingeslikt of ze in een lichaamsopening heeft gestopt, raadpleeg je direct een arts.

ES
ADVERTENCIA: Este producto contiene una pila de botón.
Ingerir una pila de botón puede dar lugar a quemaduras químicas internas en tan sólo dos horas y provocar la muerte. Las pilas usadas deben desecharse inmediatamente. Mantenga las pilas nuevas y usadas fuera del alcance de los niños. Si sospecha de la ingestión o la introducción de pilas en cualquier parte del cuerpo, busque atención médica inmediatamente.

DA
ADVARSEL: Dette produkt indeholder et knap- eller møntcellebatteri.
Hvis et knap- eller møntcellebatteri sluges, kan det forårsage indvendige ætsninger på blot to timer og medføre døden. Bortskaf brugte batterier omgående. Hold både nye og brugte batterier uden for børns rækkevidde. Hvis du har mistanke om, at batterierne kan være blevet slugt eller kommet ind i nogen del af kroppen, skal du omgående søge lægehjælp.

IS
VIÐVÖRUN: Þessi vara inniheldur hnapparahlöðu eða flata rafhlöðu.
Ef hnapparahlöða eða flöt rafhlaða er gleypt getur hún valdið innvortis efnabruna á innan við tveimur klukkustundum og leitt til dauða. Fargaðu notuðum rafhöldum tafarlaust. Geymdu nýjar og notaðar rafhöður þar sem börn ná ekki til. Ef þú telur að rafhöldur hafi verið gleyptar eða á annan hátt komist inn í einhvern hluta líkamans skaltu tafarlaust leita læknaðstoðar.

FI
VAROITUS: Tämä tuote sisältää pienen tai isokokoisien nappipariston.
Nieltynä pieni tai isokokoinen nappiparisto voi aiheuttaa sisäisiä kemiallisia palovammoja jo kahden tunnin kuluessa ja johtaa kuolemaan. Käytetyt paristot on toimitettava heti keräyspisteeseen. Pidä uudet ja käytetyt paristot poissa lasten ulottuvilta. Jos epäilet jonkun nielelleen pariston tai laittaneensa pariston kehoonsa, vie hänet välittömästi lääkäriin.

SV
VARNING: Denna produkt innehåller ett knapp- eller myntcells batteri.
Förtäring av ett knapp- eller myntcells batteri kan orsaka inre kemiska brännskador på så kort tid som två timmar och leda till döden. Kassera förbrukade batterier omedelbart. Förvara nya och använda batterier utom räckhåll för barn. Om du tror att batterierna kan ha svalts eller placerats inuti någon del av kroppen, sök omedelbart läkarvård.

NO
ADVARSEL: Dette produktet inneholder et knapp- eller myntcellebatteri.
Ved svelging kan knapp- eller myntcellebatterier gi kjemisk brannskade innvendig på bare to timer og føre til død. Brukte batterier skal avhendes øyeblikkelig. Nye og brukte batterier skal oppbevares utilgjengelig for barn. Hvis du tror at batterier har blitt svelget eller puttet inn andre steder i kroppen, må du kontakte lege øyeblikkelig.

PT
AVISO: Este produto contém uma pilha tipo botão ou moeda.
Uma pilha tipo botão ou moeda que tenha sido engolida pode provocar queimaduras químicas internas em menos de duas horas e levar à morte. Elimine as pilhas usadas imediatamente. Mantenha as pilhas novas e usadas fora do alcance das crianças. Se pensa que as pilhas podem ter sido engolidas ou colocadas no interior de alguma parte do corpo, procure de imediato assistência médica.

EL
ΠΡΟΕΙΔΟΠΟΙΗΣΗ: Αυτό το προϊόν περιέχει μία Στρογγυλή Μπαταρία Μεγέθους Κοιμπίου ή Κέρματος.
Η κατάποση μιας Στρογγυλής Μπαταρίας Μεγέθους Κοιμπίου ή Κέρματος μπορεί να προκαλέσει εσωτερικά χημικά εγκαύματα σε μόλις δύο ώρες και να οδηγήσει σε θάνατο. Πετάξτε αμέσως τις χρησιμοποιημένες μπαταρίες. Κρατήστε τις καινούριες και τις χρησιμοποιημένες μπαταρίες μακριά από τα παιδιά. Εάν νομίζετε ότι κάποια μπαταρία έχει καταποθεί ή τοποθετηθεί εντός οποιουδήποτε μέρους του σώματος, ζητήστε αμέσως ιατρική βοήθεια.

JA
警告：本製品には、ボタン型またはコイン型の電池が使用されています。
ボタン型またはコイン型電池は誤飲すると2時間以内に体内で科学火傷を起こし、死に至る恐れがあります。使用済みの電池は直ちに廃棄してください。新しい電池および使用済み電池は、どちらもお子様の手の届かないところに保管してください。電池を誤飲した恐れがある、または電池が身体のどこかに入った恐れがある場合は、直ちに医師の診察を受けてください。

ZH
警告：本品内含一颗纽扣电池。
吞咽的纽扣电池仅在两小时内就会引起体内化学灼伤并导致死亡！
请立即处理使用过的电池。请将新、旧电池放置到儿童接触不到的地方。如果电池被不慎吞下，或被置入身体的任何一个部位，请立即就医！

KO
경고: 이 제품에는 버튼 또는 코인 셀 배터리가 포함되어 있습니다.
코인 셀 배터리를 삼킬 경우, 빠르면 2시간 이내에 체내에서 화학적 화상이 일어나고 심하면 사망에 이를 수 있습니다. 다 쓴 배터리는 즉시 폐기하십시오. 배터리를 어린이의 손에 닿지 않는 곳에 보관하십시오. 배터리를 삼켰거나 신체 어느 부위에든 들어간 것으로 판단될 경우, 즉각 의사의 도움을 구하십시오.

RU
ПРЕДОСТЕРЕЖЕНИЕ. Эта игрушка работает от батарейки таблеточного или кнопочного типа.
Проглатывание батарейки таблеточного или кнопочного типа может (в течение двух часов) вызвать химические ожоги внутренних органов и привести к летальному исходу. Своевременно утилизируйте использованные батарейки. Храните новые и использованные батарейки в местах, недоступных для детей. Если у вас есть основания полагать, что ребенок проглотил батарейку или она попала внутрь какой-либо части его тела, немедленно обратитесь за медицинской помощью.

PL
OSTRZEŻENIE: w tym produkcie znajduje się płaska okrągła bateria.
Połknięcie takiej baterii może spowodować chemiczne oparzenia wewnętrzne już po dwóch godzinach, a także doprowadzić do śmierci. Gdy bateria się zużyje, należy ją natychmiast zutylizować. Nowe i używane baterie należy przechowywać z dala od dzieci. W przypadku stwierdzenia, że baterie mogły zostać połknięte lub inaczej trafić do organizmu, należy natychmiast poszukać pomocy lekarskiej.

CZ
VAROVÁNÍ: Tento výrobek obsahuje knoflíkovou nebo mincovou baterii.
Spolknutí knoflíkové nebo mincové baterie může během pouhých 2 hodin způsobit vnitřní poleptání sliznice a v některých případech mit za následek smrt. Použité baterie ihned vyjměte a zlikvidujte. Nové i použité baterie uchovávejte mimo dosah dětí. V případě spolknutí či uviznutí baterie v některé části těla okamžitě vyhledejte lékařskou pomoc.

SK
POZORNENIE: Tento produkt obsahuje gombíkovú alebo mincovú batériu.
Prehĺtnutie gombíkovej alebo mincovej batérie môže spôsobiť vnútorné chemické popálenie už do dvoch hodín a viesť k úmrtiu. Použité batérie ihneď vyhodte. Nové aj použité batérie uchováajte mimo dosahu detí. Ak si myslíte, že mohlo dôjsť k prehĺtnutiu batérie alebo sa batéria mohla dostať do vnútra ktorejkoľvek časti tela, okamžite vyhľadajte lekársku pomoc.

HU
FIGYELMEZTETÉS: Ez a termék gomebelemet illetve lapos gomebelemet tartalmaz!
A lenyelt gomebelem vagy lapos gomebelem akár két óra alatt is belső vagy sérüléseket okozhat, ami halálhoz vezetethet. Az elhasznált elemeket azonnal dobja ki! Az új és a használt elemeket ne adja gyermekek kezébe! Ha úgy gondolja, hogy valaki lenyelt egy elemet, vagy bekerült valakinek valamely testrészébe, akkor azonnal kérjen orvosi segítséget!

UA
ОБЕРЕЖНО. Продукт містить мініатюрну батарейку типу «таблетка». Якщо проковтнути мініатюрну батарейку, вона може спричинити внутрішні хімічні опіки протягом двох годин і призвести до смерті. Негайно утилізуйте використані батарейки. Зберігайте нові та використані батарейки недоступними для дітей. Якщо вам здається, що дитина проковтнула батарейку чи вона опинилася в будь-якій частині тіла дитини, негайно зверніться до лікаря.

HR
UPOZORENJE: Ovaj proizvod sadrži gumbastu bateriju ili bateriju oblika kovanice. Ako se gumbasta baterija ili baterija oblika kovanice proguta, za samo dva sata može uzrokovati unutarnje kemijske opekline i izazvati smrt. Iskorištene baterije odmah odložite u otpad. Čuvajte nove i stare baterije dalje od djece. Ako mislite da je baterija progutana ili je dospjela u bilo koji dijela tijela, odmah zatražite liječničku pomoć.

SR
УПОЗОРЕЊЕ: Овај производ садржи дугмасту батерију. Прогутана дугмаста батерија може да доведе до интерних хемијских опекотина већ за два сата и доводи до смрти. Одмах одложите искоришћене батерије у отпад. Чувајте нове и искоришћене батерије ван домаћаја деце. Ако мислите да је дошло до гутања батерија или стављања у било који део тела, одмах потражите помоћ лекара.

MK
ПРЕДУПРЕДУВАЊЕ: Овој производ садржи батерија тип копче или тип монета.

Проголтавањето на батерија тип копче или тип монета може да предизвика внатрешно хемиско горење во рок од два часа и да доведе до смрт. Искрфлете ги веднаш искористените батери. Држете ги новите и користените батерији подалеку од деца. Ако мислите дека е можно батериите да се проголтани или поставени во кој било дел на телото, веднаш побарајте медицинска помош.

SL
OPOZORILO: Ta izdelek vsebuje gumbasto baterijo. Če oseba požre gumbasto baterijo, lahko to povzroči kemične opekline notranjih organov že v dveh urah po zaužitju. Tovrstne poškodbe lahko vodijo v smrt. Iztrošene baterije takoj zavržite. Pazite, da nove ali iztrošene baterije ne bodo v dosegu otrok. Če menite, da je oseba zaužila baterijo ali si jo vstavila v kateri koli del telesa, takoj poiščite zdravniško pomoč.

RO
AVERTIZARE: Acest produs conține o baterie de tip pastilă. Înghițirea unei baterii de tip pastilă poate cauza arsuri chimice interne în doar două ore, ducând la deces. Debarasați-vă imediat de bateriile uzate. Nu lăsați bateriile noi și uzate la îndemâna copiilor. Dacă credeți că bateriile ar fi putut fi înghițite sau ar fi putut ajunge în interiorul oricărei părți a corpului, solicitați imediat asistență medicală.

BG
ПРЕДУПРЕЖДЕНИЕ: Този продукт съдържа батерия тип „копче“ или „монета“. При поглъщане батериите тип „копче“ или „монета“ могат да предизвикат вътрешни химически изгаряния в рамките на по-малко от два часа и да доведат до смърт. Незабавно изхвърляйте използваните батерии. Дръжте новите и стари батерии далеч от деца. Ако смятате, че е възможно батериите да са били поглънати или да са попаднали където и да е вътре в тялото, потърсете незабавно медицинска помощ.

LV
BRĪDINĀJUMS. Šim produktam ir pogas jeb monētas tipa akumulators. Ja pogas jeb monētas tipa akumulators tiek norīts, tas jau divu stundu laikā var izraisīt iekšējus ķīmiskus apdegumus un izraisīt nāvi. Nekavējoties utilizējiet izlietotos akumulatorus. Jaunus un lietotus akumulatorus glabājiet bērniem nepieejamā vietā. Ja uzskatāt, ka akumulators varētu būt norīts vai ievietots kādā ķermeņa daļā, nekavējoties vērsieties pēc medicīniskās palīdzības.

ET
HOIATUS! See toode sisaldab nõõp- või müntpatareid. Alla neelatud nõõp- või müntpatarei võib tekitada sisemisi keemilisi põletusi kõigest kahe tunniiga ning põhjustada surma. Kõrvaldage kasutatud patareid viivitamatult. Hoidke uusi ja kasutatud patareid lastele kättesaamatus kohas. Kui arvate, et keegi on patareid alla neelanud või need on sattunud mõnda kehaosasse, pöörduge kohe arsti poole.

LT
ĮSPĖJIMAS. Šiame gaminyje yra sagos arba monetos formos baterija. Praryta sagos arba monetos formos baterija gali sukelti vidinius cheminius nudeginimus greičiau nei per dvi valandas ir galiausiai sukelti mirtį. Panaudotas baterijas nedelsiant utilizuokite. Naujas ir panaudotas baterijas laikykite atokiau nuo vaikų. Jei manote, kad vaikas galėjo praryti arba įsprausti bateriją sau į kūną, nedelsdami kreipkitės medicininės pagalbos.

TD

TR
UYARI: Bu ürün bir düğme pil içerir. Yutulmuş düğme pil, iki saat gibi kısa bir sürede iç kimyasal yanıklara neden olabilir ve ölüme yol açabilir. Kullanılmış pilleri derhal atın. Yeni ve kullanılmış pilleri çocuklardan uzak tutun. Pillerin yutulmuş ya da vücudun başka bir yerine sokulmuş olabileceğini düşünüyorsanız derhal doktora başvurun.

AR
تحذير: يحتوي هذا المنتج على بطارية خلايا قرصية أو بطارية خلايا على شكل عملة. قد يؤدي ابتلاع بطارية خلايا قرصية أو بطارية خلايا على شكل عملة إلى حدوث حروق كيميائية داخلية خلال فترة قصيرة لا تتجاوز ساعتين وقد يؤدي إلى الوفاة. يرجى التخلص من البطاريات المستعملة على الفور مع الاحتفاظ بالبطاريات الجديدة والمستعملة بعيداً عن متناول الأطفال. إذا كنت تعتقد أن البطاريات تم ابتلاعها أو إدخالها إلى أي جزء من أجزاء الجسم، فاطلب المساعدة الطبية على الفور.

ID
PERINGATAN: Produk ini berisi Baterai Sel Kancing. Baterai Sel Kancing yang tertelan dapat mengakibatkan luka bakar kimiawi dalam tubuh minimal setelah dua jam dan dapat mengakibatkan kematian. Segera buang baterai yang sudah tidak digunakan. Jauhkan baterai baru maupun bekas dari jangkauan anak-anak. Jika Anda curiga baterai telah tertelan atau masuk ke dalam tubuh, segeralah minta bantuan dokter.





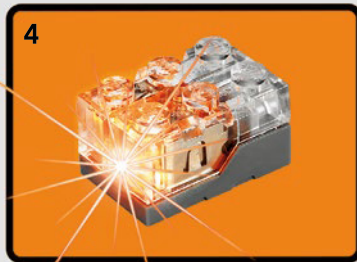
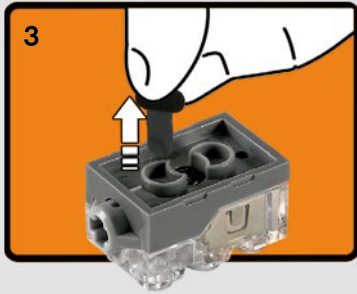
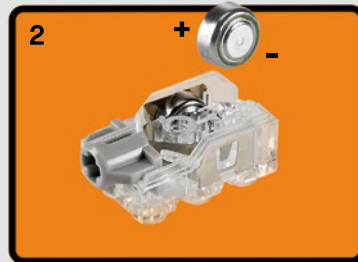
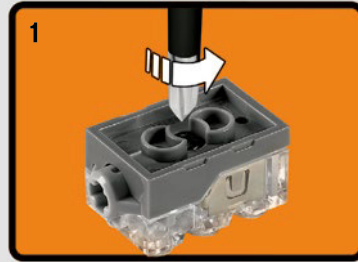



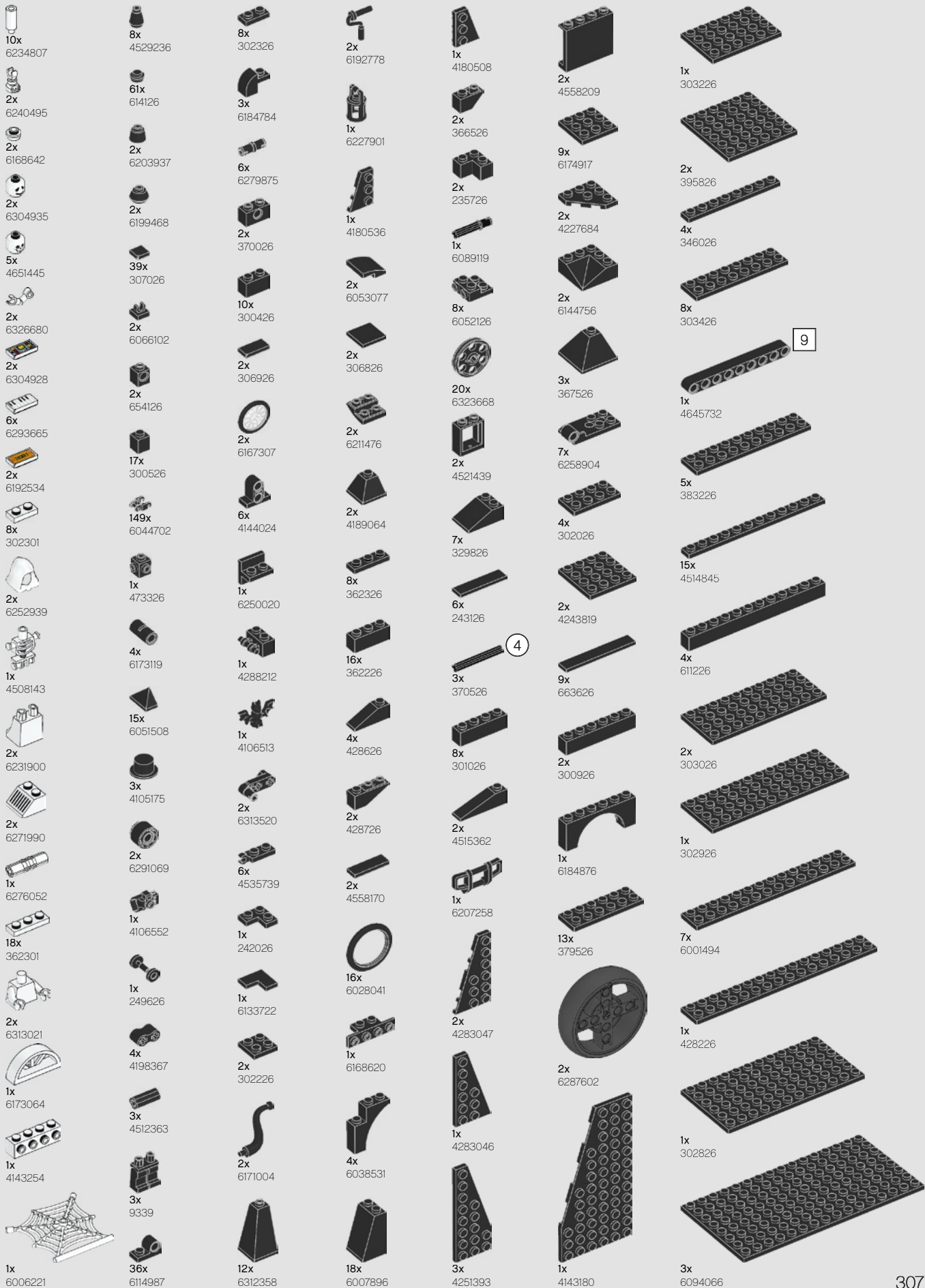













































































































MS
AMARAN: Produk ini mengandungi Bateri Sel Butang atau Syiling. Tertelan bateri Sel Butang atau Syiling boleh mengakibatkan lecuran kimia dalaman dalam tempoh sekurang-kurangnya dua jam dan menyebabkan kematian. Buang bateri terpakai dengan serta-merta. Jauhkan bateri baharu dan terpakai daripada anak-kanak. Jika anda mendapati bateri mungkin telah ditelan atau termasuk ke dalam mana-mana bahagian badan, dapatkan rawatan perubatan dengan segera.

EN Please retain the leaflet as it contains important information
 DE Die Broschüre bitte aufbewahren, sie enthält wichtige Informationen
 FR Veuillez conserver le dépliant car il contient des informations importantes
 IT Conserva l'opuscolo in quanto contiene informazioni importanti
 NL Bewaar a.u.b. de folder: die bevat belangrijke informatie
 ES Conserve el folleto; contiene información importante
 DA Gem hæftet, da det indeholder vigtige oplysninger
 IS Geymið bæklinginn þar sem hann inniheldur mikilvægar upplýsingar
 FI Säilytä esite, koska se sisältää tärkeää tietoa
 SV Spara broschyren eftersom den innehåller viktig information
 NO Heftet inneholder viktig informasjon og skal beholdes
 PT Por favor guarde o folheto, pois contém informação importante
 EL Κρατήστε το φυλλάδιο γιατί περιέχει σημαντικές πληροφορίες
 JA 説明書には重要な情報が含まれていますので保管しておいてください
 ZH 本说明书包含重要信息, 请务必妥善保存
 KO 중요한 정보가 담겨있으므로 리플릿을 보관해 두세요
 RU Пожалуйста, сохраните упаковку, поскольку она содержит важную информацию
 PL Prosimy zachować ulotkę, ponieważ zawiera ona ważne informacje
 CZ Ponechte si prosím leták, neboť obsahuje důležité informace
 SK Ponechajte si prosím leták, pretože obsahuje dôležité informácie
 HU Kérjük, őrizze meg a szórólapot, mert fontos tudnivalókat tartalmaz
 UA Будь ласка, зберігайте упаковку, оскільки вона містить важливу інформацію
 HR Spremite letak jer sadrži važne obavijesti
 SR Молимо да сачувате упутство јер се у њему налазе важне информације
 MK Чувајте ја брошурата бидејќи содржи важни информации
 SL Prosimo, da brošurico shranite, saj so v njej pomembne informacije
 RO Vă rugăm să păstrați broșura întrucât conține informații importante
 BG Запазете листовката, тъй като вътре има ценна информация
 LV Lūdzu, saglabājiet bukletu, jo uz tā ir norādīta svarīga informācija
 ET Hoidke infoleht alles, sest sellele on märgitud oluline teave
 LT Išsaugokite informacinį lapelį, nes ant jo pateikiama svarbi informacija
 TR Önemli bilgiler içerdiğinden dolayı lütfen broşürü saklayın
 AR الرجاء الاحتفاظ بهذه النشرة لاحتوائها على معلومات هامة
 ID Harap simpan lembaran ini karena berisi informasi penting
 MS Sila simpan lembar maklumat kerana ia mengandungi maklumat penting



1:1
2x  1.5V



| | | | | | | |
|---|---|--|--|---|---|---|
|  26x 4211242 |  3x 4629736 |  15x 4211189 |  1x 4211247 |  6x 4529241 |  6x 6011459 |  2x 4211436 |
|  2x 6071274 |  2x 6117976 |  5x 6150305 |  2x 4216945 |  9x 6167667 |  64x 4211388 |  1x 4211815 |
|  4x 4620075 |  2x 6008297 |  1x 4211185 |  15x 4585337 |  2x 6284071 |  18x 4211398 |  2x 6251044 |
|  2x 6270052 |  2x 4565394 |  1x 4211185 |  2x 4263776 |  144x 4211525 |  2x 4211437 |  2x 6304933 |
|  1x 4550736 |  4x 6146858 |  5x 4579690 |  2x 4263776 |  6x 6271165 |  2x 6206249 |  28x 4211428 |
|  6x 6172757 |  2x 4271949 |  1x 4211186 |  3x 4271874 |  12x 4211399 |  4x 6225230 |  13x 4211429 |
|  10x 4531751 |  6x 4211200 |  2x 4211225 |  1x 6096701 |  2x 4211415 |  3x 6015344 |  1x 6211969 |
|  19x 4211149 |  1x 4211202 |  1x 6280388 |  10x 4211211 |  2x 6262085 |  2x 6266251 |  2x 4251163 |
|  2x 6092590 |  4x 4211221 |  4x 6159763 |  3x 4211207 |  4x 6061702 |  18x 6123809 |  18x 6225228 |
|  2x 4211252 |  1x 4520638 |  3x 4221590 |  1x 6096716 |  141x 4211389 |  3x 6121614 |  2x 4211419 |
|  2x 6192310 |  2x 6245259 |  2x 4636170 |  1x 4223729 |  13x 4211535 |  1x 6088708 |  1x 4211773 |
|  10x 4211150 |  1x 4211220 |  2x 4655611 |  1x 6096716 |  2x 4213567 |  6x 4211461 |  1x 4217918 |
|  4x 4211151 |  2x 4211152 |  2x 4211193 |  1x 6055145 |  1x 4211508 |  1x 6304930 |  24x 4211386 |
|  51x 6058084 |  1x 6323704 |  2x 4211193 |  2x 6004996 |  2x 6248890 |  41x 4211349 |  1x 4211570 |
|  4x 6035547 |  37x 4595814 |  4x 6044725 |  2x 6004996 |  1x 4650645 |  9x 4211353 |  1x 6297209 |
|  37x 4595814 |  4x 6044725 |  3x 4216615 |  2x 6004996 |  2x 4640536 |  15x 4211387 |  3x 4211356 |
|  37x 4595814 |  4x 6044725 |  3x 4216615 |  2x 6004996 |  1x 4227657 |  2x 6007894 |  27x 4211394 |

23x
4211445

1x
4211441

1x
74335

12x
6236437

2x
6254484

2x
4579260

1x
6163633

2x
6304922

11x
6256117

1x
4525464

1x
6240227

2x
4570877

2x
6232135

1x
6290270

1x
6102769

2x
6163989

2x
6271167

4x
6245265

2x
4615606

4x
4565452

1x
6227248

1x
4211395

4x
4211466

1x
6182787

8x
6240550

1x
6212081

5x
6286492

4x
6214214

5x
4560183

2x
4211452

2x
4261301

1x
6247785

2x
6269941

8x
4666579

9x
6222063

4x
4622742

2x
4211452

1x
6275271

1x
6248859

1x
6248859

2x
6321305

1x
6132264

4x
4211385

1x
6102575

1x
6123730

1x
6238673

2x
6000743

12x
4113917

2x
6064049

2x
6195314

1x
4211795

1x
6270320

1x
6225808

5x
4613761

2x
6174925

2x
6132790

6x
4211393

4x
4211406

1x
6290549

4x
6252043

2x
6208727

3x
4114084

2x
6132767

5x
4211438

2x
4211408

2x
6071270

8x
6240551

3x
6186003

6x
4114077

1x
6093064

2x
4211805

1x
4166618

1x
4216656

1x
6247793

2x
4162916

3x
4114064

1x
4496699

9x
4211392

1x
4211405

2x
4169960

1x
6247795

4x
6103405

1x
6037890

12x
4528604

3x
4211425

1x
4211405

2x
6057458

1x
6247364

2x
4162916

1x
6304921

4x
4616711

24x
4211481

1x
4211401

2x
6130007

1x
6047056

2x
4264569

3x
4124067

2x
6132768

6x
4251149

6x
4514846

1x
4153707

1x
6047056

1x
4667595

1x
6288331

2x
4626904

5x
4211521

3x
4211522

1x
371024

1x
6267125

1x
6097420

2x
4143409

1x
6015424

3x
4211366

3x
4211366

1x
366624

1x
6235080

2x
6285134

6x
6130009

1x
379528

4x
4613196

10x
4206482

1x
6240515

2x
614323

1x
6240515

4x
4613196

7

3

7

3,2

- 4x 6171103
- 8x 4529240
- 14x 4211090
- 3x 6012451
- 3x 6221607
- 19x 4211063
- 3x 6092572
- 3x 6261355
- 1x 6184977
- 1x 6269999
- 24x 4210762
- 4x 6230233
- 2x 6055313
- 12x 4211096
- 2x 6100124
- 2x 6126083
- 7x 4211094
- 19x 6228923
- 1x 4568734
- 7x 4211133
- 5x 6149768
- 2x 4211068
- 6x 4211001
- 1x 4648256
- 8x 6092649
- 2x 6313189
- 1x 4222693
- 1x 6100931
- 4x 4210862
- 4x 4211000
- 4x 4645099
- 5x 6133119
- 1x 4211006
- 1x 4211007
- 4x 6083620
- 2x 6185675
- 1x 4210999
- 10x 4213607
- 6x 6039176
- 2x 4227398
- 2x 6118832
- 2x 4508553
- 1x 6079036
- 3x 4595710
- 2x 4210798

4

55







- 1x 6274738
- 2x 6168665
- 51x 6252258
- 37x 6254552
- 1x 6286876
- 1x 6246888
- 1x 6304920
- 1x 6245253
- 1x 6304919
- 16x 6207933
- 1x 6300091
- 4x 6257902
- 13x 6285441
- 5x 6060803
- 2x 6195089
- 8x 4536675
- 13x 4523159
- 25x 6190252
- 4x 6186672
- 2x 6256803
- 4x 6146054
- 32x 6290401
- 6x 6060800
- 1x 4529247
- 1x 4505990
- 2x 6295686
- 20x 4523160
- 2x 6212377
- 2x 6219088
- 4x 6112307
- 1x 6092594
- 1x 306221
- 4x 6271820
- 4x 4142865
- 1x 403221
- 1x 6133493
- 1x 6132541

- 1x 6100930
- 1x 6219677
- 1x 6178488
- 1x 6092565
- 6x 6209519
- 1x 243121
- 1x 6286432
- 7x 300121
- 2x 6130002
- 1x 6167932
- 17x 6194729
- 1x 6065515
- 1x 6093516
- 2x 4519970
- 52x 6058221
- 1x 6046943
- 2x 6177917
- 20x 6252667
- 12x 6223039
- 12x 4519946
- 7x 6312357
- 1x 6152450
- 1x 6275092
- 1x 6205345
- 1x 6310580
- 1x 6271205
- 2x 6219624
- 2x 6058245
- 100x 6058242
- 4x 6016483
- 33x 6312356
- 192x 6024722
- 46x 6062697
- 2x 6278089
- 31x 6020143
- 39x 6058219
- 1x 6273354

6



Customer Service
Kundenservice
Service Consommateurs
Servicio Al Consumidor
LEGO.com/service or dial

00800 5346 5555 :         

1-800-422-5346 :  



FEEDBACK AND WIN

FEEDBACK AND WIN

Your feedback will help shape the future development of this product series.

Please visit:

FEEDBACK UND GEWINNEN

Dein Feedback trägt zur Weiterentwicklung dieser Produktreihe bei.

Geh auf:

COMMENTEZ ET GAGNEZ

Vos commentaires nous aideront à concevoir les futurs produits de cette gamme.

Rendez-vous sur :

COMENTA Y GANA

Tu opinión nos ayudará a dar forma al desarrollo de esta serie de productos en el futuro.

Visita:

反馈有奖

您的反馈将有助于我们在今后改进本系列产品。

请访问：

[LEGO.com/productfeedback](https://www.lego.com/productfeedback)

By completing, you will automatically enter a drawing to win a LEGO® set.

Terms & Conditions apply.

Durch Ausfüllen nimmst du automatisch an der Verlosung eines LEGO® Preises teil.

Es gelten die Teilnahmebedingungen.

En envoyant vos commentaires, vous serez automatiquement inscrit(e) à un tirage au sort qui vous permettra de remporter un prix LEGO®.

Offre soumise à conditions.

Al contestar, participarás automáticamente en el sorteo y podrás ganar un set LEGO®.

Sujeto a Términos y Condiciones.

完成我们的反馈调查，即可自动进入抽奖环节，赢取乐高® 套装。

适用《条款和条件》。

