

GHOSTBUSTERS™ ECTO-1

BUILDING INSTRUCTIONS
INSTRUCTIONS DE MONTAGE
INSTRUCCIONES DE CONSTRUCCIÓN

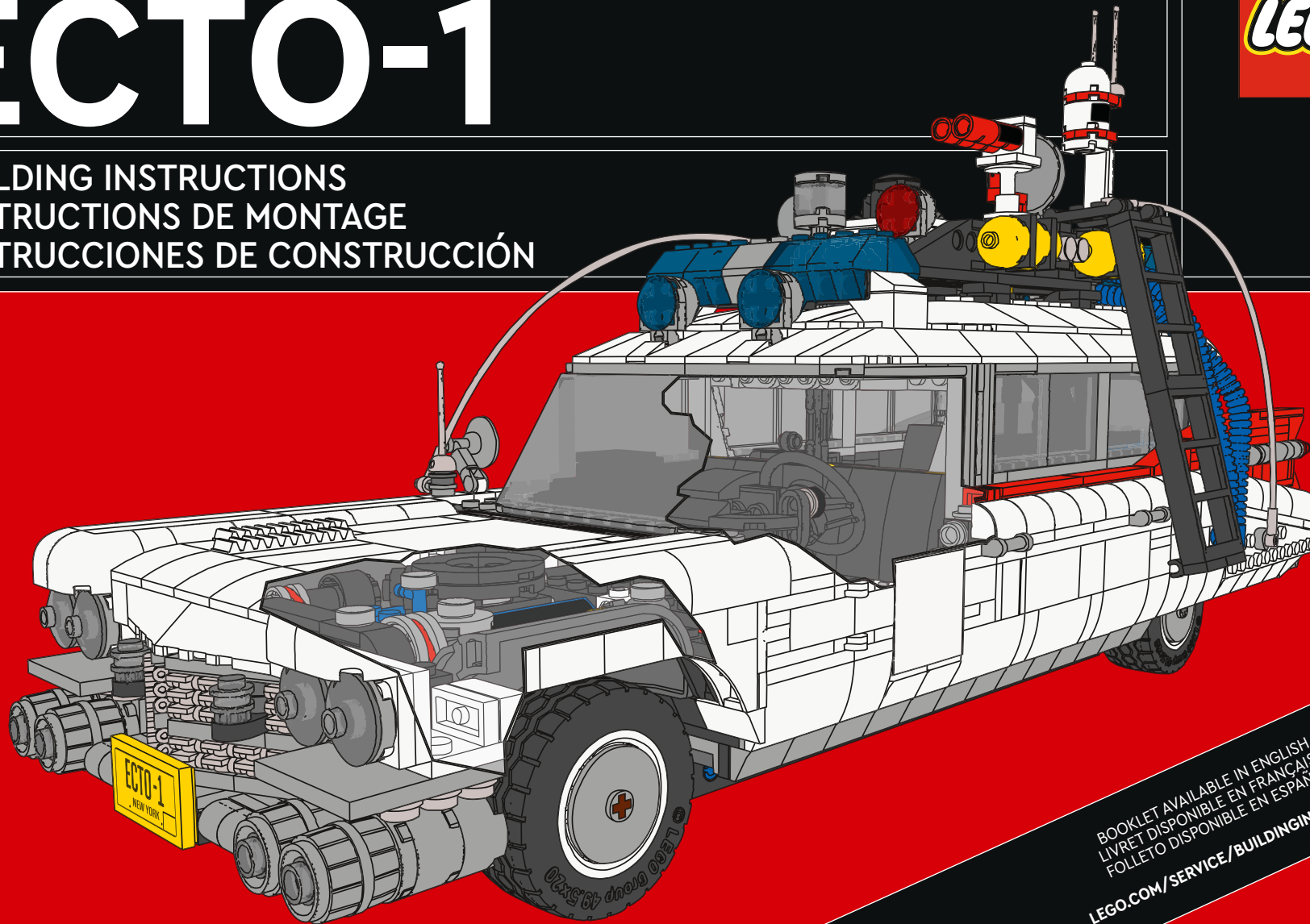

BOOKLET AVAILABLE IN ENGLISH ON
LIVRET DISPONIBLE EN FRANÇAIS SUR
FOLLETO DISPONIBLE EN ESPAÑOL EN
LEGO.COM/SERVICE/BUILDINGINSTRUCTIONS

CLASSIFIEDS | PETITES ANNONCES | CLASIFICADOS

HELP WANTED

WE'RE CALLING YOU!

There are ghosts appearing all over Summerville and we need your help right away! This is an exciting opportunity to re-build the legendary Ecto-1 with some brand-new upgrades according to the plans we uncovered in a barn not far from town. The car is literally

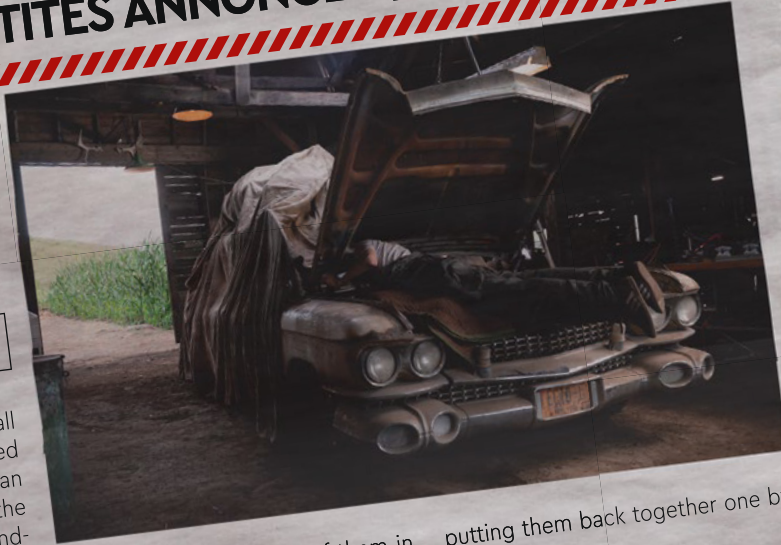

in pieces though, 2,352 of them in fact, and you'll have the honor of putting them back together one by one.

NOUS EMBAUCHONS

ON A BESOIN DE VOUS !

Des fantômes se manifestent aux quatre coins de Summerville et nous avons besoin d'aide immédiatement ! Il s'agit d'une formidable occasion de reconstruire la légendaire Ecto-1 tout en y apportant

quelques améliorations selon les plans que nous avons trouvés dans une grange loin de la ville. La voiture est littéralement en morceaux, 2 352 pour être exact, et vous aurez l'honneur de les réassembler un par un.

SE NECESITA PERSONAL

¡TE LLAMAMOS A TI!

¡Toda Summerville se está llenando de fantasmas y necesitamos tu ayuda inmediato! Tienes ante ti una emocionante oportunidad de reconstruir el legendario Ecto-1 con las nuevas funciones que descubrimos en unos

The Ghostbusters have a long history protecting residents from the paranormal. They saved New York from the Stay Puft Marshmallow Man and protected the world from the evil spirit of Gozer. When slime levels rise, and ghosts descend, you know who to call!

Les chasseurs de fantômes protègent les citoyens contre les phénomènes paranormaux depuis longtemps. Ils ont sauvé New York de Bibendum Chamallow et protégé le monde de l'esprit maléfique de Gozer. Quand les niveaux d'ectoplasme montent et que les fantômes apparaissent, vous savez qui appeler !

Los cazafantasmas acumulan un amplio historial de éxitos protegiendo de lo paranormal a los residentes. Salvaron Nueva York del hombre de malvavisco y defendieron al mundo del espíritu maligno de Gozer. Cuando los niveles de residuos ectoplásmicos ascienden y los fantasmas descienden, ¡ya sabes a quién llamar!



HISTORY OF ECTO-1

Before getting our flagship Ectomobile back on the road, it's important to understand a little background information on this 1959 Cadillac Miller-Meteor. Originally purchased by Dr. Ray Stantz for \$4,800, this vehicle was perfect for our new paranormal investigation and elimination business. With the help of Dr. Egon Spengler, all the ghostbusting gear was added to make this the ultimate command vehicle. As you can see, the car has seen better days but if you are up for the task, we're ready to believe you!



L'HISTOIRE DE L'ECTO-1

Avant de remettre notre emblématique Ectomobile sur la route, il faut souligner quelques informations contextuelles sur cette Cadillac Miller-Meteor 1959. Achetée à l'origine par le Dr Ray Stantz pour 4 800 \$, cette voiture était parfaite pour notre nouvelle entreprise d'investigation paranormale et d'éradication. Avec l'assistance du Dr Egon Spengler, l'équipement de chasse aux fantômes a été ajouté pour en faire le véhicule de commandement idéal. Comme vous pouvez le constater, la voiture a connu des jours meilleurs, mais si vous êtes prêt à relever le défi, nous sommes prêts à vous croire !

HISTORIA DEL ECTO-1

Antes de que nuestro inconfundible Ectomóvil regrese a las calles, es importante que repasemos los datos más interesantes de este Cadillac Miller-Meteor de 1959. El vehículo lo adquirió el Dr. Ray Stantz por \$4800. Era justo lo que necesitábamos para nuestra nueva empresa de investigaciones y eliminaciones paranormales profesionales. Con la ayuda del Dr. Egon Spengler, lo fuimos equipando con dispositivos cazafantasmas hasta convertirlo en el centro de control móvil más eficaz jamás visto. Como puedes observar, el auto ha tenido mejores días, pero, si dices que estás capacitado para afrontar la tarea, ¡estamos listos para creerte!



Nothing draws attention like our spectacular Ectomobile racing around with its lights blazing and siren screeching. You never know who or what you'll meet at the other end!

Rien n'attire l'attention comme notre spectaculaire Ectomobile avec ses gyrophares flamboyants et ses sirènes hurlantes. On ne sait jamais ce qui nous attend à l'autre bout !

Nada llama más la atención que nuestro espectacular Ectomóvil a toda velocidad con las luces parpadeando intensamente y la sirena sonando a todo volumen. ¡Nunca se sabe a quién o qué te encontrarás en el otro barrio!

PORTABLE COMMAND STATION

To some it may look like a repurposed V8 1959 Cadillac Series 62 Miller-Meteor with 360 horsepower and 4-speed automatic transmission. Which indeed it is. But to us it's also a roving HQ with a mobile laboratory and a portable arsenal containing every weapon at our ghostbusting disposal. Often imitated but never matched, the Ecto-1 has survived everything from catastrophic earthquakes to lava-hot marshmallow fluff! Now it's your job to reassemble and overhaul it...

ESTACIÓN DE CONTROL PORTÁTIL

A algunos les parecerá simplemente un Cadillac serie 62 Miller-Meteor de 1959 reacondicionado, con su motor V8, sus 360 HP y su transmisión automática de 4 velocidades. Y, en efecto, lo es. Pero, para nosotros, también es un cuartel general sobre ruedas con un laboratorio móvil y un arsenal portátil que contiene todas las armas cazafantasmas a nuestra disposición. Muchas veces imitado y nunca igualado, el Ecto-1 ha sobrevivido a todo, ¡desde catastróficos terremotos hasta cremosos pedazos de malvavisco ardientes como la lava! Ahora, tu misión es rearmarlo y ponerlo en forma...

POSTE DE COMMANDEMENT PORTATIF

Certains diront qu'elle ressemble à une Cadillac Series 62 Miller-Meteor V8 1959 transformée avec 360 chevaux et une transmission automatique à 4 vitesses. Et ils ont raison. Mais pour nous, c'est aussi un QG ambulant avec un laboratoire mobile et un arsenal portable contenant toutes les armes à notre disposition. Souvent imitée mais jamais égale, l'Ecto-1 a survécu à tout, des tremblements de terre catastrophiques aux morceaux de guimauve bouillants ! Maintenant, c'est à vous de la remonter et de la réviser...



1/2" ISOMETRIC
ECTO 1

SCALE: 1/2" = 1'
13 SEP 89,

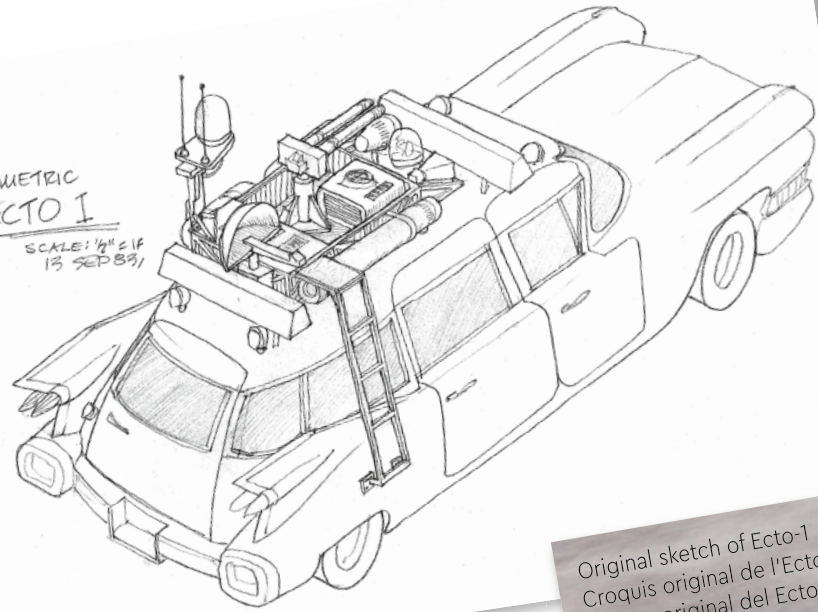

Original sketch of Ecto-1
Croquis original de l'Ecto-1
Boceto original del Ecto-1

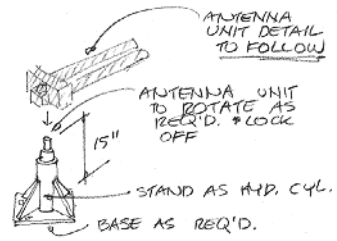

1/2" ISOMETRIC -
T.V. ANTENNA

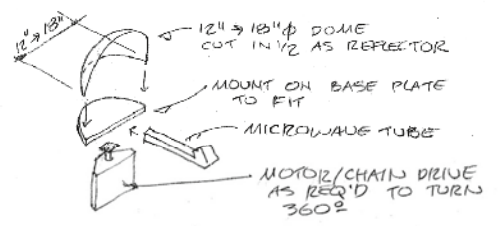

1/2" ISOMETRIC -
DIRECTIONAL ANTENNA

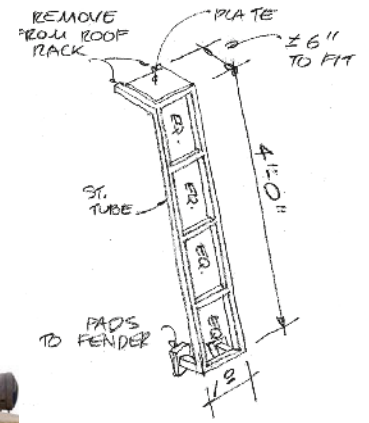

MIKE THE MECHANIC

Meet Mike Psiaki, Ghostbuster and LEGO® Ectomobile builder. He designed this latest update of the Ecto-1 and would have completed it if he hadn't met with an unfortunate protonic reversal accident. His biggest challenge was capturing the complicated curves of the Cadillac with boxy LEGO elements. Like all true scientists, engineers and LEGO builders, Mike was an ace at adapting and improvising. The ladder for his Ecto-1 came from 2 classic LEGO window frames stacked on top of each other, while the front grille is actually made up of more than 40 silver roller skates!



MIKE LE MÉCANICIEN

Mike Psiaki est un chasseur de fantômes et le constructeur de l'Ectomobile LEGO®. Il a conçu cette dernière version de l'Ecto-1, et l'aurait terminée s'il n'avait pas connu un malheureux accident d'inversion protonique. Son plus grand défi a été de rendre les courbes complexes de la Cadillac avec des éléments LEGO angulaires. Comme tous les bons scientifiques, ingénieurs et constructeurs LEGO, Mike est un pro de l'adaptation et de l'improvisation. L'échelle de son Ecto-1 est faite de 2 cadres de fenêtre LEGO classiques empilés l'un sur l'autre, tandis que la calandre avant est en fait composée de plus de 40 patins à roulettes argentés !

MIKE EL MECÁNICO

Conoce a Mike Psiaki, cazafantasmas y constructor del Ectomóvil LEGO®. Diseñó esta última versión actualizada del Ecto-1, y la habría terminado si no hubiera sufrido un desafortunado accidente de inversión protónica. Su mayor desafío fue capturar las complicadas formas curvas del Cadillac con las marcadas aristas de los elementos LEGO. Como todos los verdaderos científicos, ingenieros y constructores LEGO, Mike es un experto adaptando e improvisando. La escalera de su Ecto-1 proviene de 2 marcos de ventana LEGO clásicos apilados uno sobre el otro y la parrilla delantera se compone, en realidad, ¡de más de 40 patines plateados!





ECTOMOBILE OVERVIEW

Now that you're up for the task, it's time to take a deep dive into the particulars of our impressive quick-response vehicle and all its sophisticated equipment. The detailed schematic and reference materials contained over the next pages should allow you to move forward ... hopefully at the wheel of a completed Ectomobile!

VUE D'ENSEMBLE DE L'ECTOMOBILE

Maintenant que vous êtes prêt à vous lancer, il est temps de vous présenter plus en détail notre impressionnant véhicule d'intervention rapide et son équipement sophistiqué. Les schémas détaillés et les documents de référence contenus dans les prochaines pages devraient vous permettre d'aller de l'avant... au volant d'une Ectomobile complète, nous l'espérons !

DESCRIPCIÓN GENERAL DEL ECTOMÓVIL

Ahora que te sientes preparado para la tarea, llegó el momento de profundizar en las características de nuestro impresionante vehículo de respuesta rápida y todo su sofisticado equipo. Los detallados materiales de referencia y esquemas que aparecen en las siguientes páginas te permitirán avanzar, con suerte... ¡al volante de un Ectomóvil terminado!

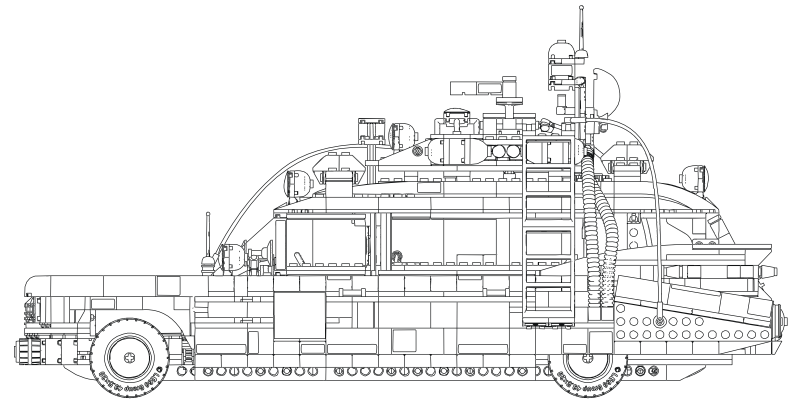

This model may only be a smaller scale version of the real thing, but it's got everything you need for ghostbusting! There are 2,352 pieces in this set.

Ce modèle n'est peut-être qu'une version à petite échelle de la vraie voiture, mais il contient tout ce qu'il vous faut pour chasser les fantômes ! Cet ensemble contient 2 352 pièces.

Este modelo puede ser solo una versión a escala más pequeña del vehículo real, ¡pero tiene todo lo que necesitas para ir a cazar fantasmas! Hay 2352 piezas en este set.

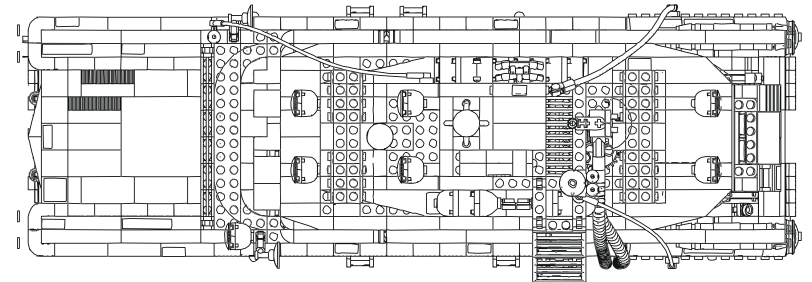

Don't panic! Take your time and follow the instruction manual. You can do this!

Ne paniquez pas ! Prenez votre temps et suivez le manuel d'instructions. Vous pouvez y arriver !

¡No te angusties! Tómate tu tiempo y sigue el manual de instrucciones. ¡Puedes hacerlo!

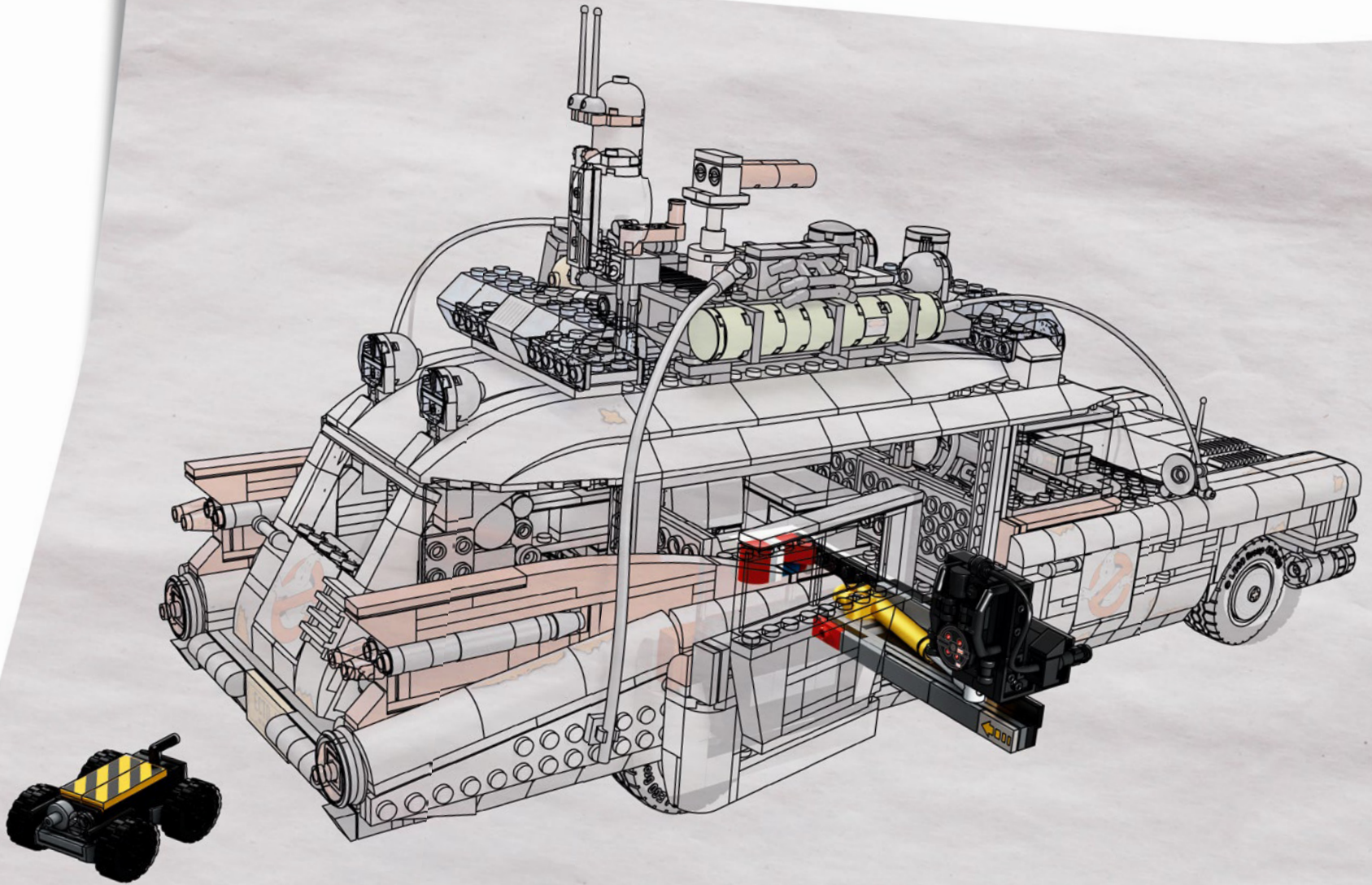

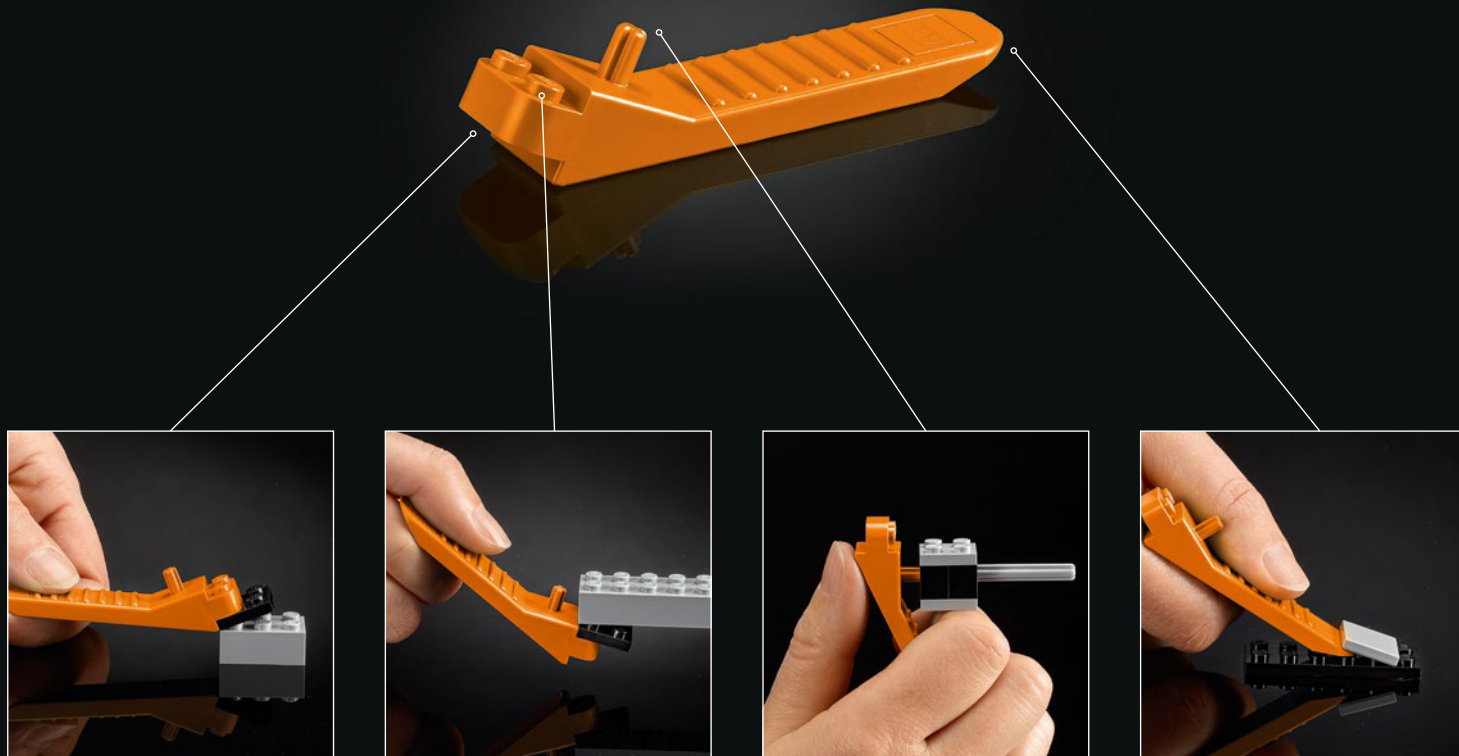

LEGO.com/brickseparator

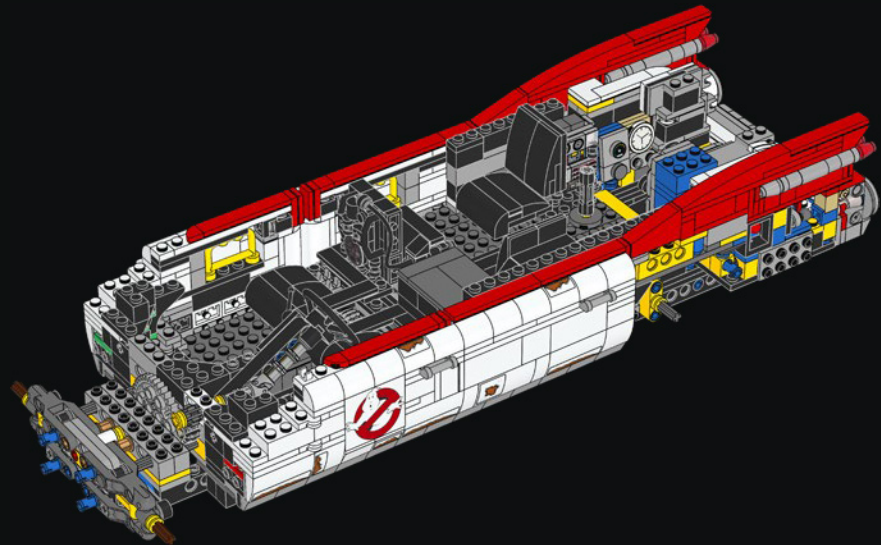
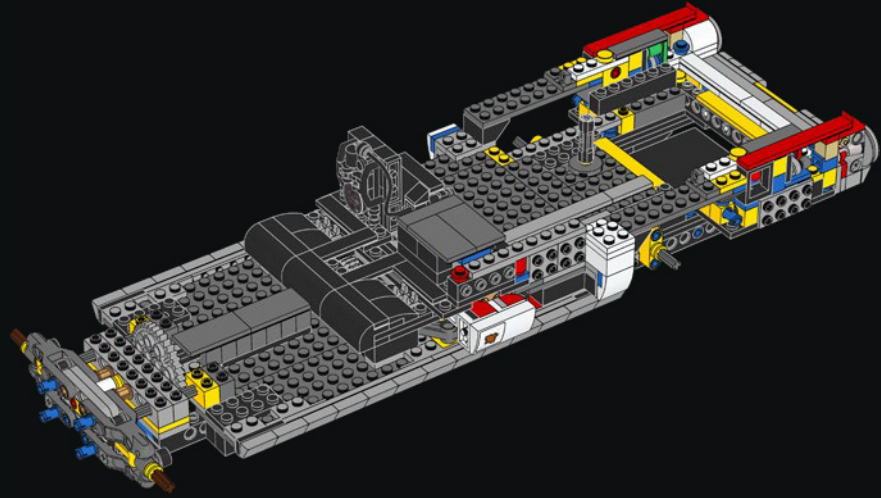

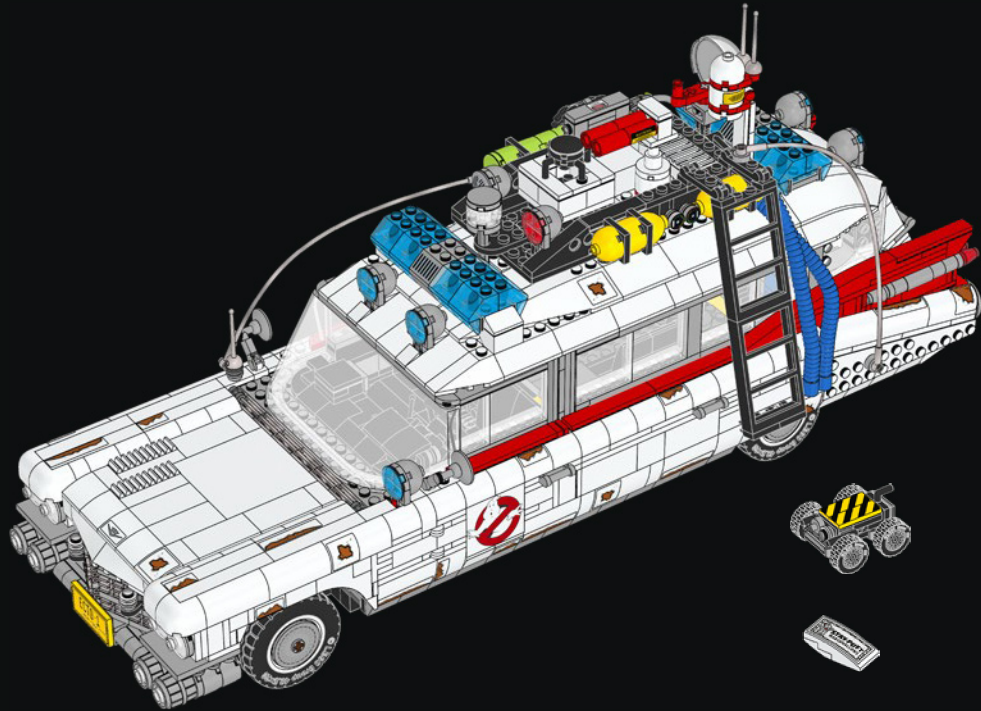
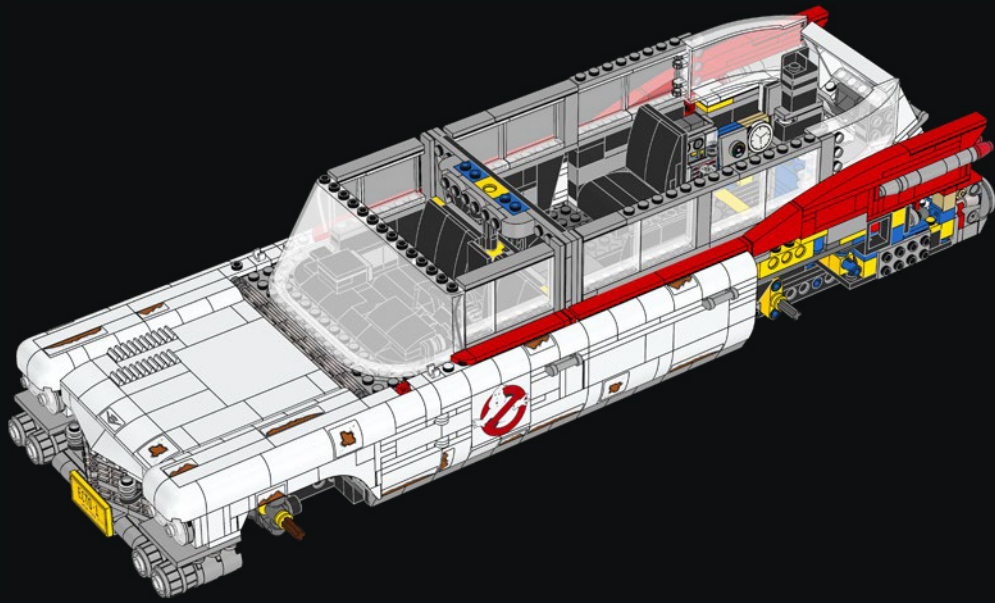
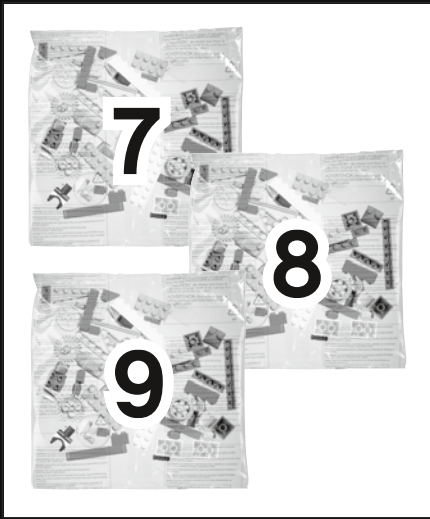

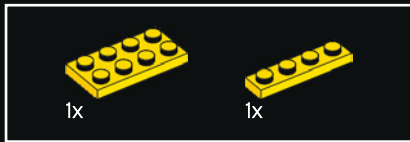
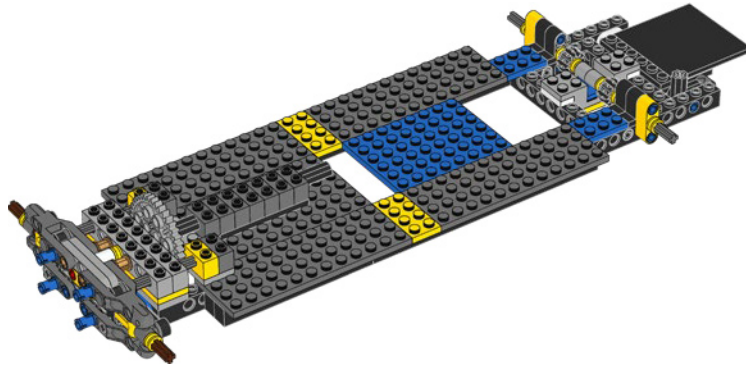
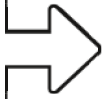

1

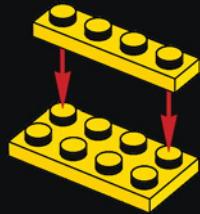

2

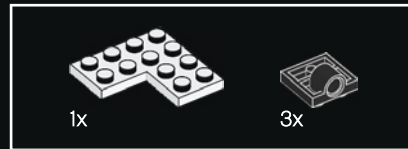
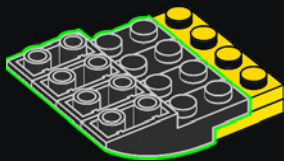

3

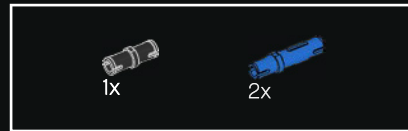
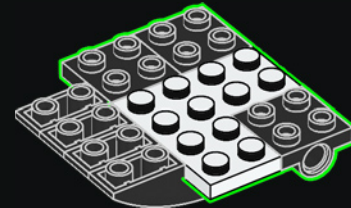

4

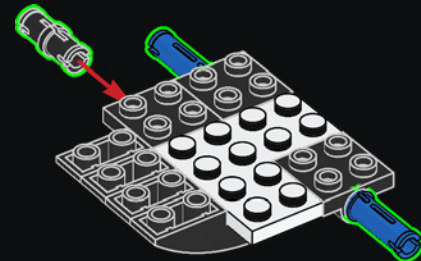



5

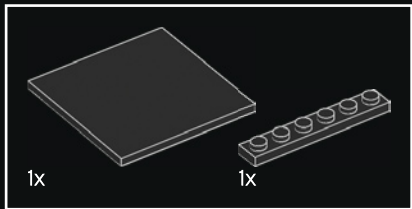
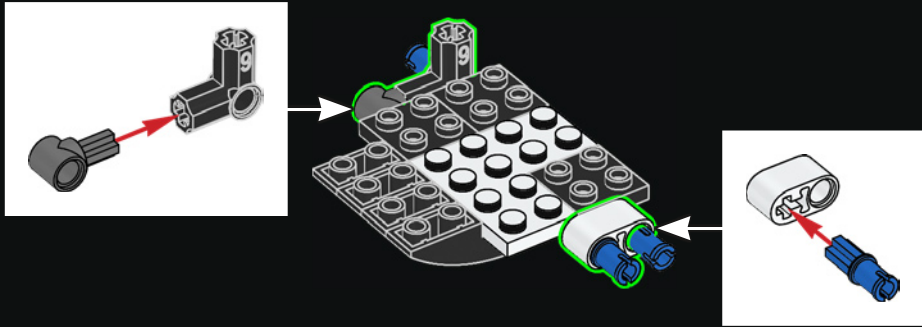

6

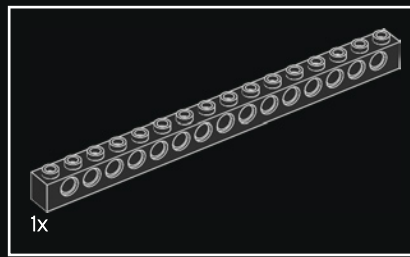
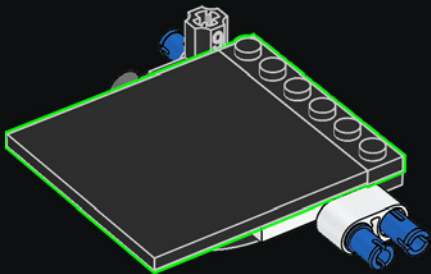

7

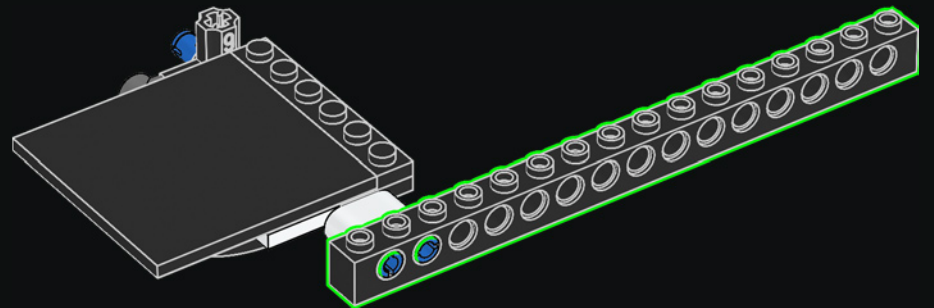

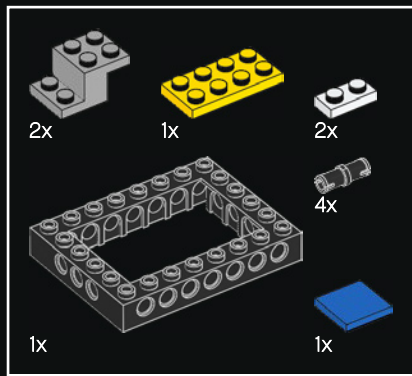

8

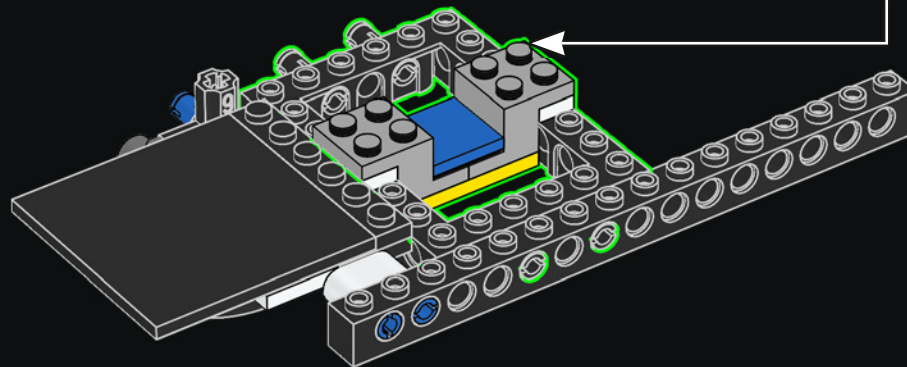
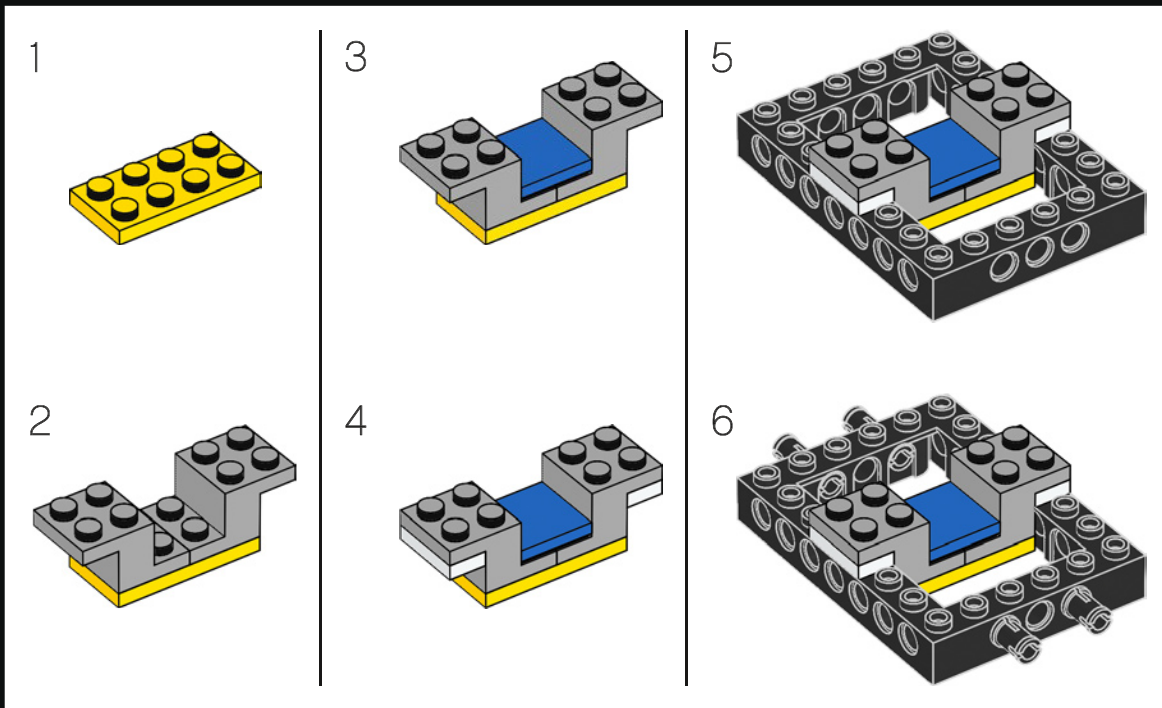

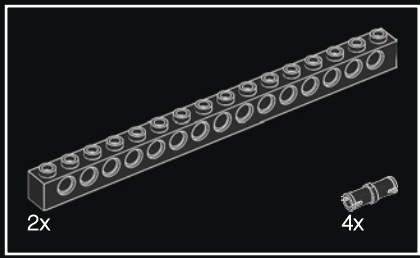

9

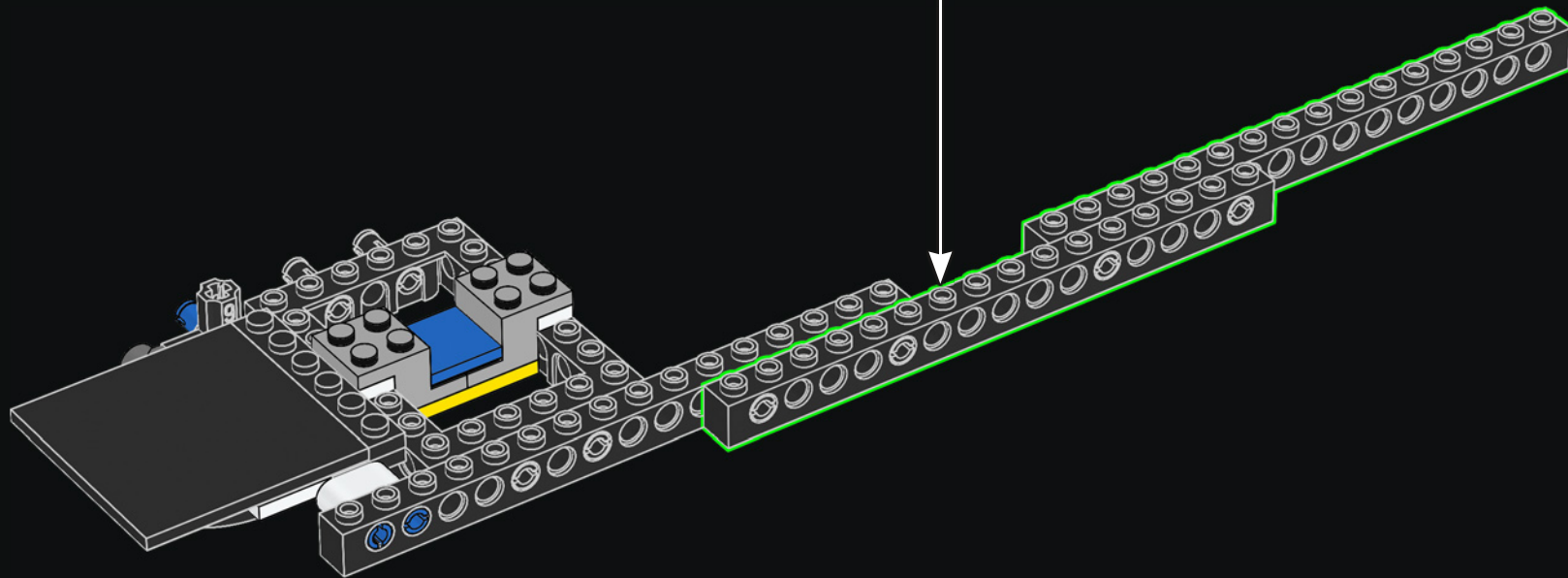
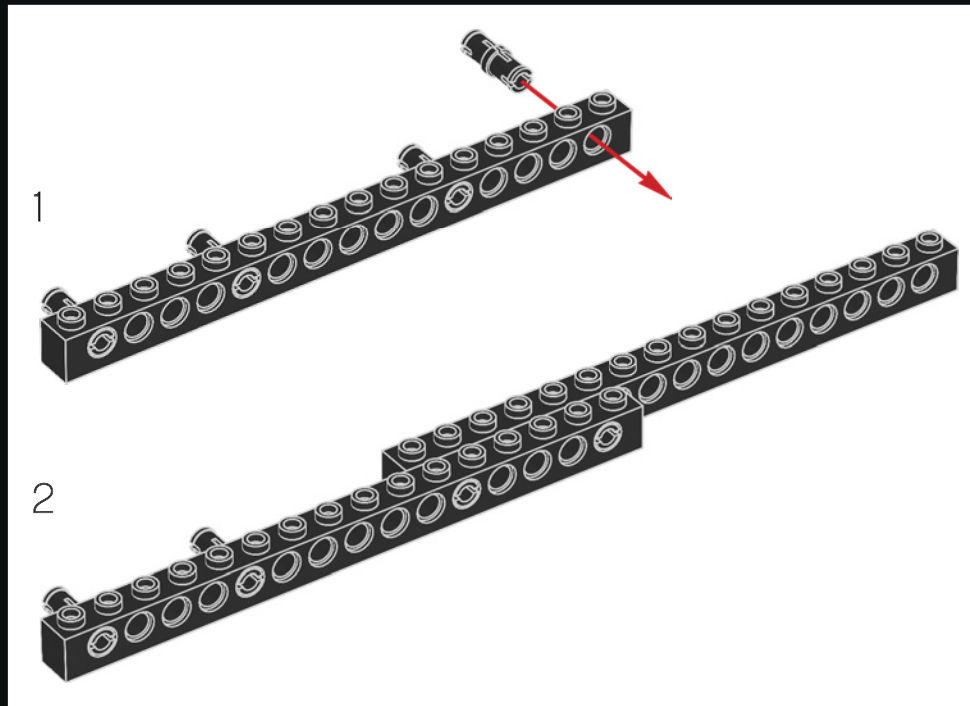

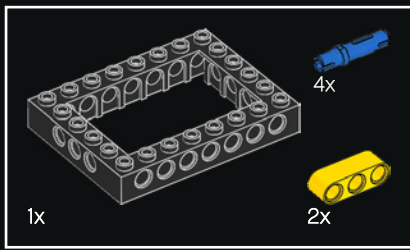

10

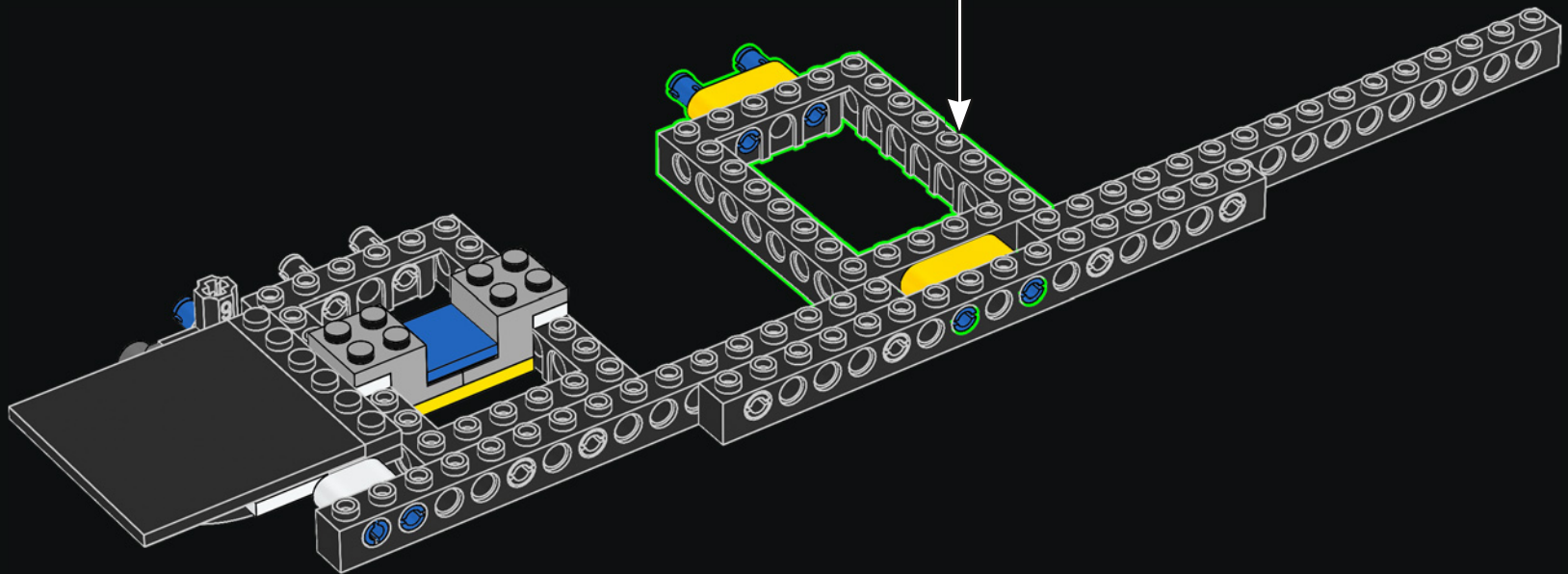
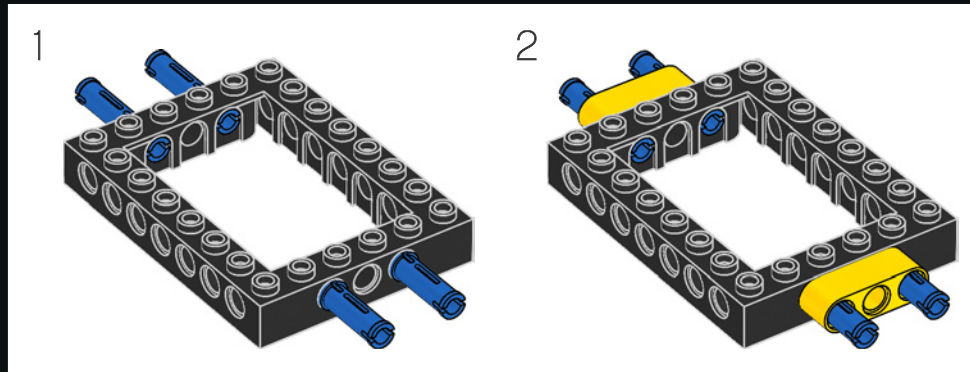

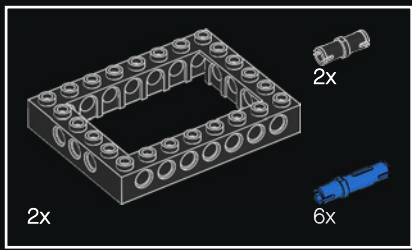

11

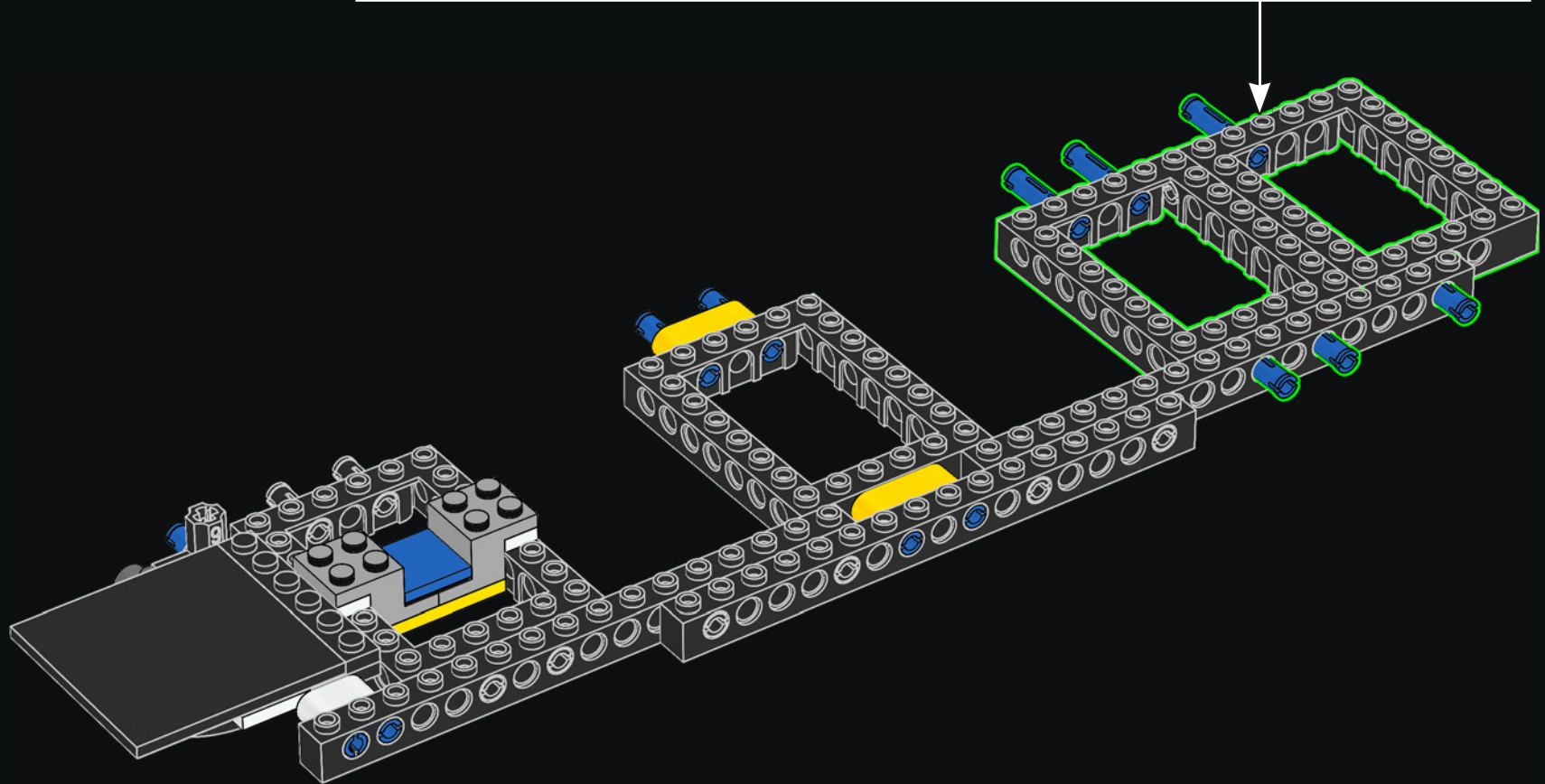
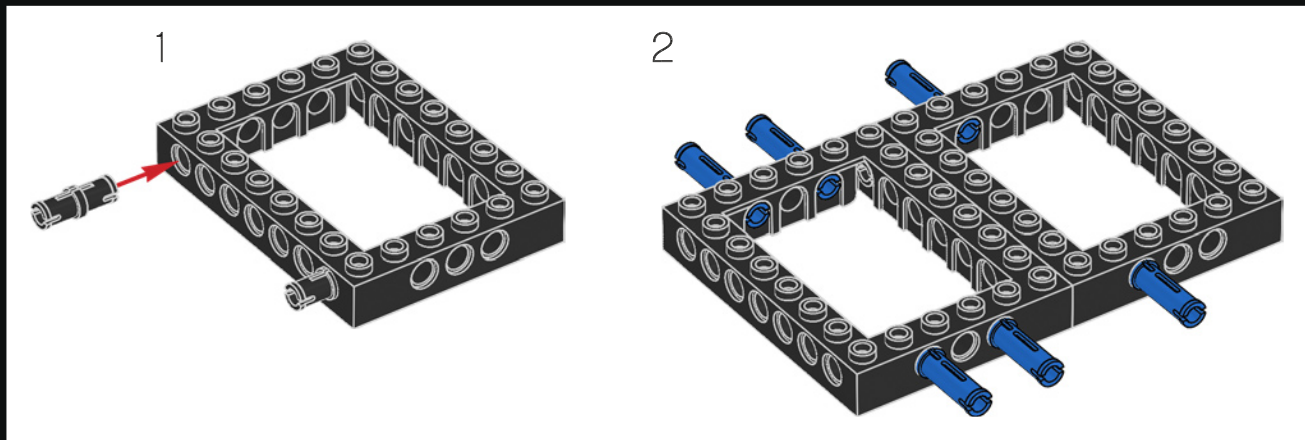

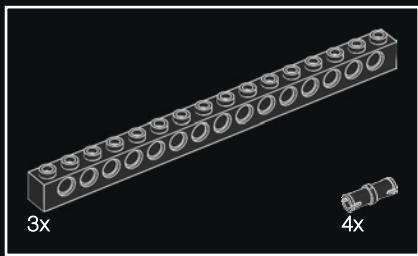

12

1

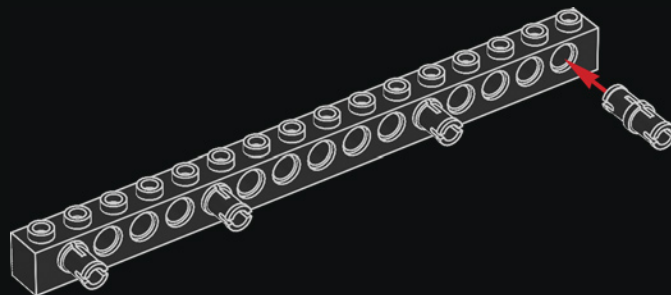

2

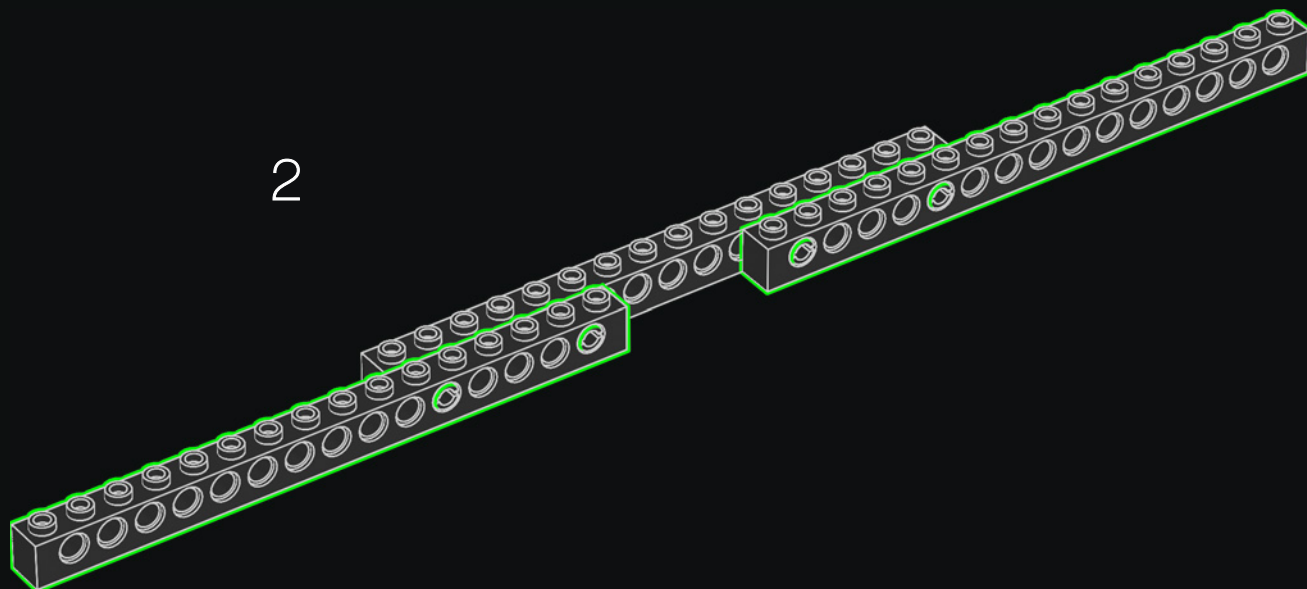

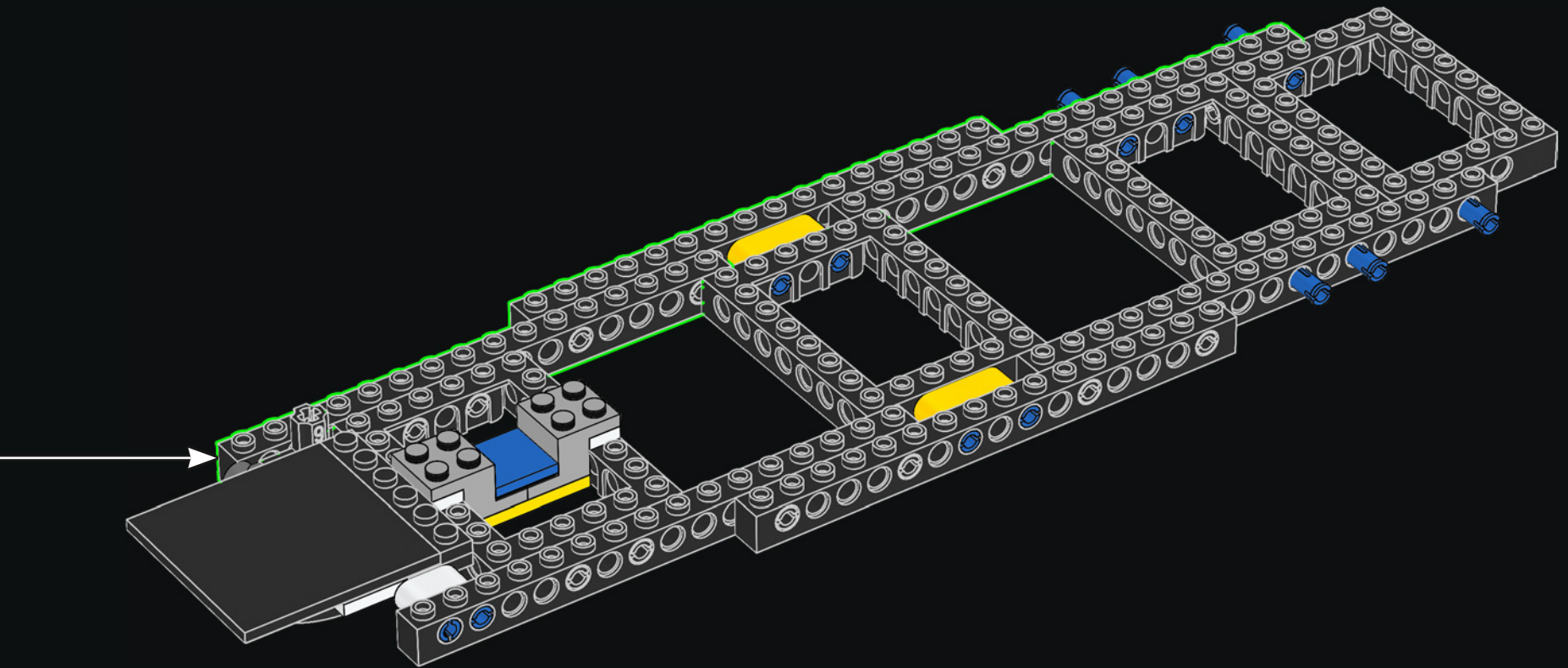

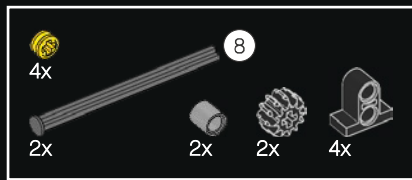

13

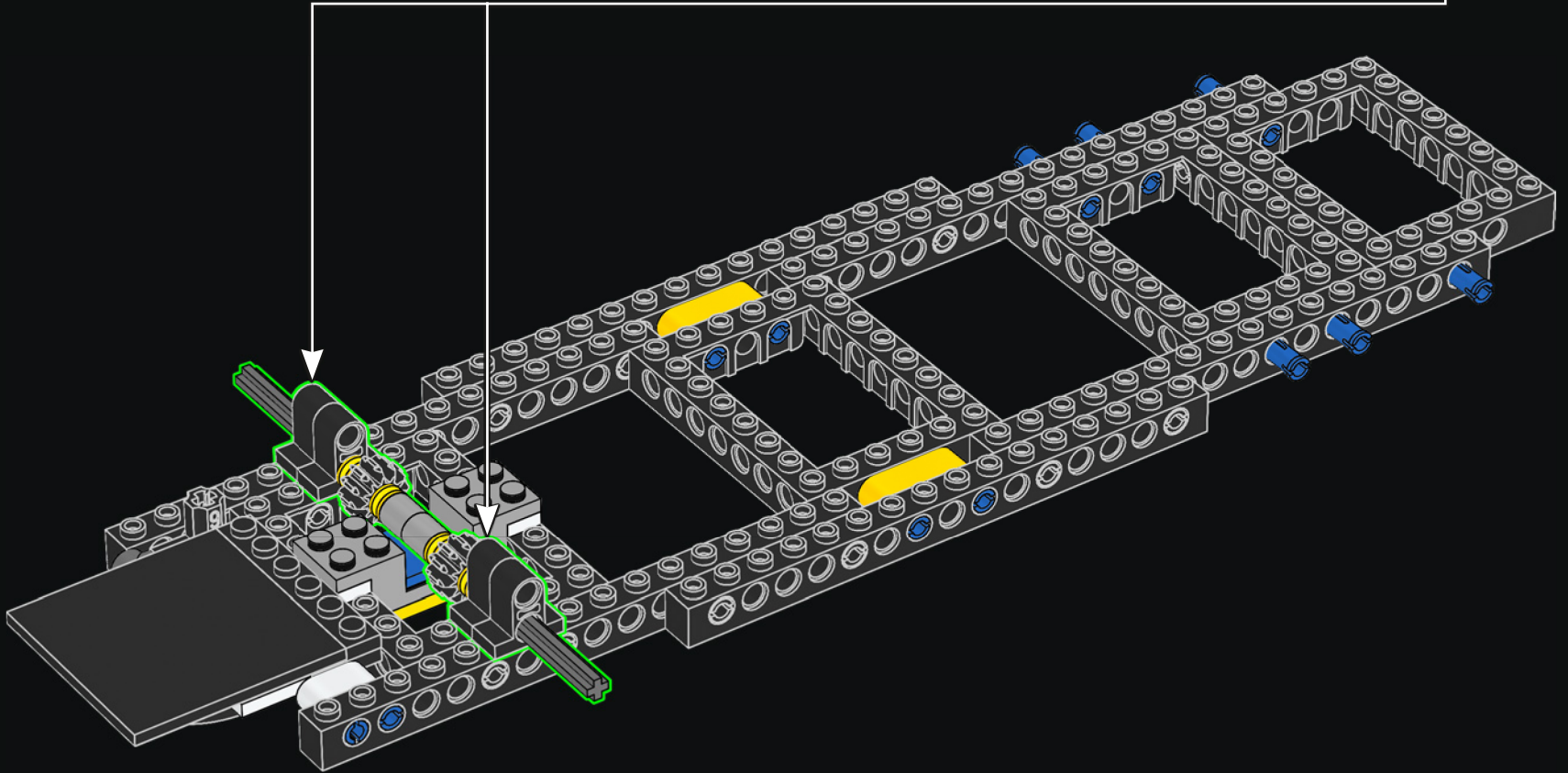
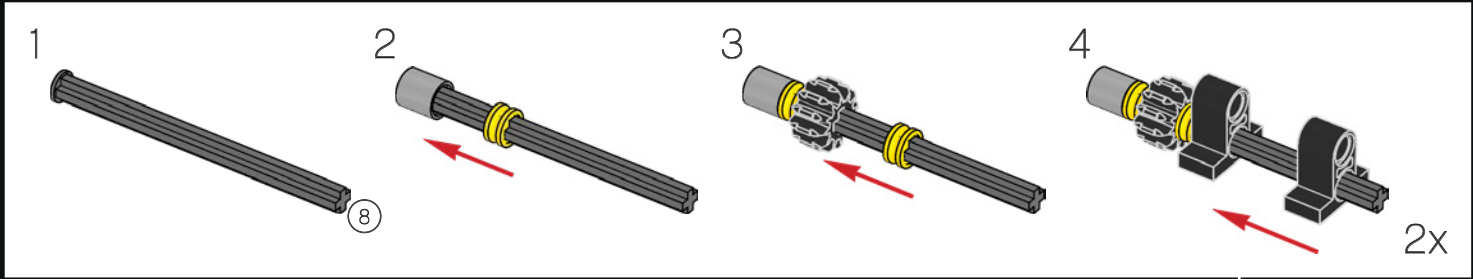

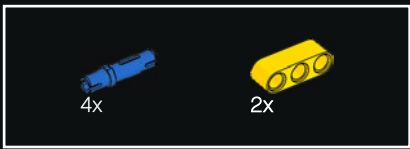

14

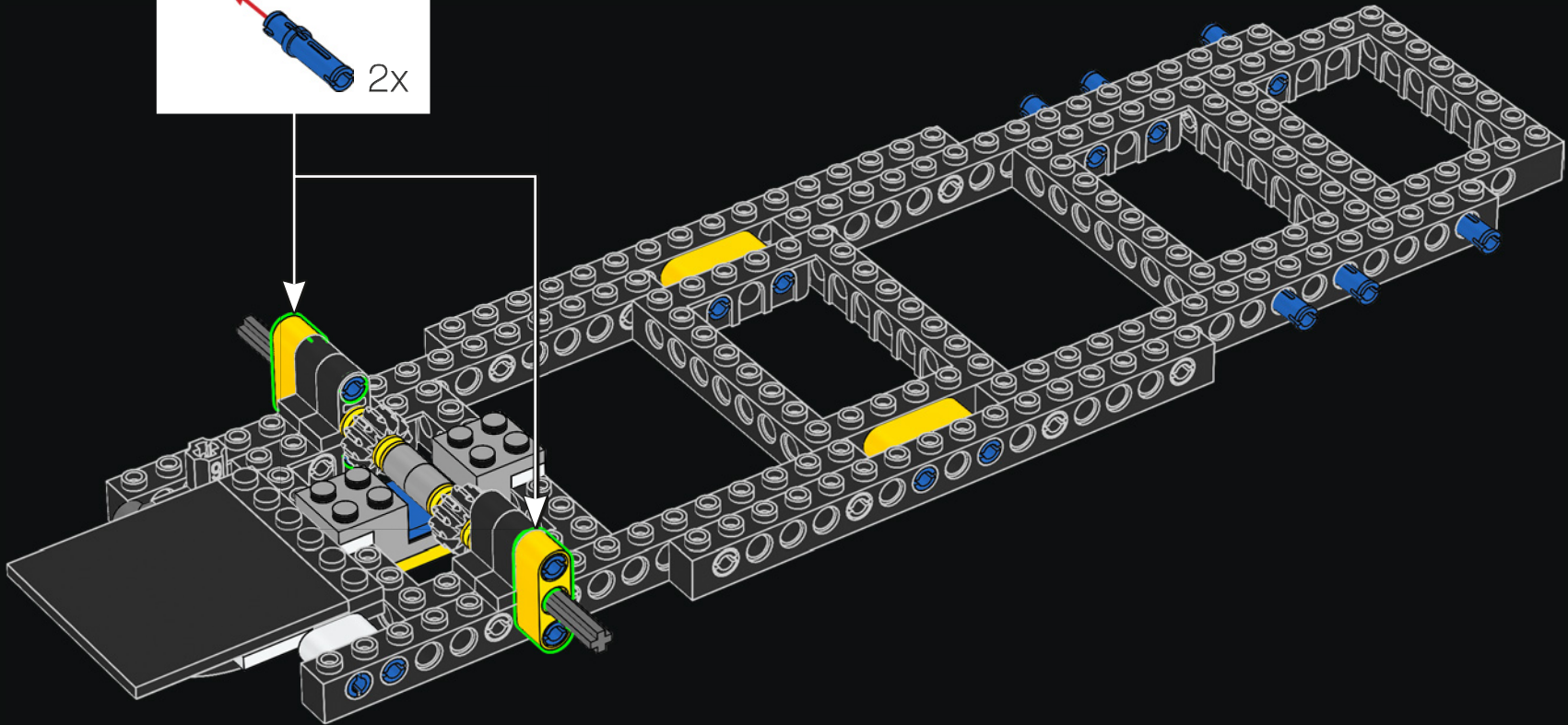
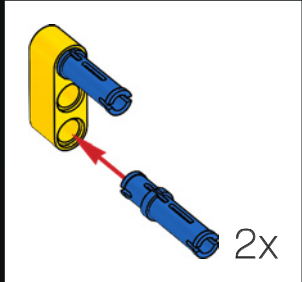

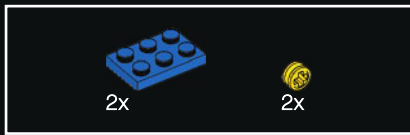

15

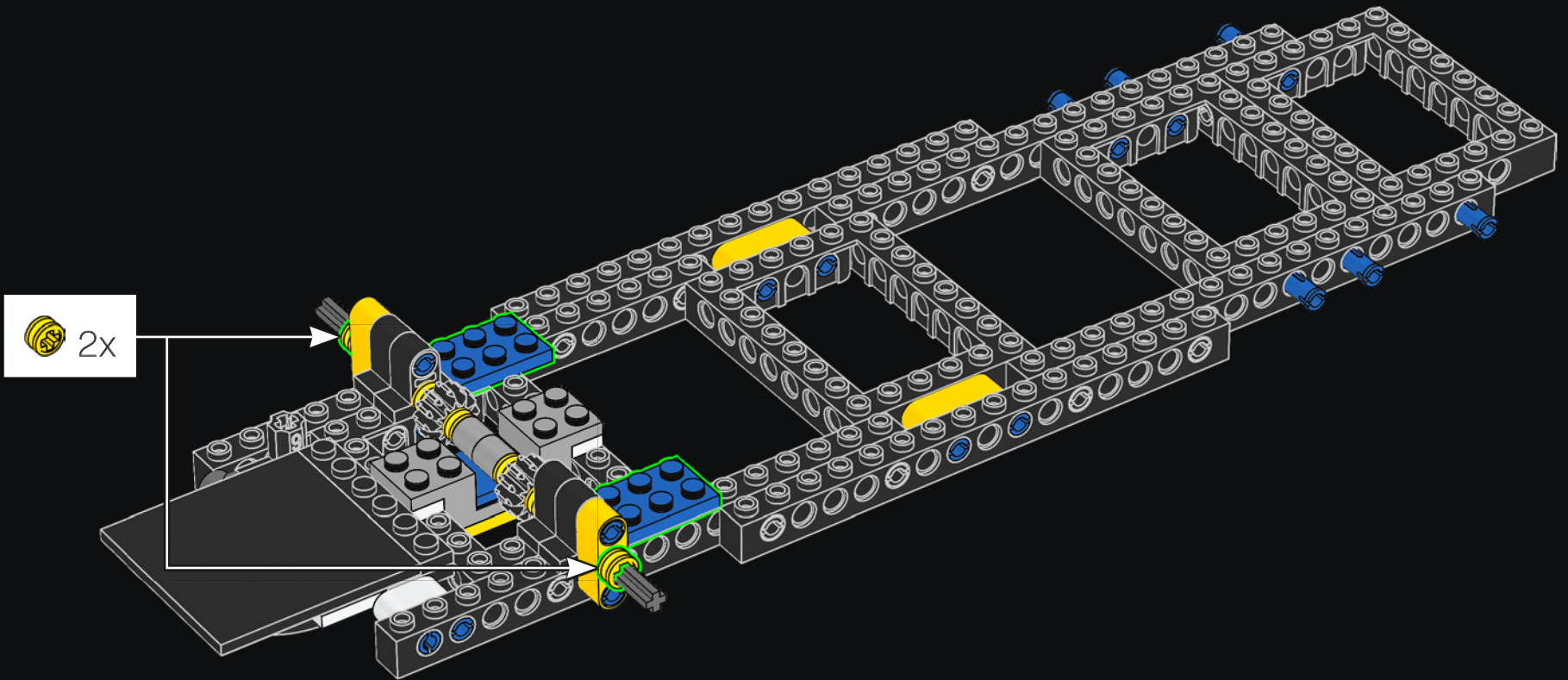

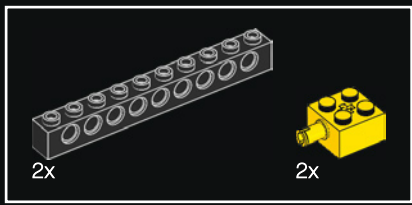

16

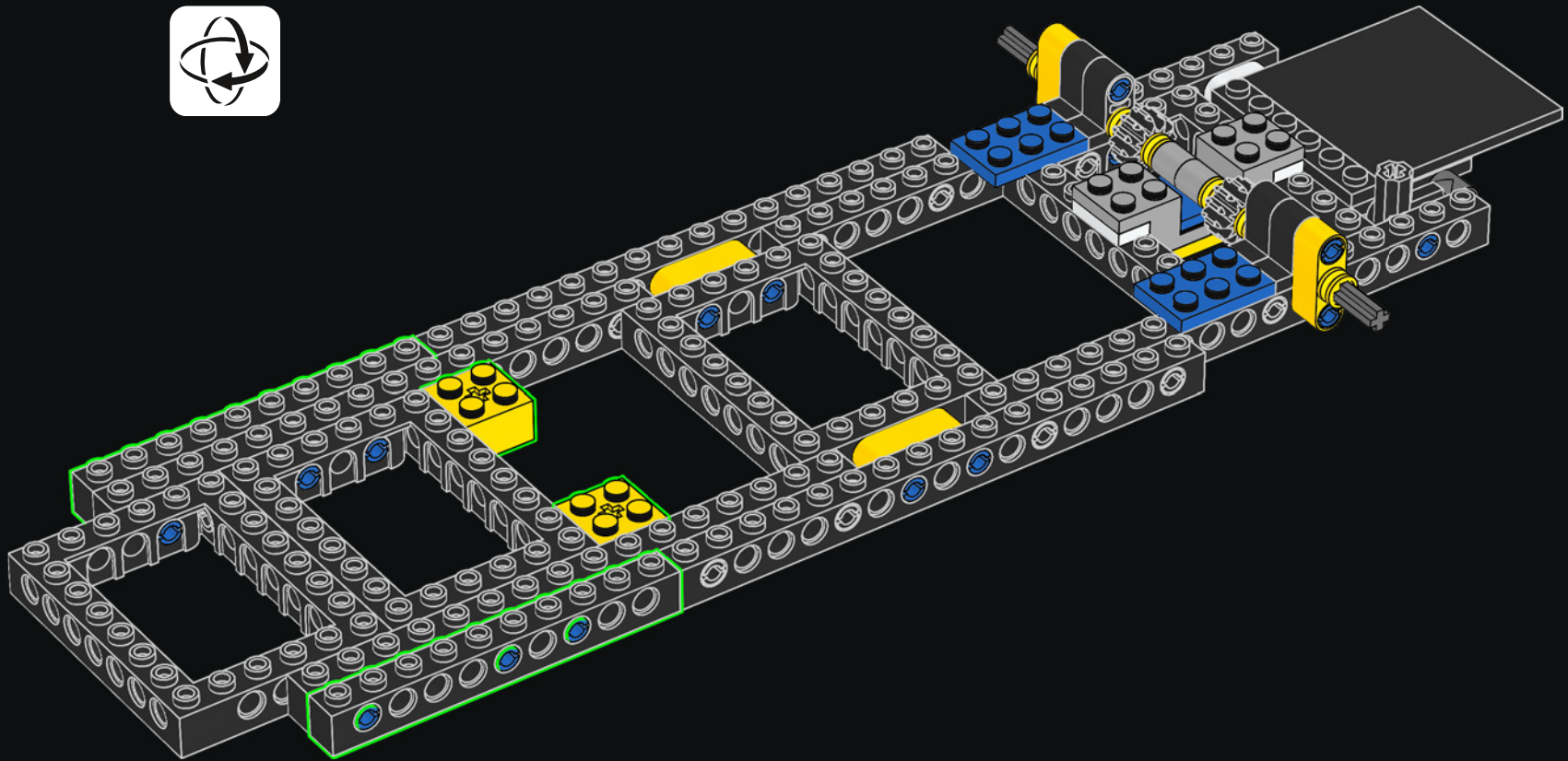

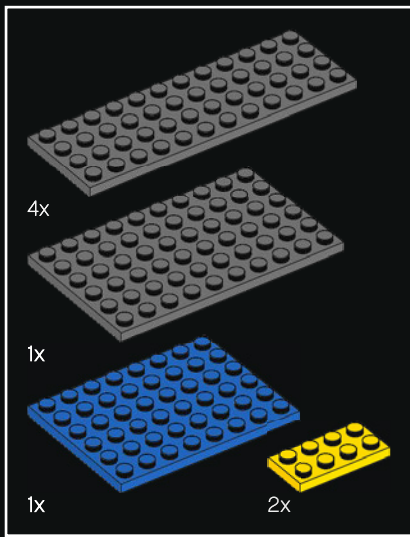

17

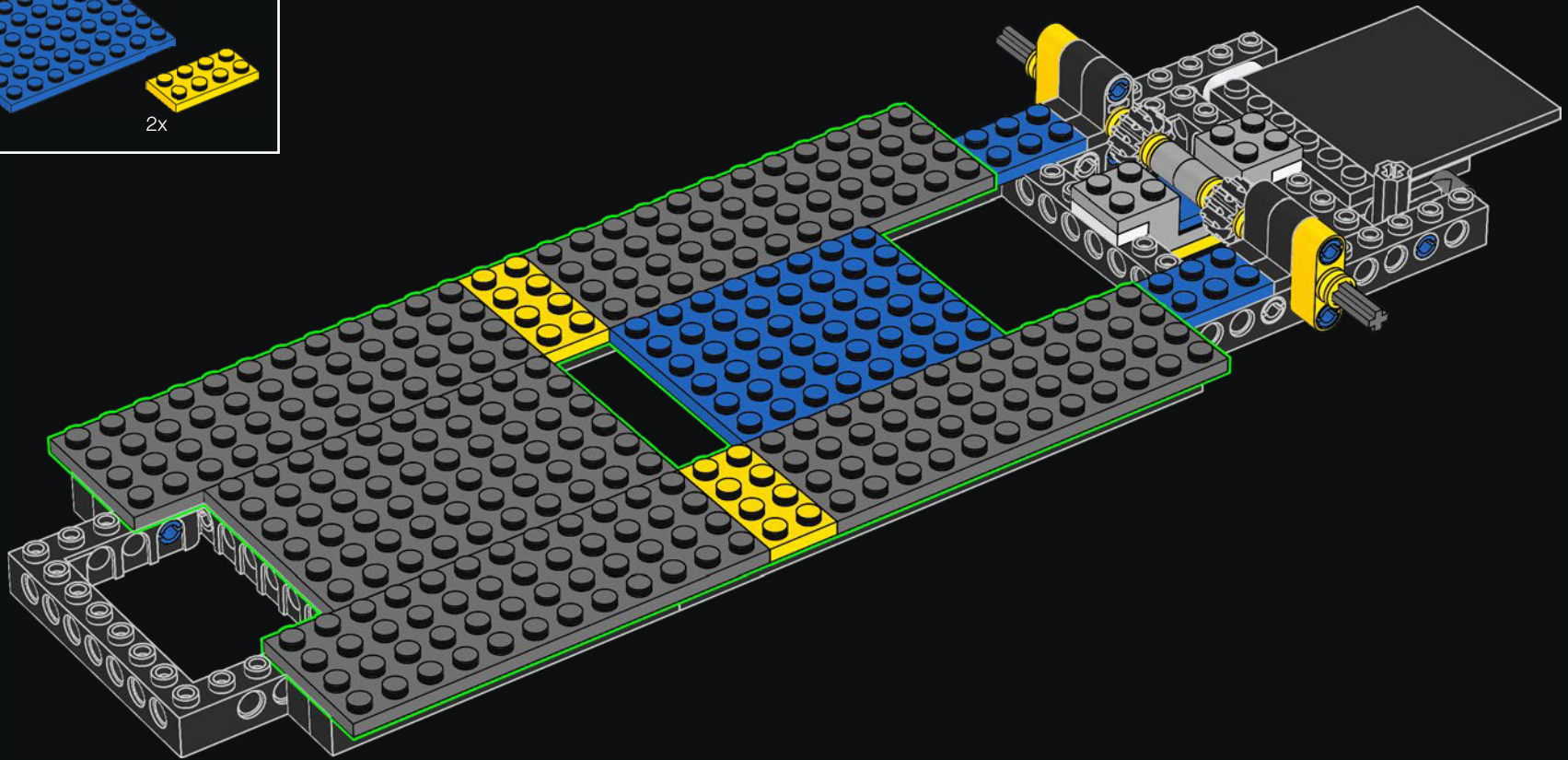

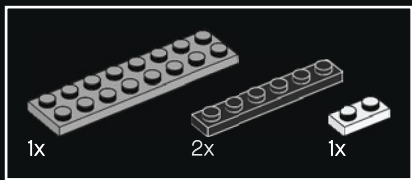

18

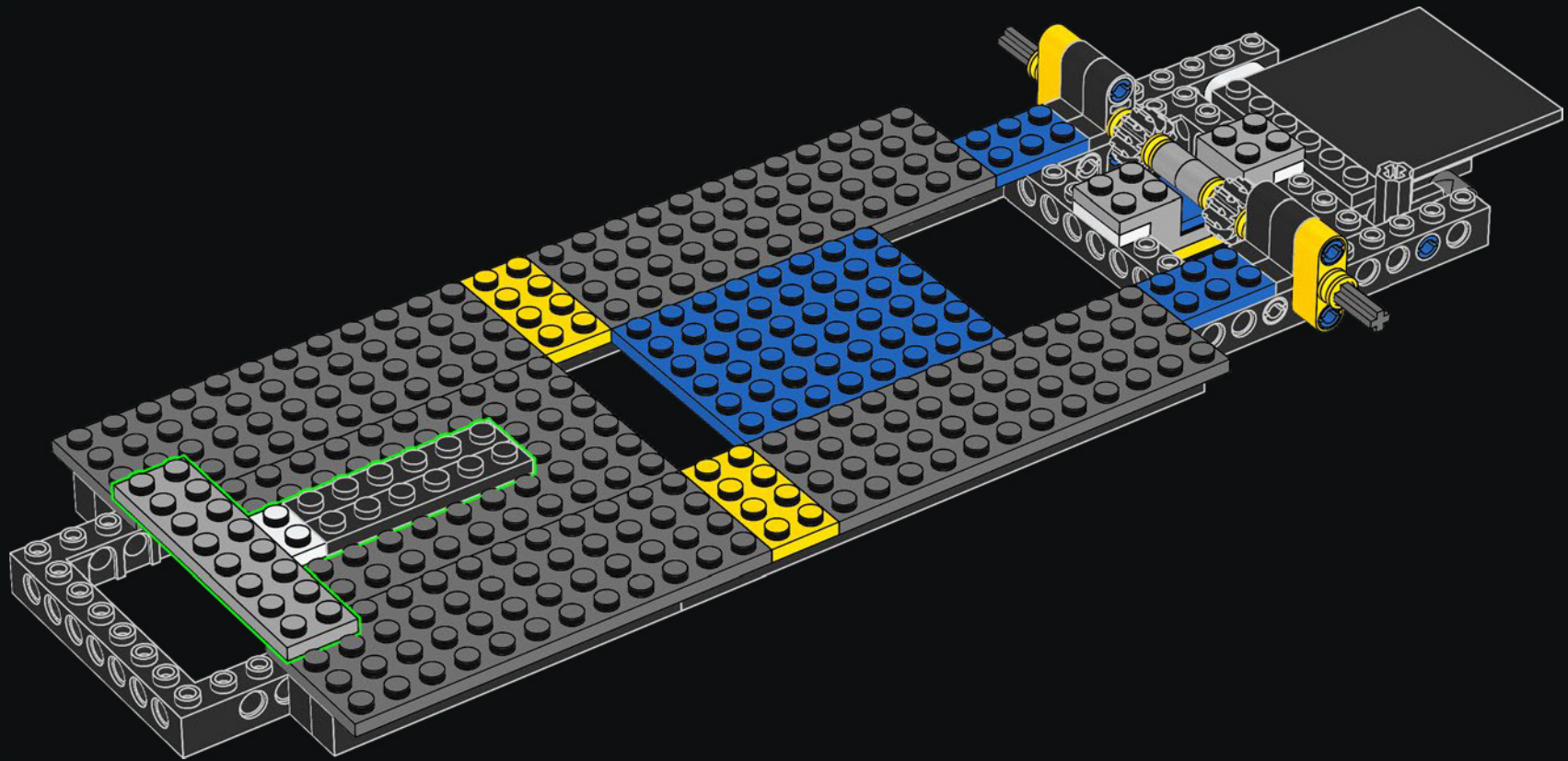



19

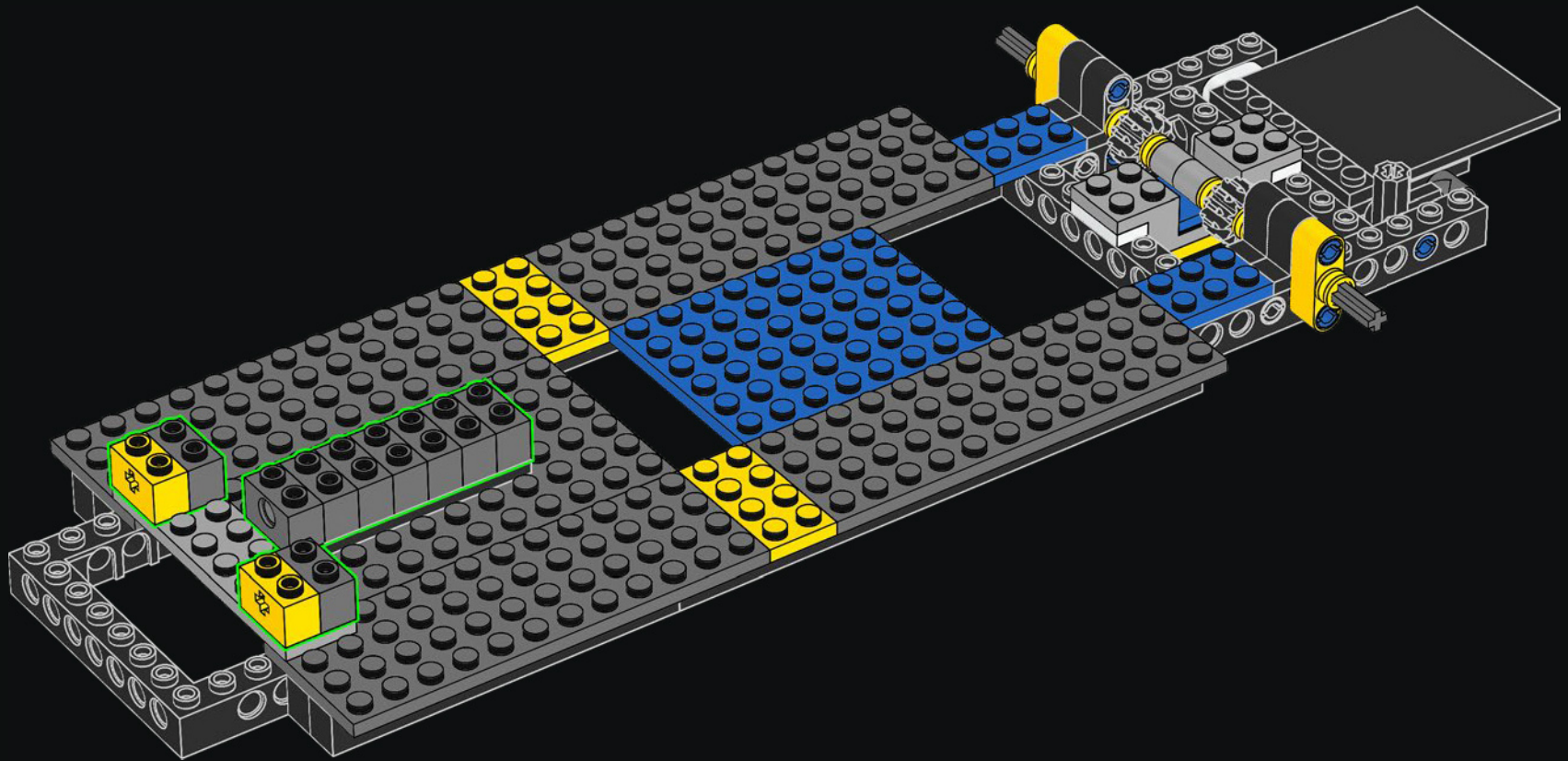

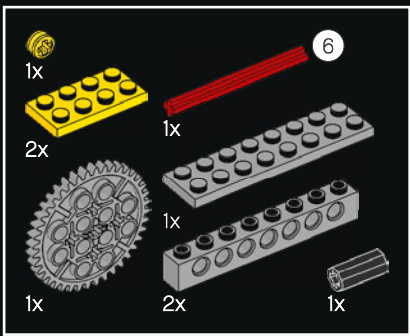

20

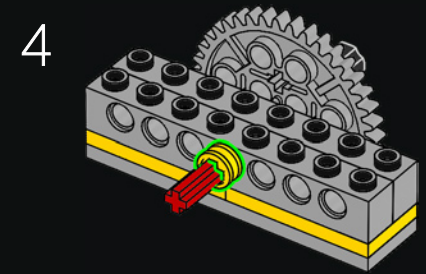
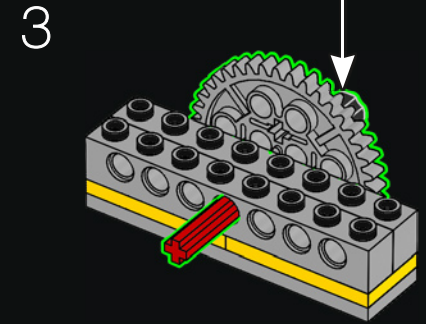
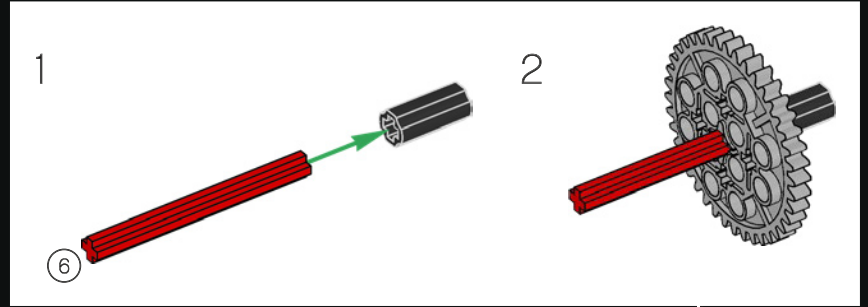
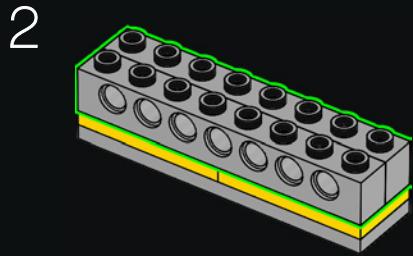
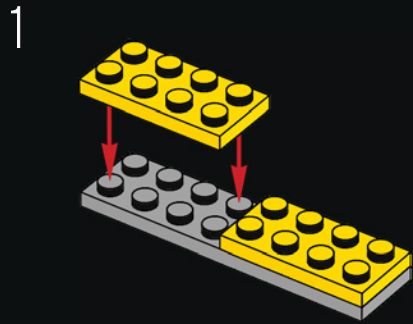

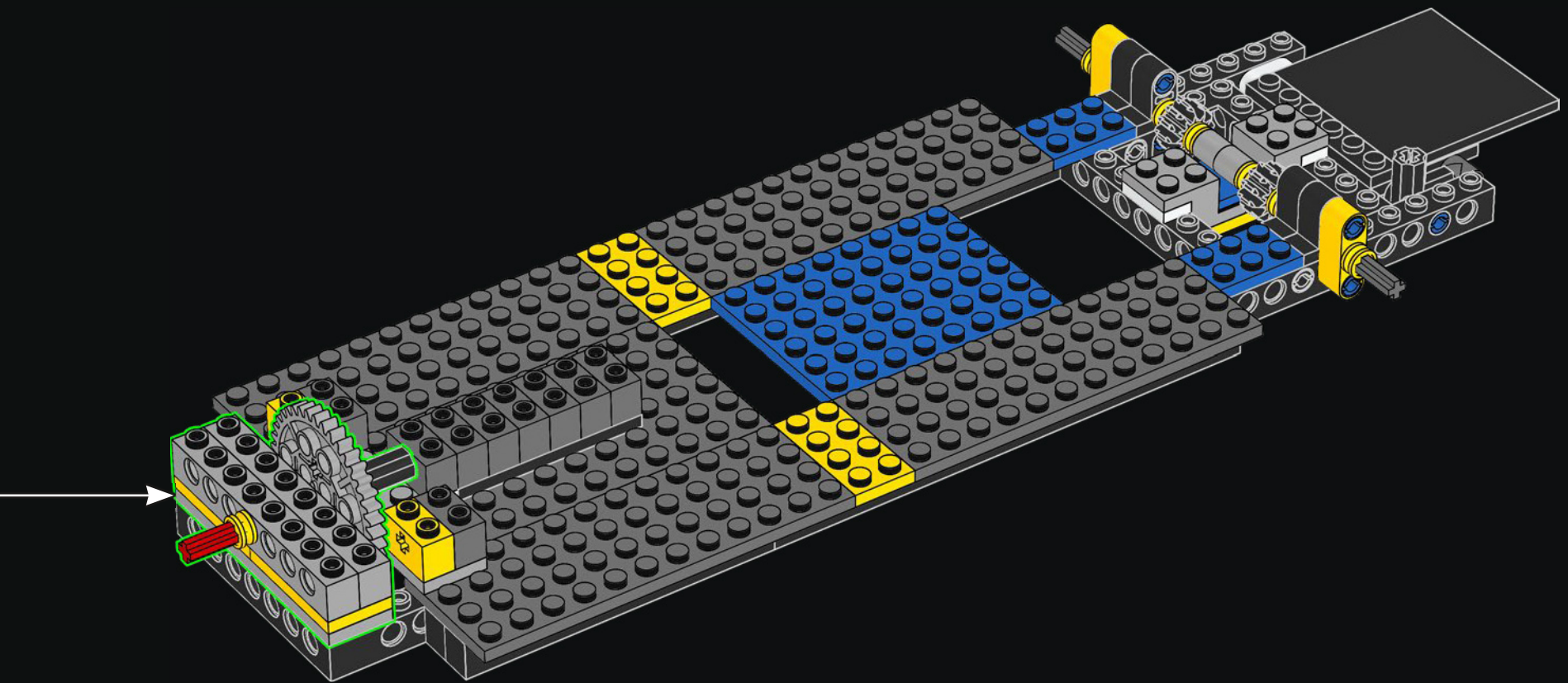

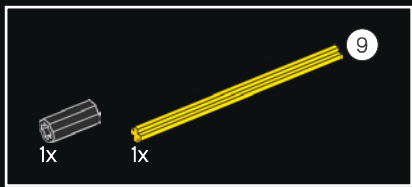

21

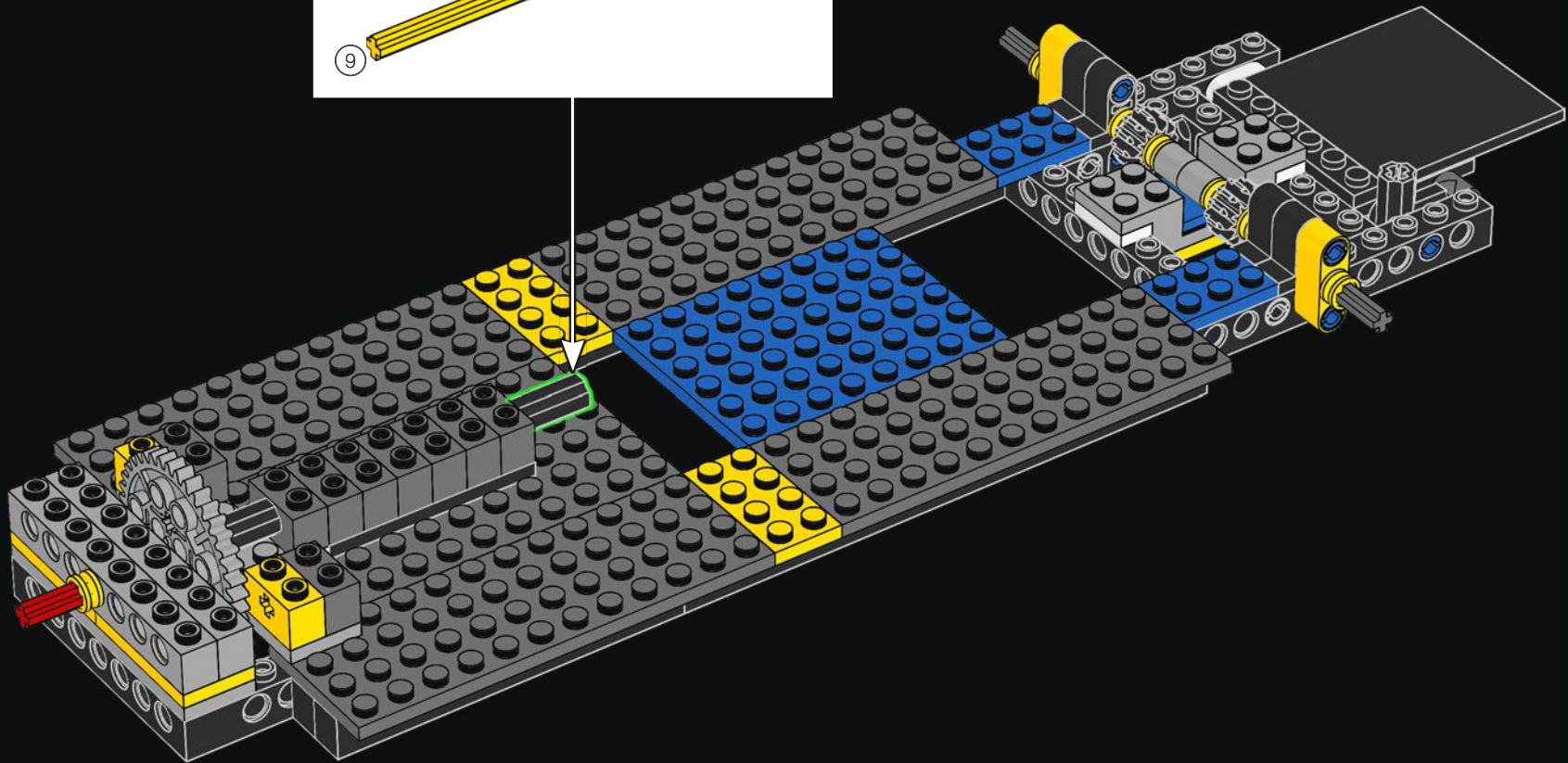
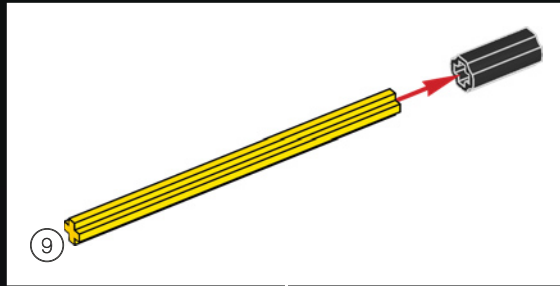

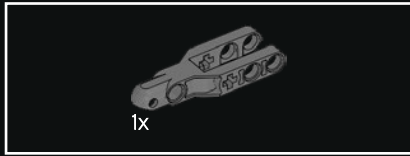
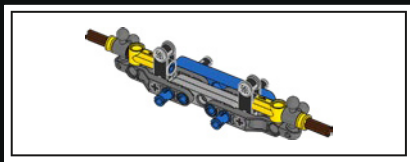

22



23

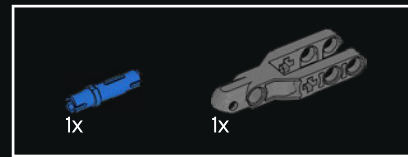
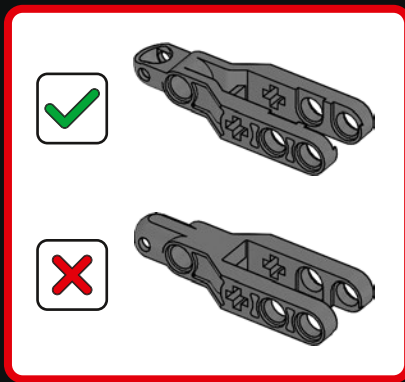
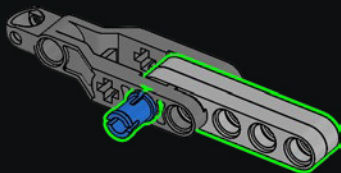

24

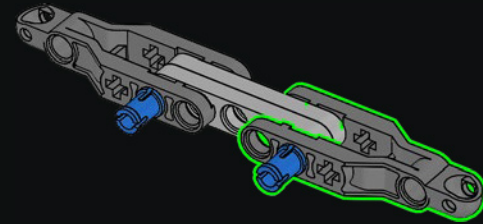

25

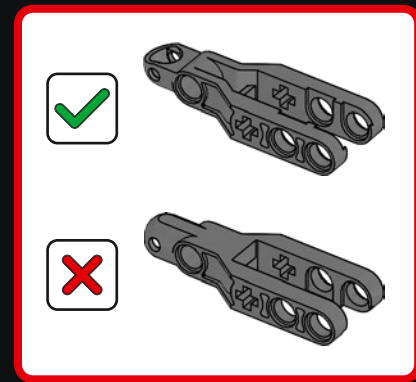
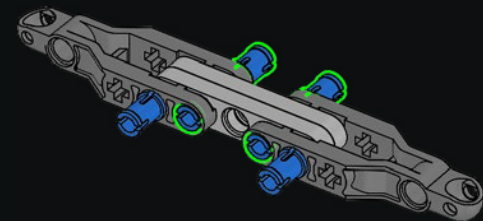



26

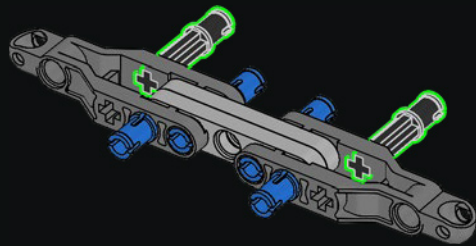

27

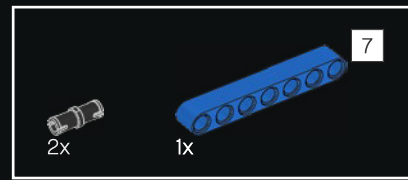
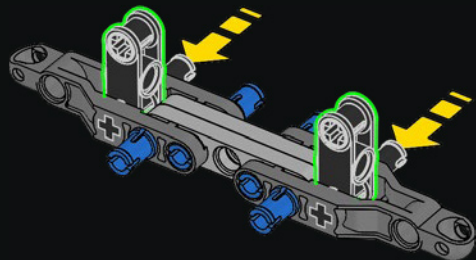

28

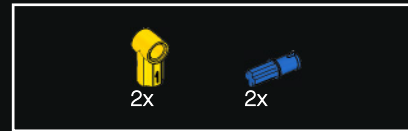
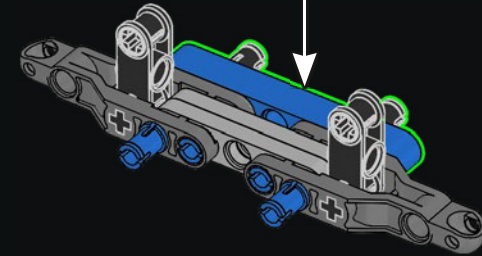
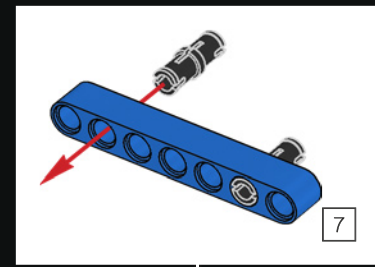

29

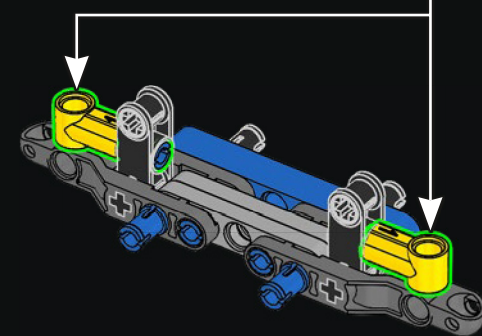
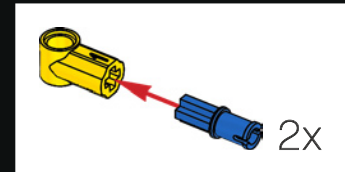



30

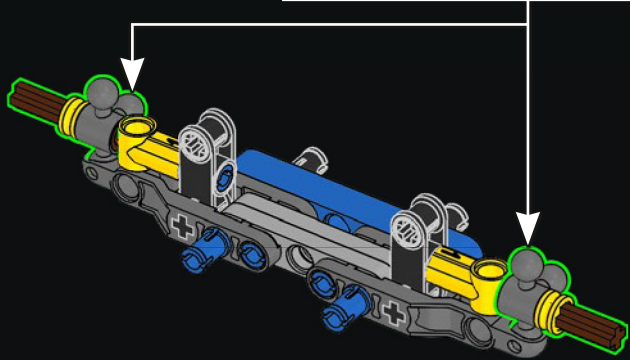
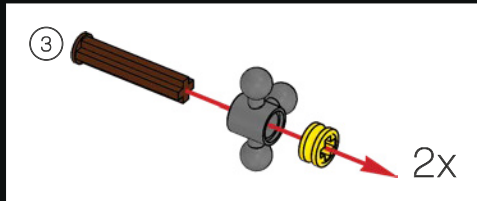

31

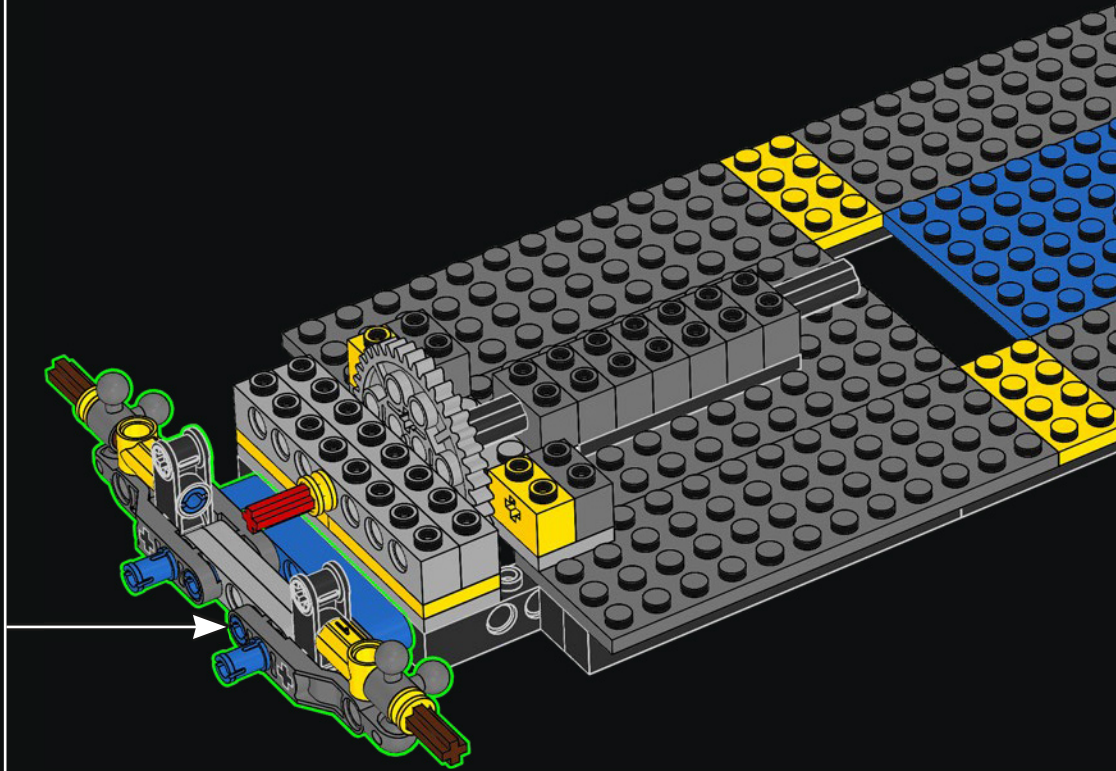

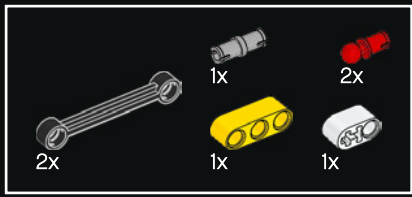

32

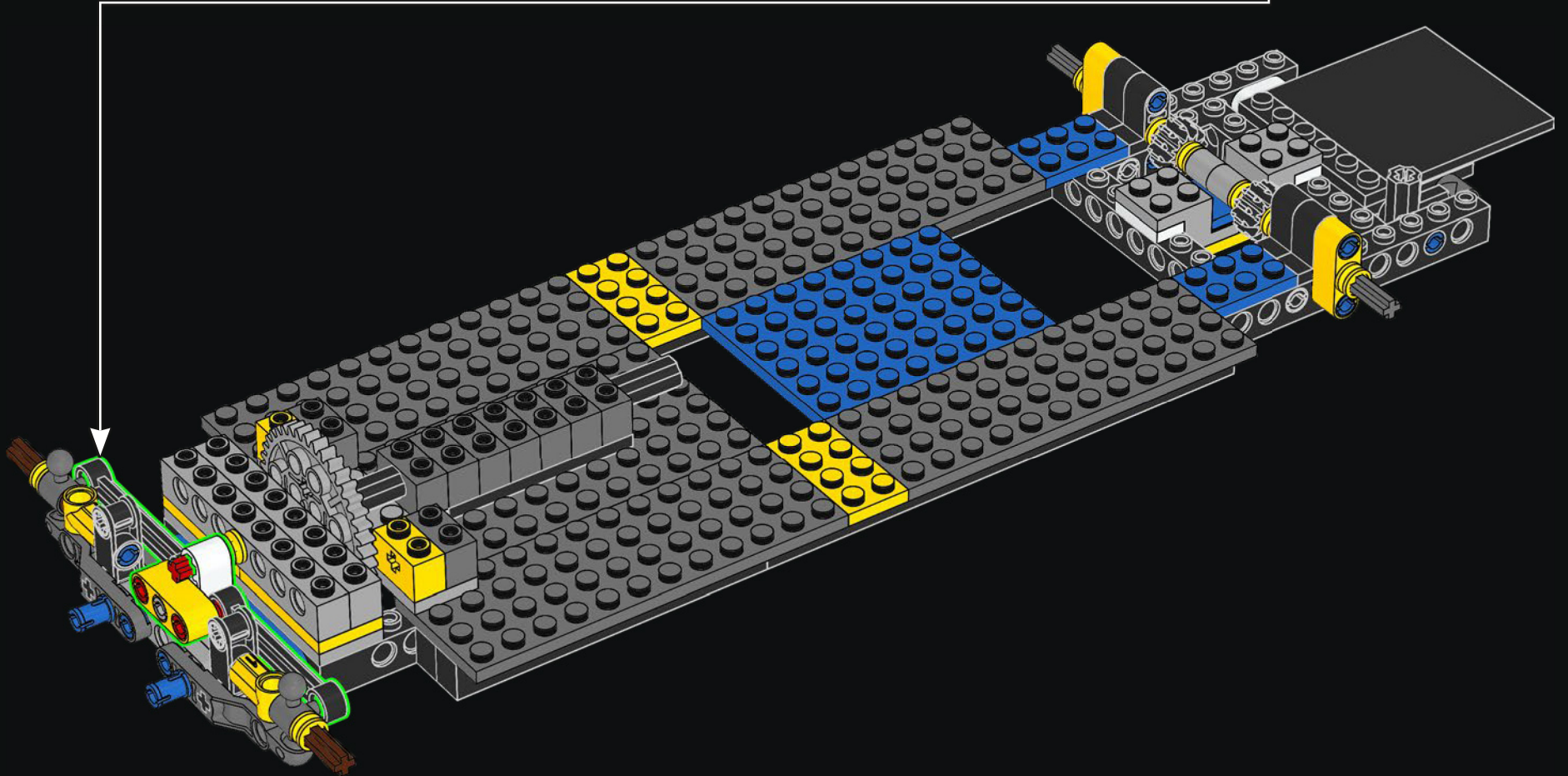
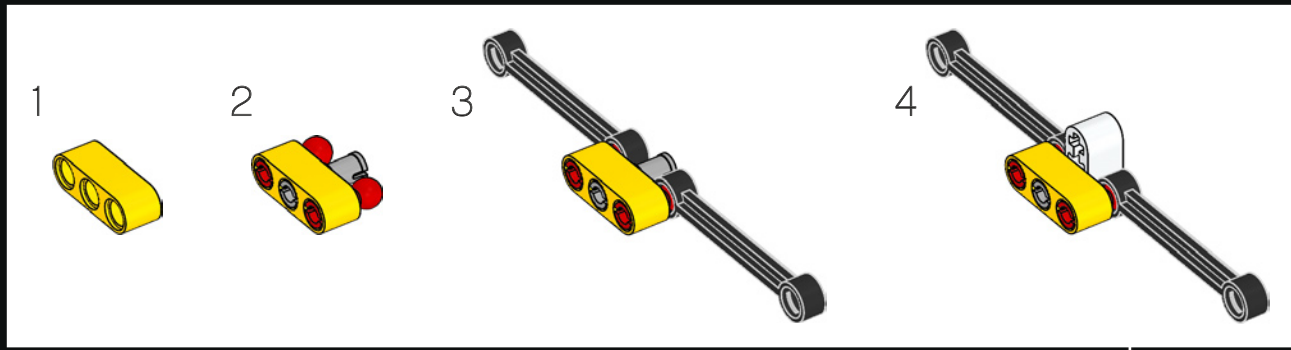

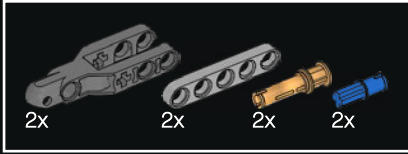
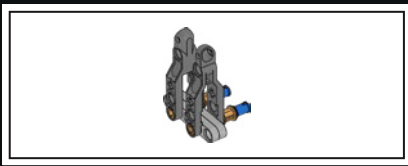

33

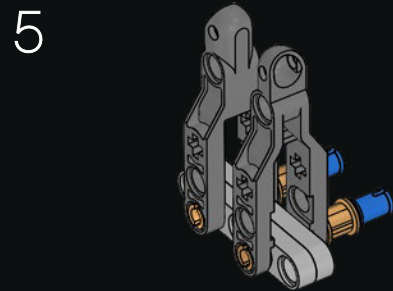
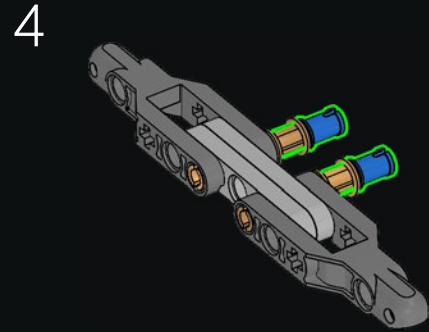
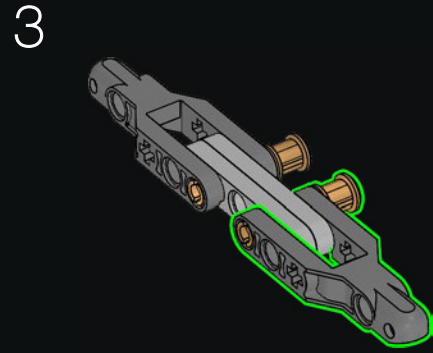
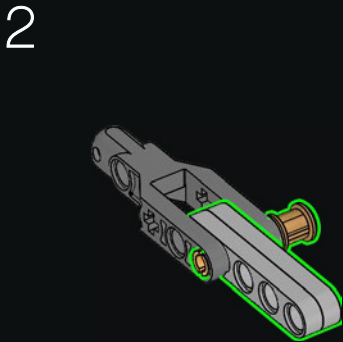
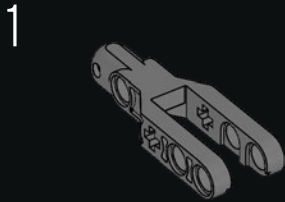
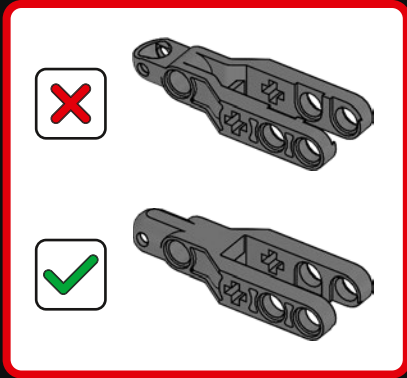

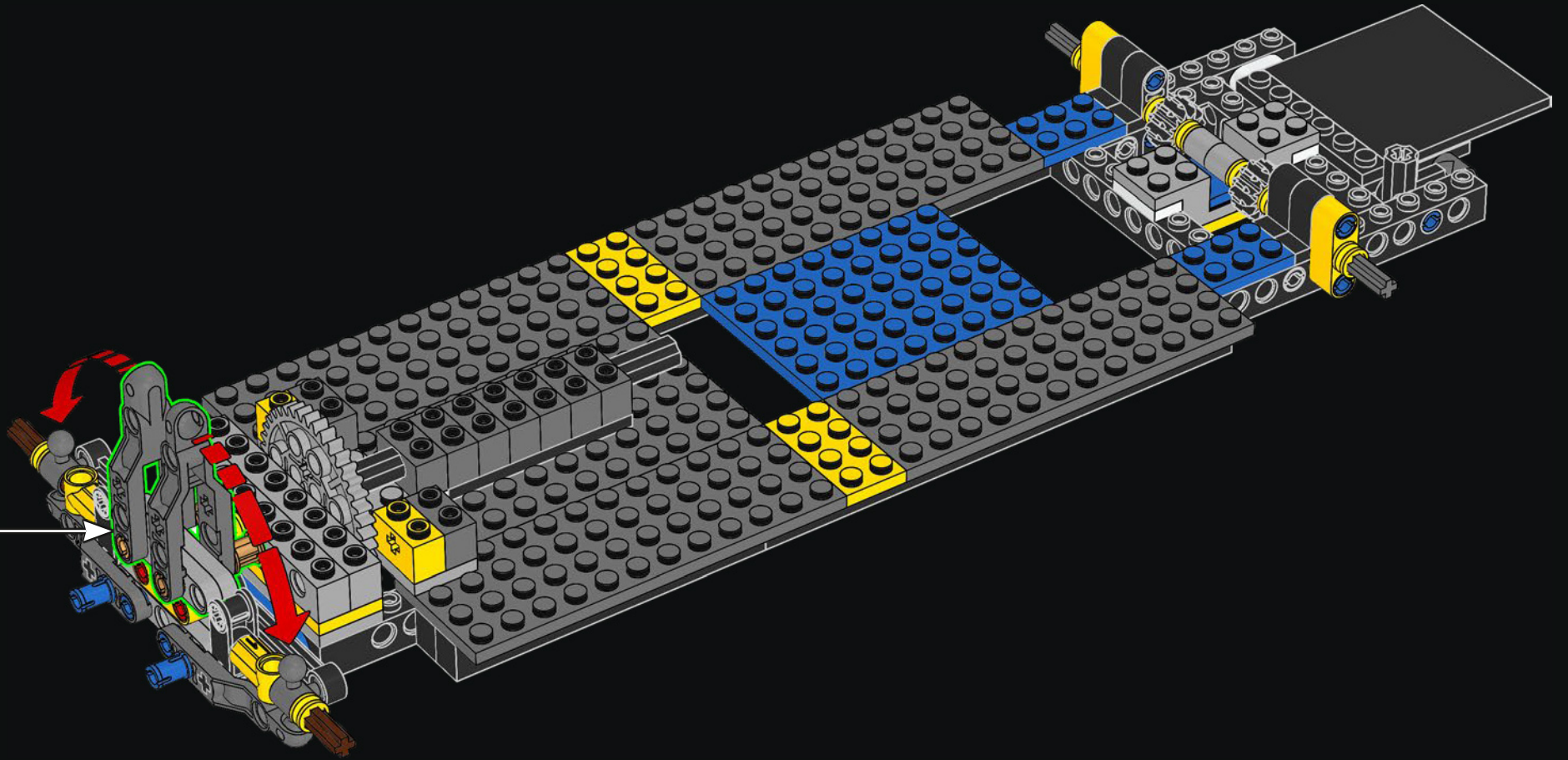

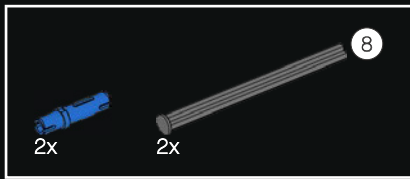

34

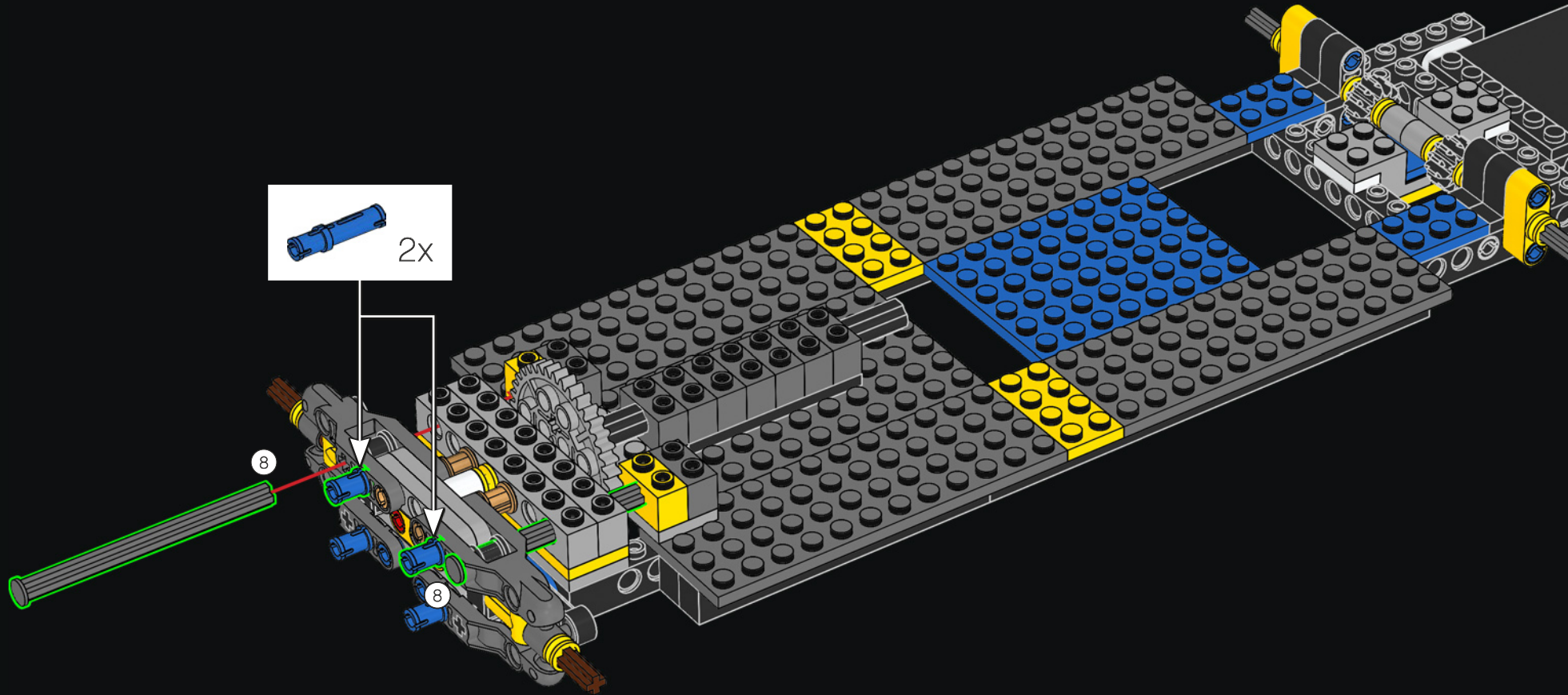

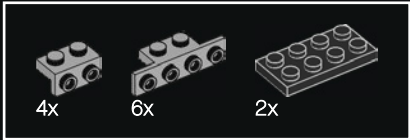
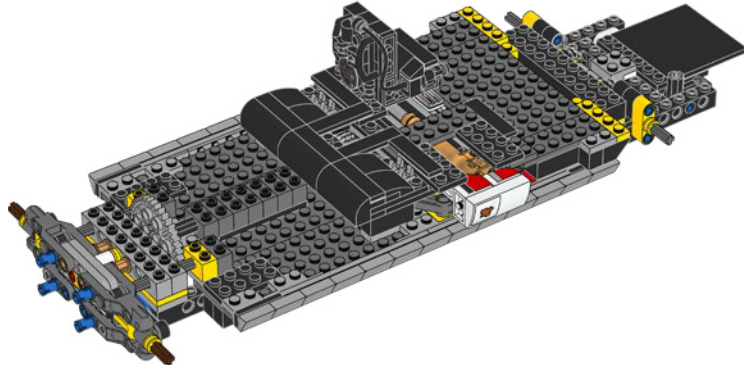
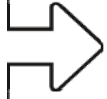

35

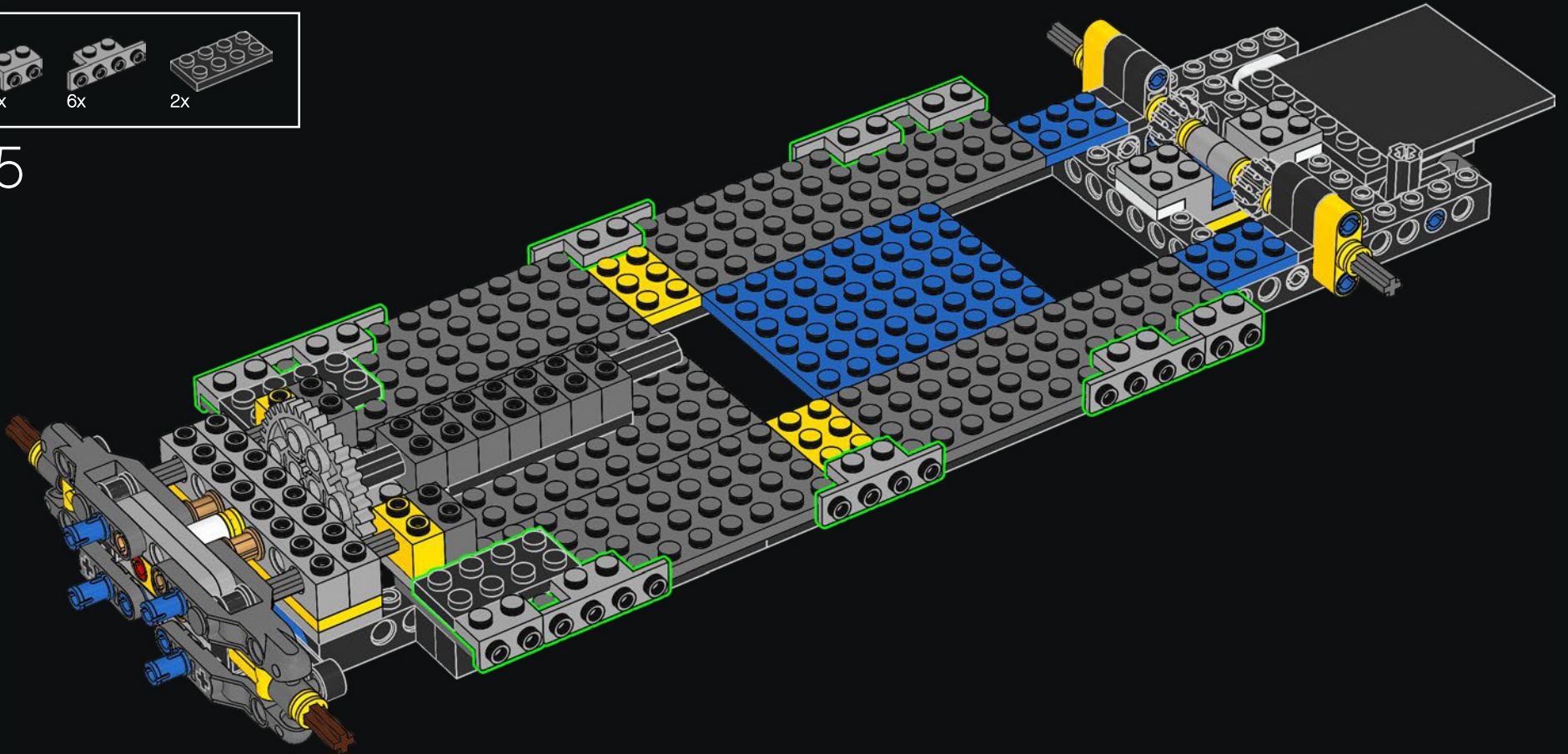

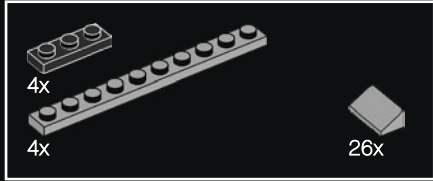
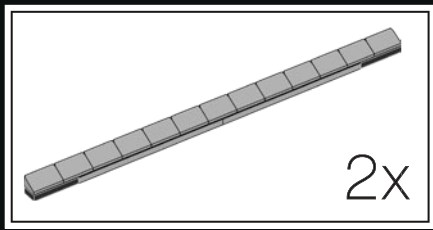

36

1

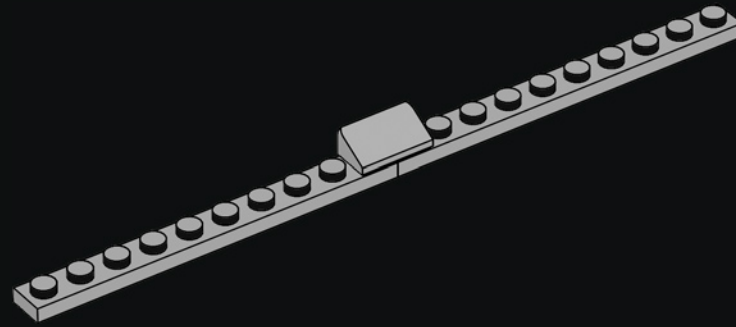

2

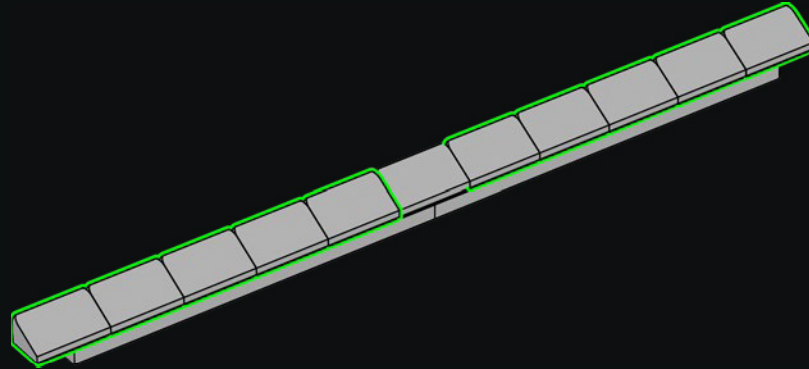

3

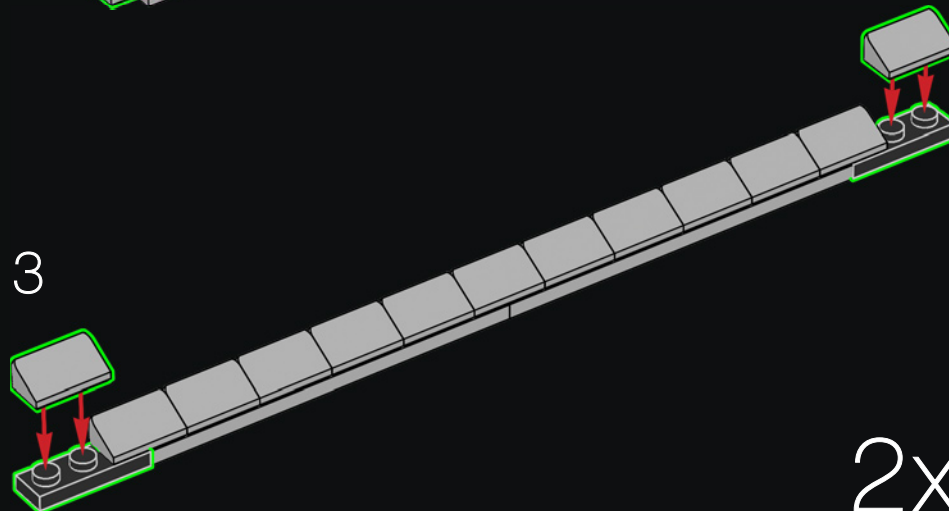

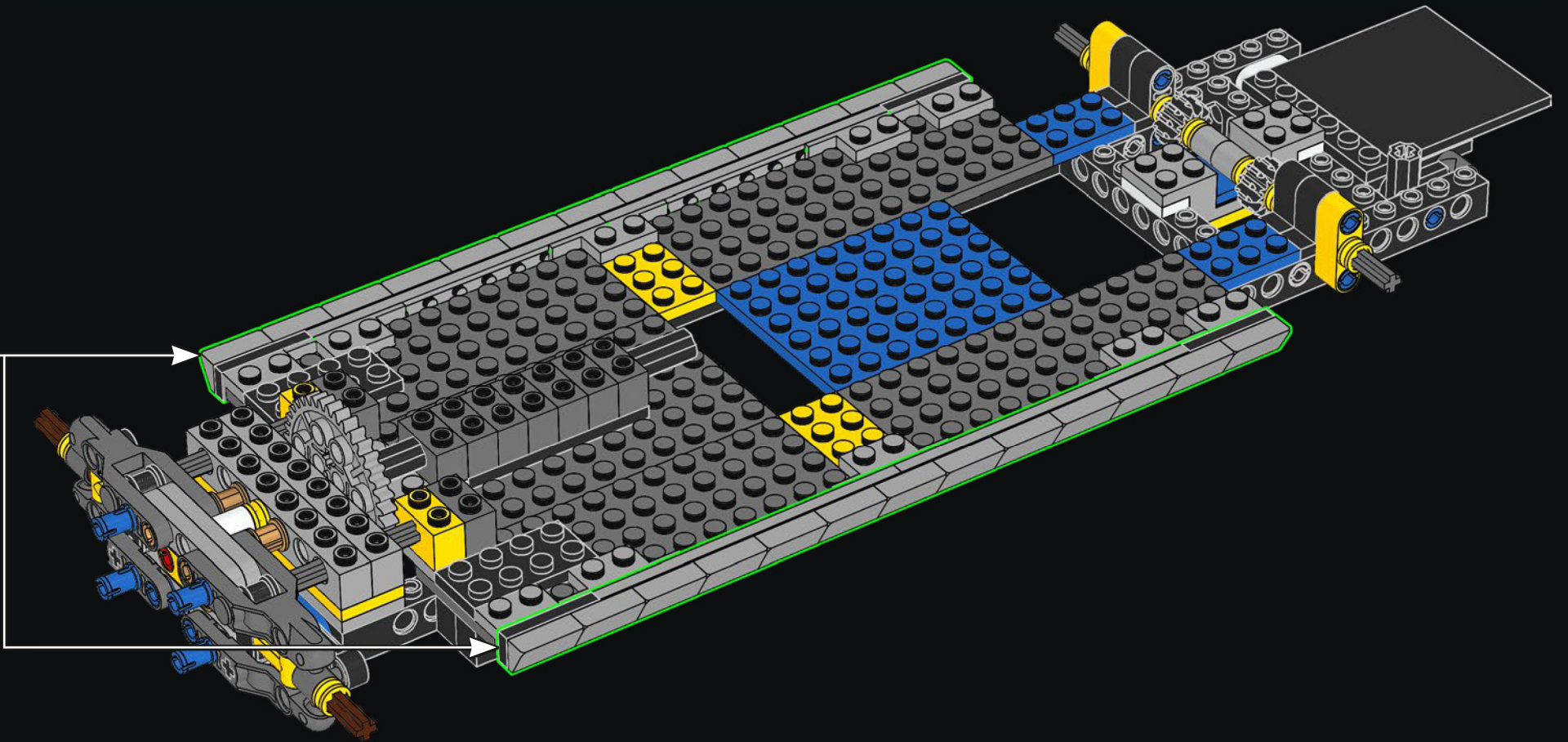

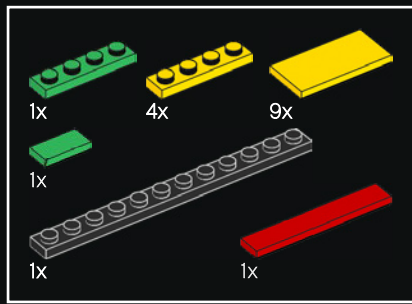

37

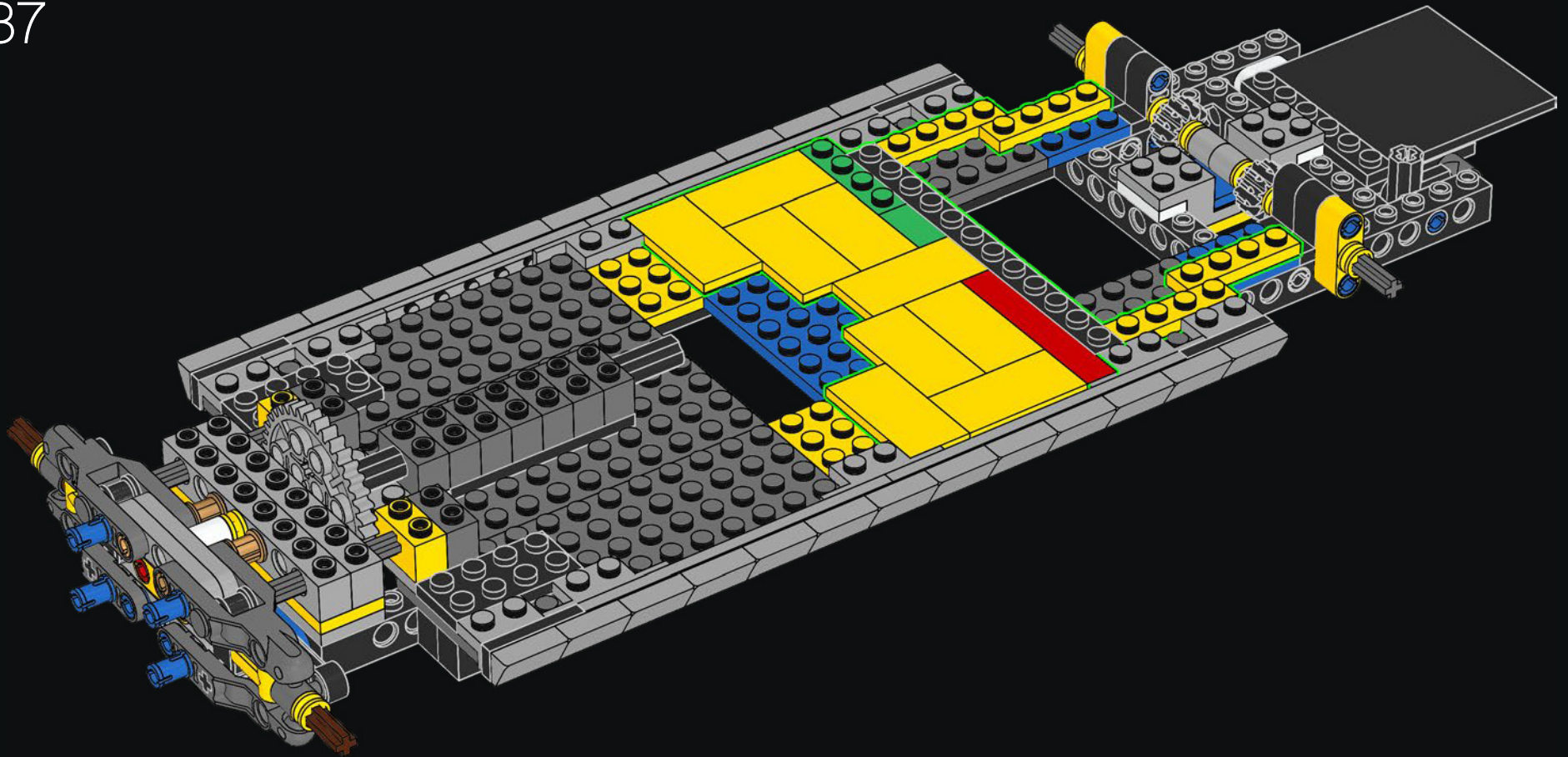

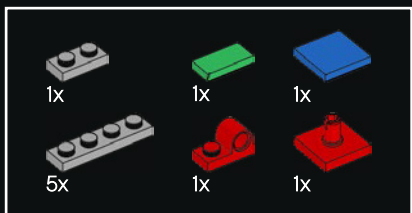

38

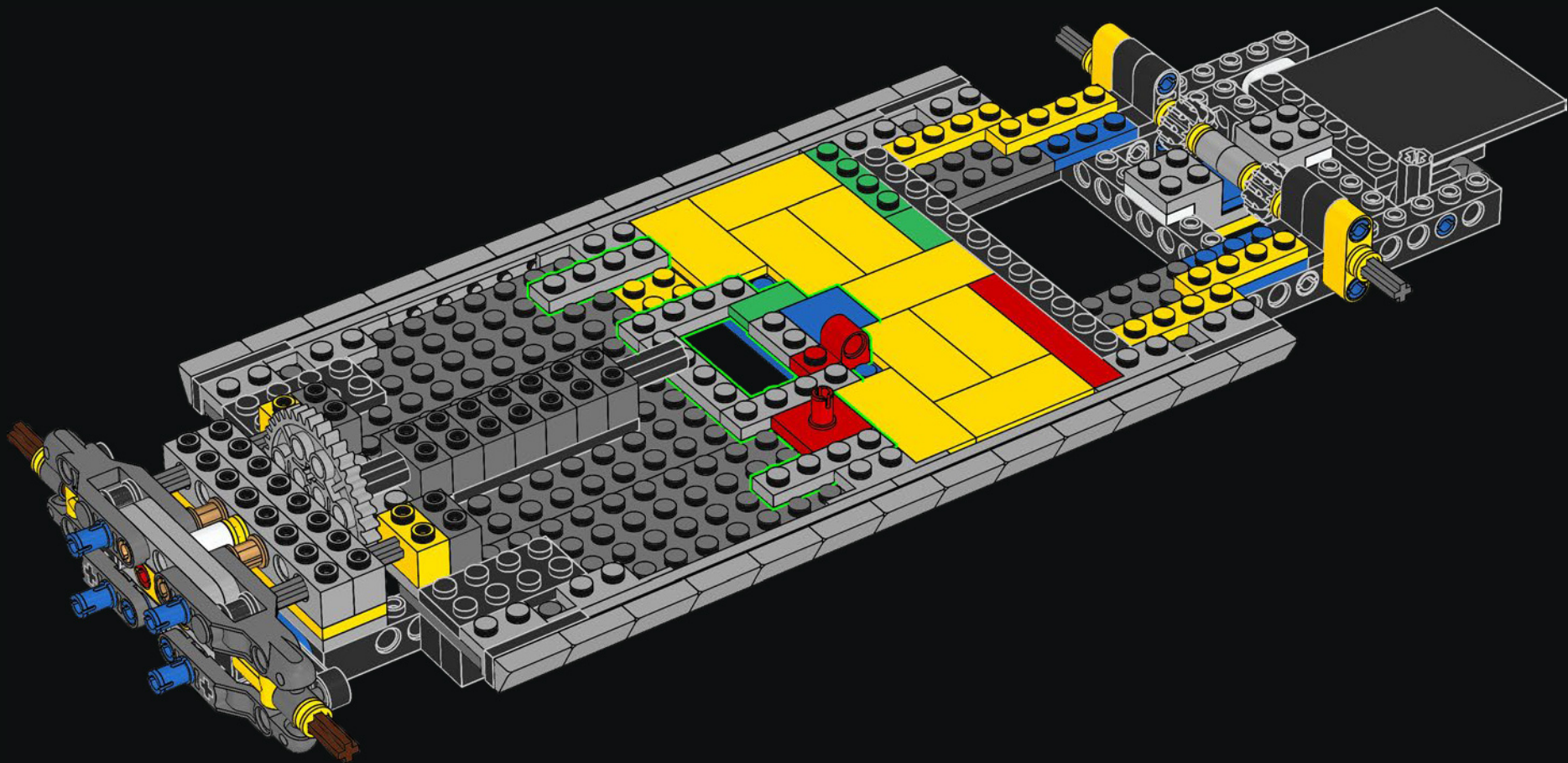

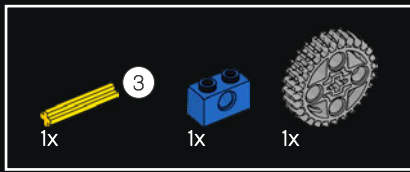

39

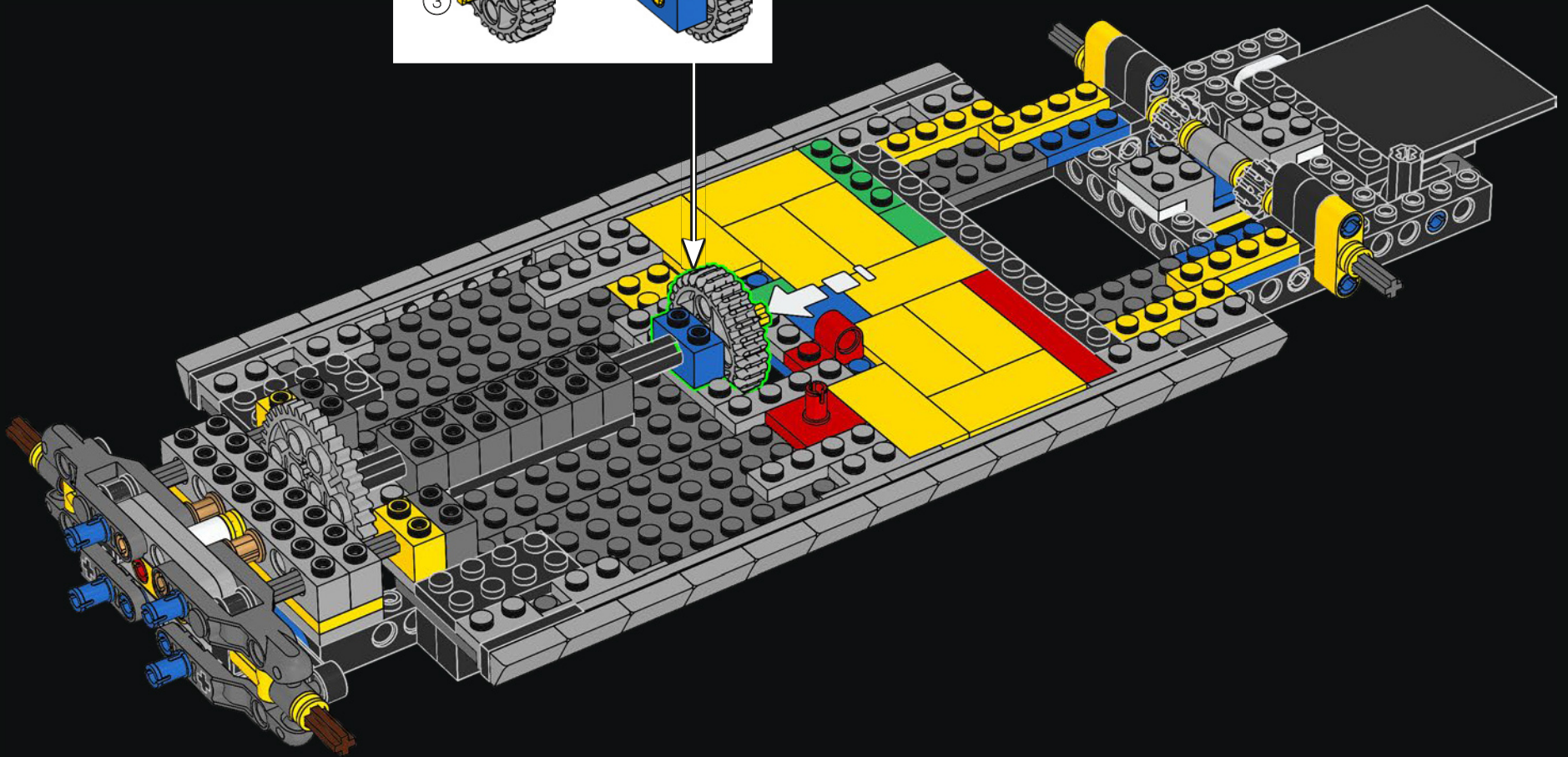
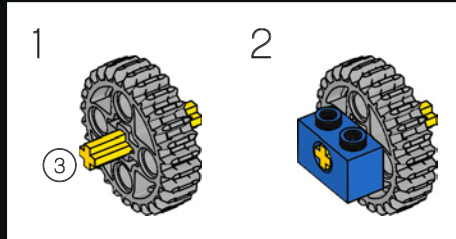

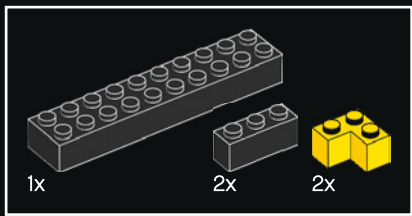

40

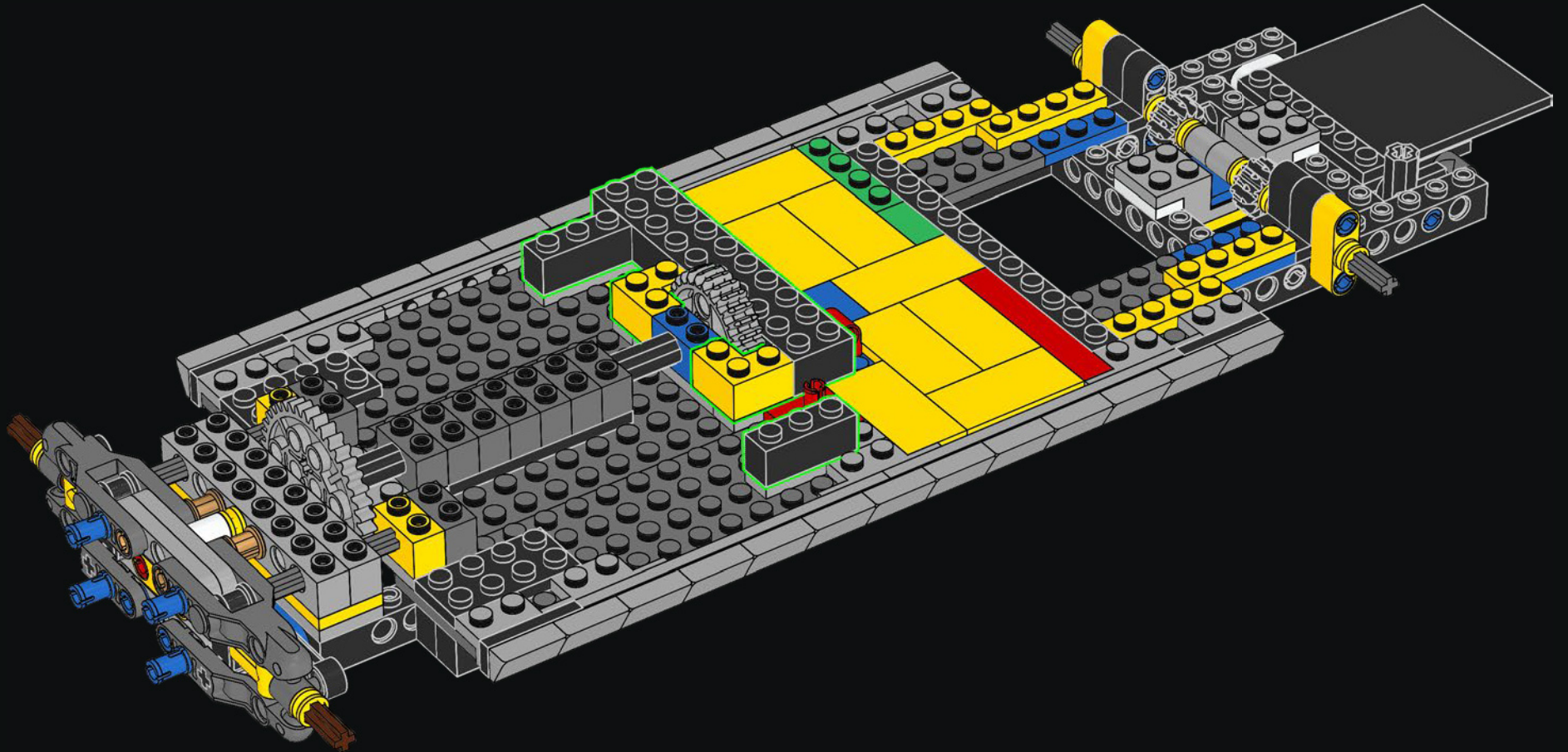

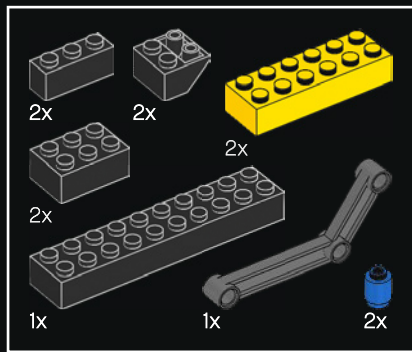

41

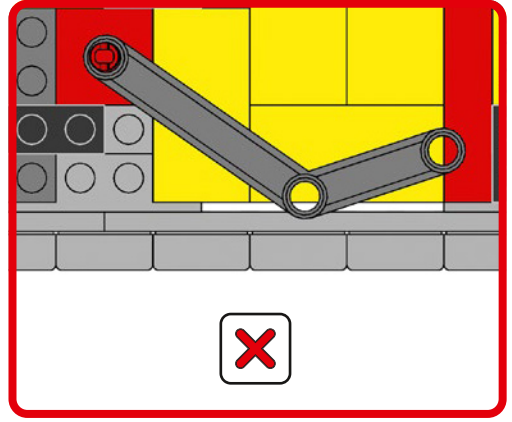
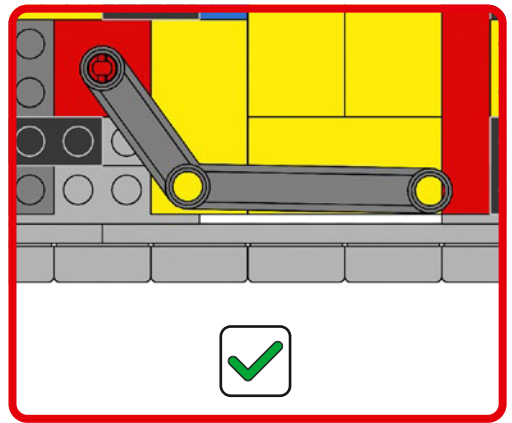
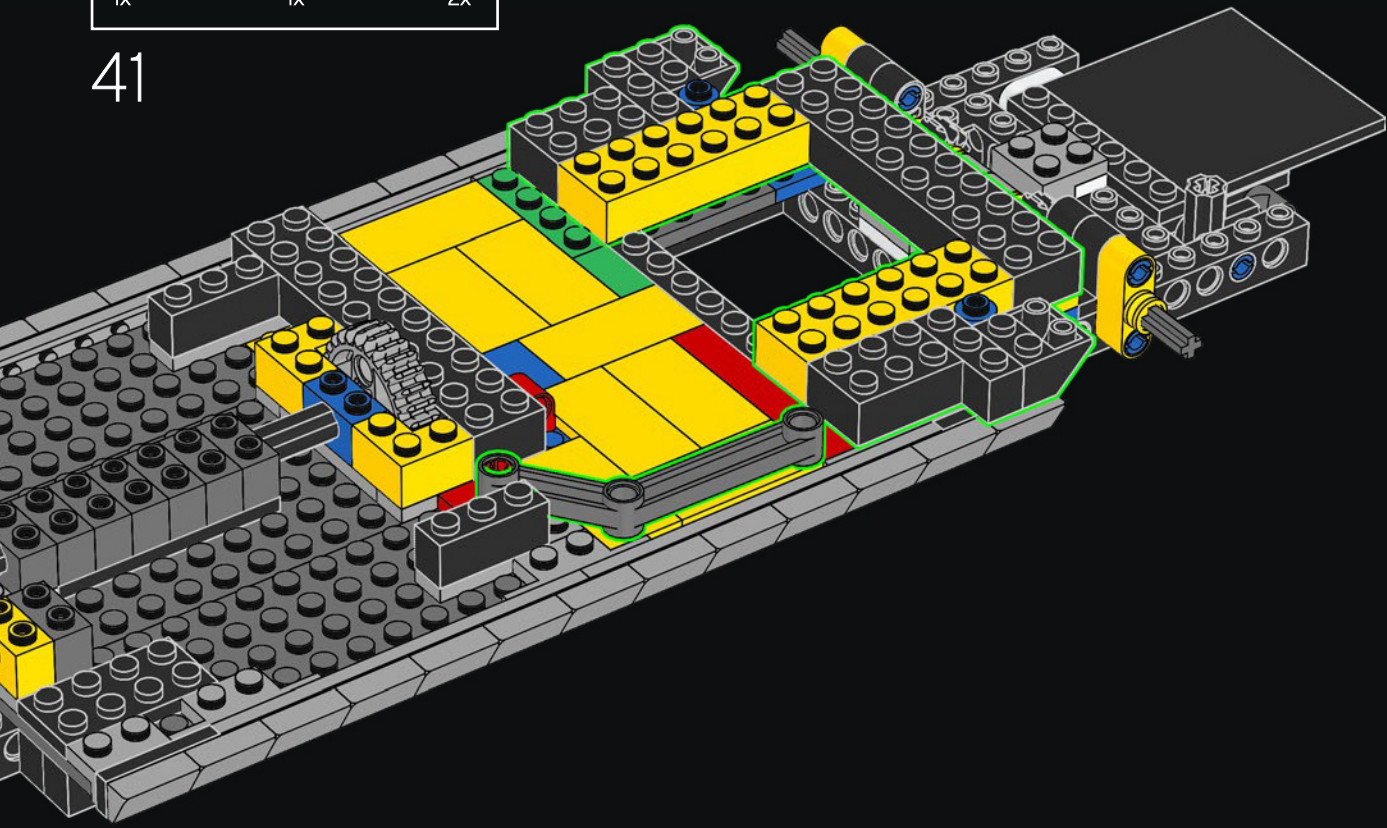

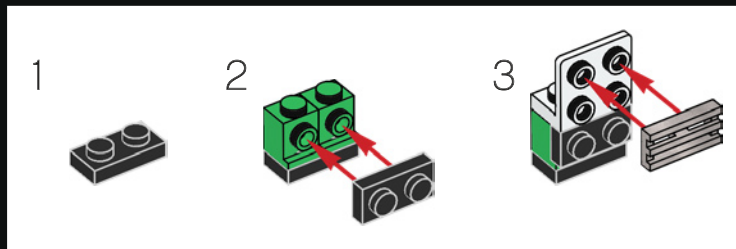
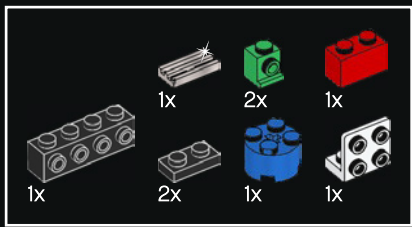

42

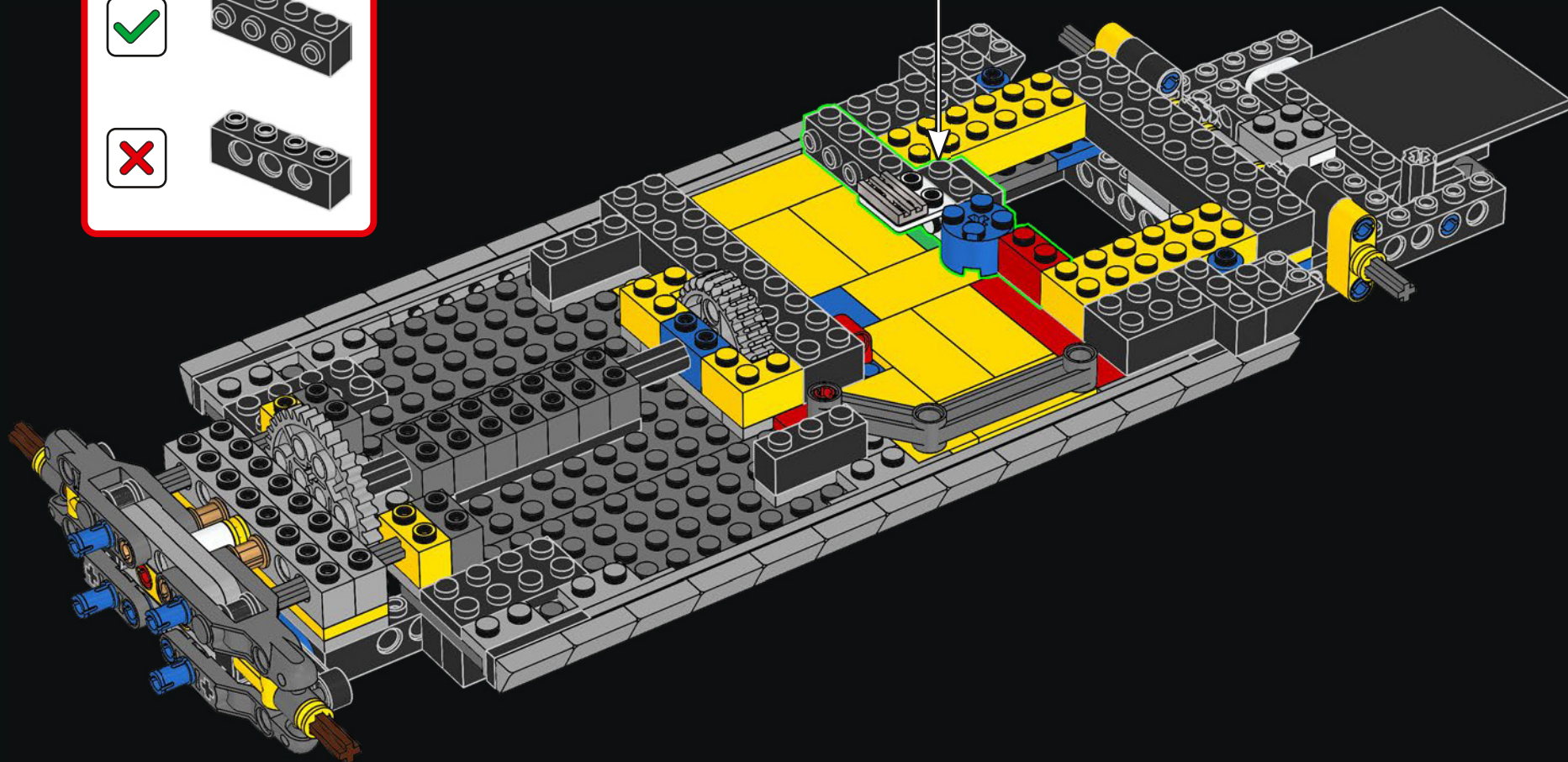
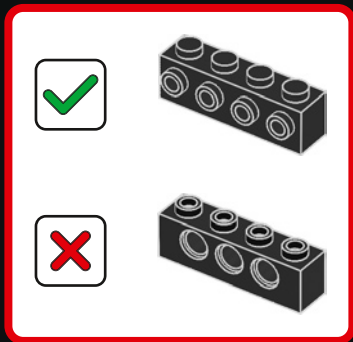

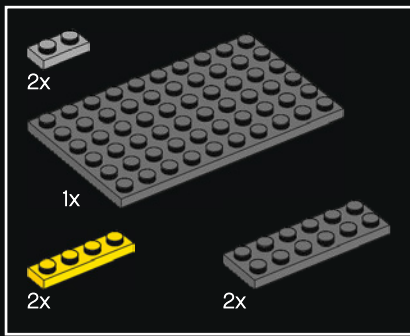

43

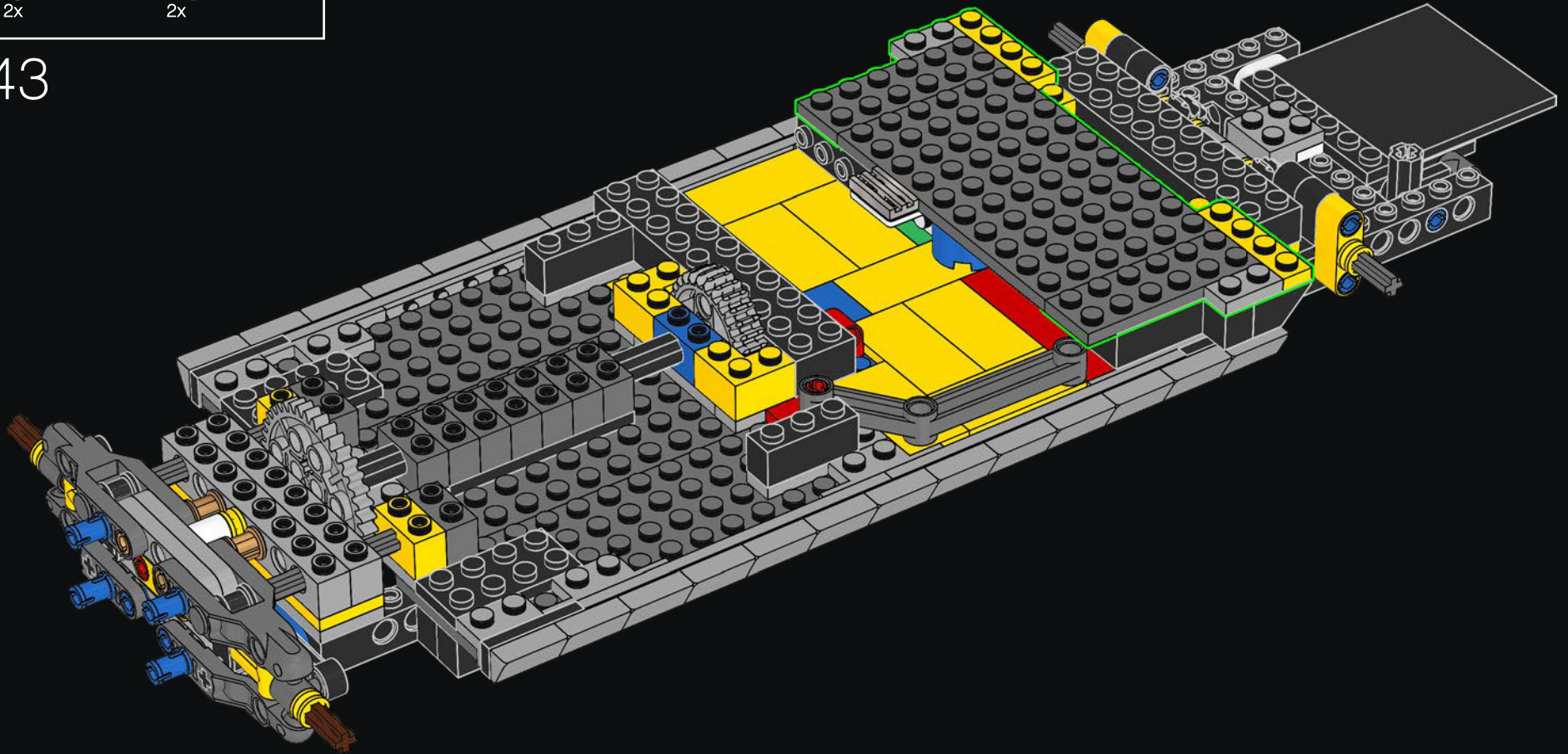

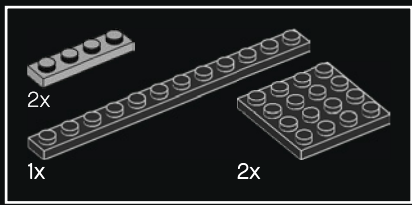

44

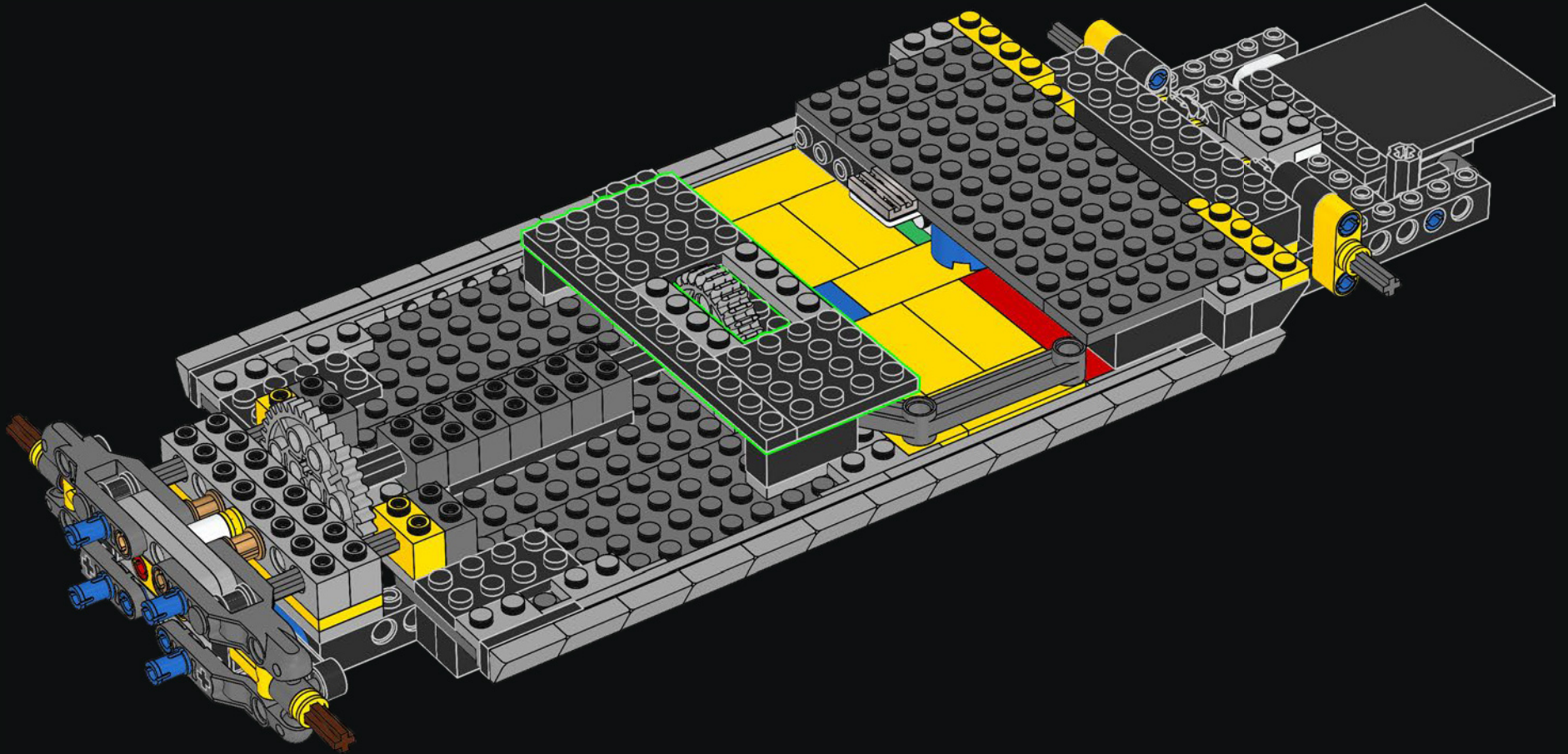

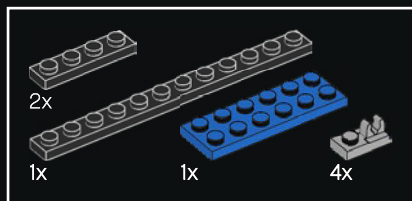

45

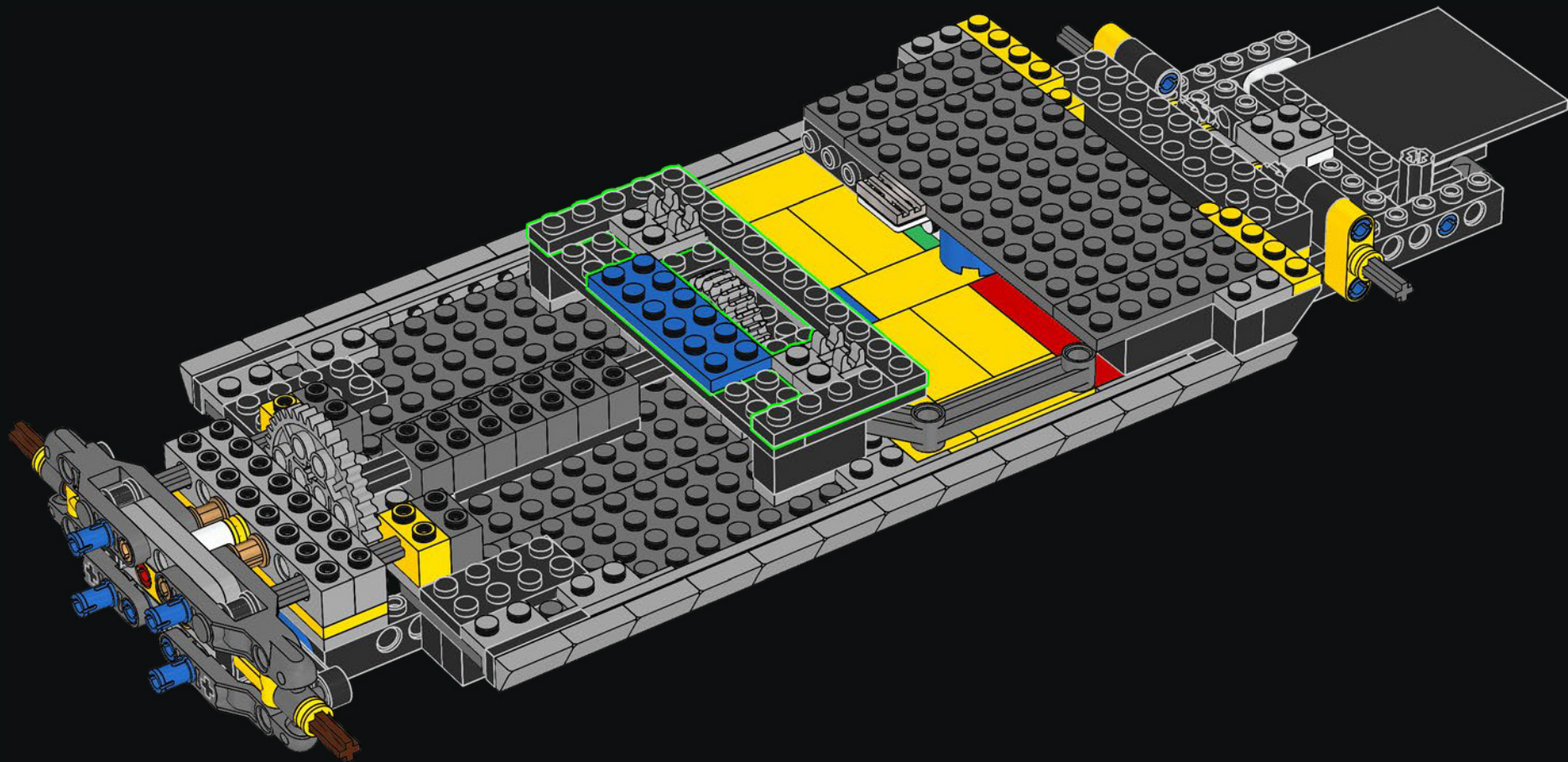

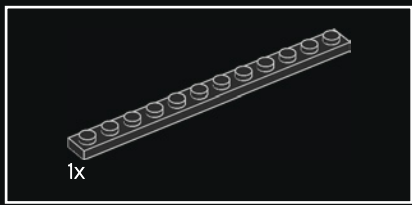

46

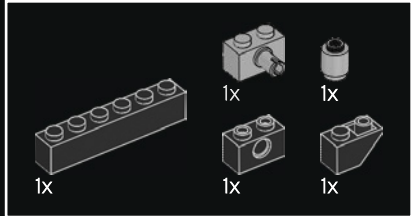
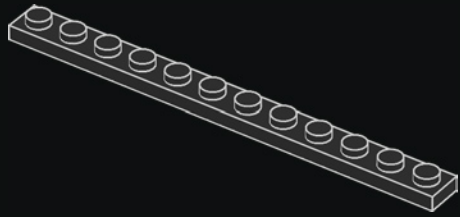

47

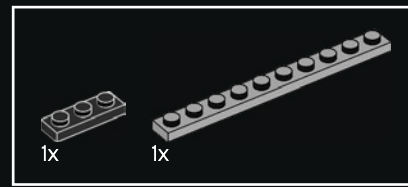
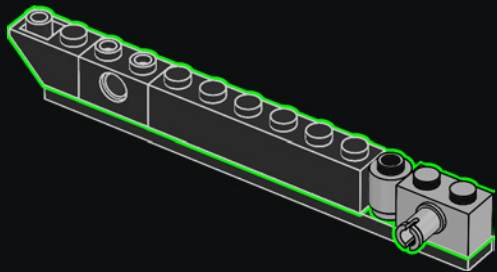

48

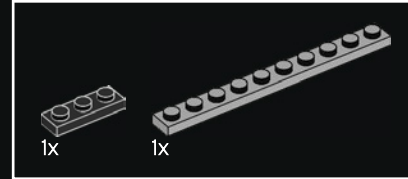
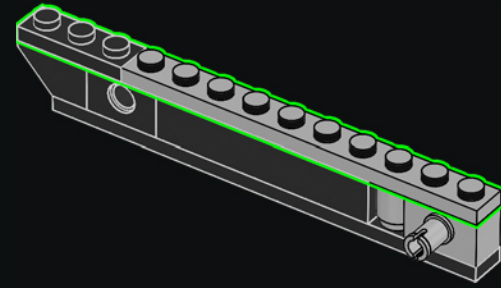

49

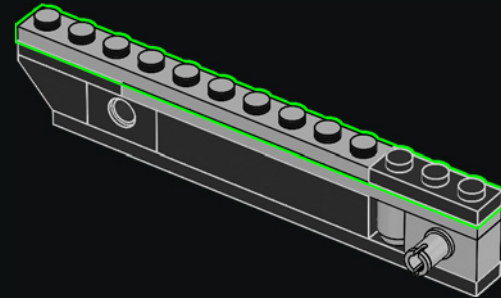

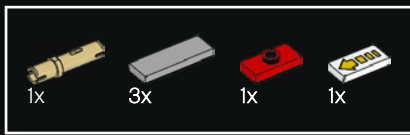

50

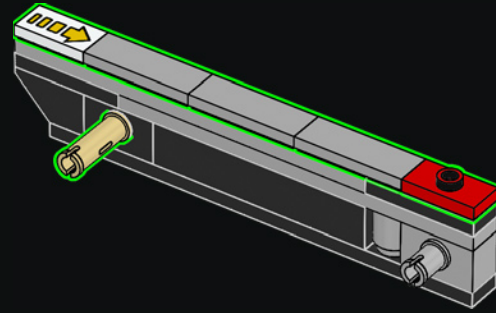

51

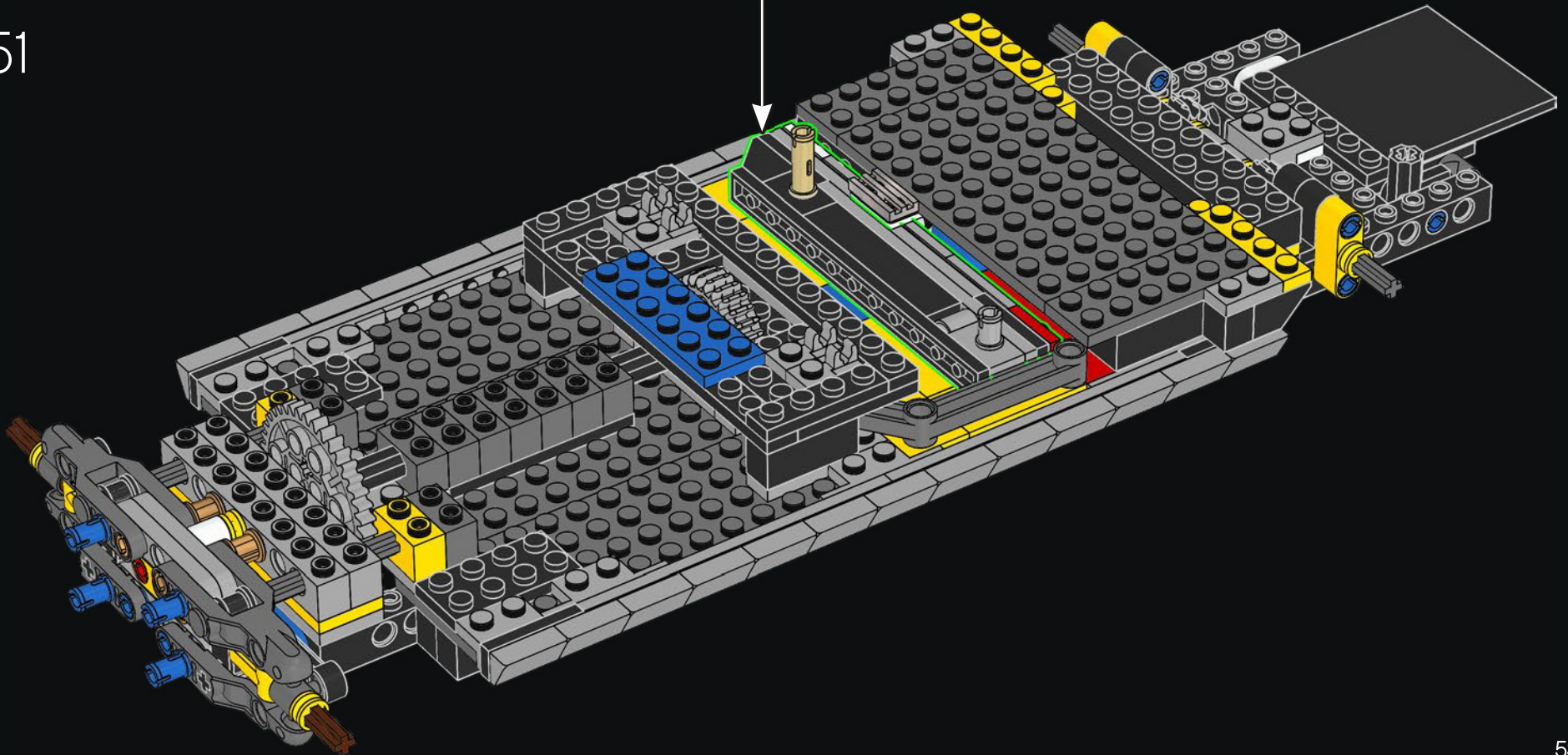

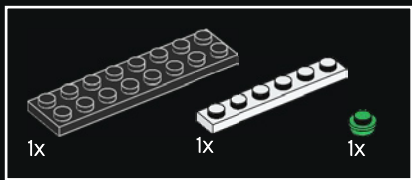

52

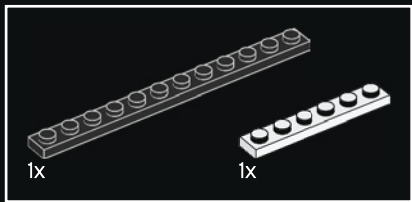
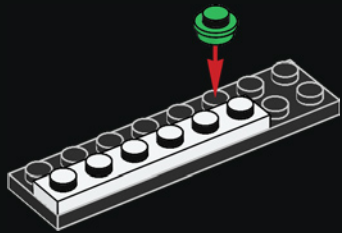

53

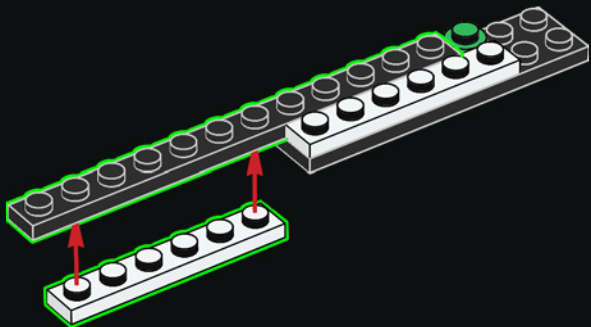

54



54

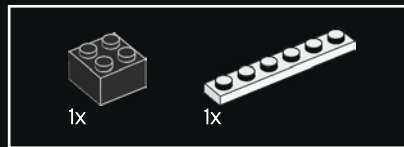
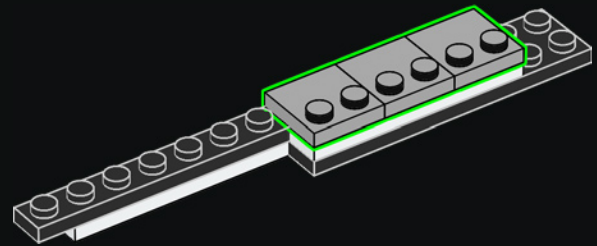

55

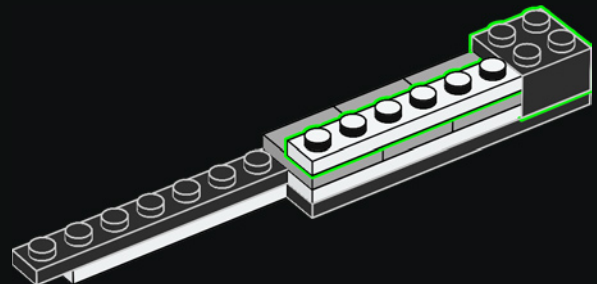



56

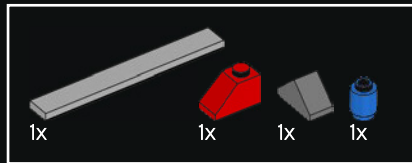
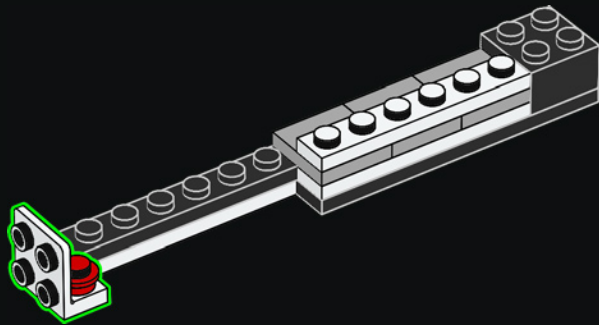

57

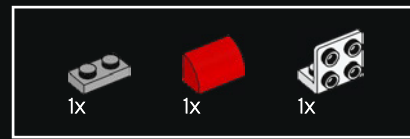
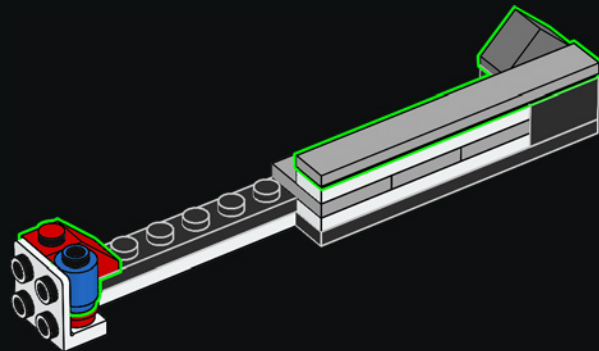

58

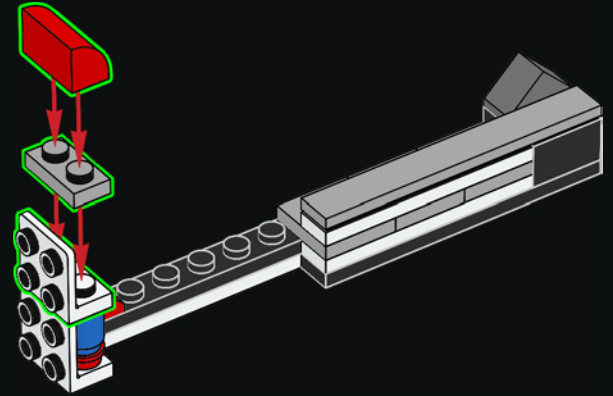

59

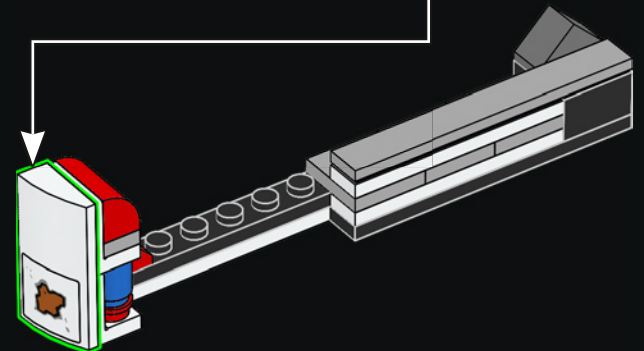
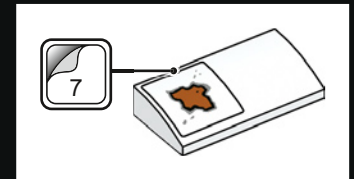

60

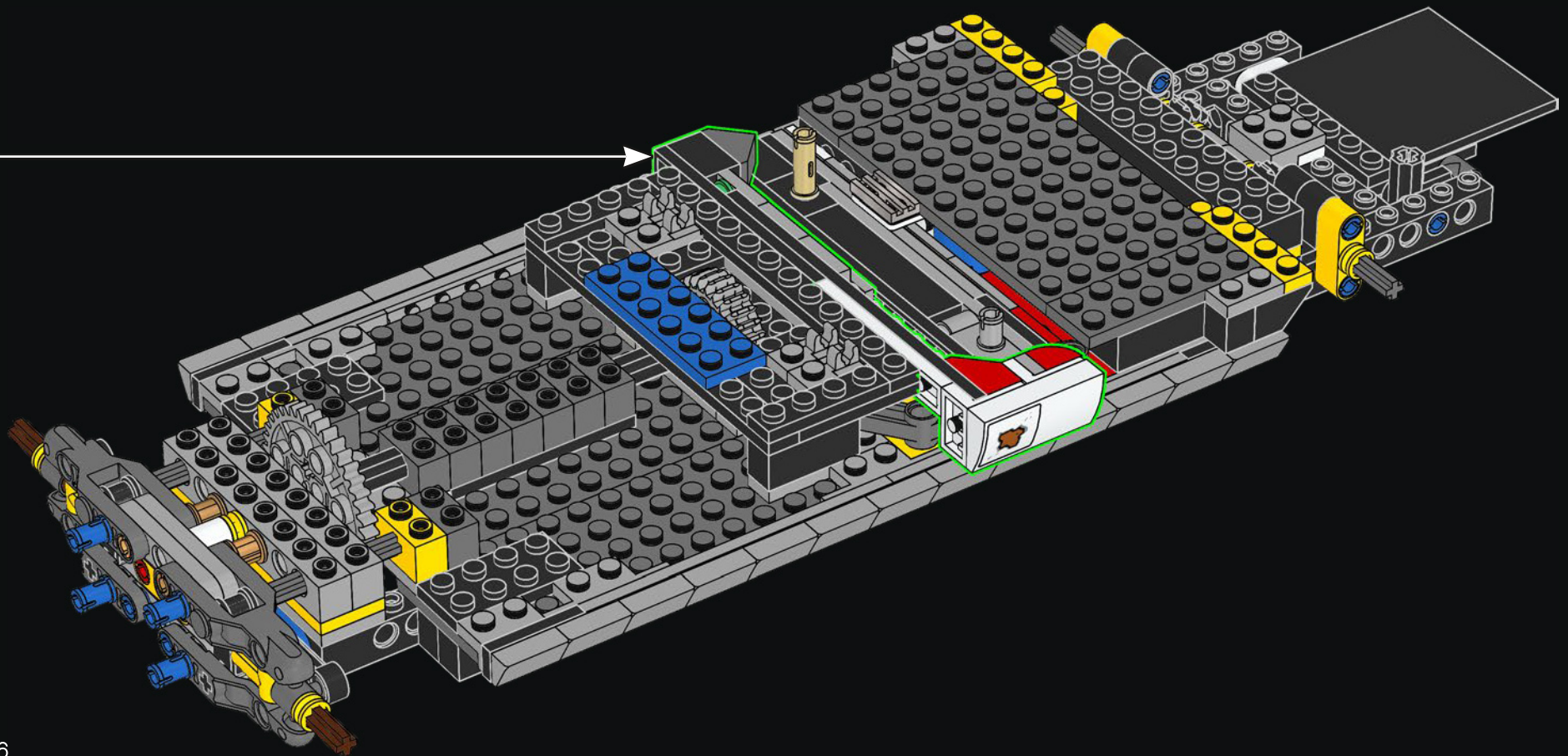



61

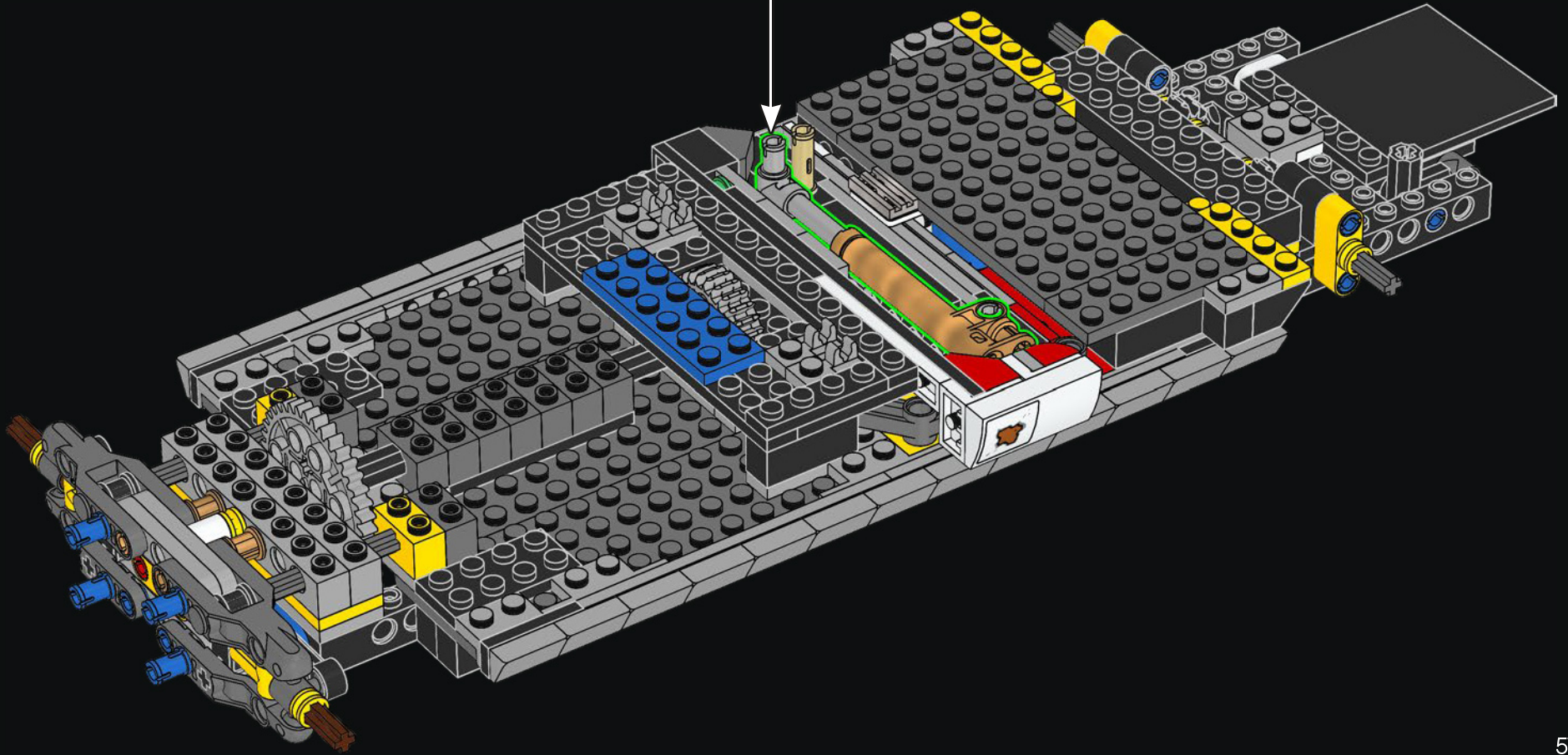
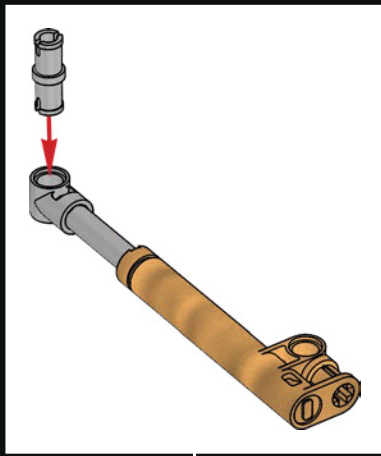

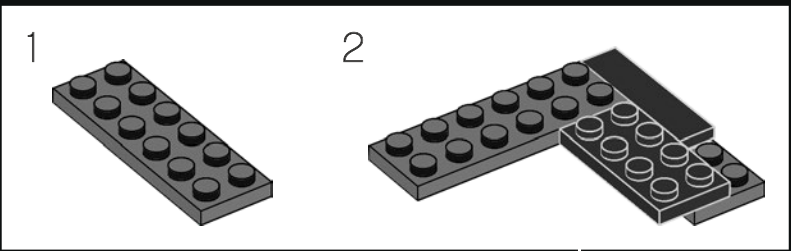
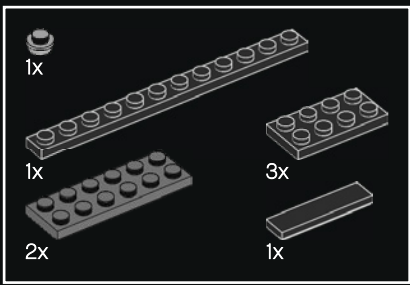

62

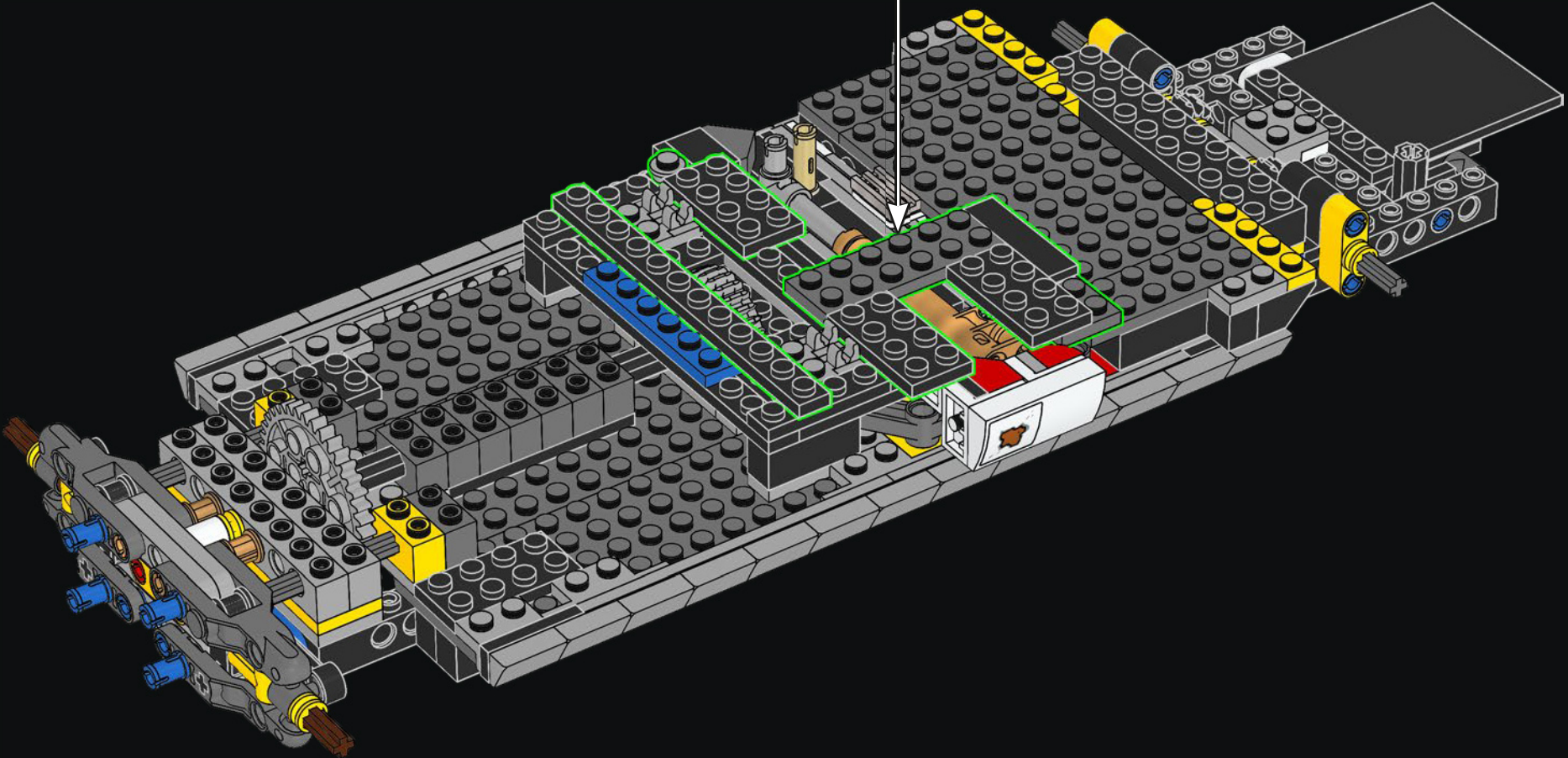

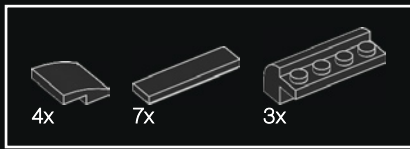

63

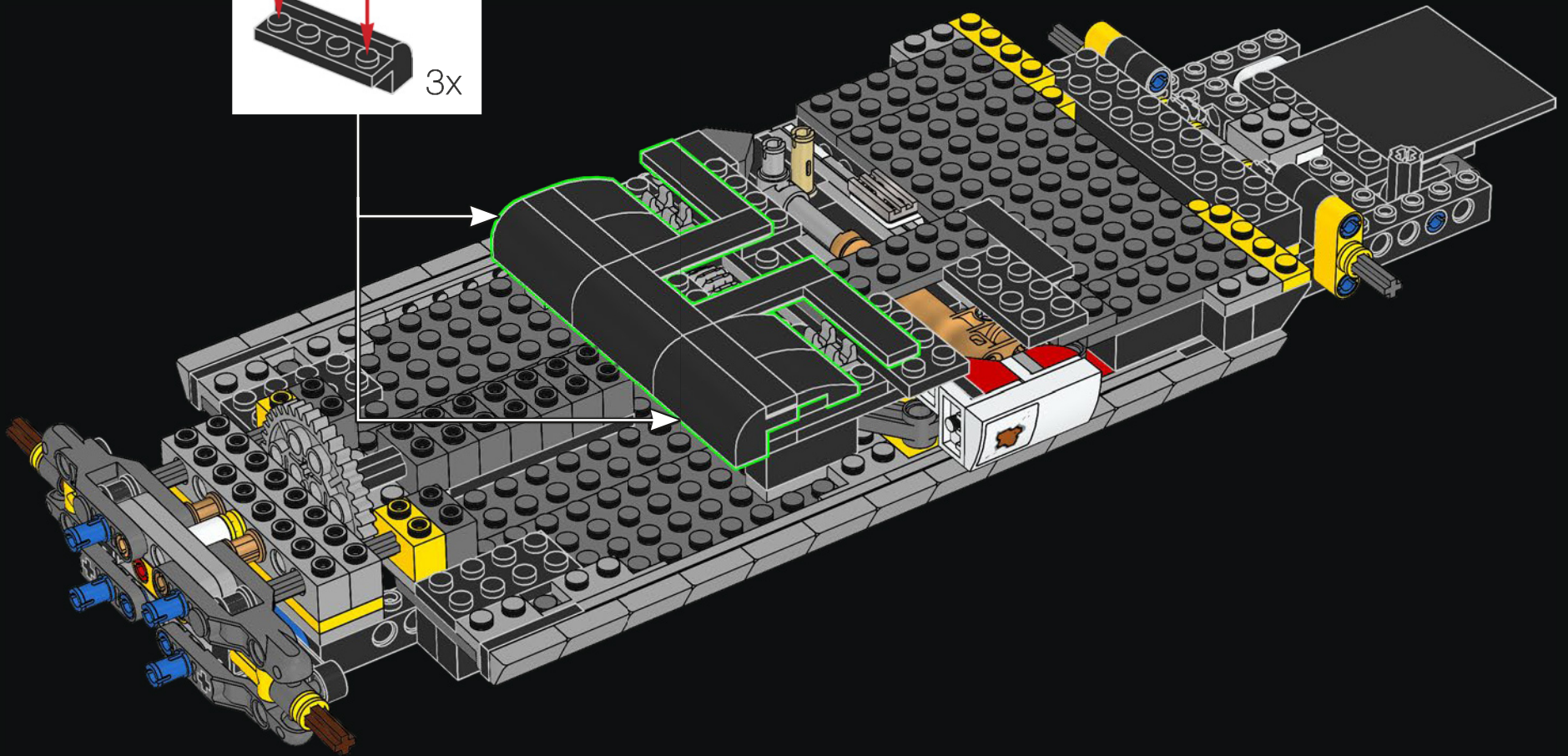
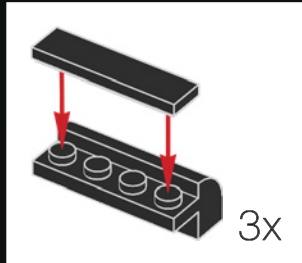

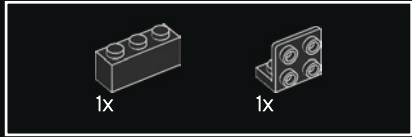
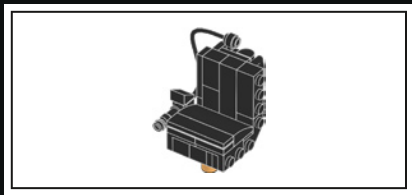

64

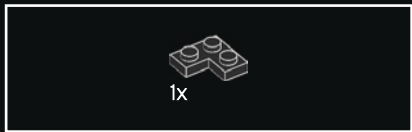
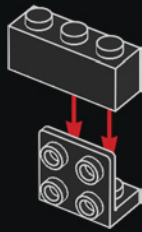

65

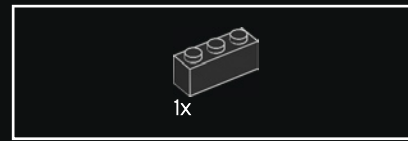
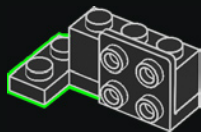

66

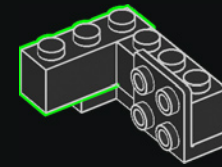

67

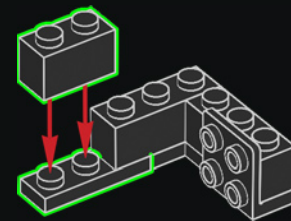

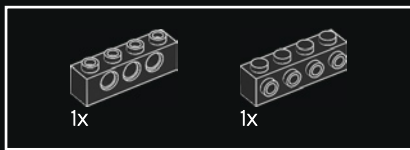

68

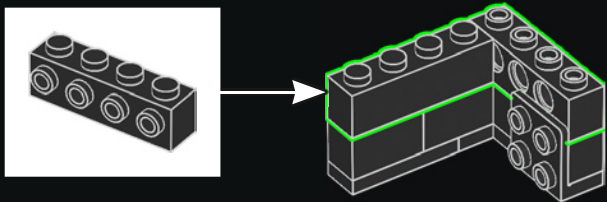

69

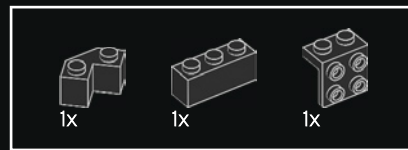
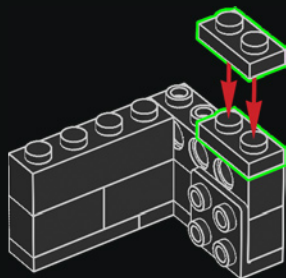

70

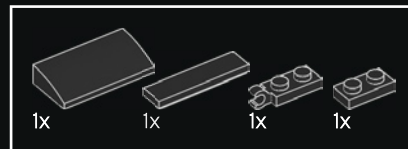
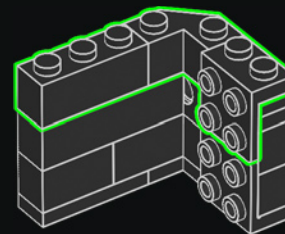

71

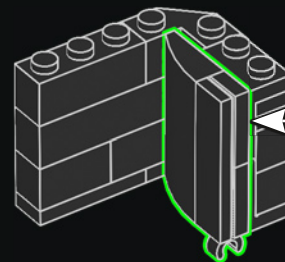
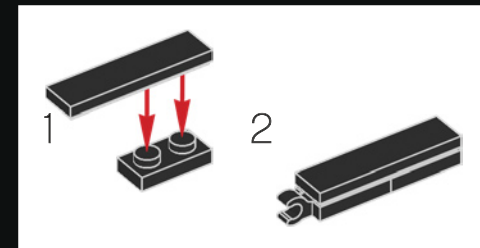

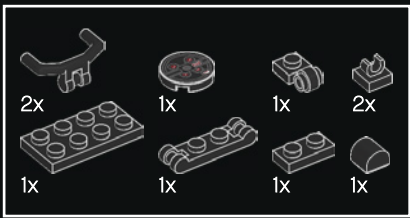

72

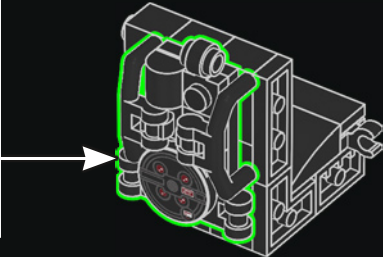
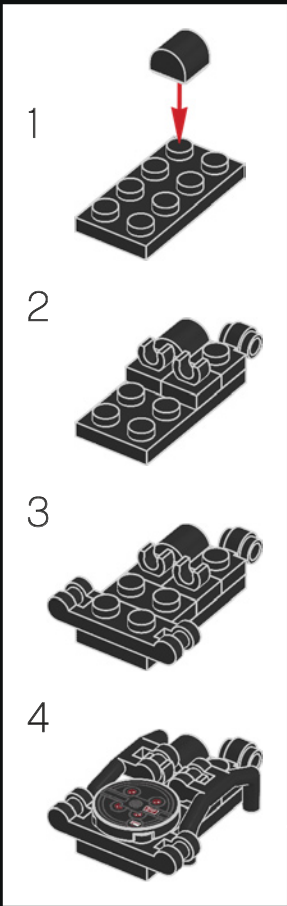

73

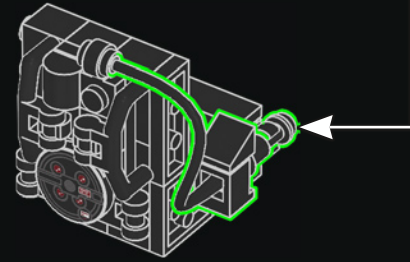
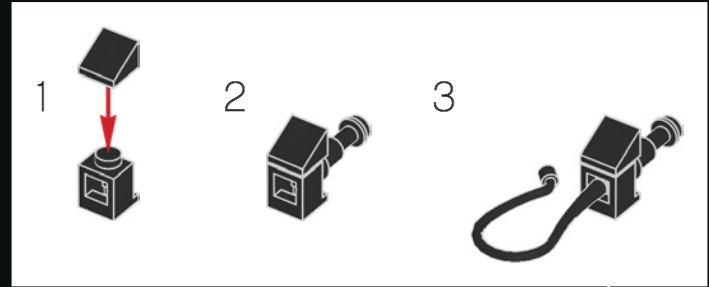

74

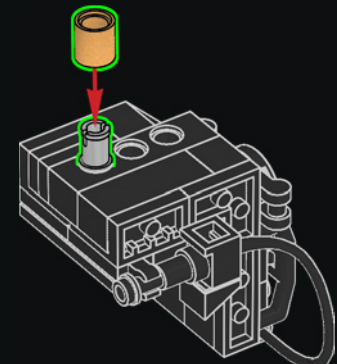

75

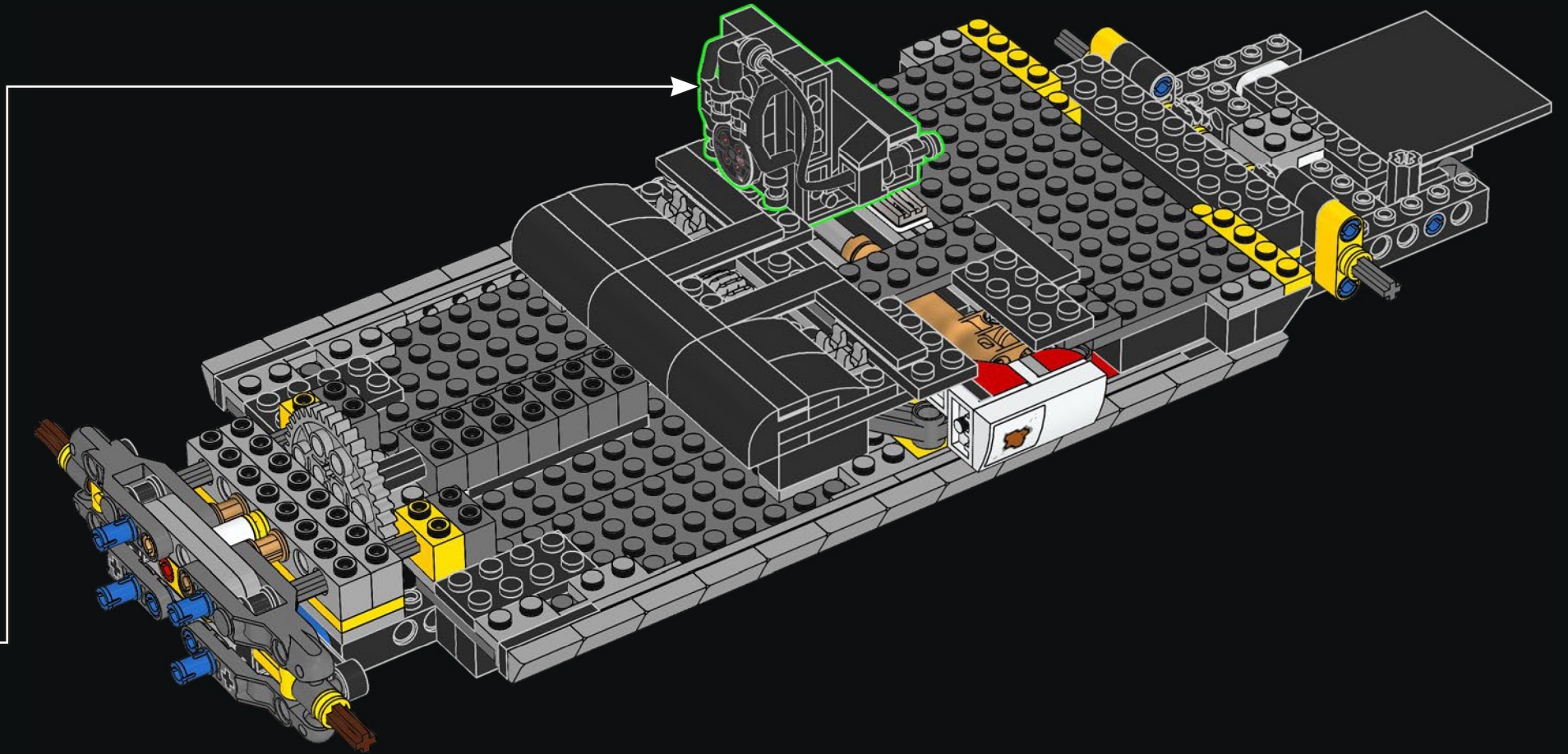

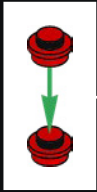
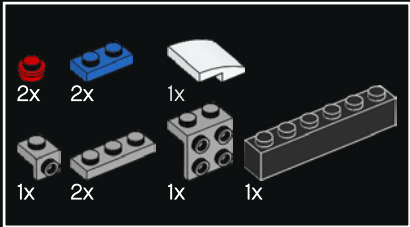
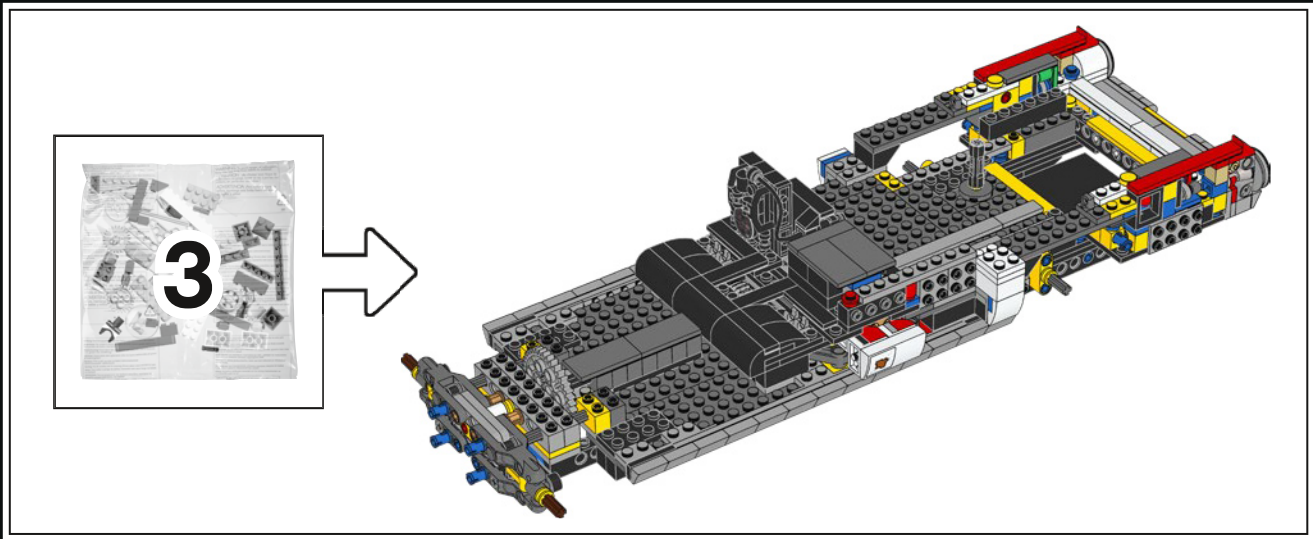

76

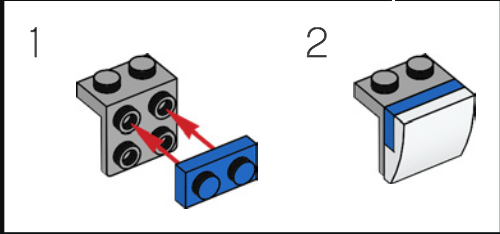
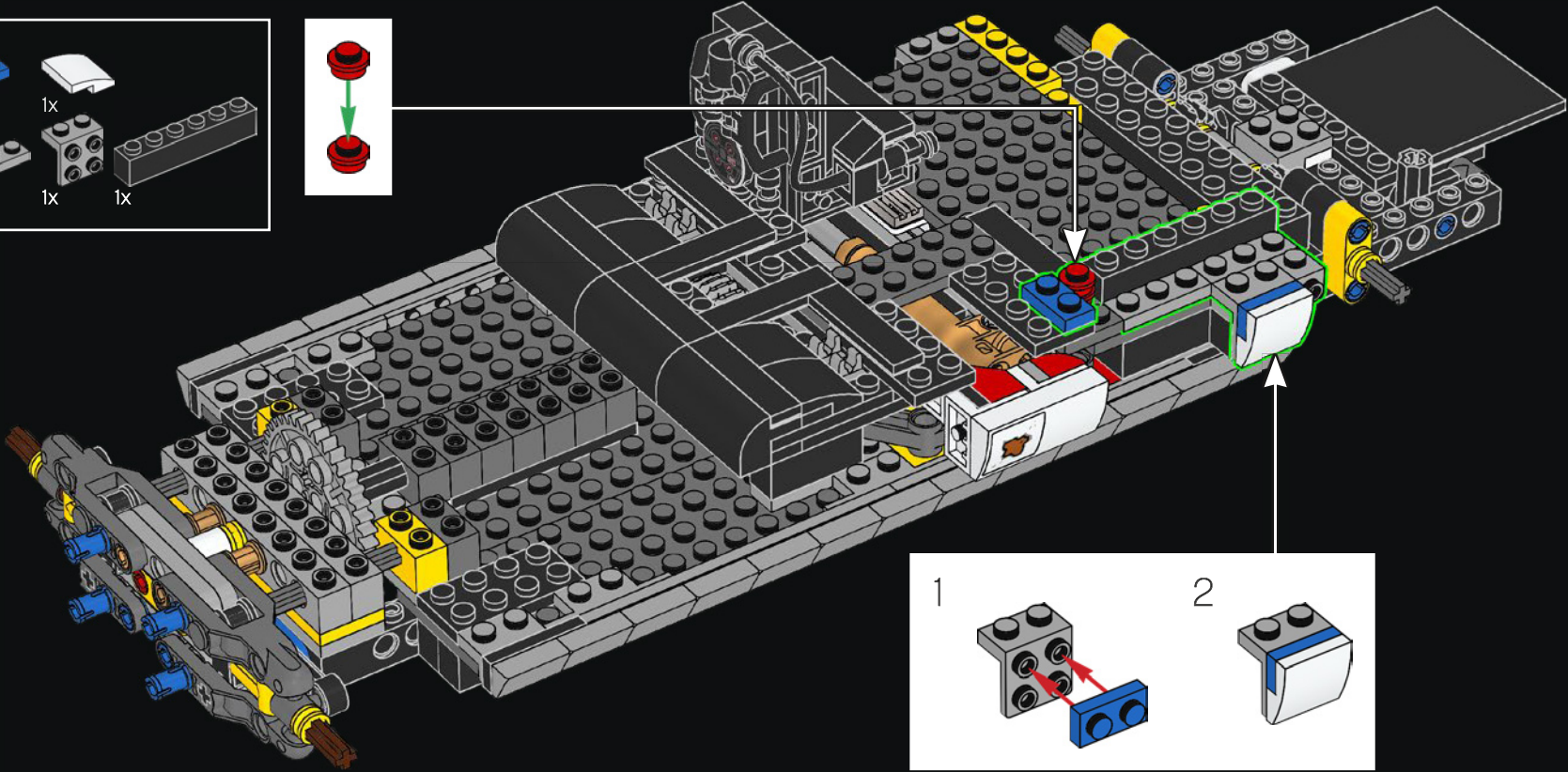

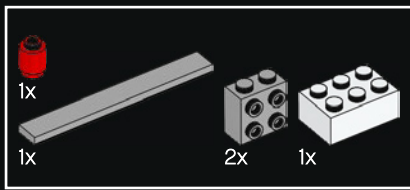

77

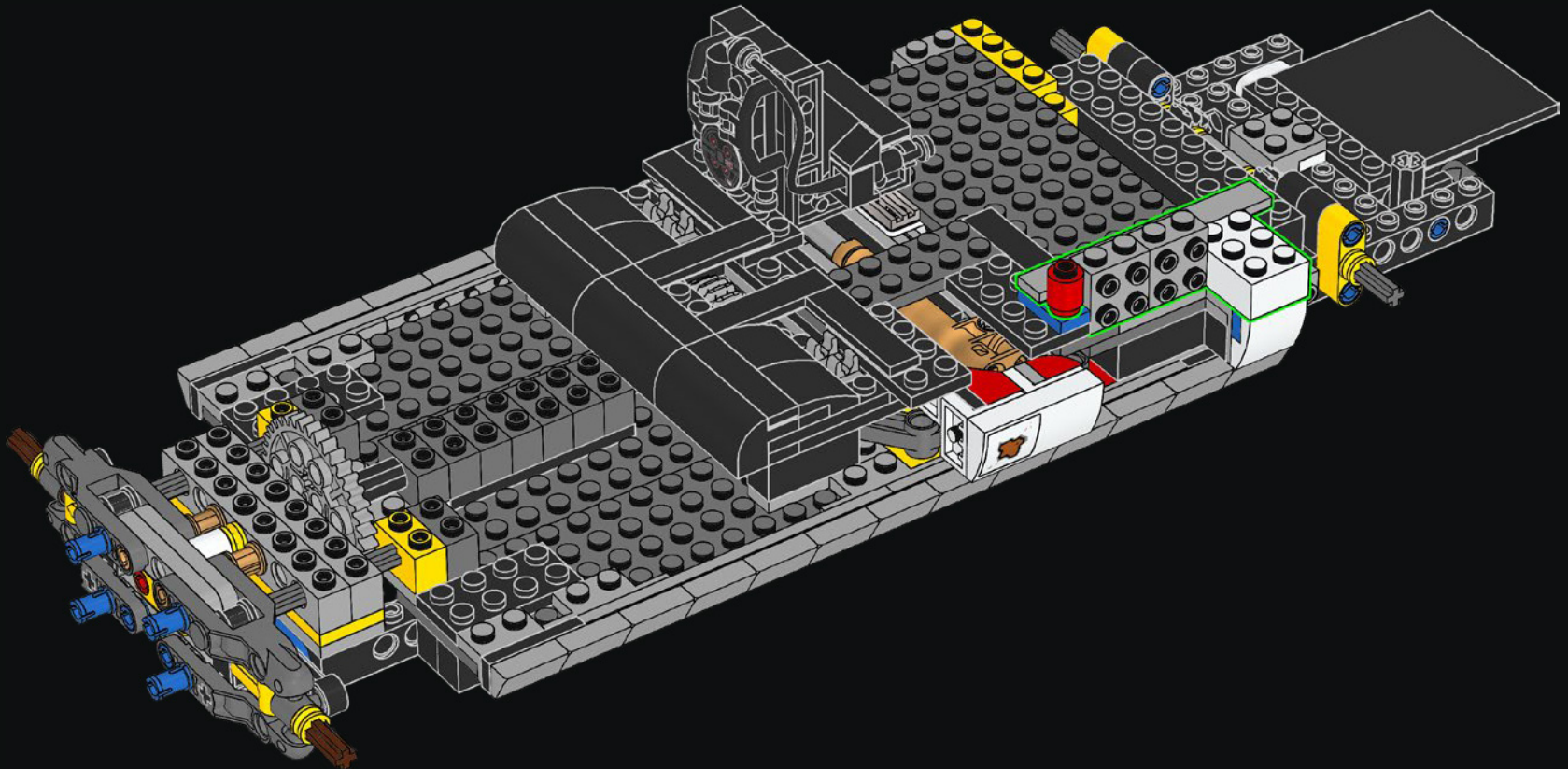

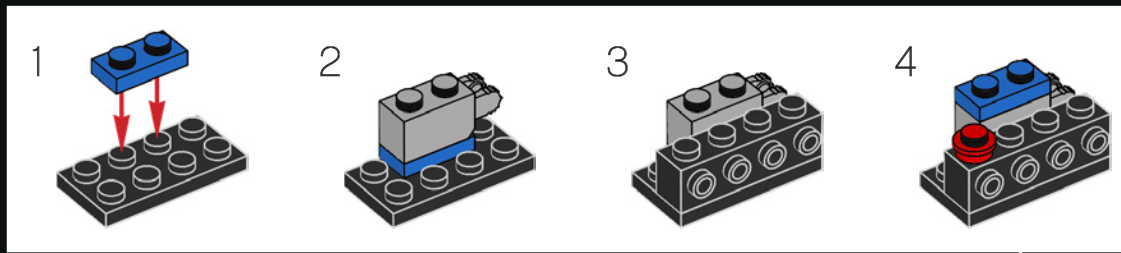
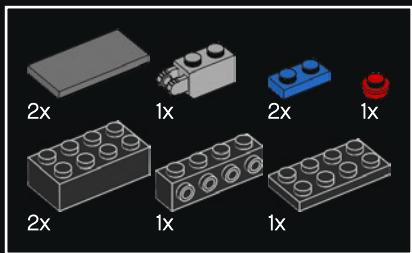

78

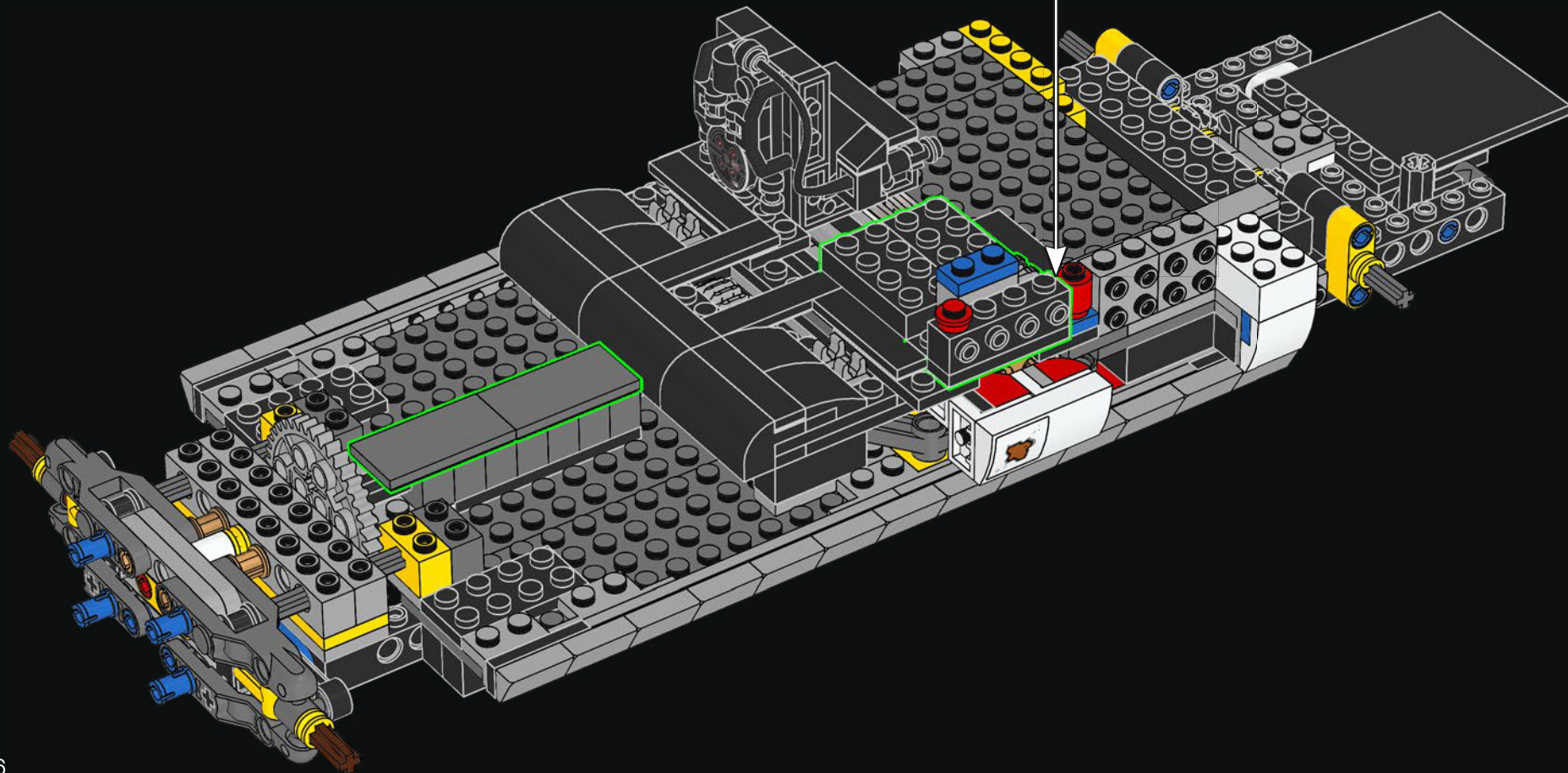

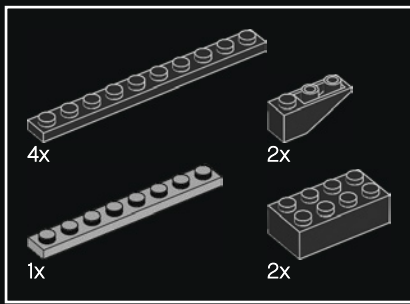

79

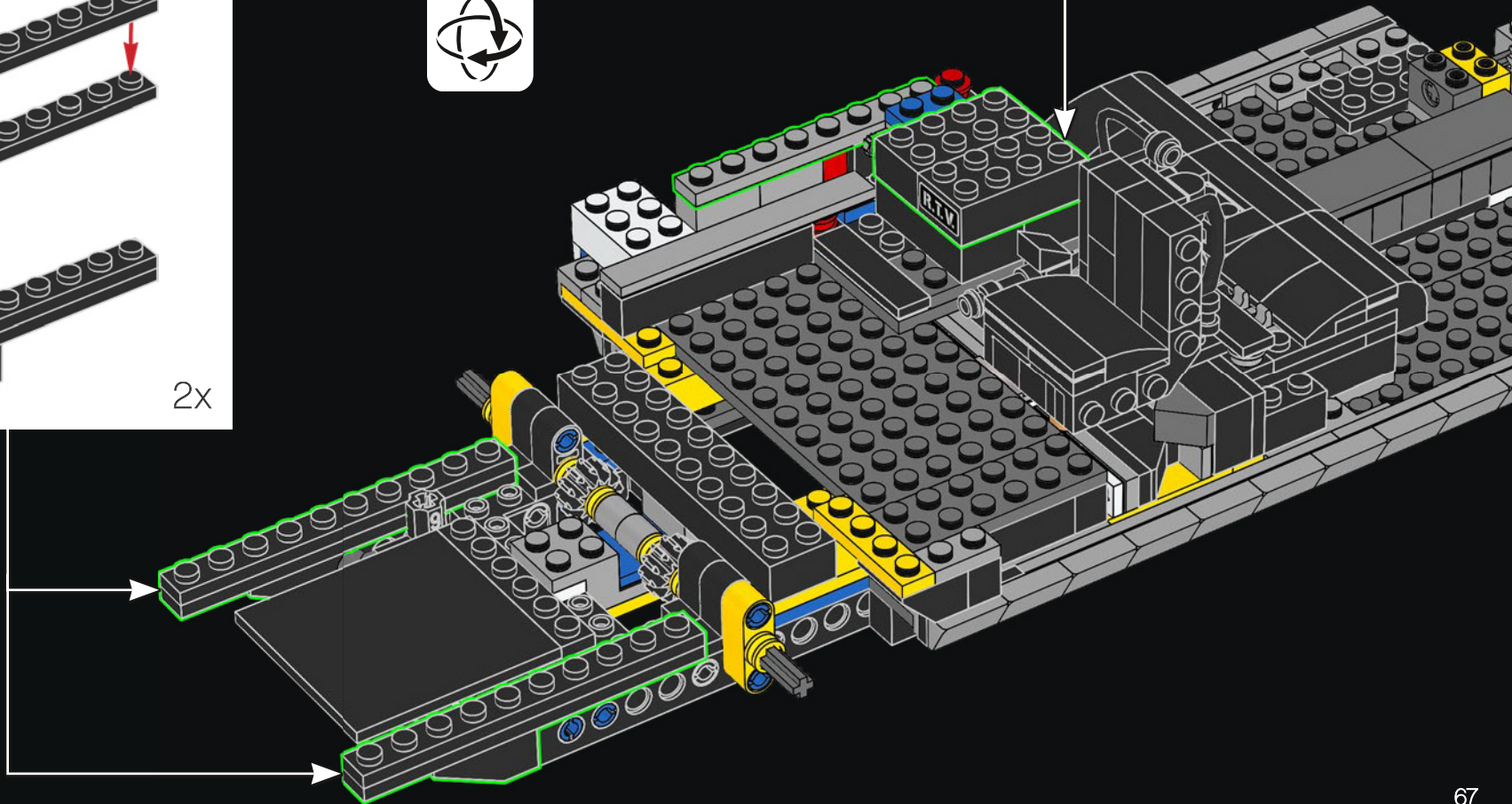
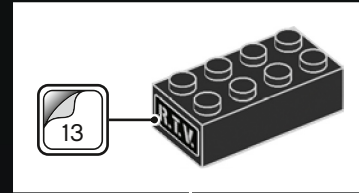
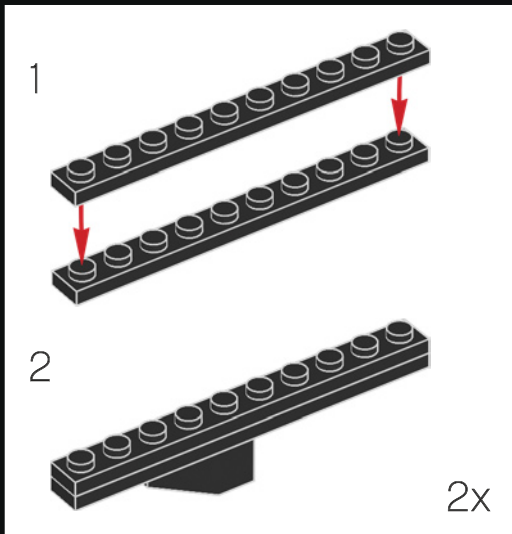

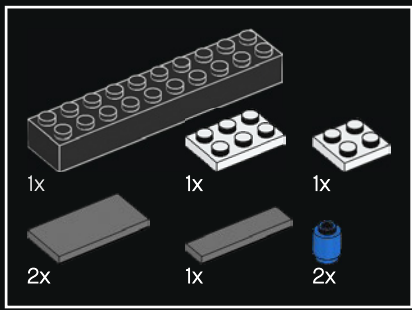

80

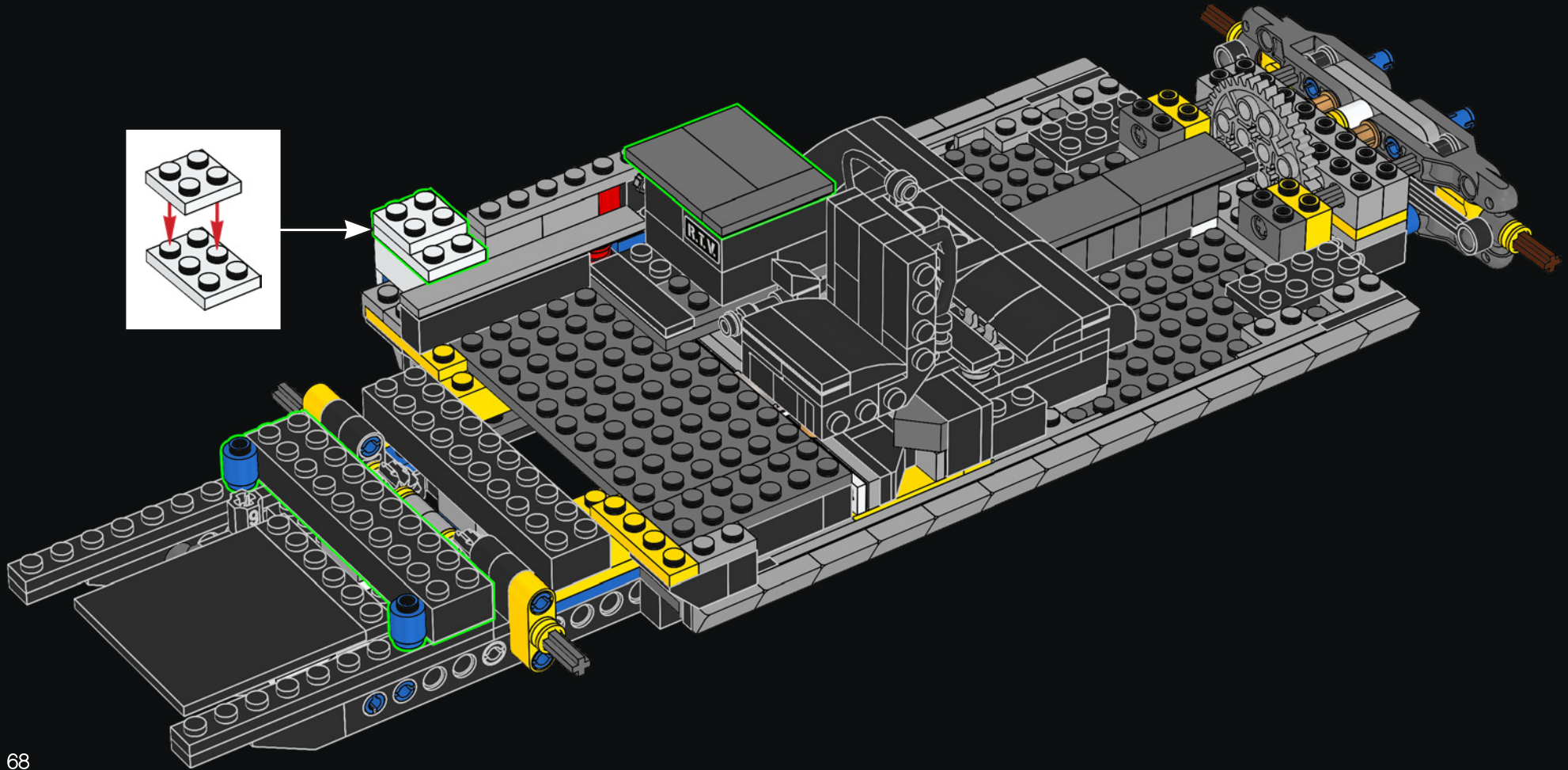

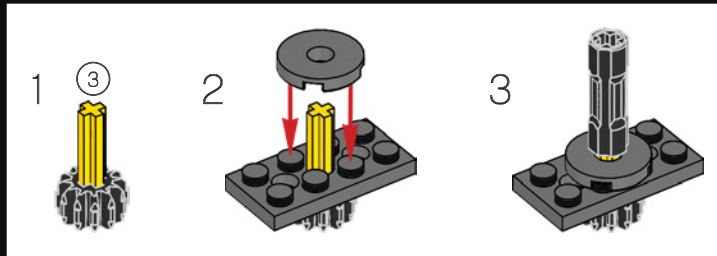
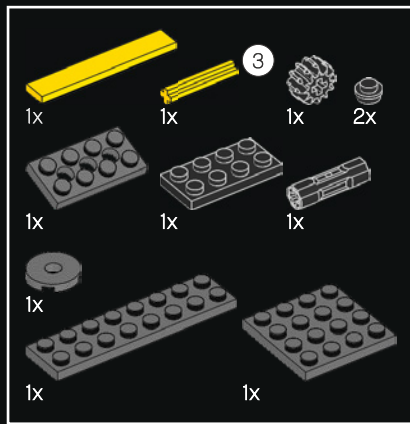

81

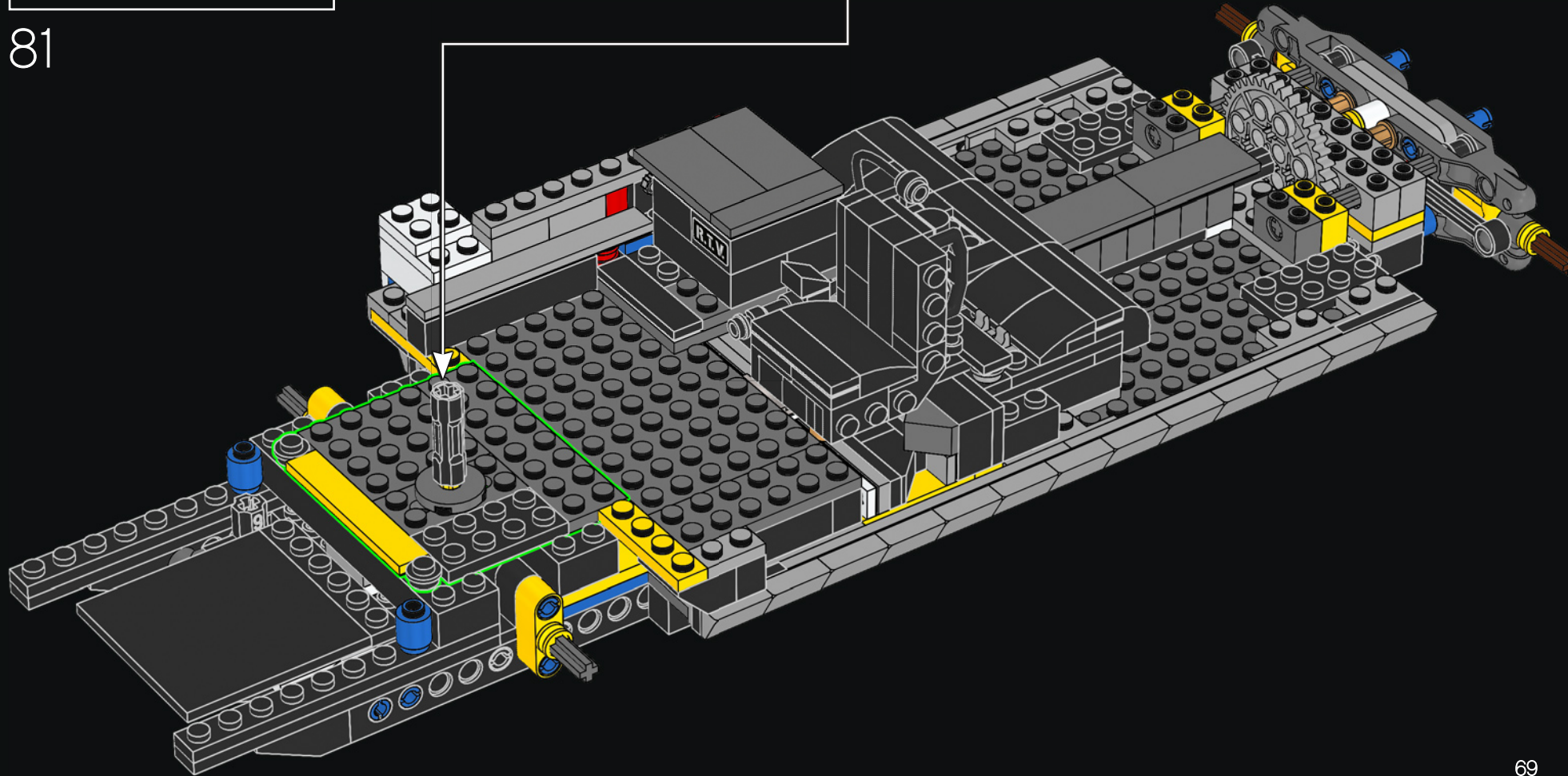

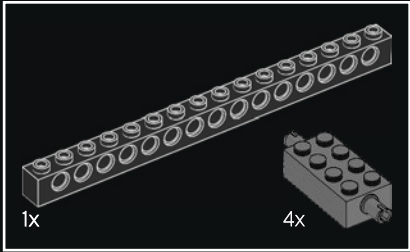
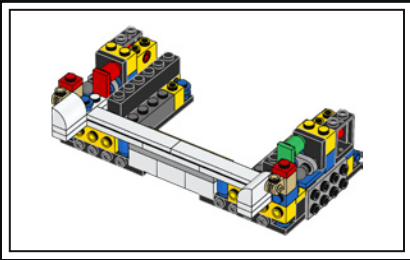

82

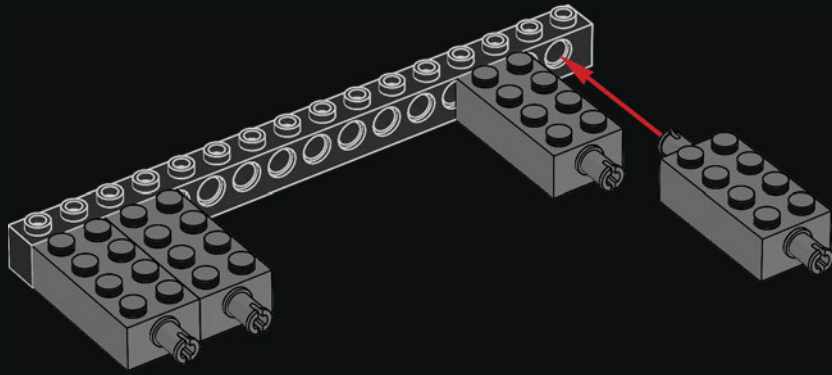

83

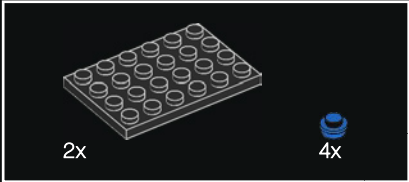
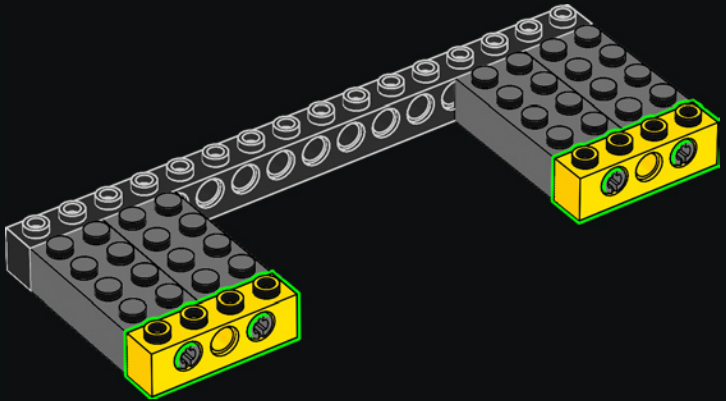

84

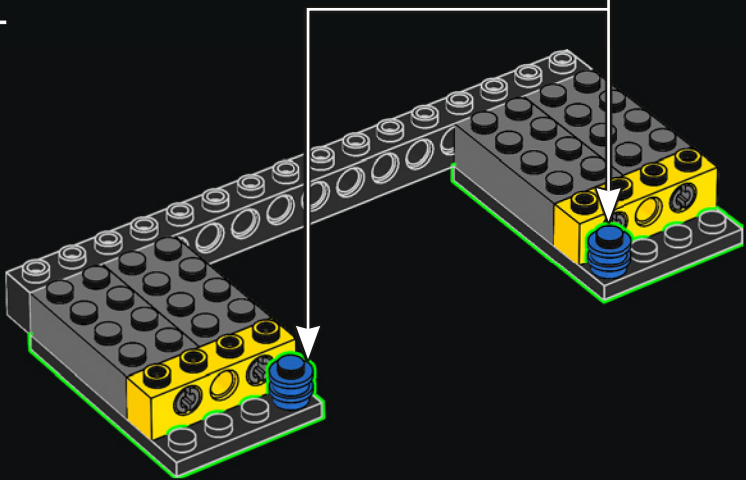
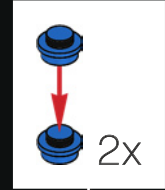



85

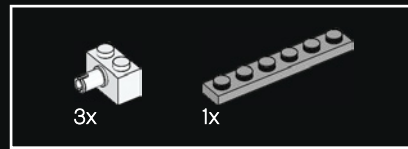
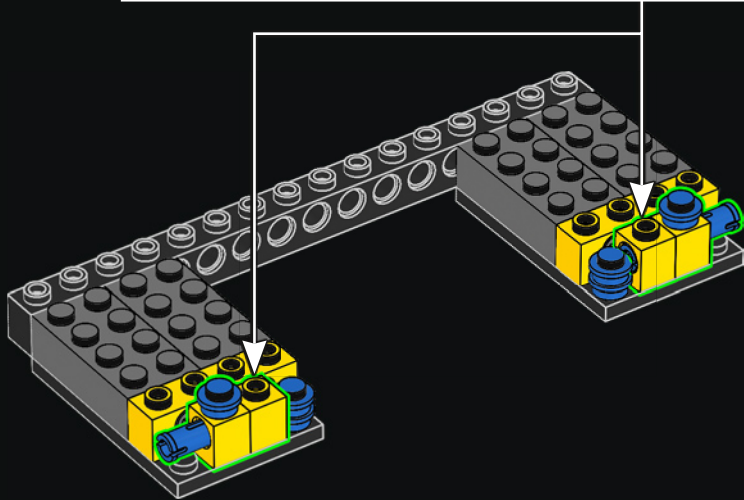
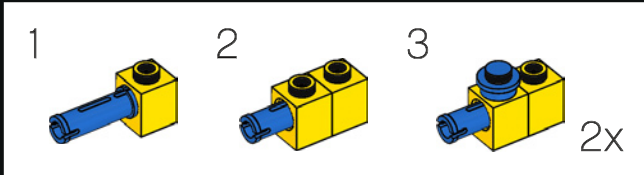

86

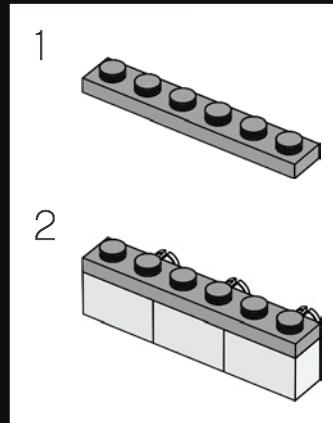
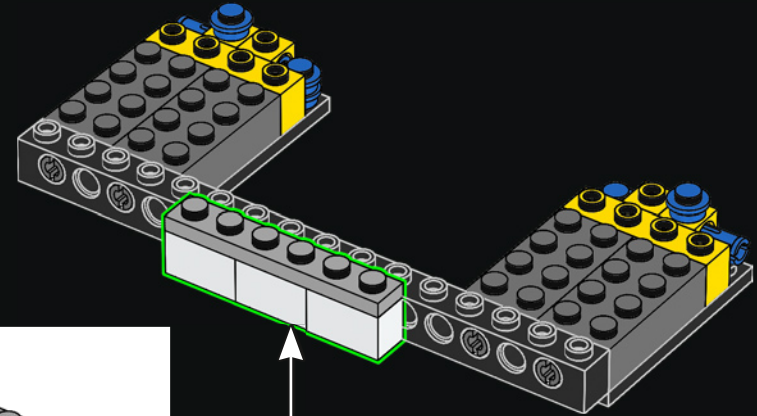

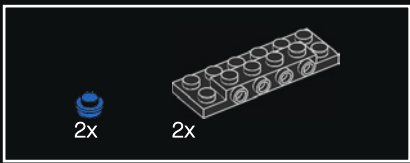

87

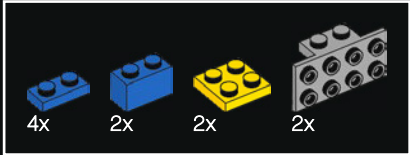
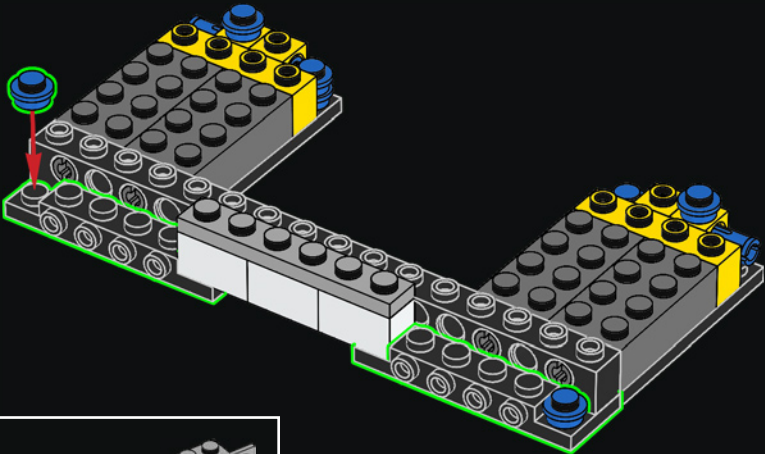

88

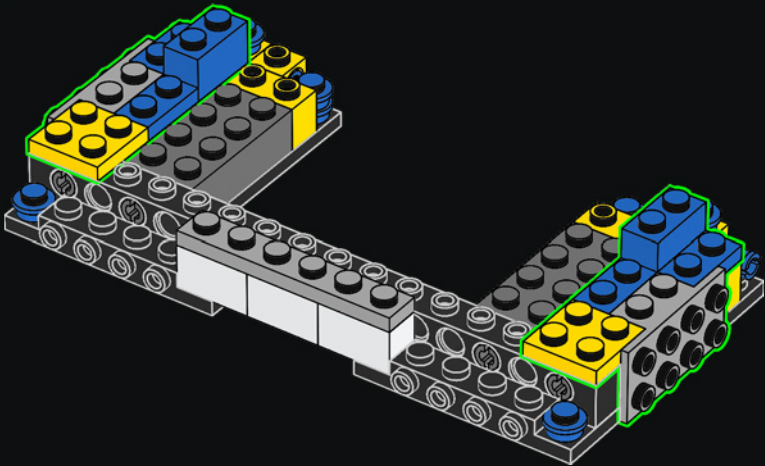

89

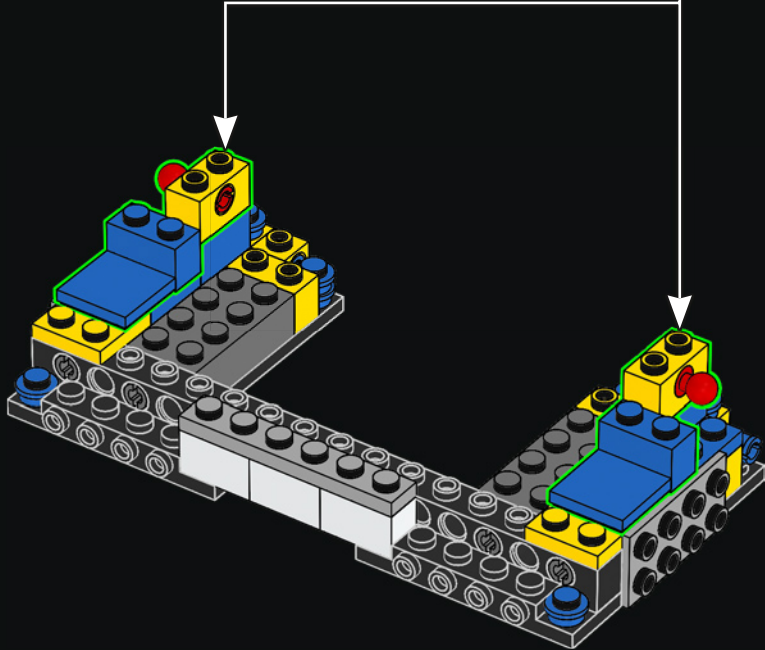
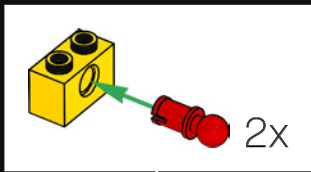

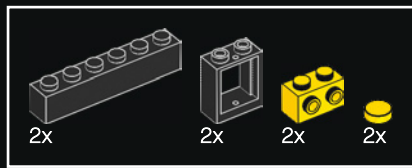

90

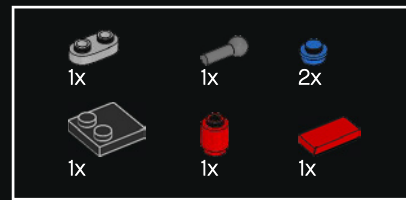
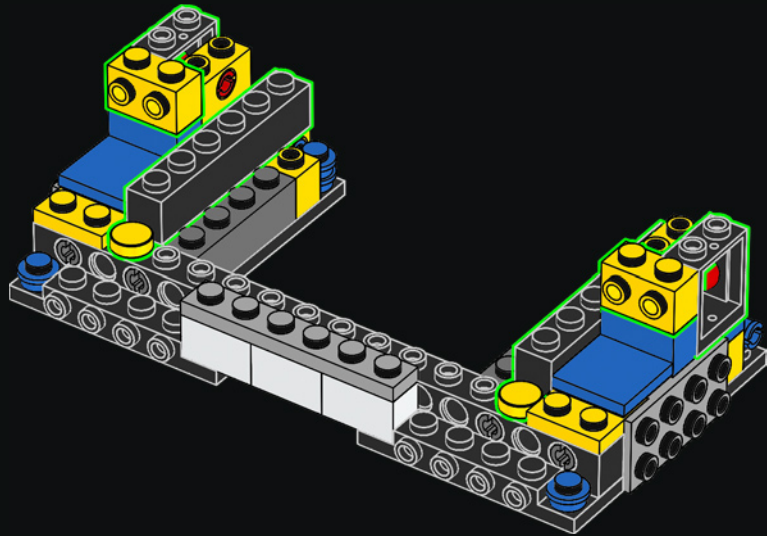

91

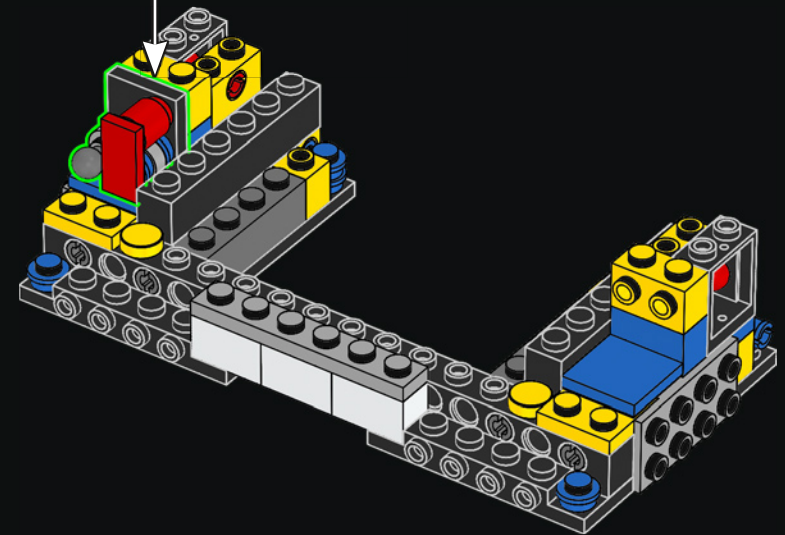
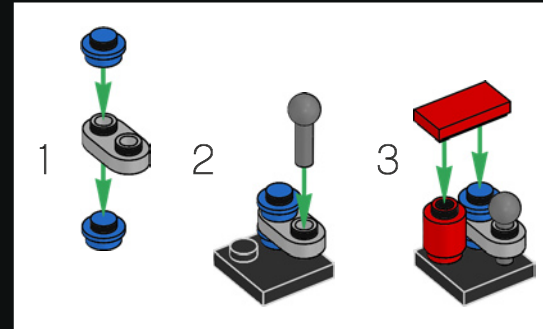

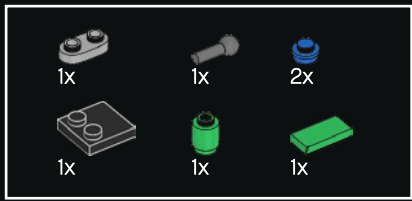

92

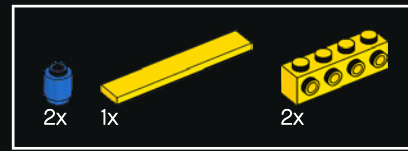
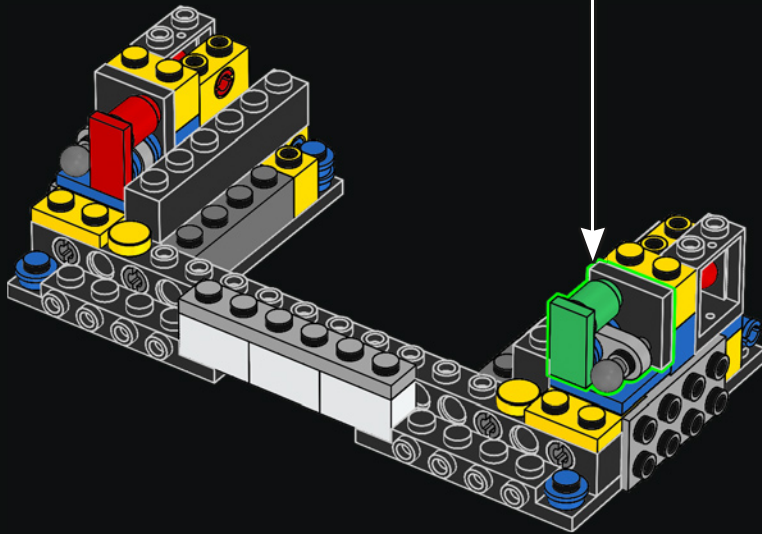
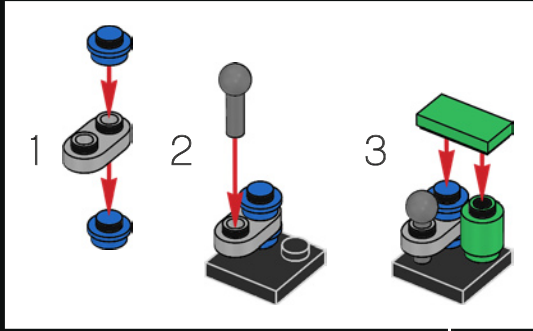

93

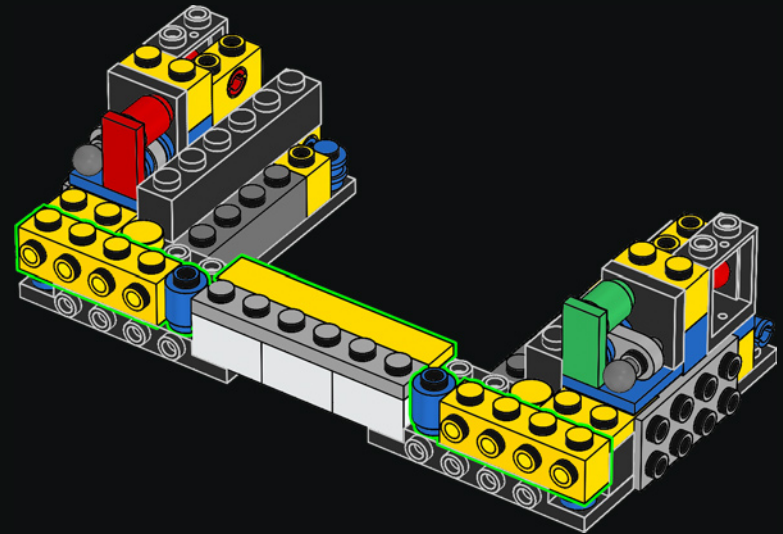

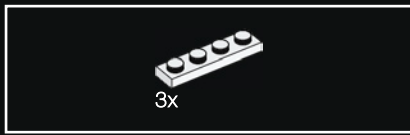

94

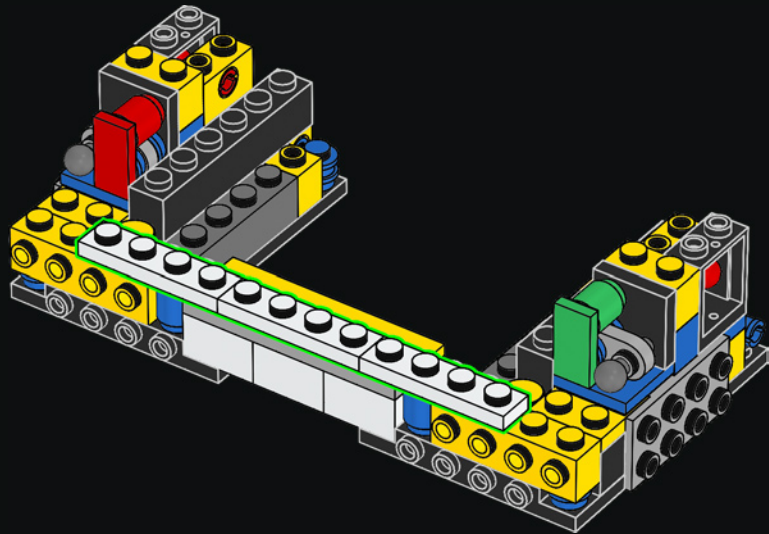

95

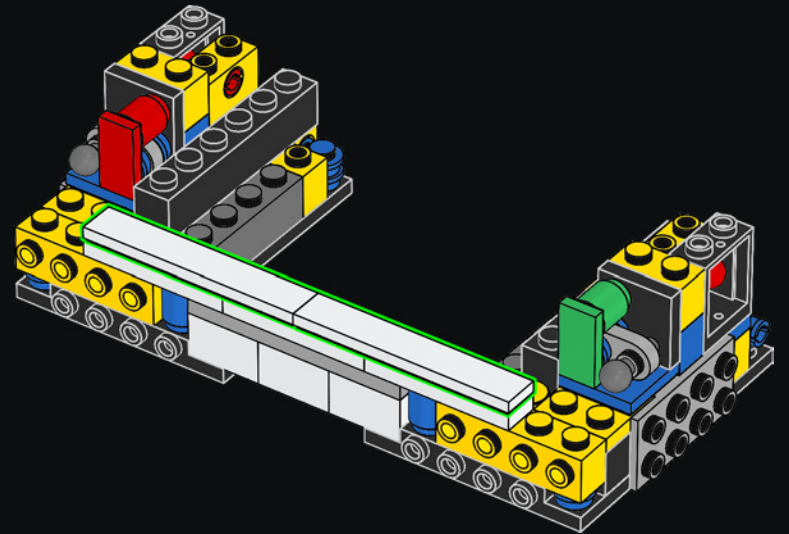

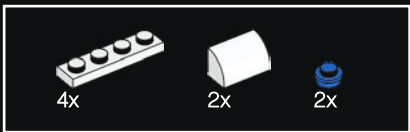

96

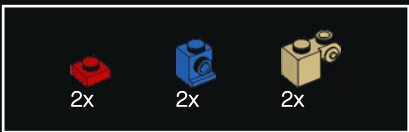
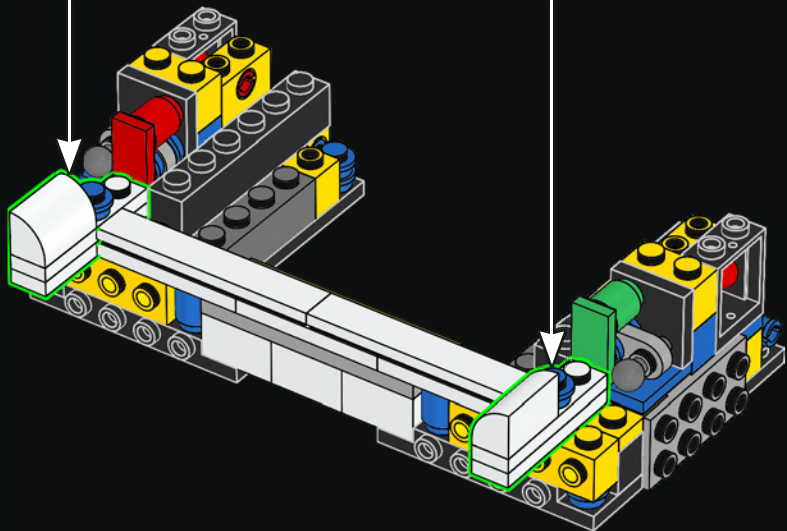
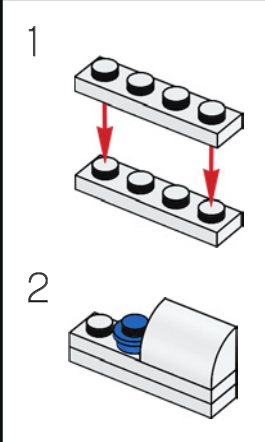
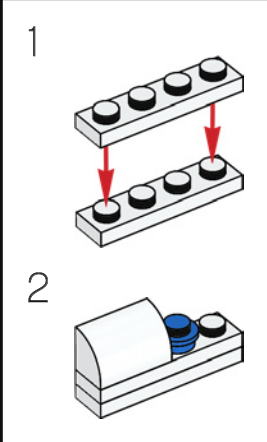

97

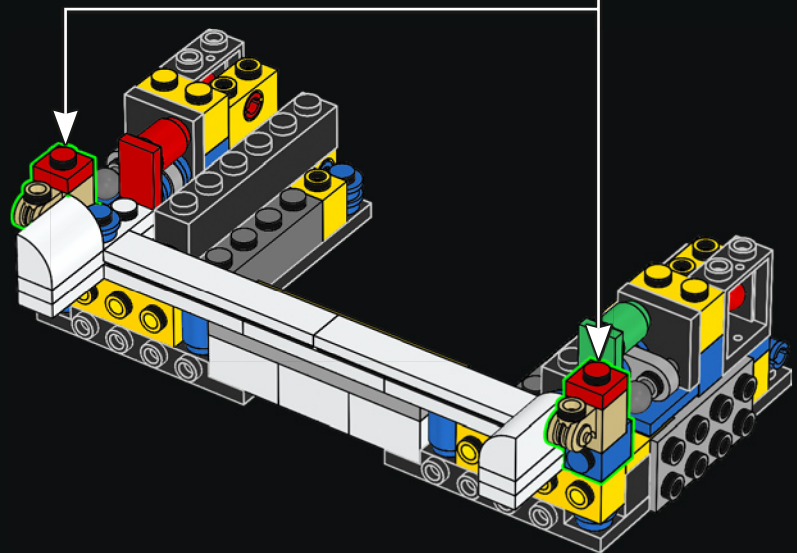
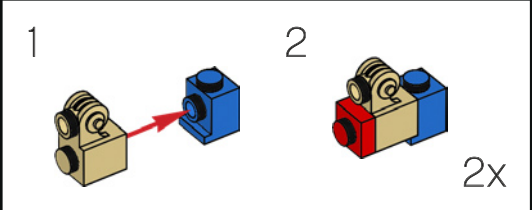

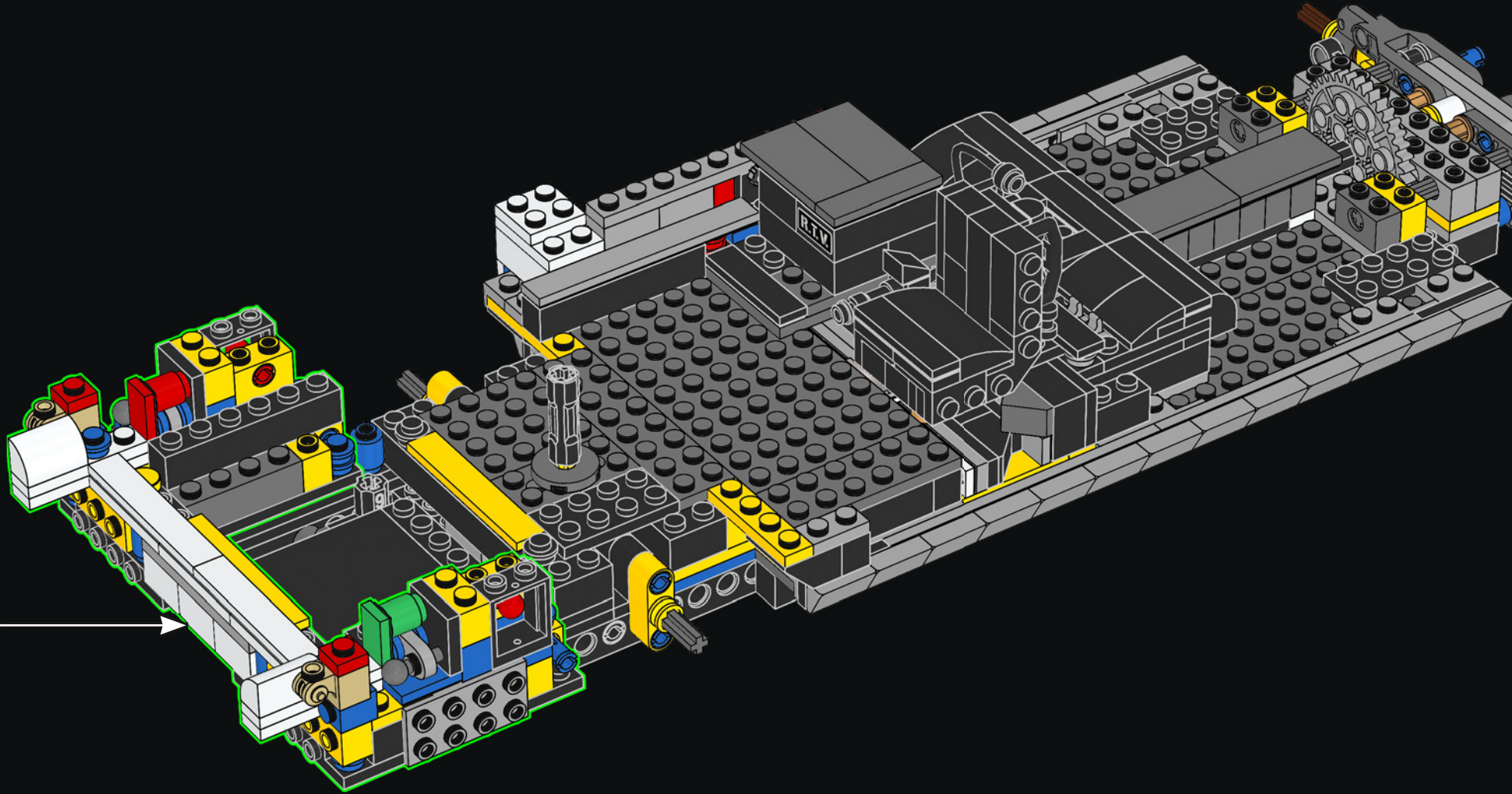

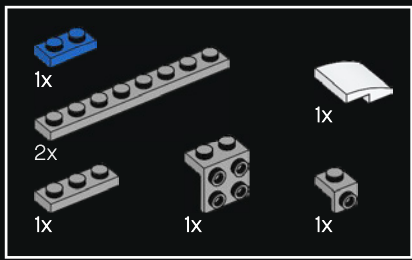

99

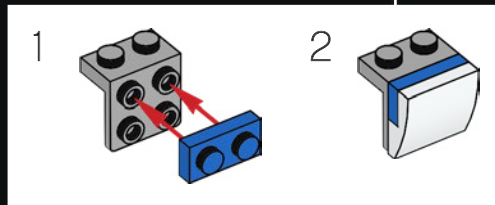
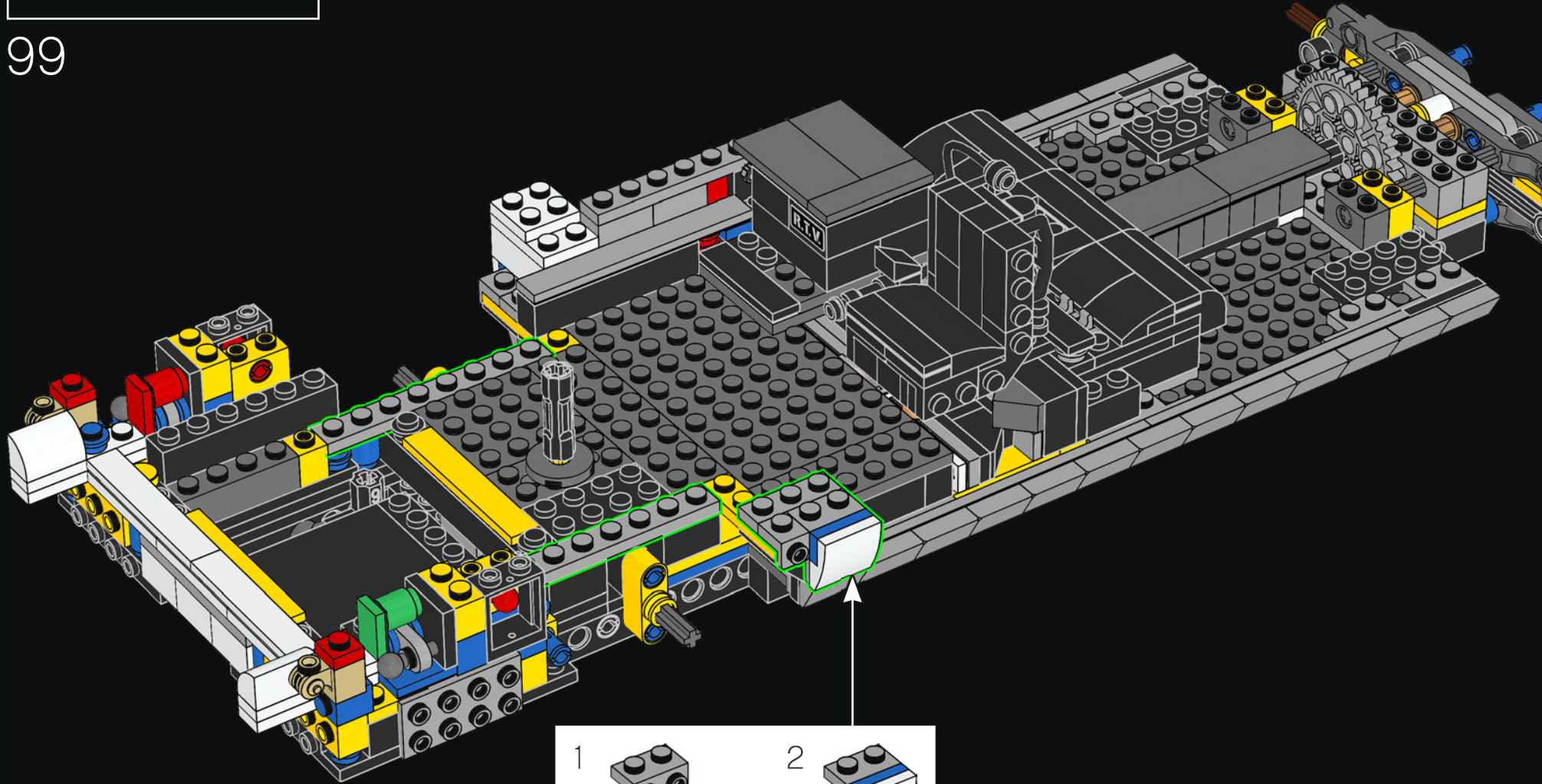

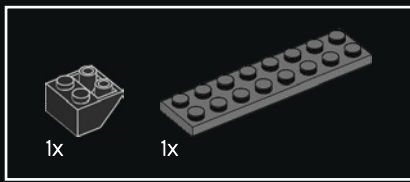

100

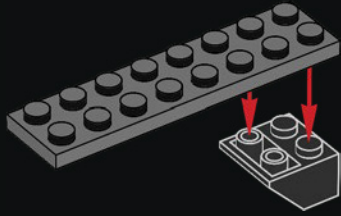

101

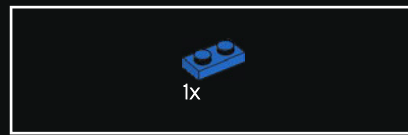
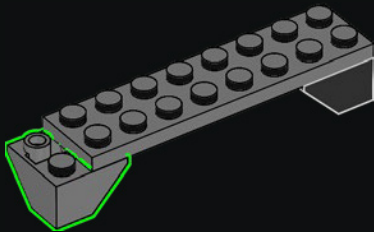

102

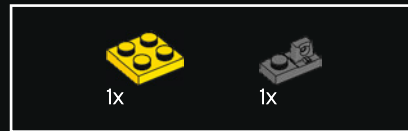
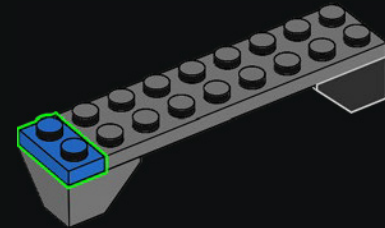

103

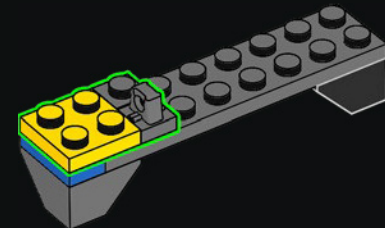

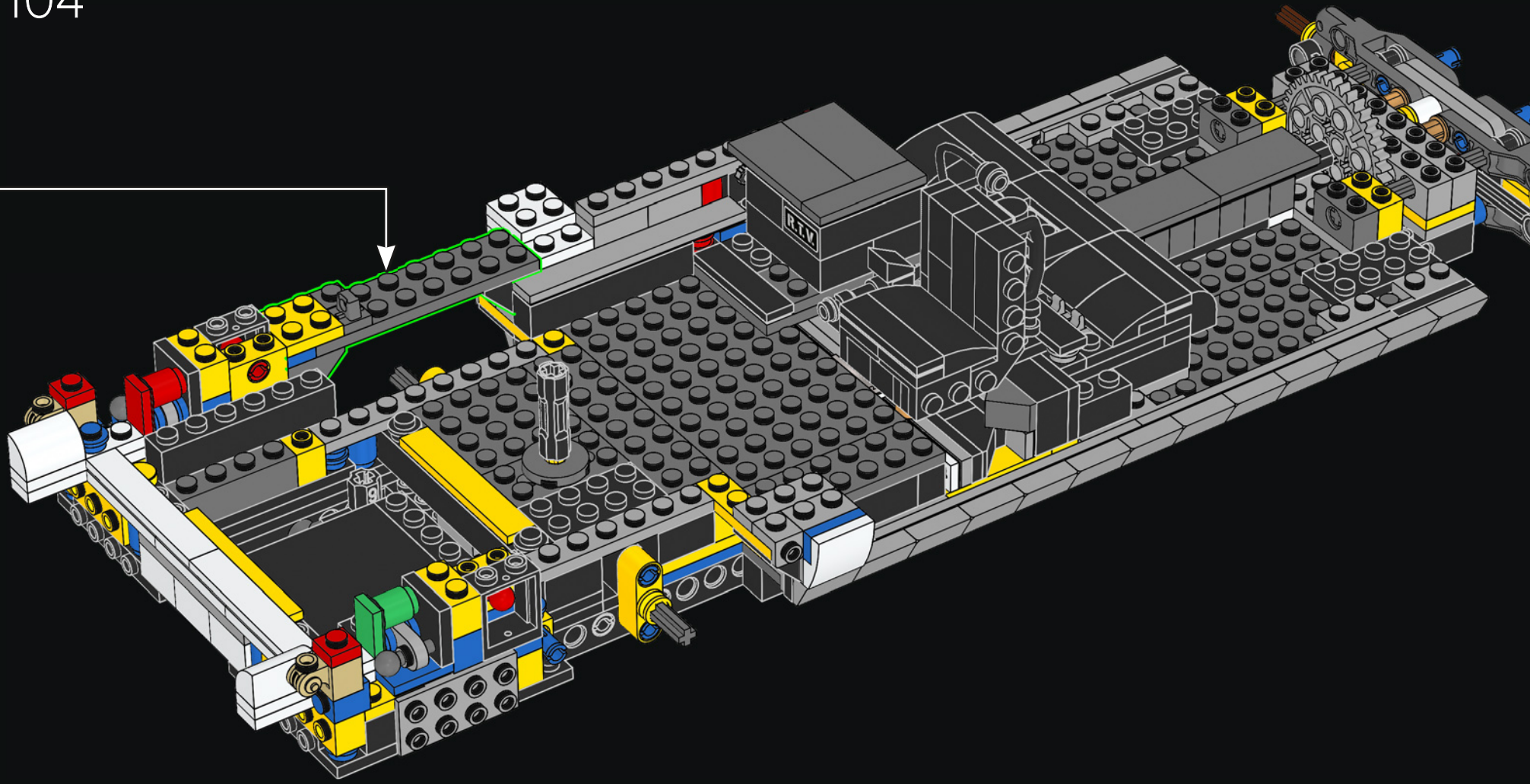

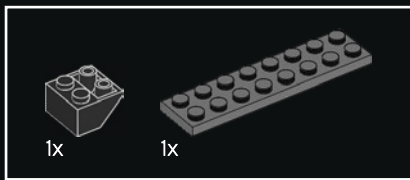

105

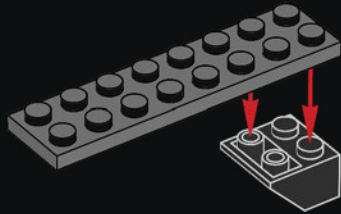

106

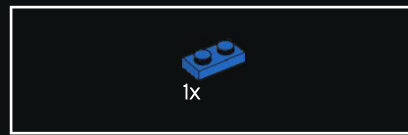
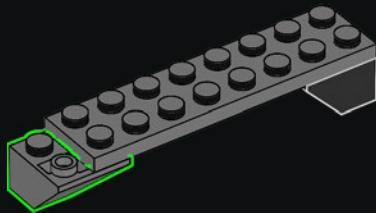

107

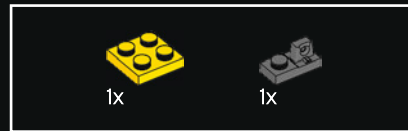
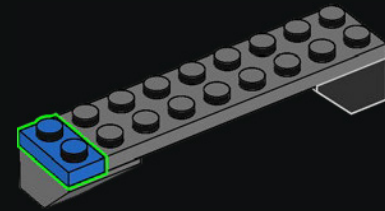

108

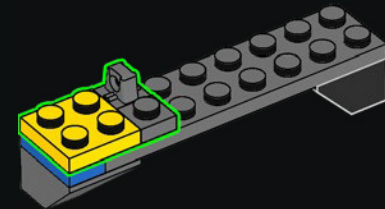

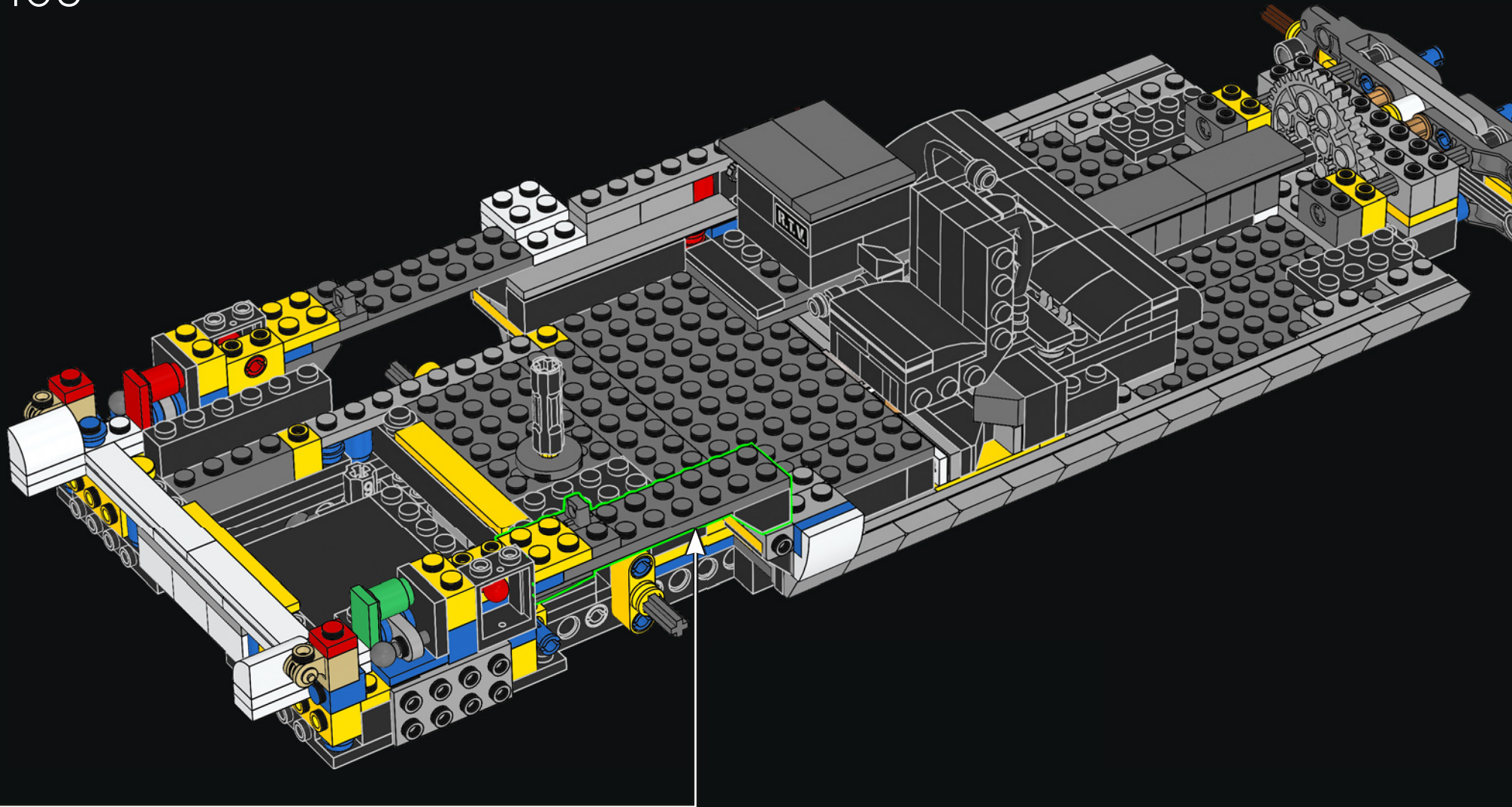

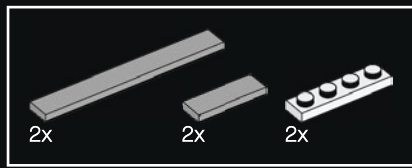

110

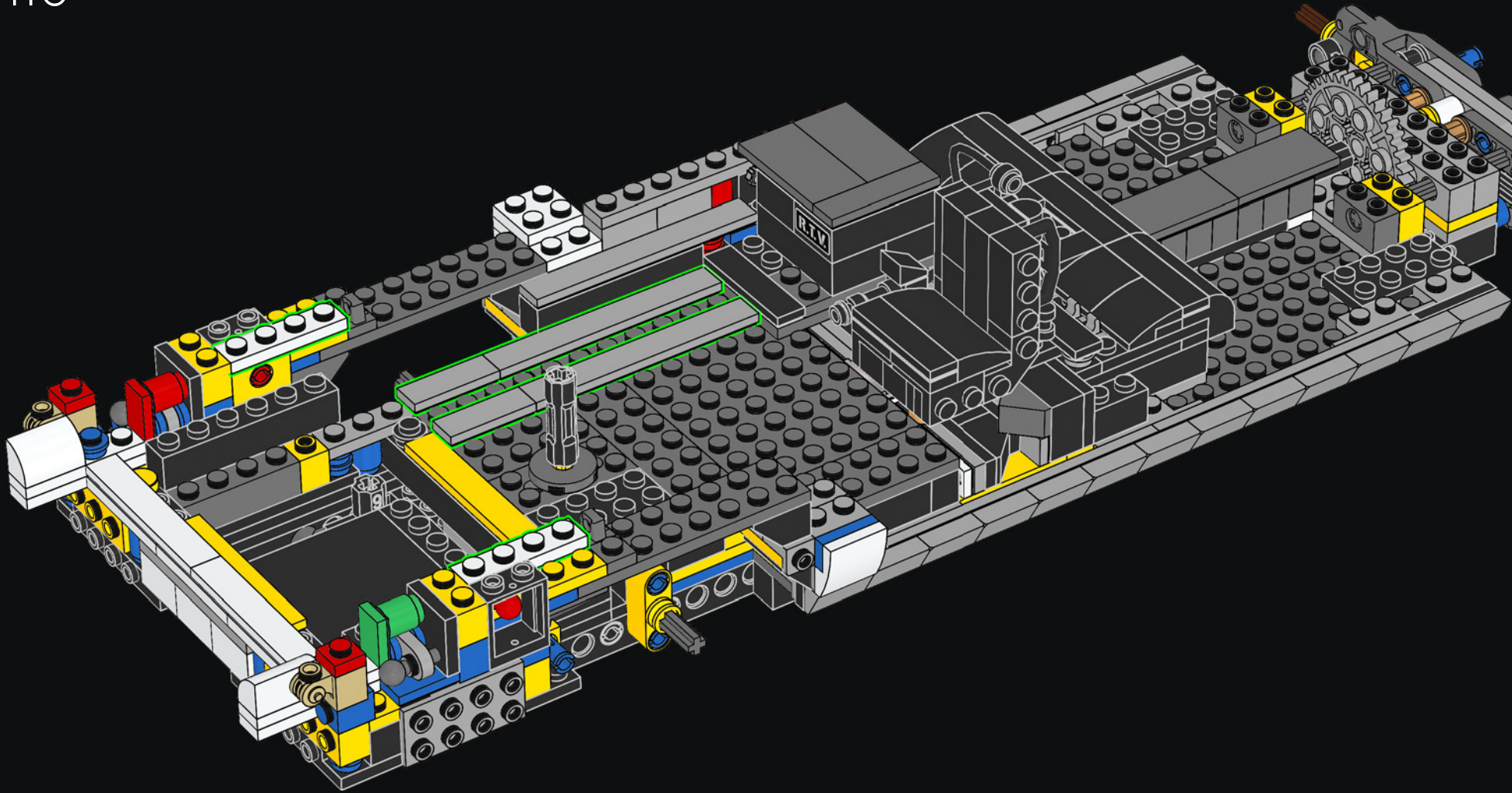

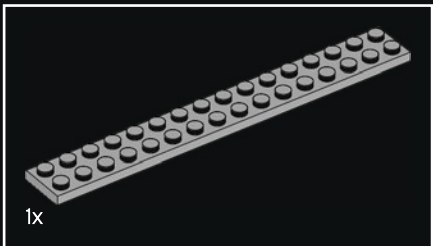
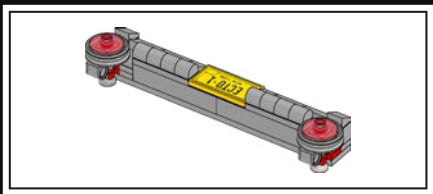

1x

111

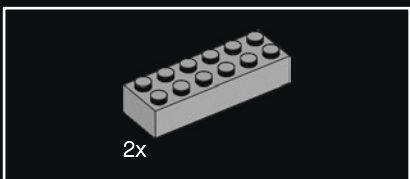
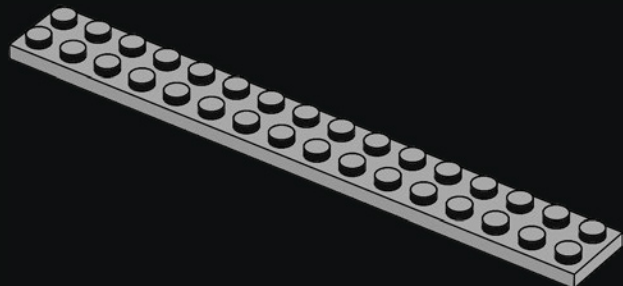

2x

112

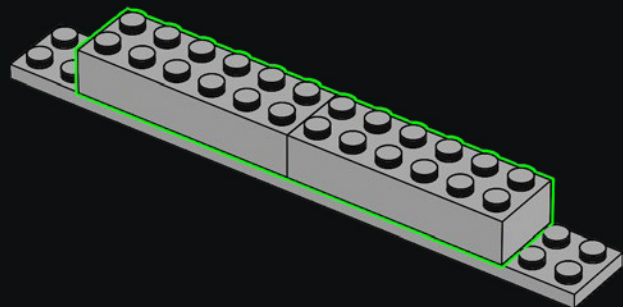

2x

113

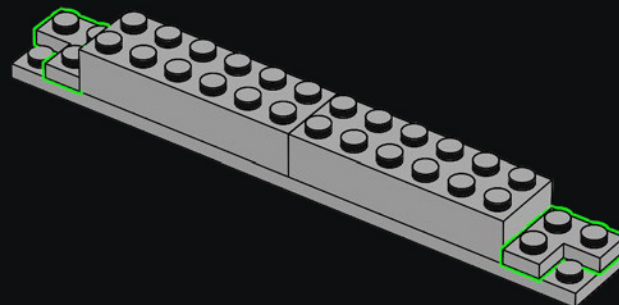

2x

2x

114

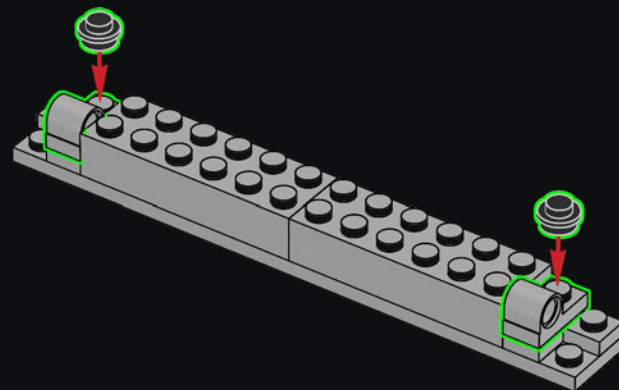



115

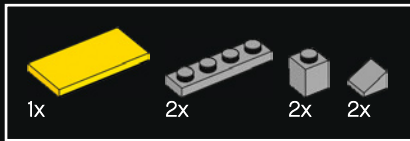
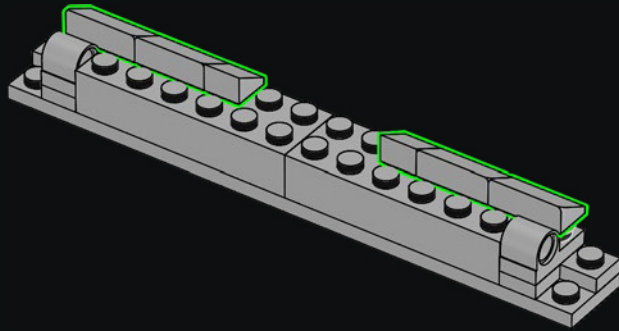

116

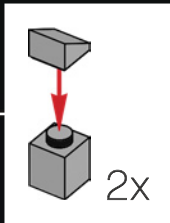
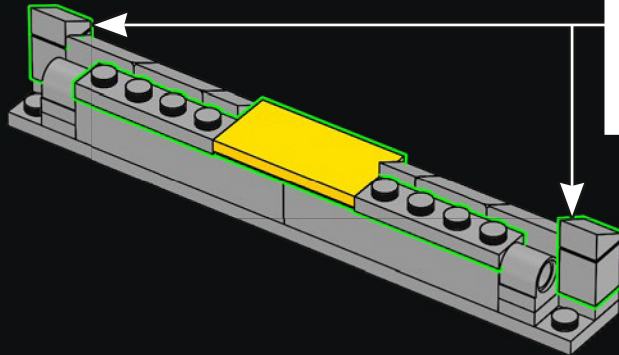

117

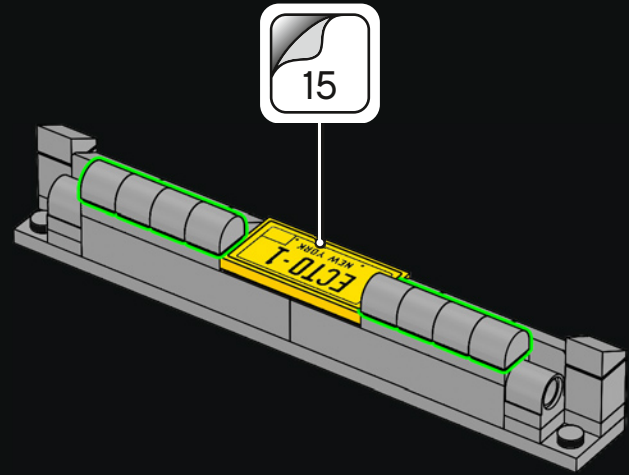

118

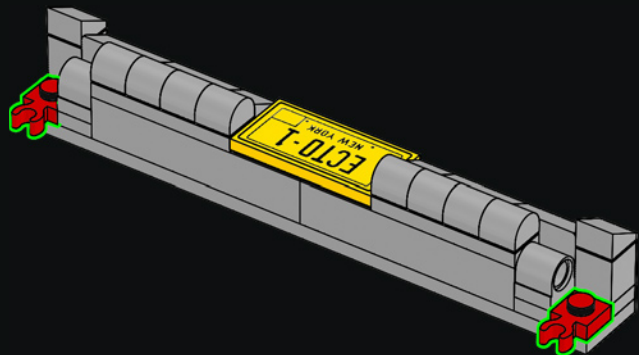

2x

119

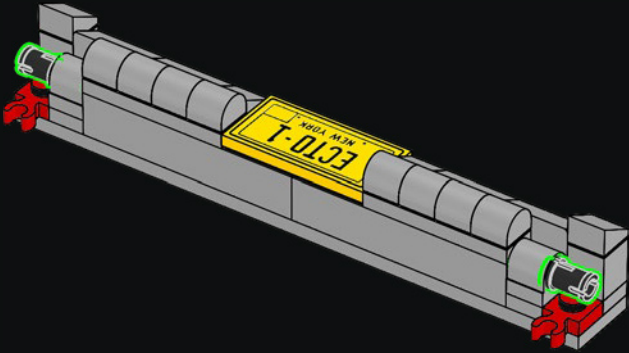

2x

120

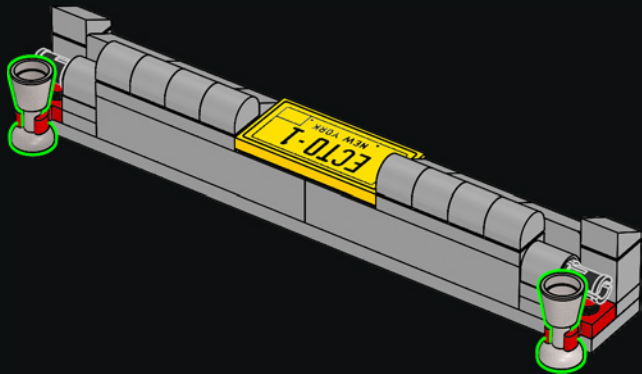

2x

121

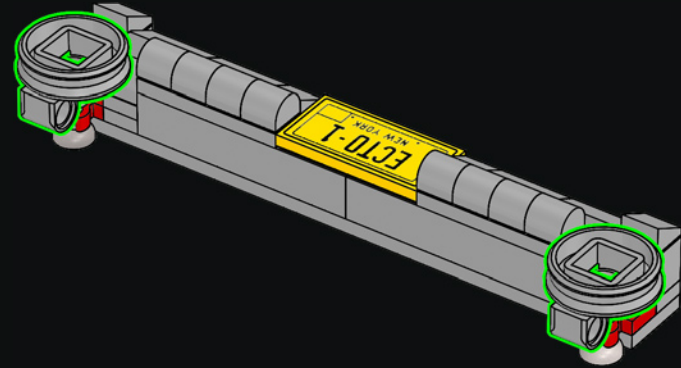

2x

2x

2x

122

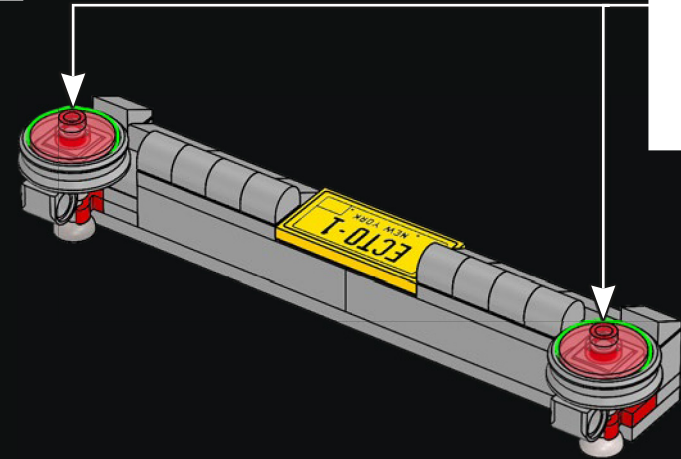

2x

123

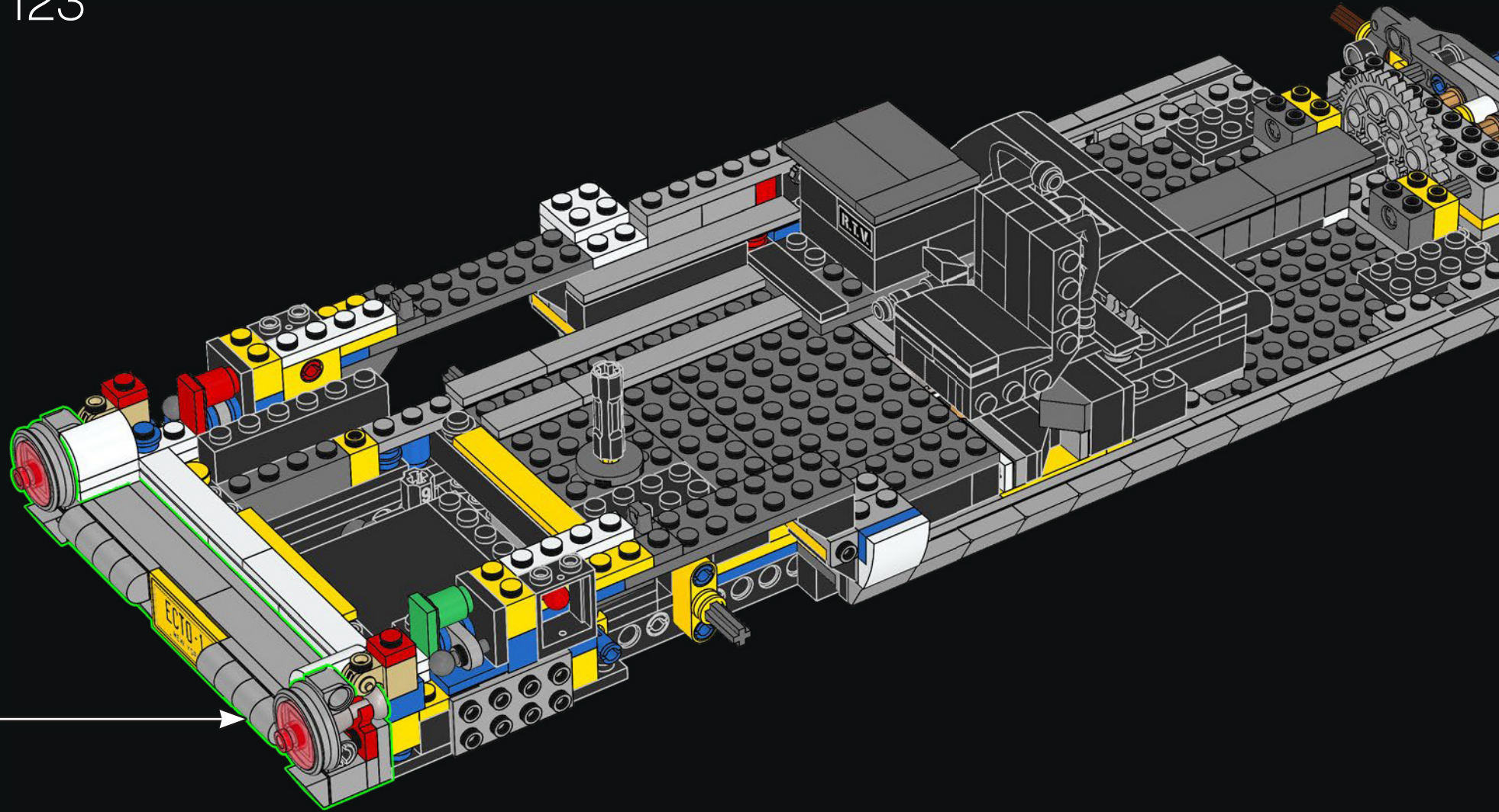

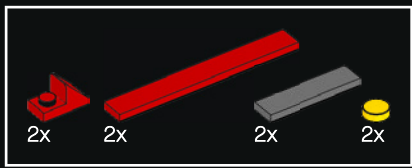

124

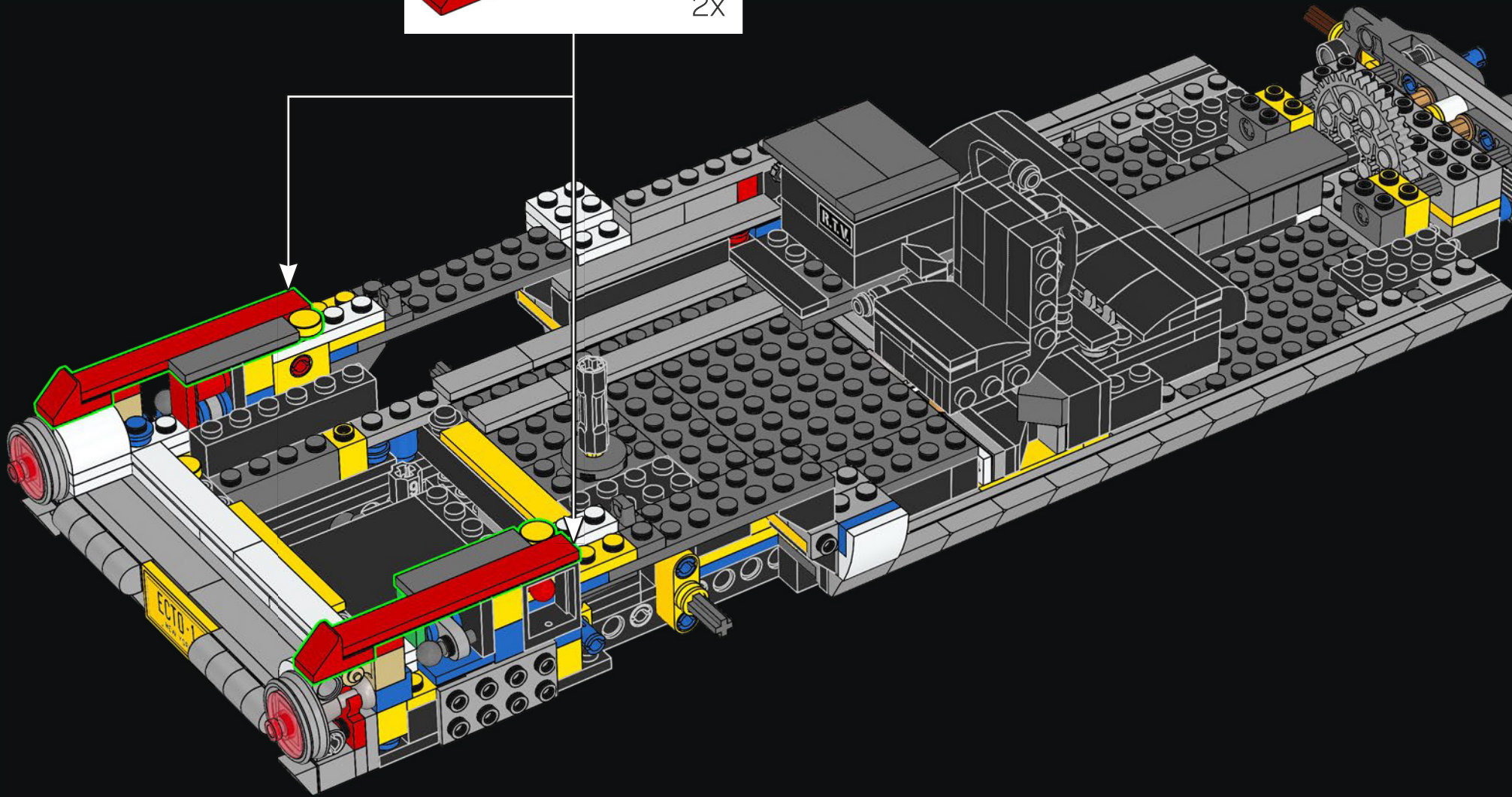
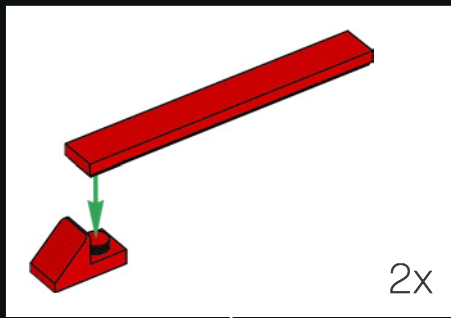

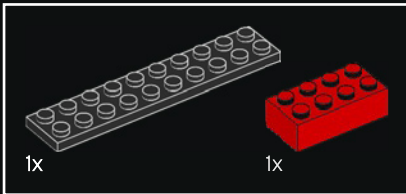
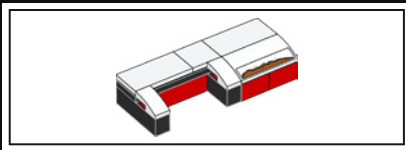
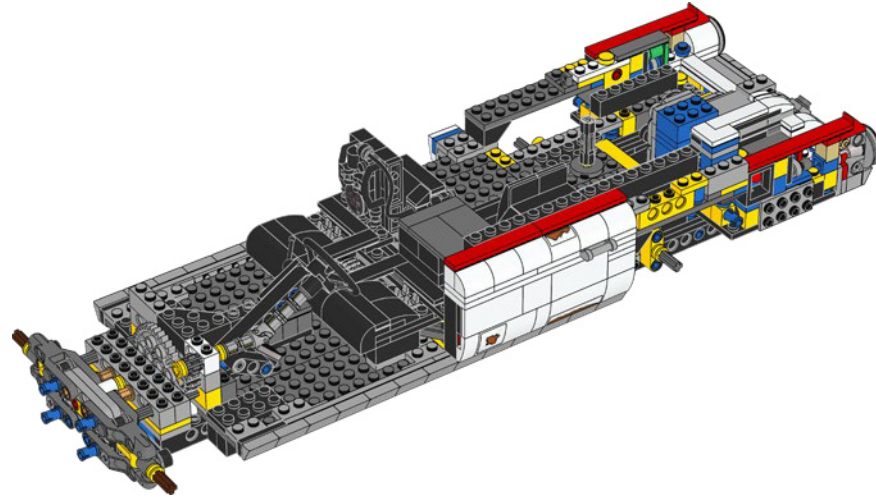

125

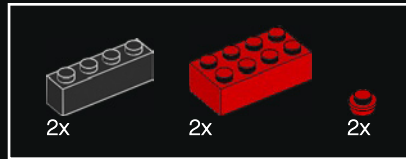
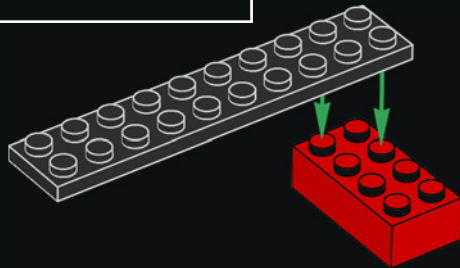

126

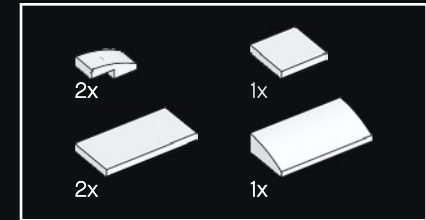
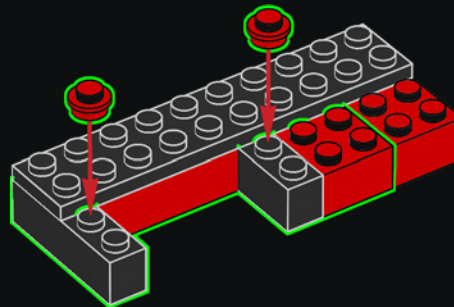

127

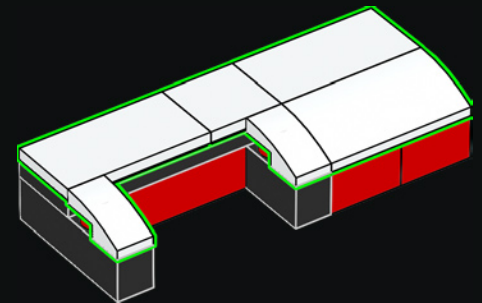

128

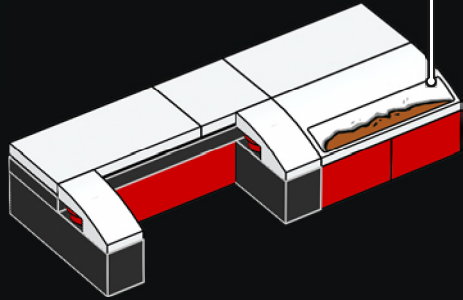

129

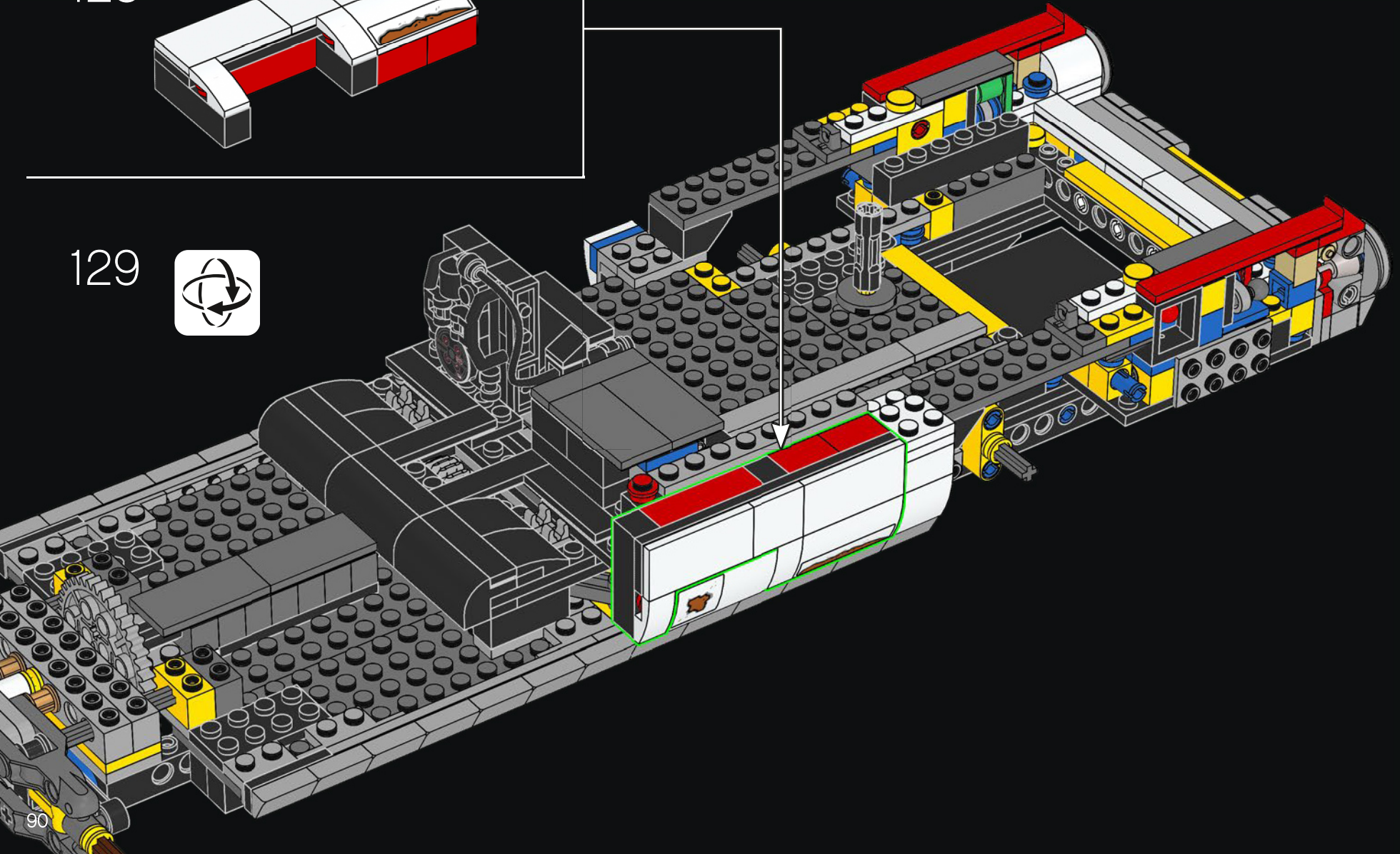

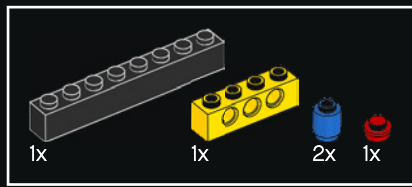

130

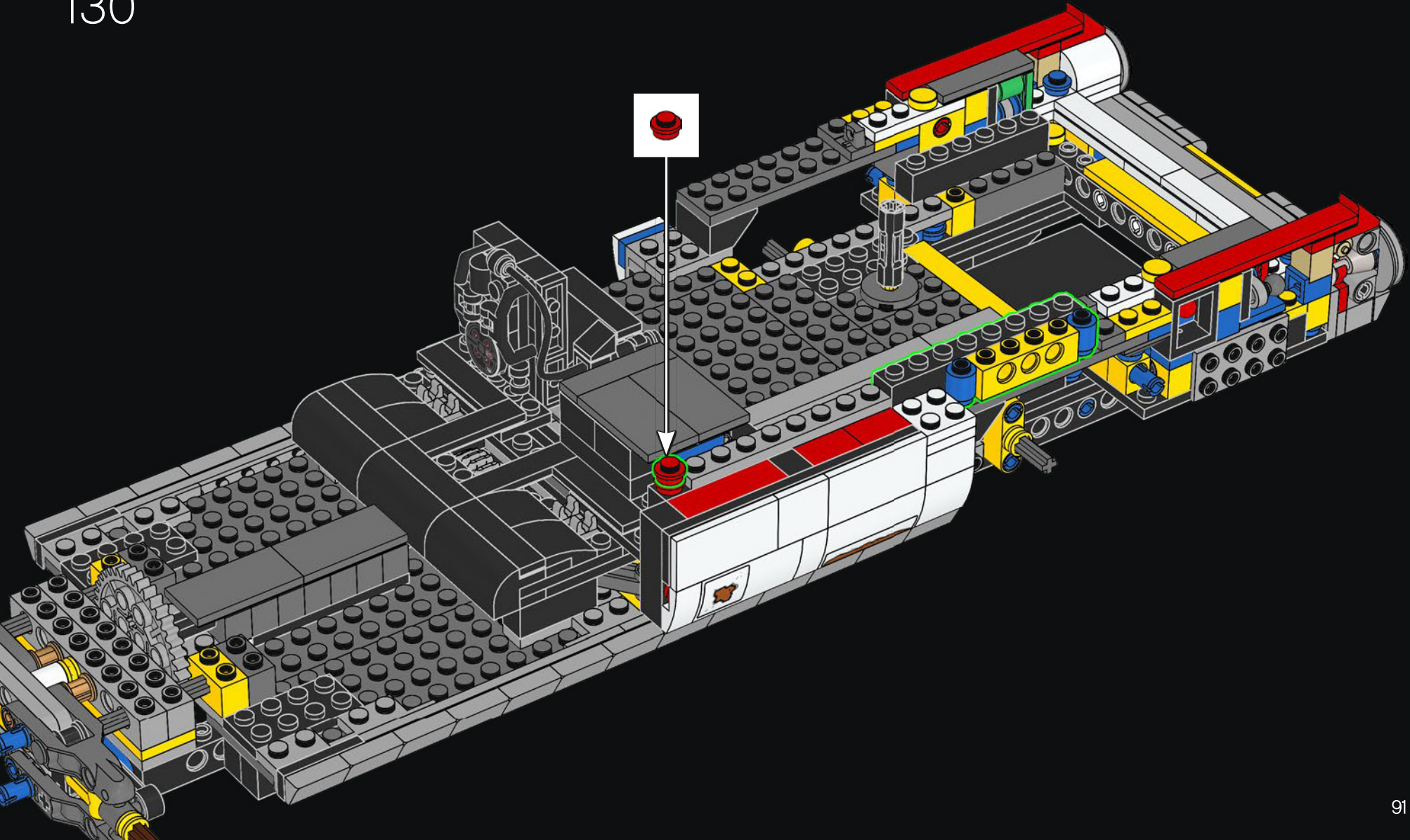

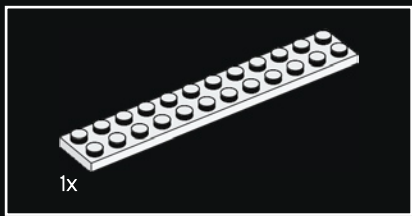

131

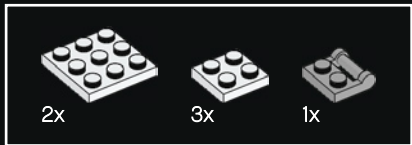
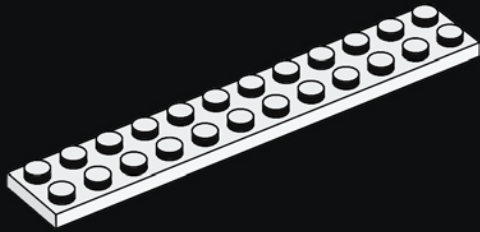

132

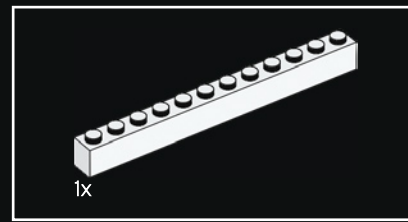
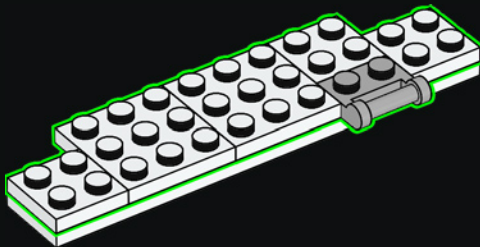

133

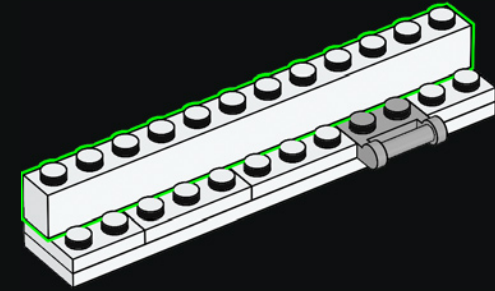

134

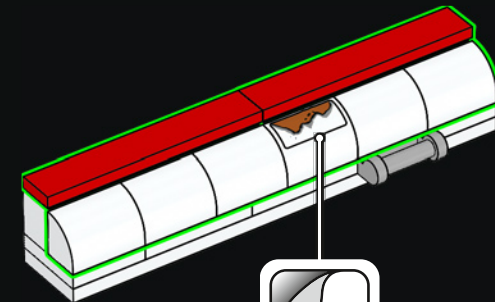

4

135

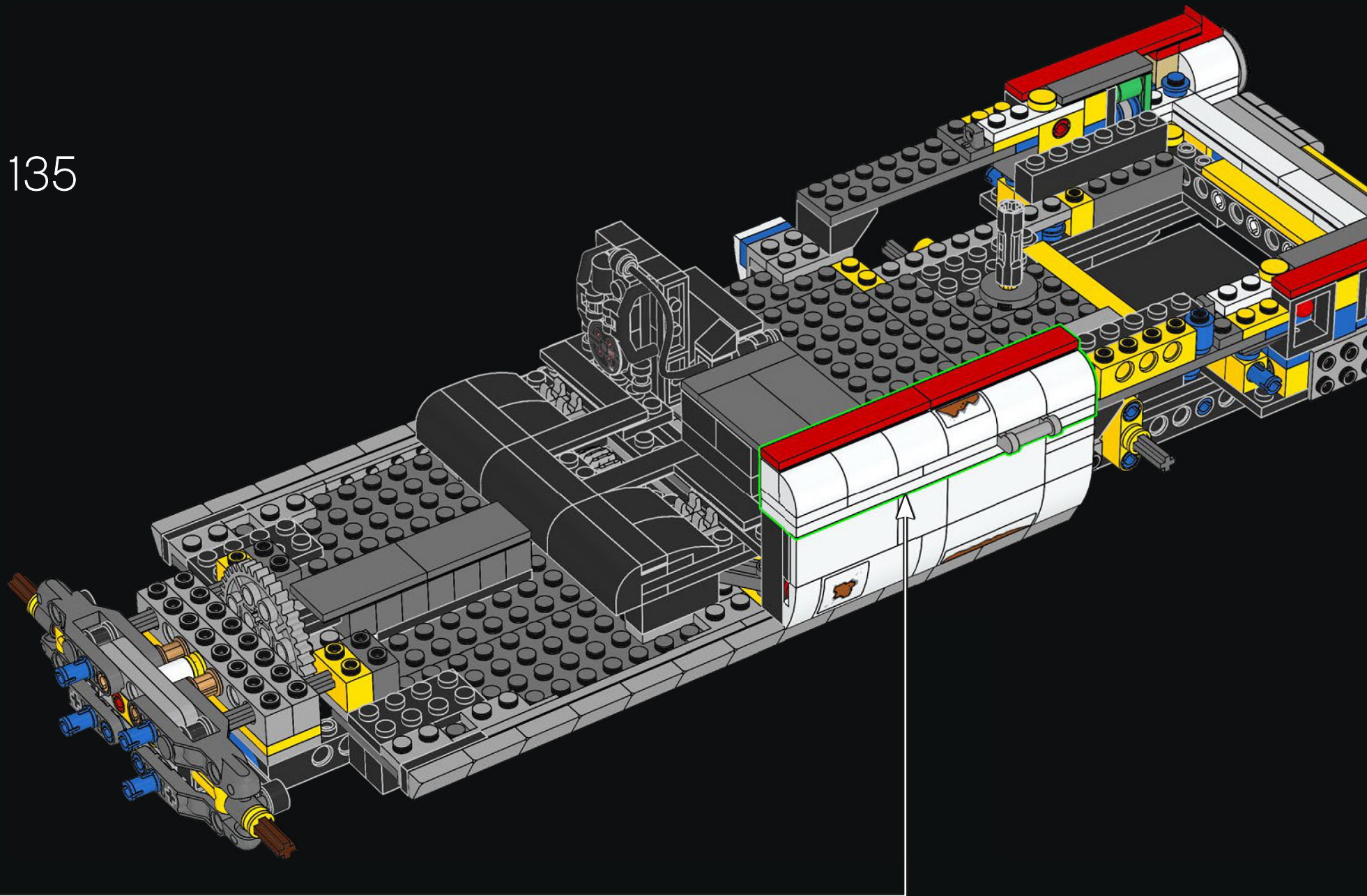

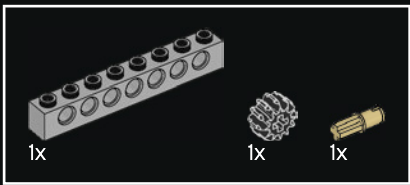

136

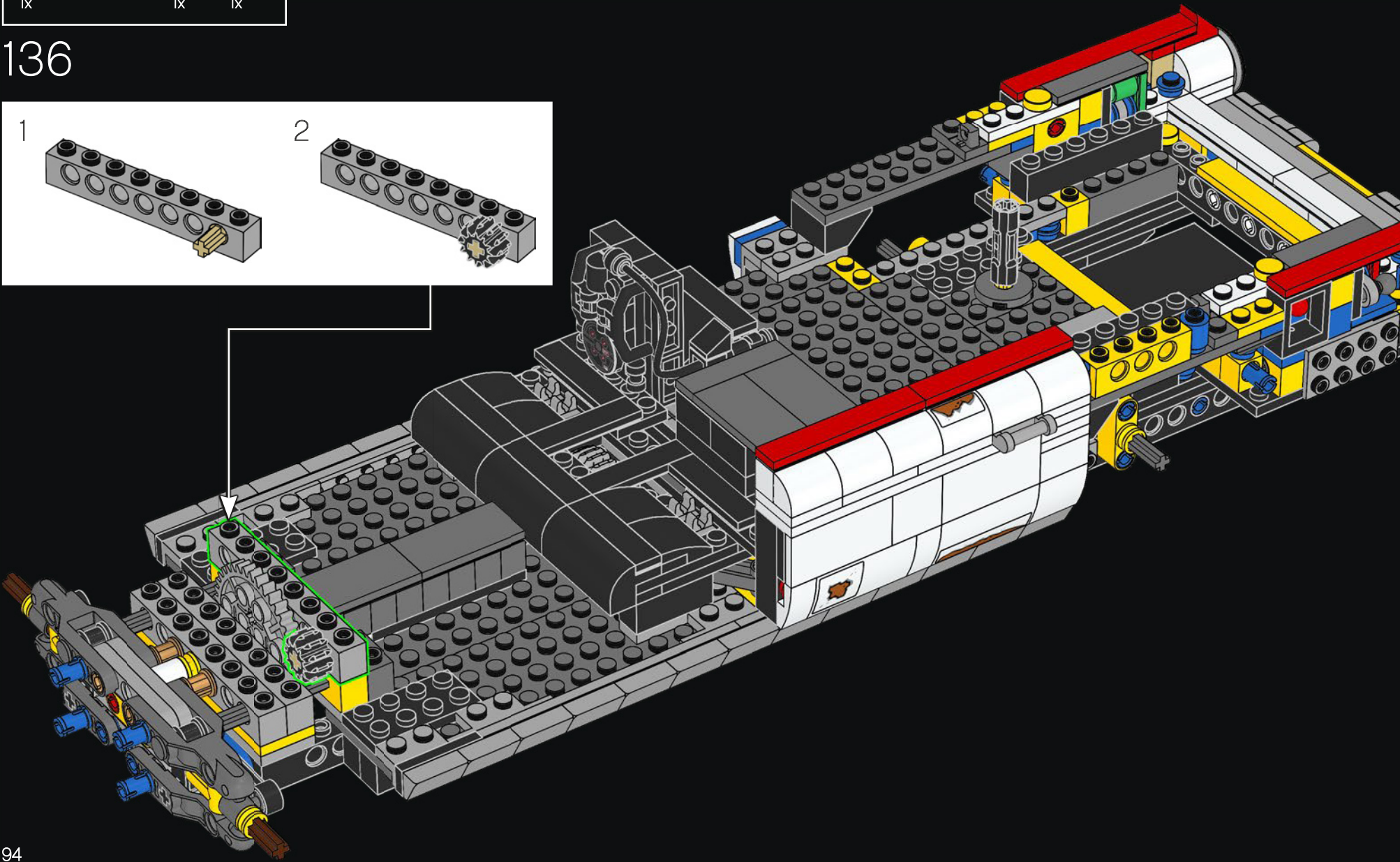
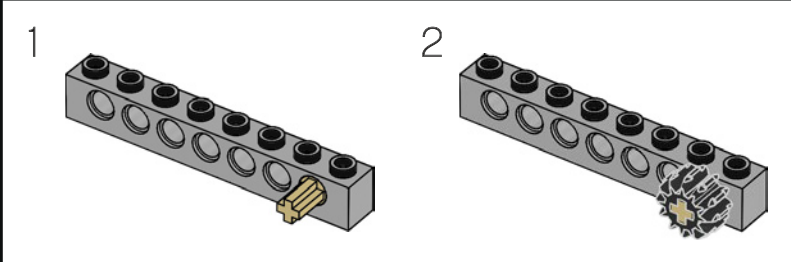

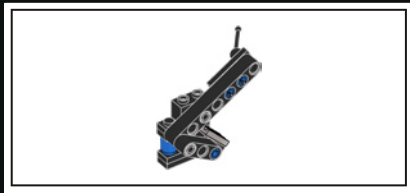

137

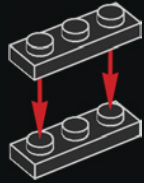

138

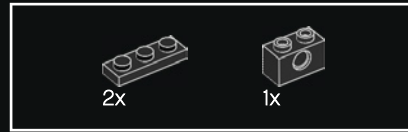
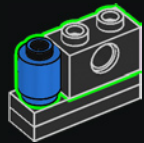

139

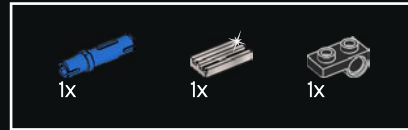
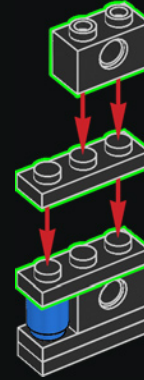

140

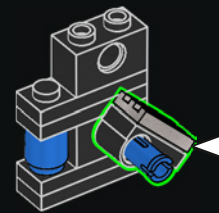
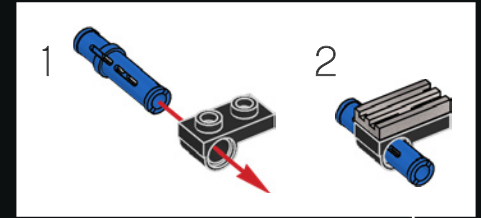

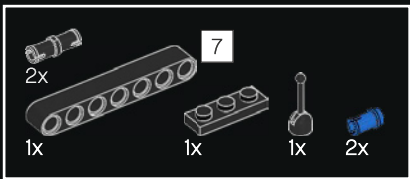

141

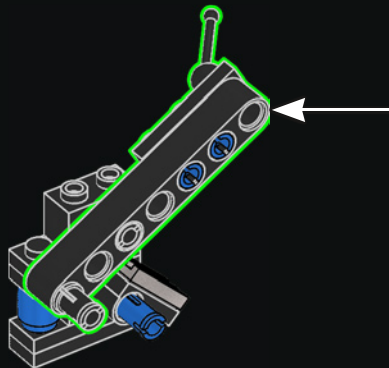
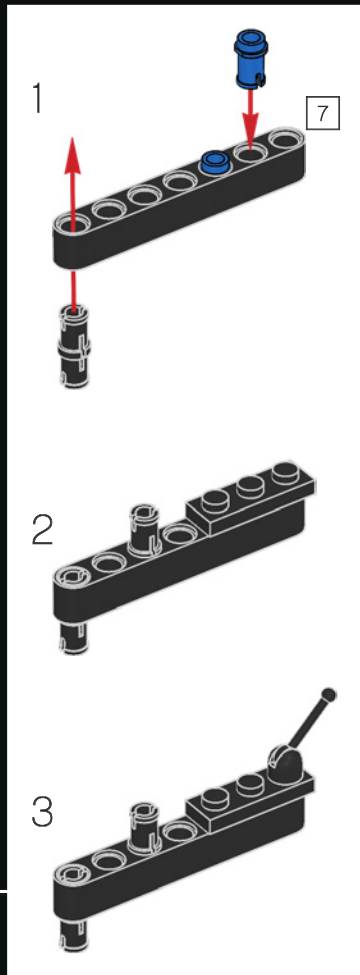

96



142

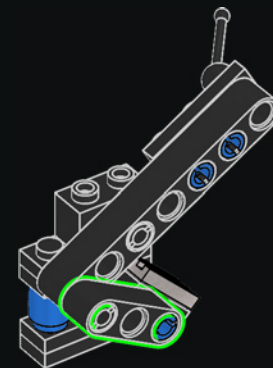

143

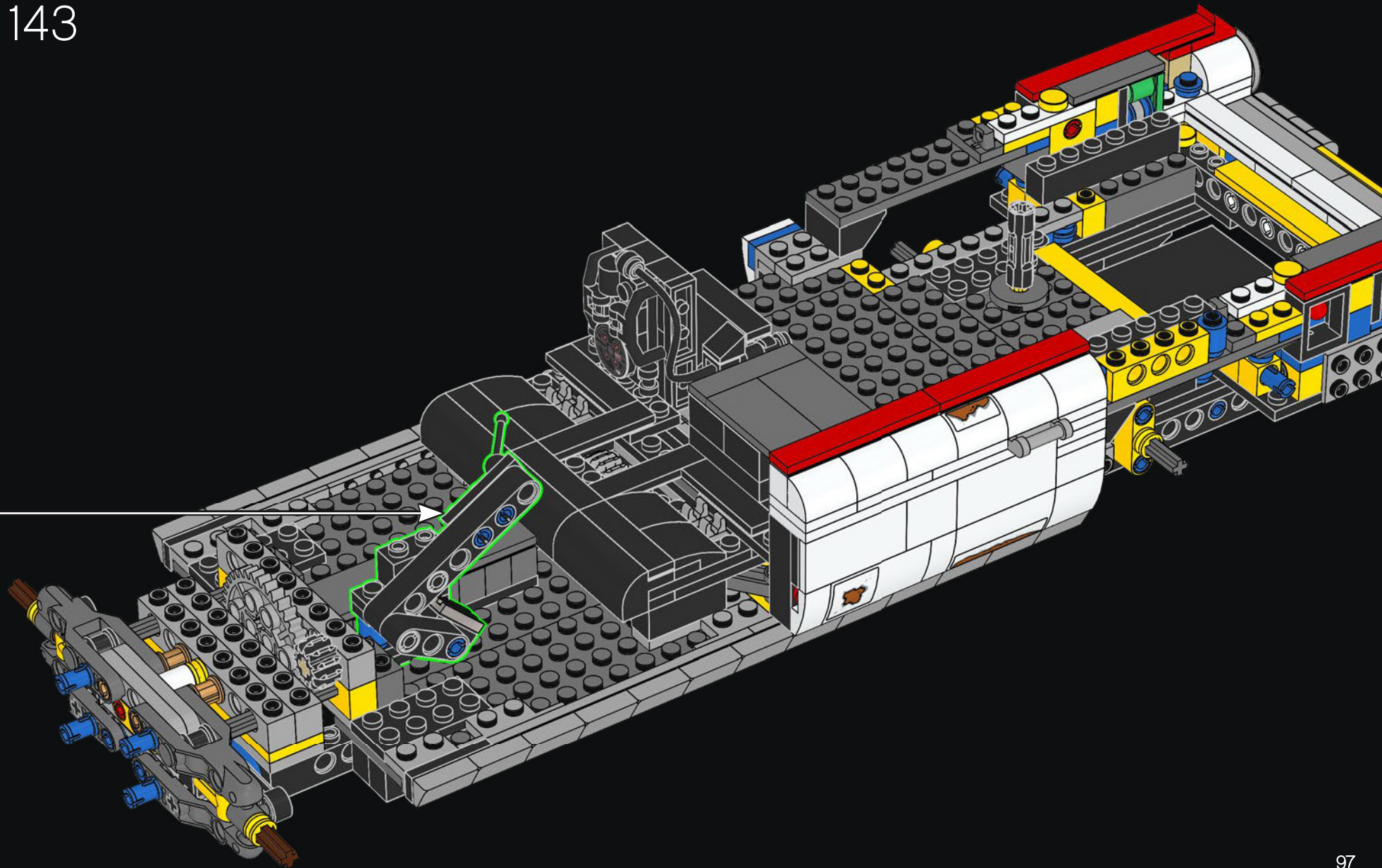

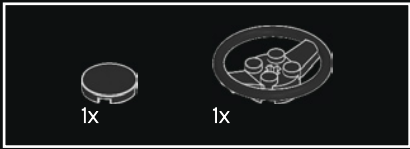
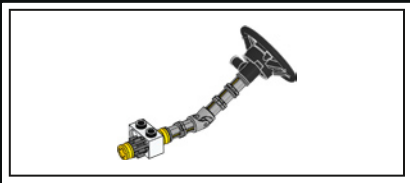

144

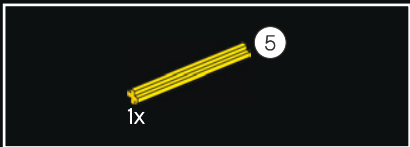
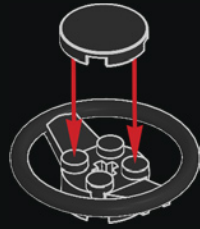

145

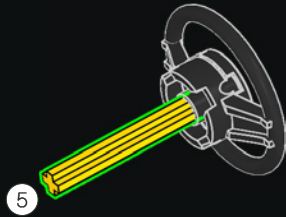

146

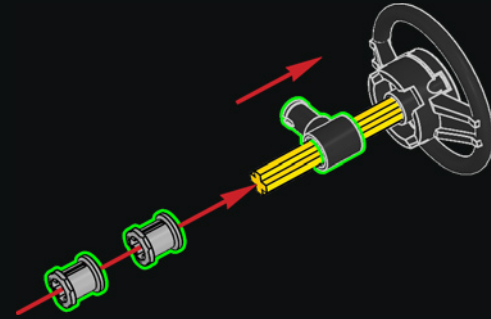

147

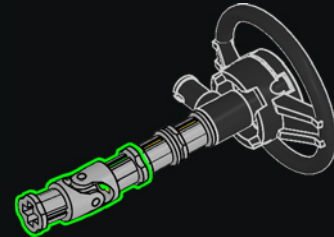

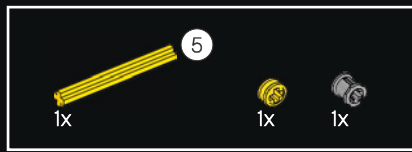

148

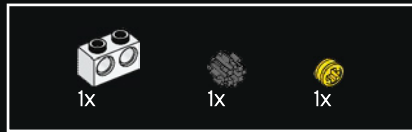
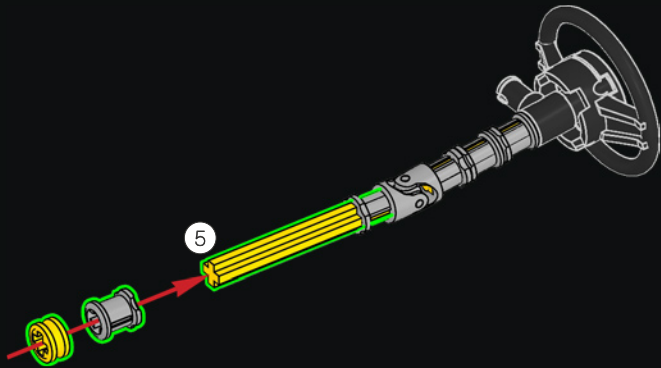

149

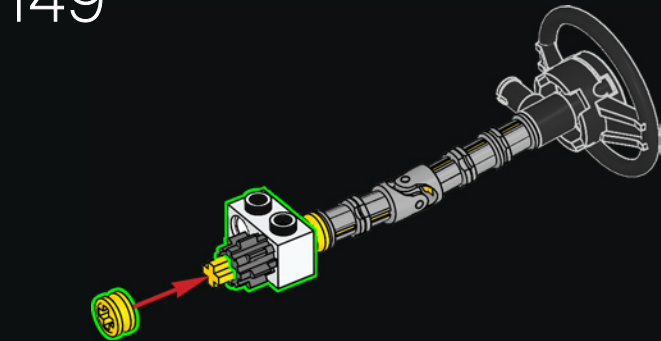

150

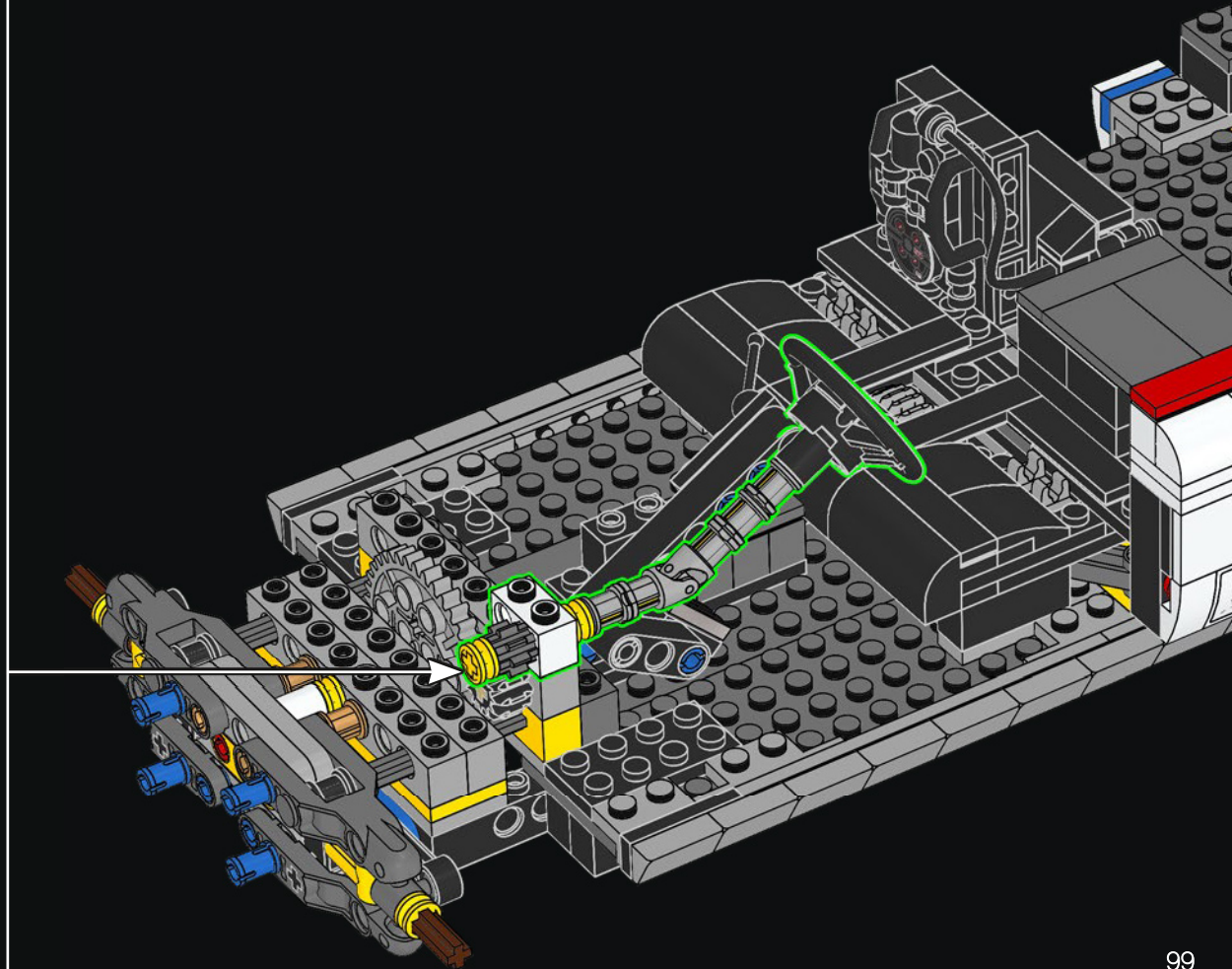

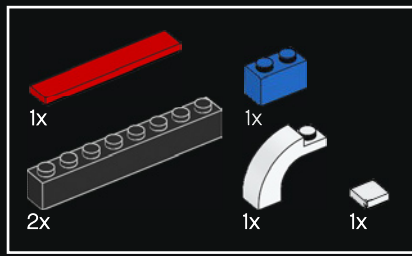

152

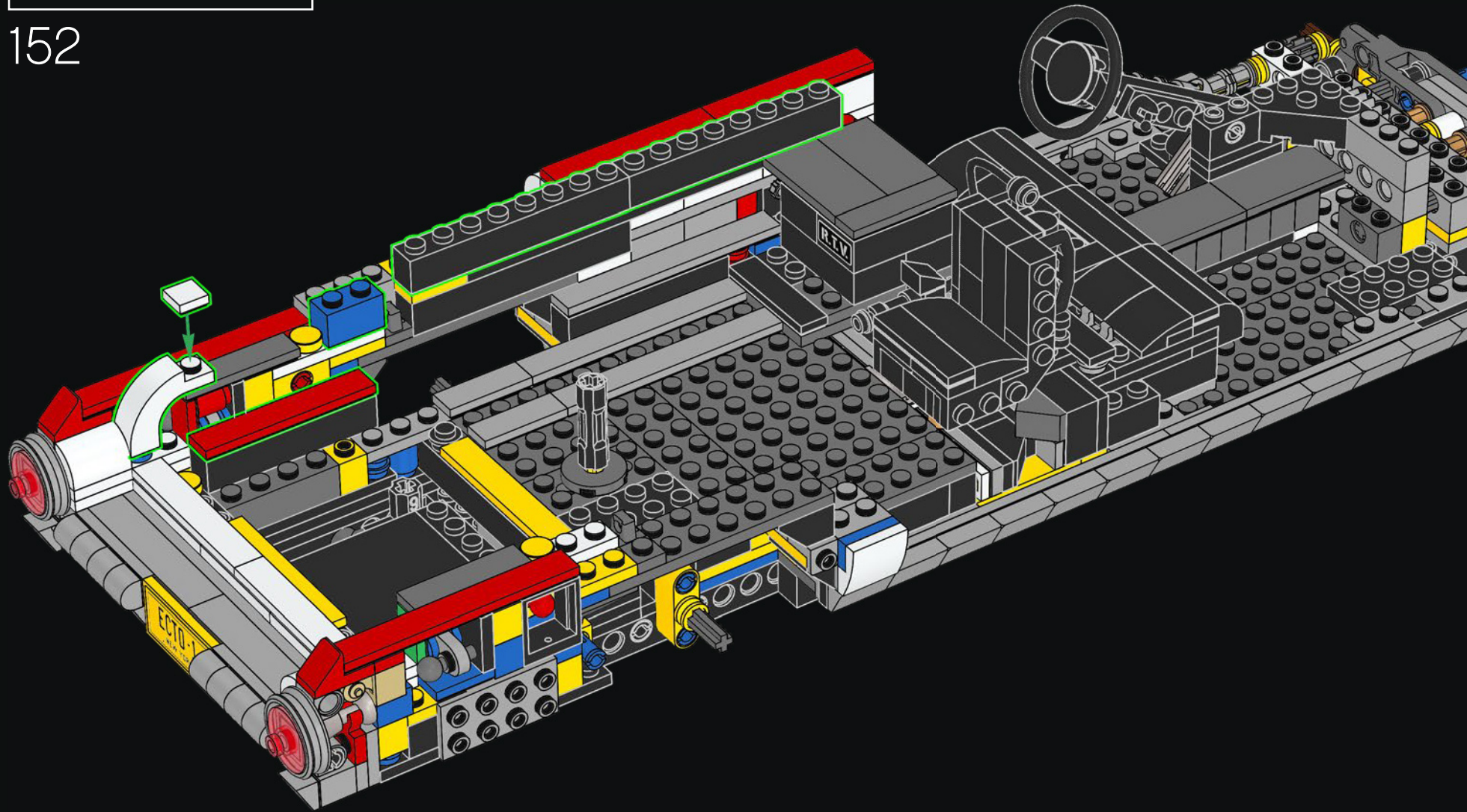

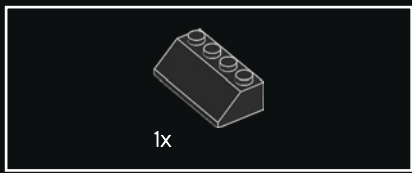

153

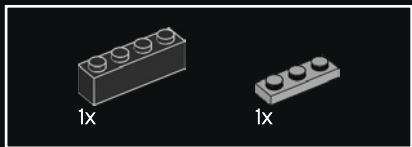
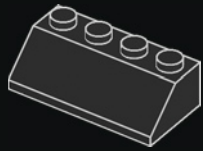

154

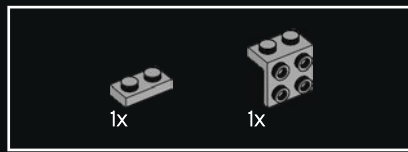
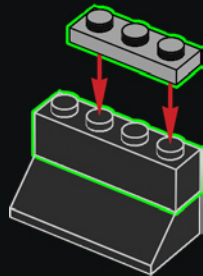

155

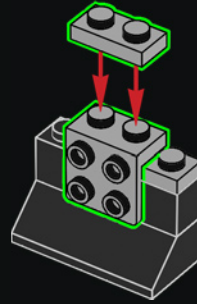

156

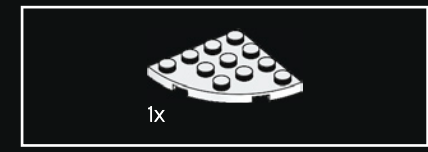
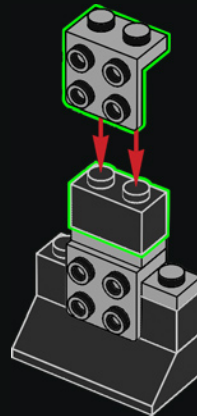

157

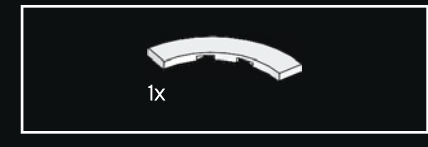
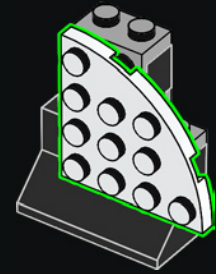

158

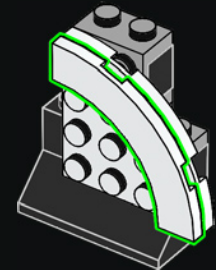

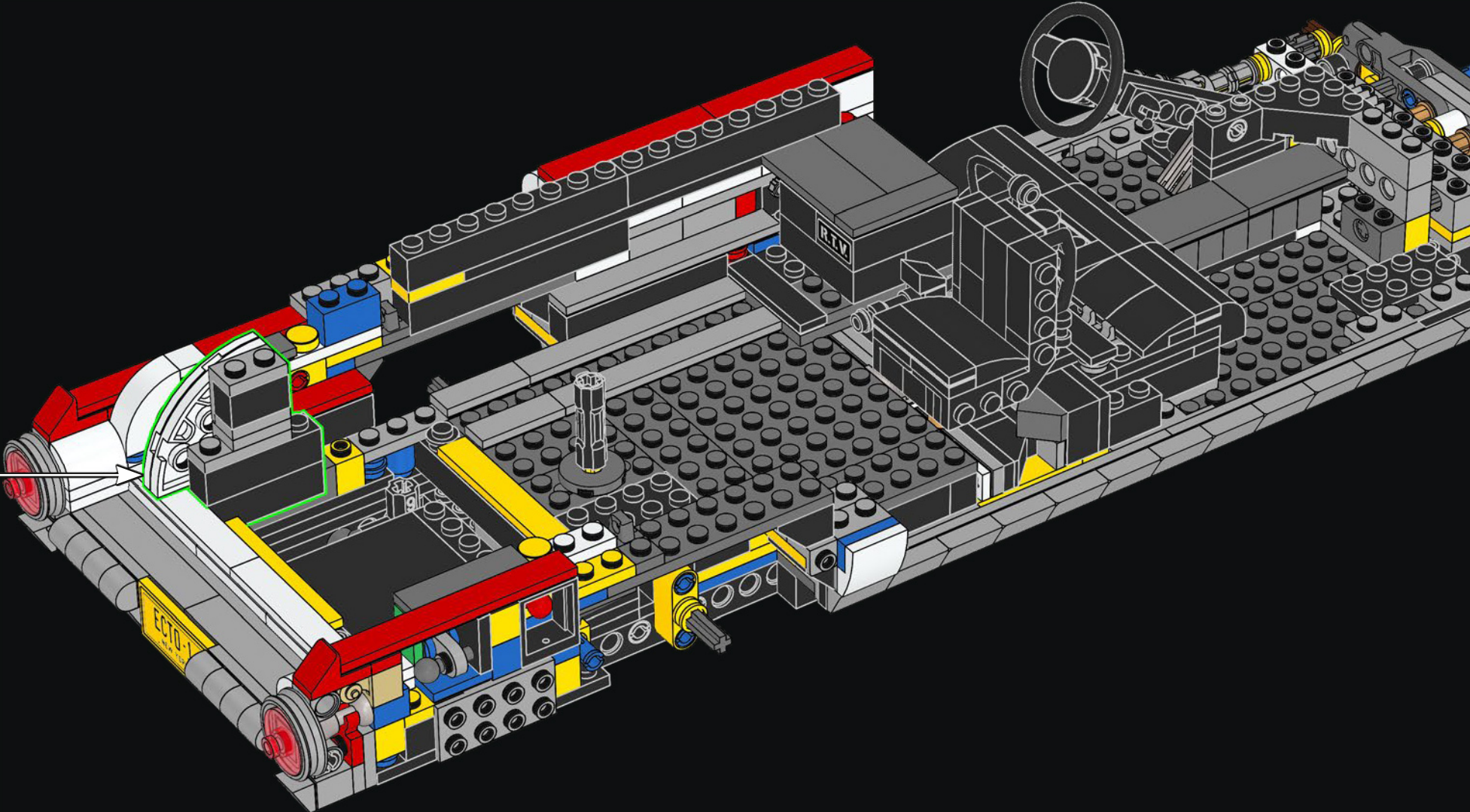

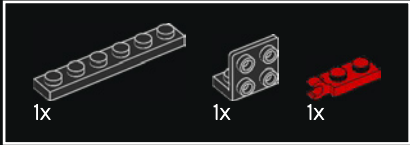
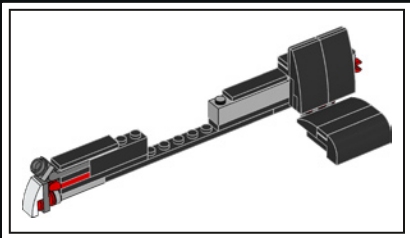

160

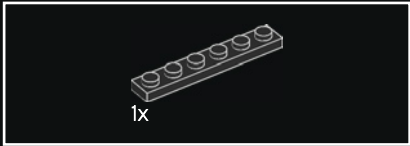
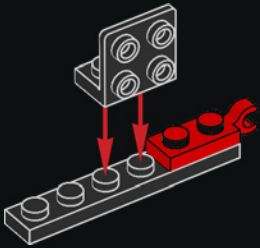

161

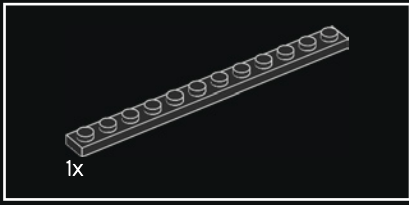
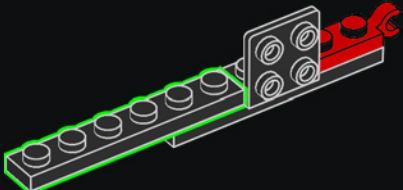

162

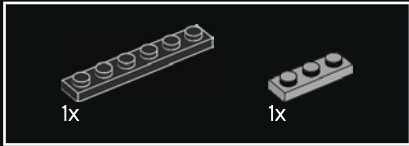
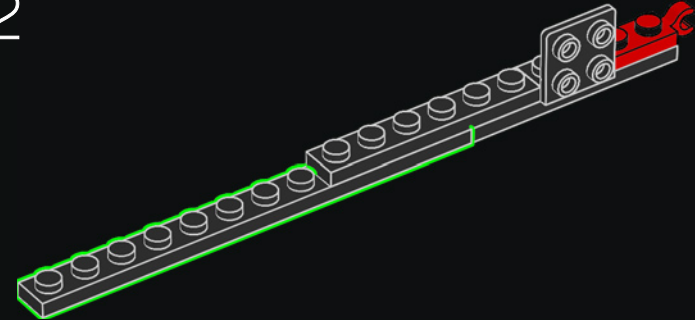

163

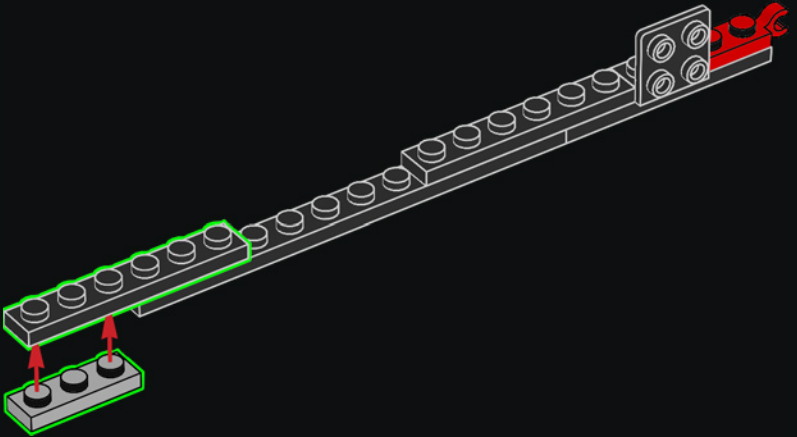

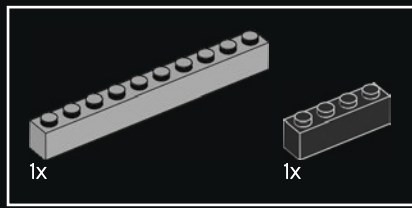

164

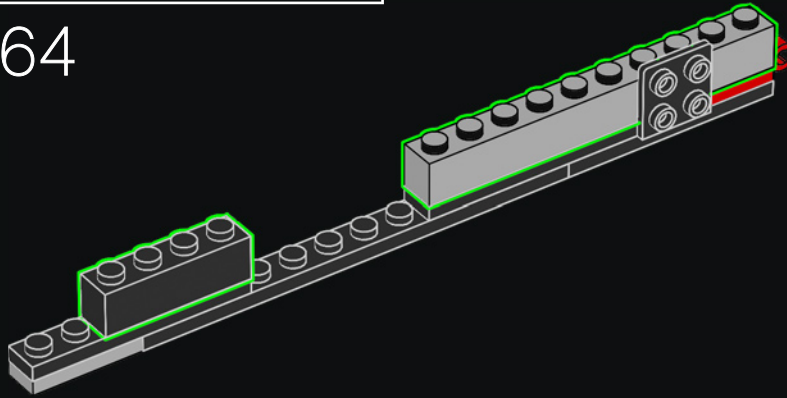

165

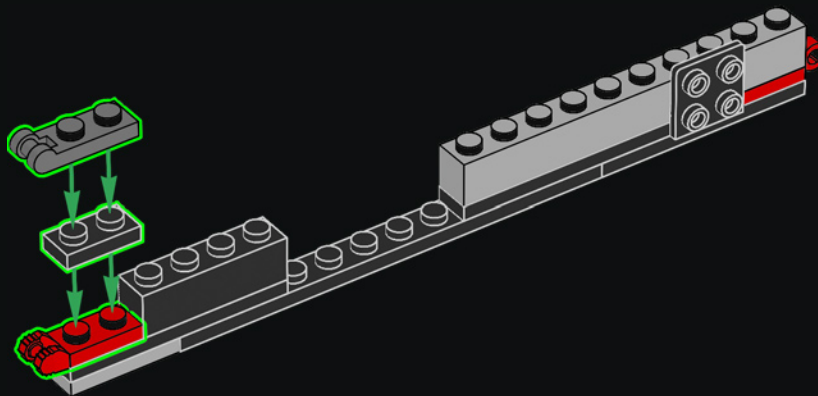

166

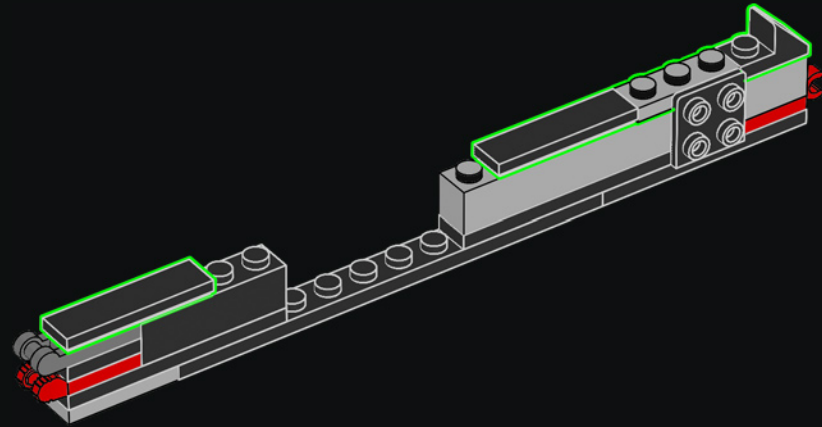

167

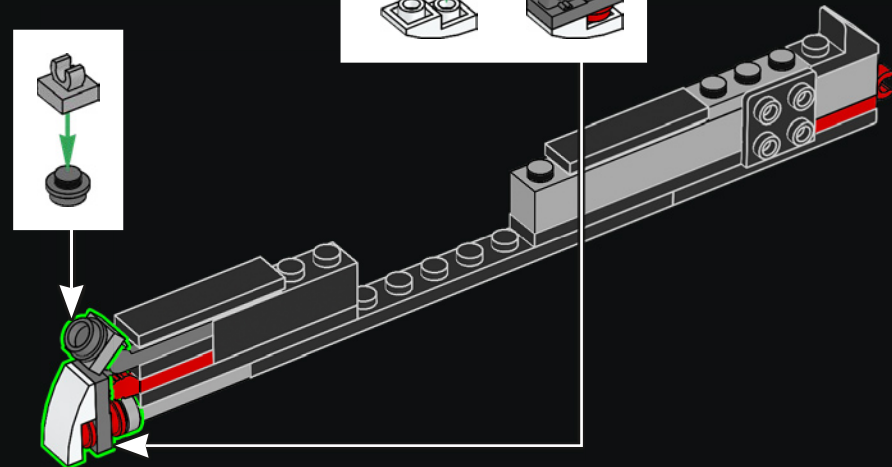
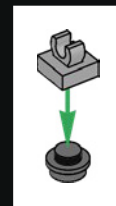
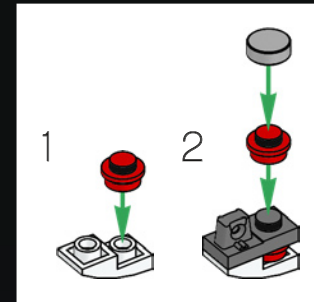



2x

168

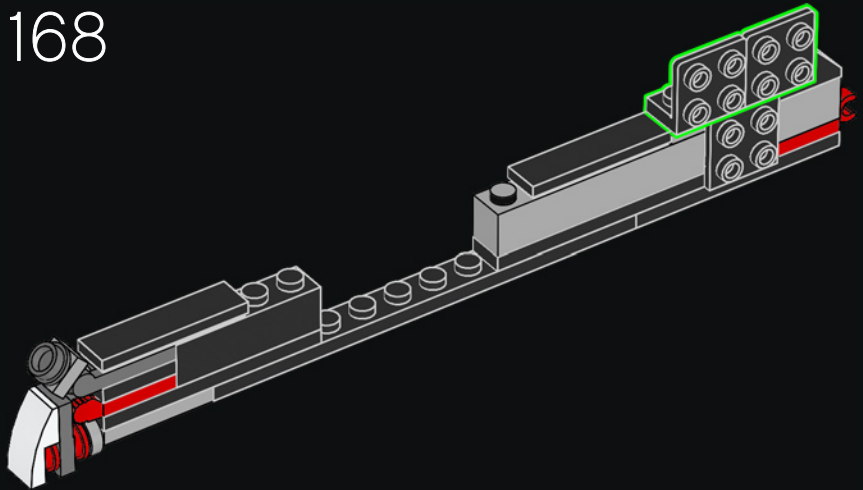

1x

170

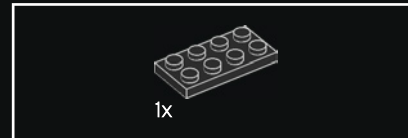

1x

169

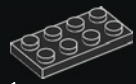
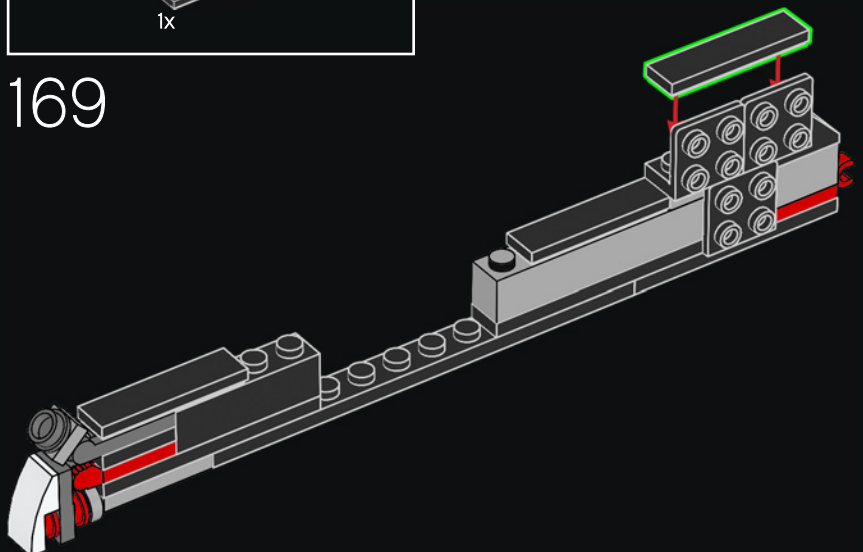

1x



2x

171

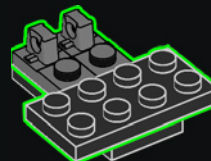

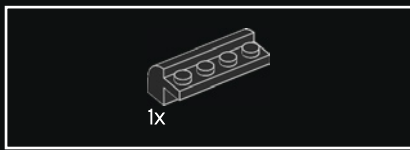

172

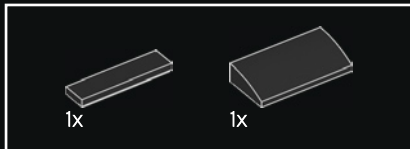
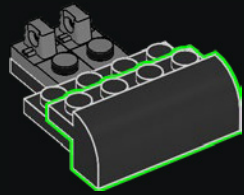

173

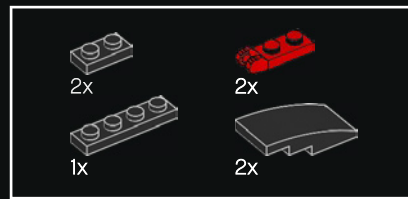
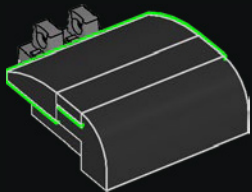

174

- 1
- 2
- 3
- 4

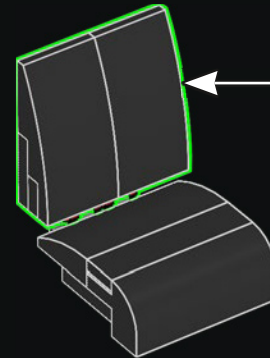

175

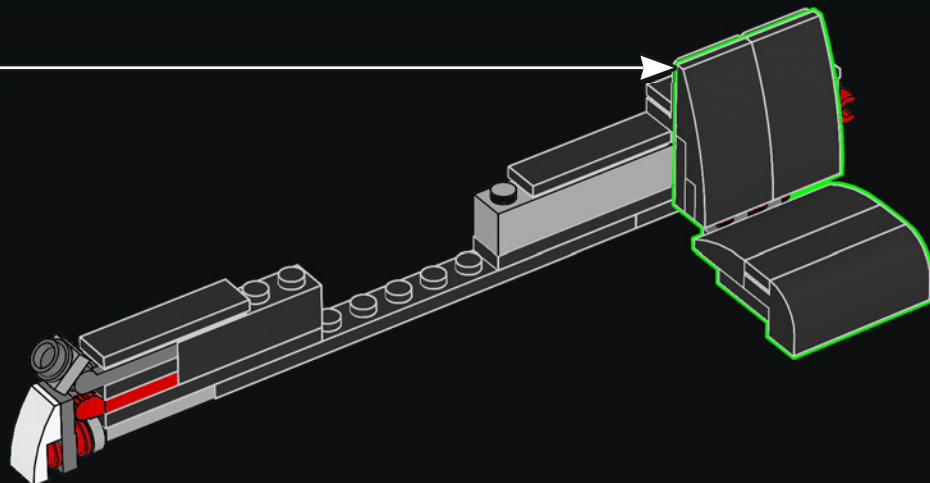

176

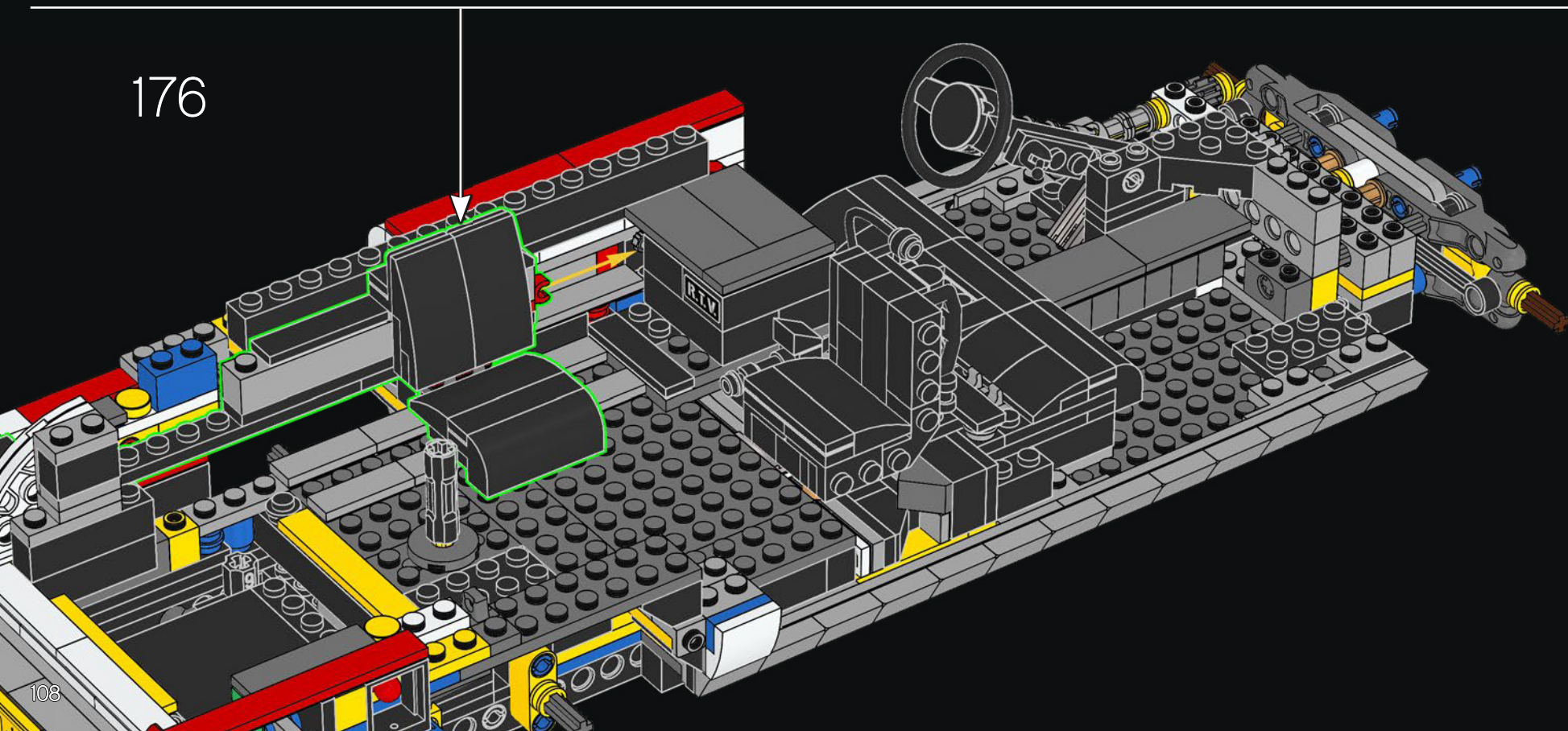

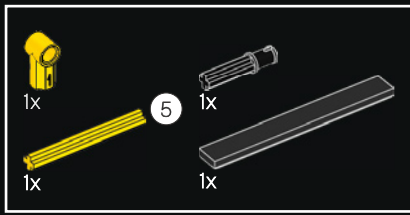

177

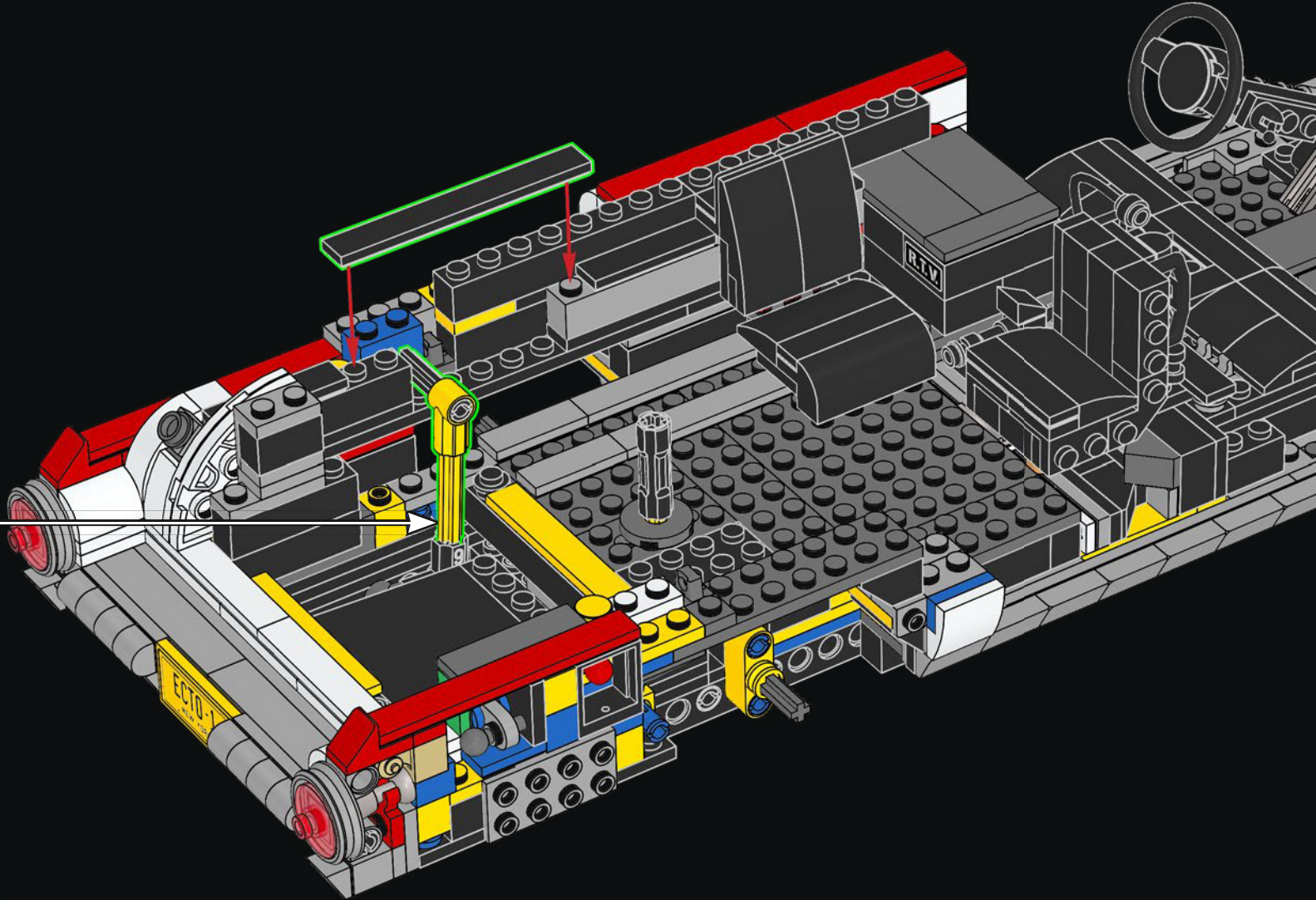
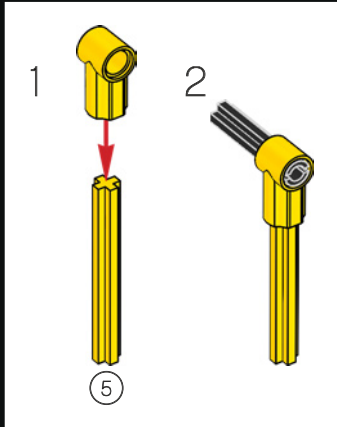

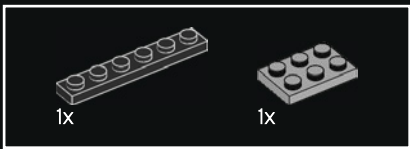

178

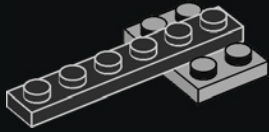

179

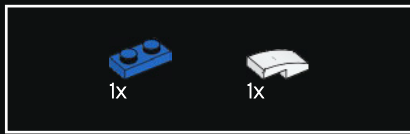
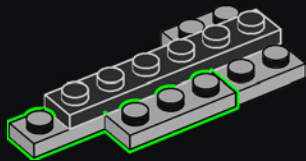

180

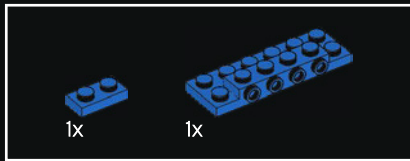
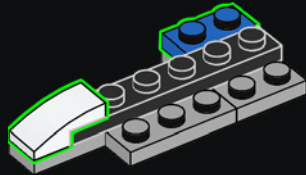

181

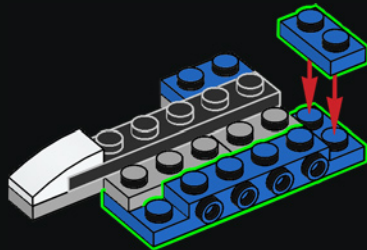

182

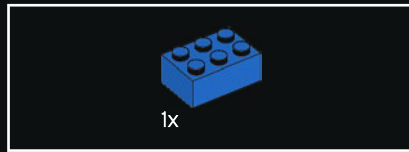
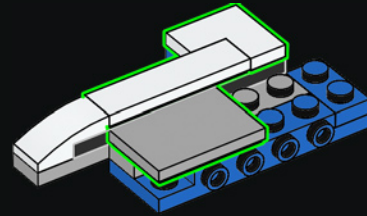

183

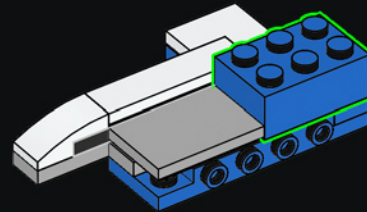

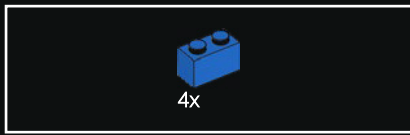

184

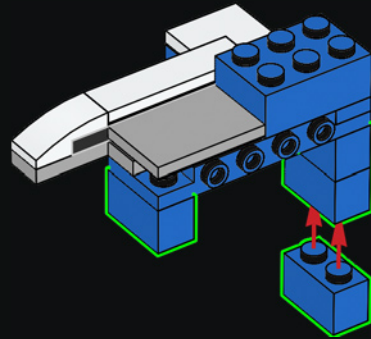

185

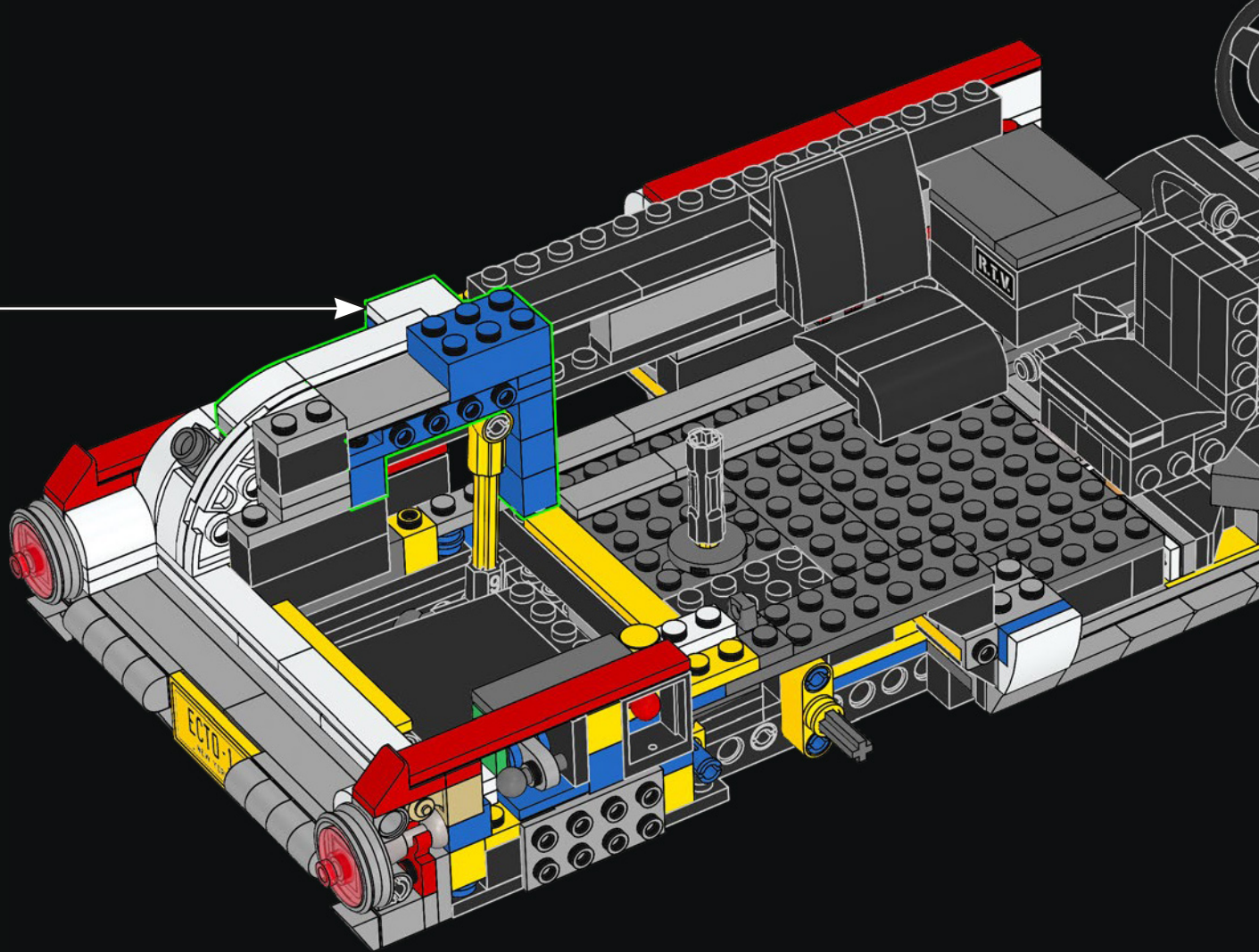

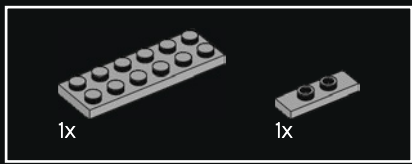

186

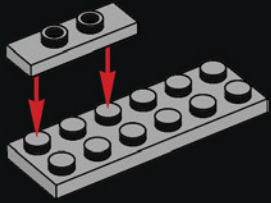

187

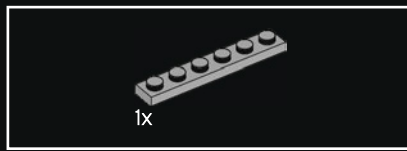
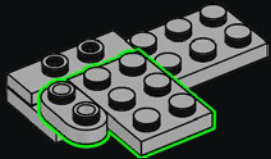

188

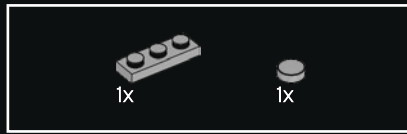
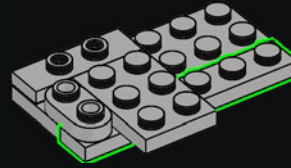

189

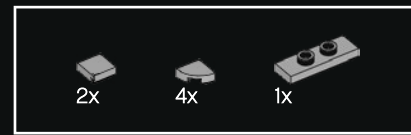
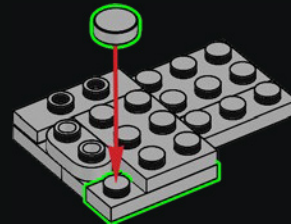

190

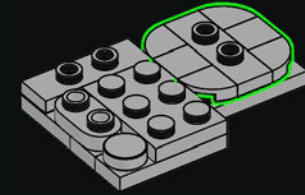

191



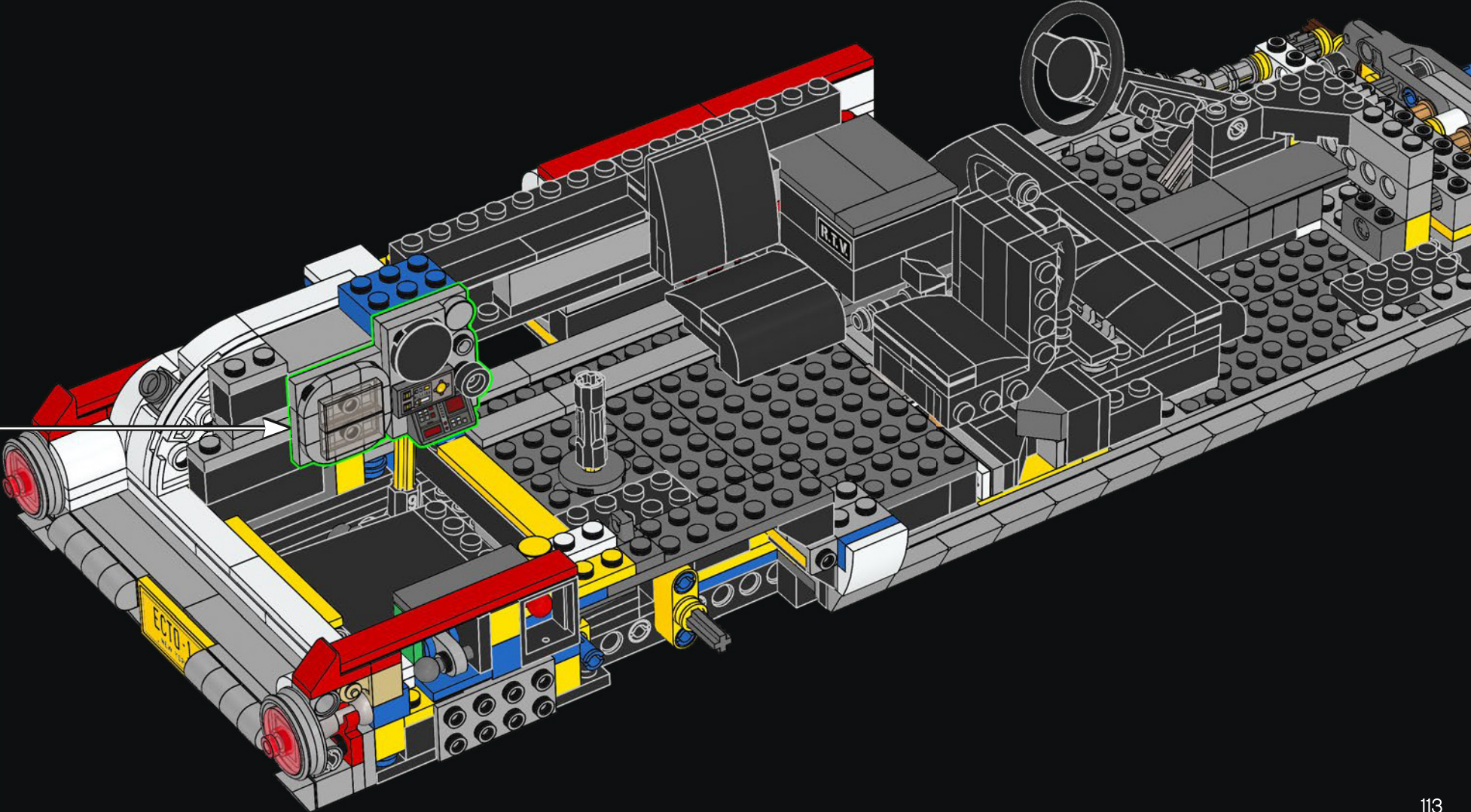

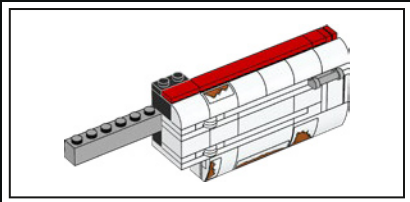
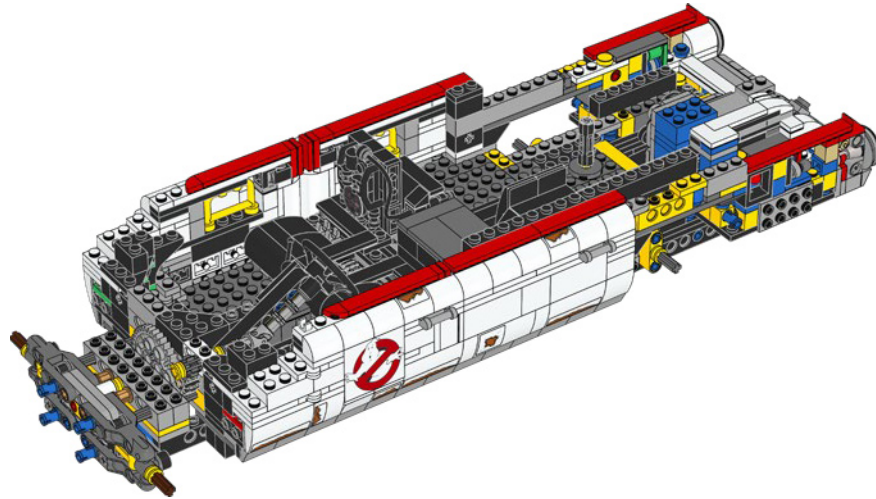
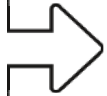

193

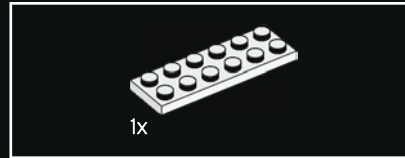
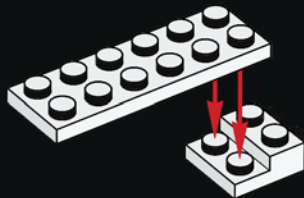

194

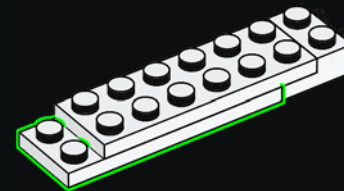

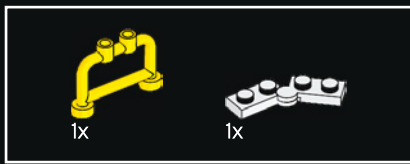

195

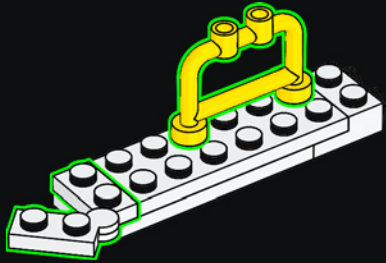

196

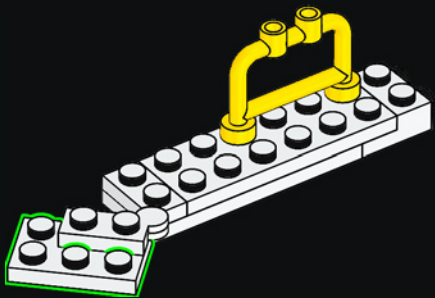

197

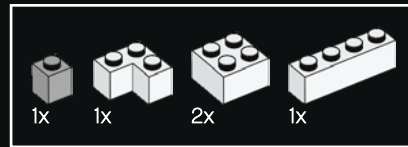
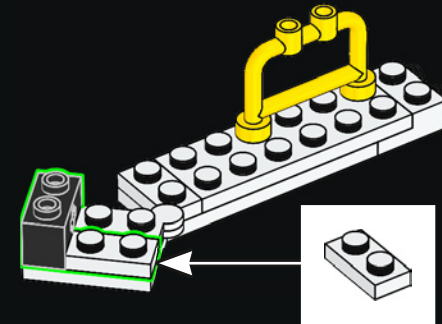

198

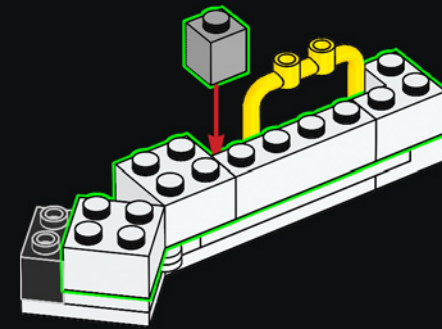

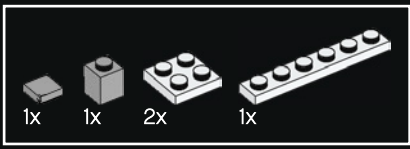

199

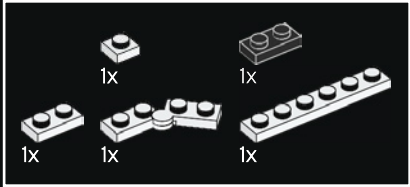
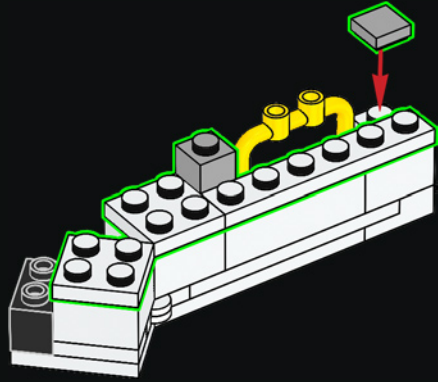

200

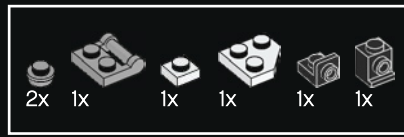
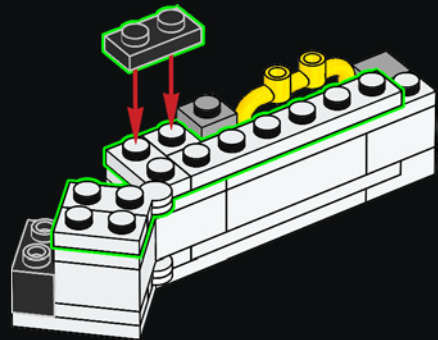

201

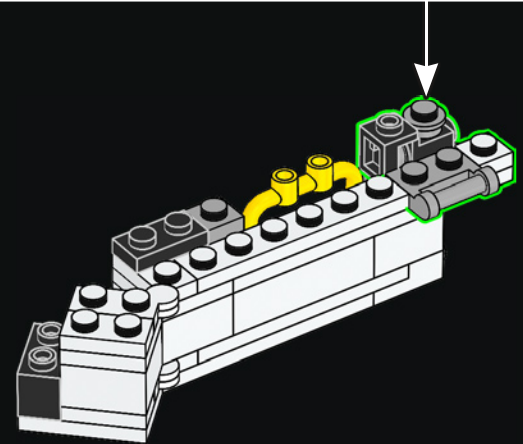
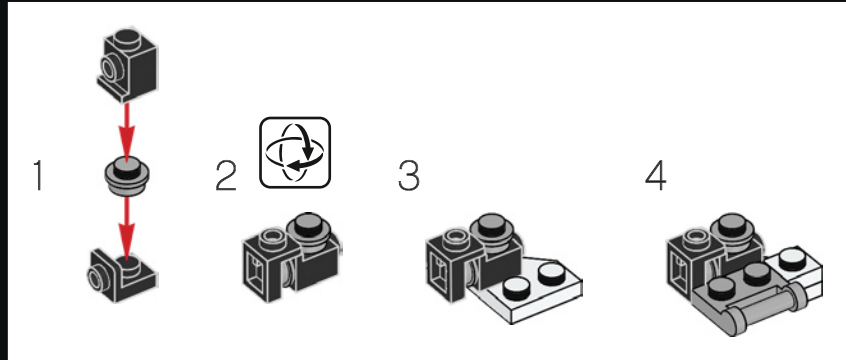

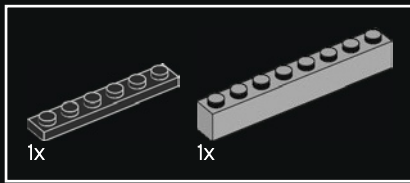

202

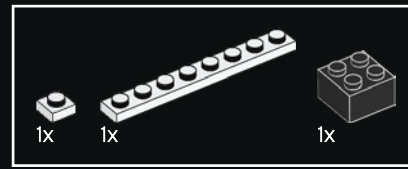
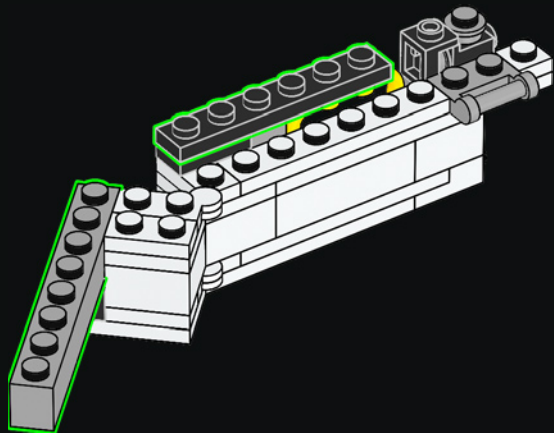

203

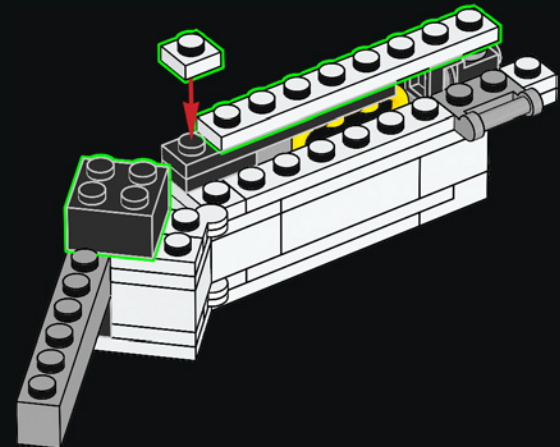

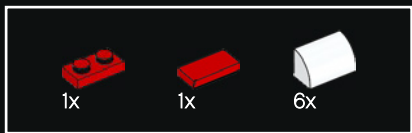

204

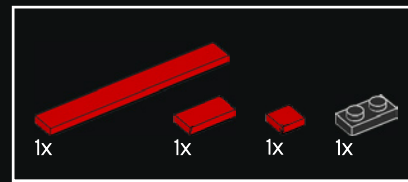
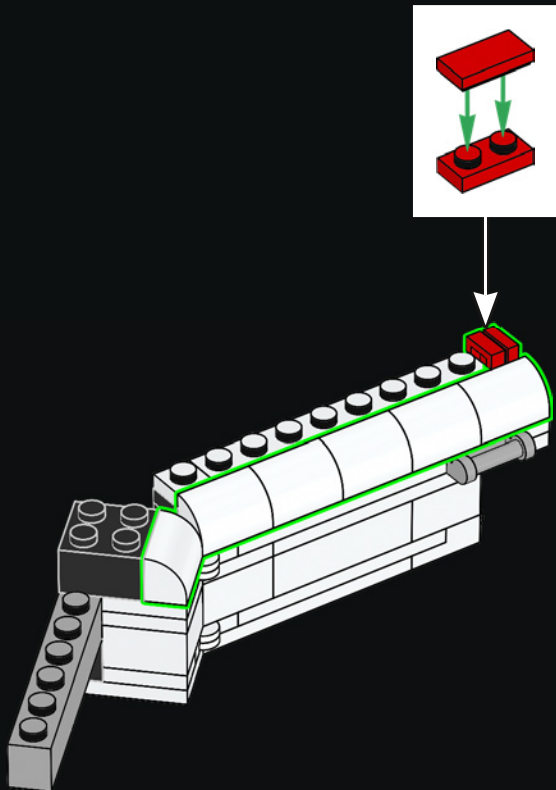

205

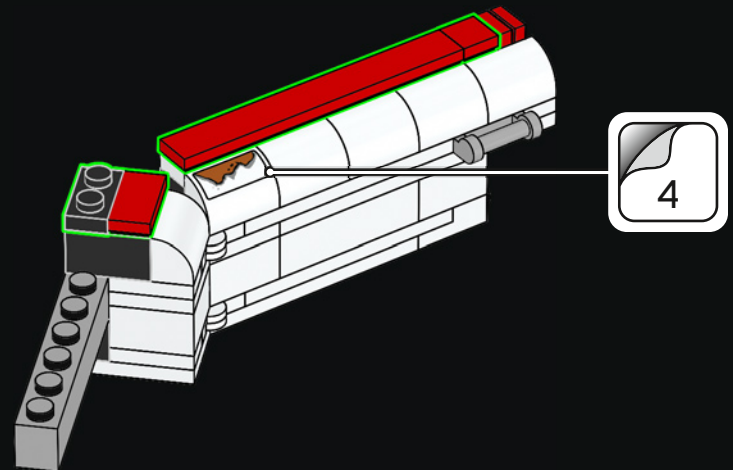

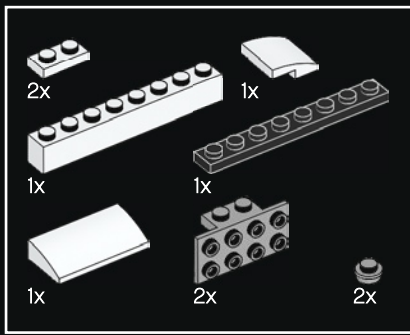

206

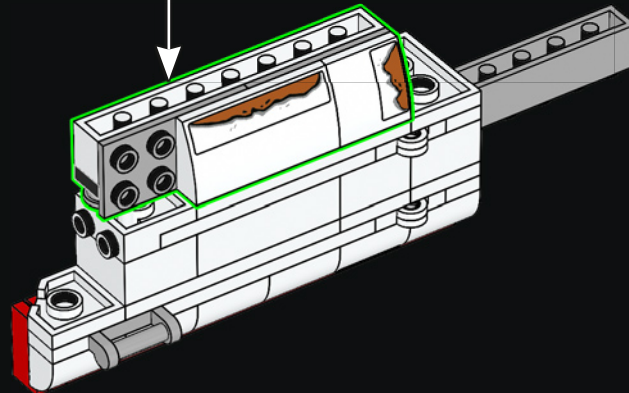
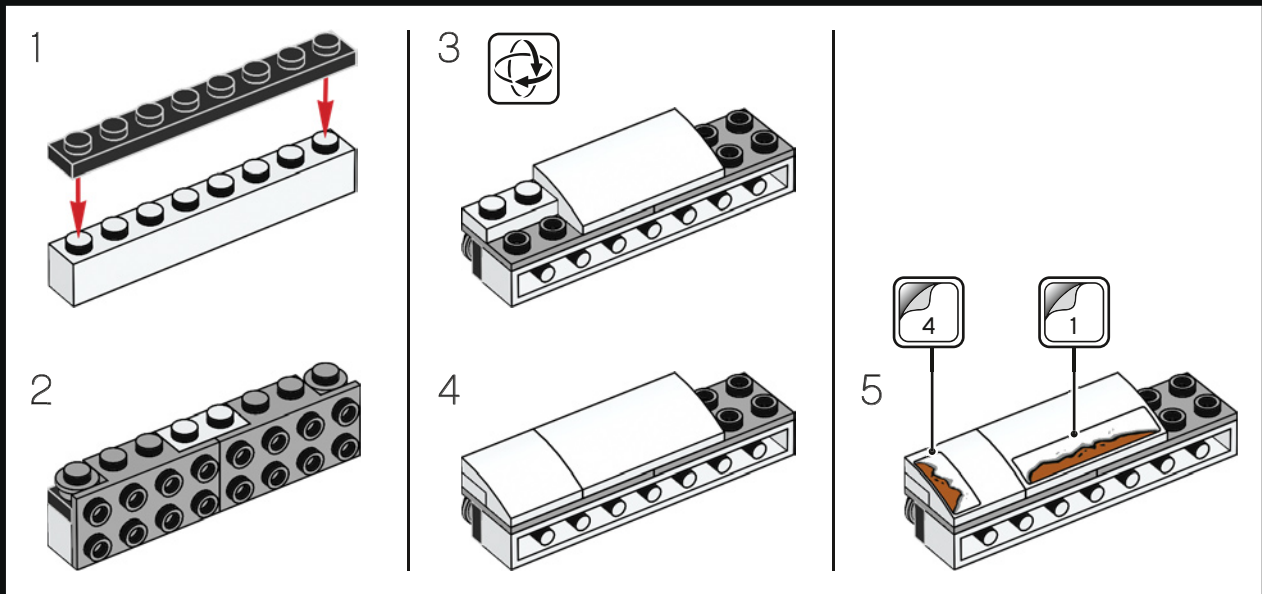

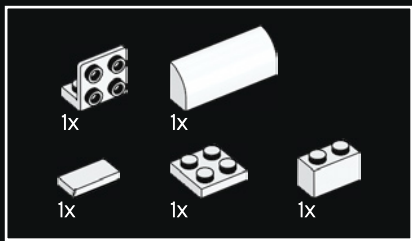

207

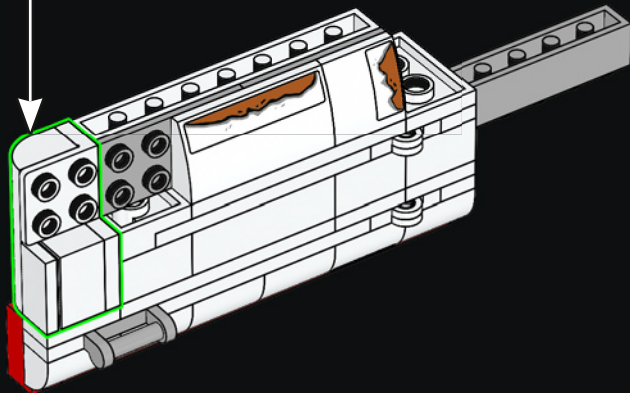
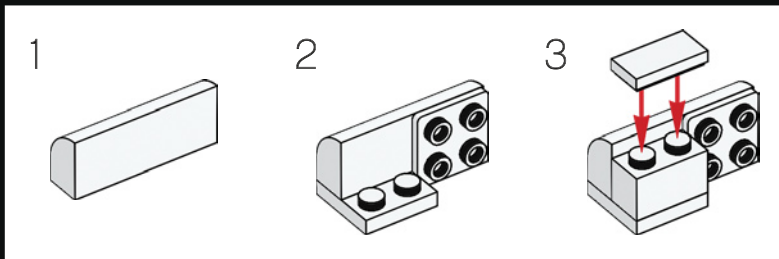

208

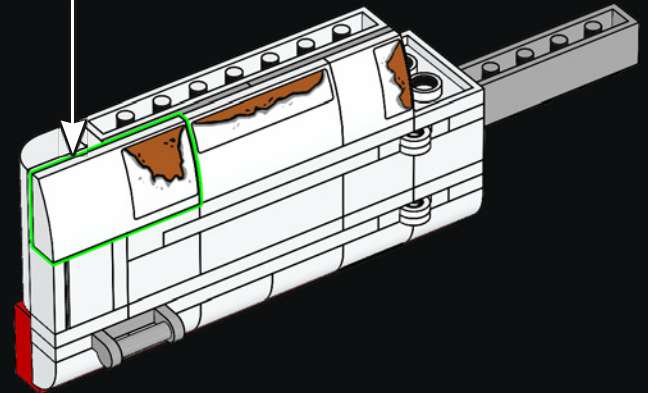
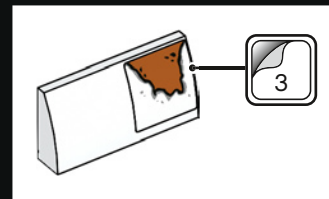

209

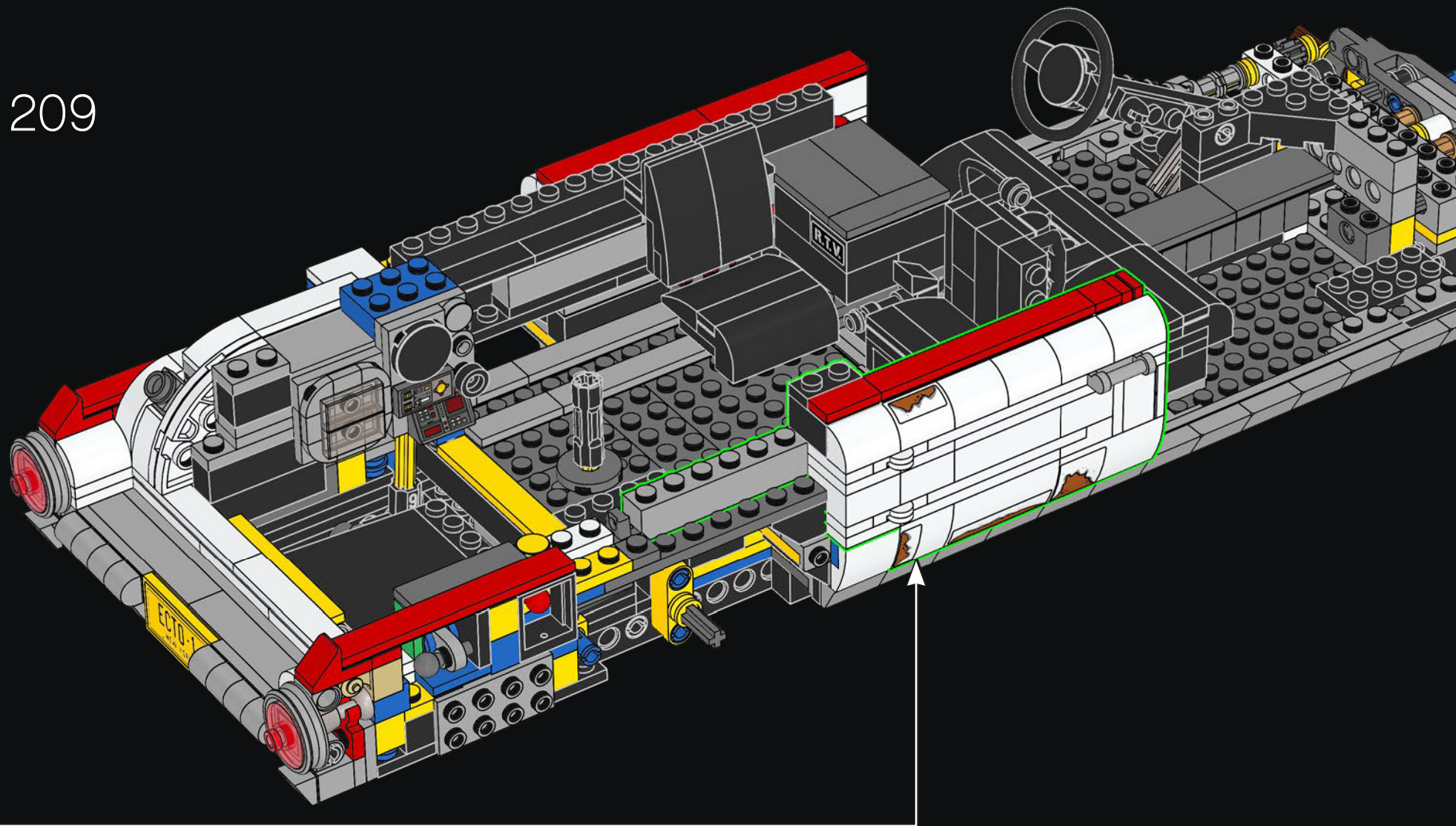

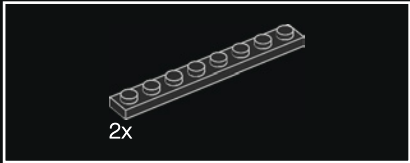
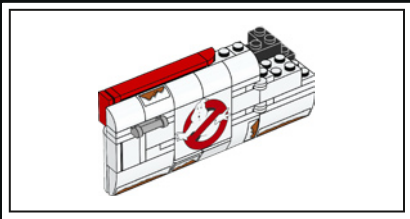

2x

210

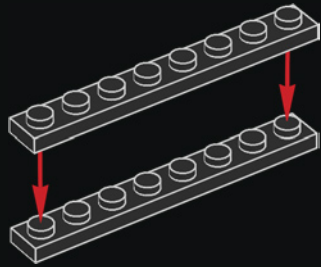

2x

2x

211

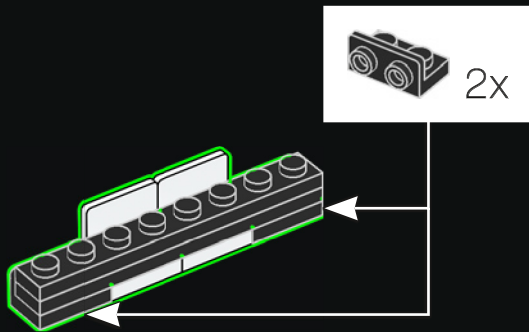

2x



2x

212

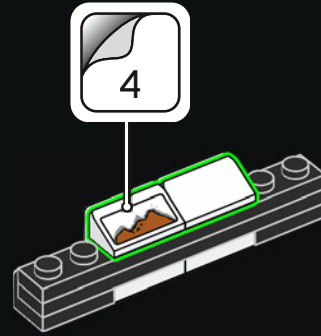

4



1x

1x

213

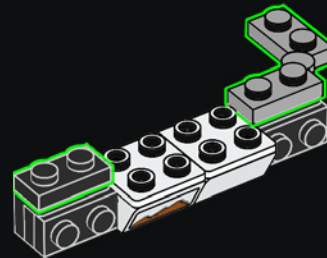



214

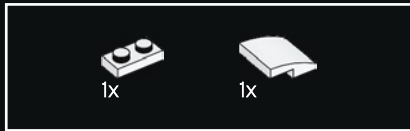
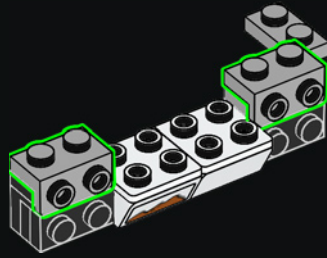

215

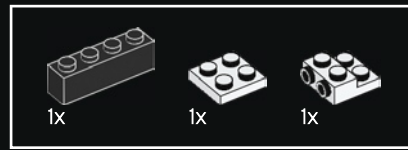
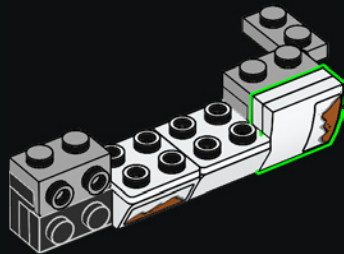
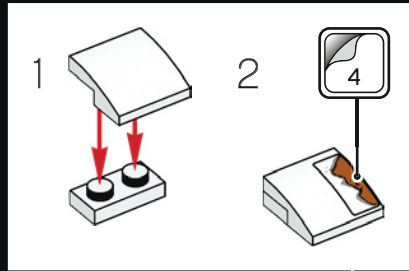

216

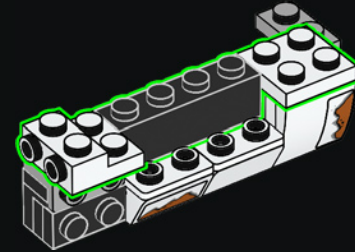

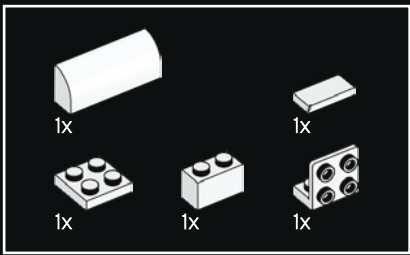

217

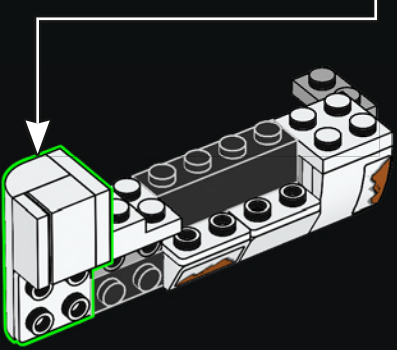
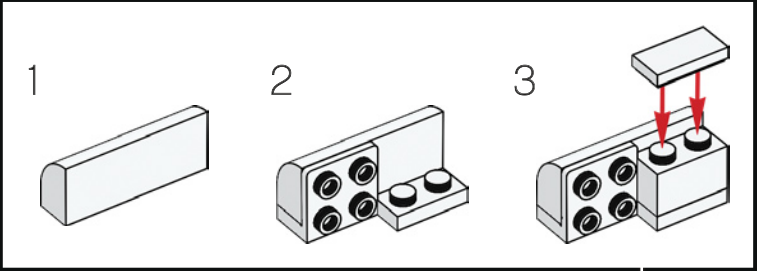

218

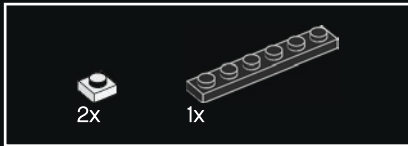
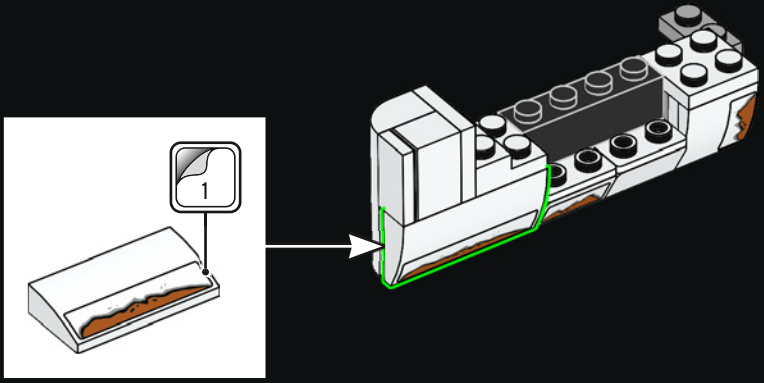

219

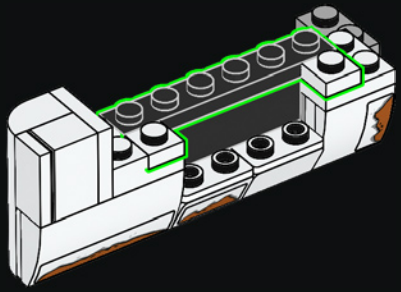



220

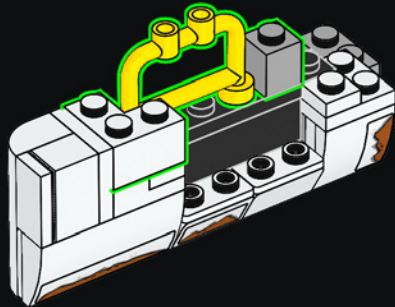

221

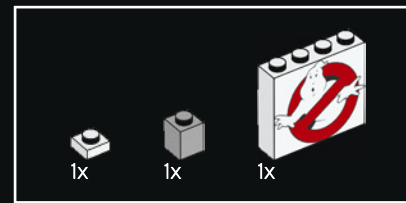
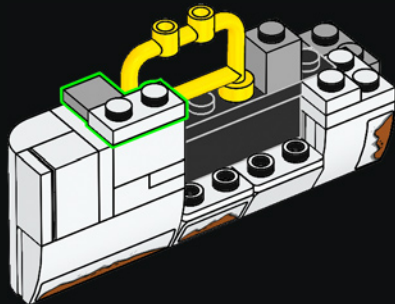

222

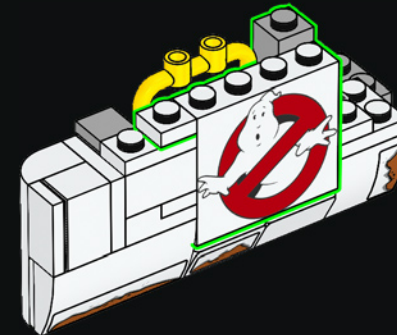

The No-Ghost logo has become a powerful marketing tool for the Ghostbusters business and features a ghost named Mooglie.

Le logo « fantômes interdits » est devenu un puissant outil de marketing pour l'entreprise des chasseurs de fantômes et met en vedette un fantôme nommé Mooglie.

El logotipo del fantasma atrapado en una señal de prohibido (llamado Mooglie) se ha convertido en una poderosa herramienta de mercadotecnia para la empresa de los cazafantasmas.



223

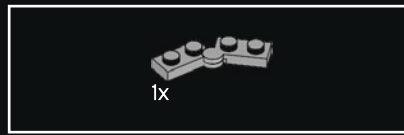
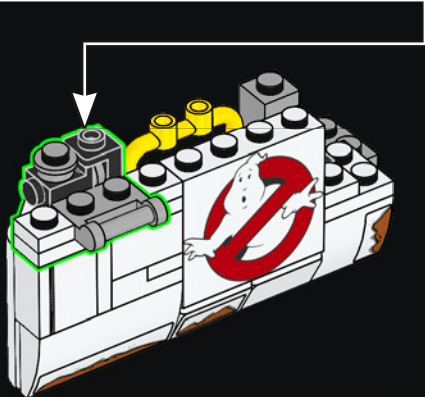
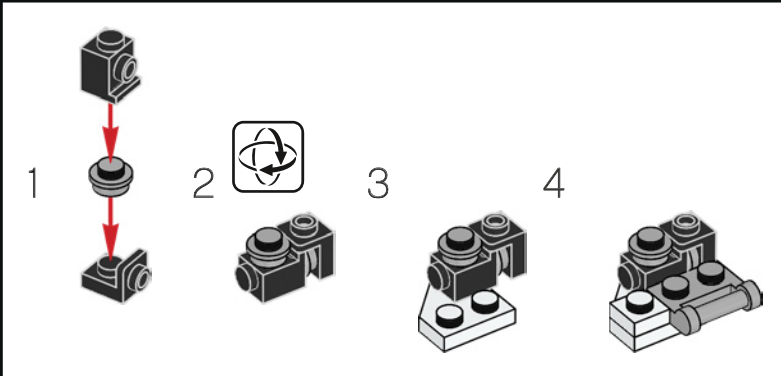

224

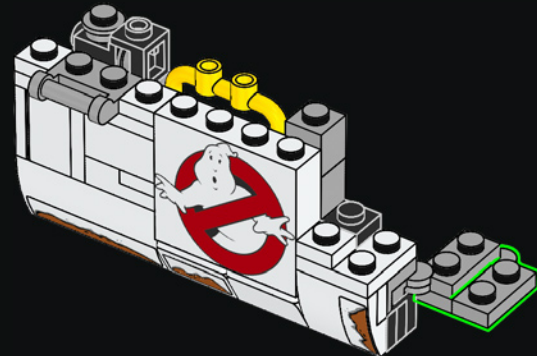

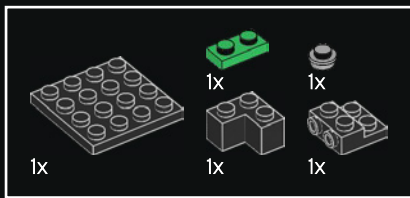

225

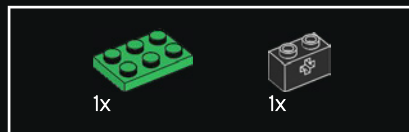
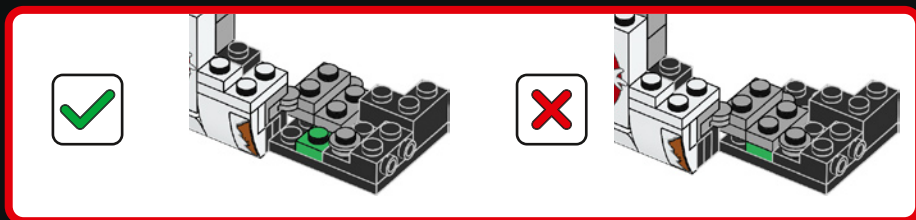
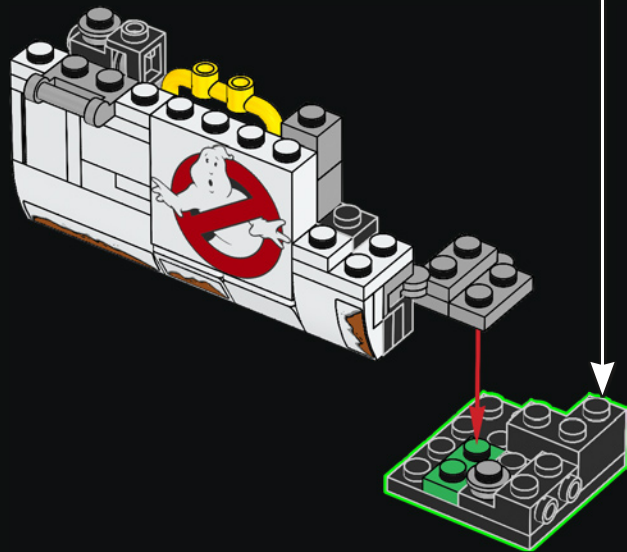
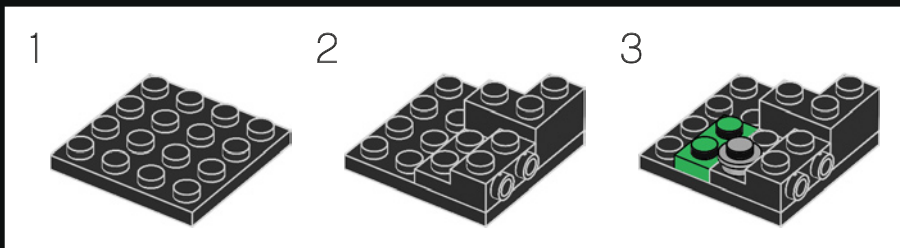

226

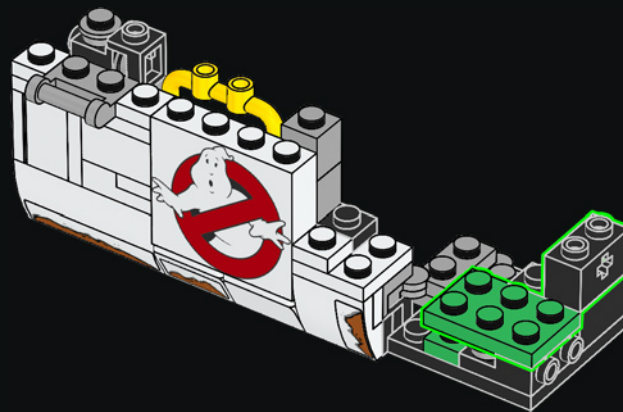

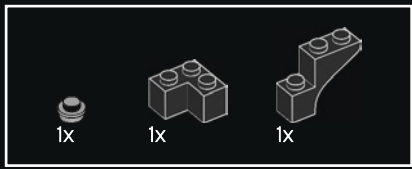

227

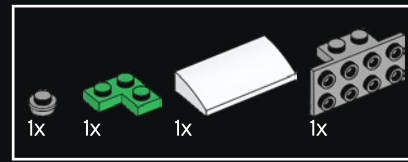
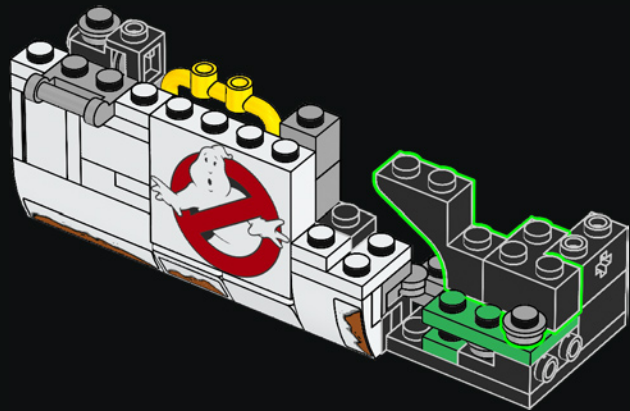

228

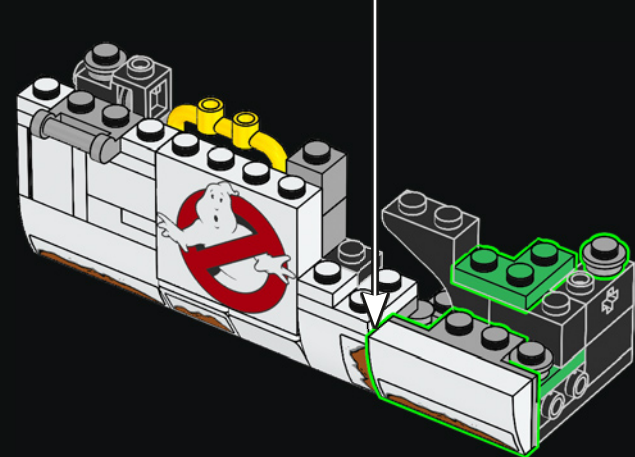
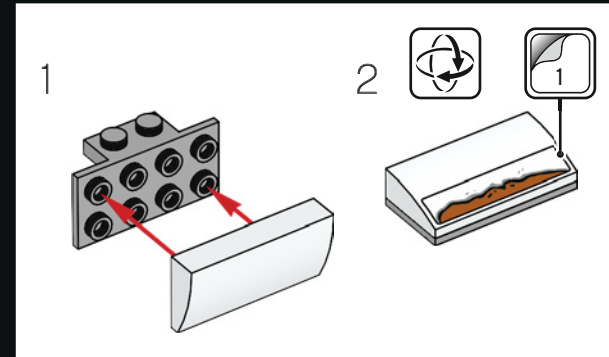



229

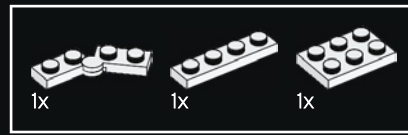
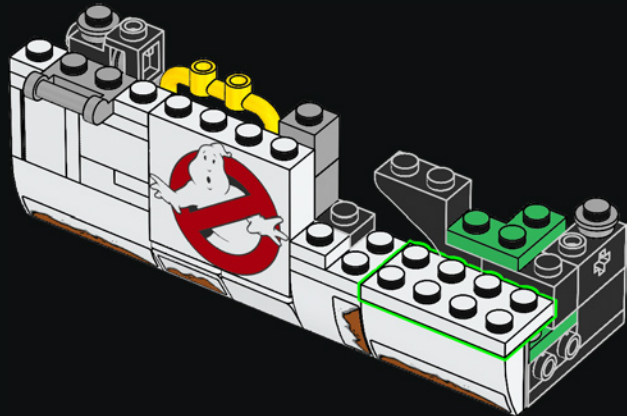

230

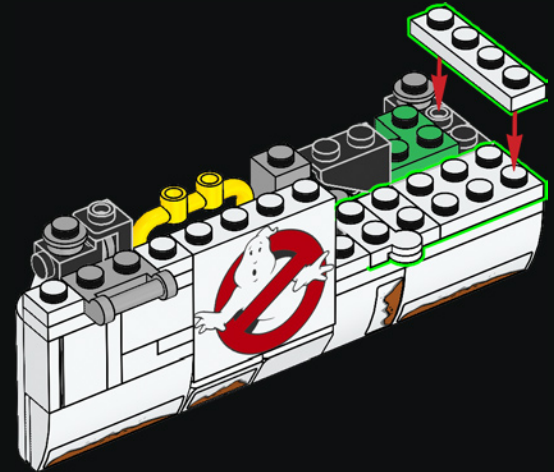



231

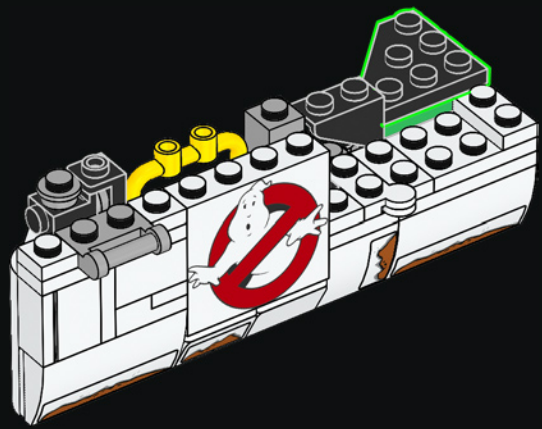

232

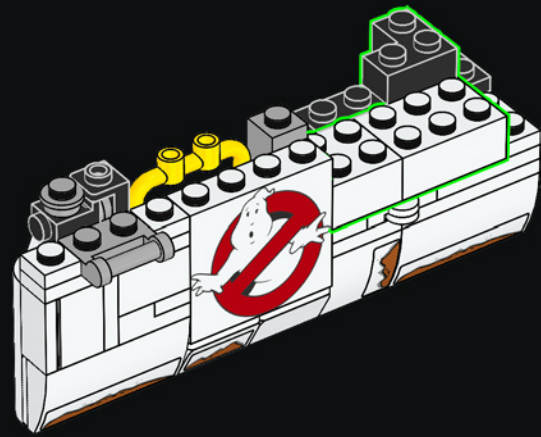

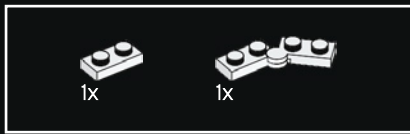

233

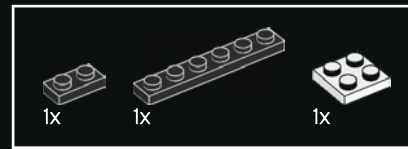
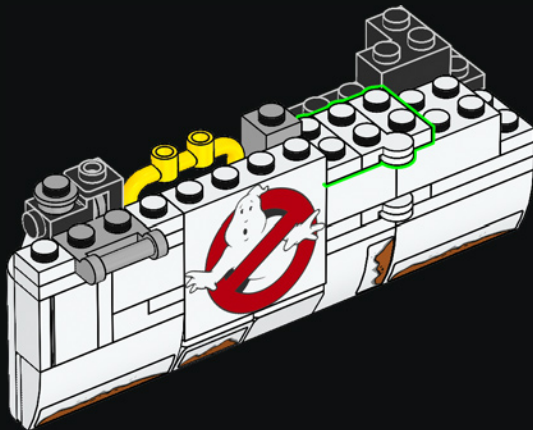

234

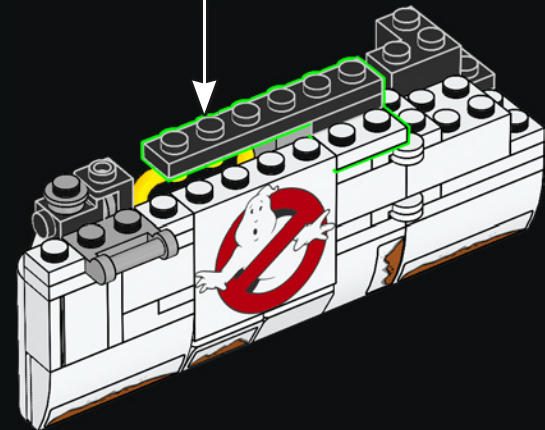
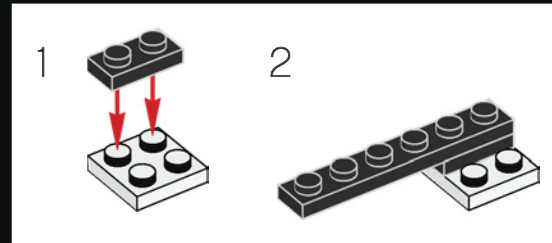

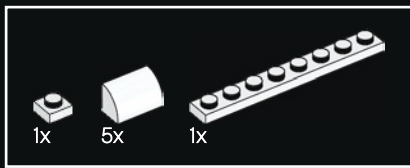

235

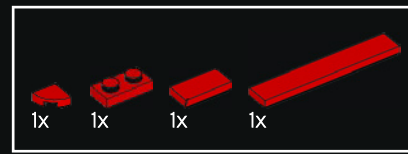
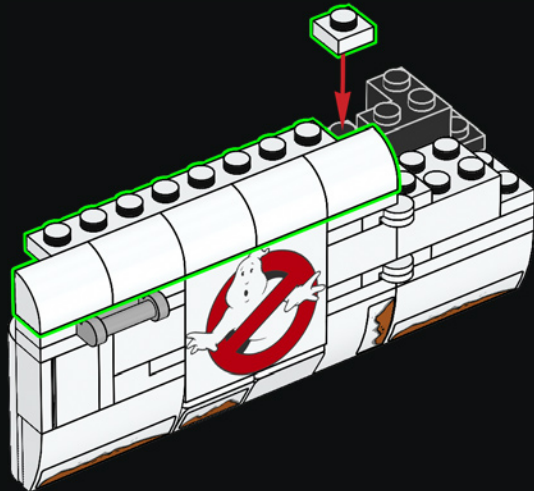

236

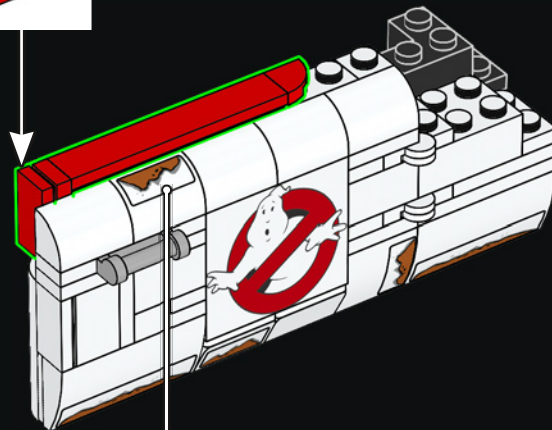
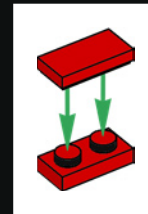

237

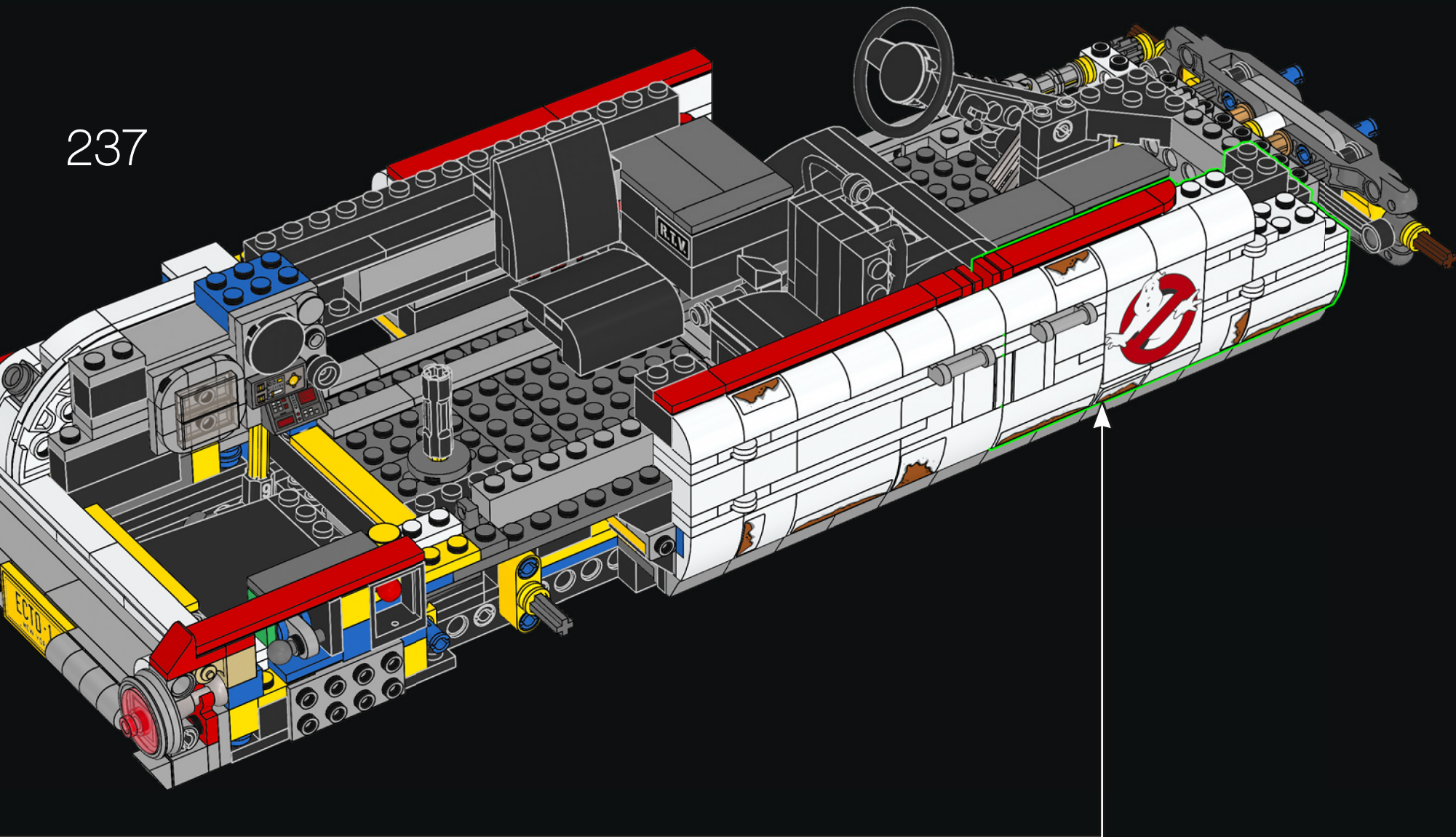

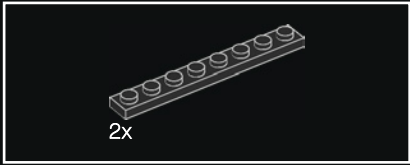
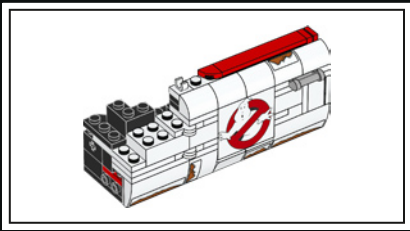

238

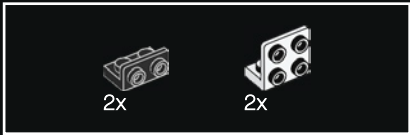
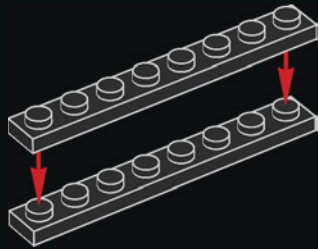

239

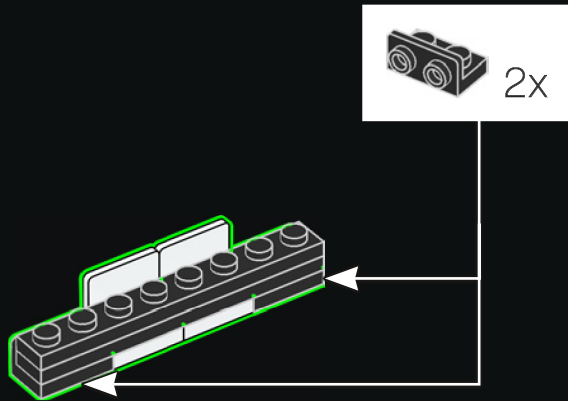

240

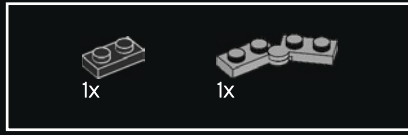
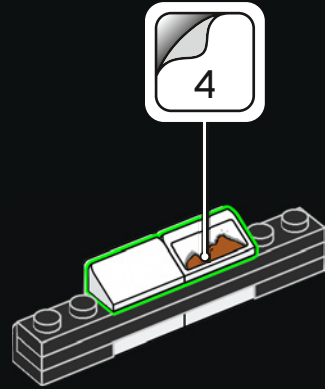

241

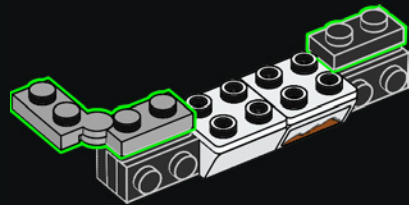



242

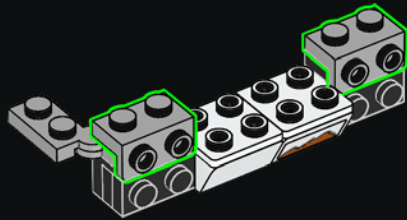

243

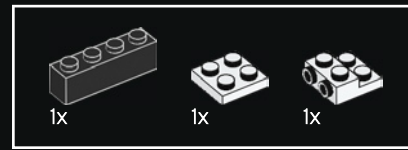
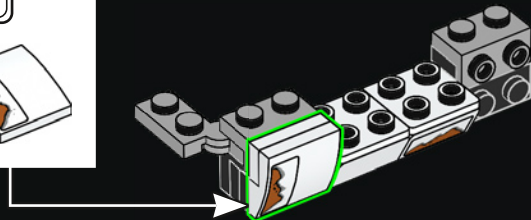
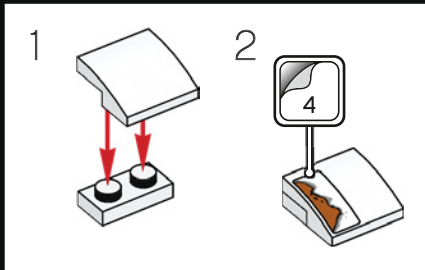

244

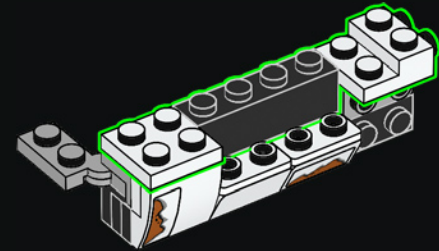

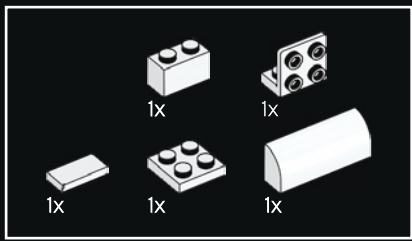

245

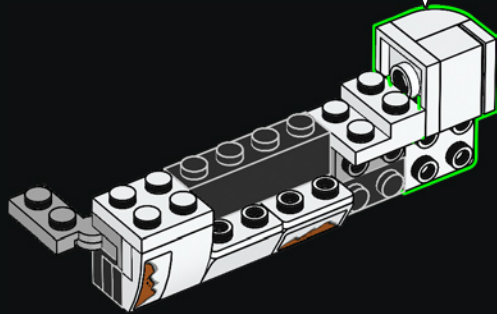
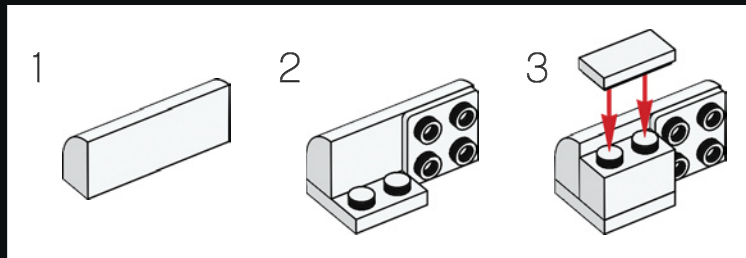

246

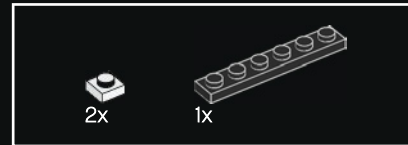
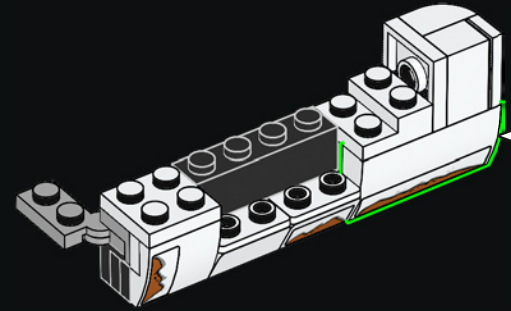
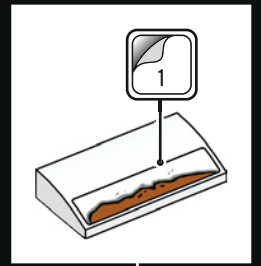

247

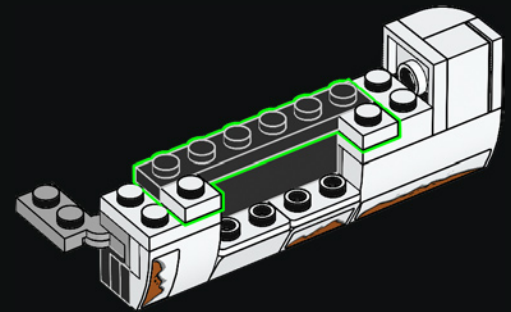

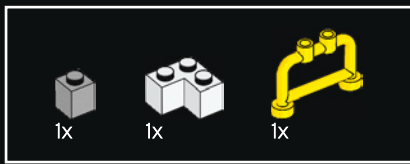

248

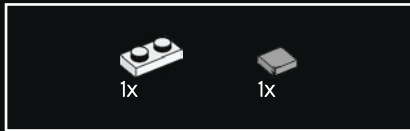
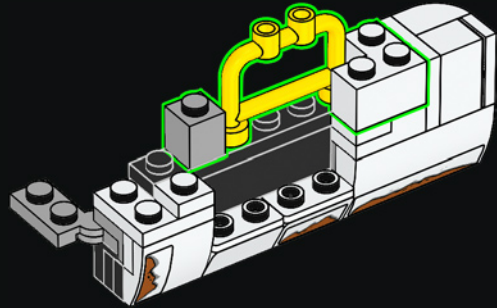

249

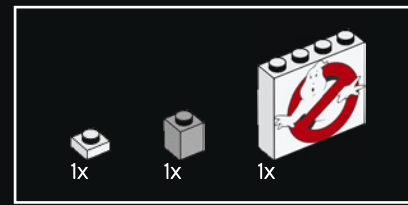
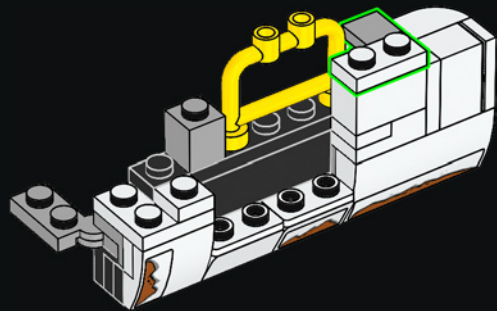

250

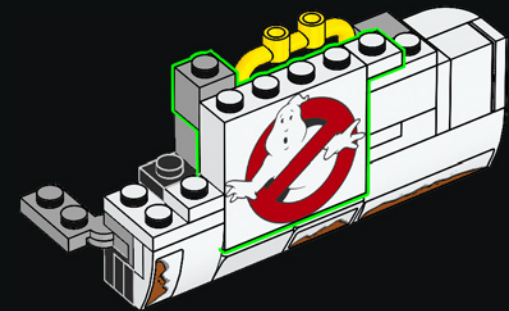

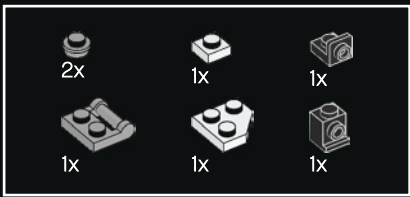

251

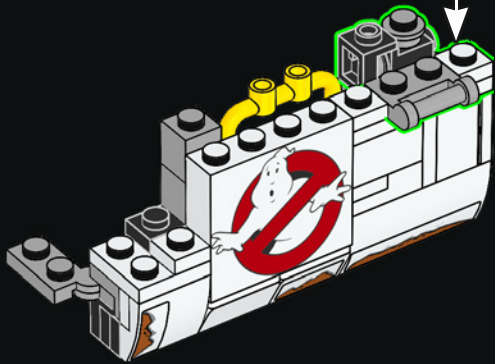
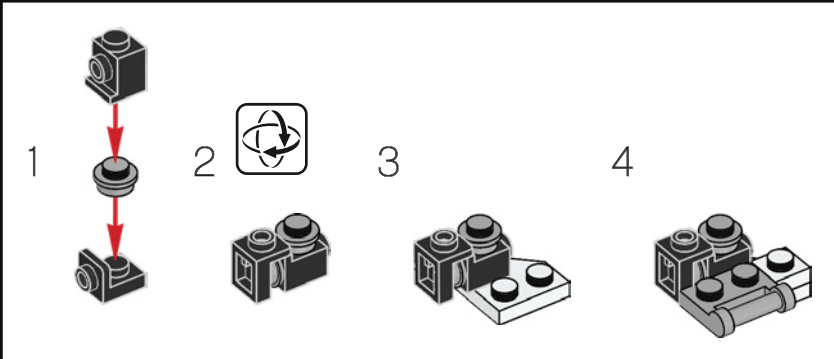

252

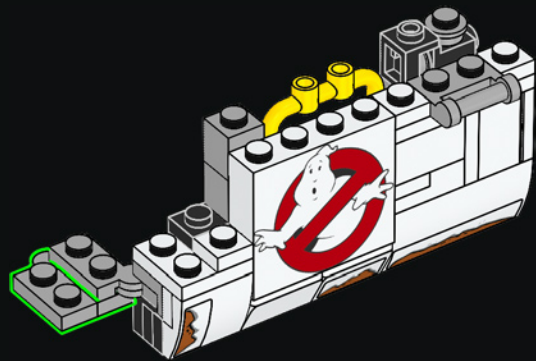

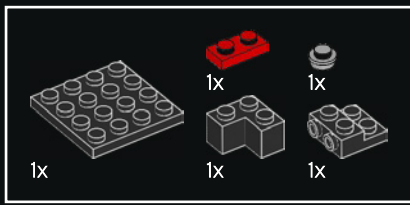

253

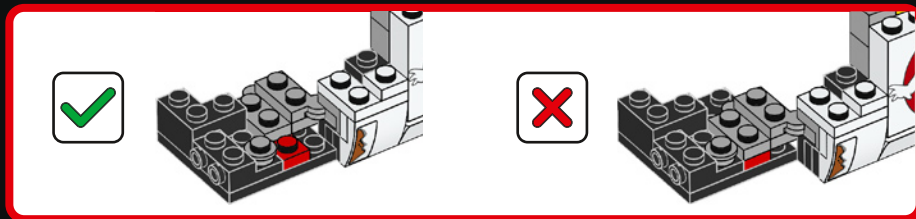
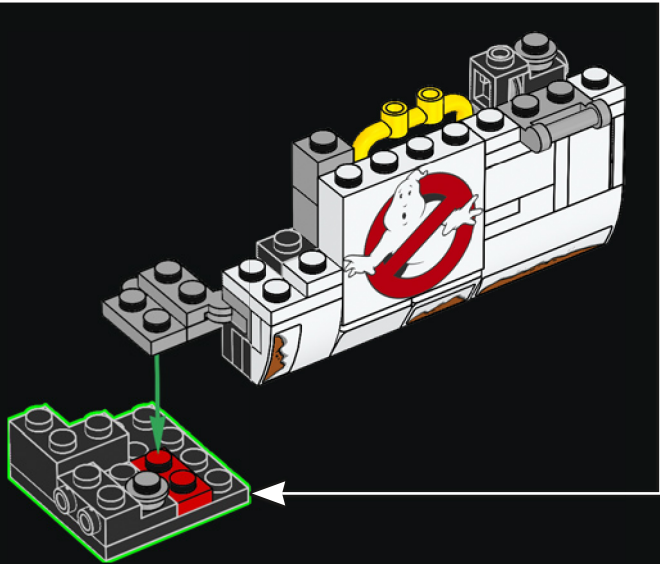
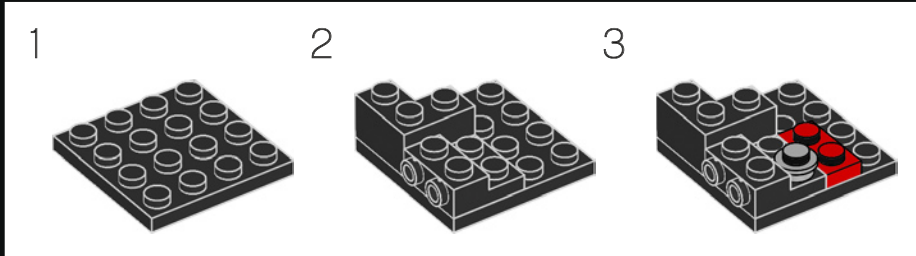

254

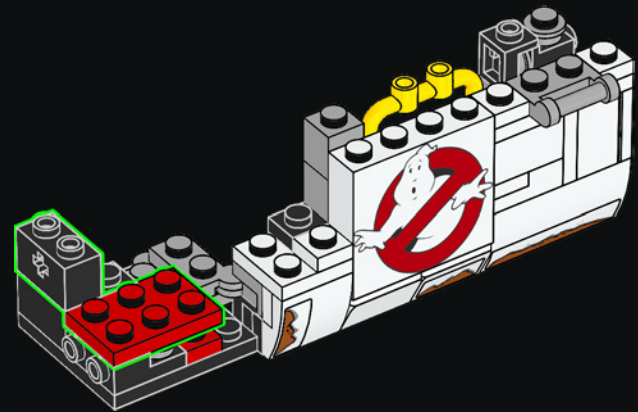

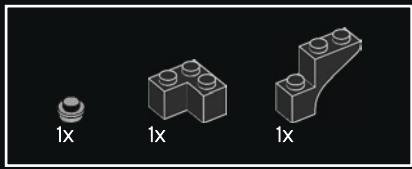

255

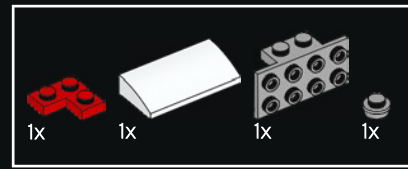
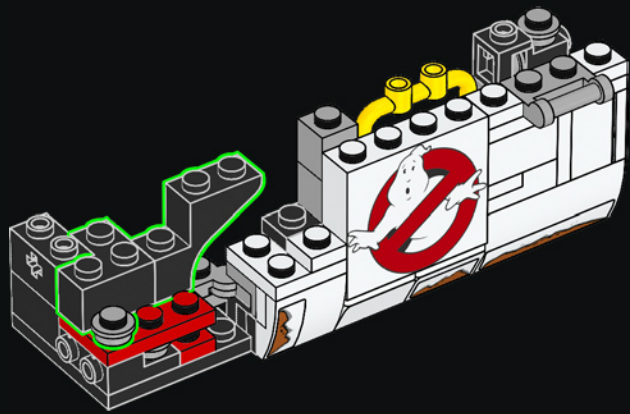

256

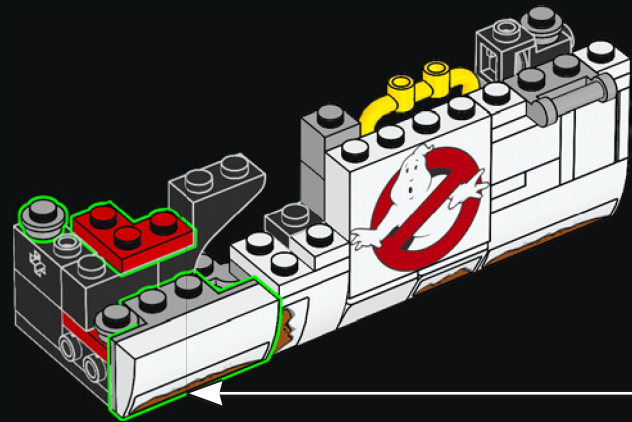
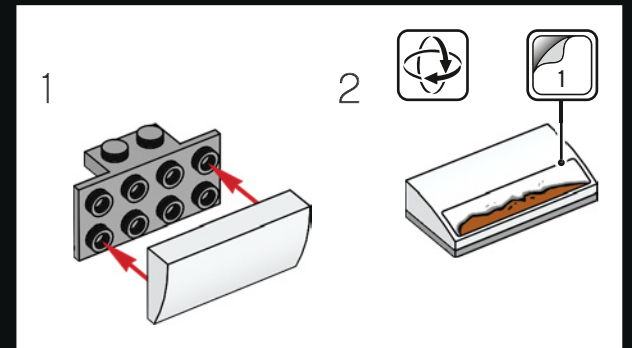



257

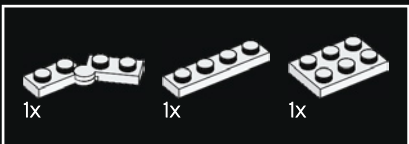
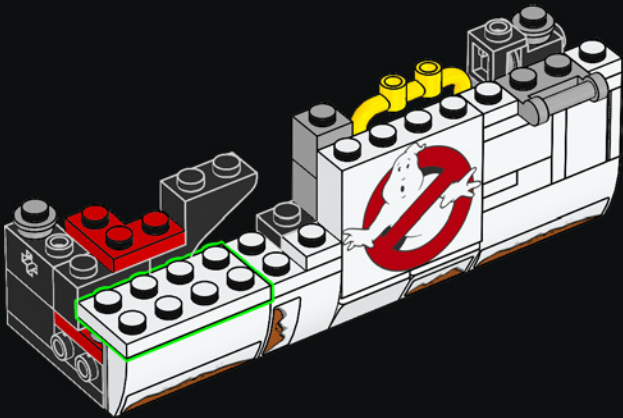

258

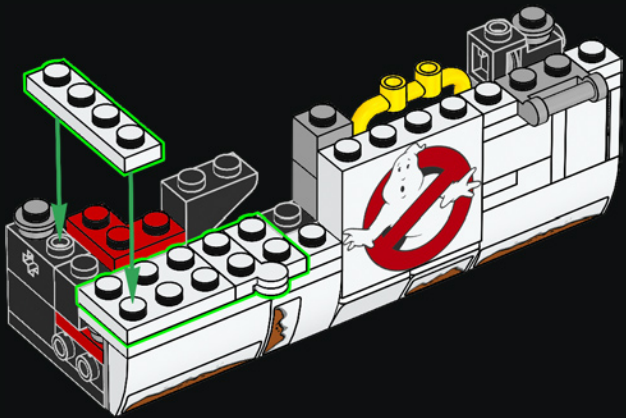

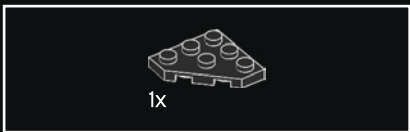

259

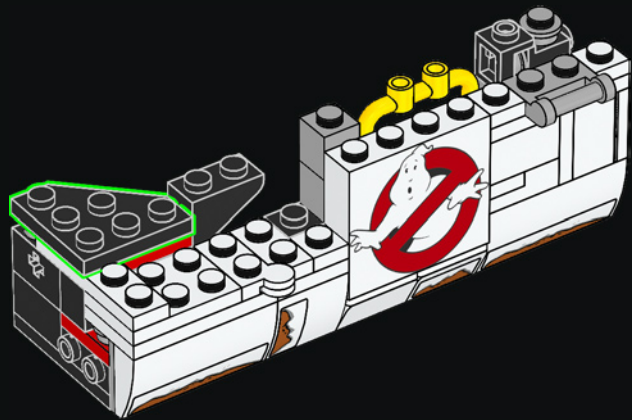

260

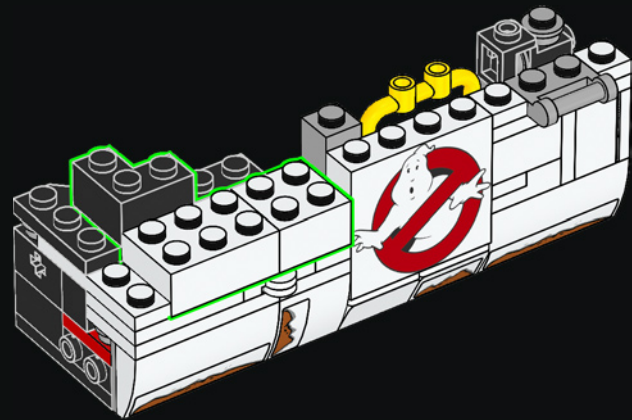

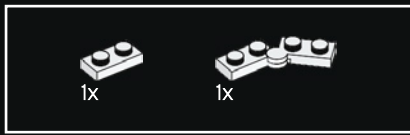

261

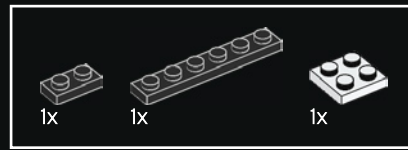
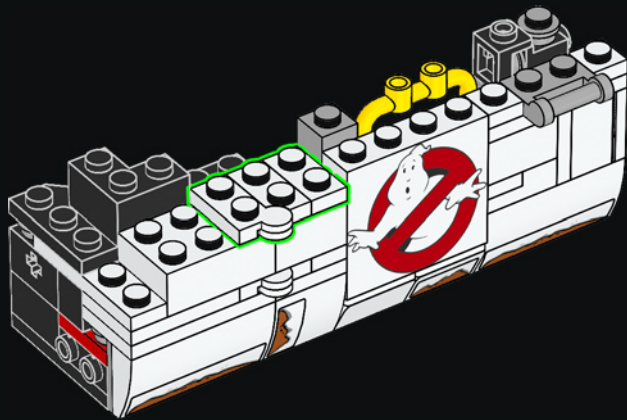

262

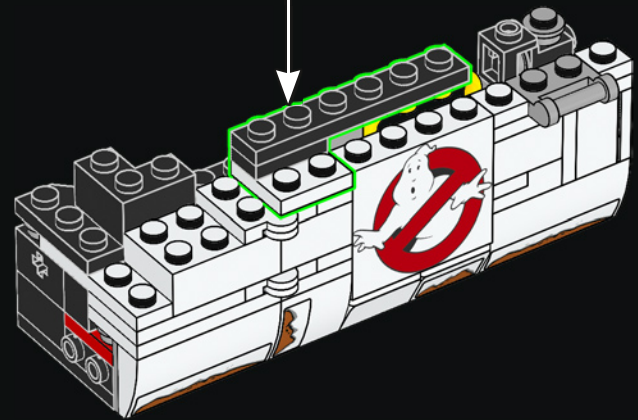
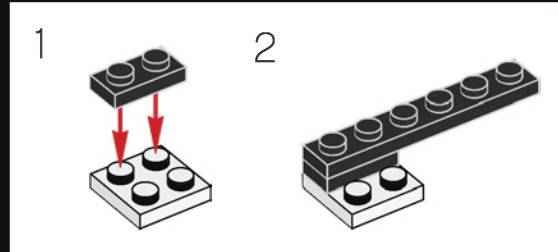

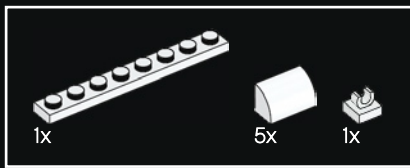

263

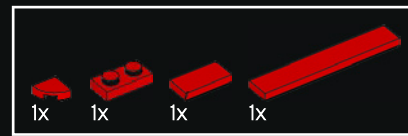
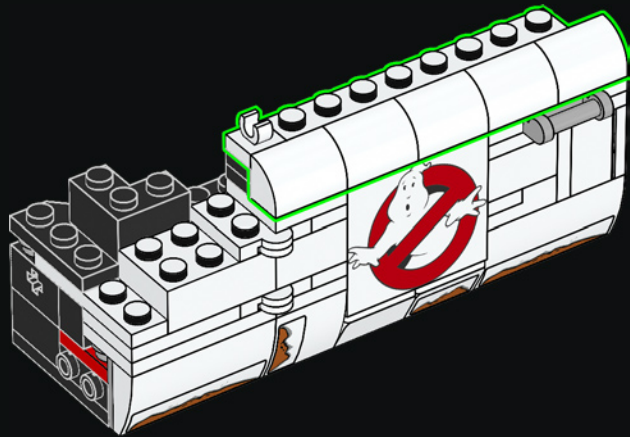

264

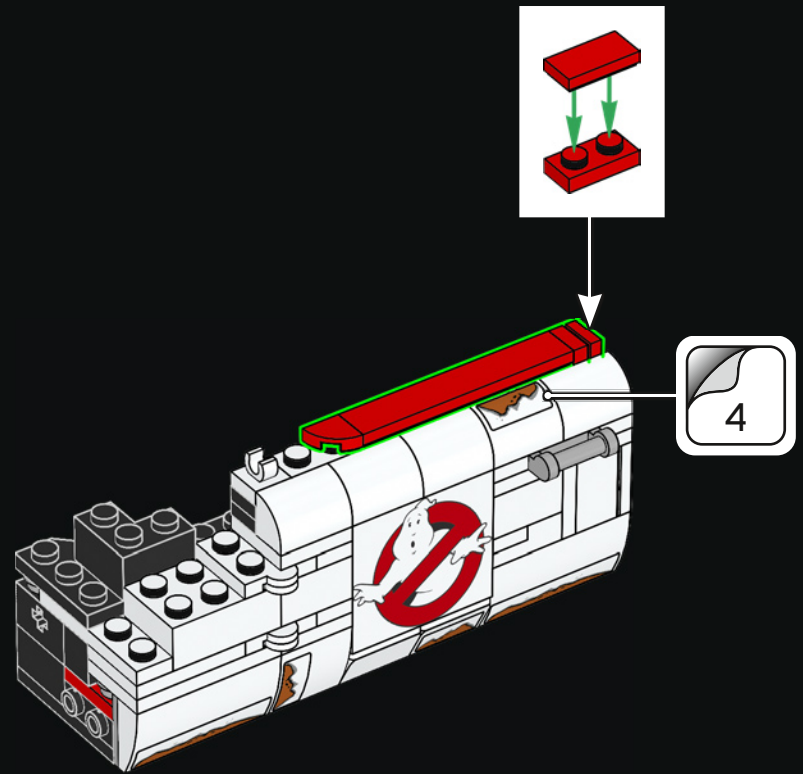

265

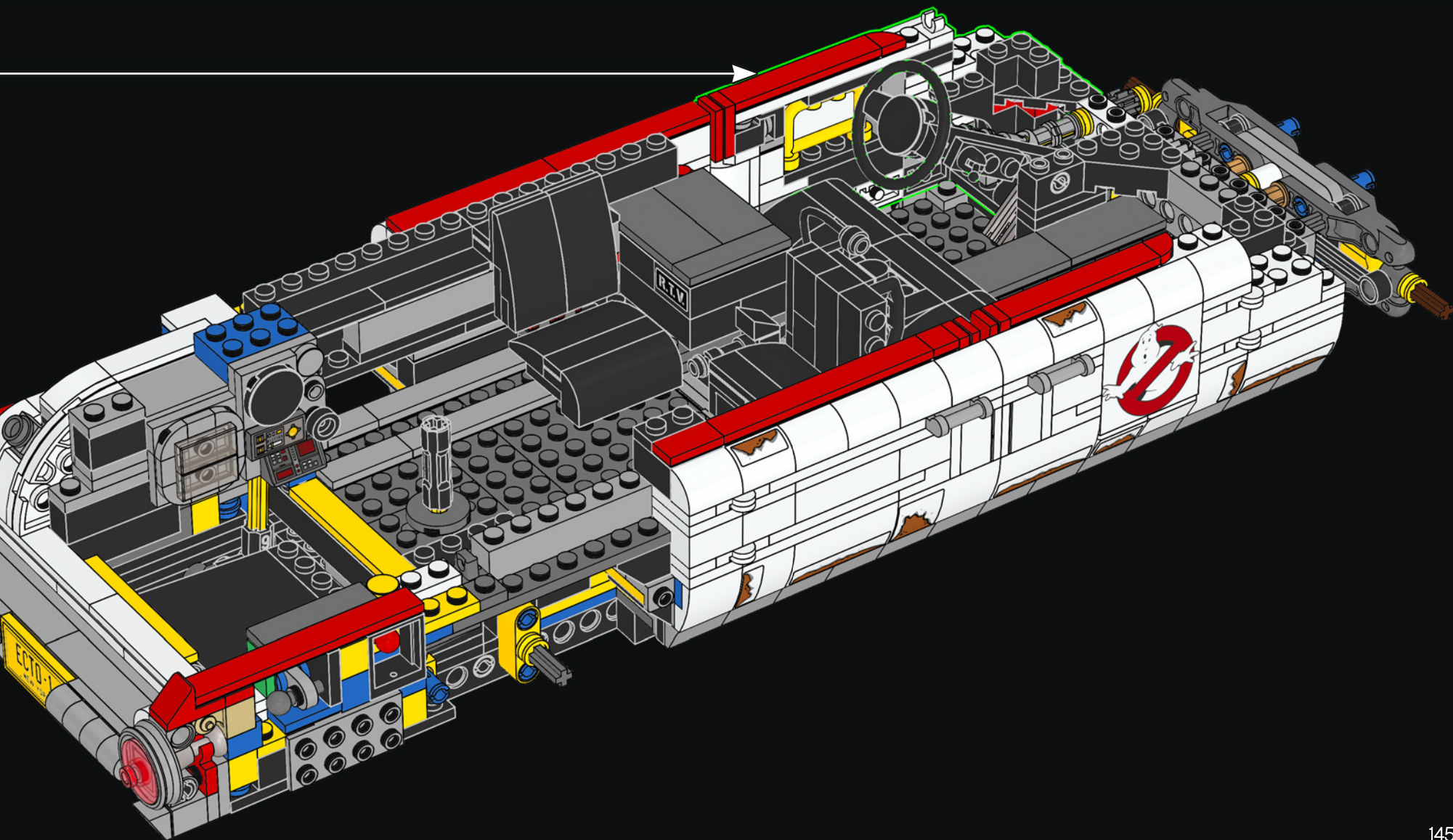

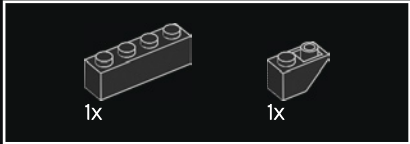
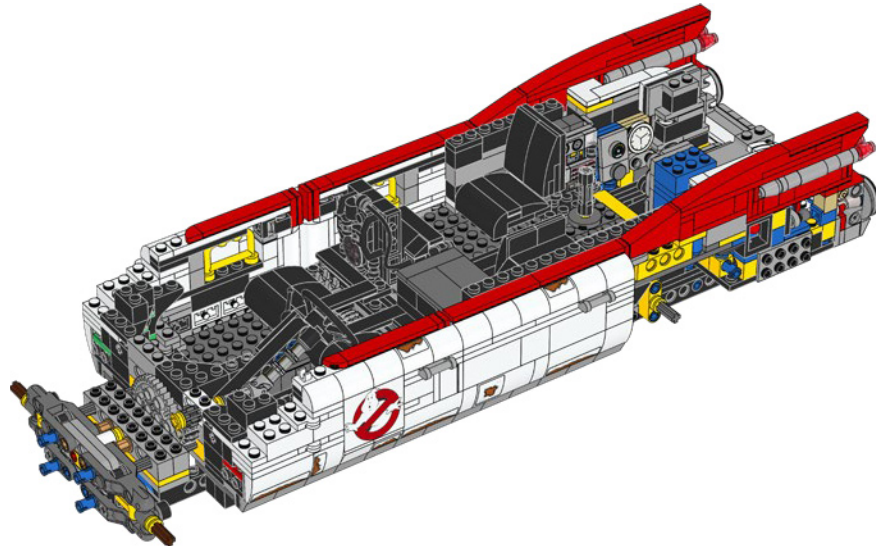
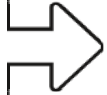

266

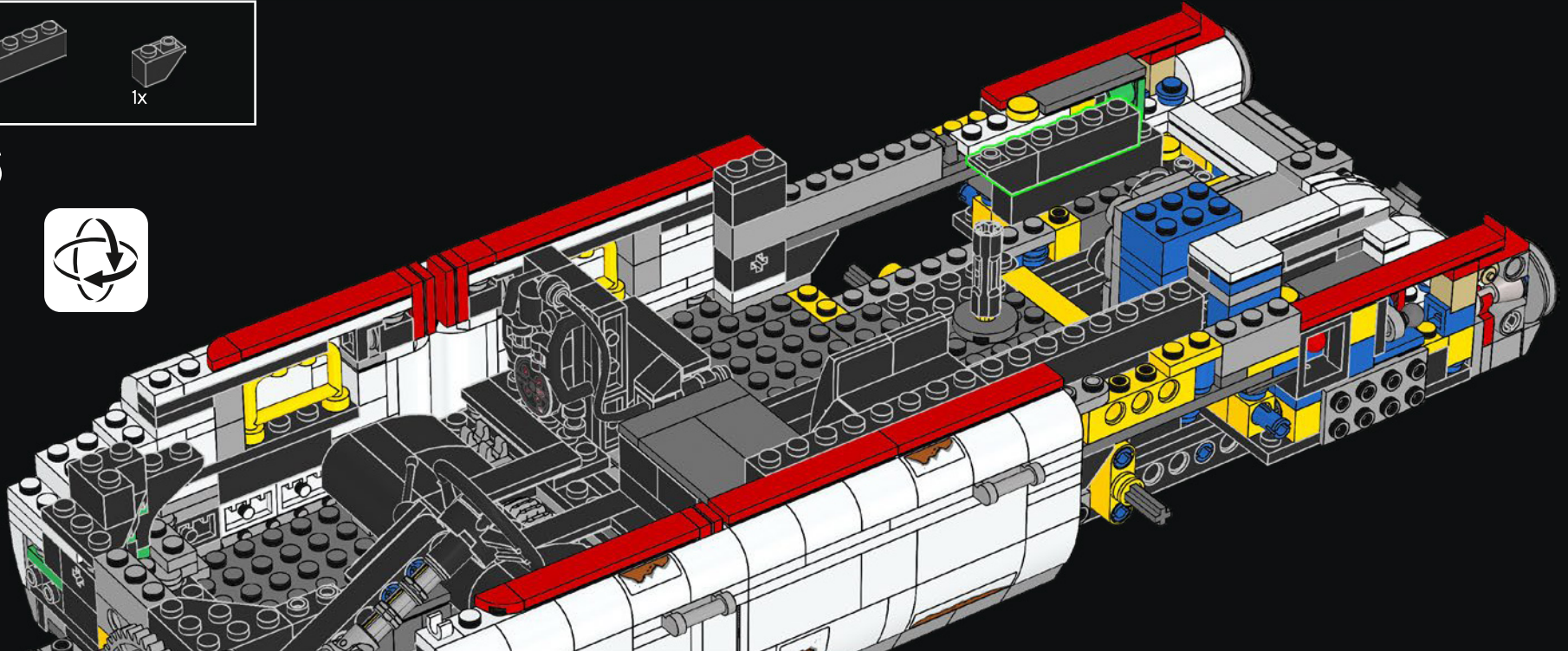

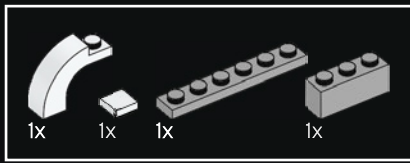

267

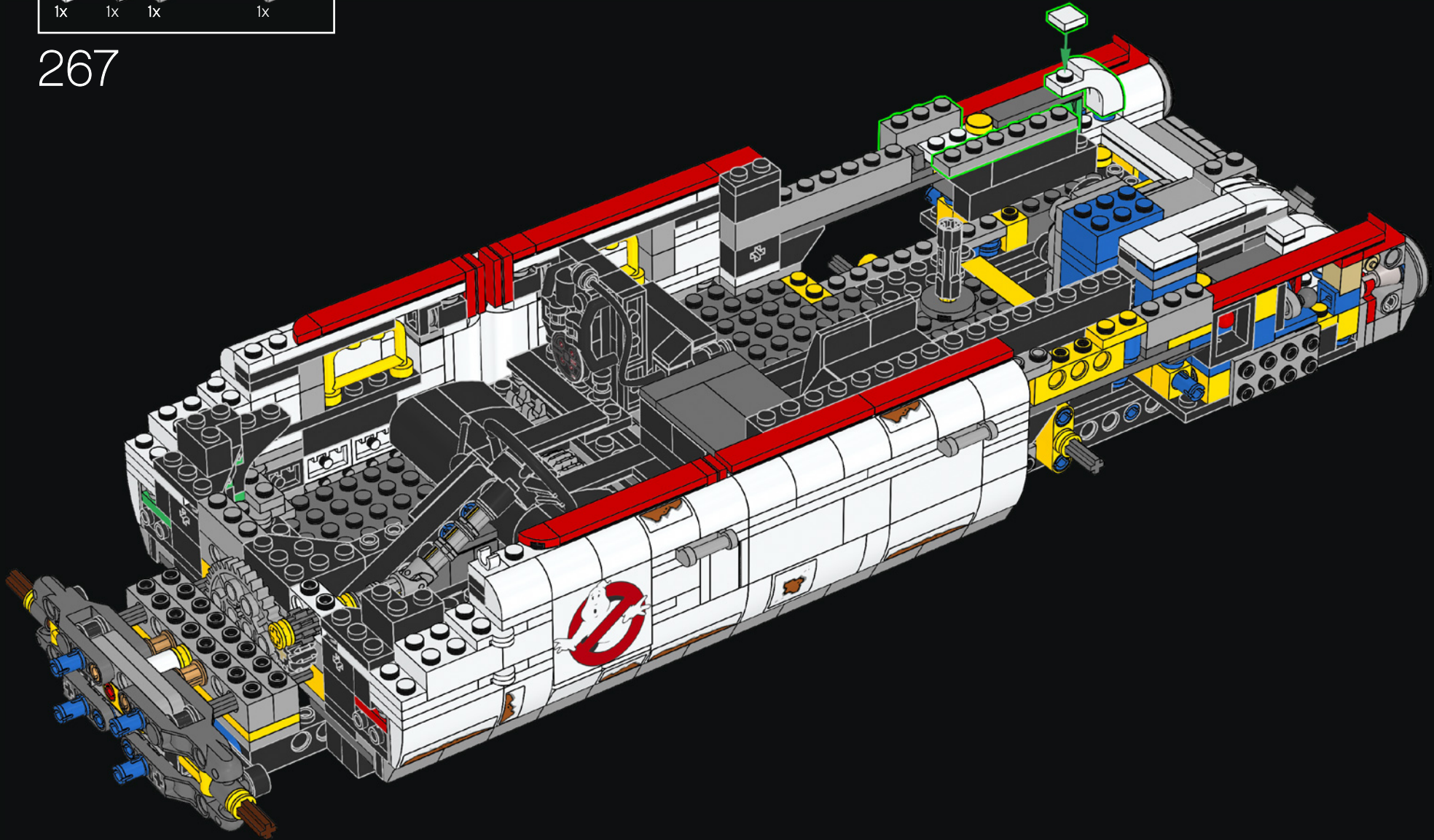

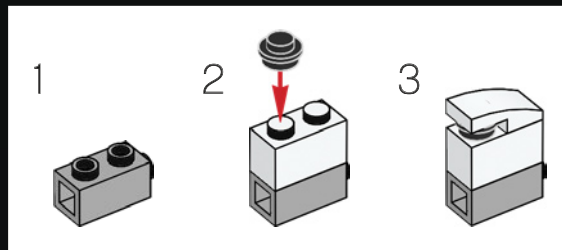
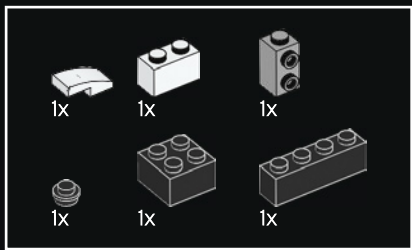

268

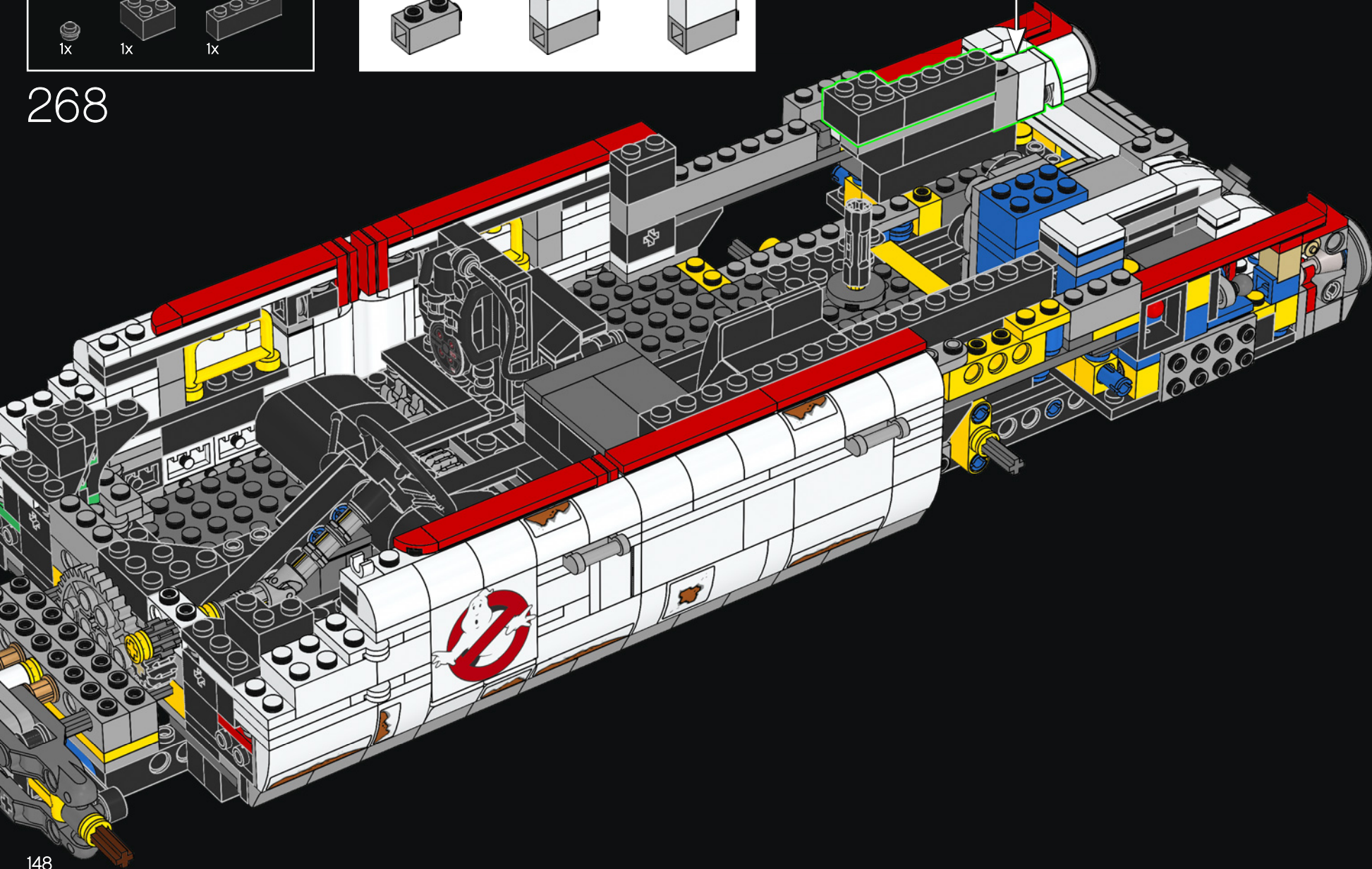

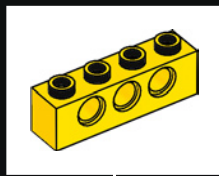
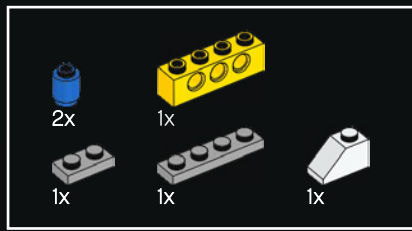

269

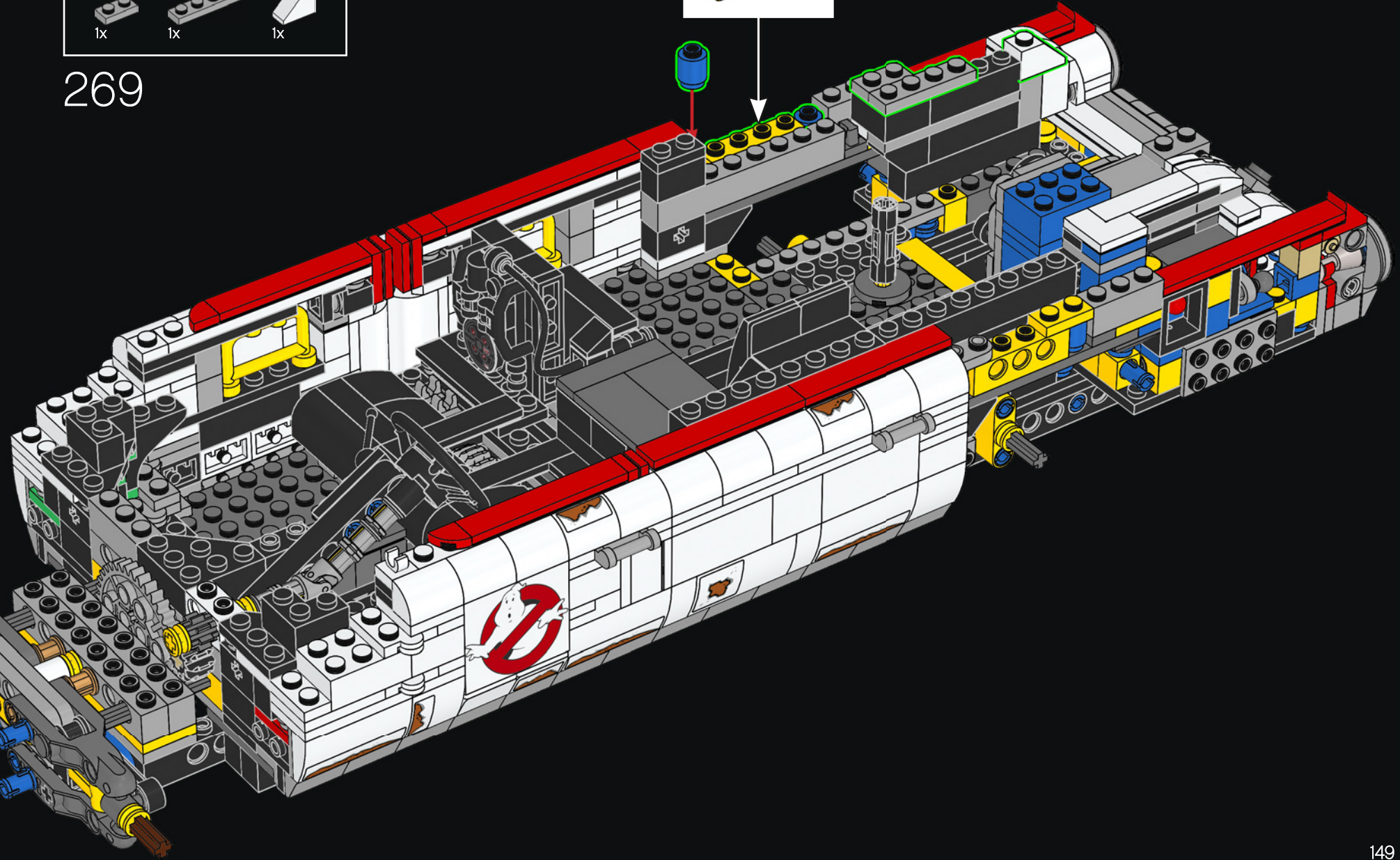

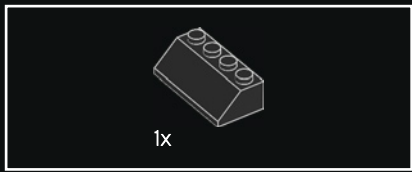

270

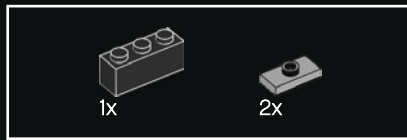
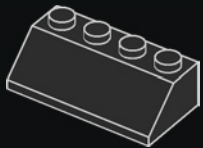

271

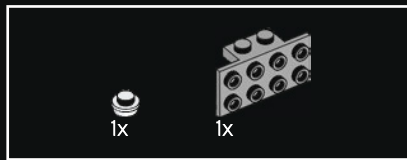
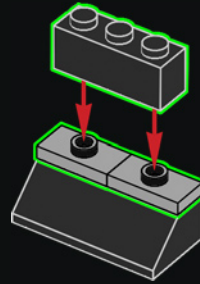

272

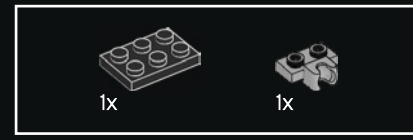
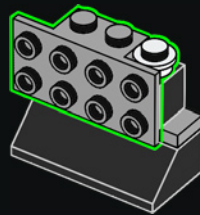

273

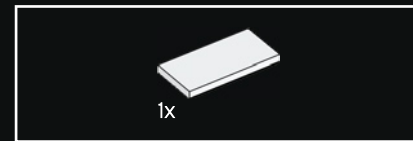
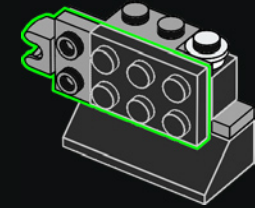

274

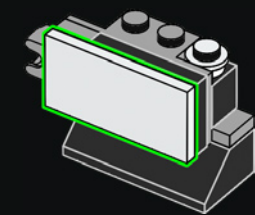

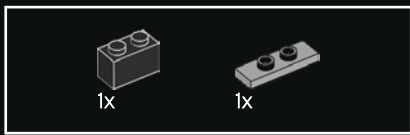

275

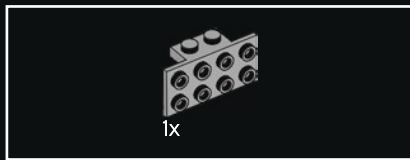
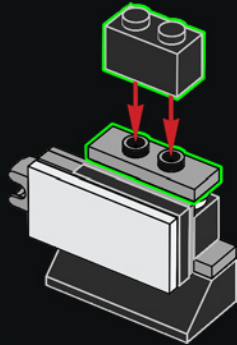

276

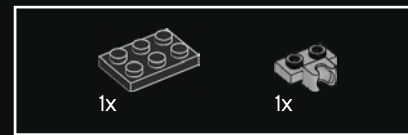
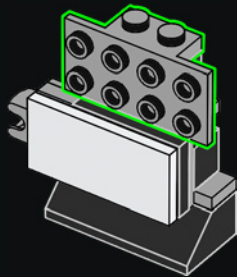

277

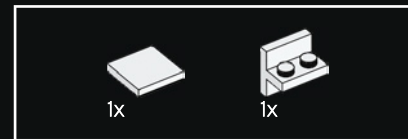
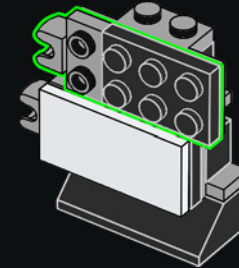

278

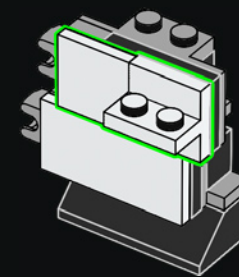

279

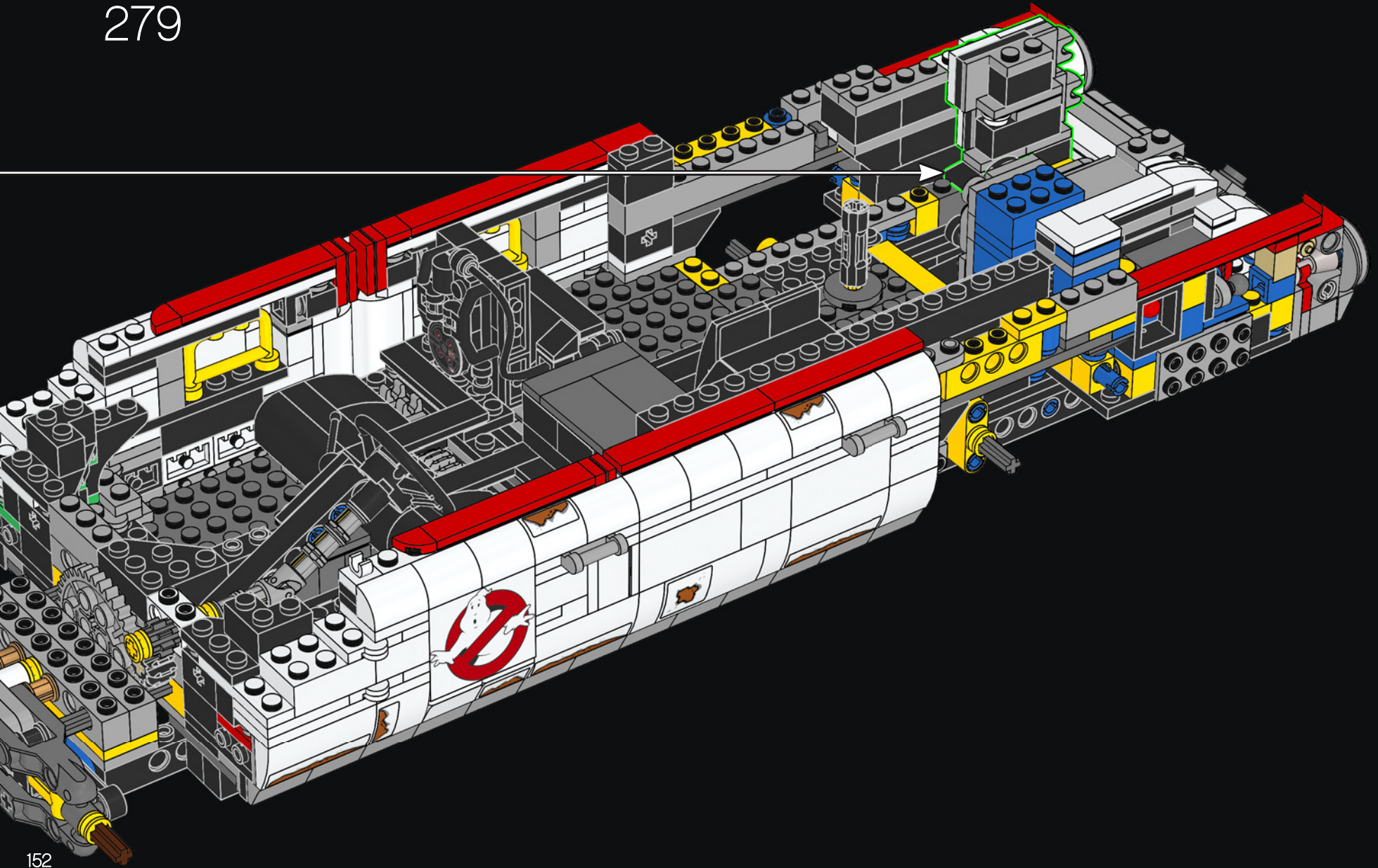

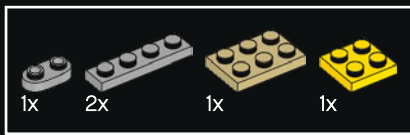

280

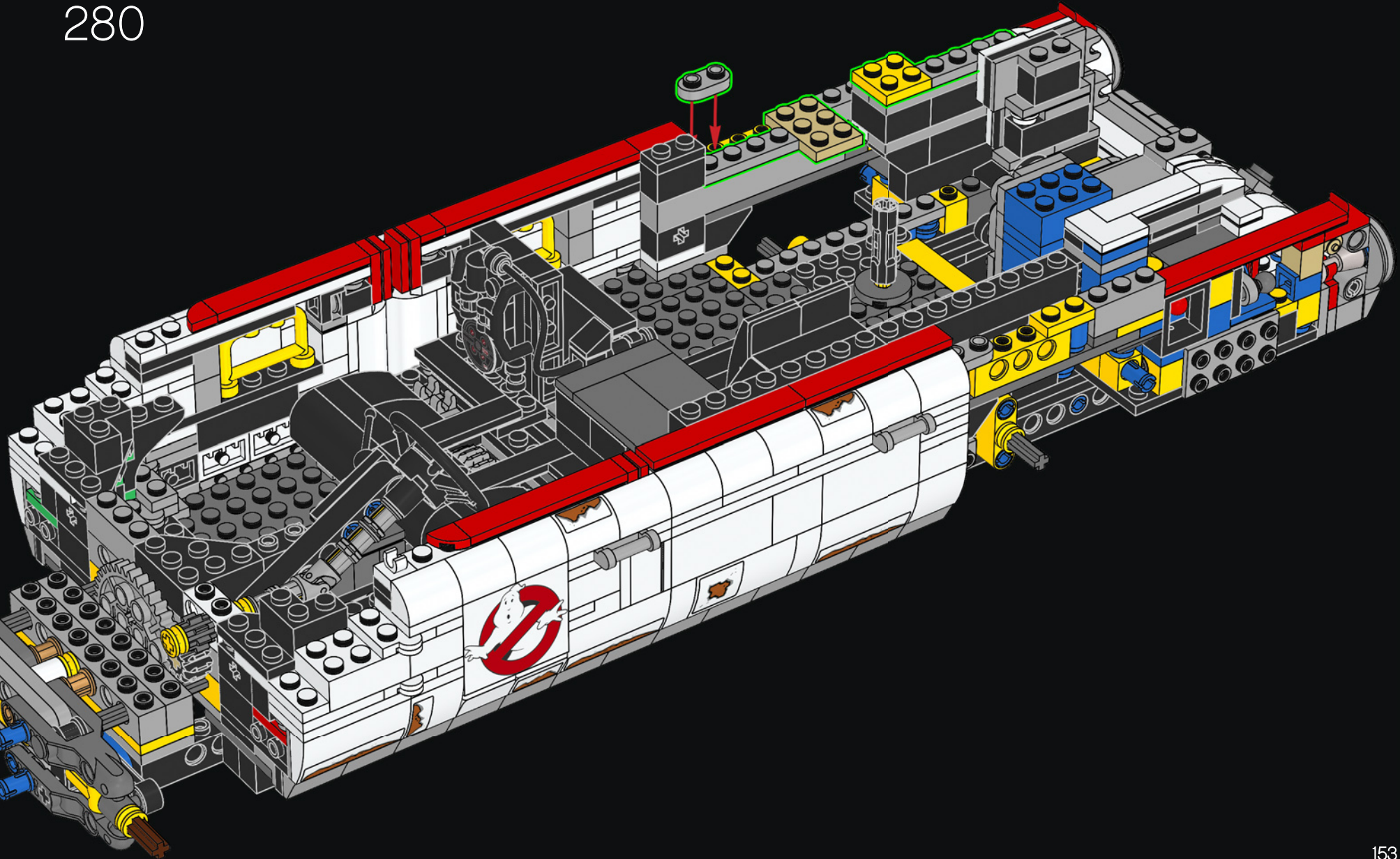

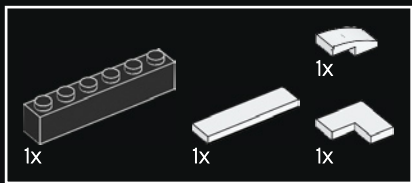

281

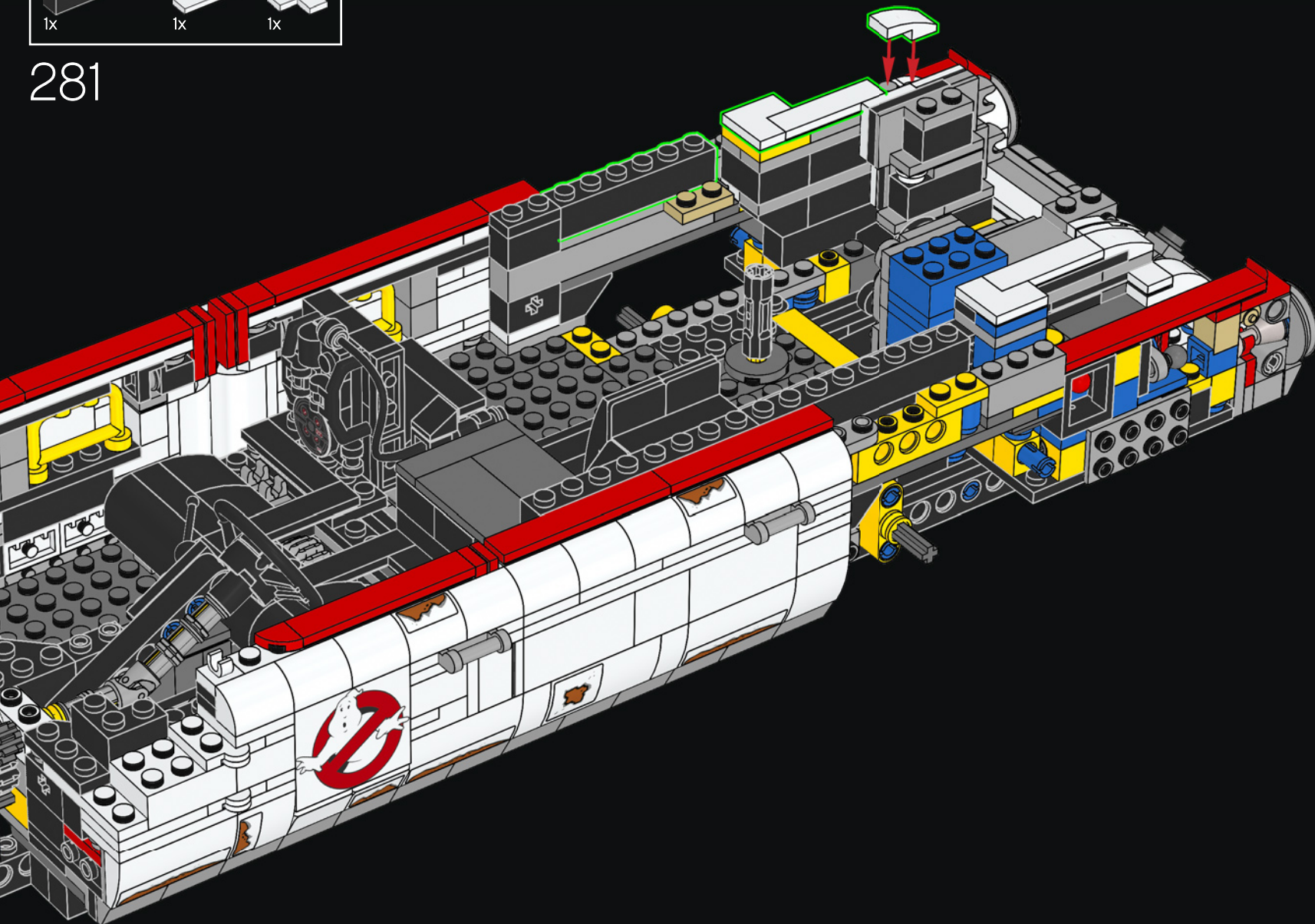

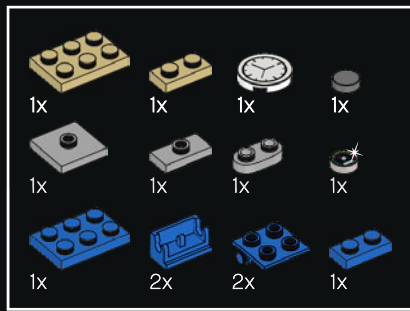

282

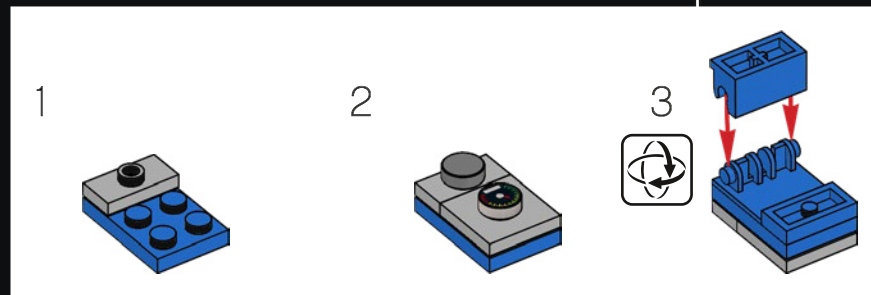
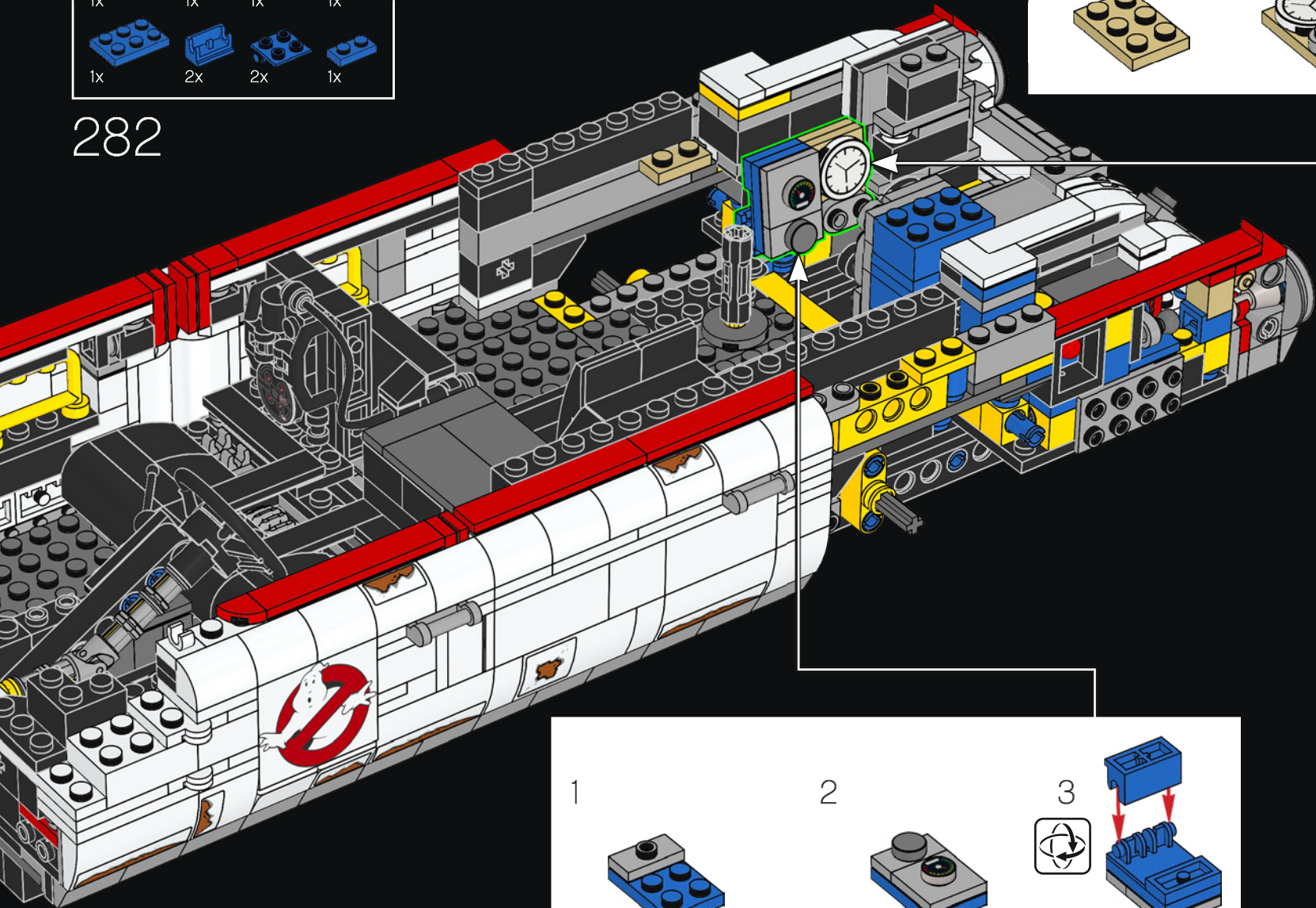
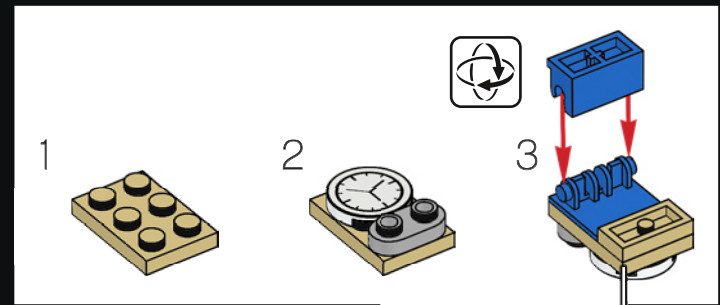



283

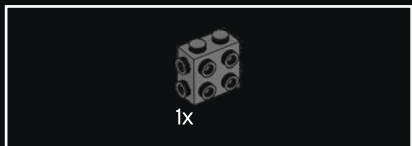
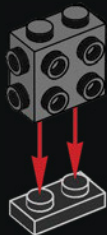

284

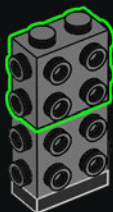

285

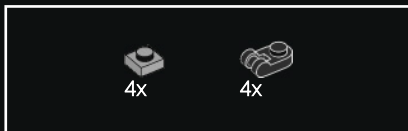

286

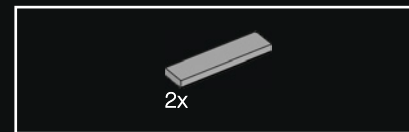

287

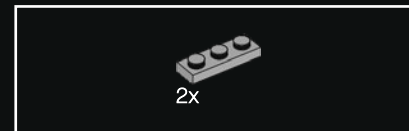
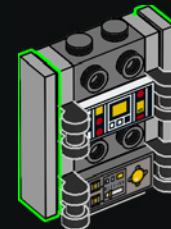

288

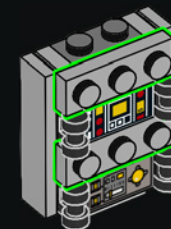

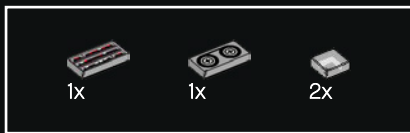

289

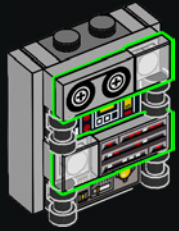

290

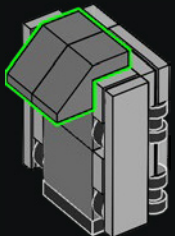

291

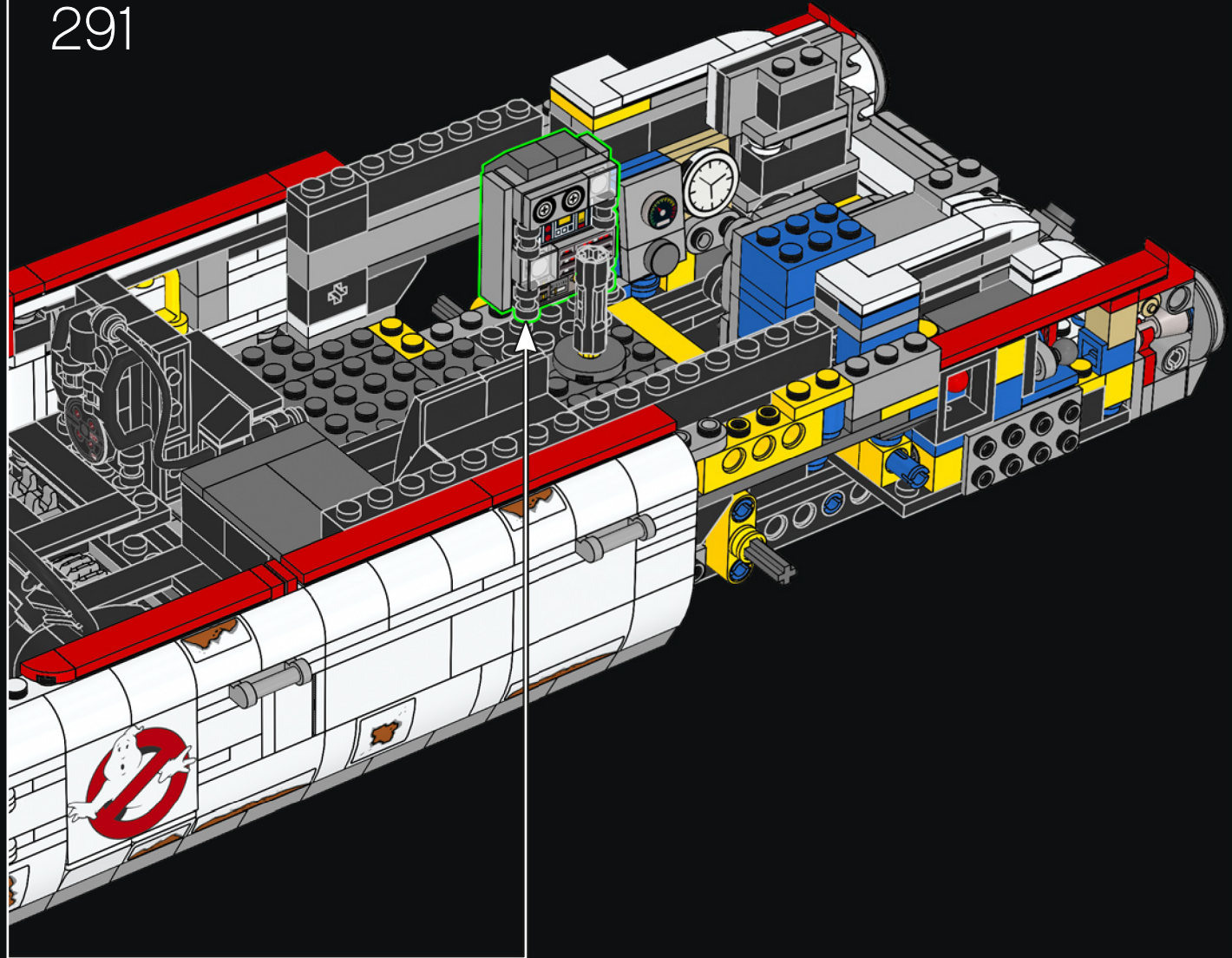



292

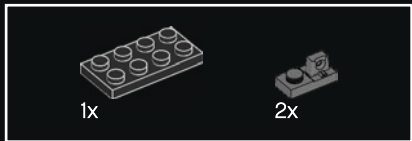
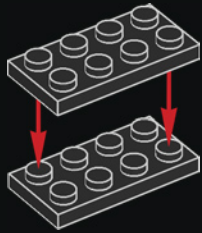

293

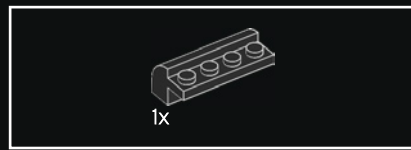
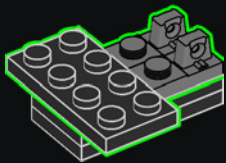

294

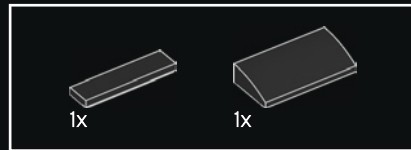
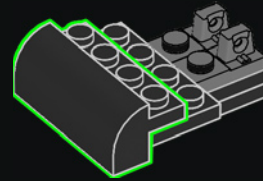

295

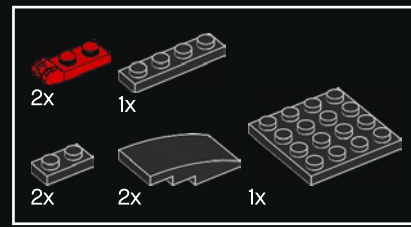
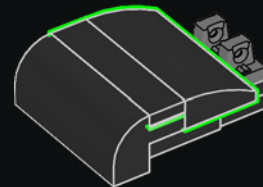

296

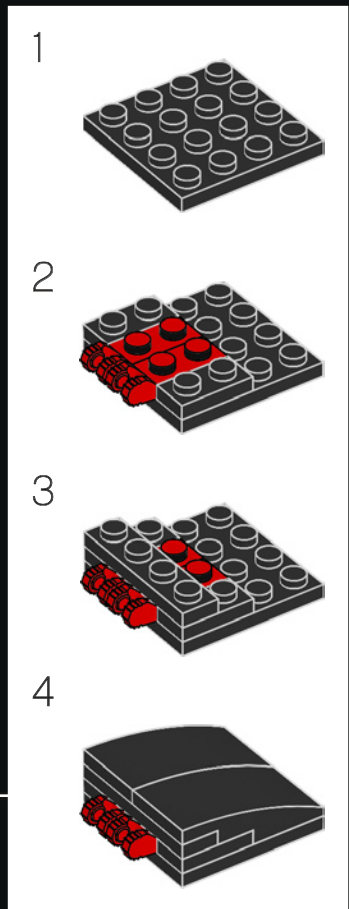
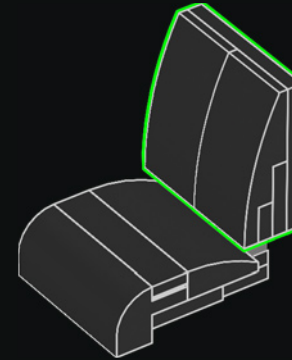

297

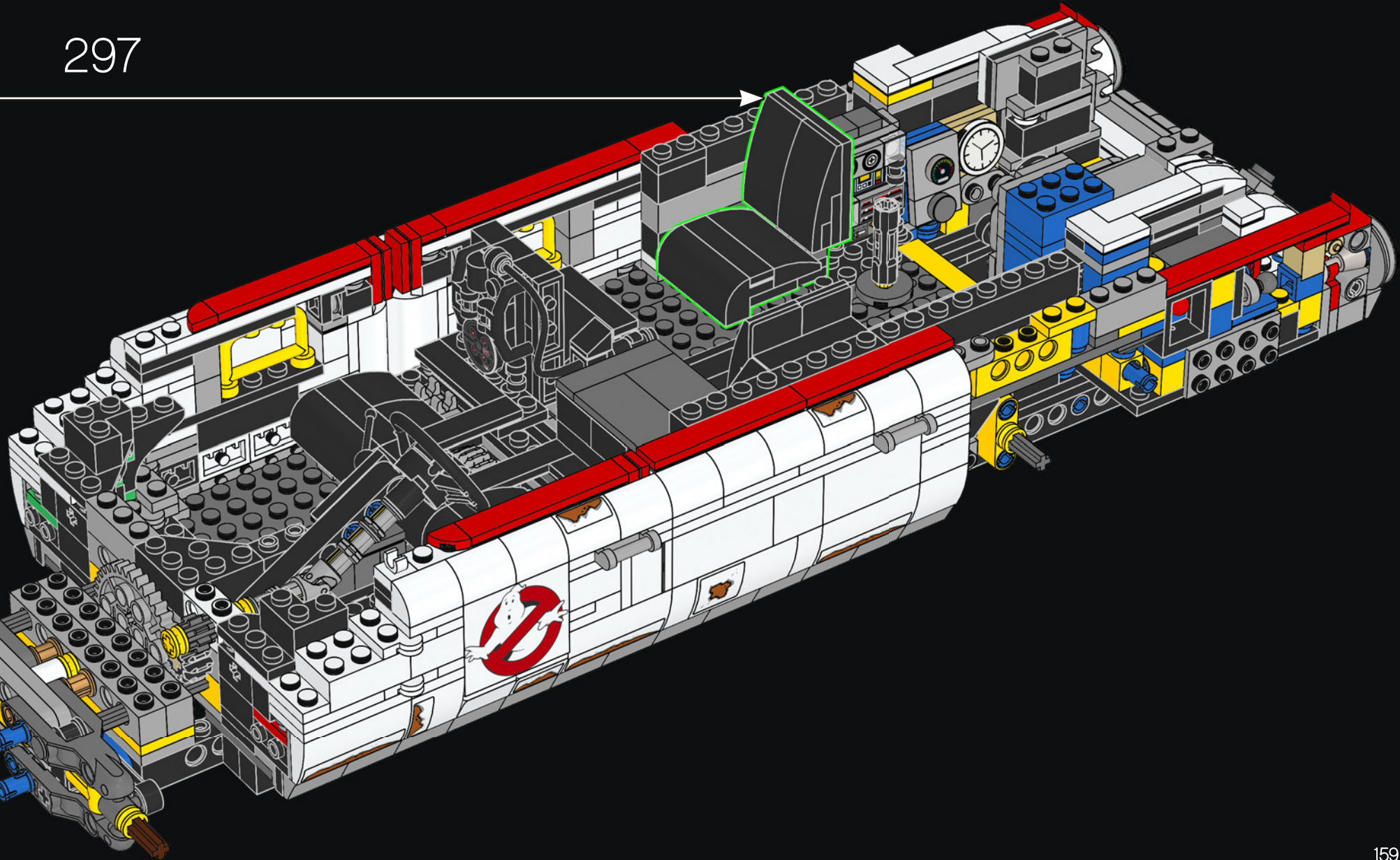

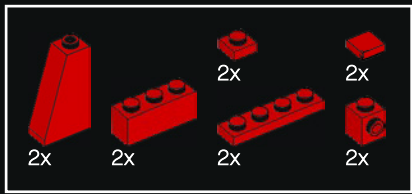

298

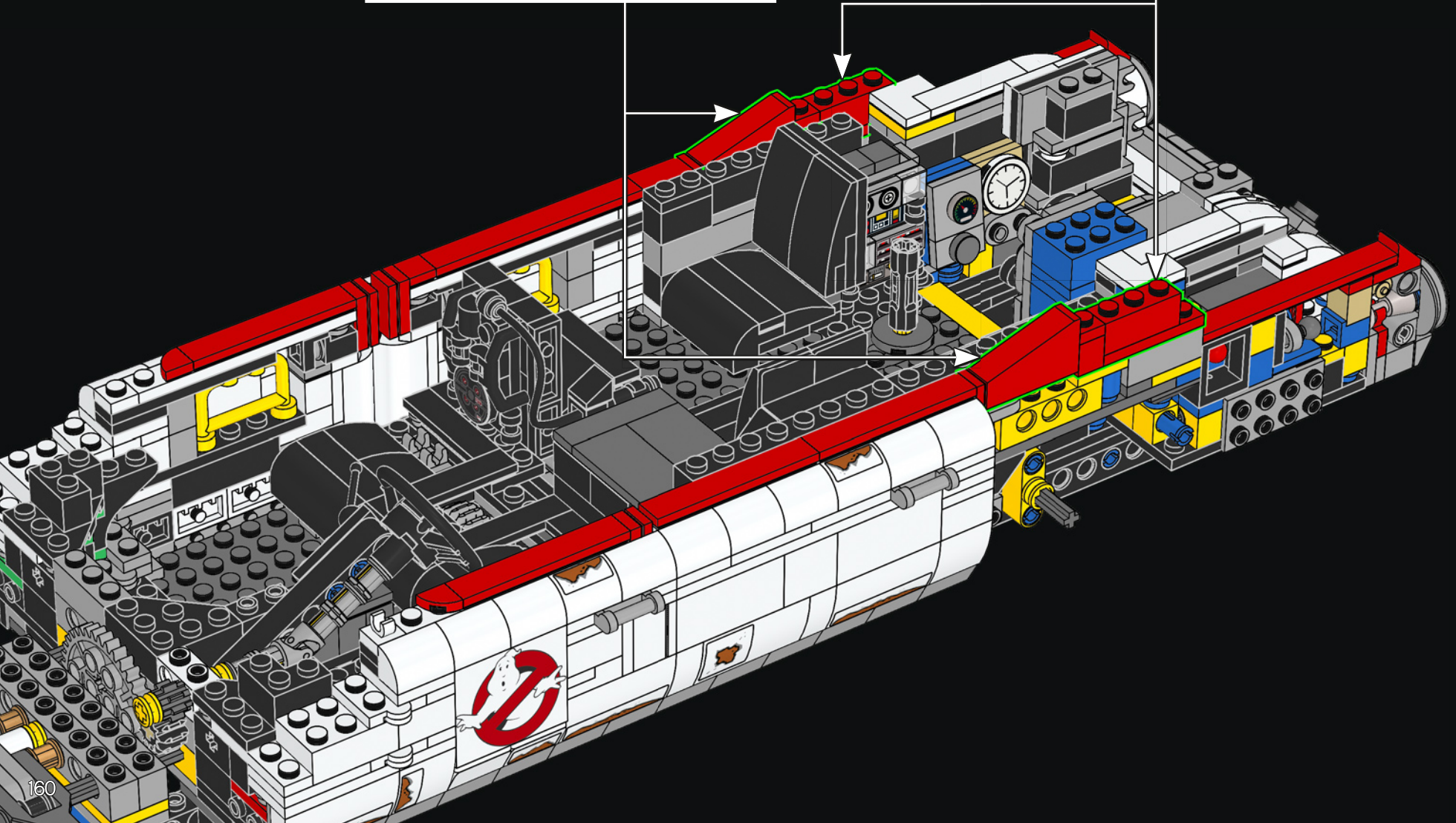
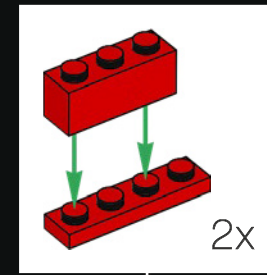
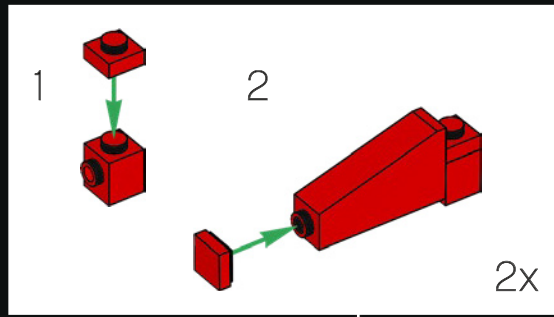



299

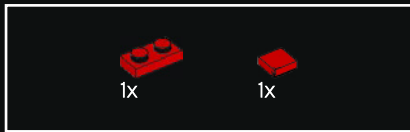
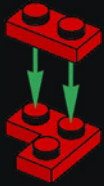

300

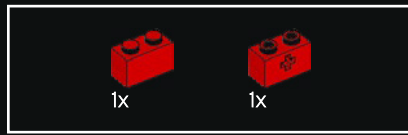
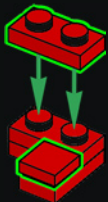

301

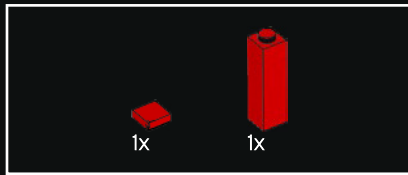
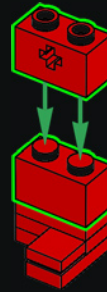

302



303



304

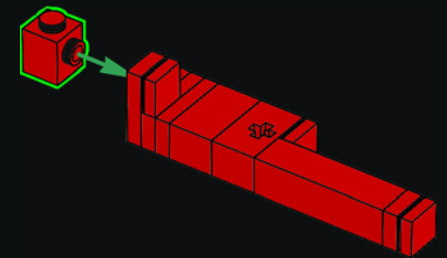

305

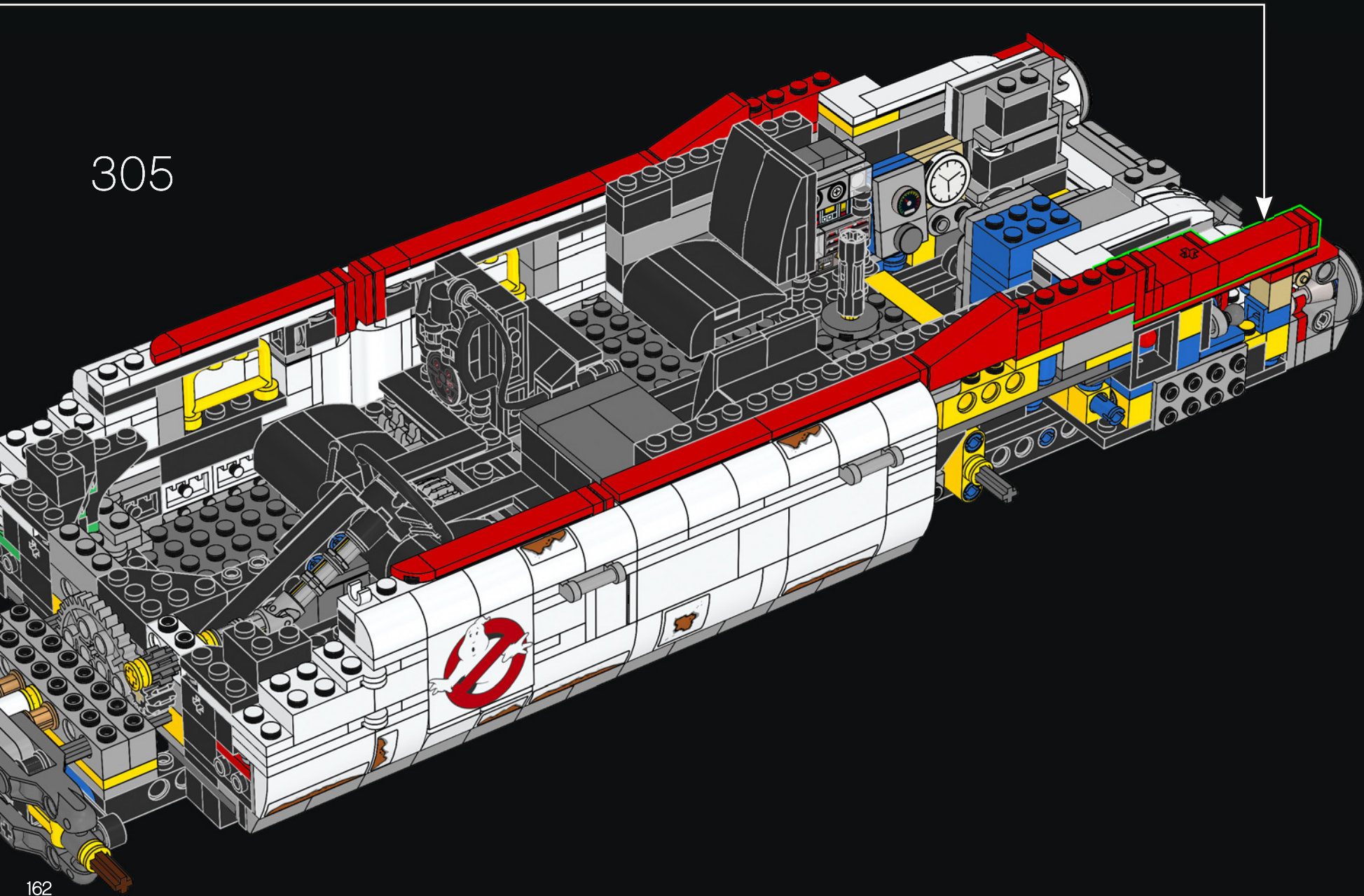



306

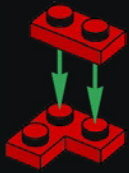

307

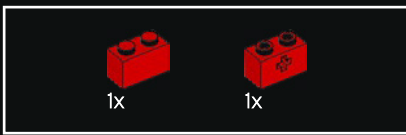
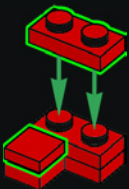

308

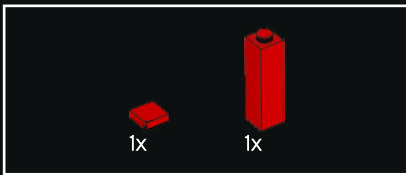
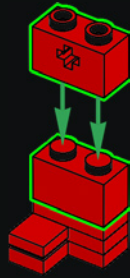

309

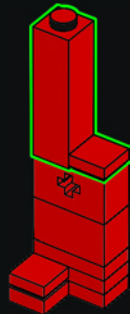

310

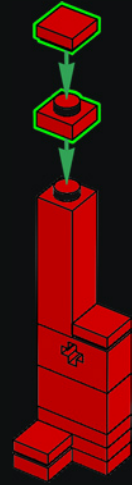

311

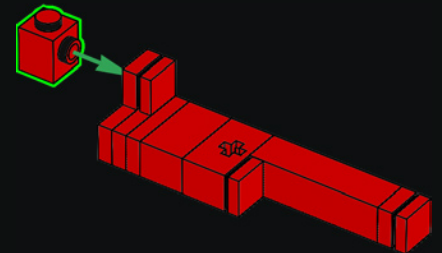

312

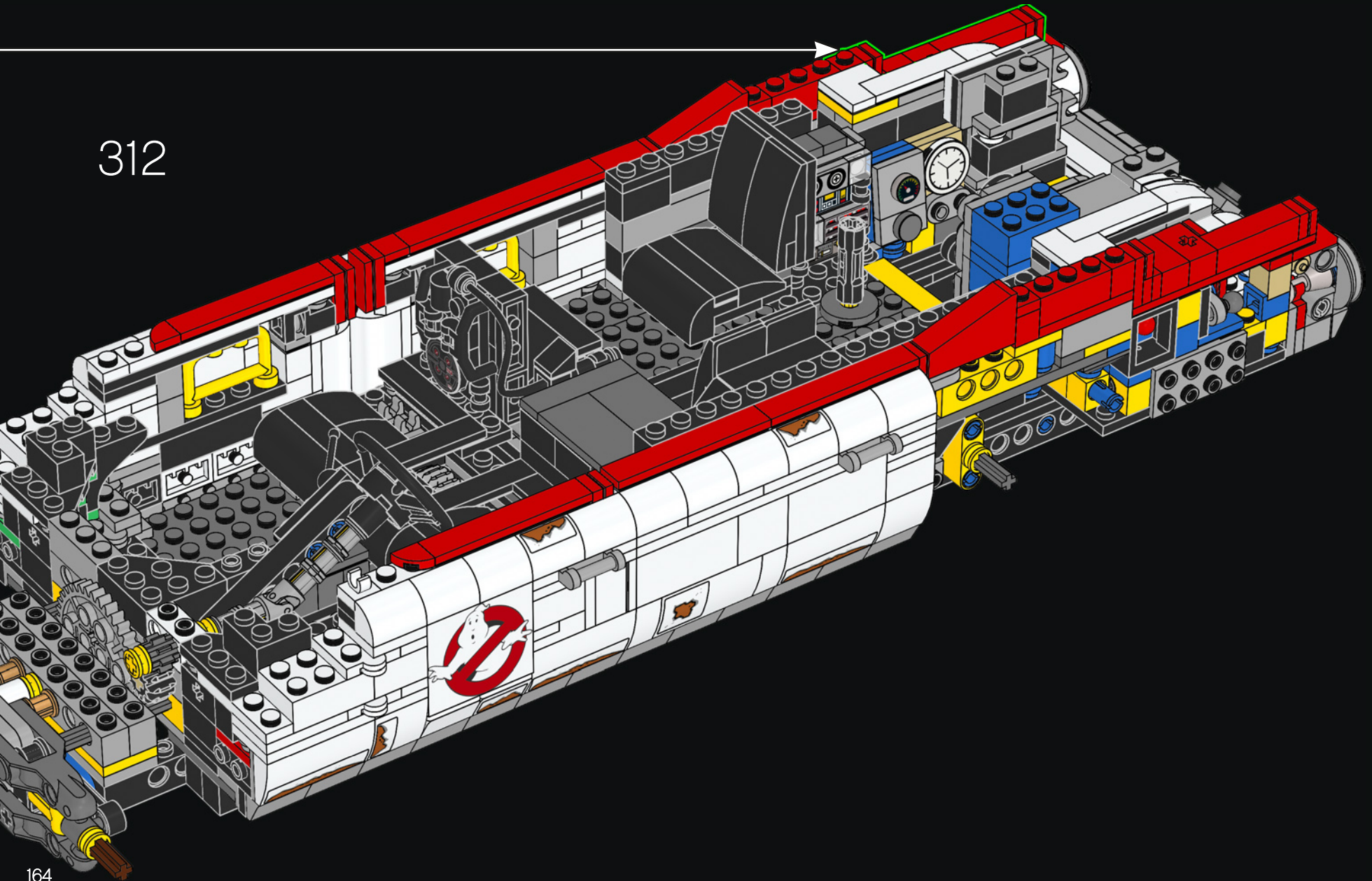

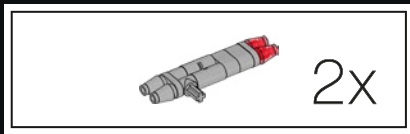

313

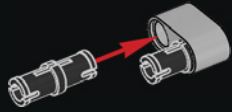

314

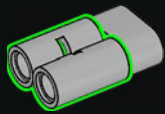

315

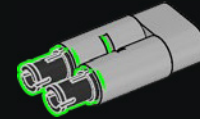

316

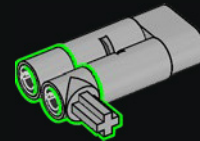



317

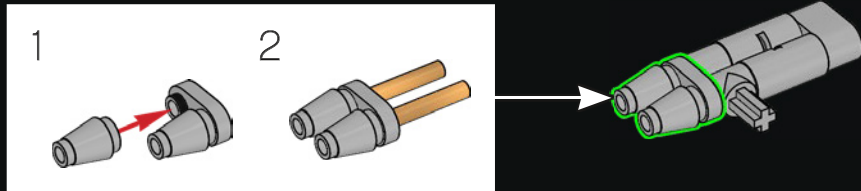

318

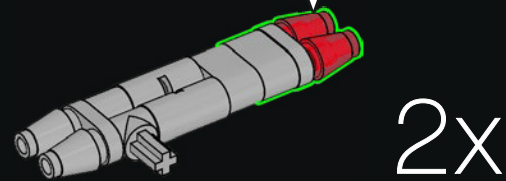
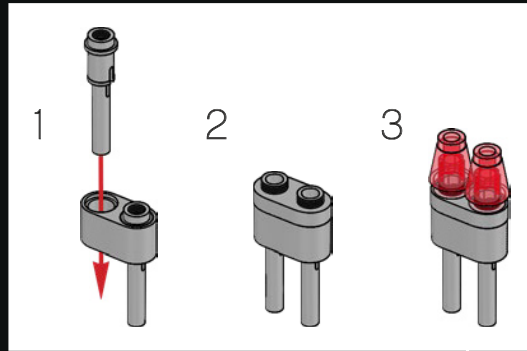

319

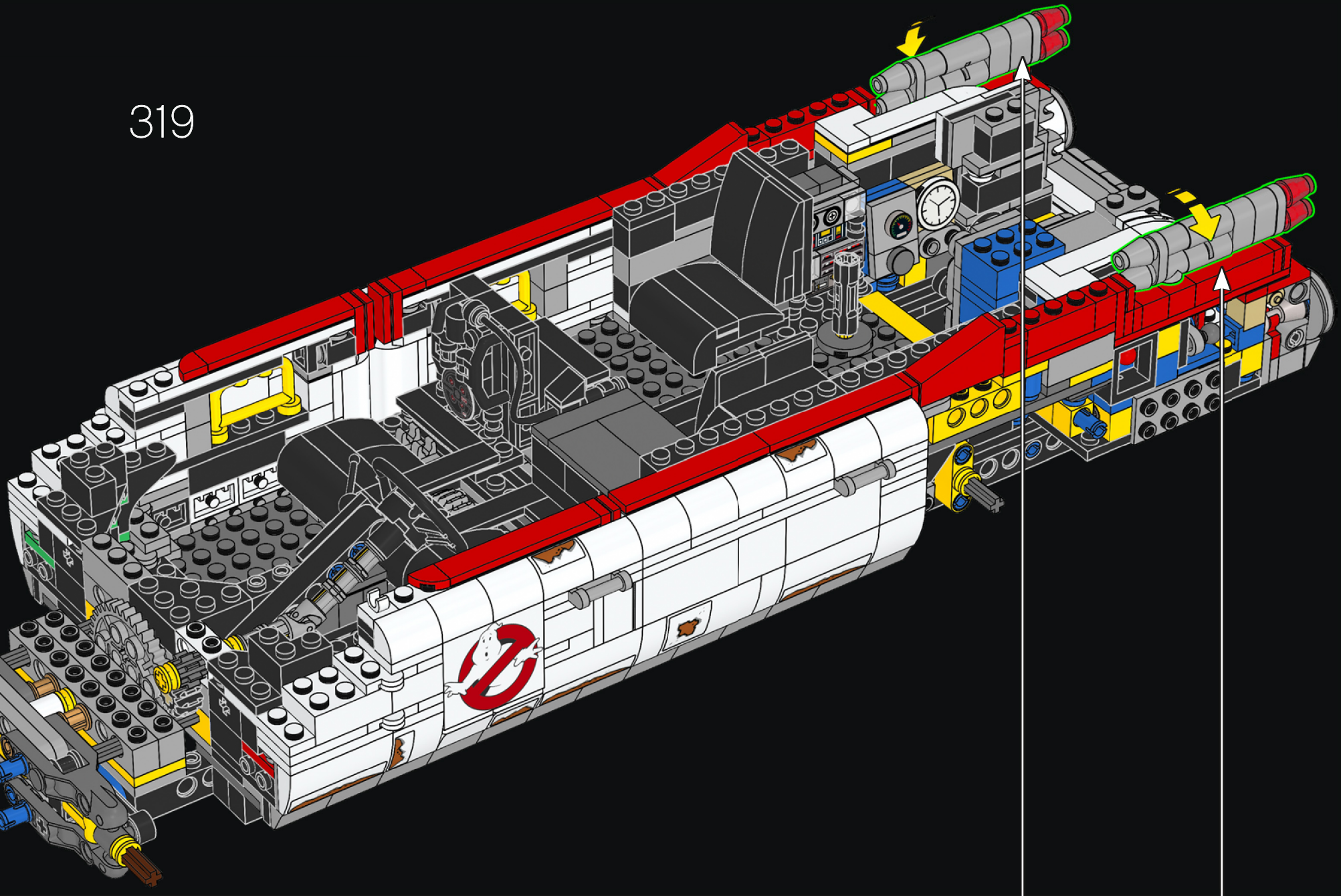

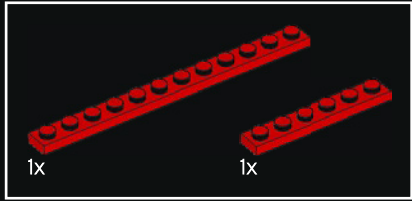
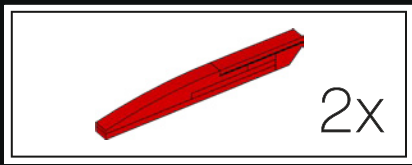

320

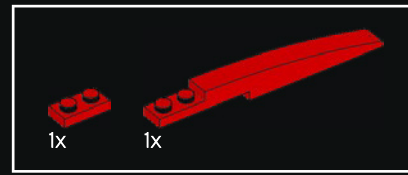
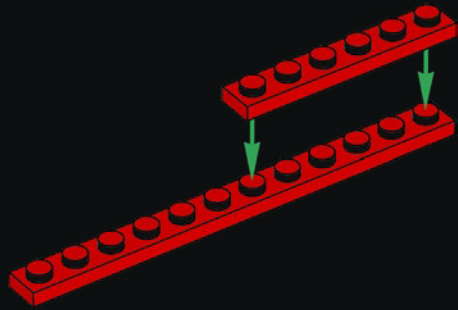

321

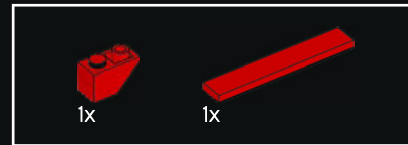
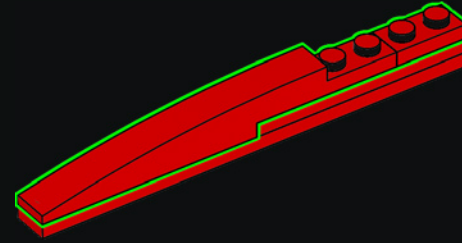

322

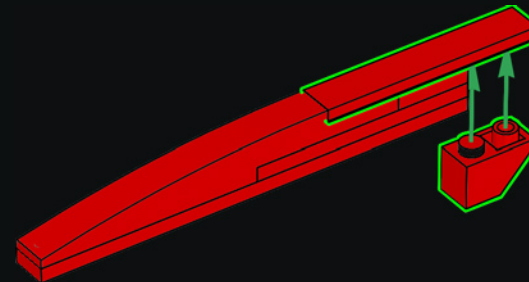

2x

323

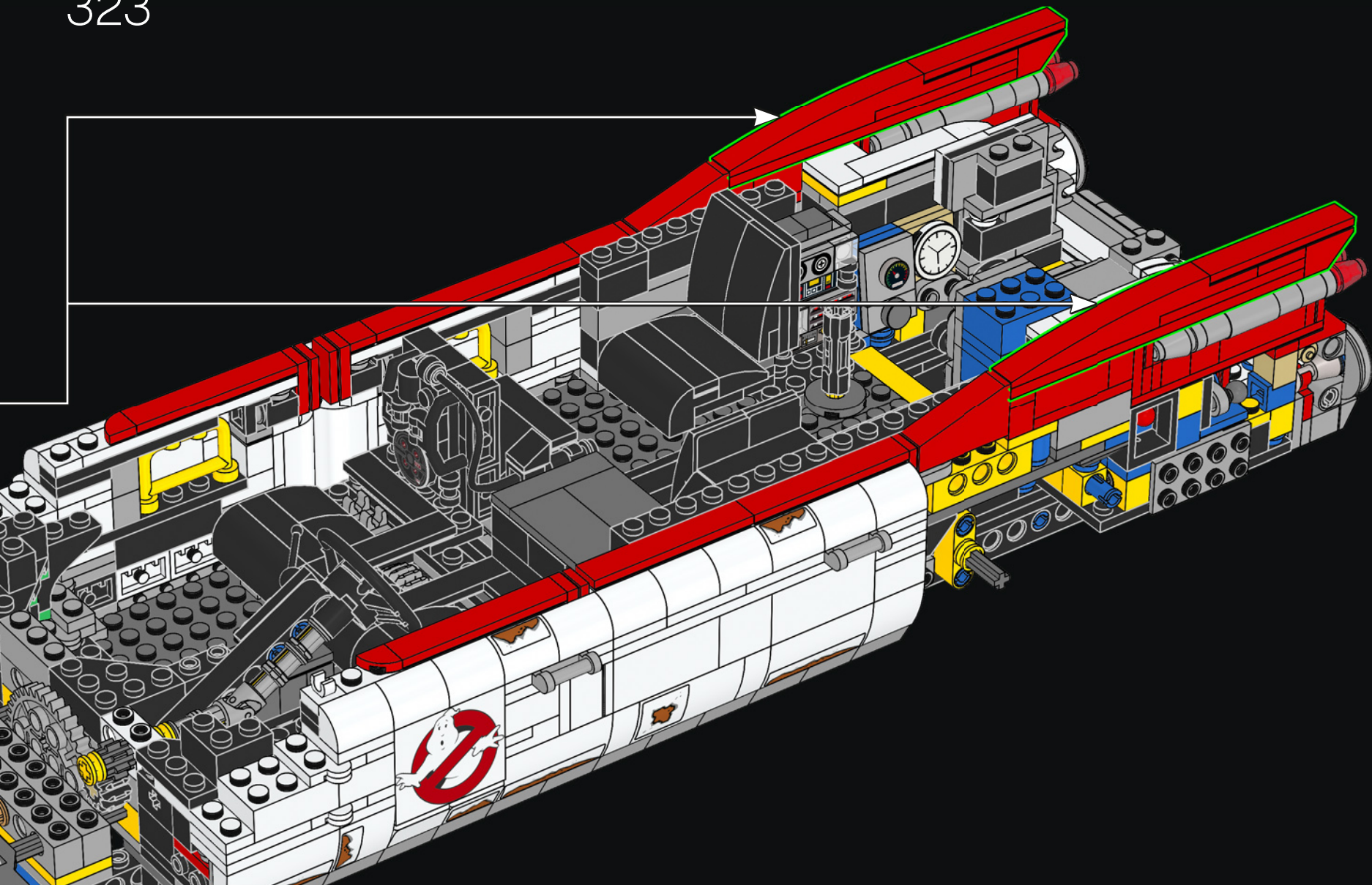

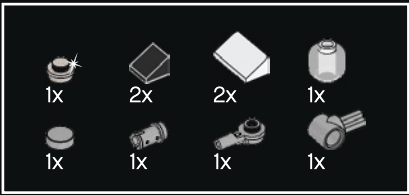
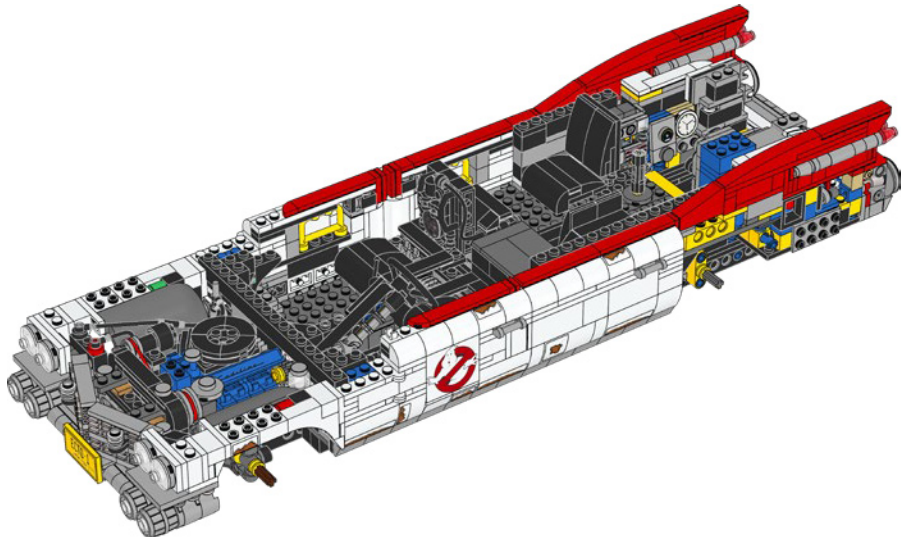
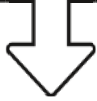

324

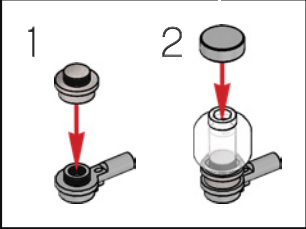
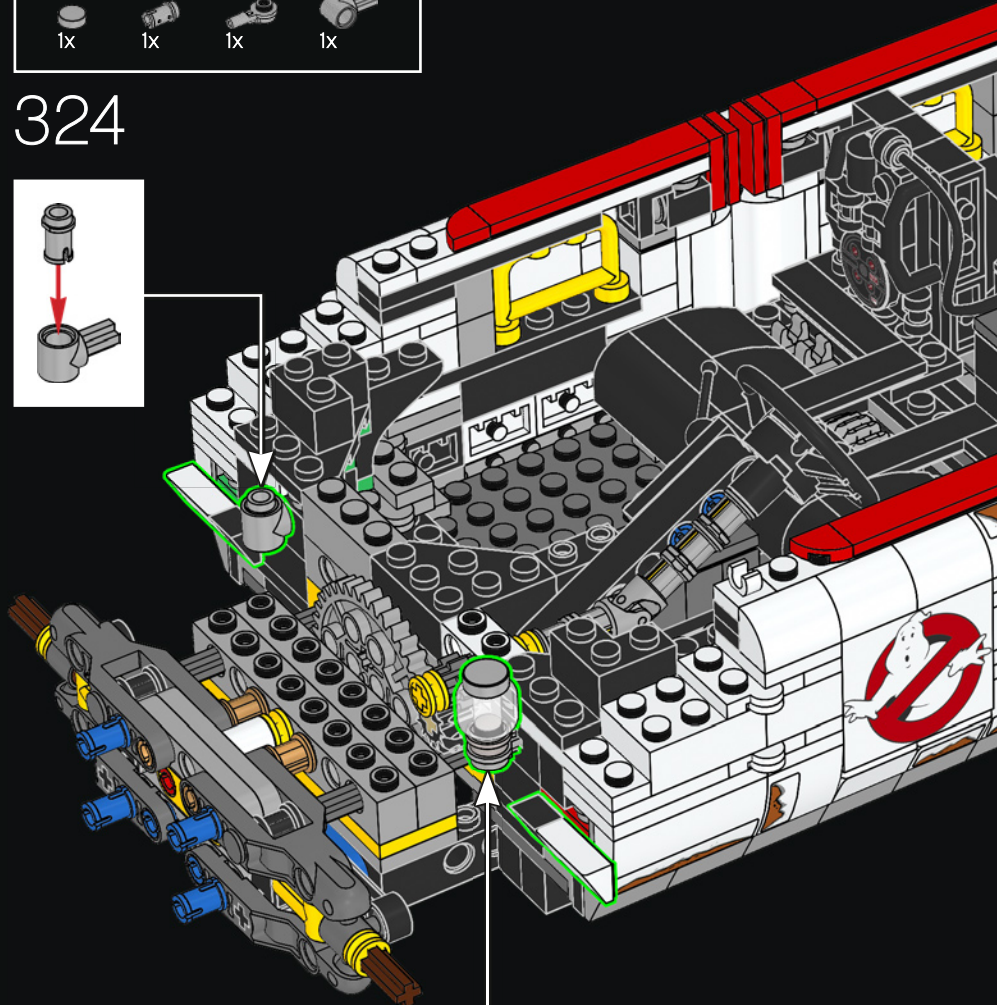
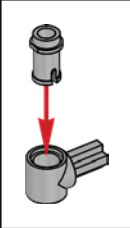

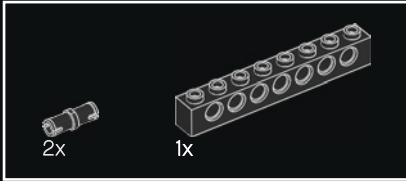
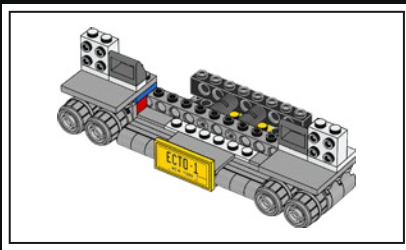

325

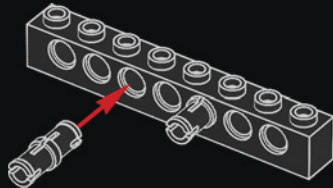

326

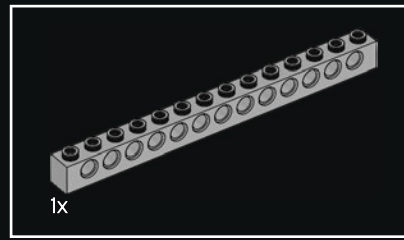
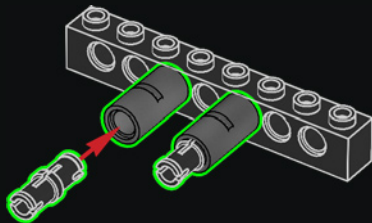

327

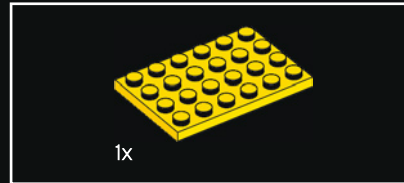
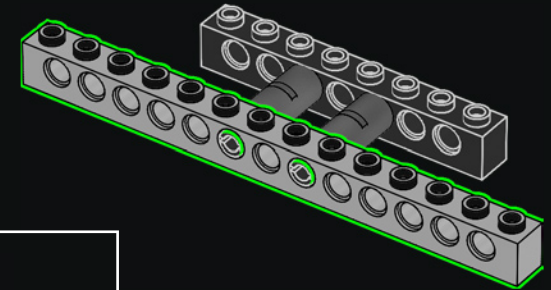

328

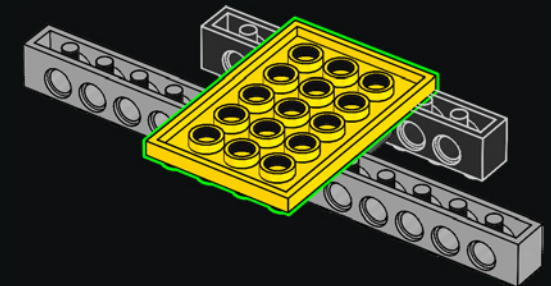



329

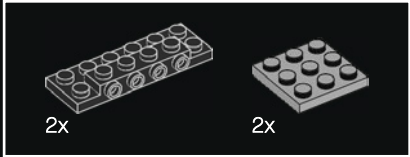
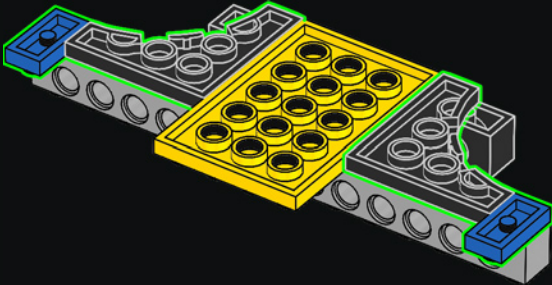

330

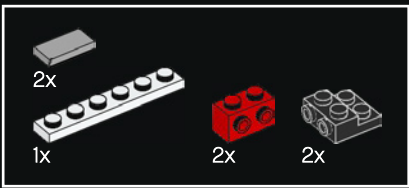
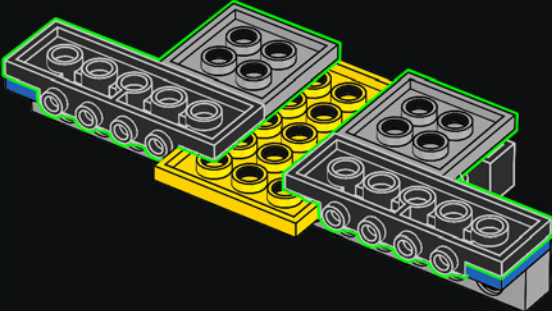

331

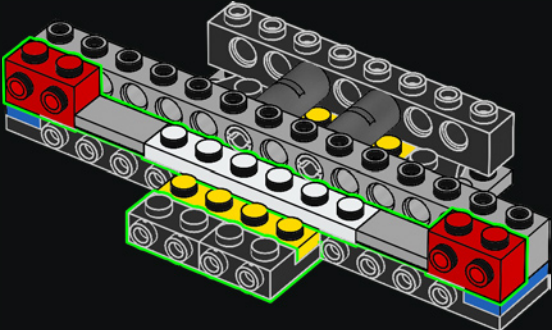

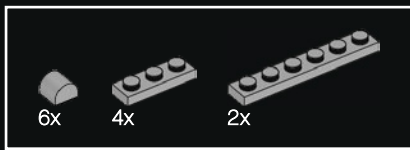

332

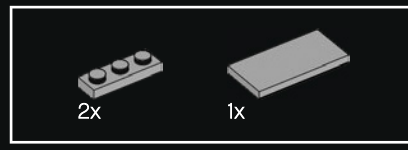
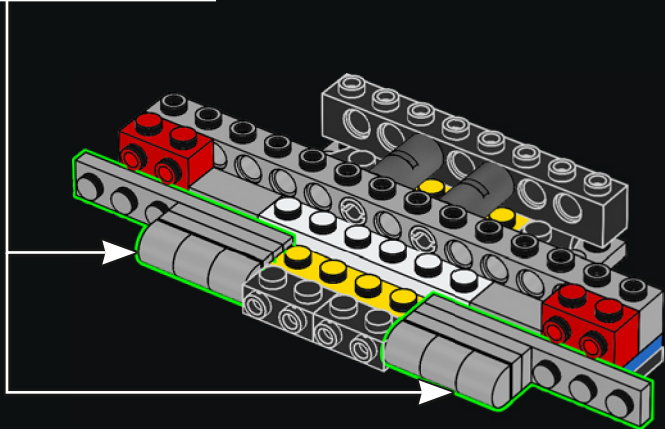
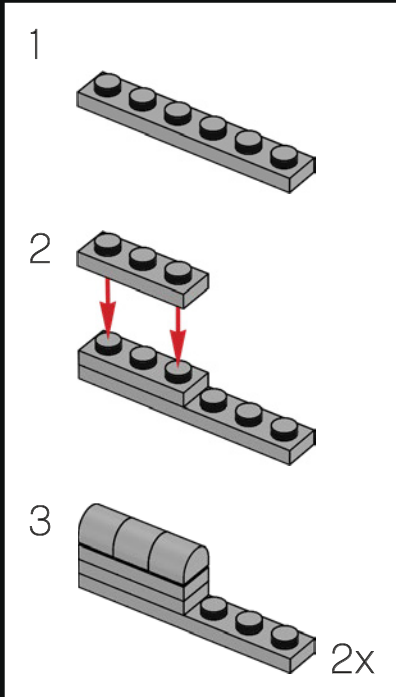

333

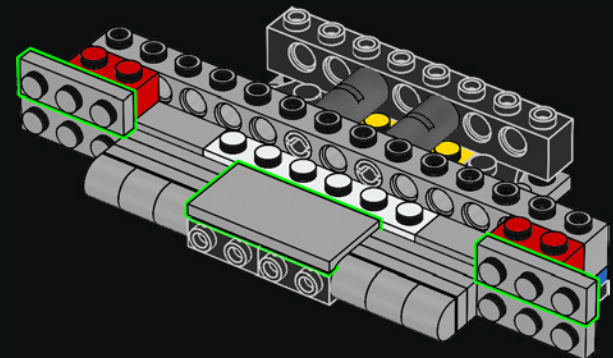

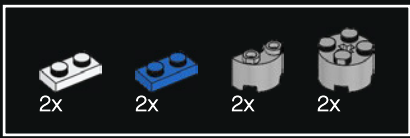

334

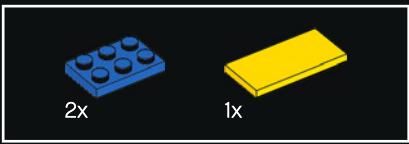
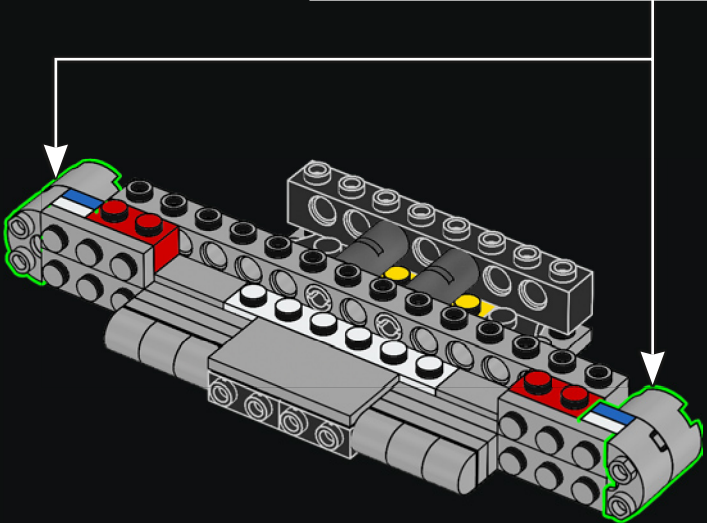
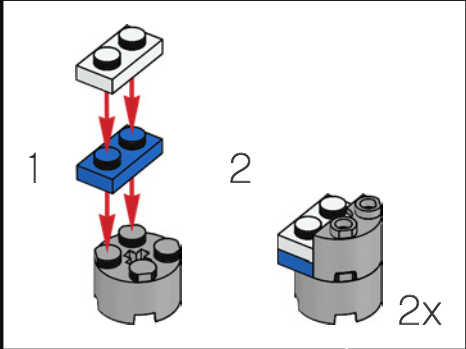

335

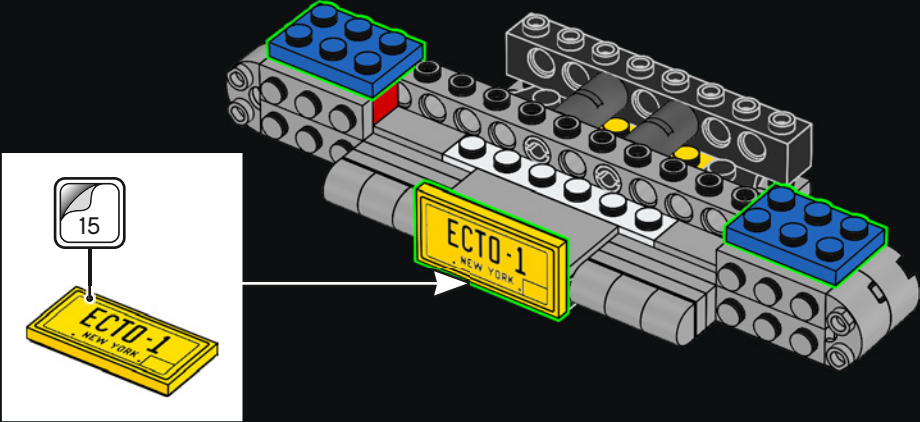



336

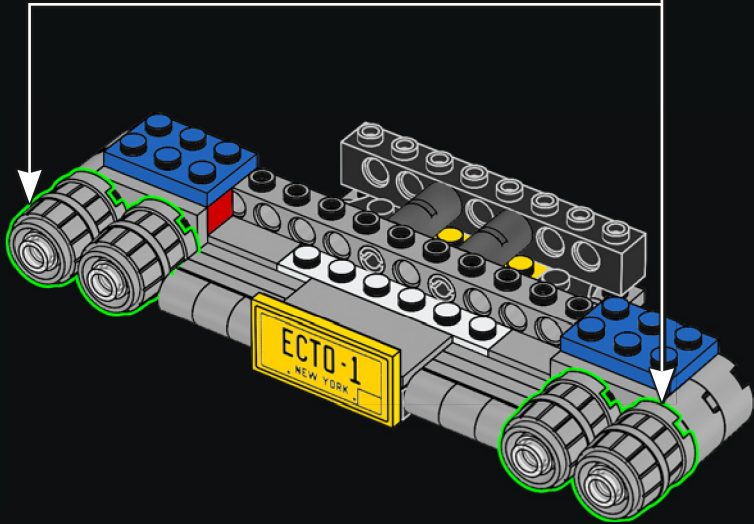
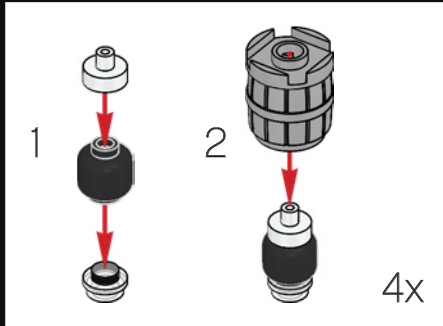

337

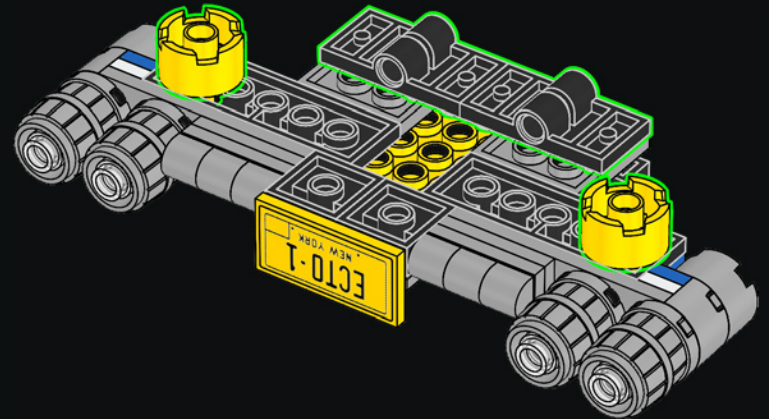



338

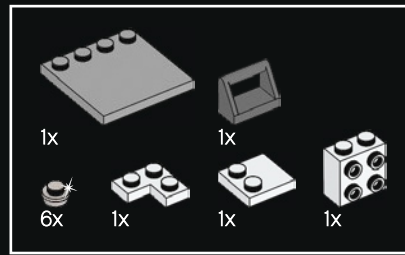
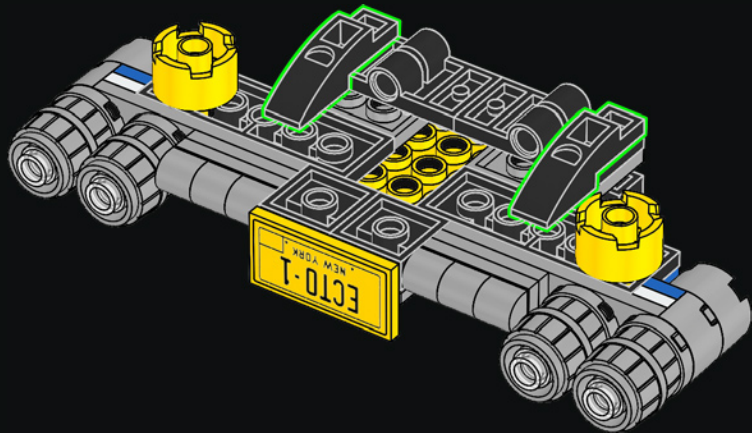

339

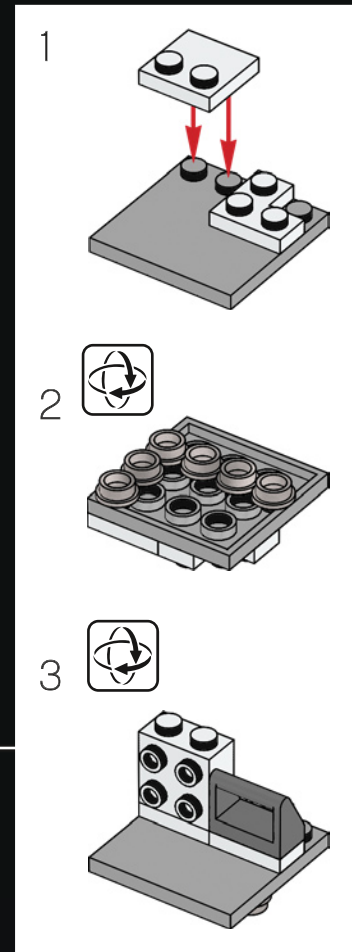
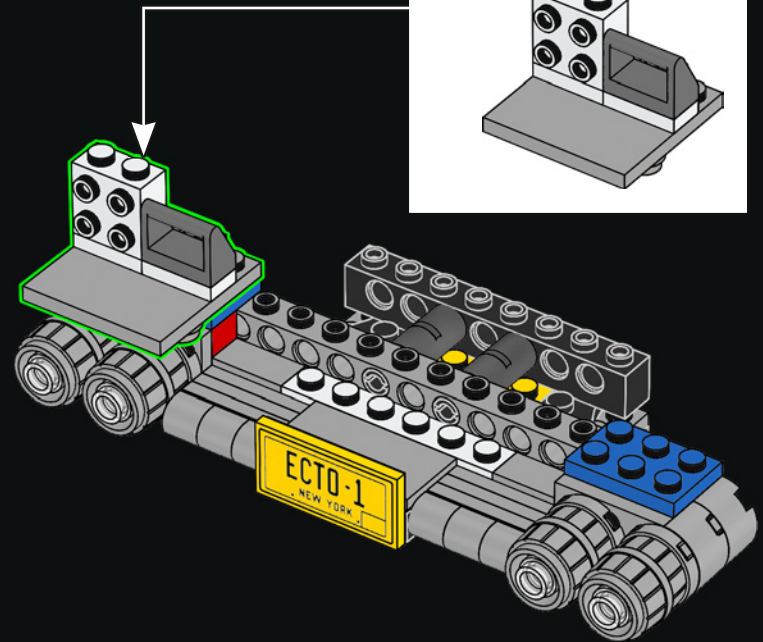

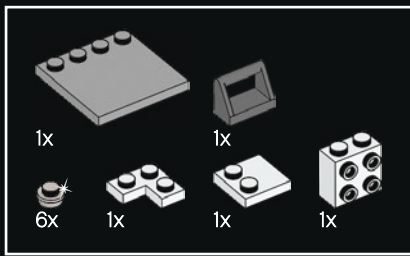

340

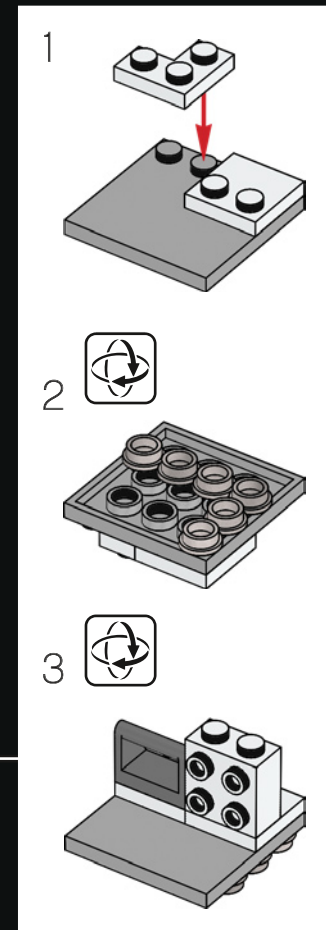
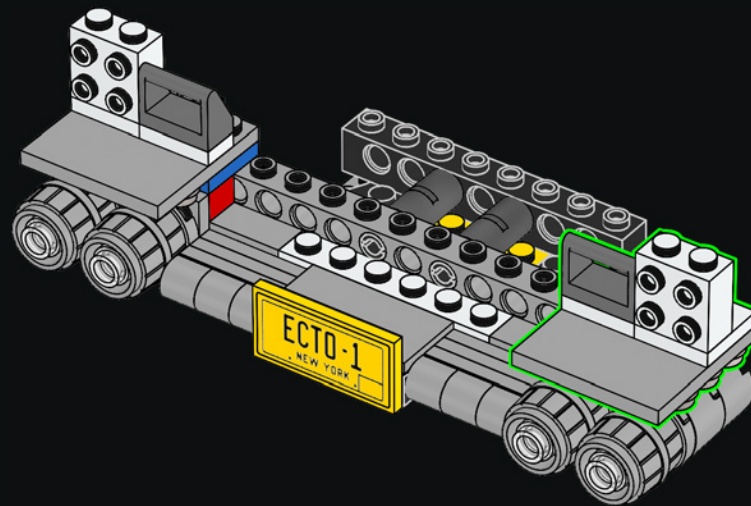

341

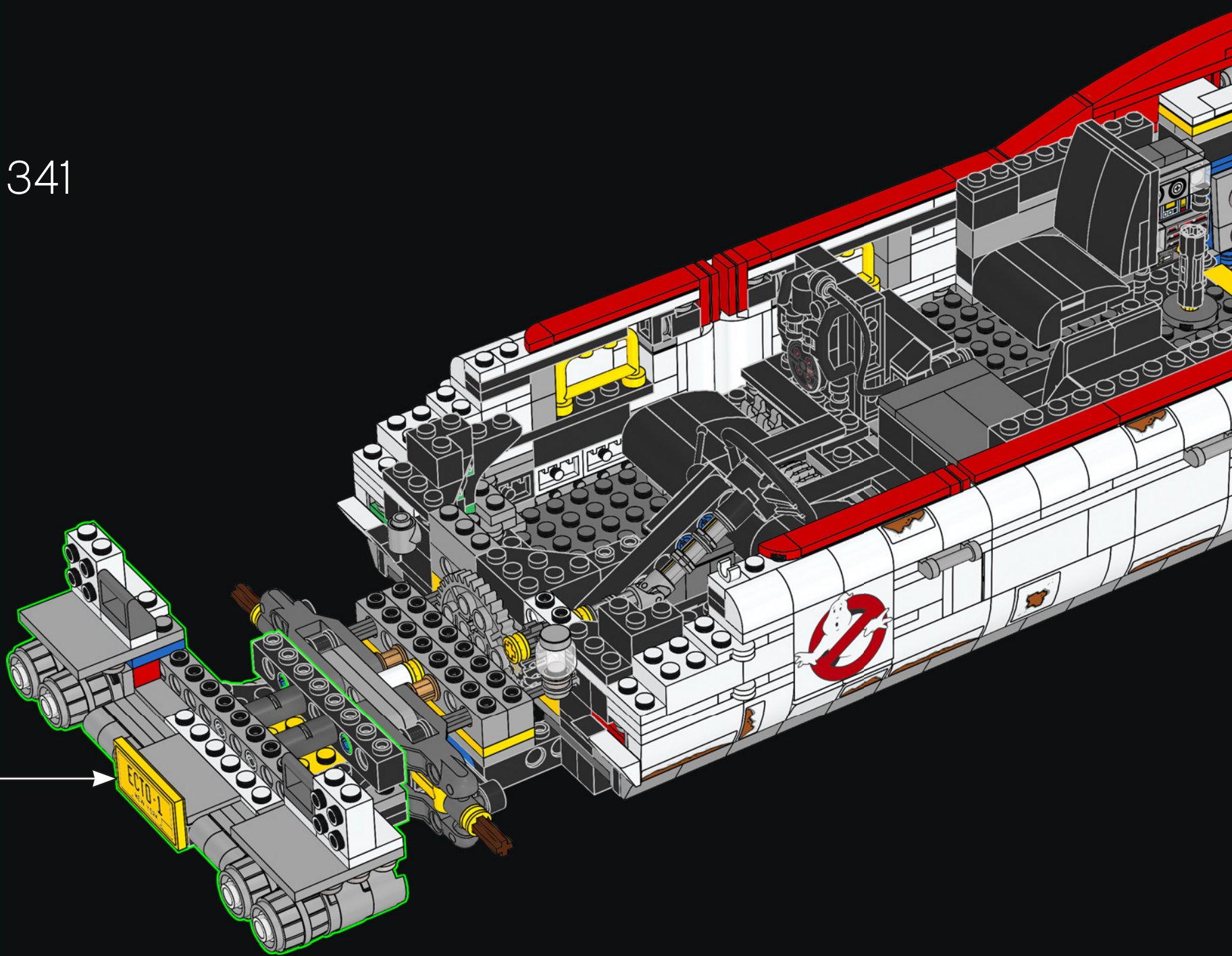

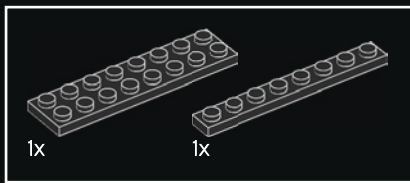

342

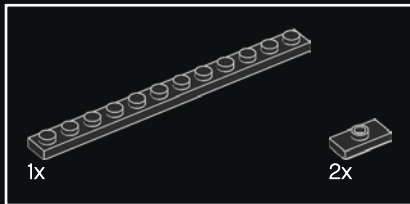
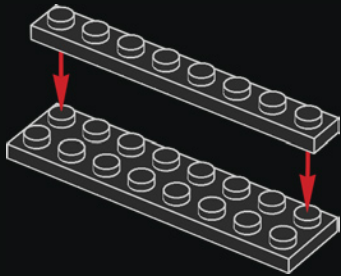

343

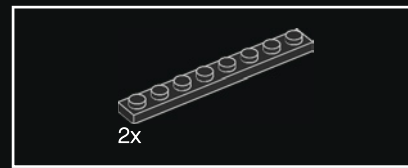
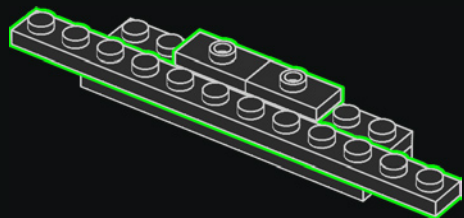

344

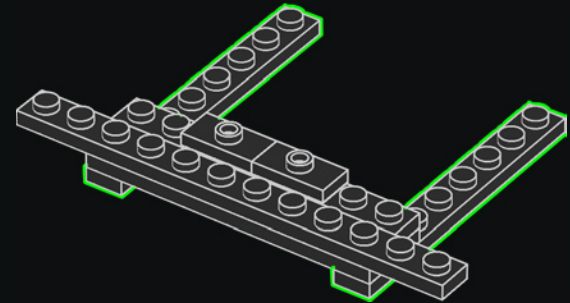

345

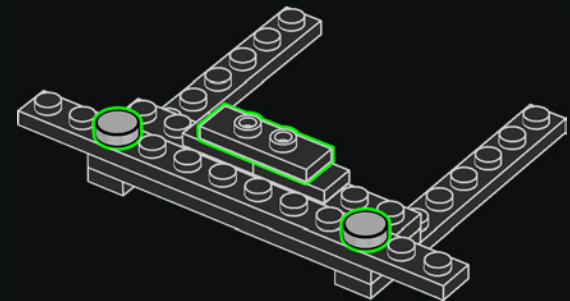

346

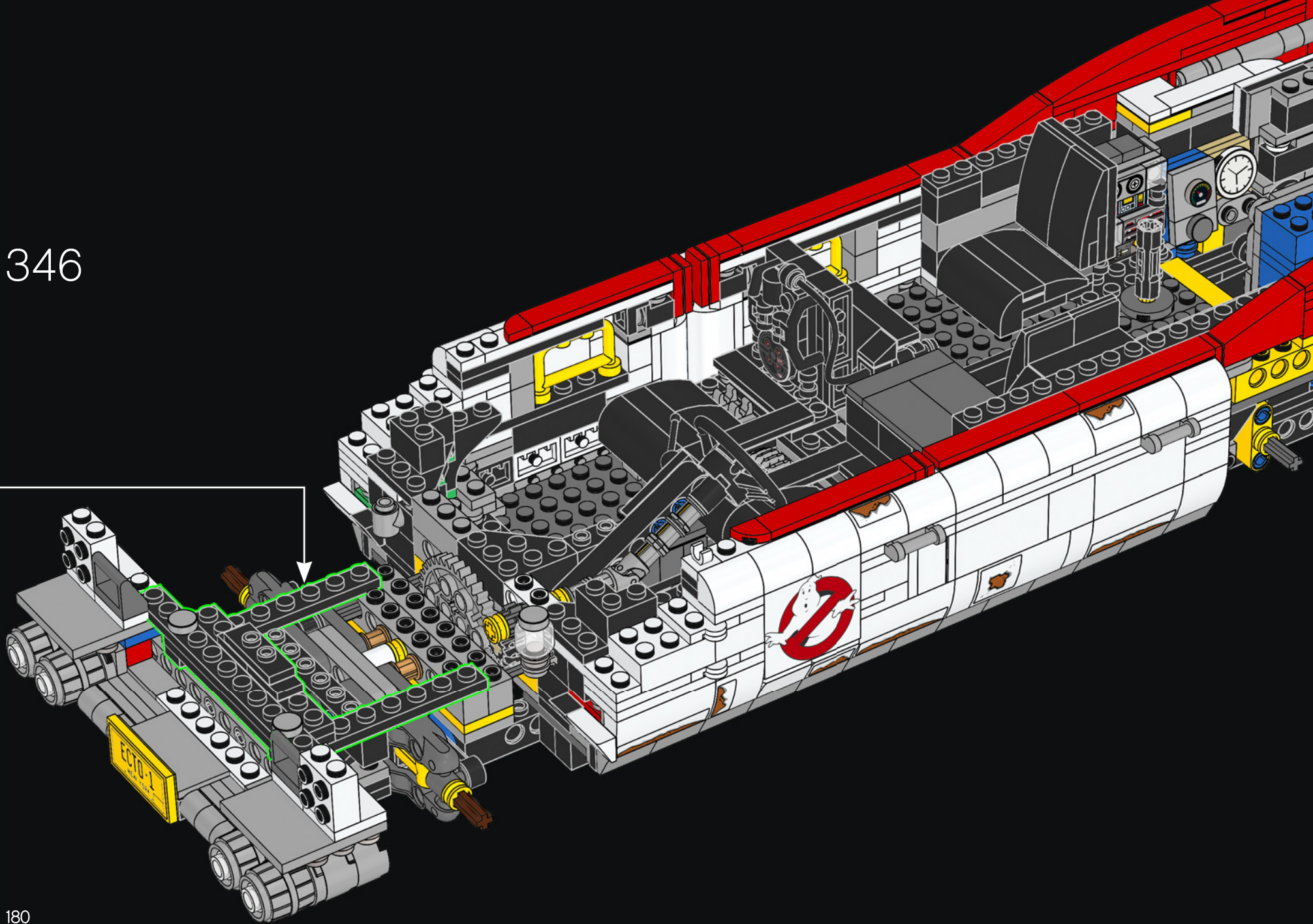

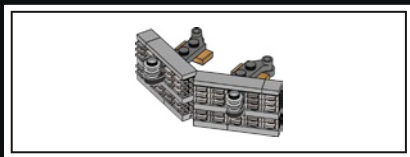

347



348

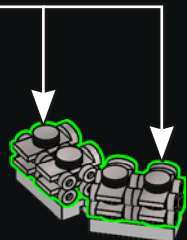
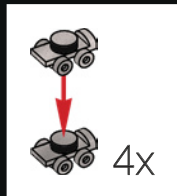

349

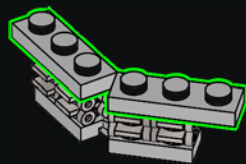

350

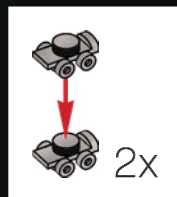
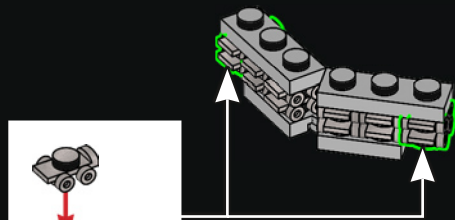

351

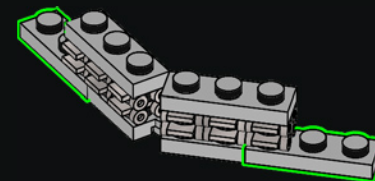

352

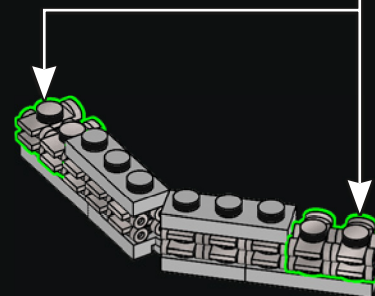
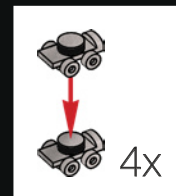



353

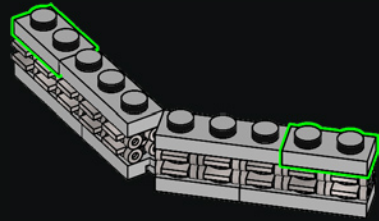

355

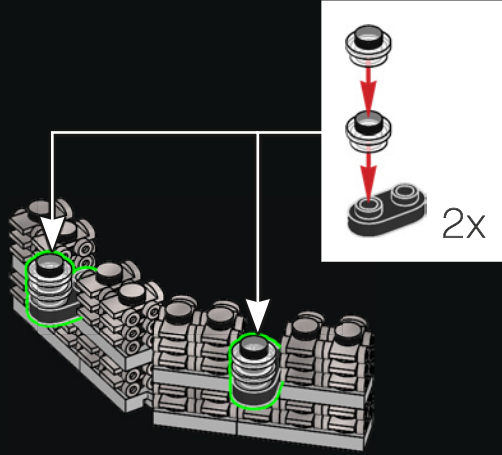

354

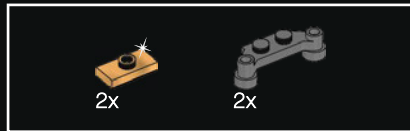
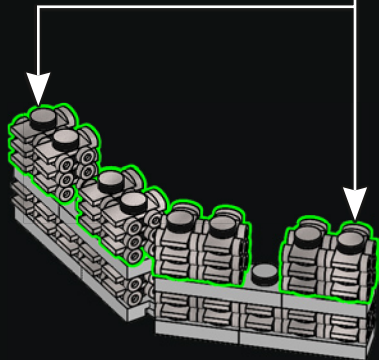
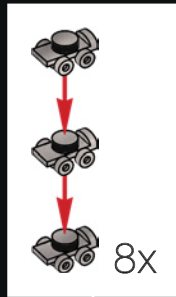

356

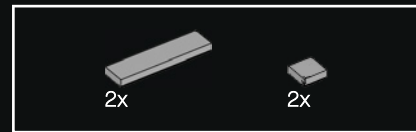
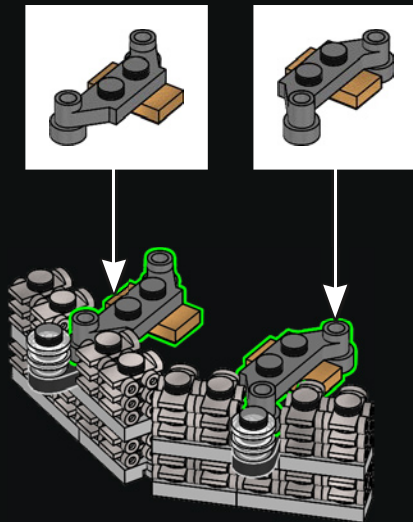

357

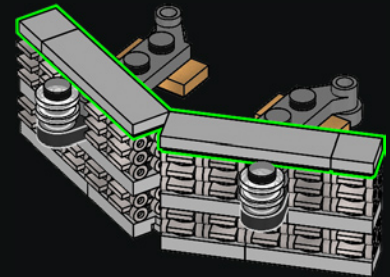

358

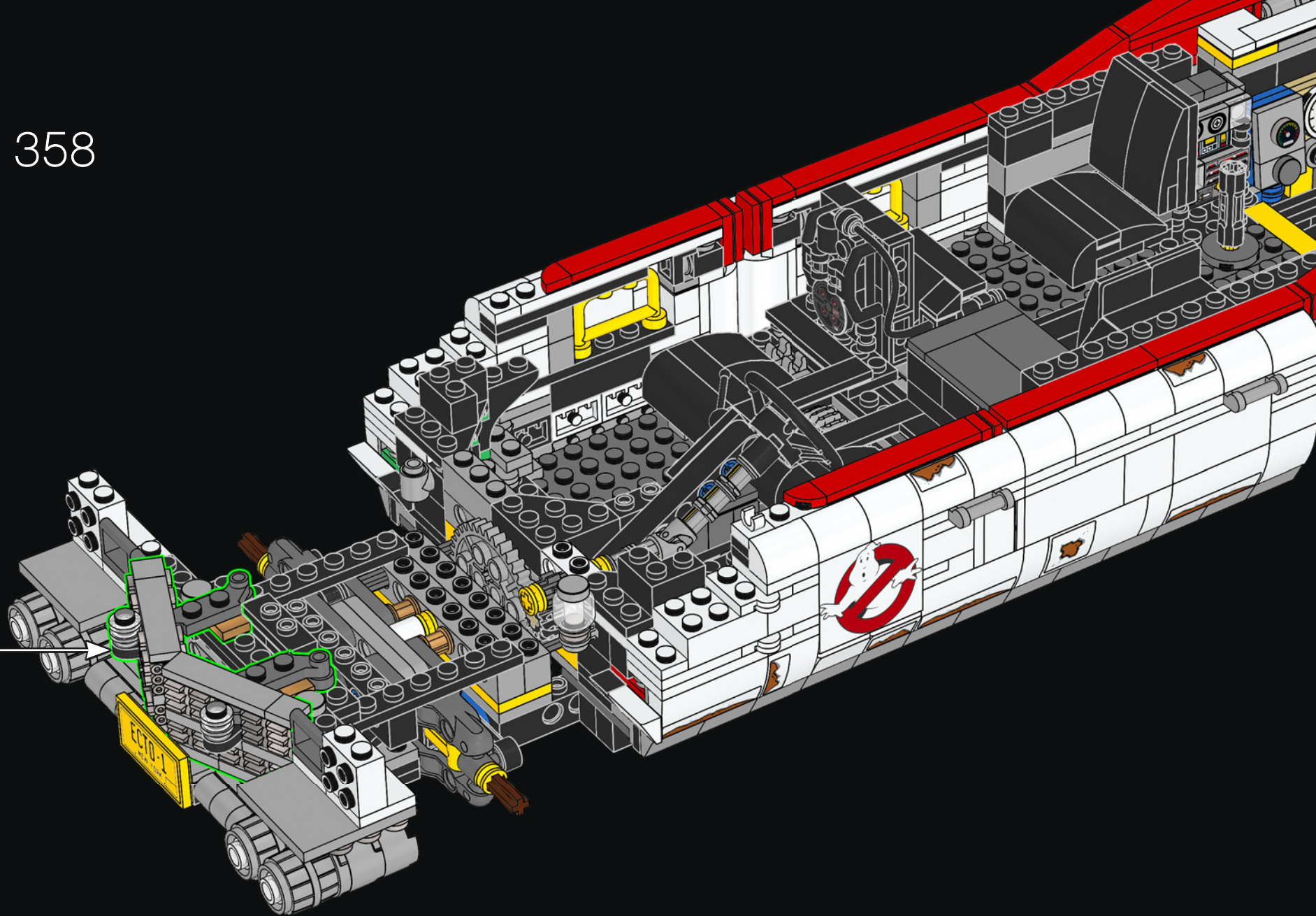

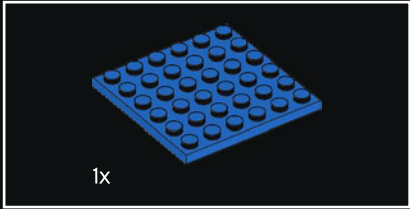
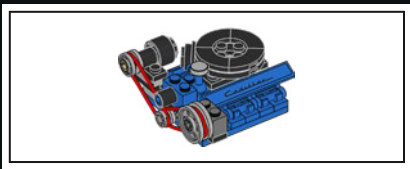

359

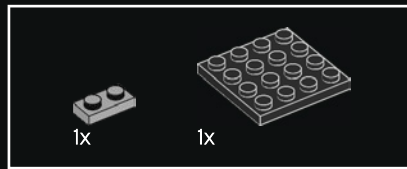
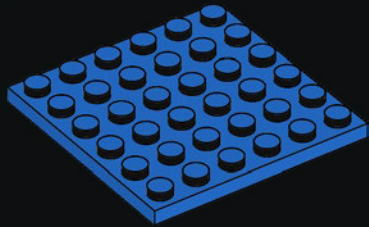

360

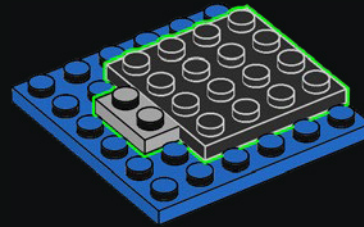

361

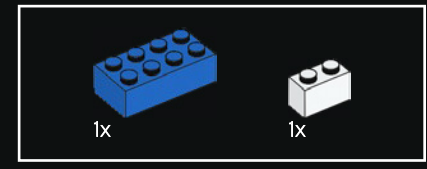
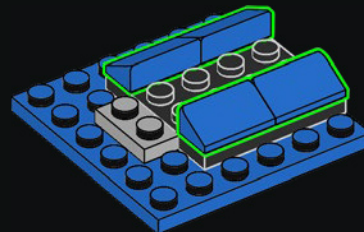

362

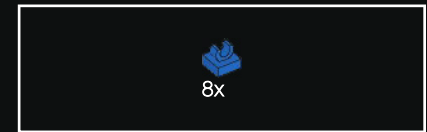
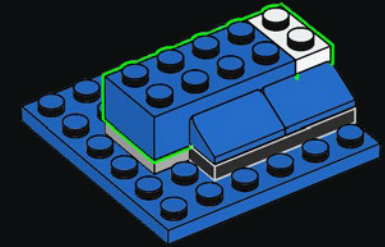

363

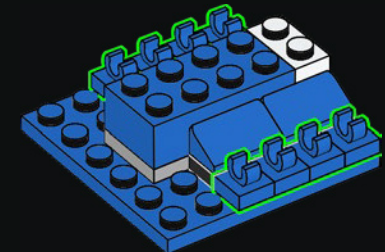

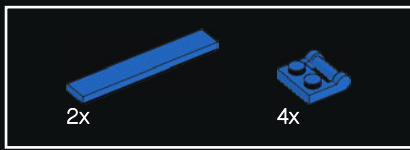

364

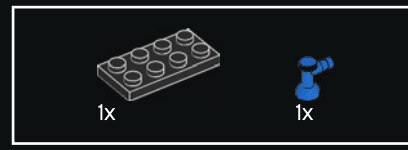
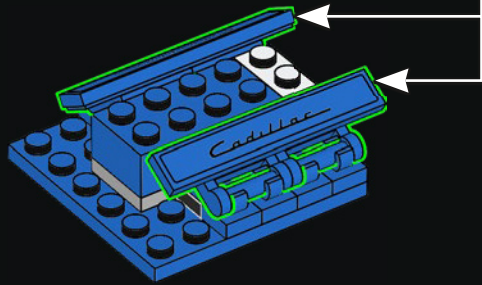
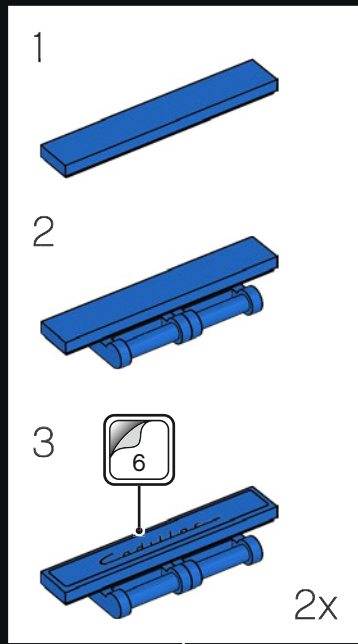

365

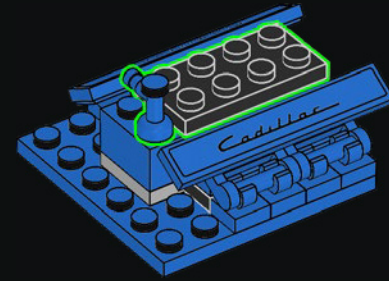

366

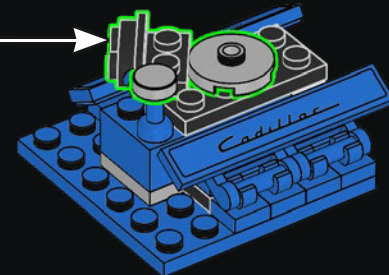
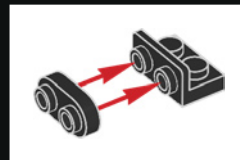



367

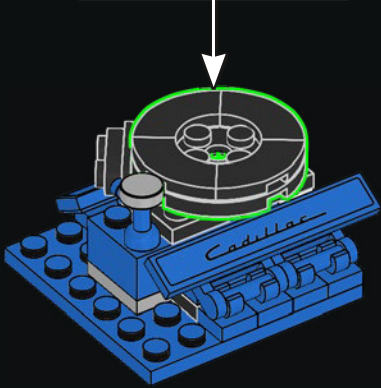
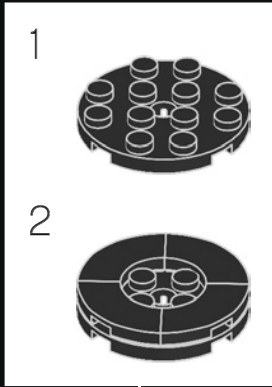

368

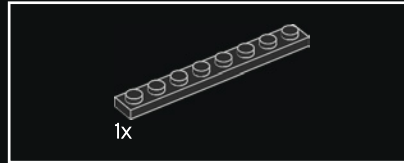
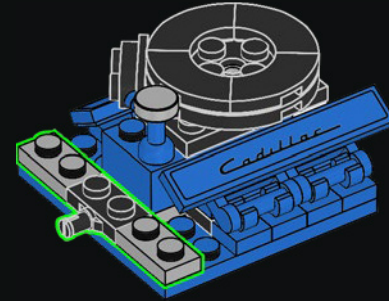

369

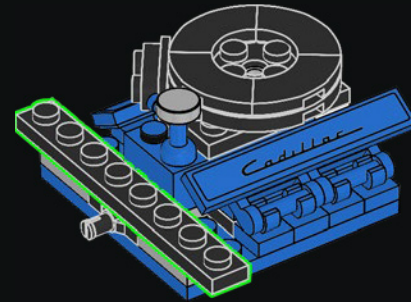

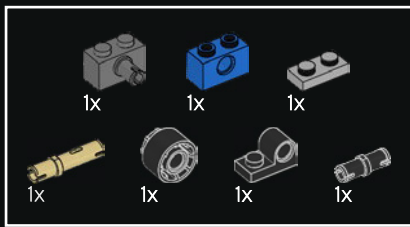

370

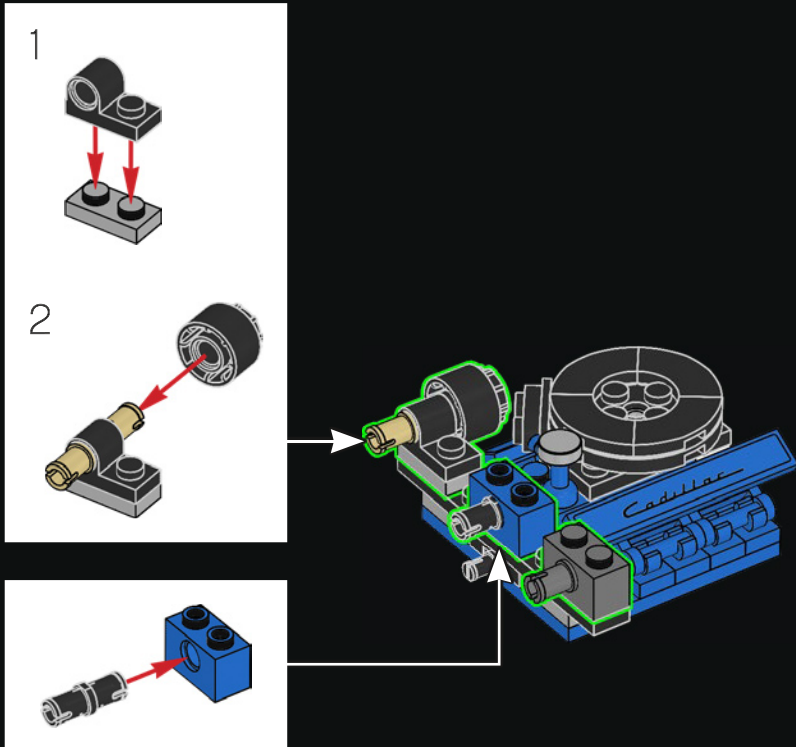

371

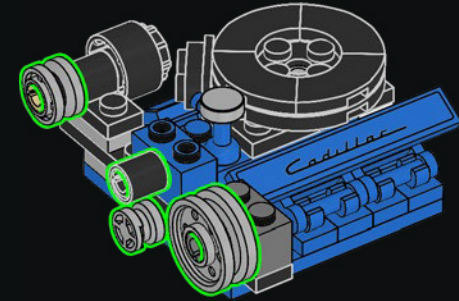

372

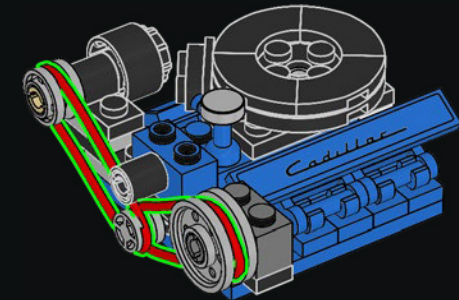

373

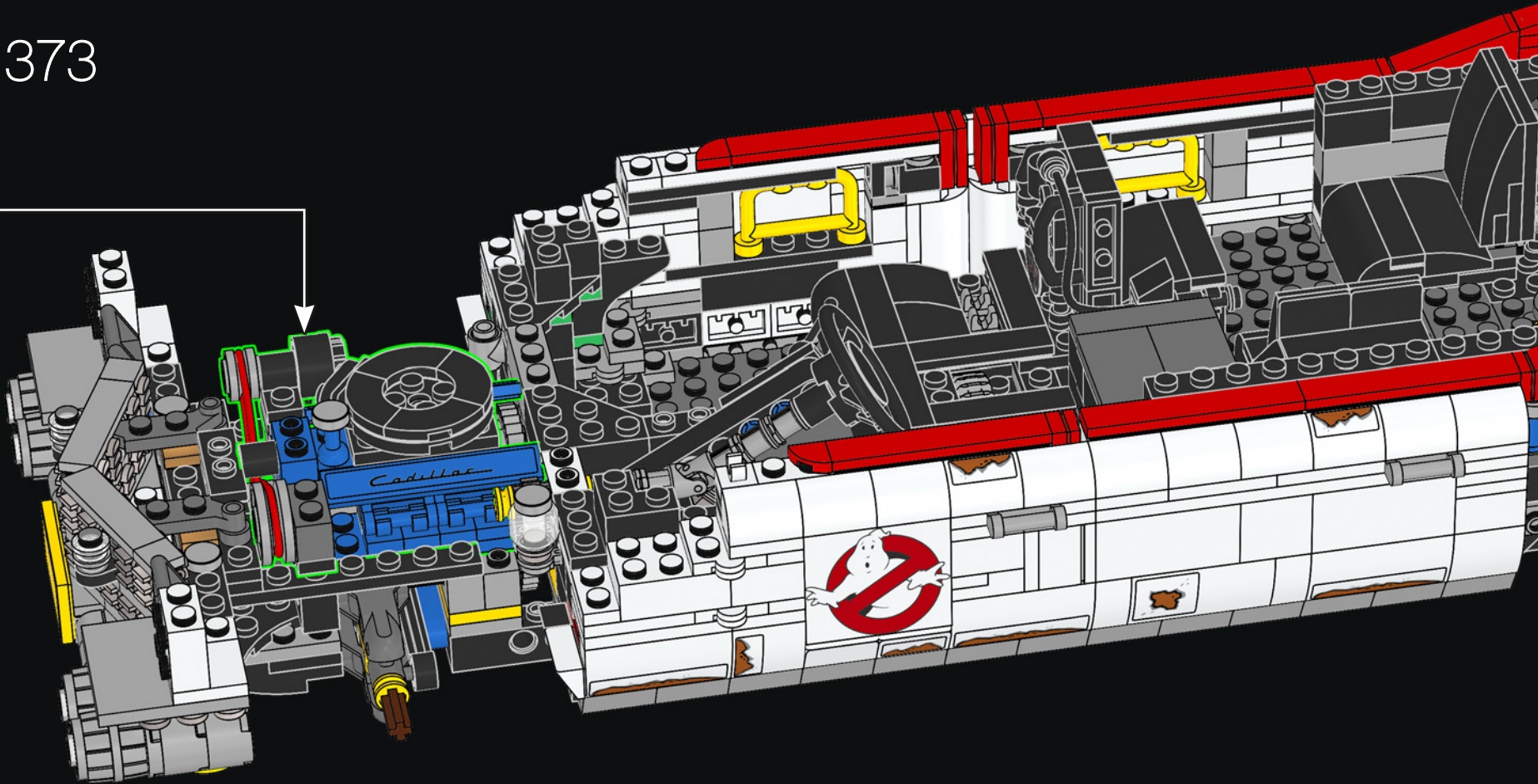

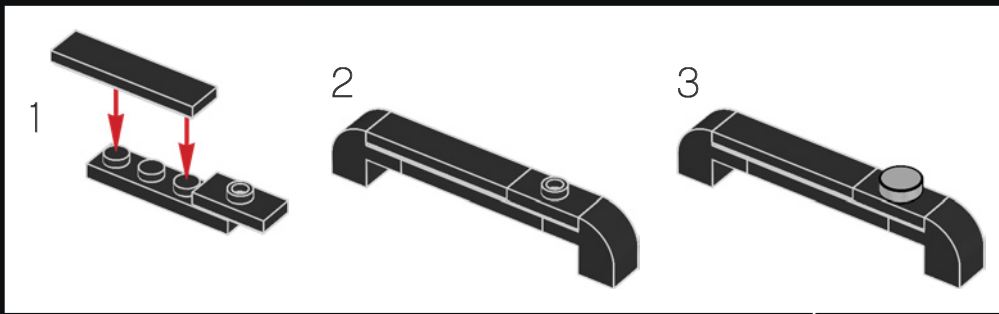
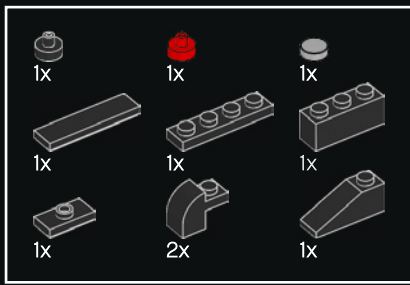

374

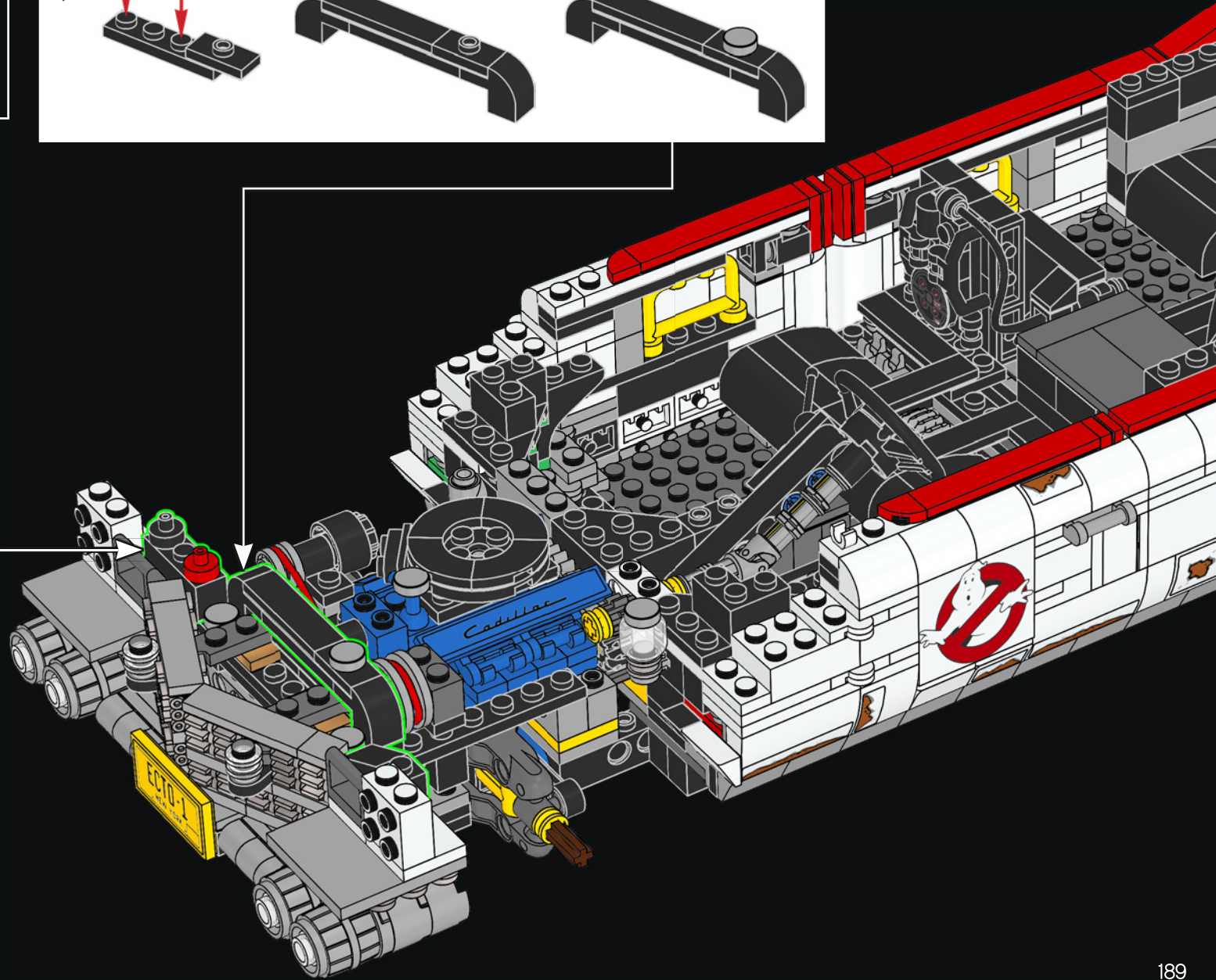
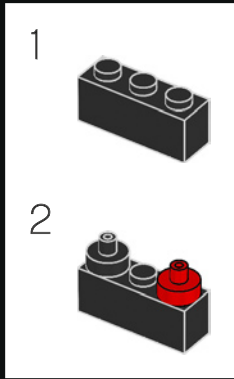

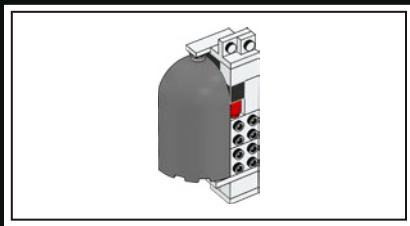

375

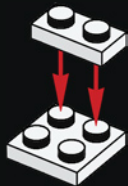

376

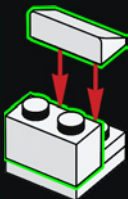

377

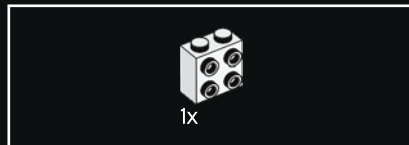
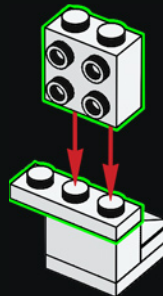

378

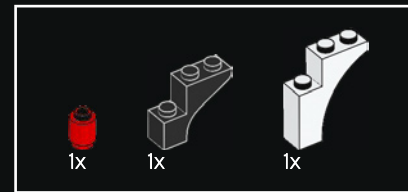
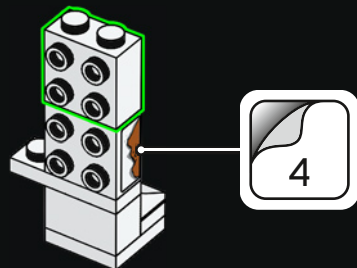

379

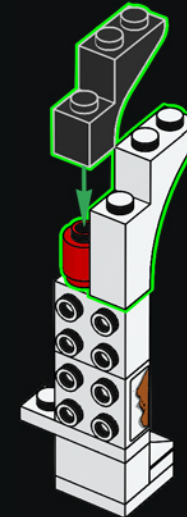

380

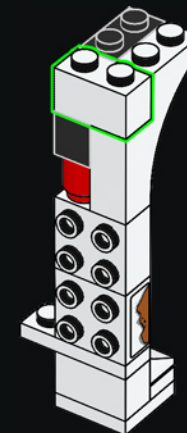

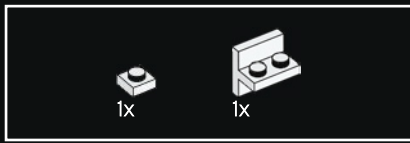

381

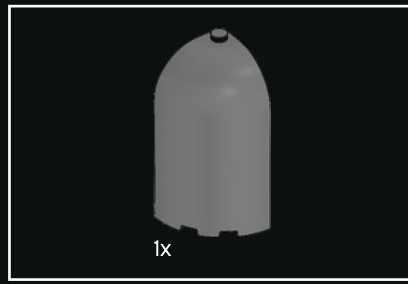
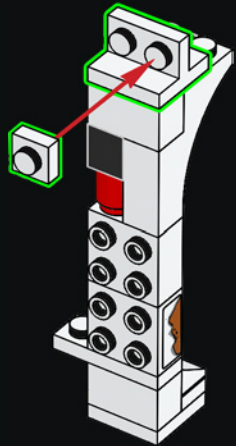

382

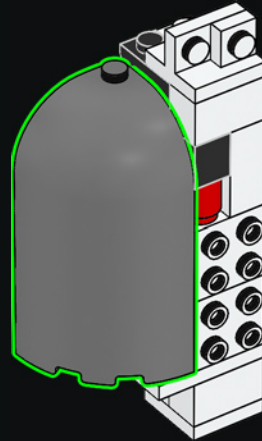

383

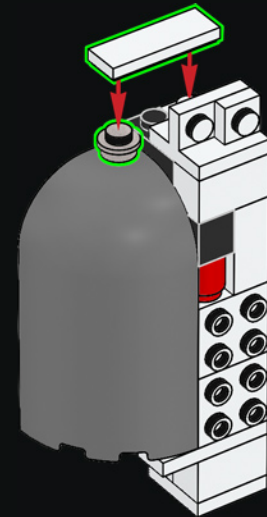

384

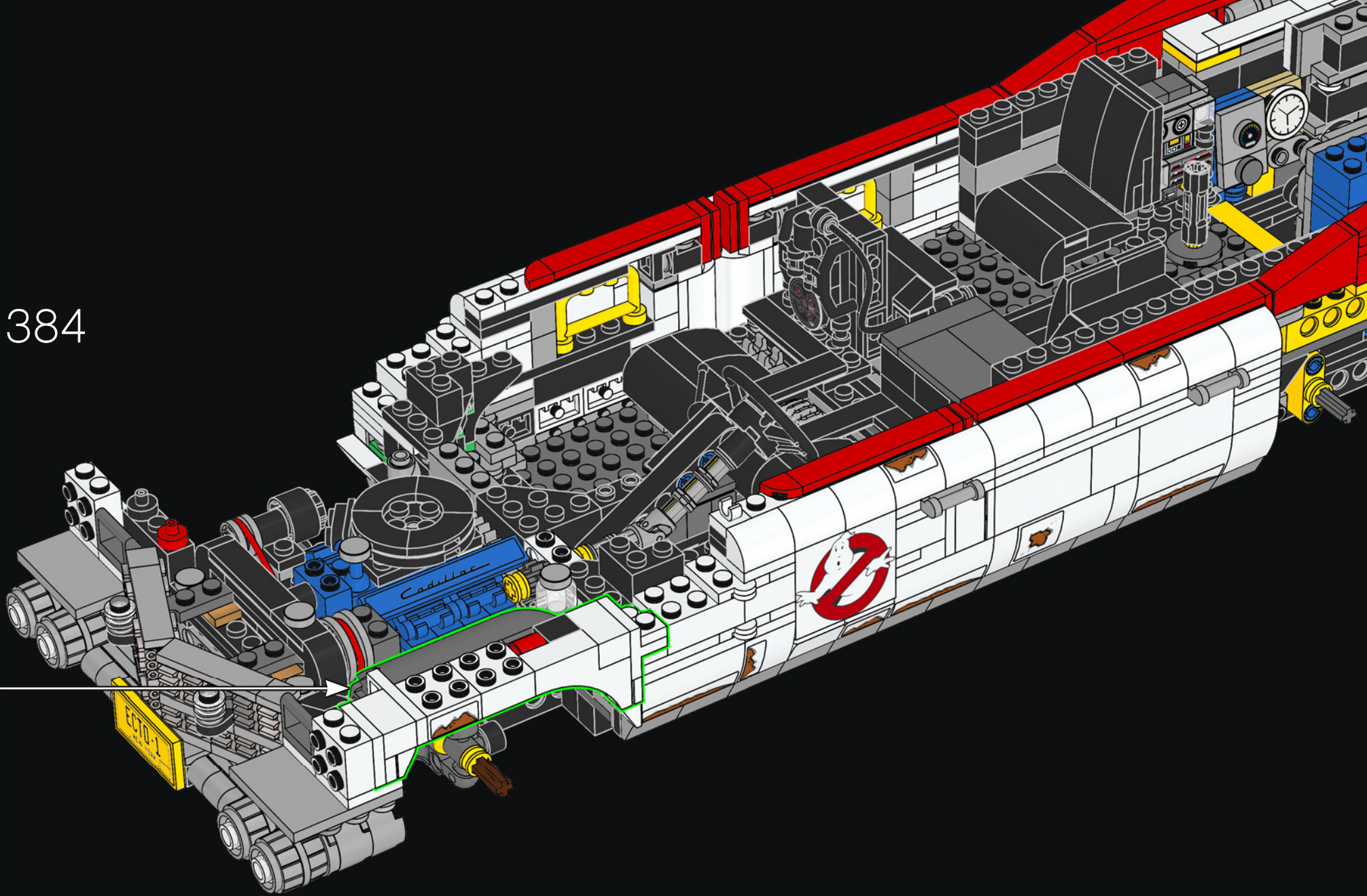

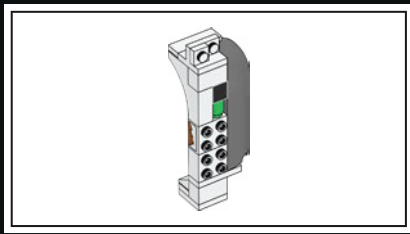

385

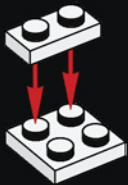

386

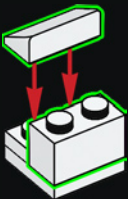

387

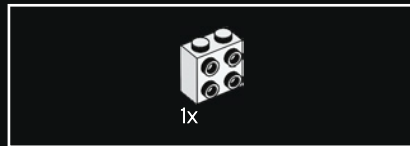
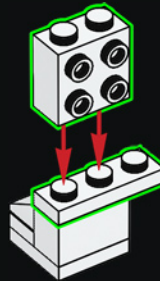

388

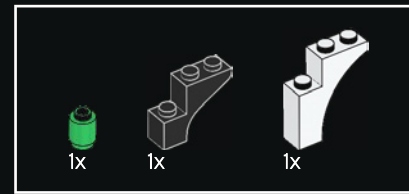
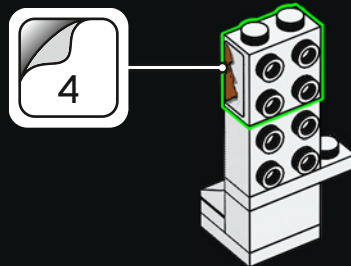

389

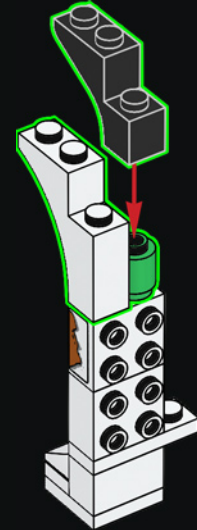

390

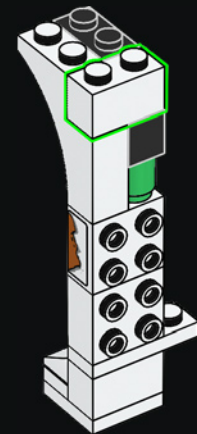

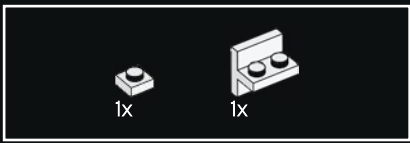

391

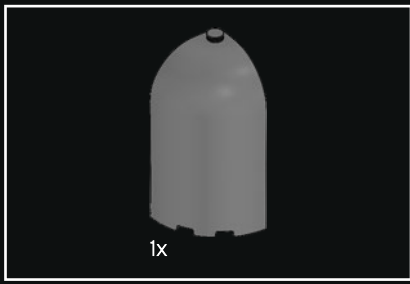
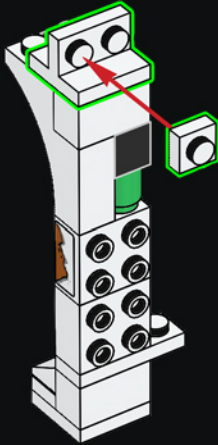

392

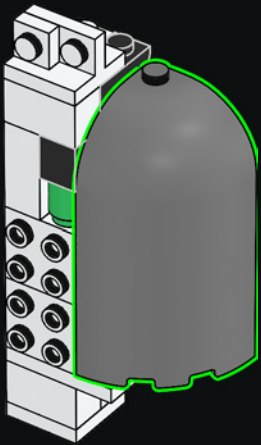

393

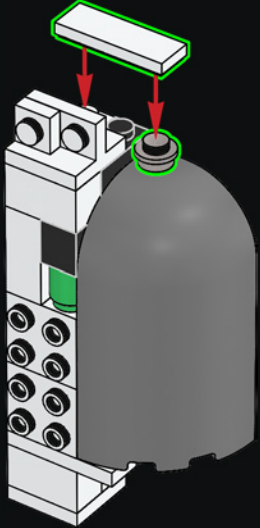

394

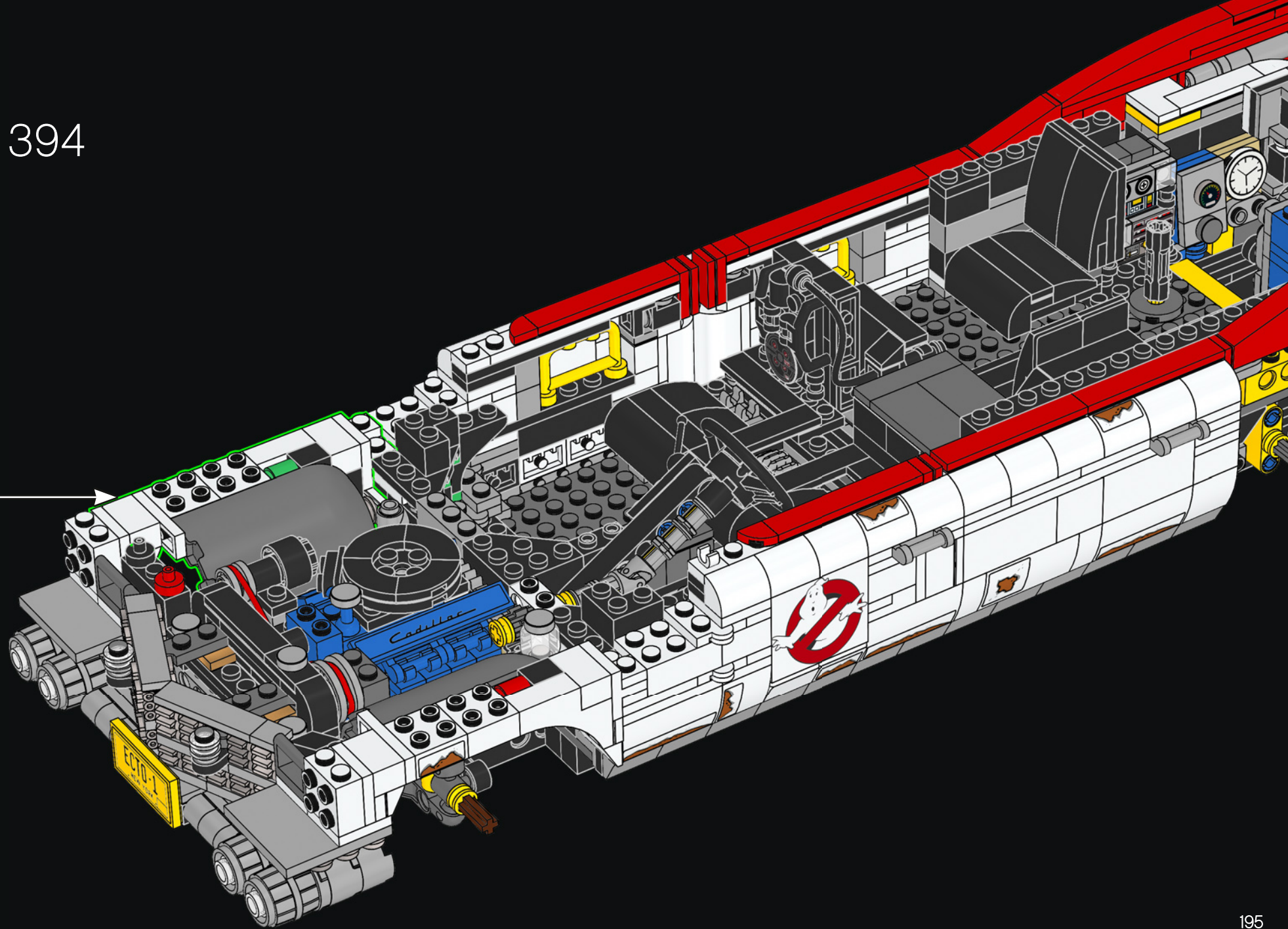

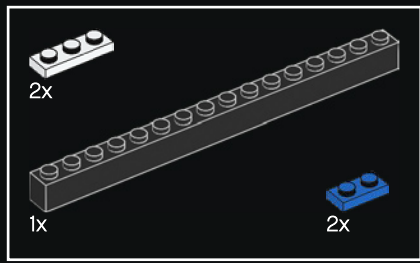

395

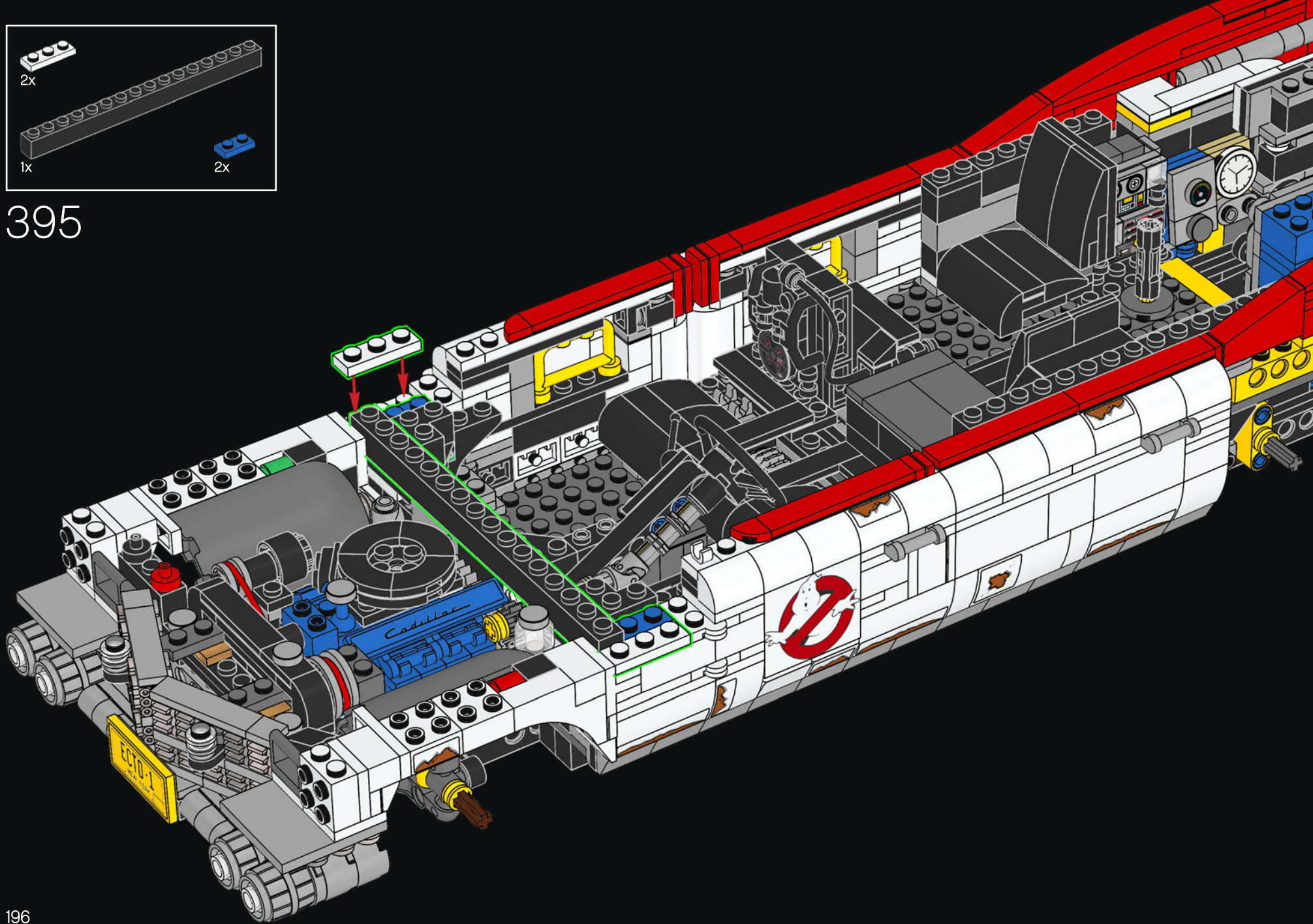

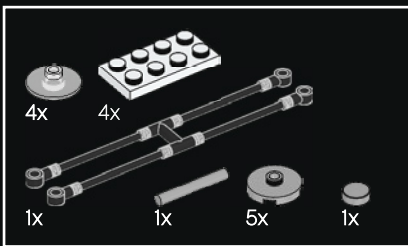

396

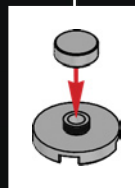
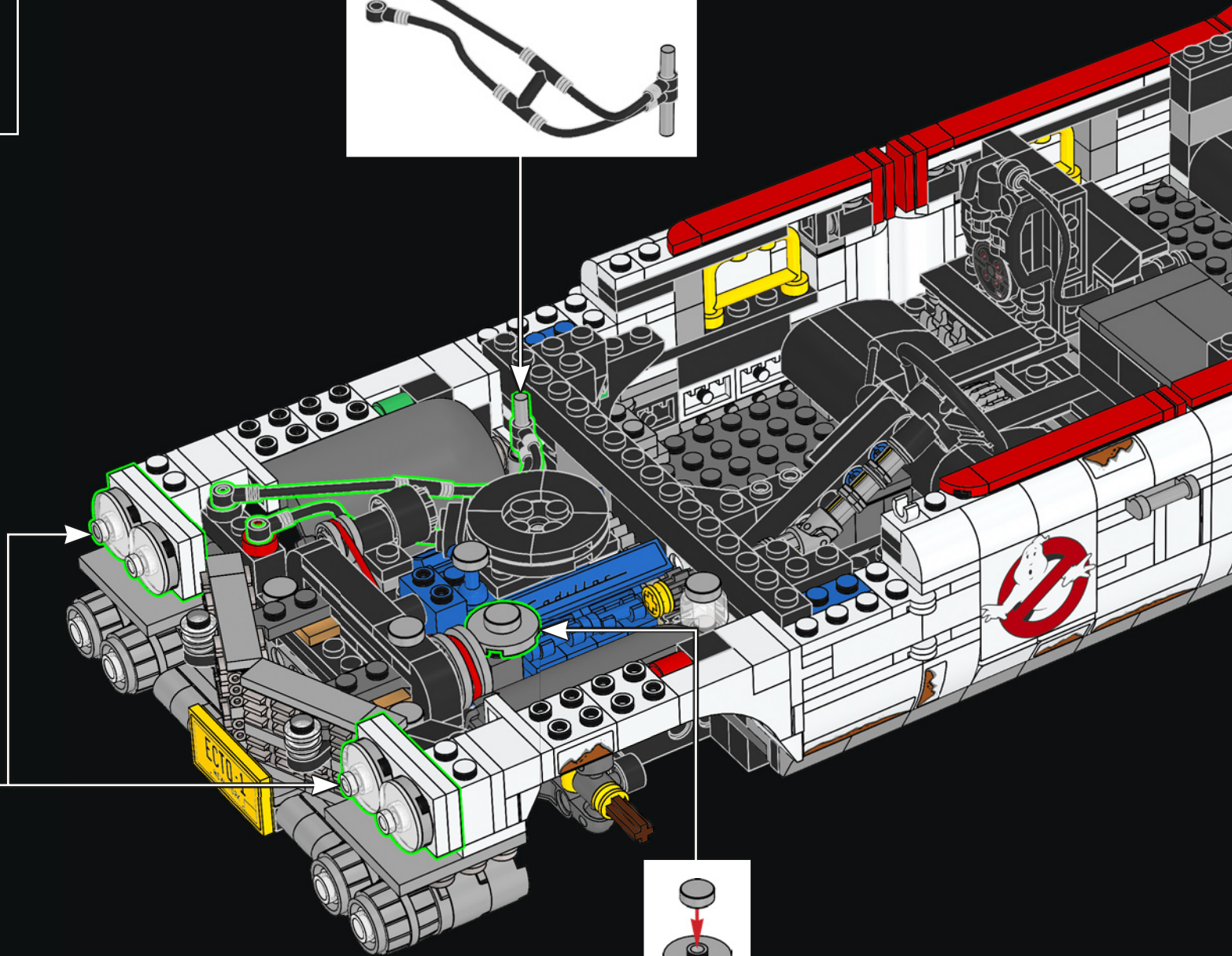
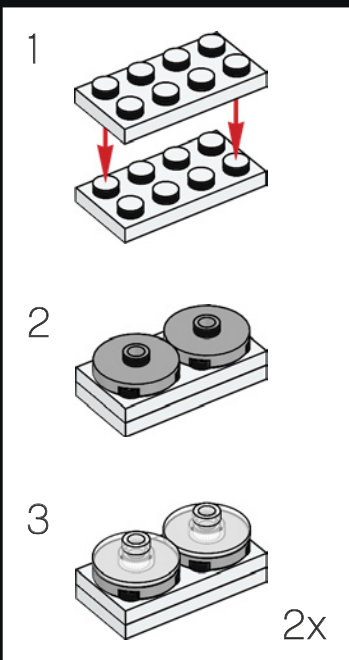

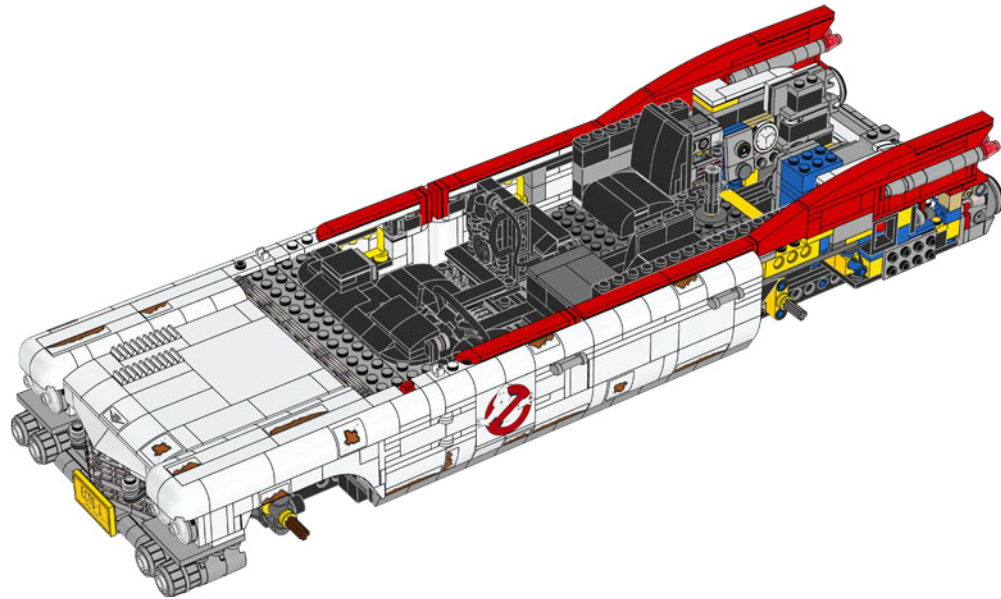
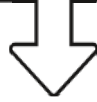

4x

397

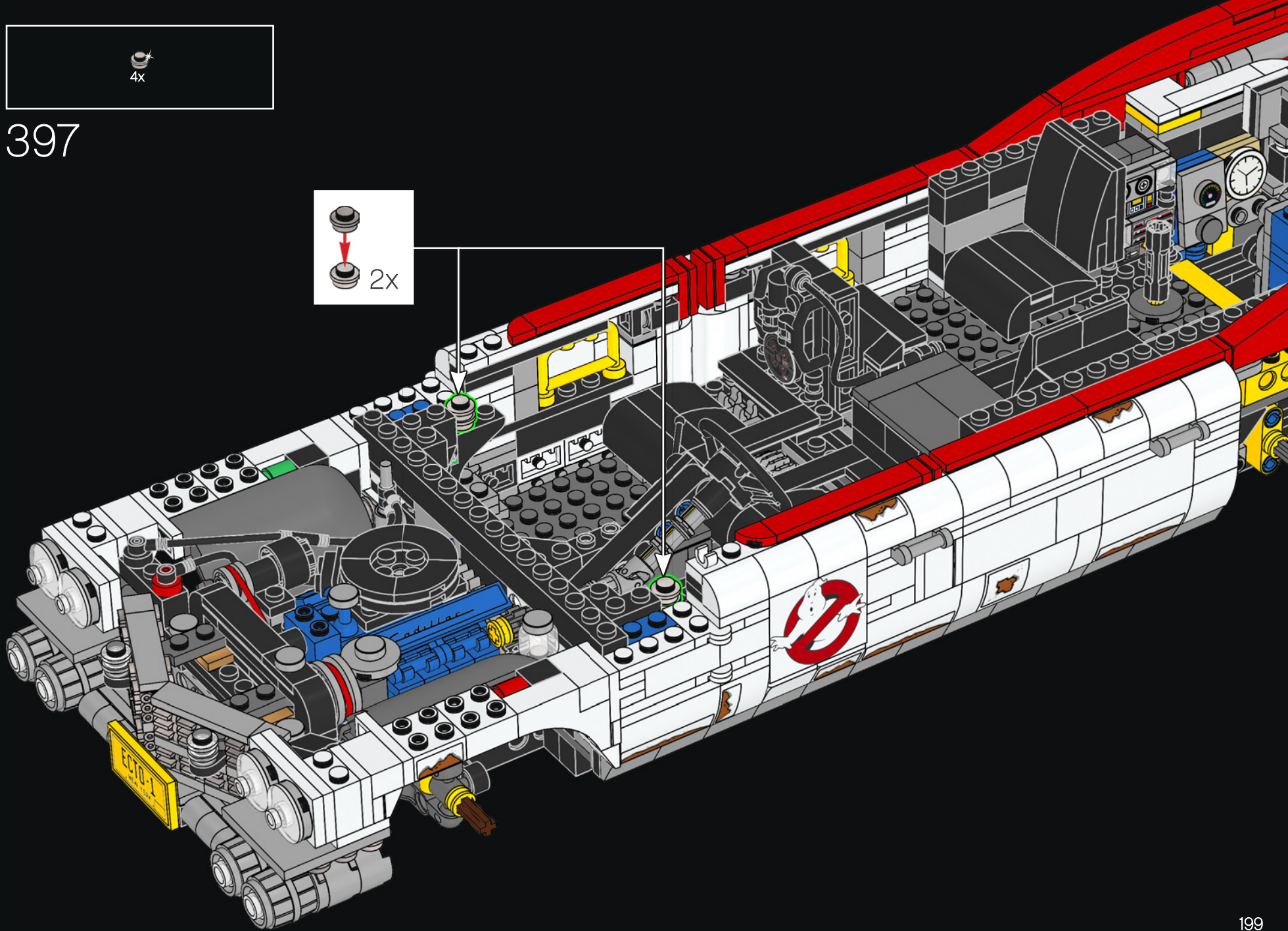
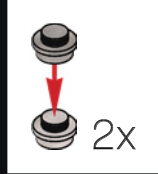

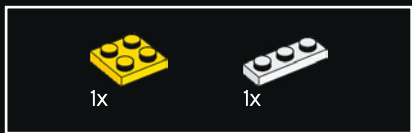

398

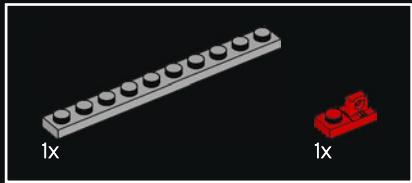
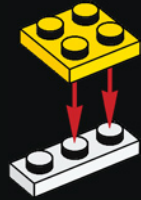

399

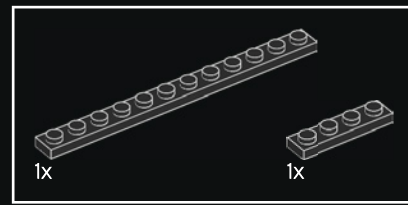
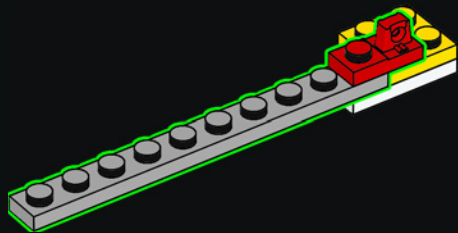

400

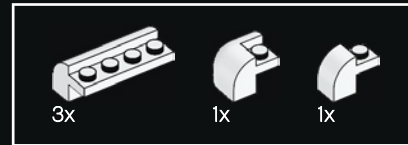
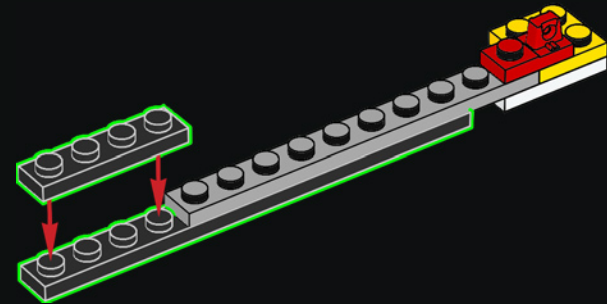

401

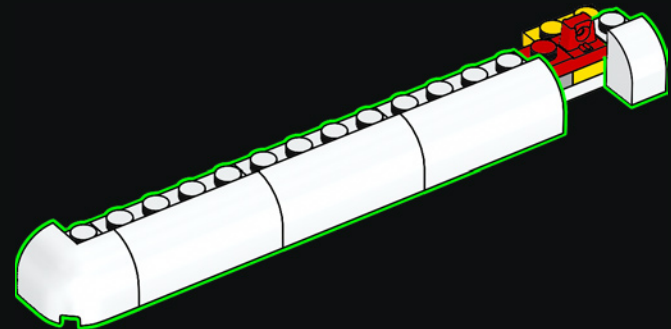

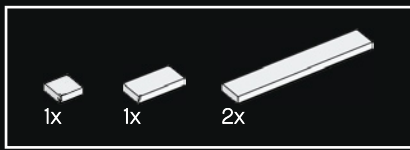

402

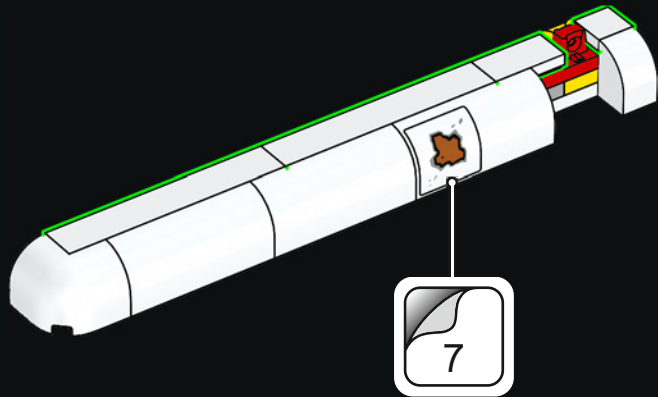

403

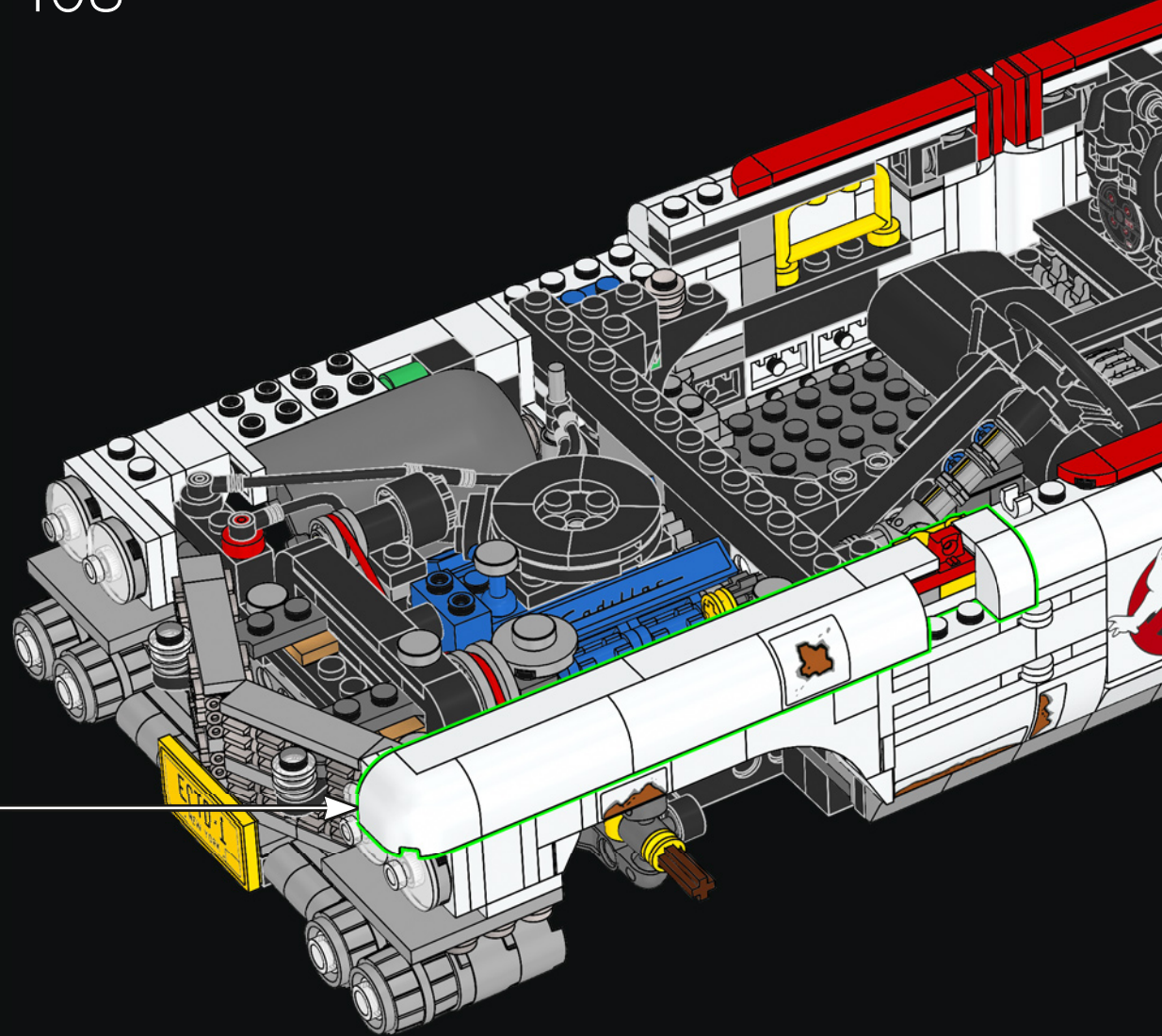

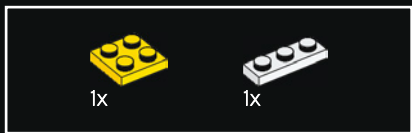

404

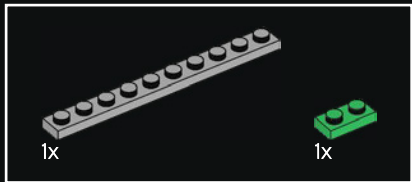
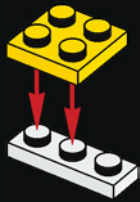

405

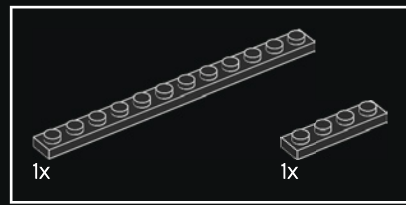
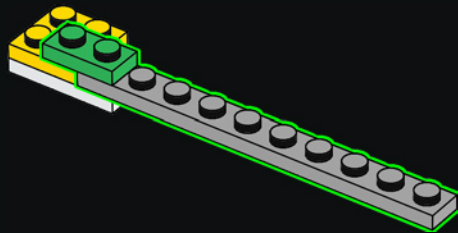

406

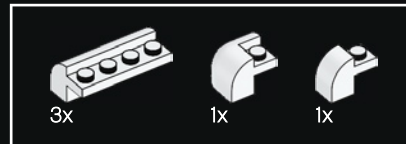
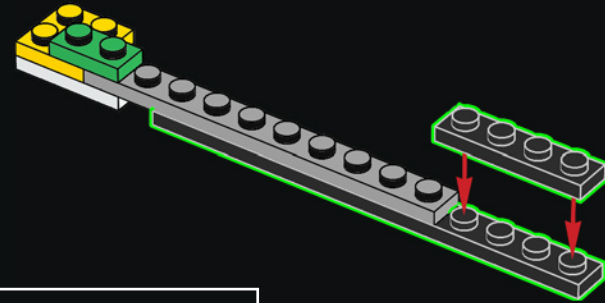

407

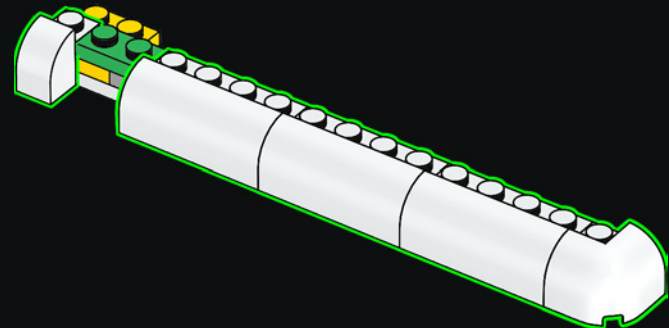

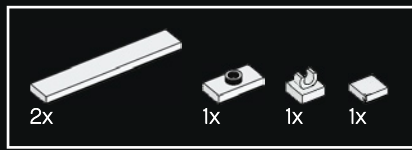

408

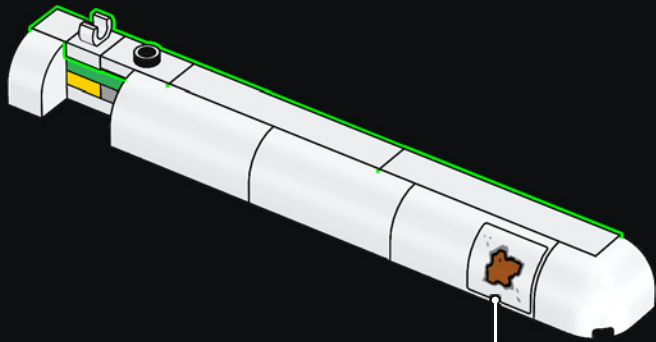

409

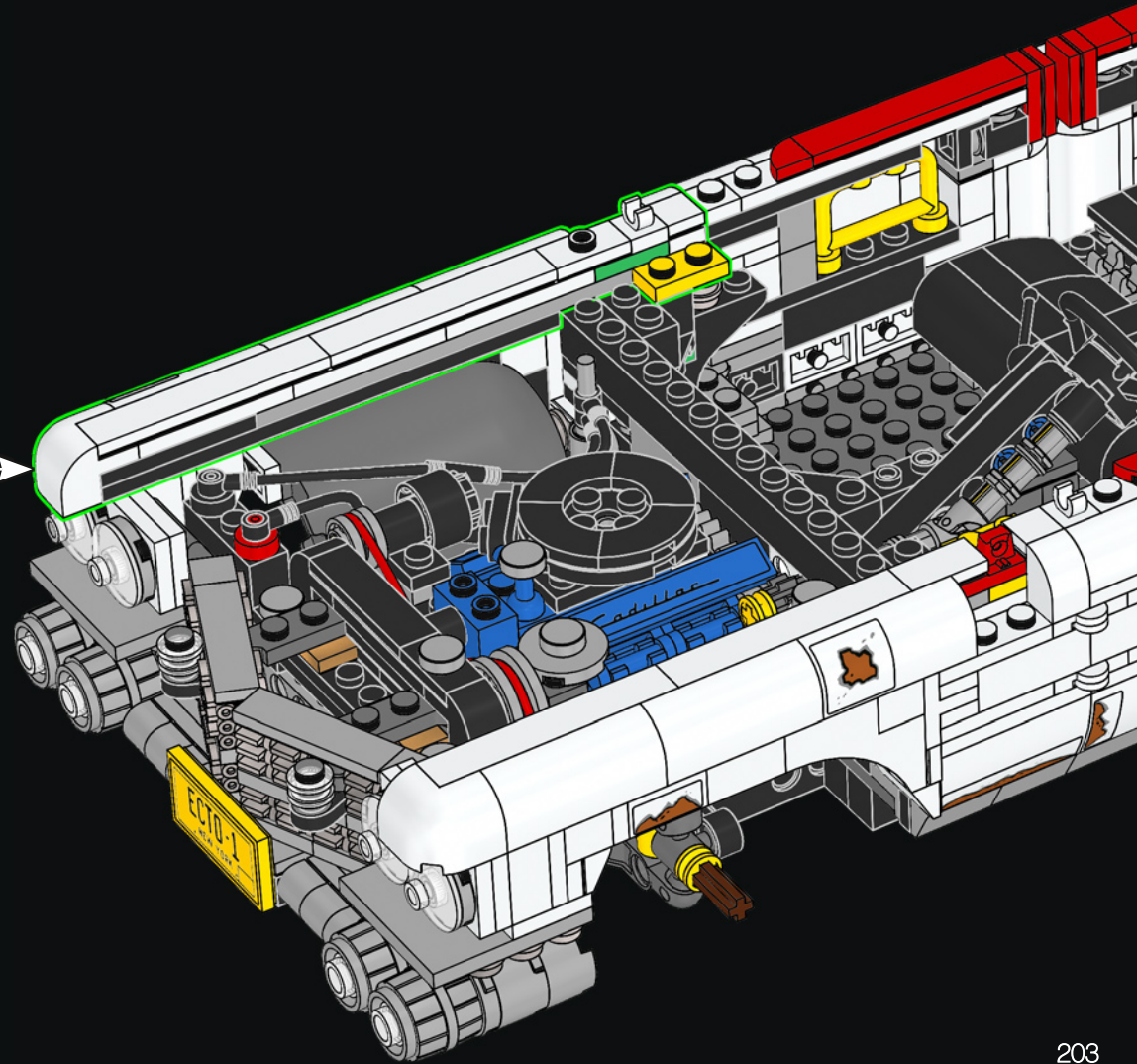

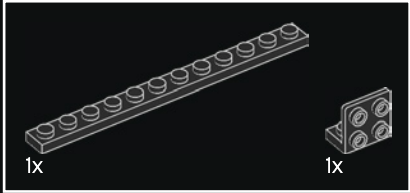
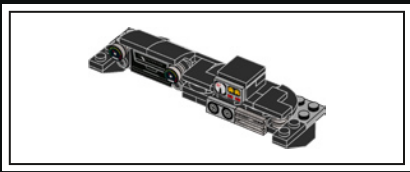

410

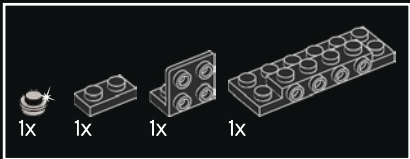
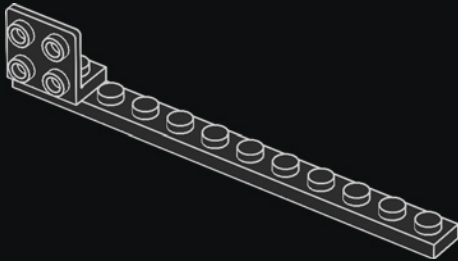

411

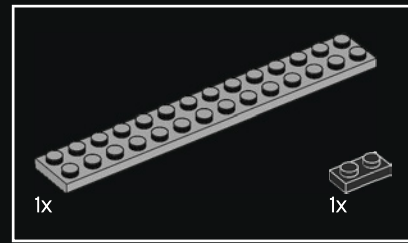
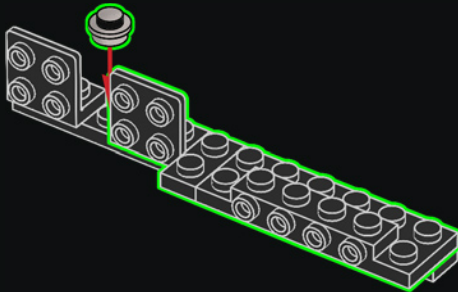

412

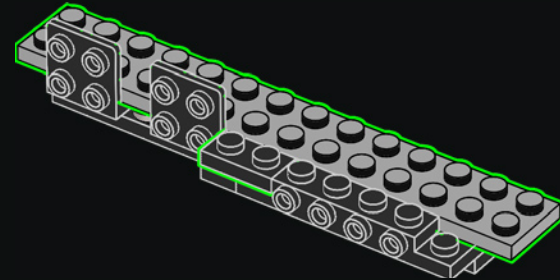

413

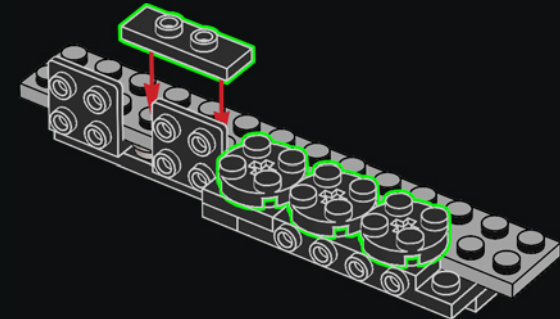

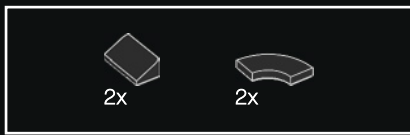

414

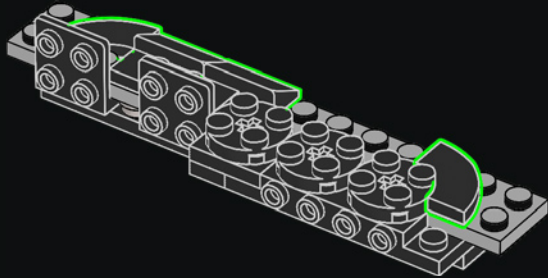

415

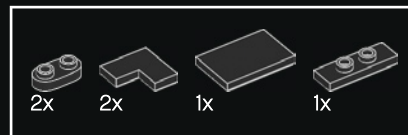
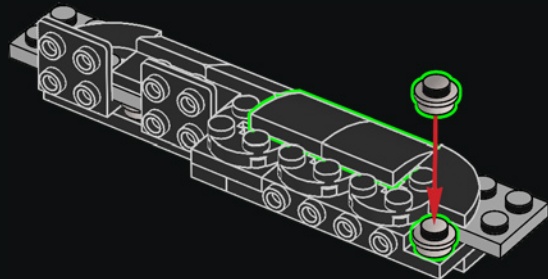

416

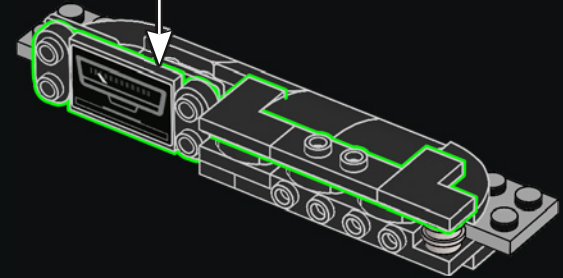
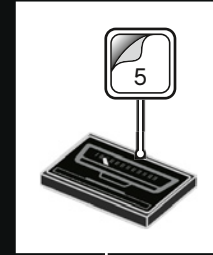

417

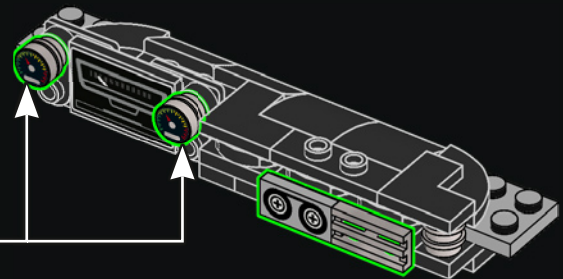

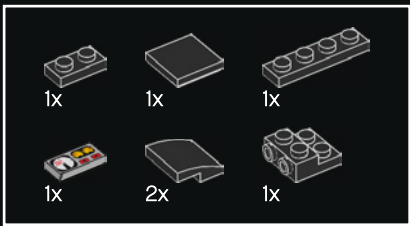

418

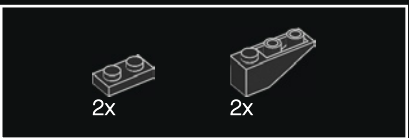
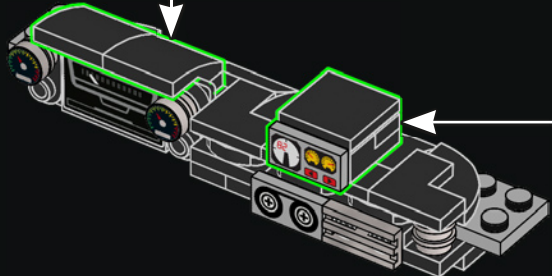
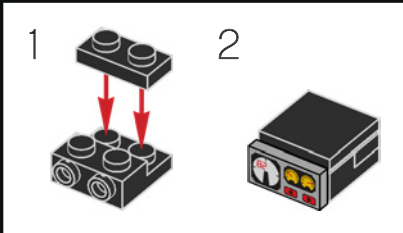
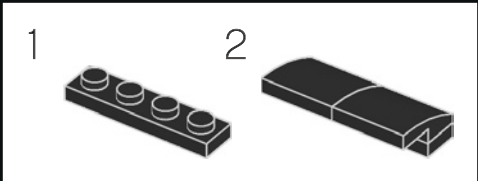

419

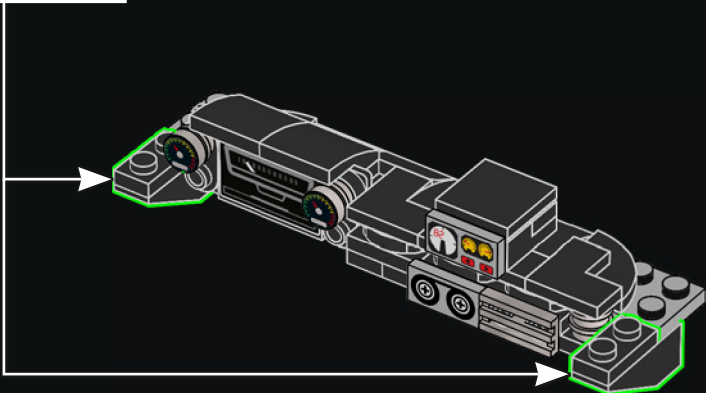
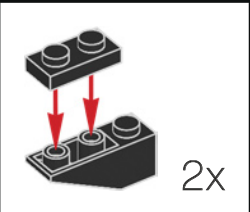

420

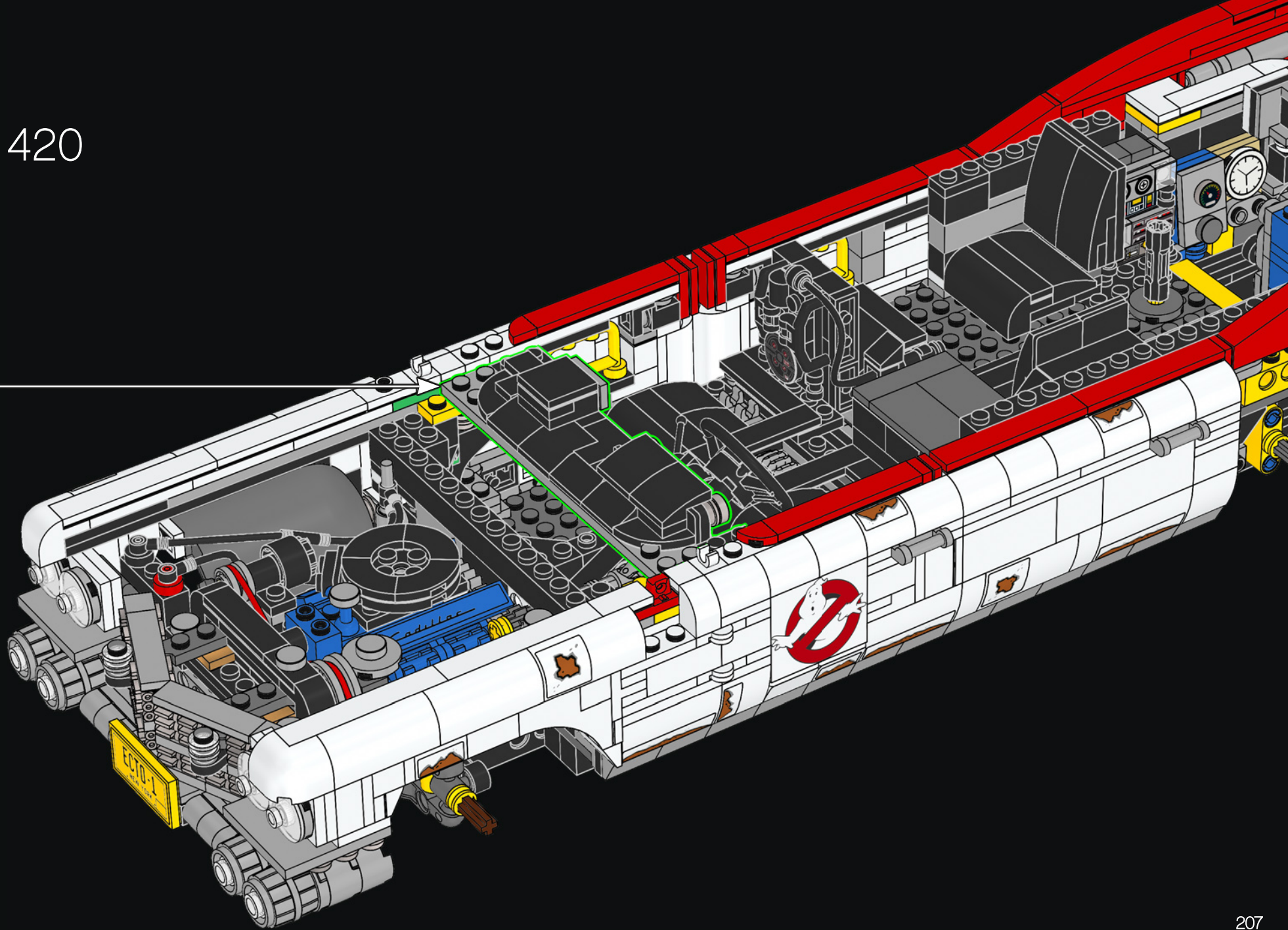

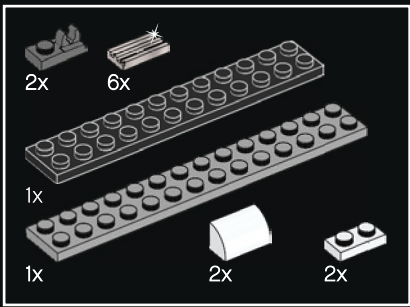

421

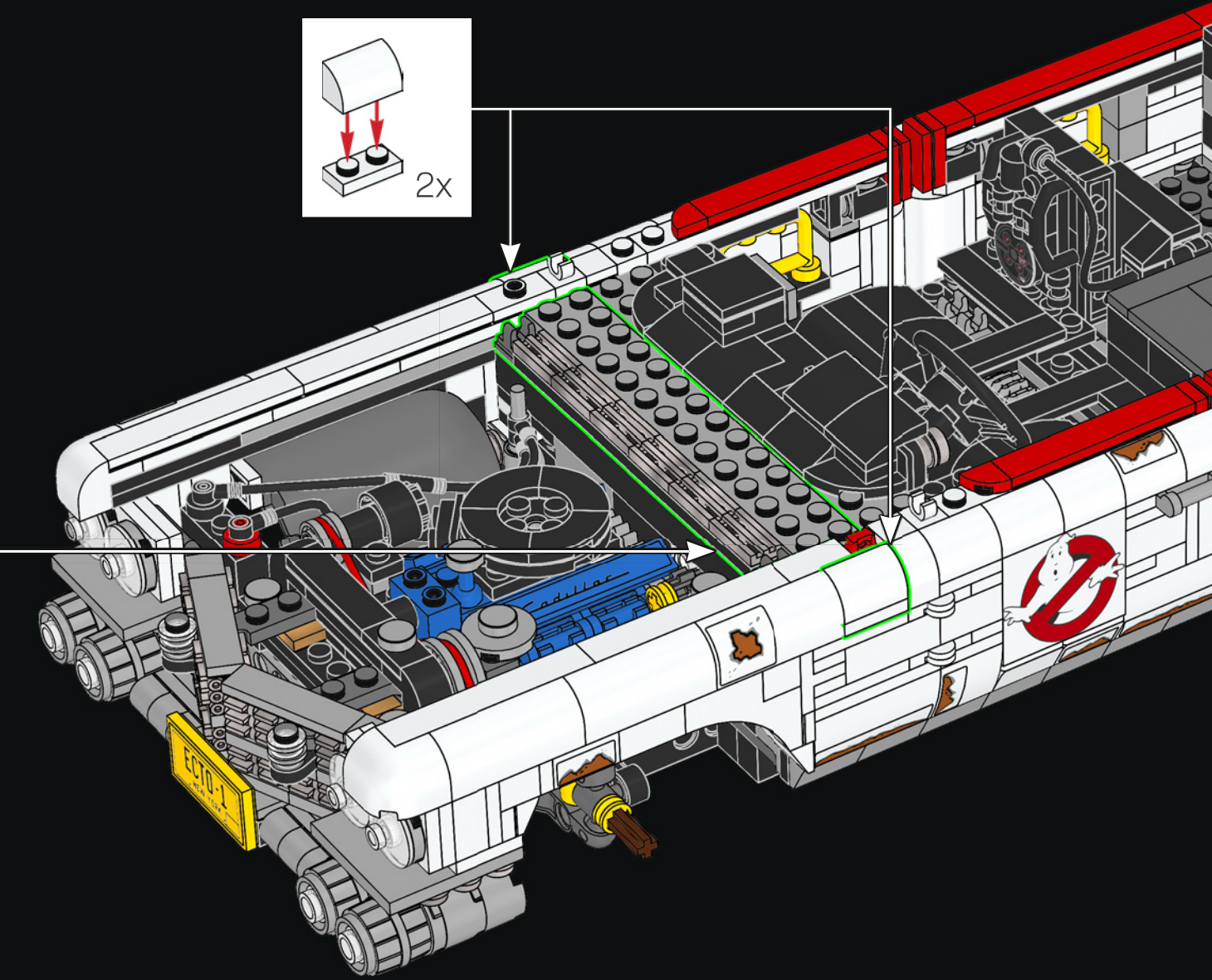
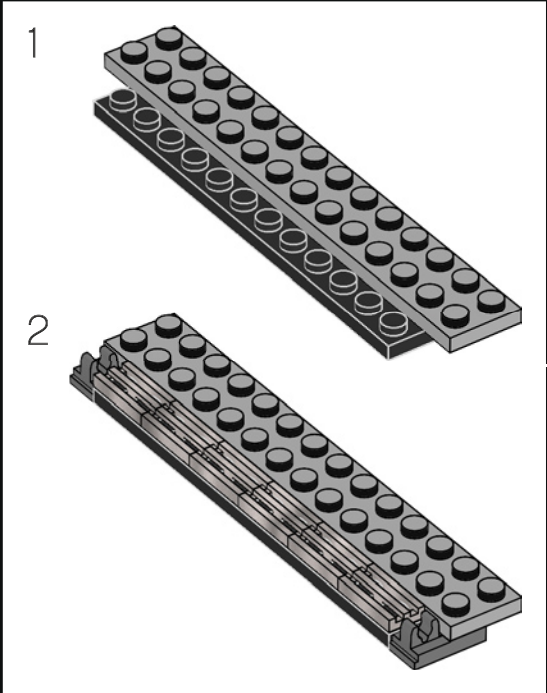
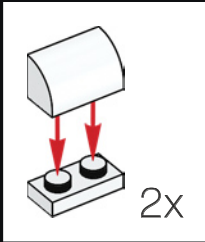

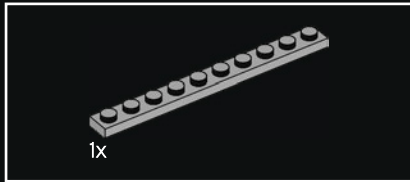
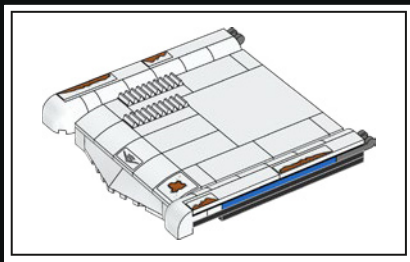

422

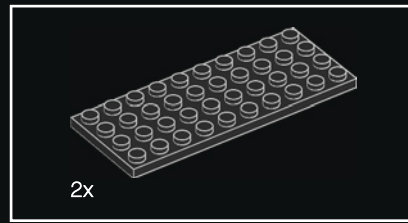
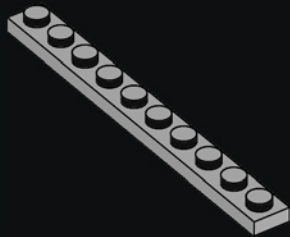

2x

423

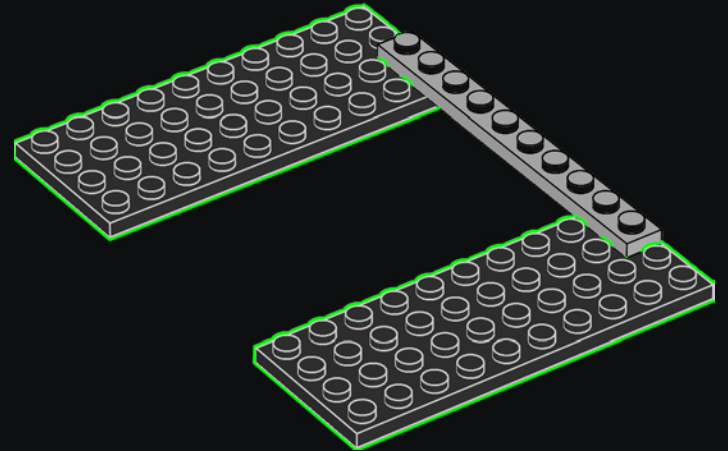

4x

424

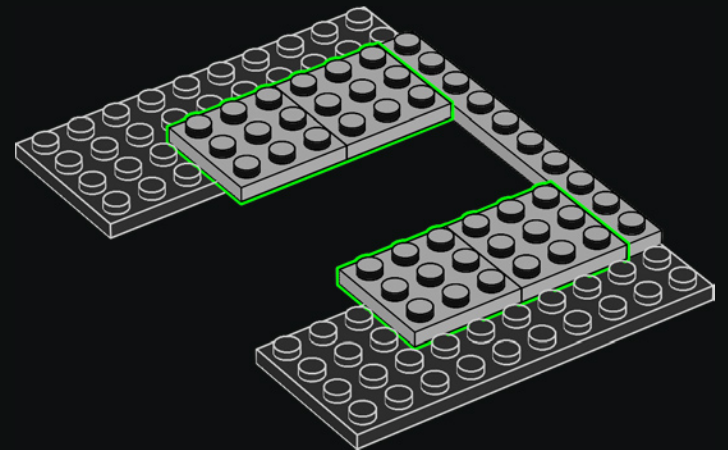

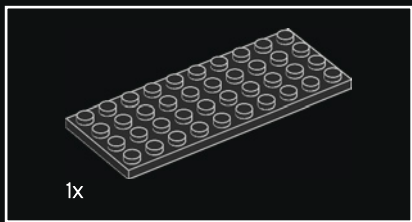

425

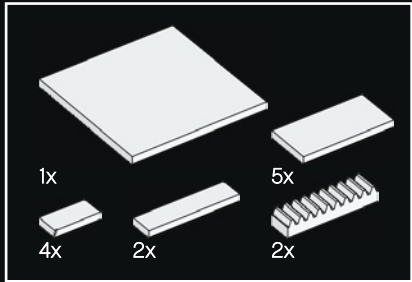
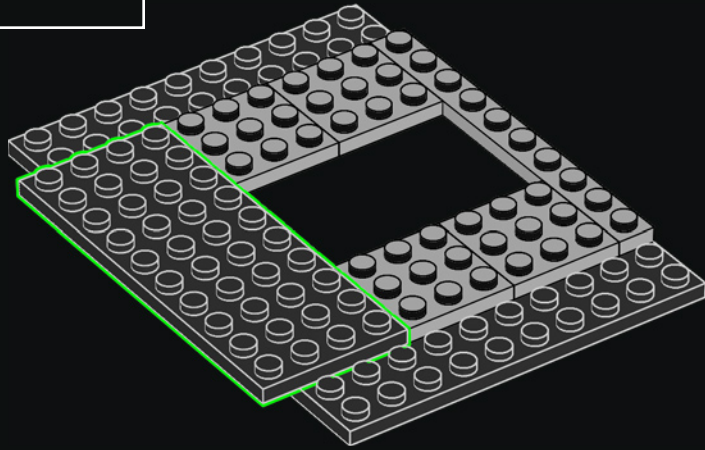

426

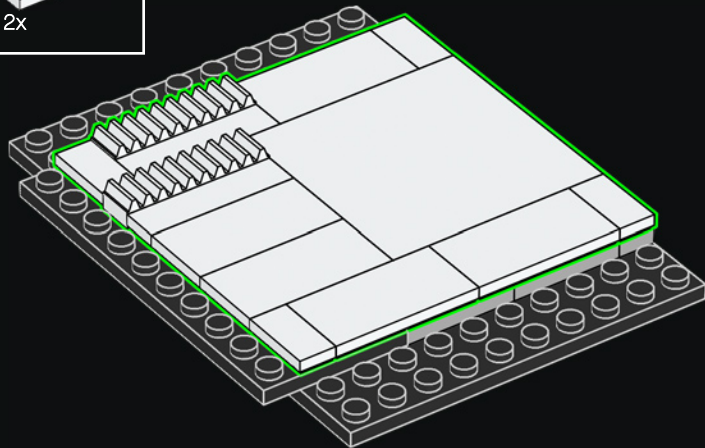

427

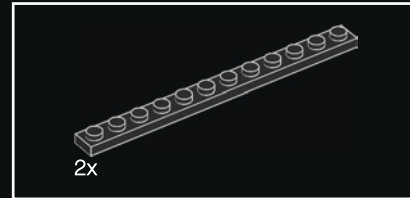
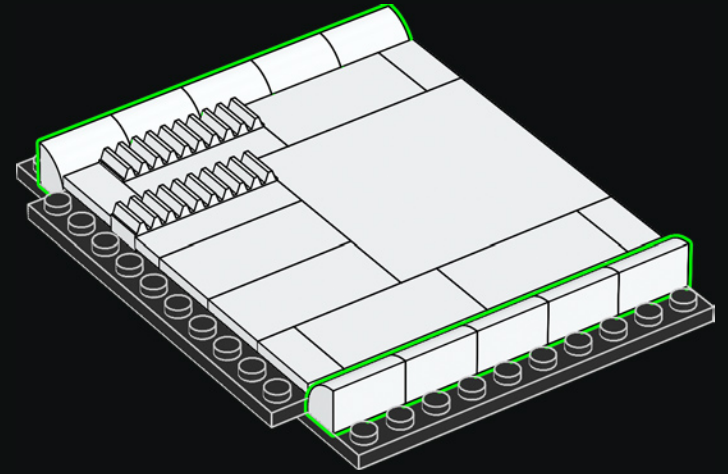

428

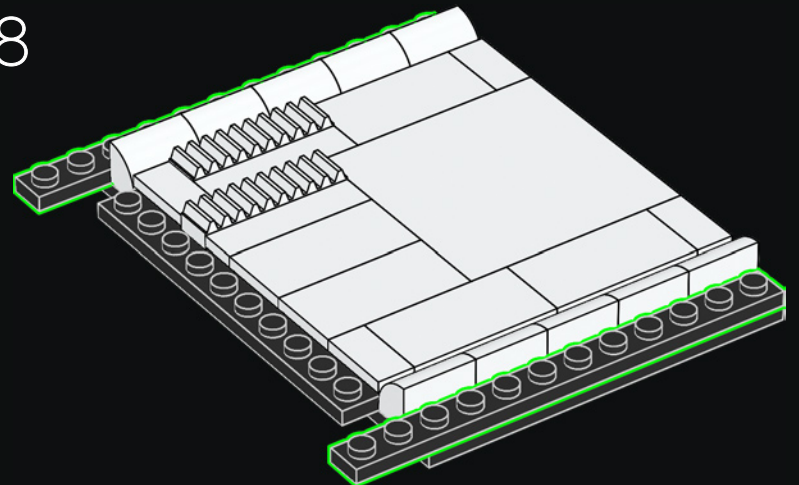

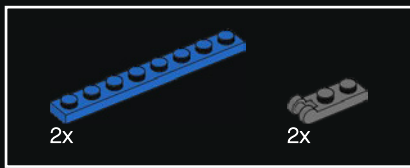

429

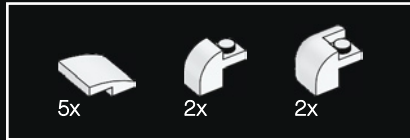
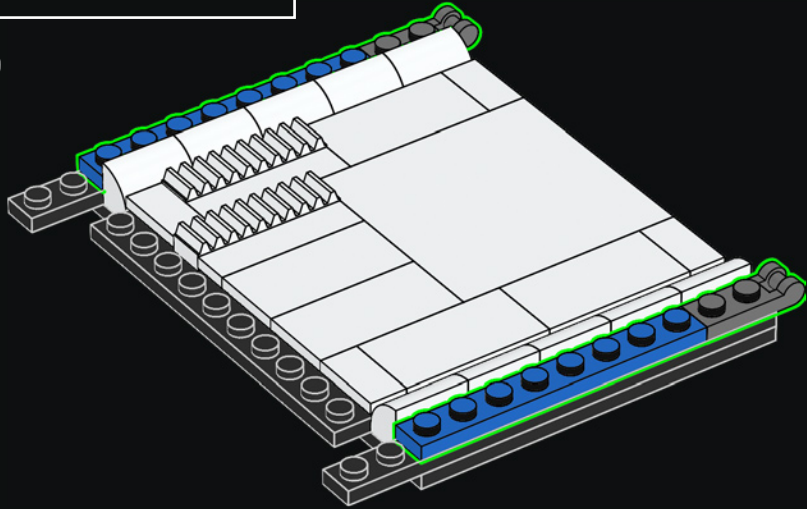

430

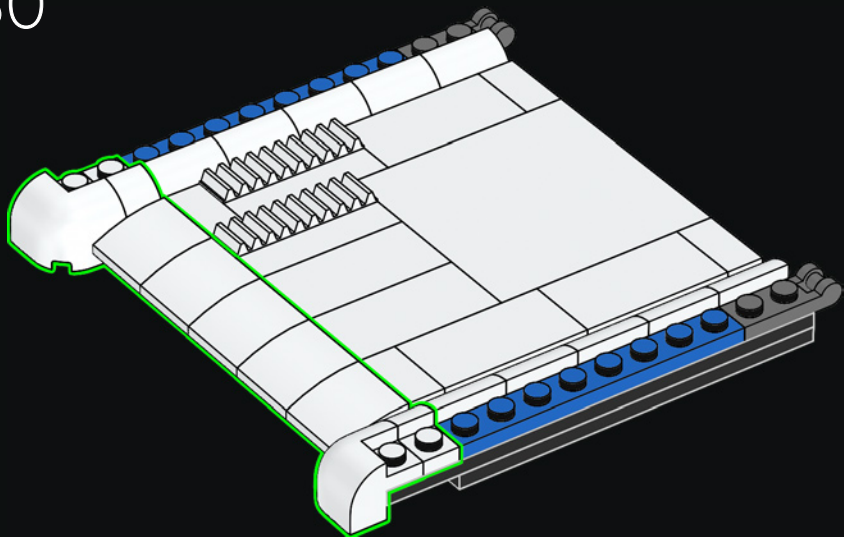

431

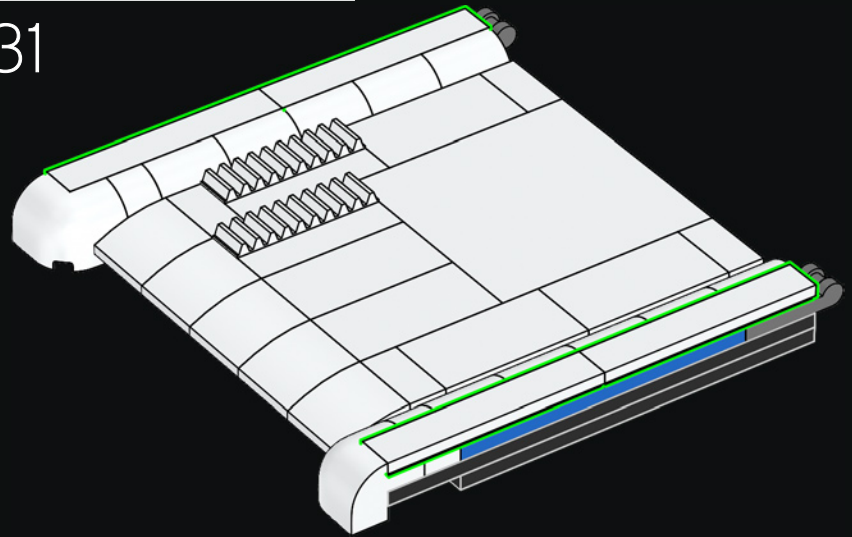

432

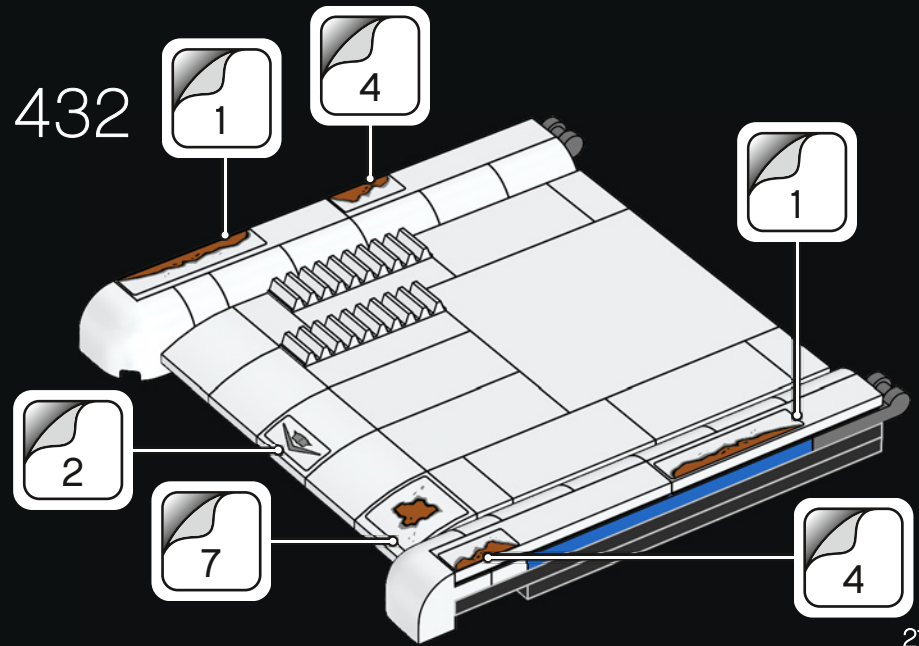

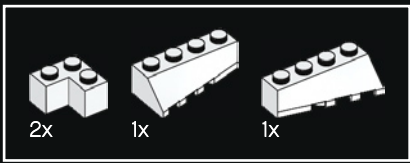

433

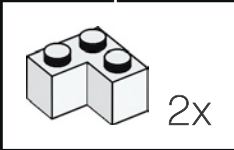
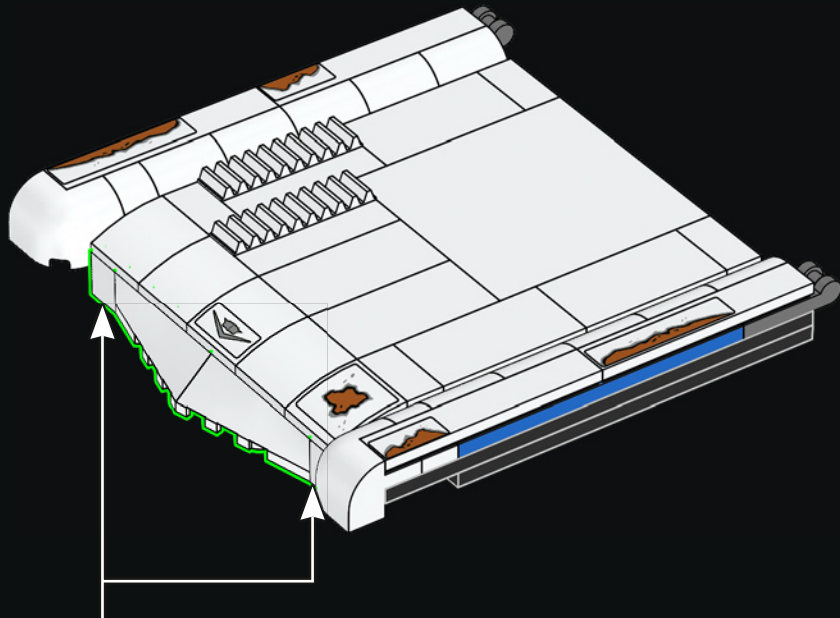

434

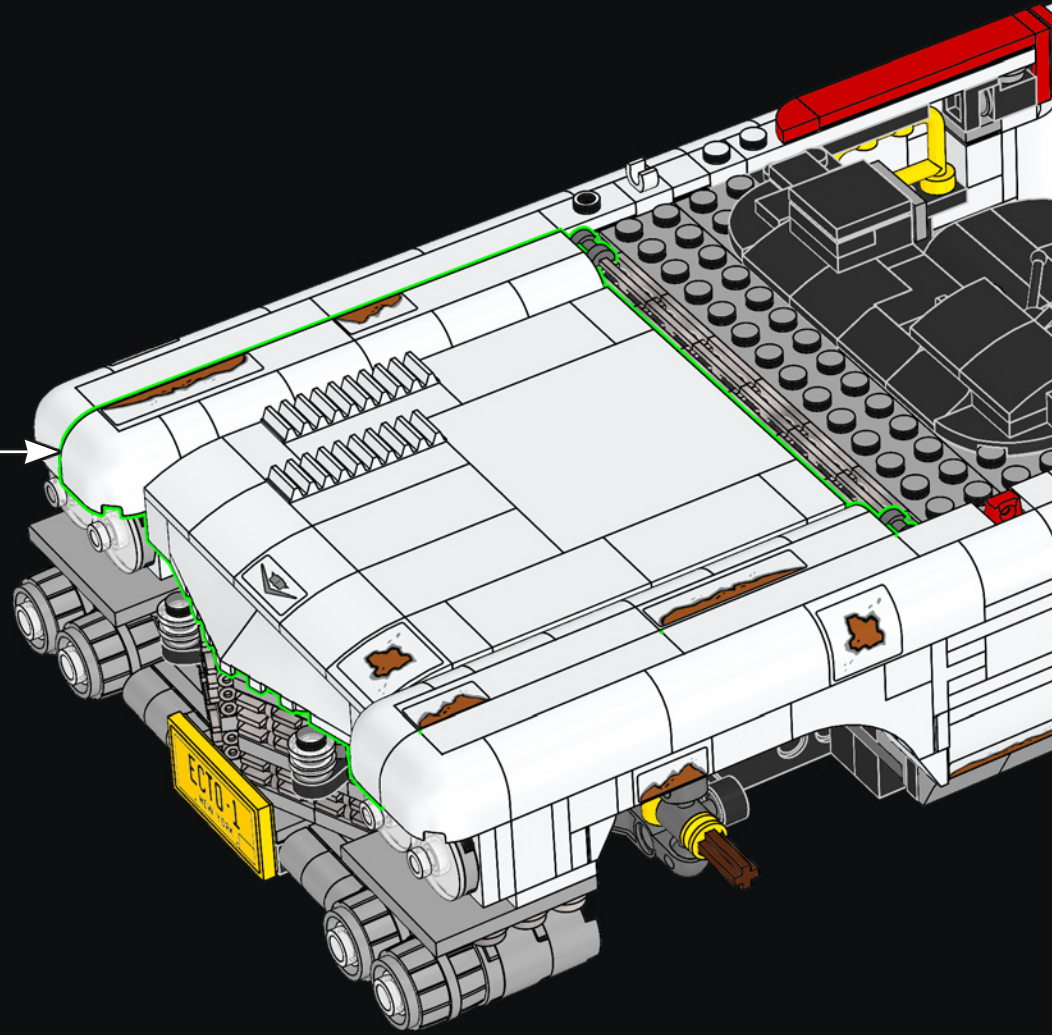

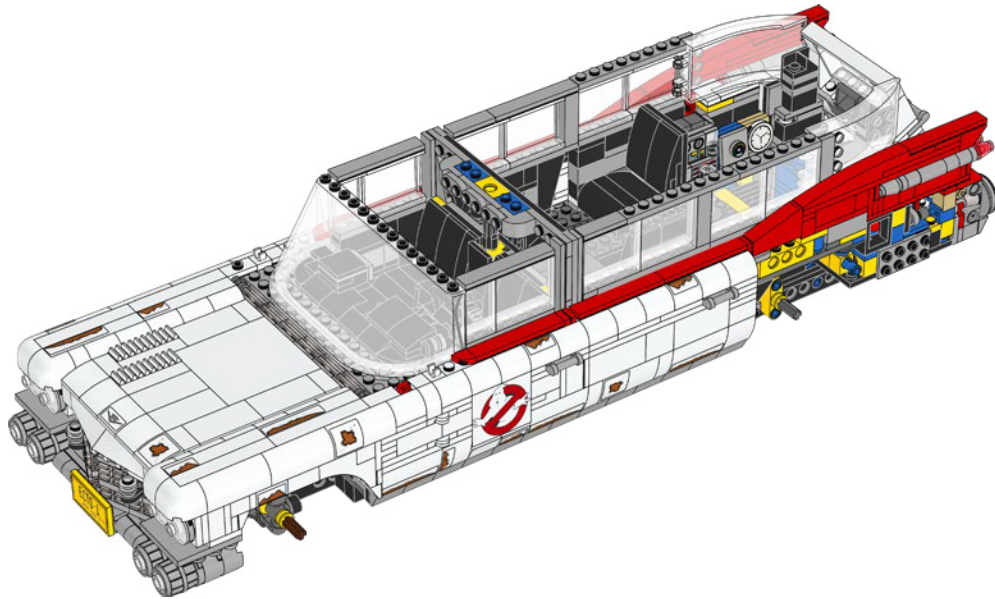
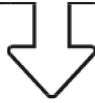
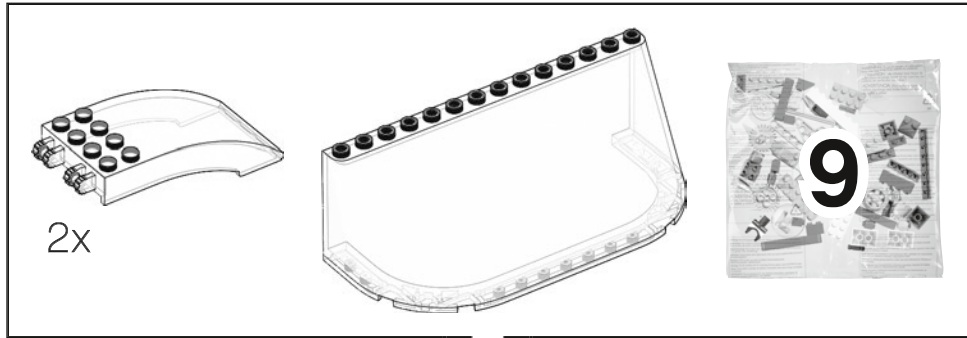

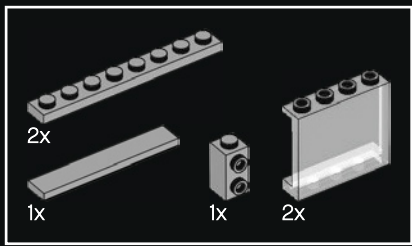

435

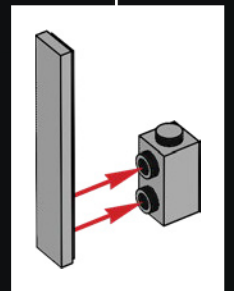
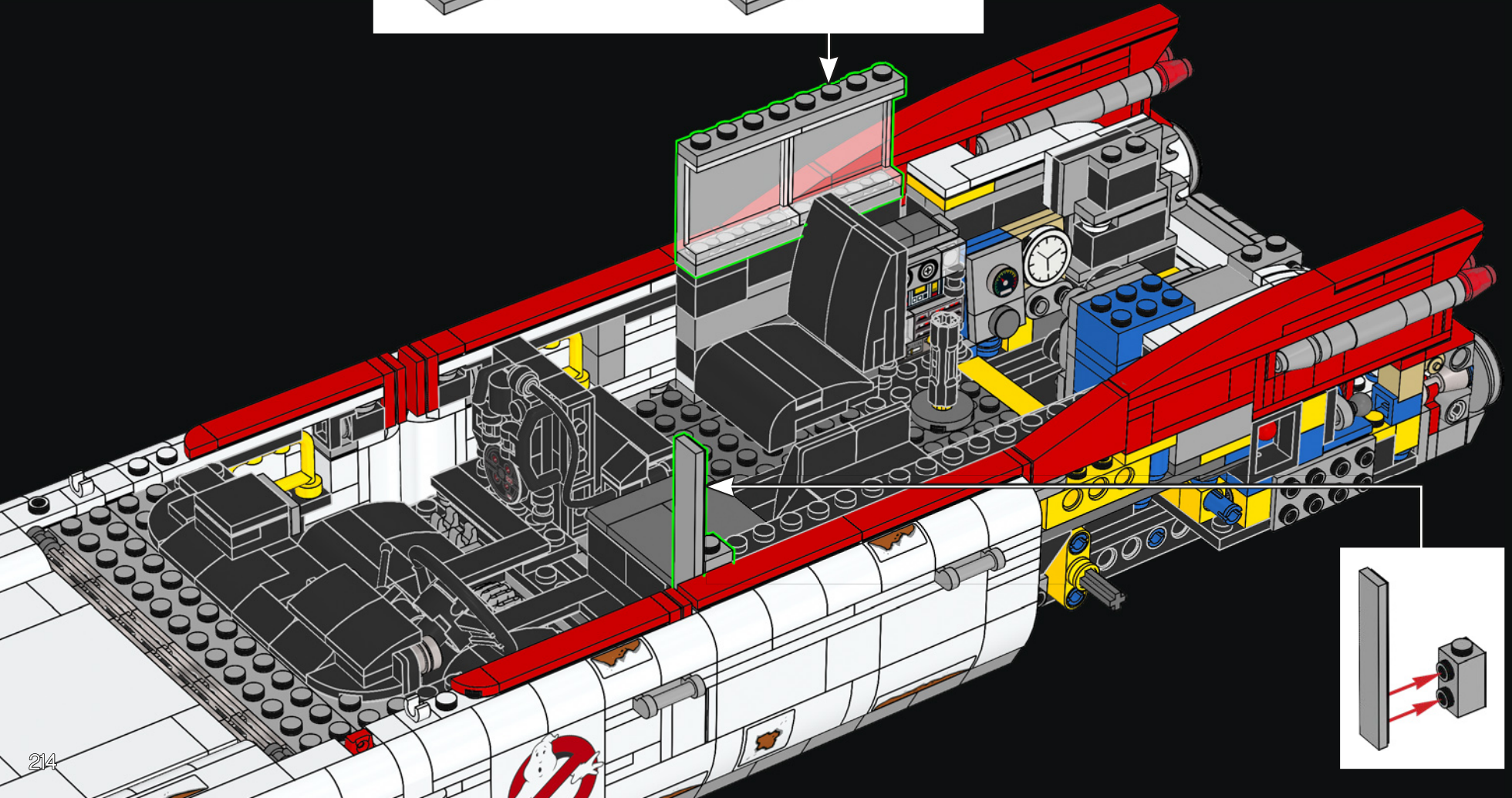
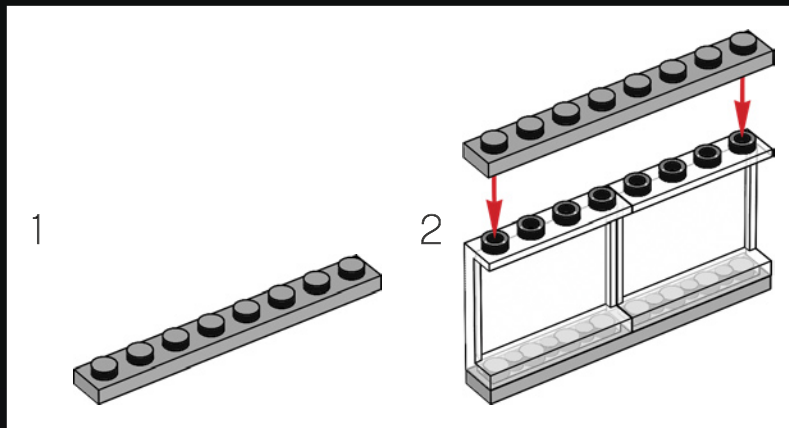

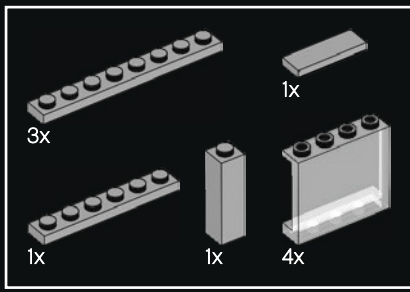

436

1

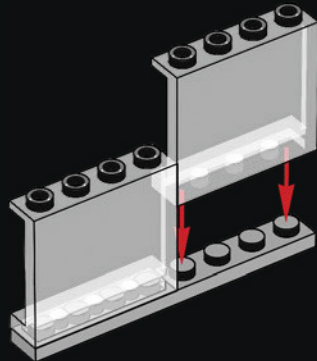

2

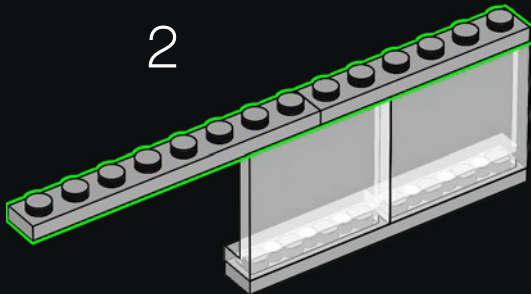

3

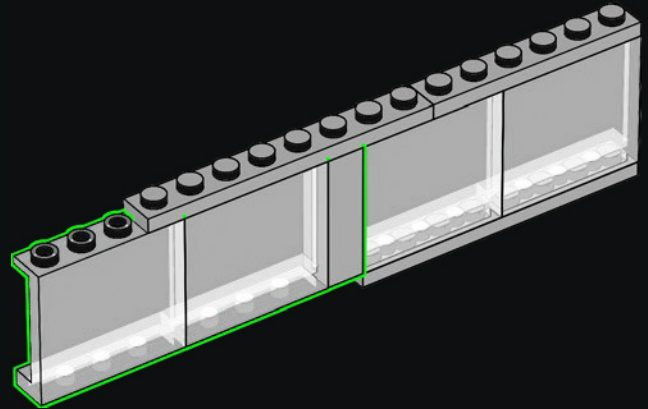

4

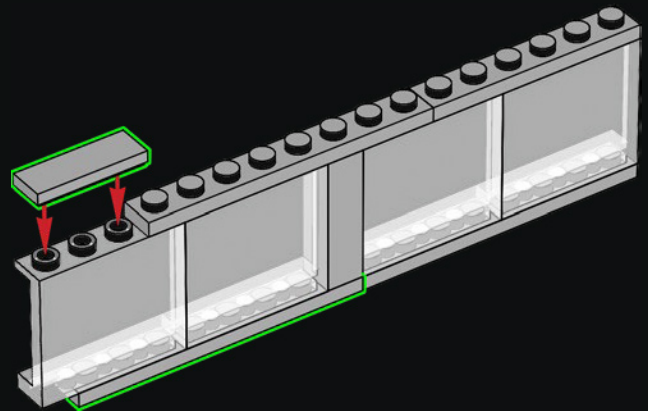

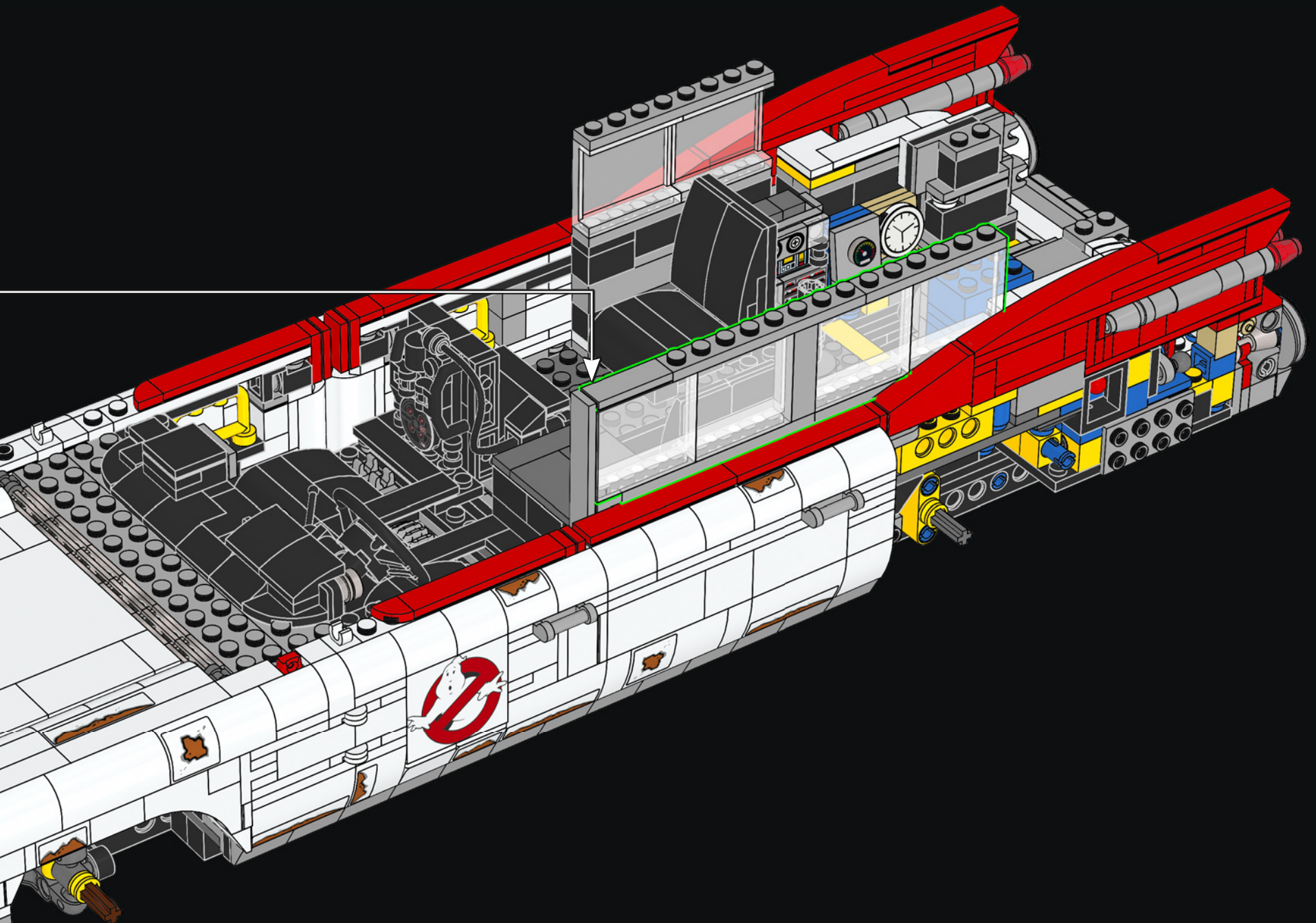

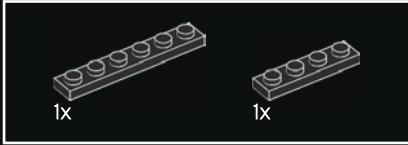
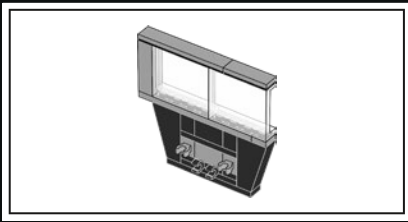

437

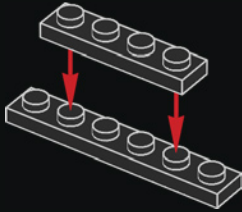

438

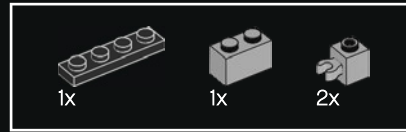
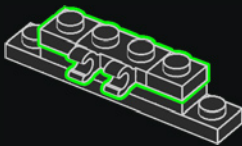

439

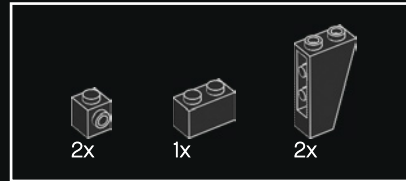
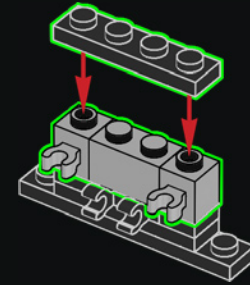

440

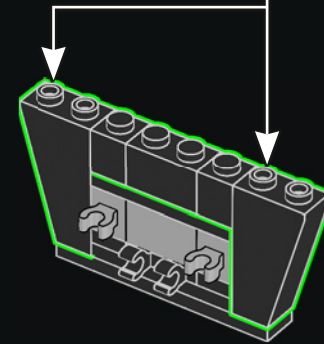
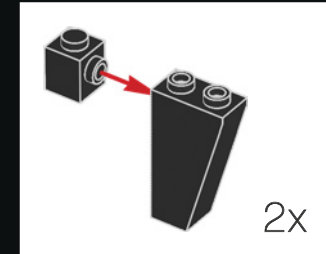

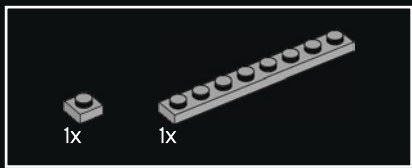

441

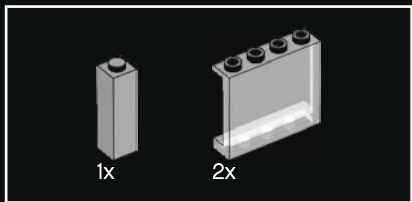
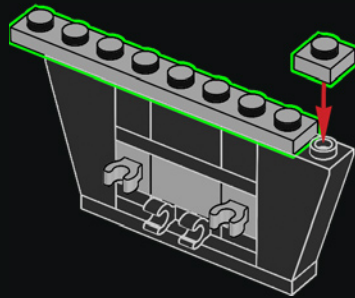

442

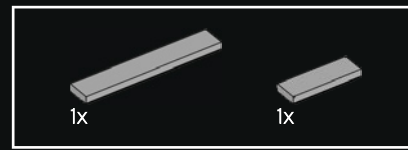
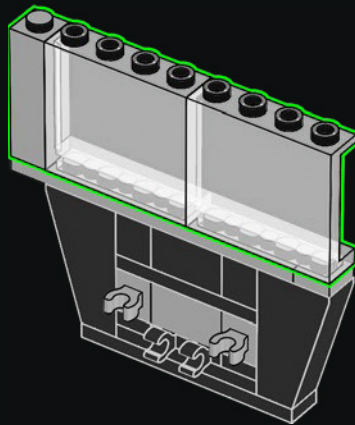

443



444

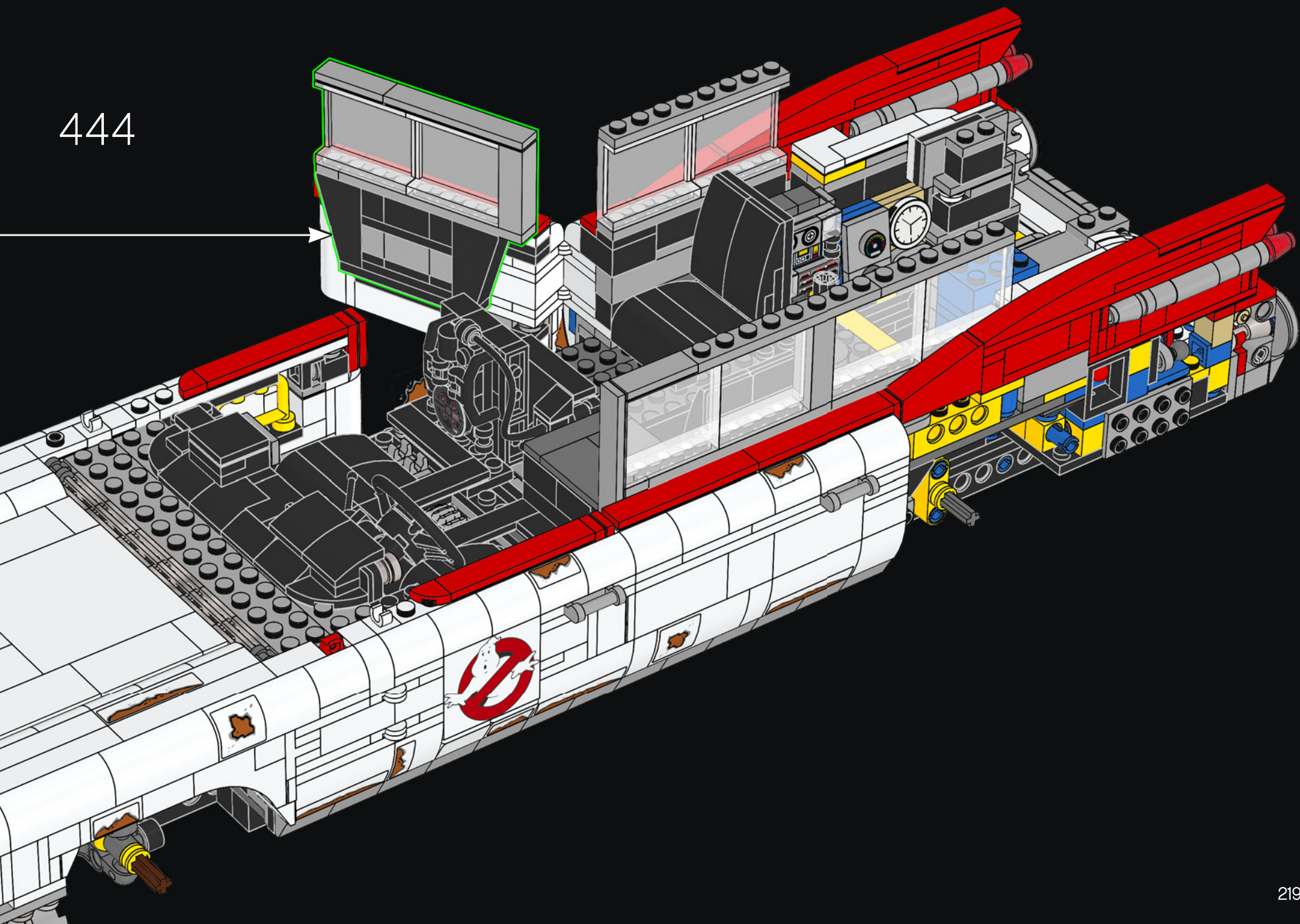

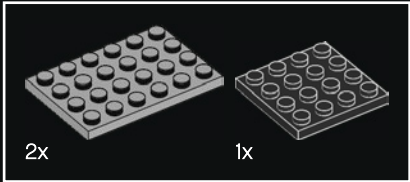
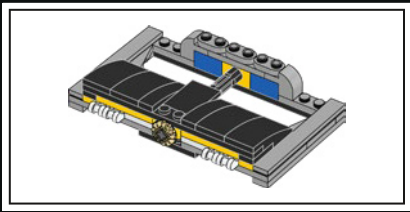

445

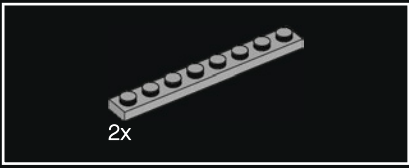
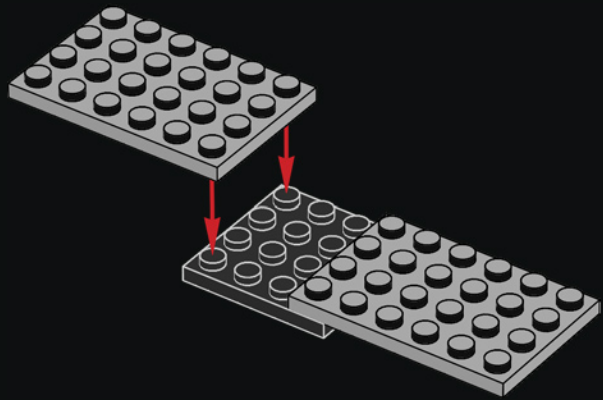

446

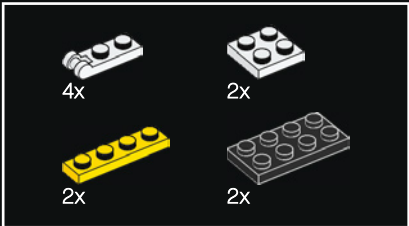
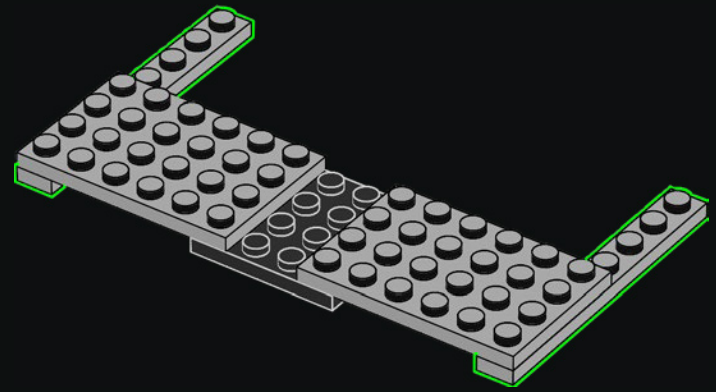

447

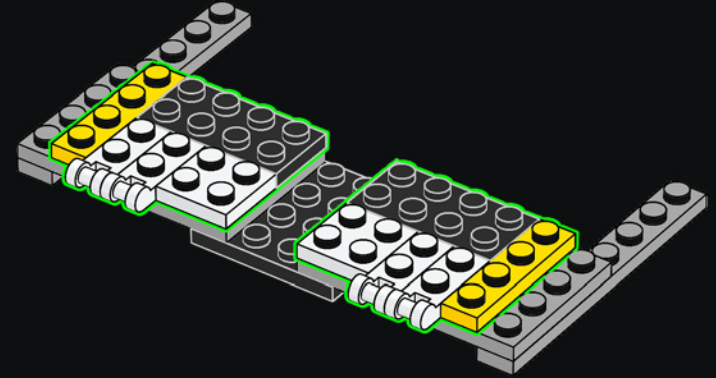

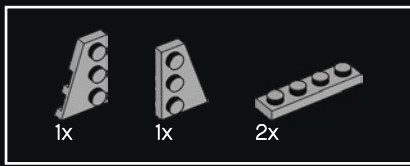

448

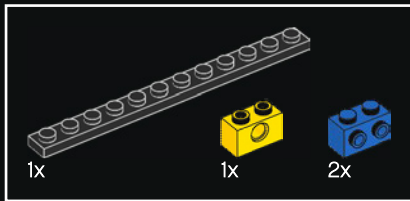
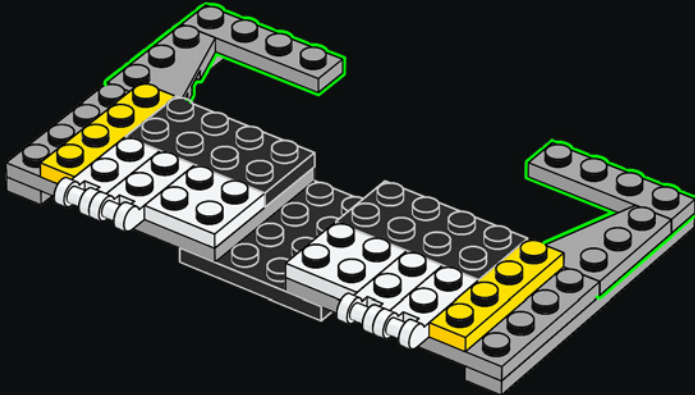

449

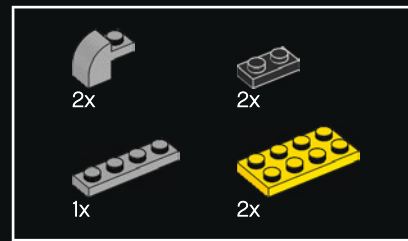
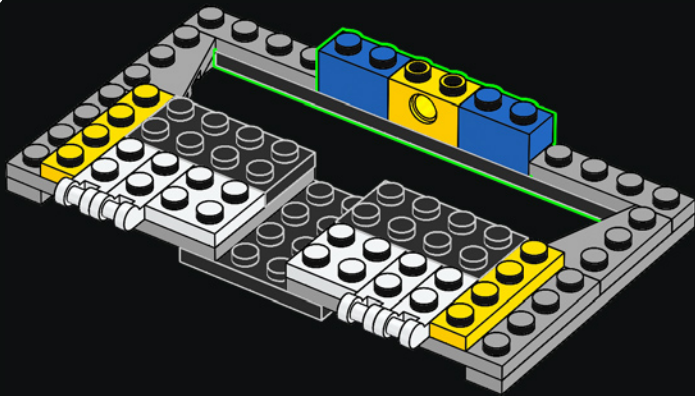

450

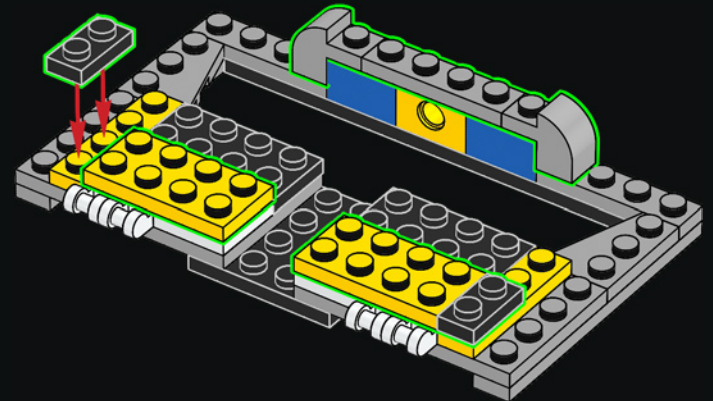

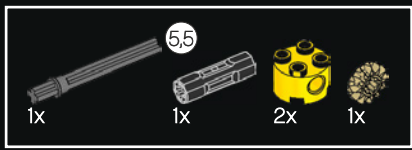

451

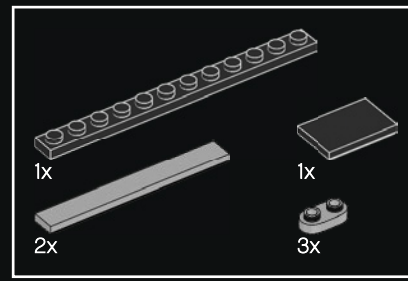
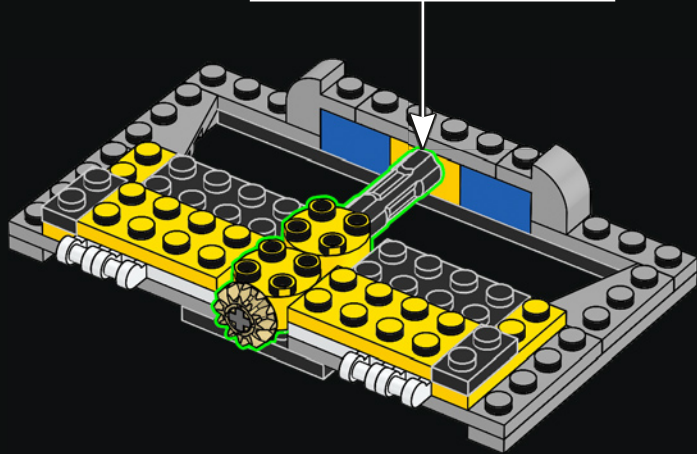
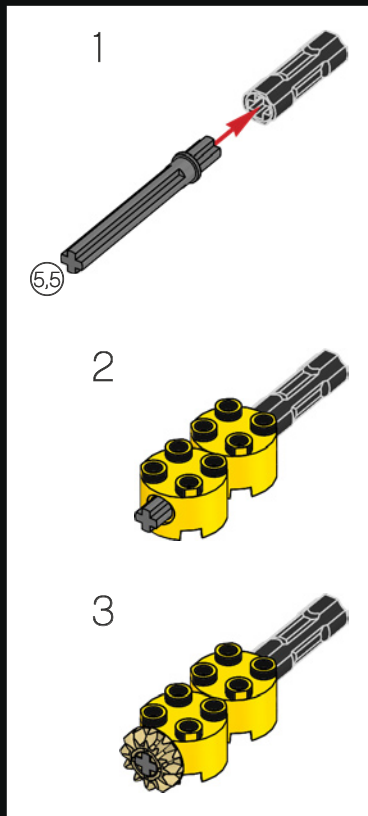

452

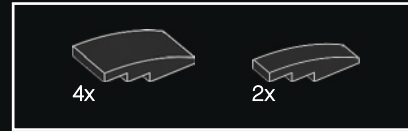
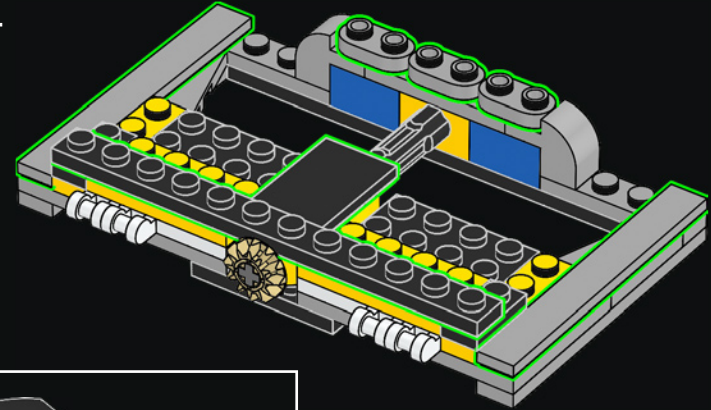

453

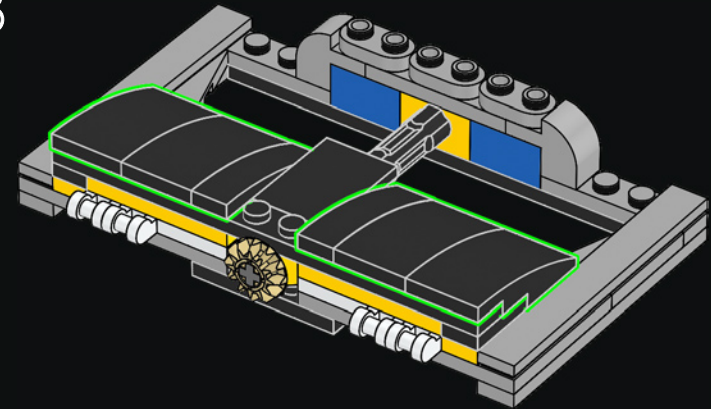

454

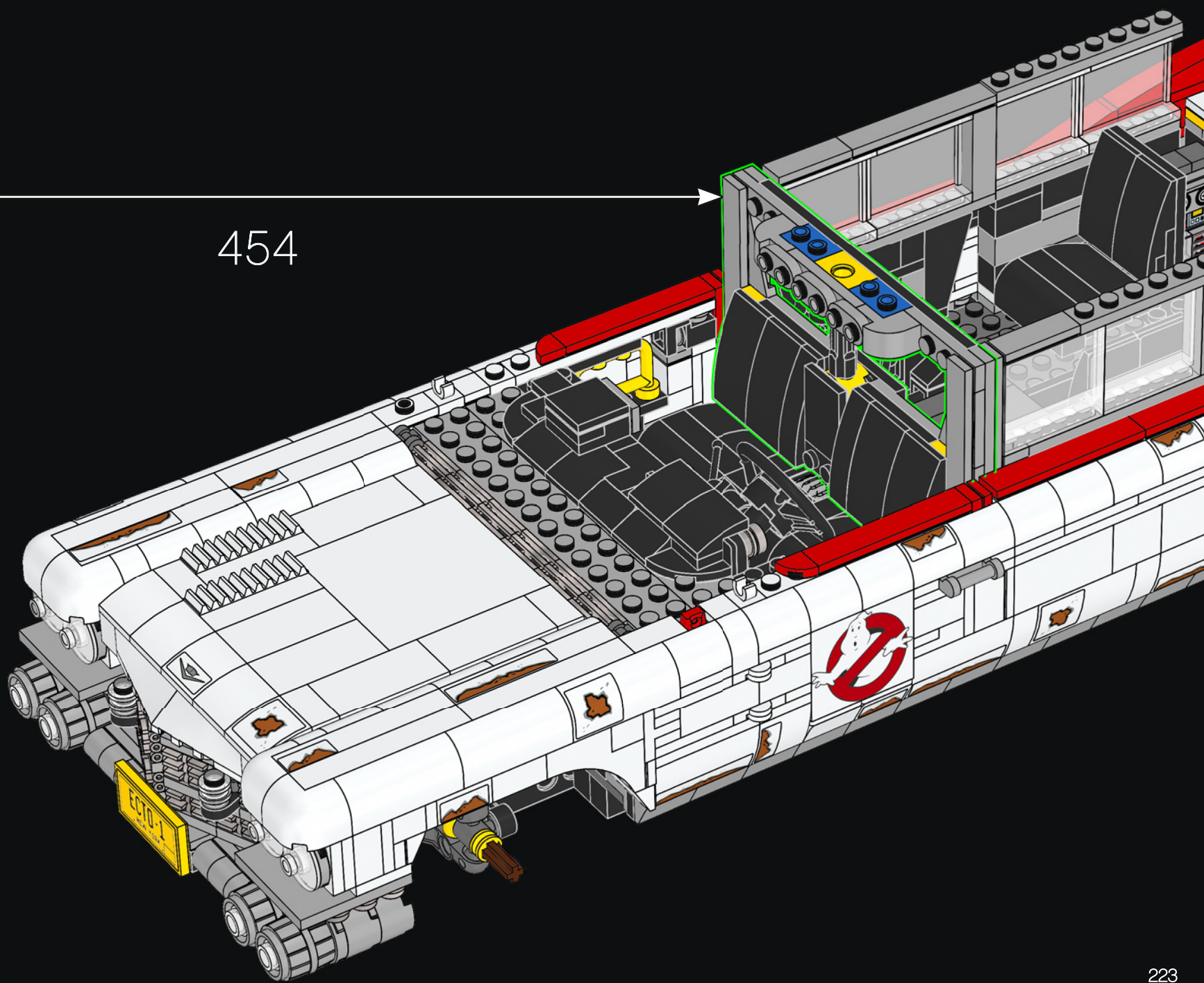

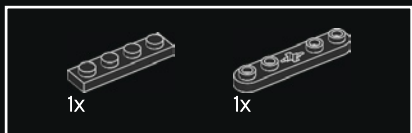

455

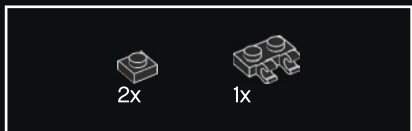
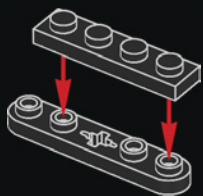

456

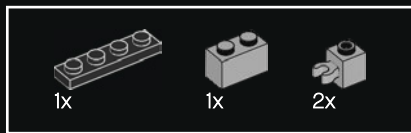
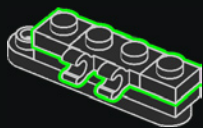

457

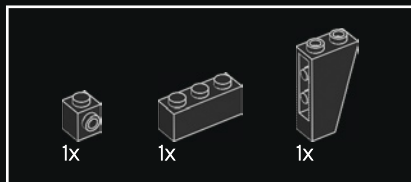
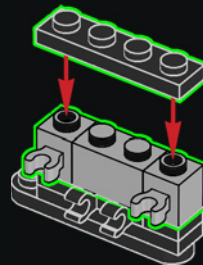

458

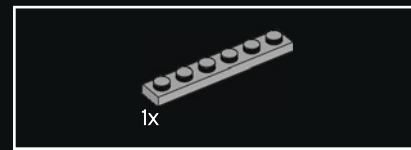
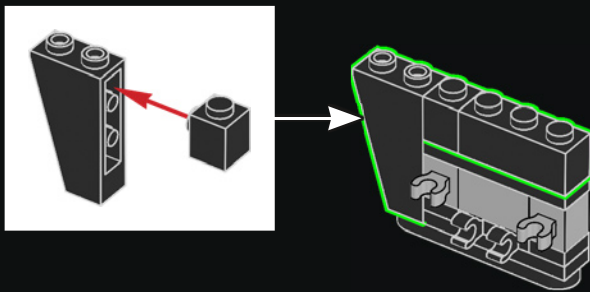

459

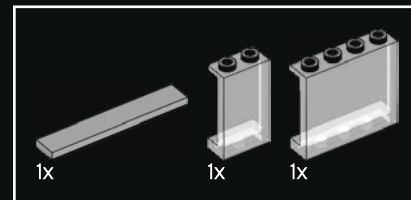
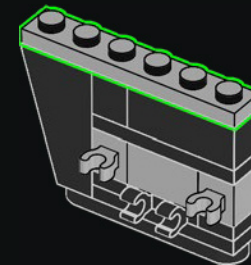

460

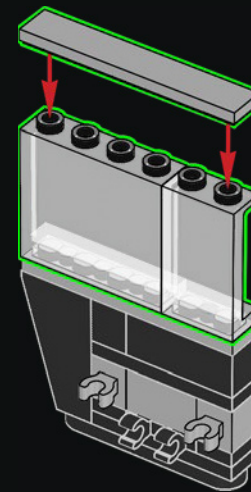

461

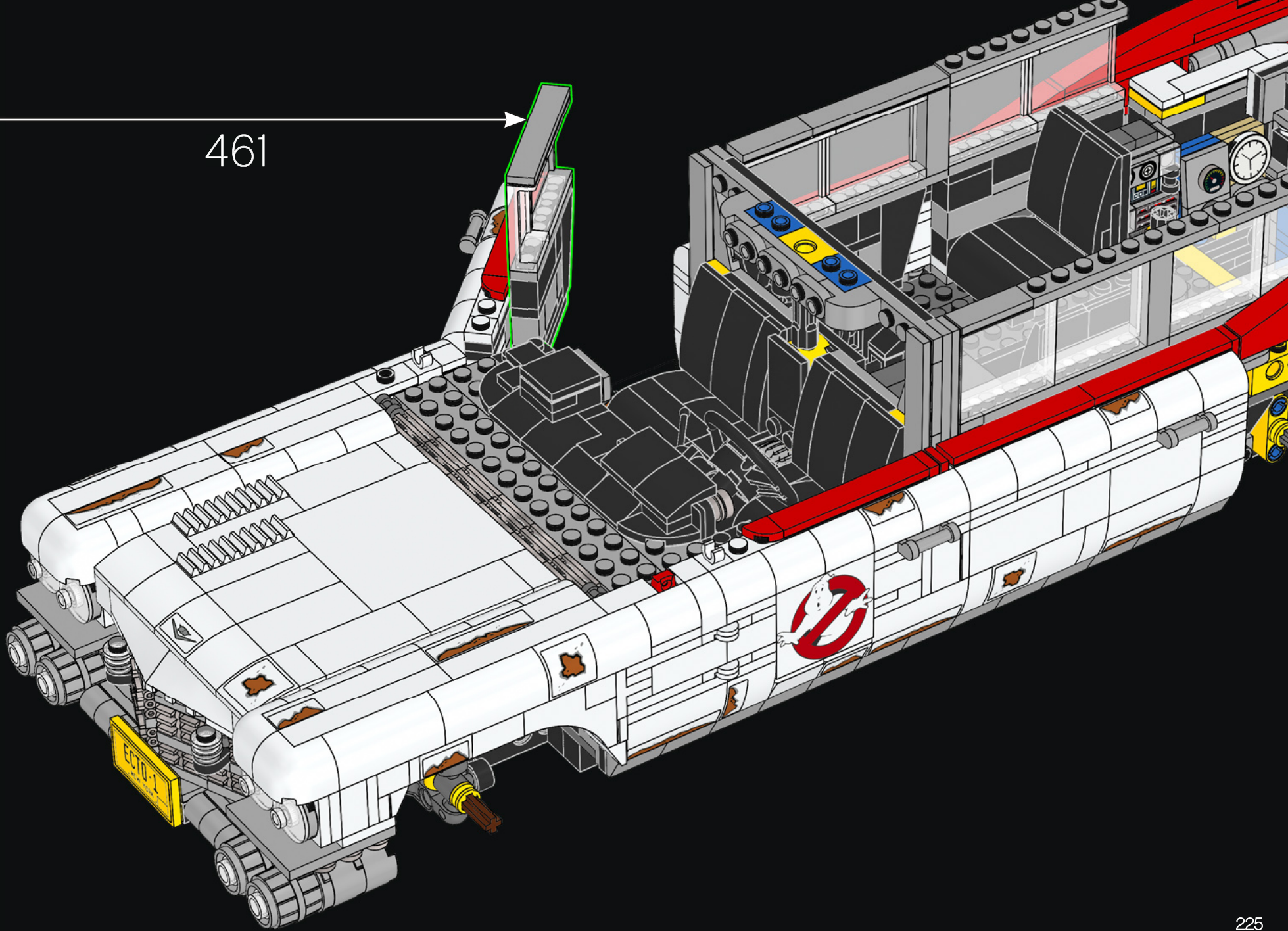

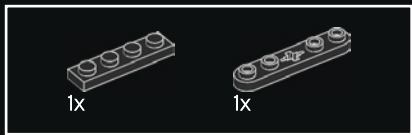

462

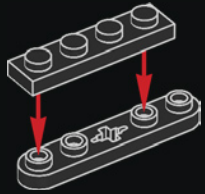

463

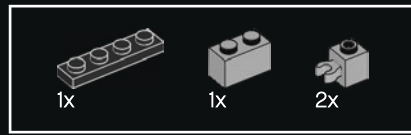
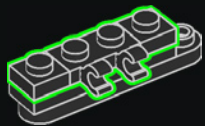

464

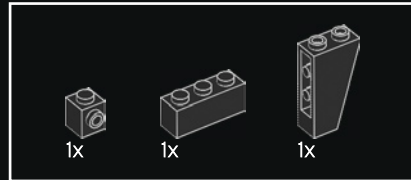
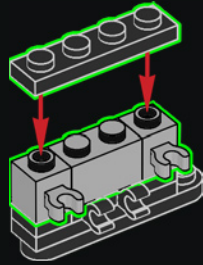

465

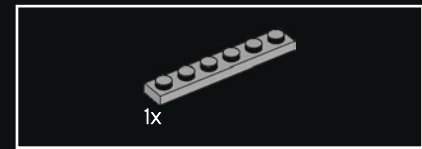
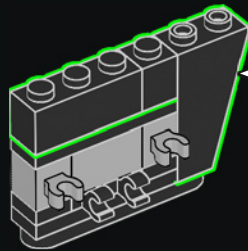
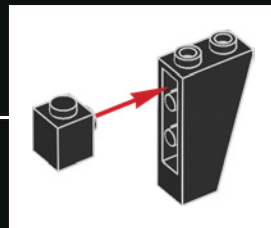

466

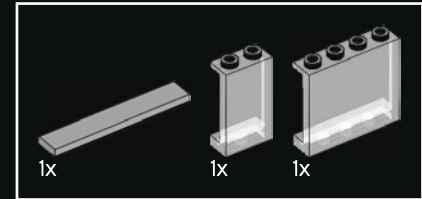
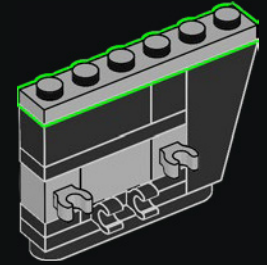

467

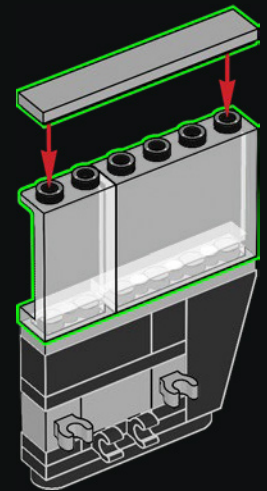

468

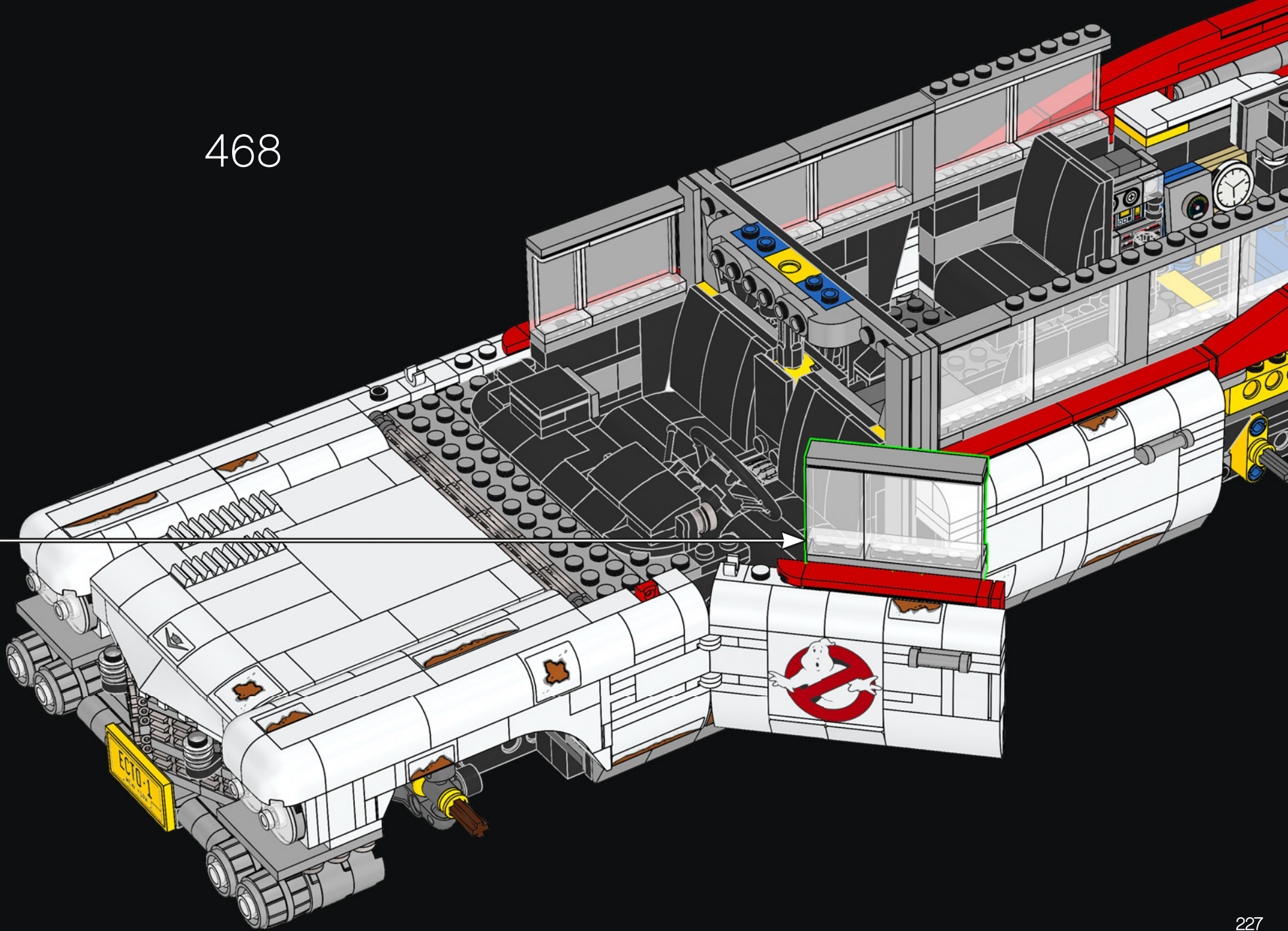

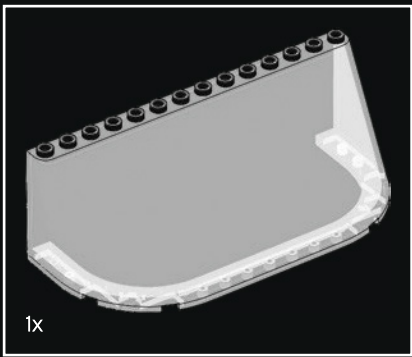

469

1

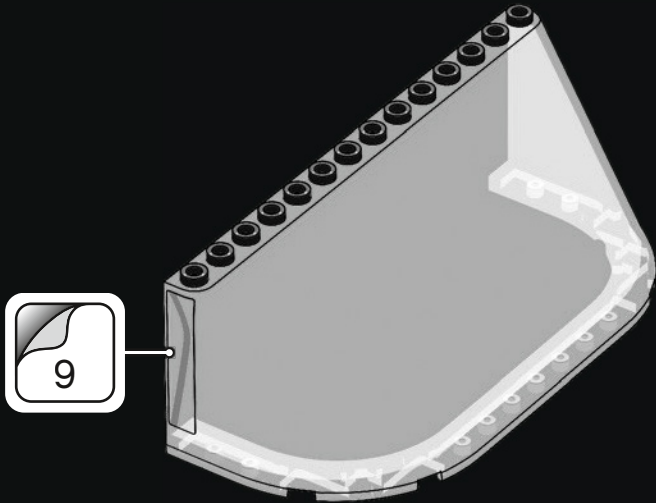

2

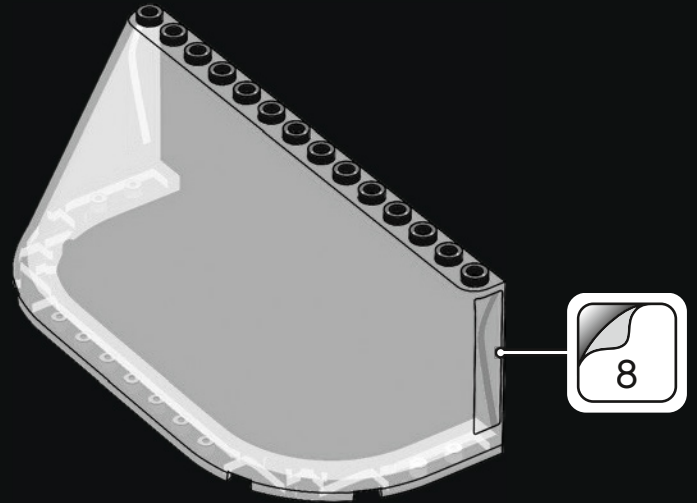

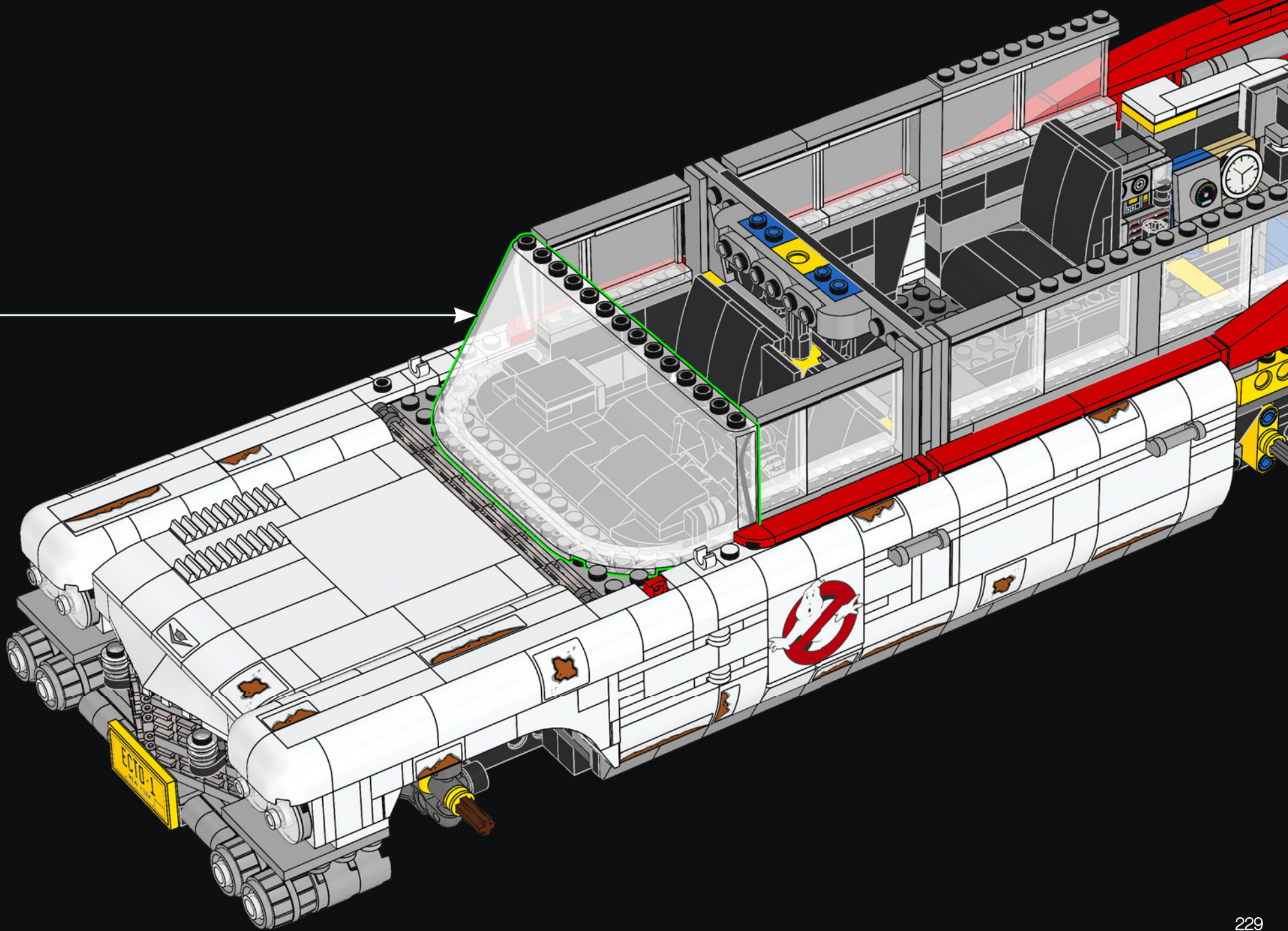

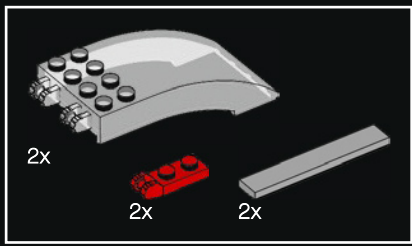

470

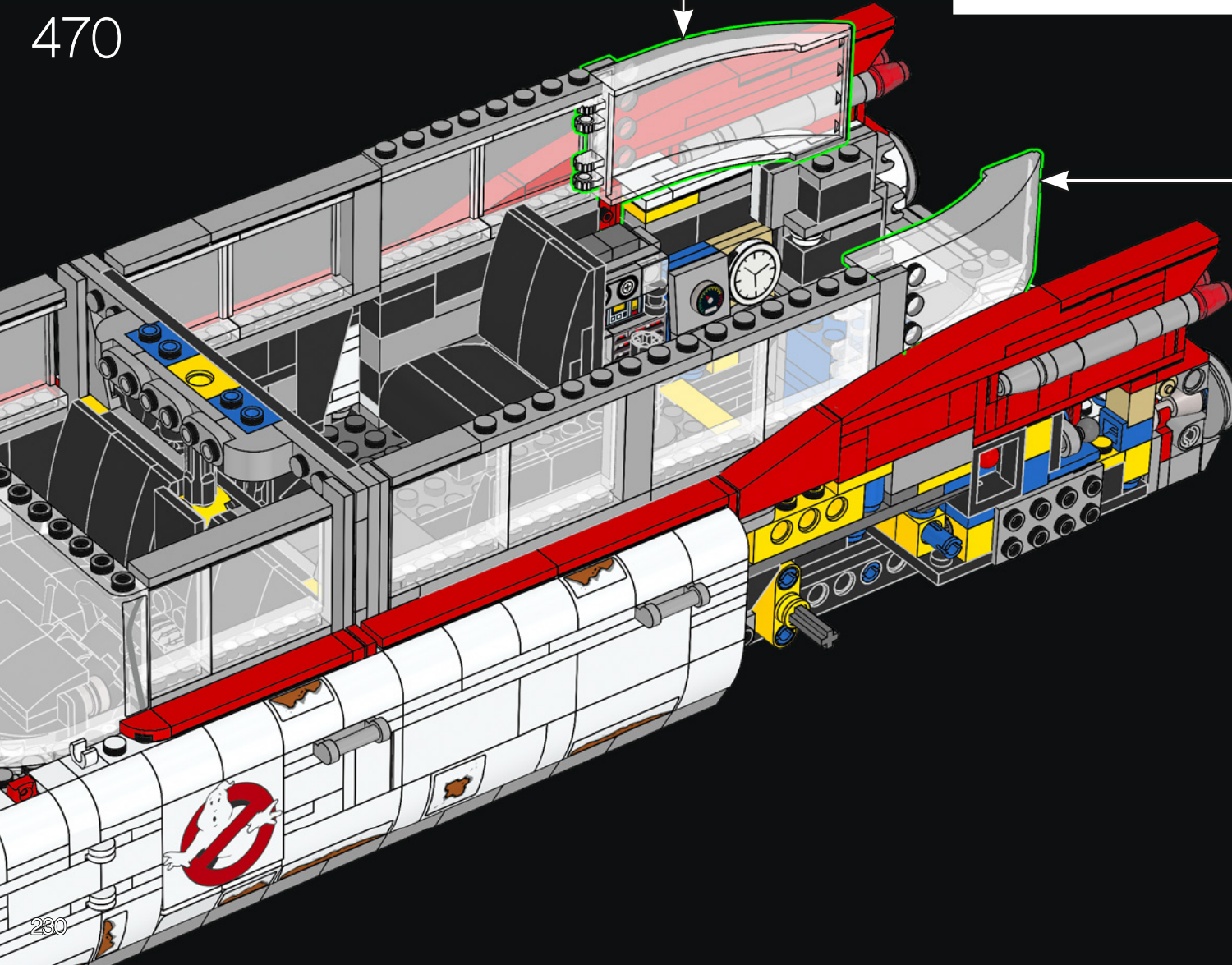
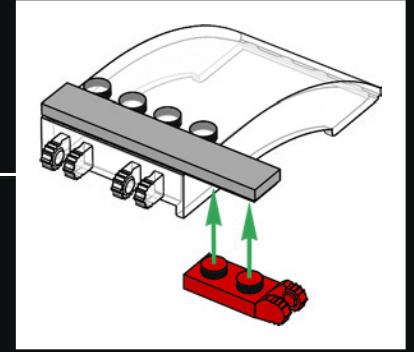
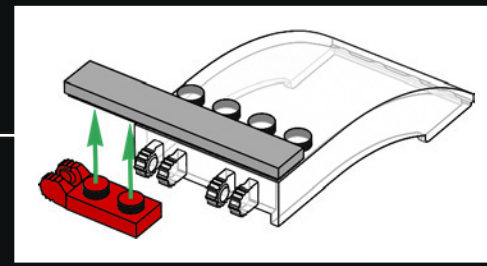

280



471

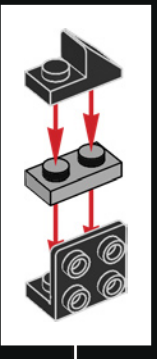
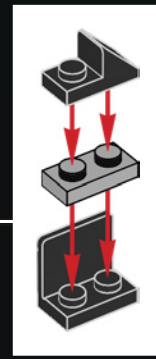
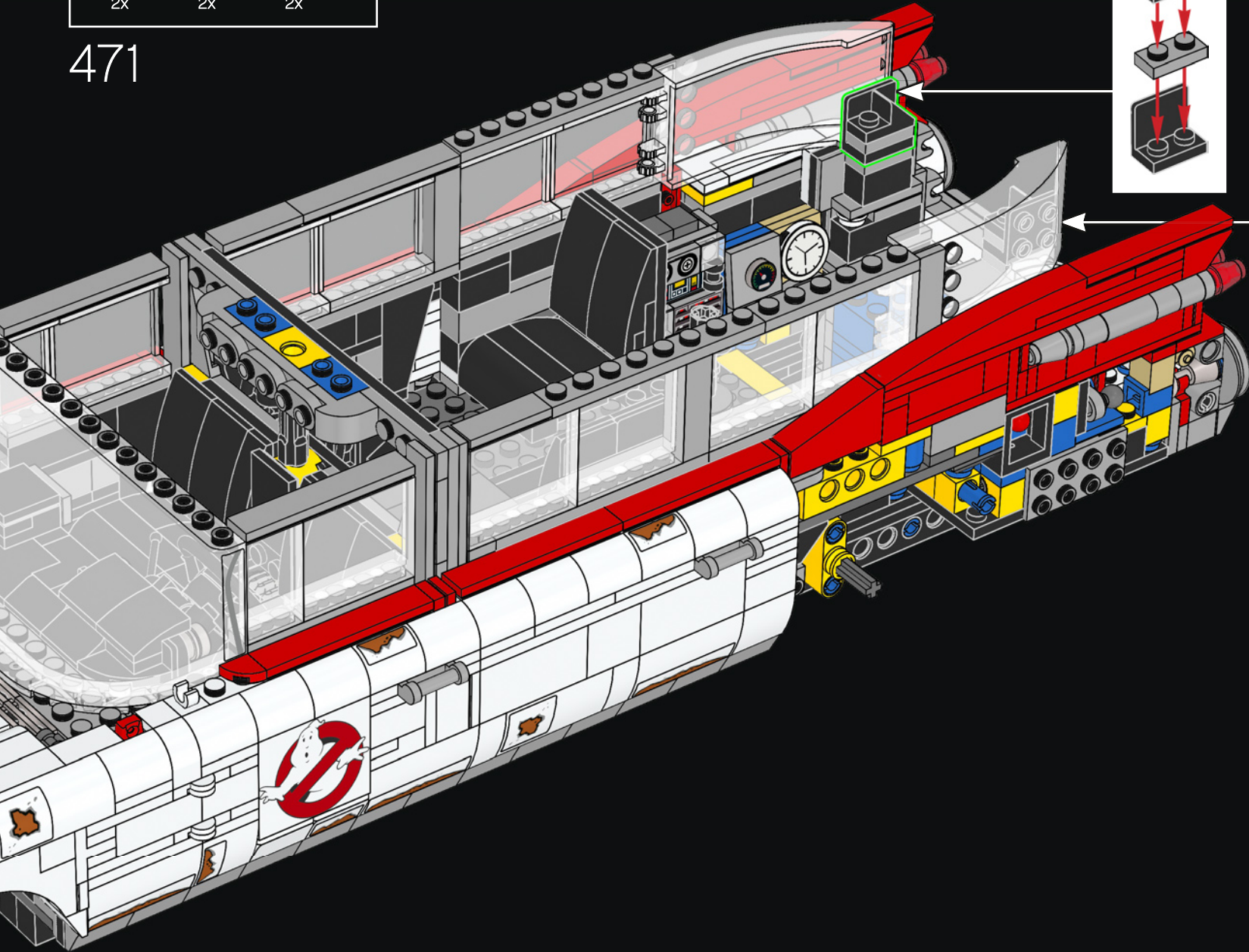

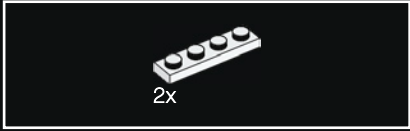
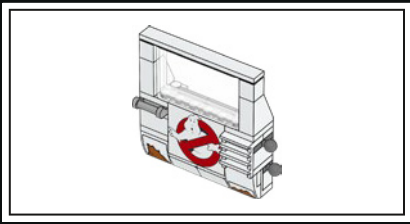

472

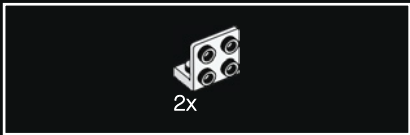
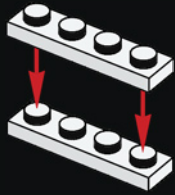

473

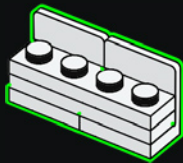

474

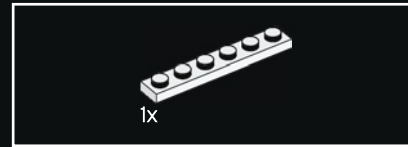
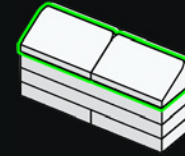

475

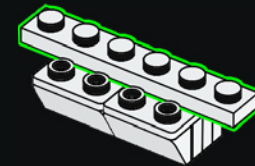



476

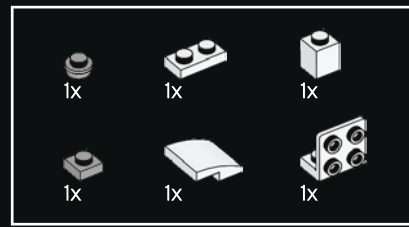
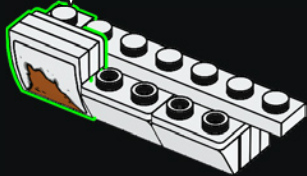
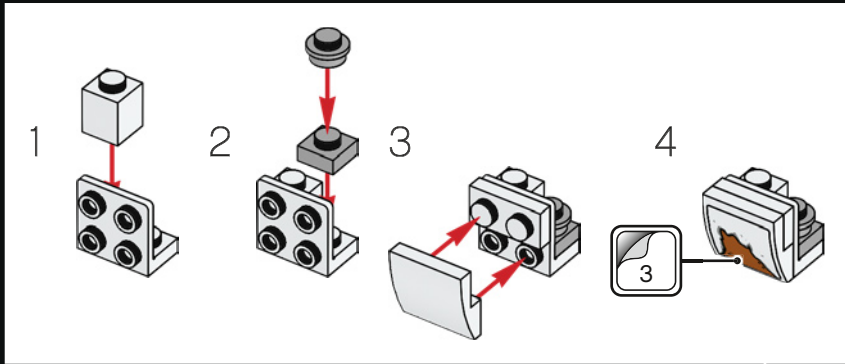

477

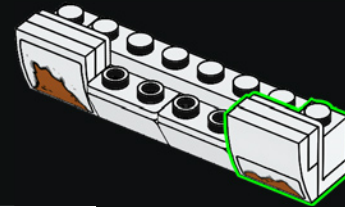
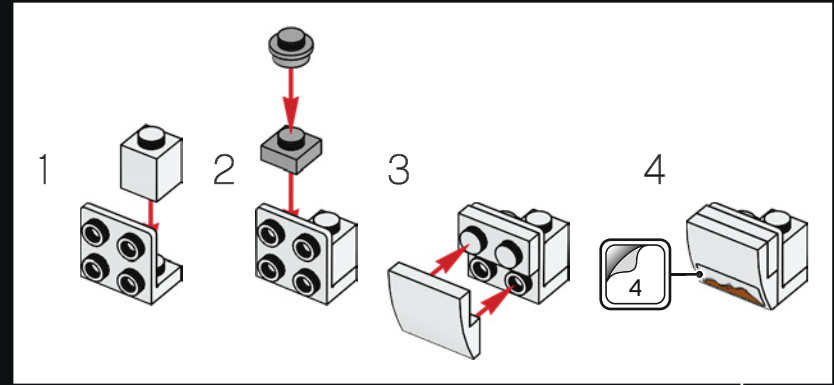

478

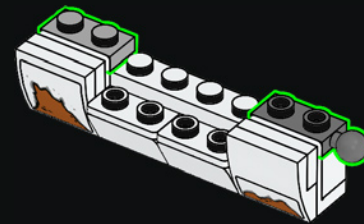



479

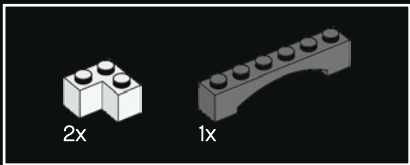
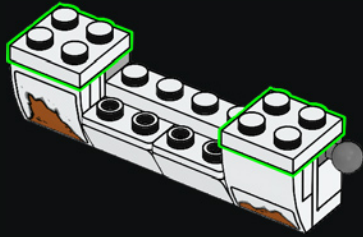

480

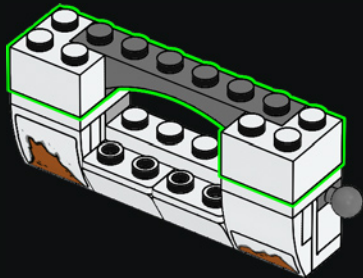

481

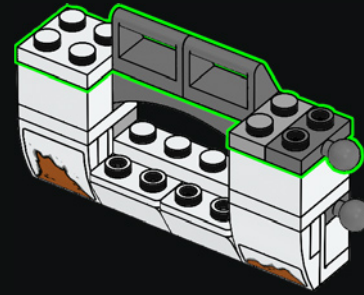

482

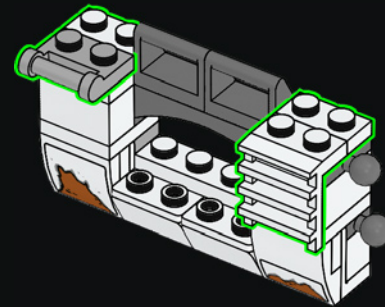

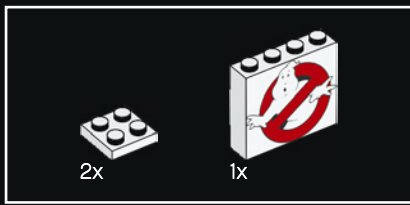

483

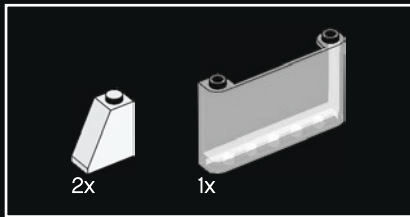
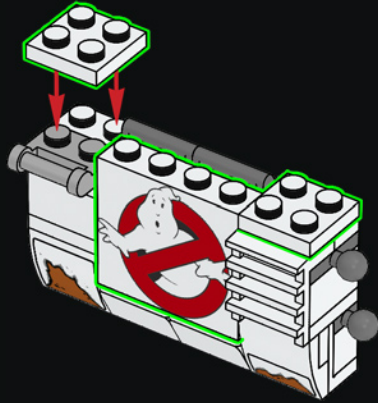

484

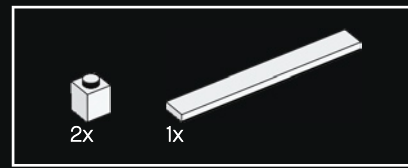
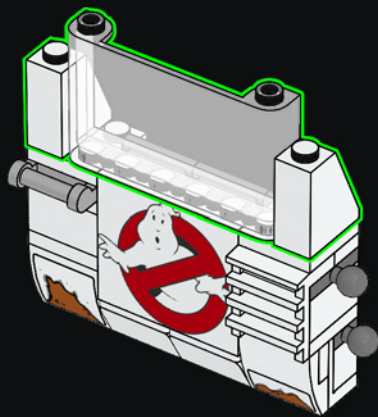

485

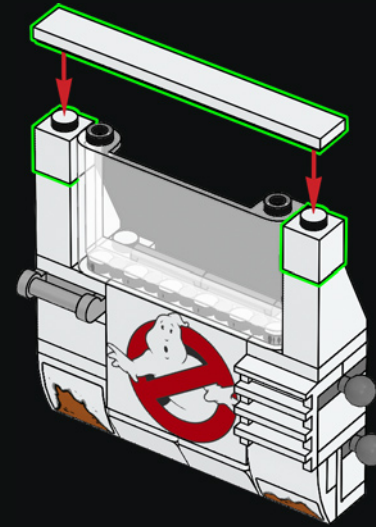

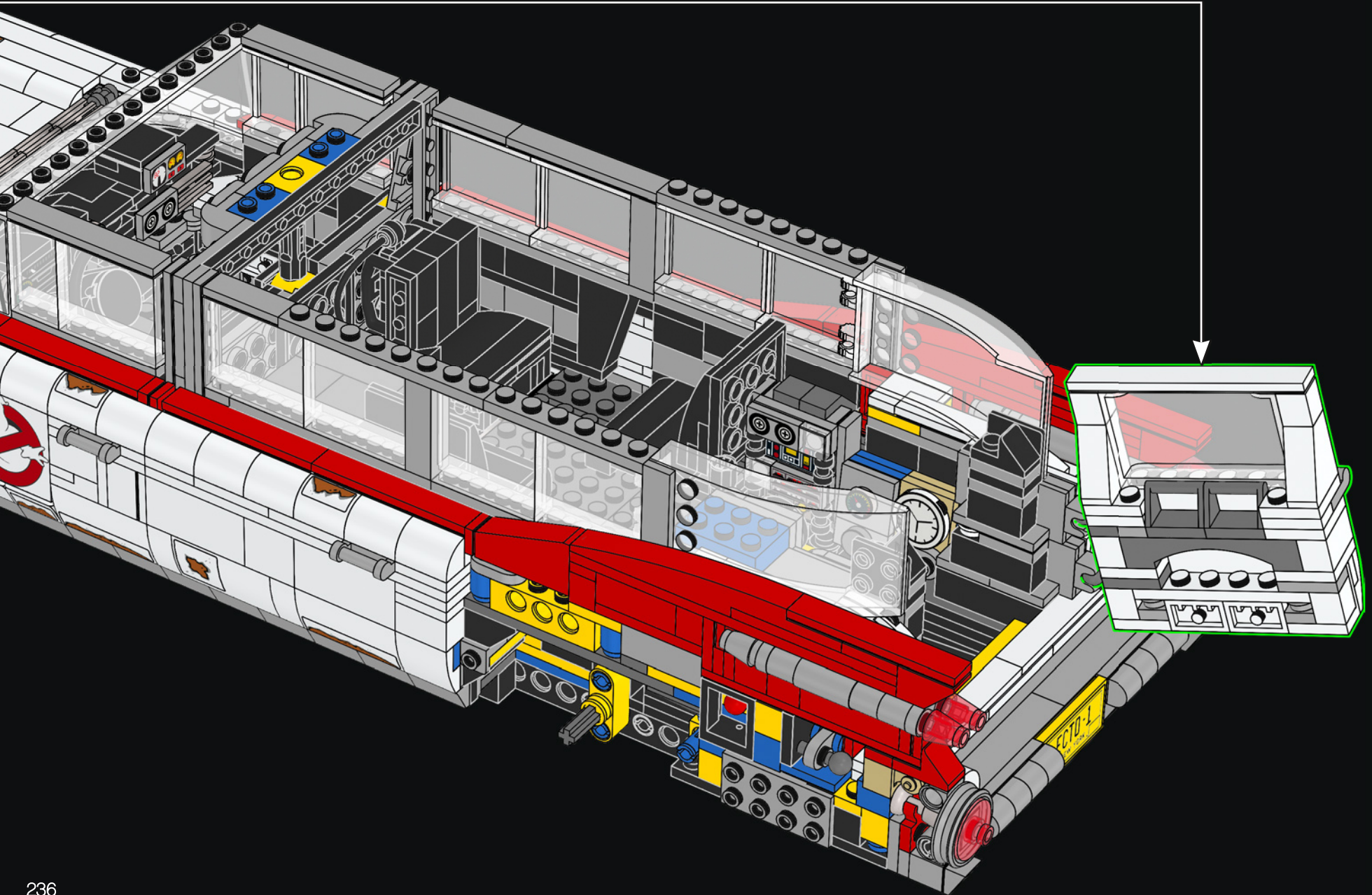

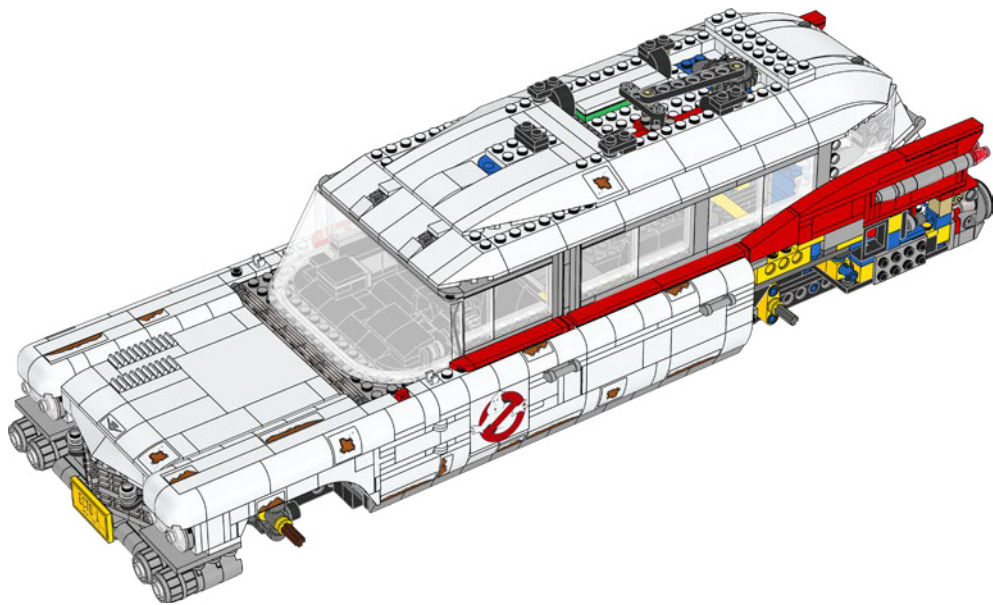
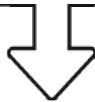

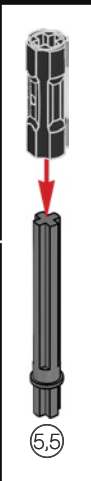
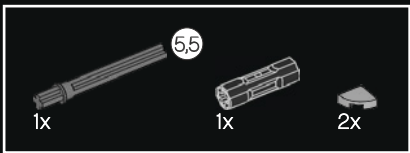

487

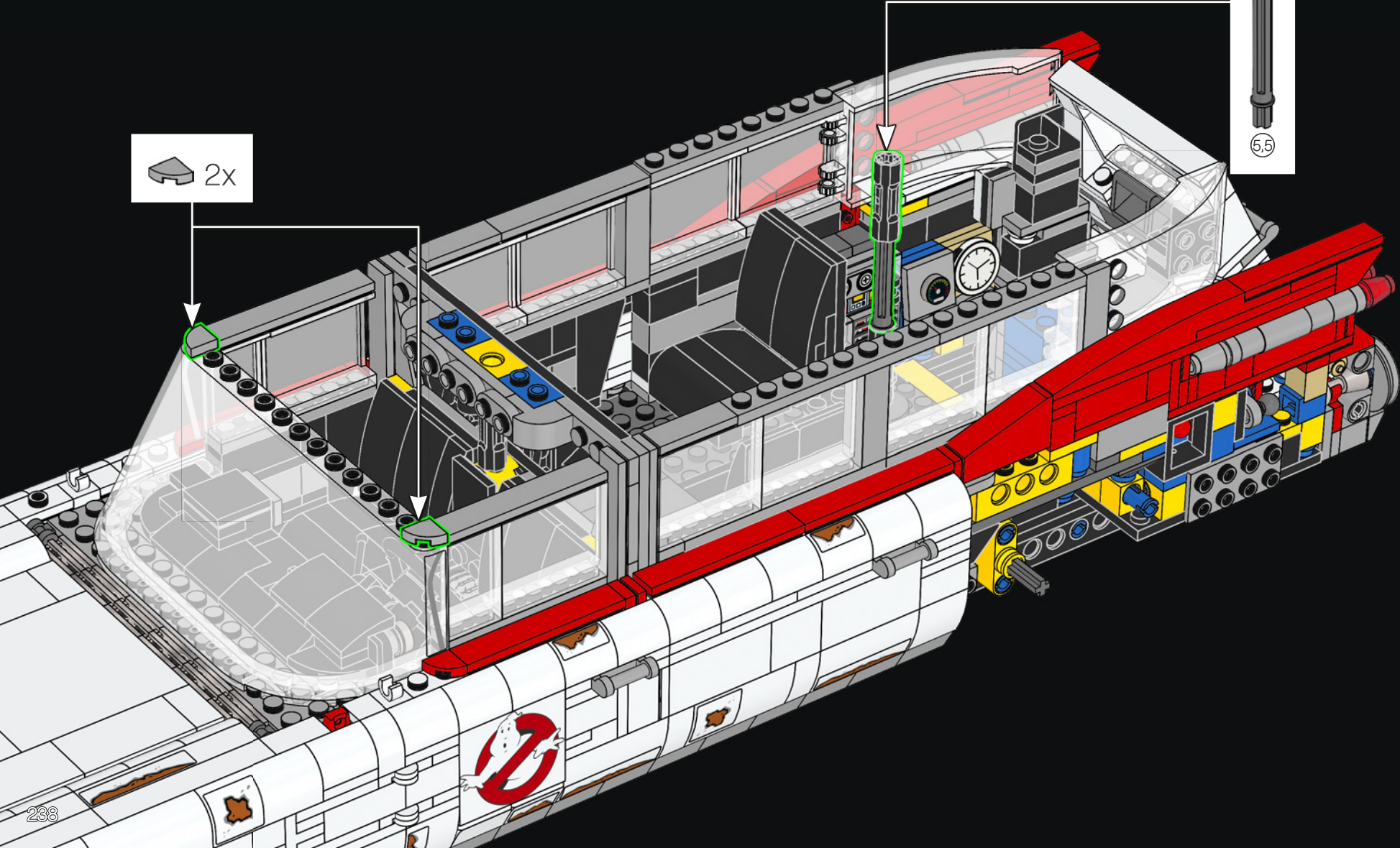

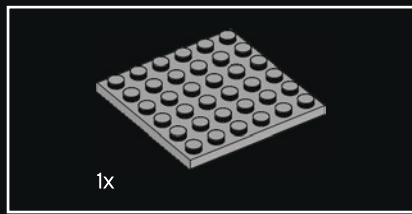

488

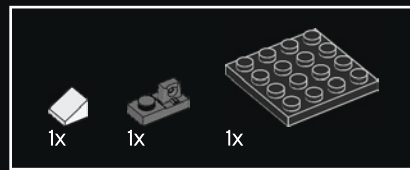

489

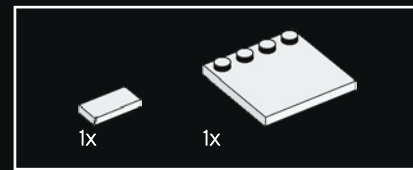

491

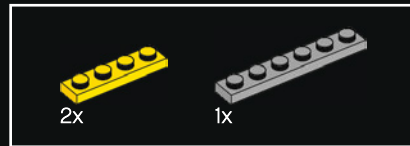
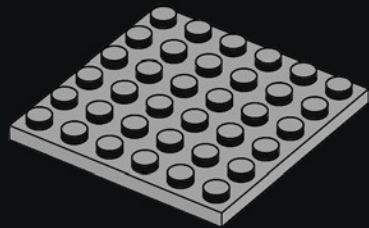

490

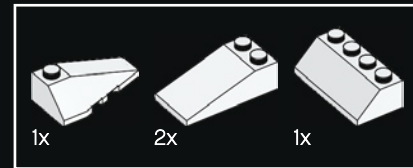

492

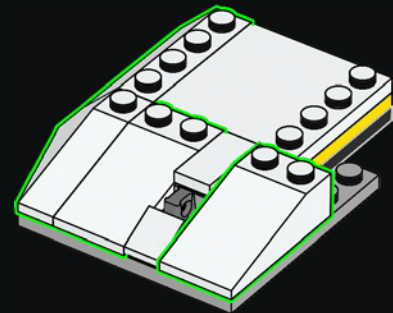
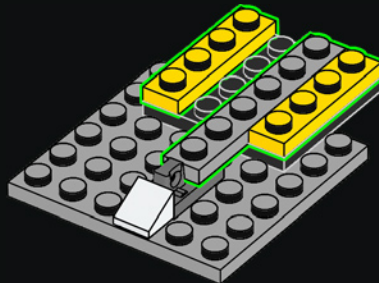
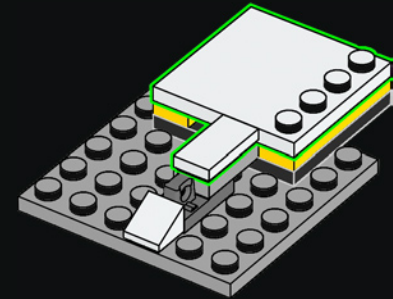
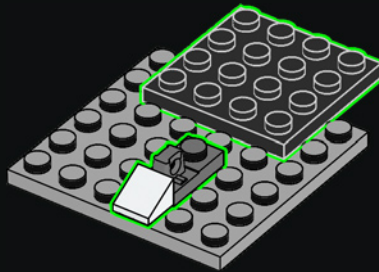

493

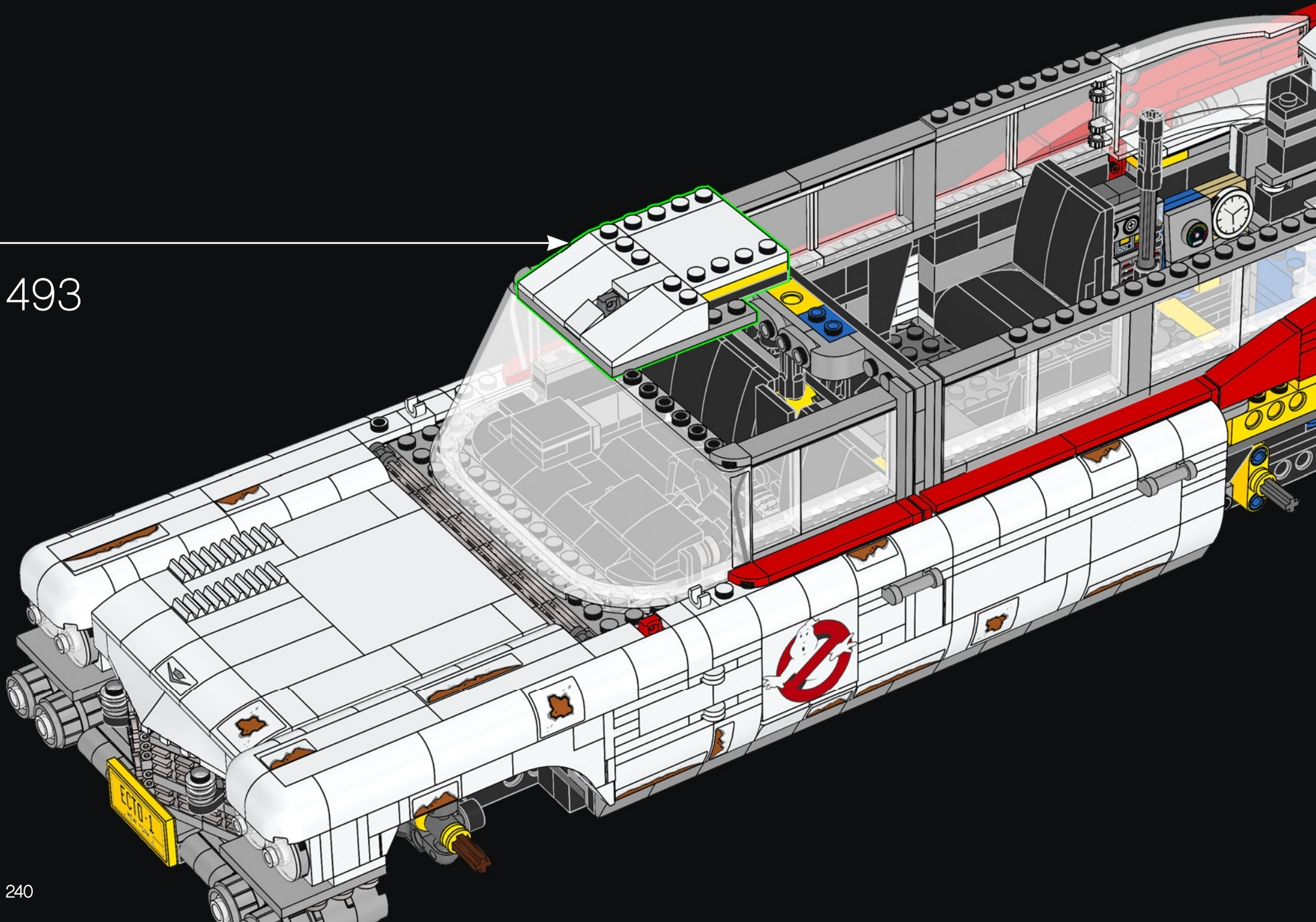

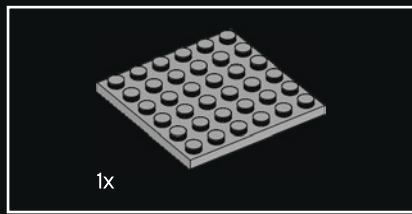

494

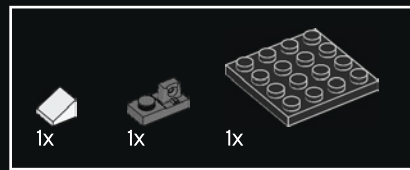

495

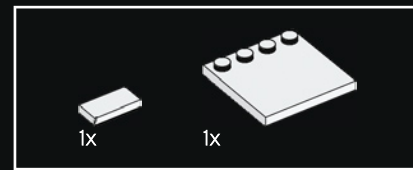

497

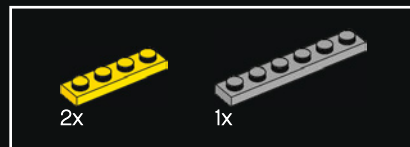
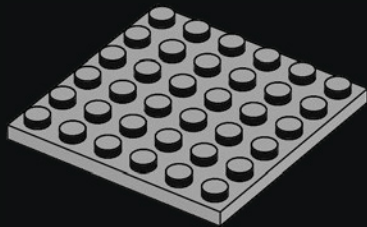
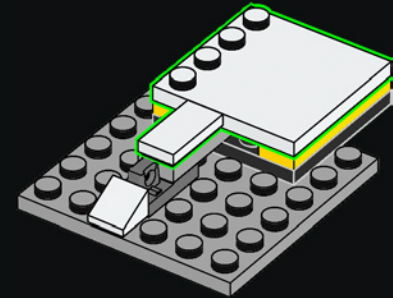
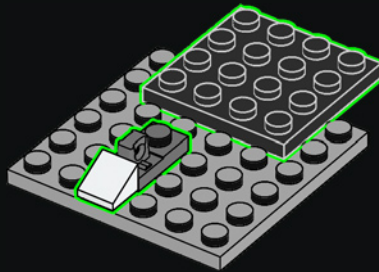

496

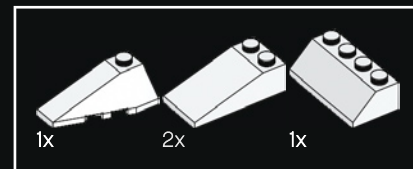

498

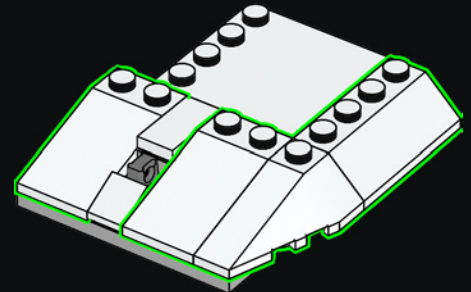
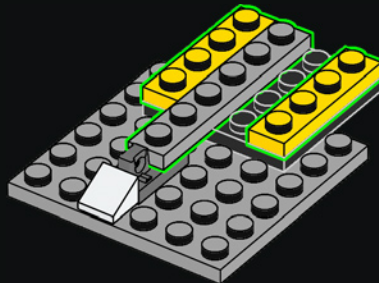

499

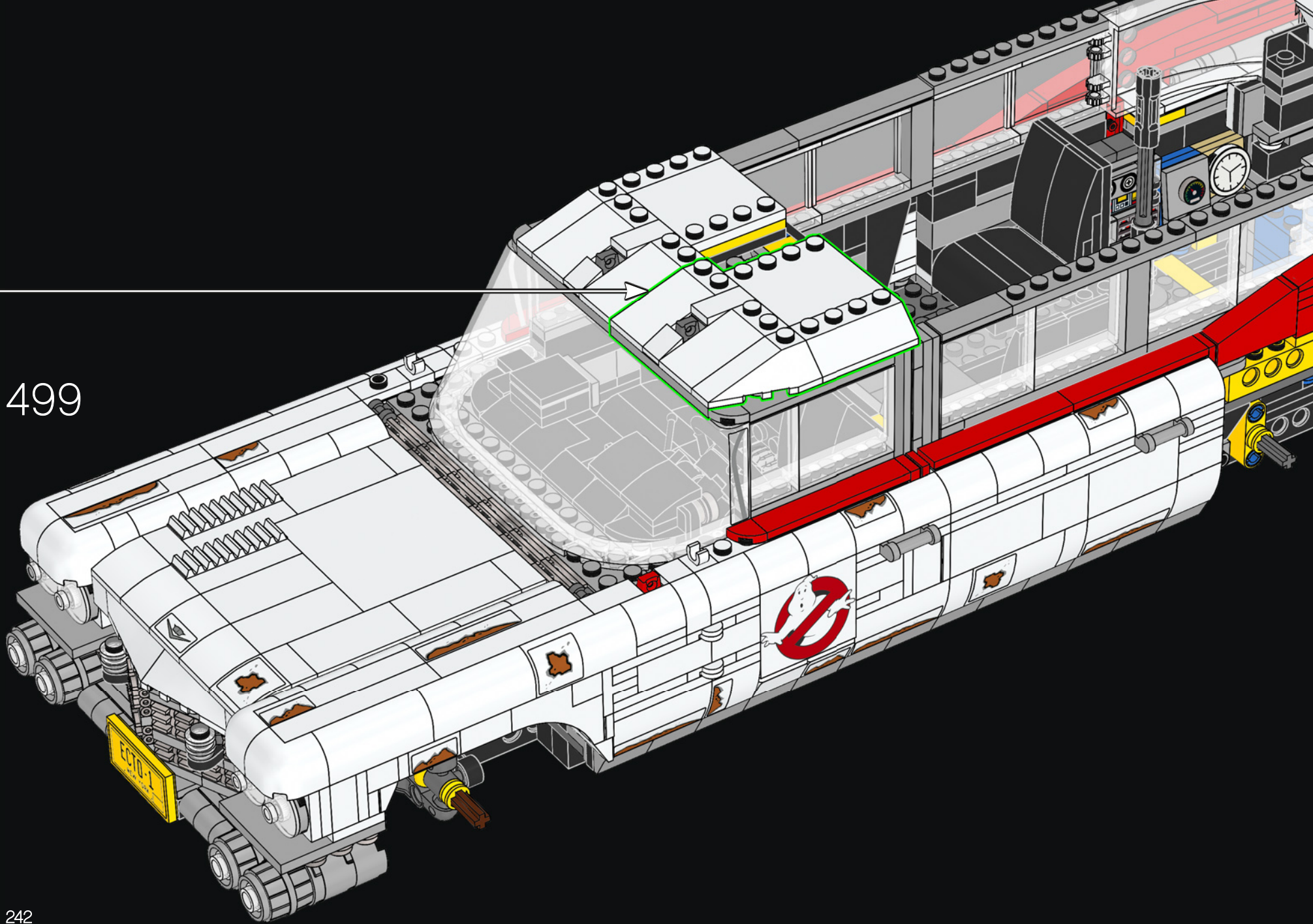

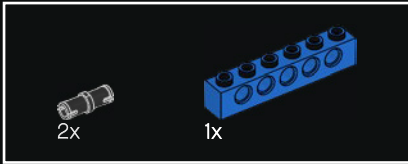
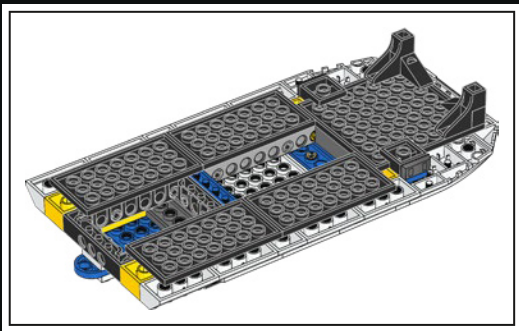

500

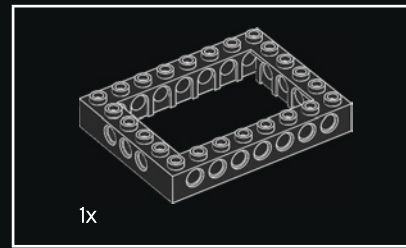
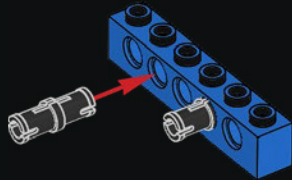

501

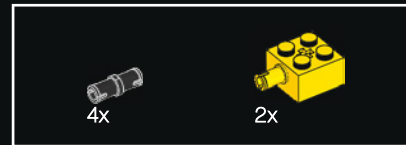
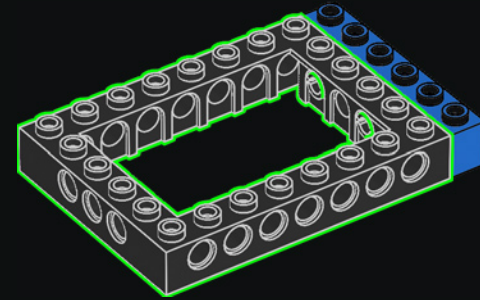

502

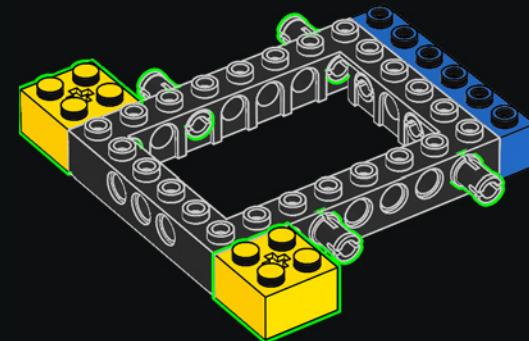

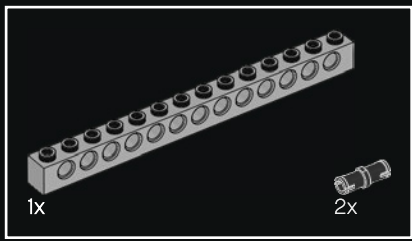

503

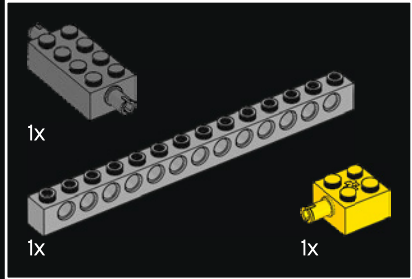
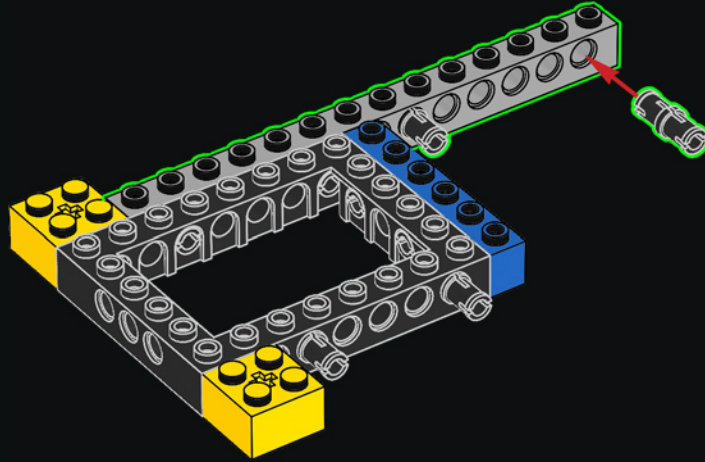

504

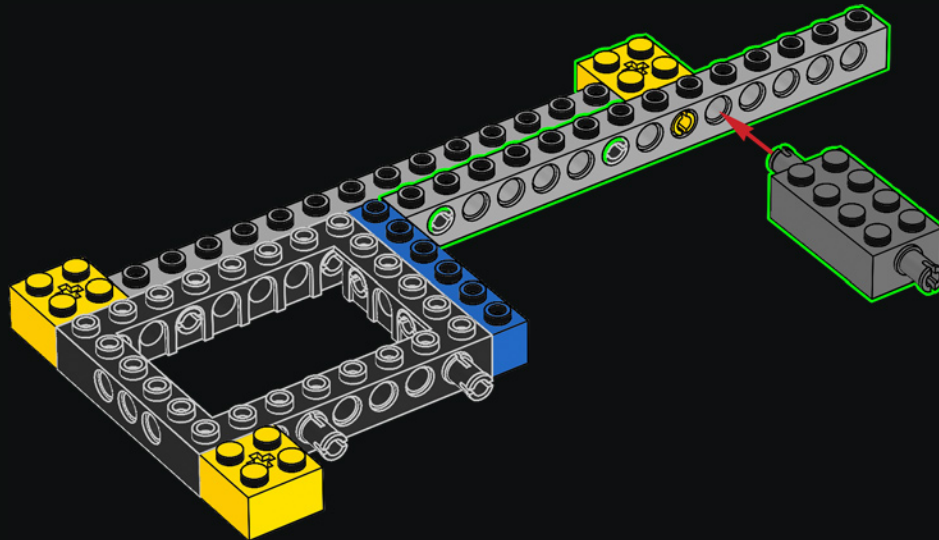

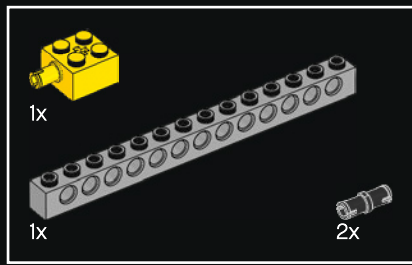

505

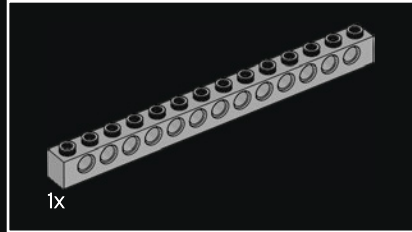
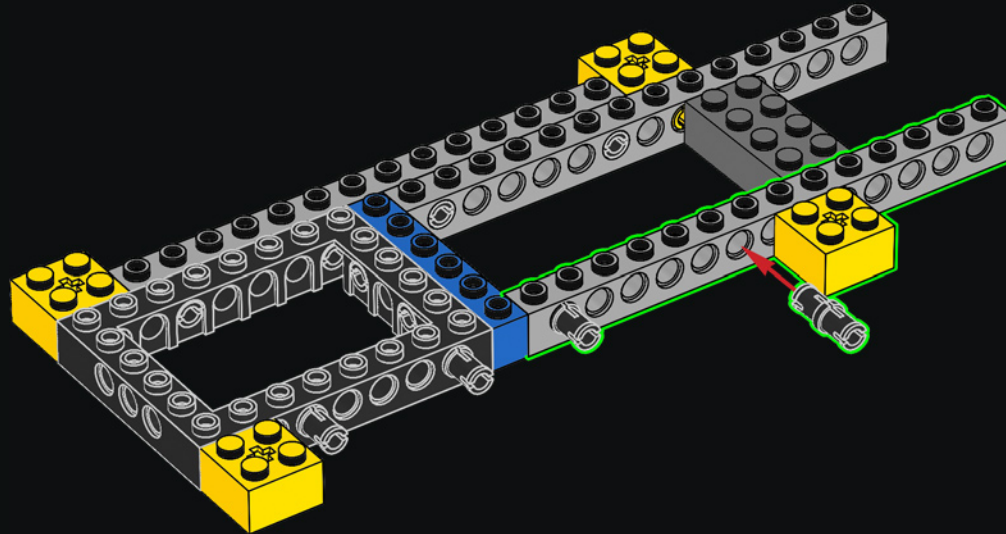

506

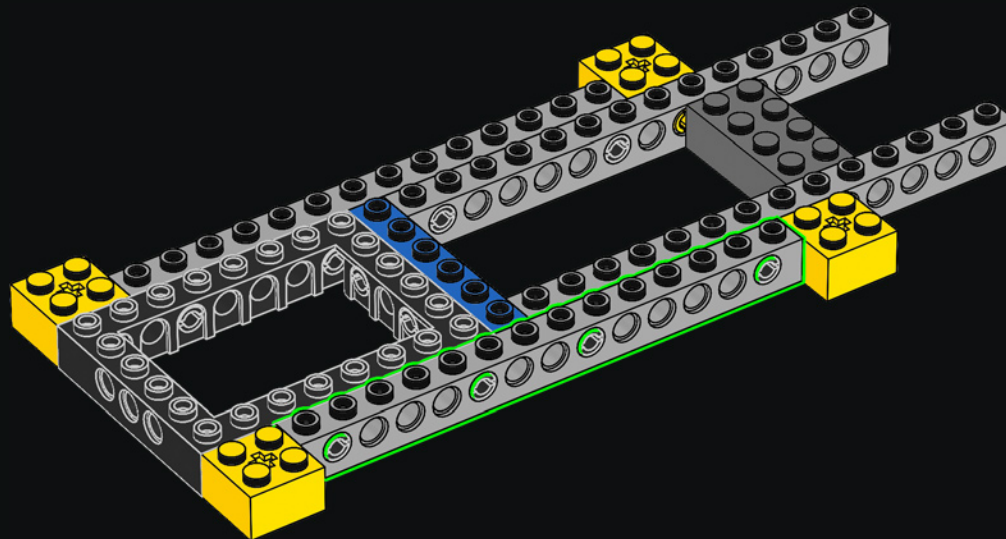

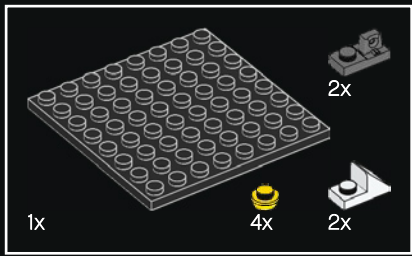

507

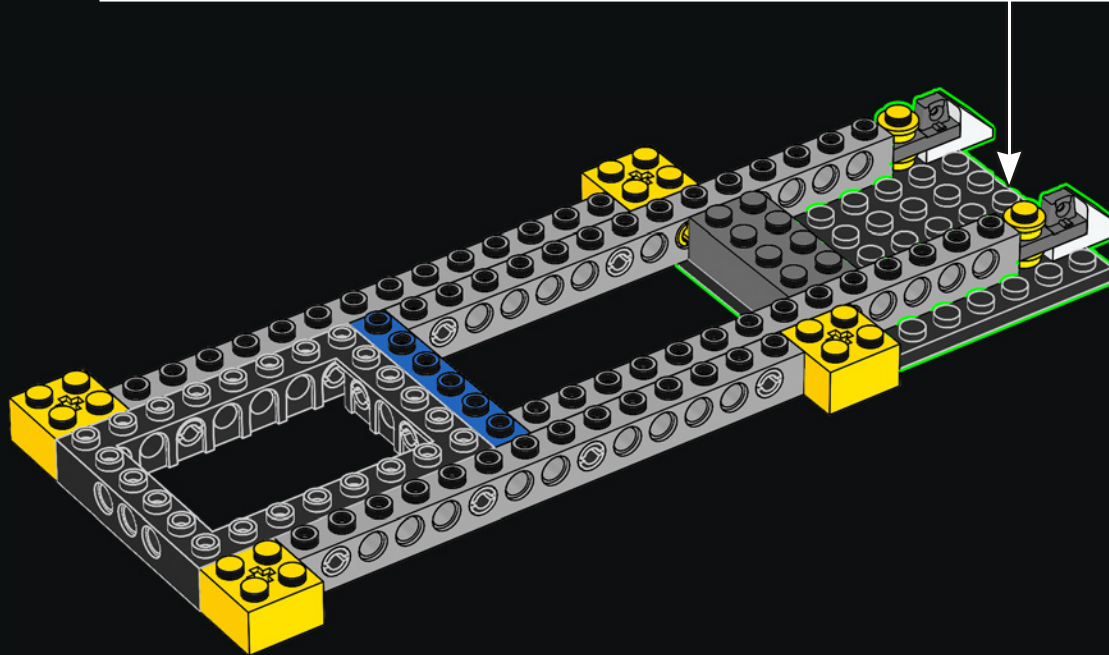
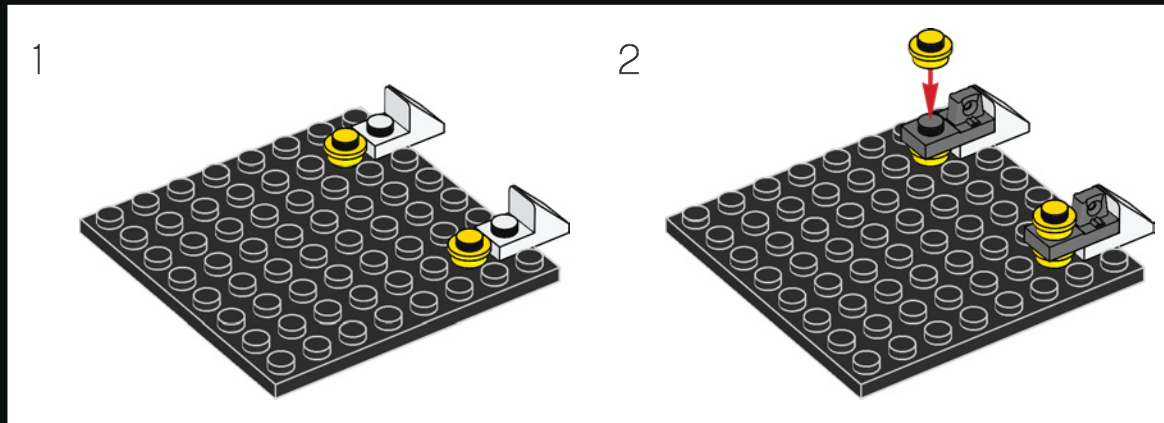

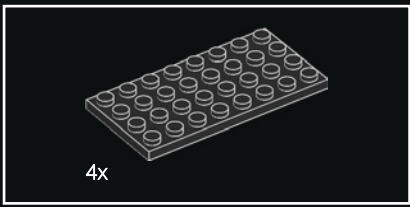

508

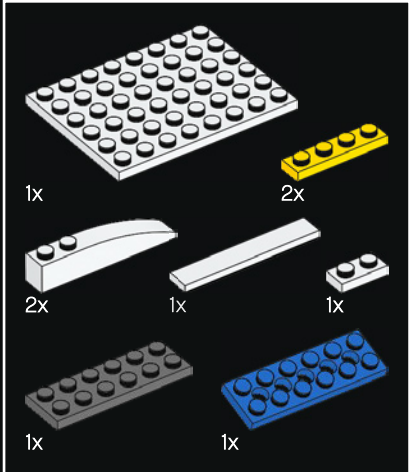
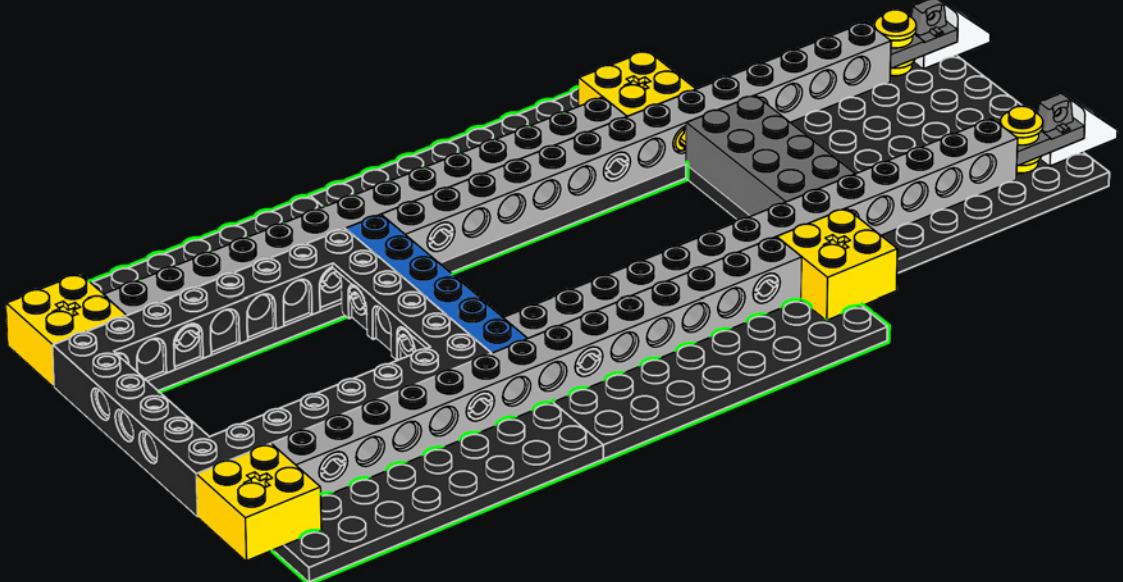

509

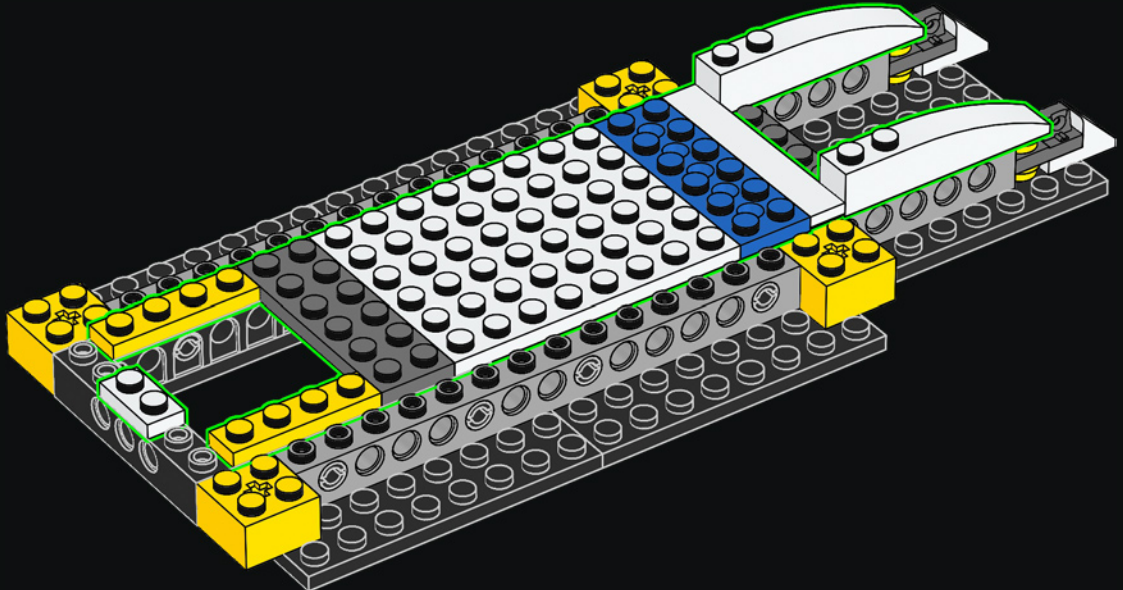

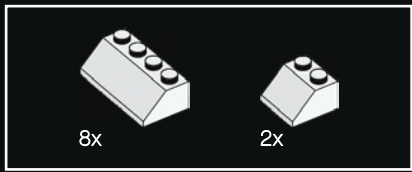

510

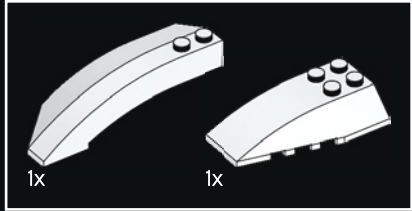
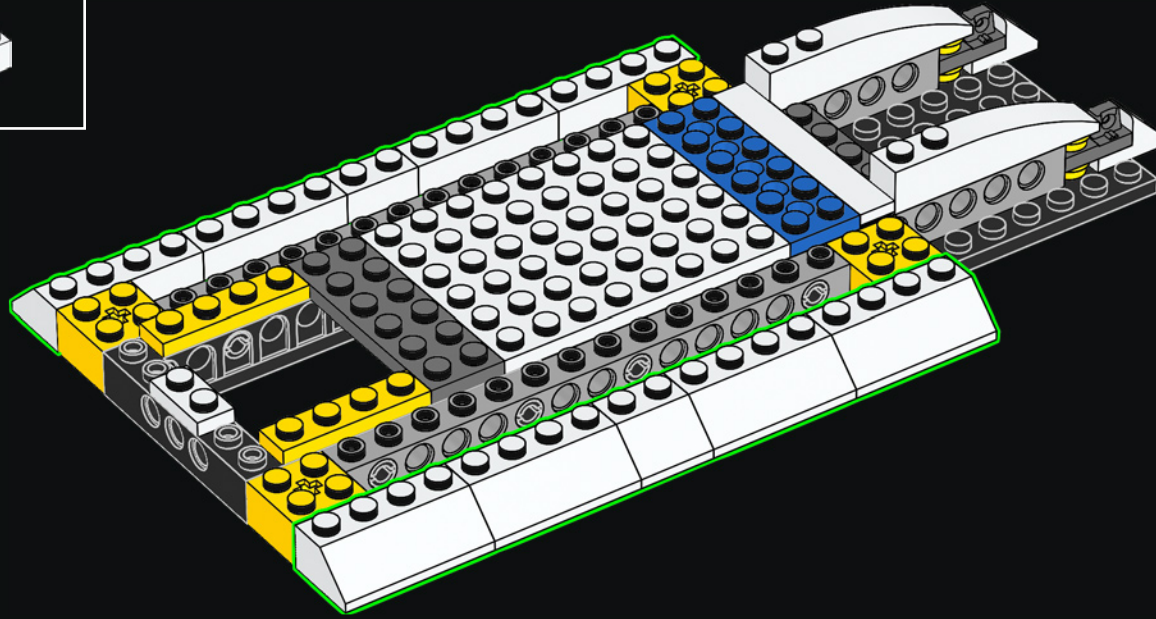

511

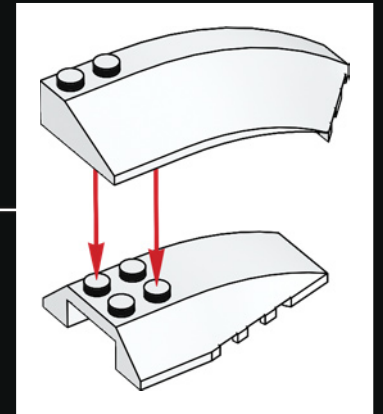
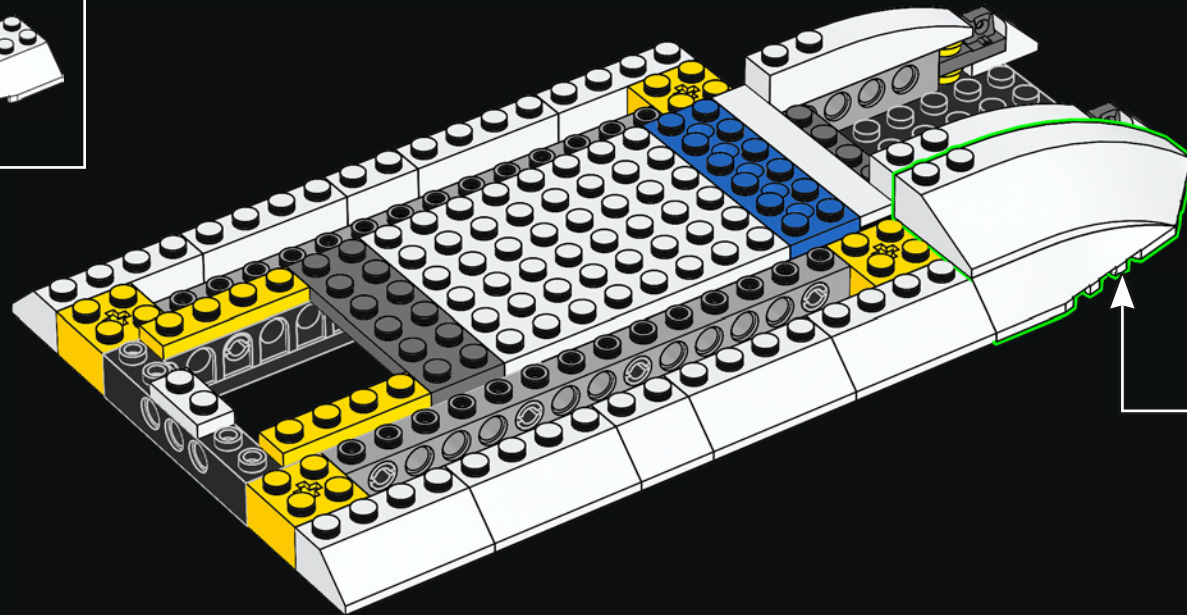

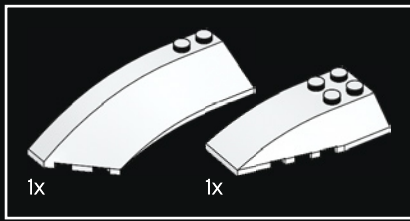

512

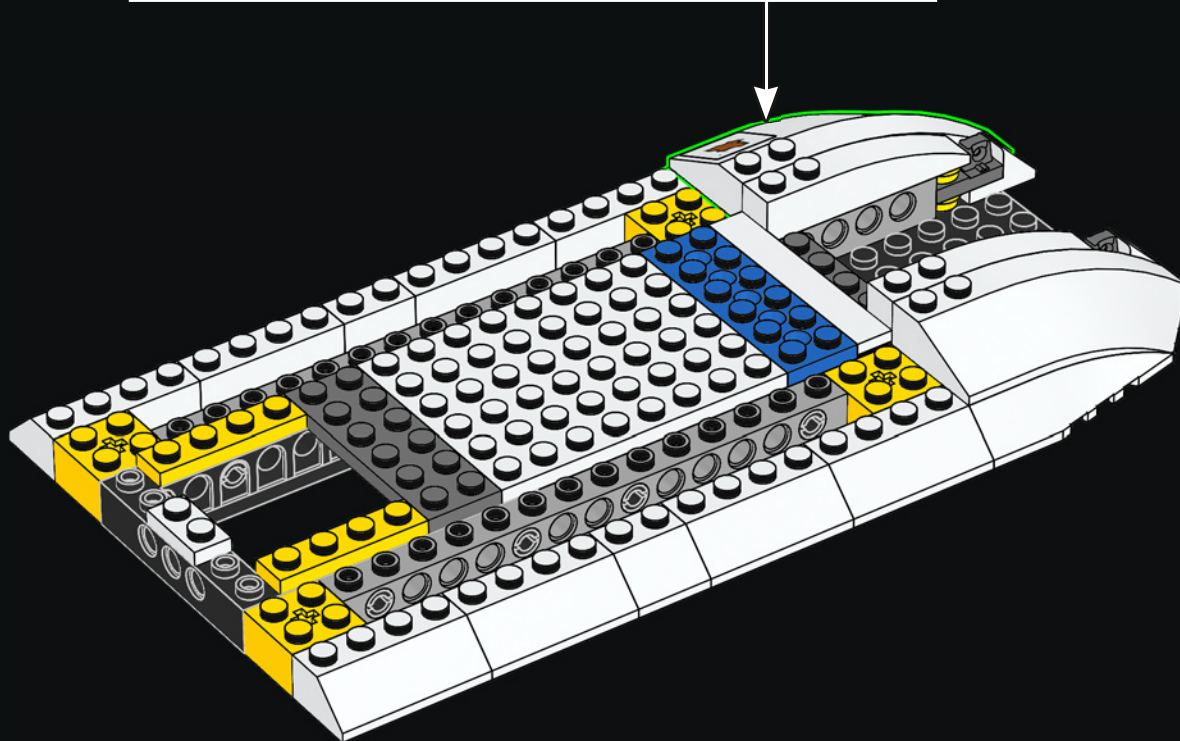
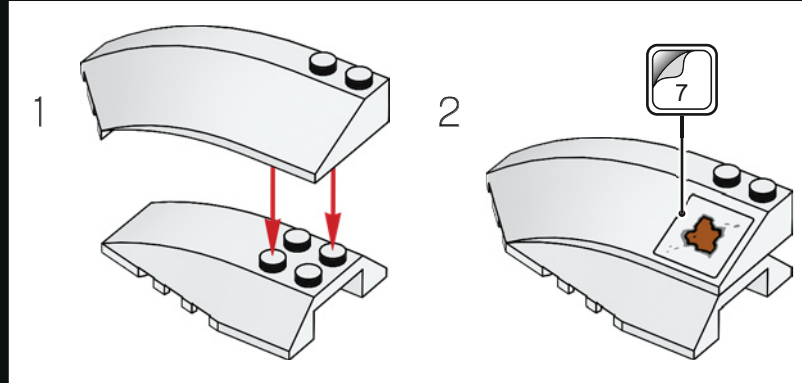

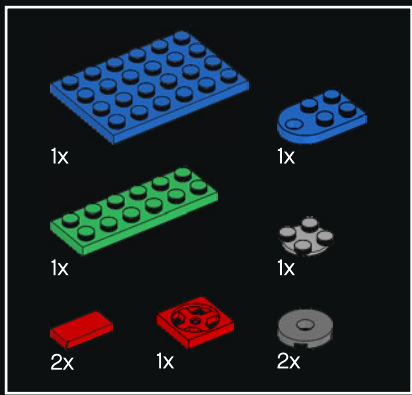

513

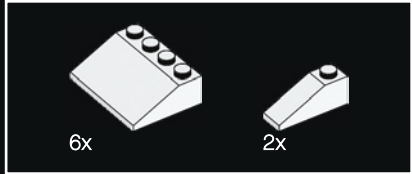
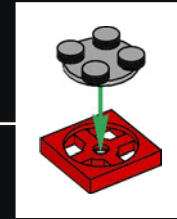
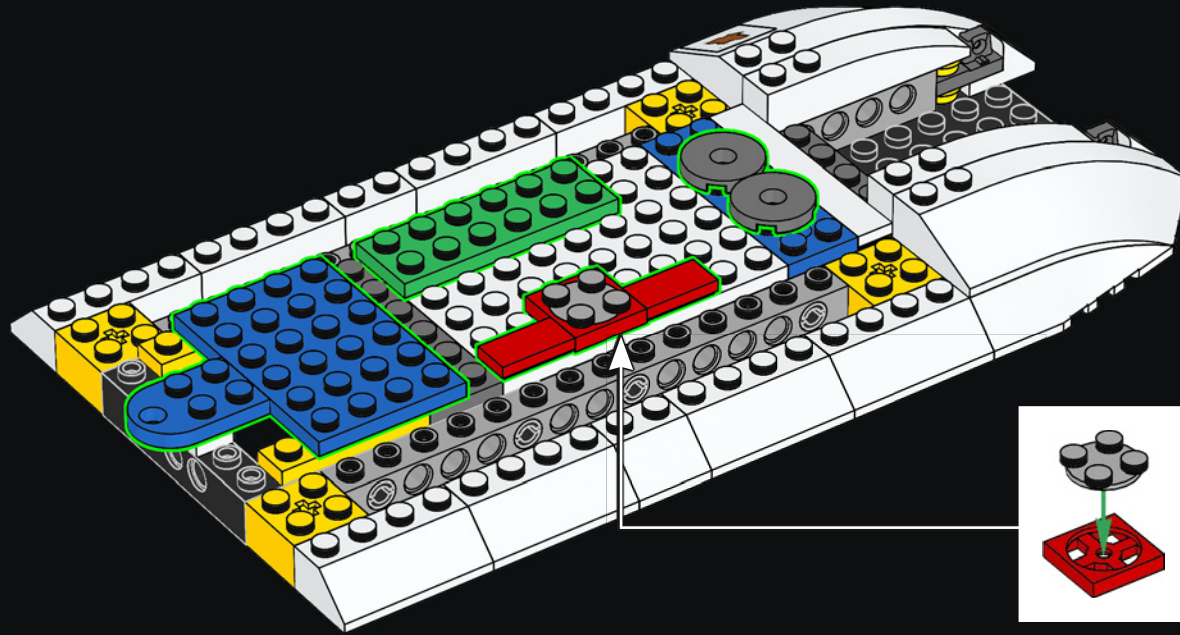

514

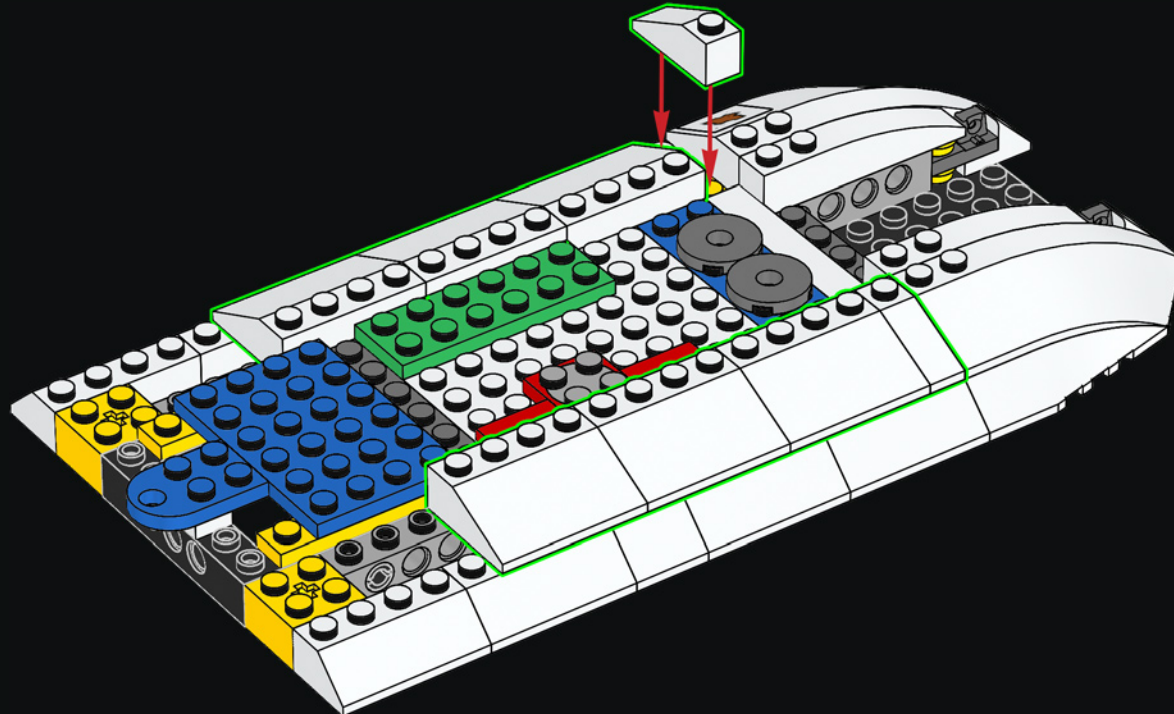

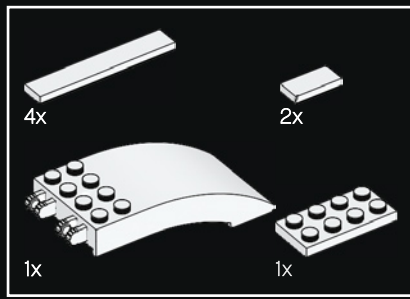

515

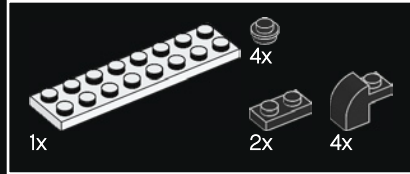
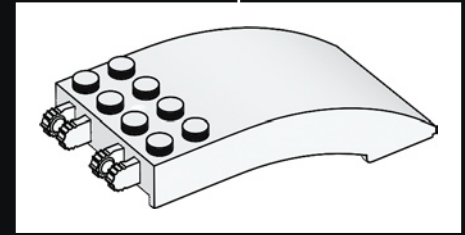
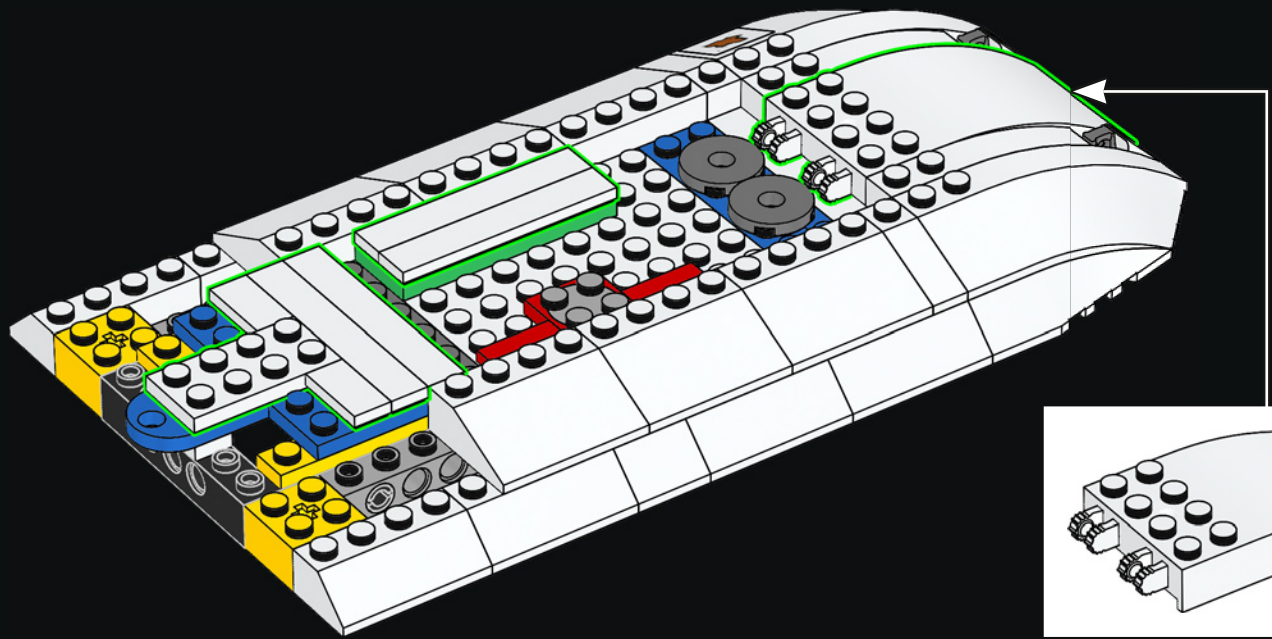

516

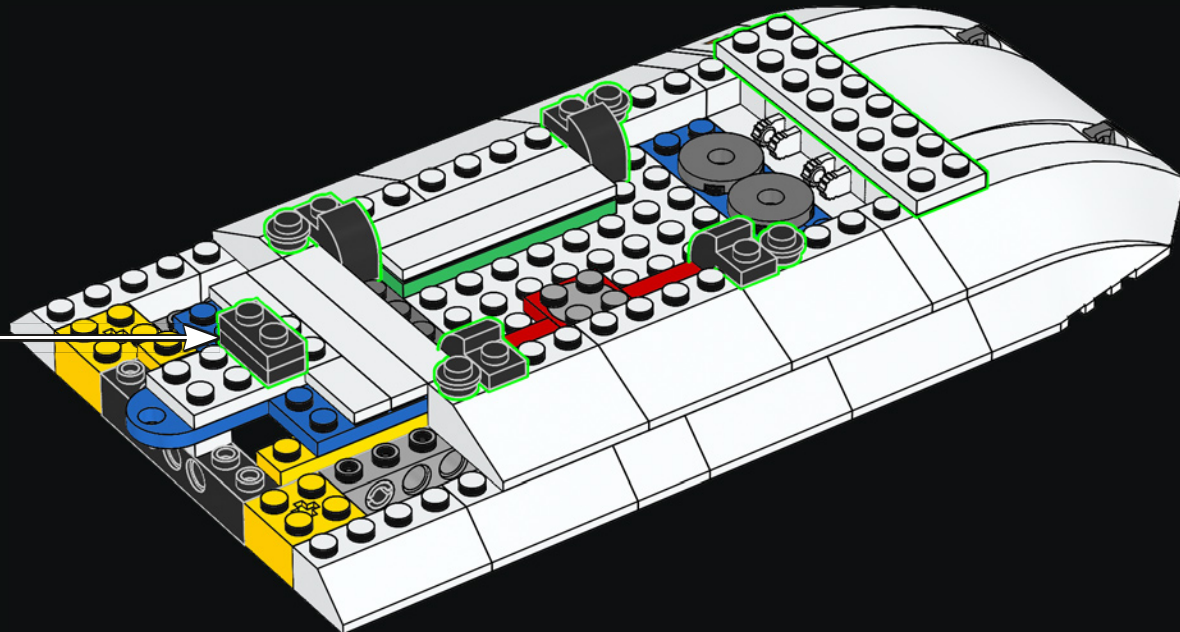
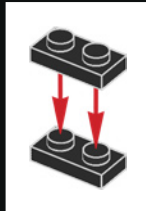



517

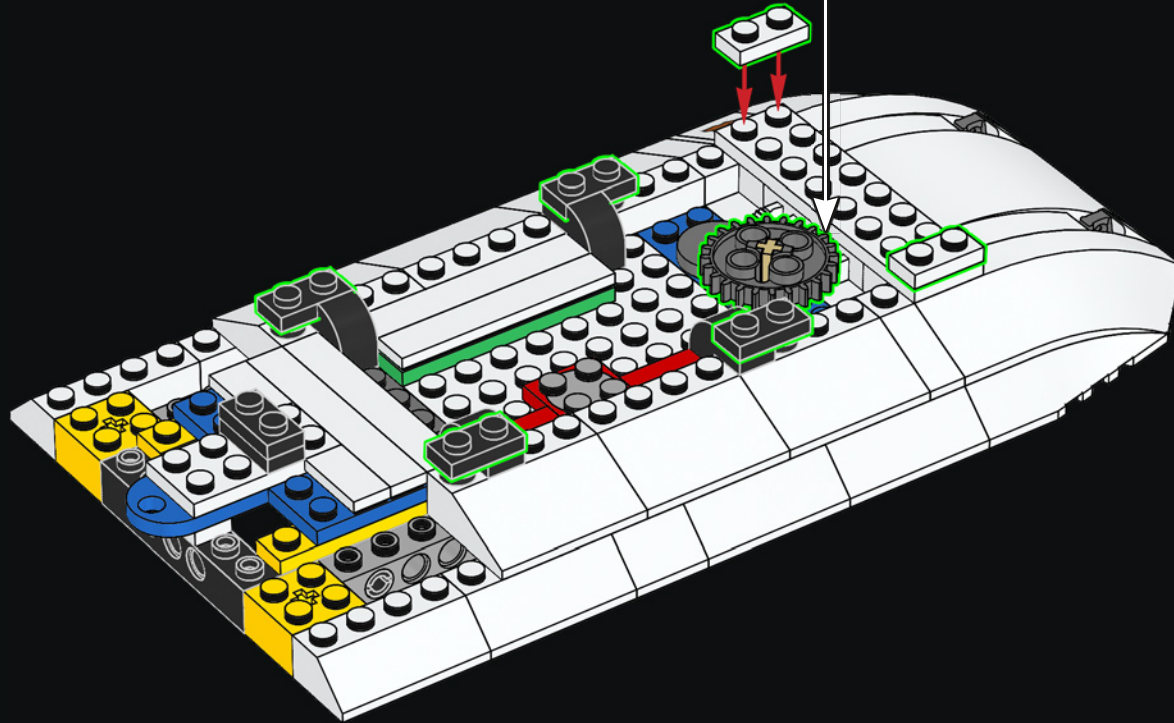
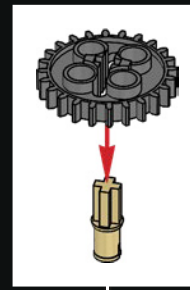

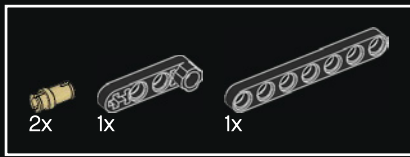

518

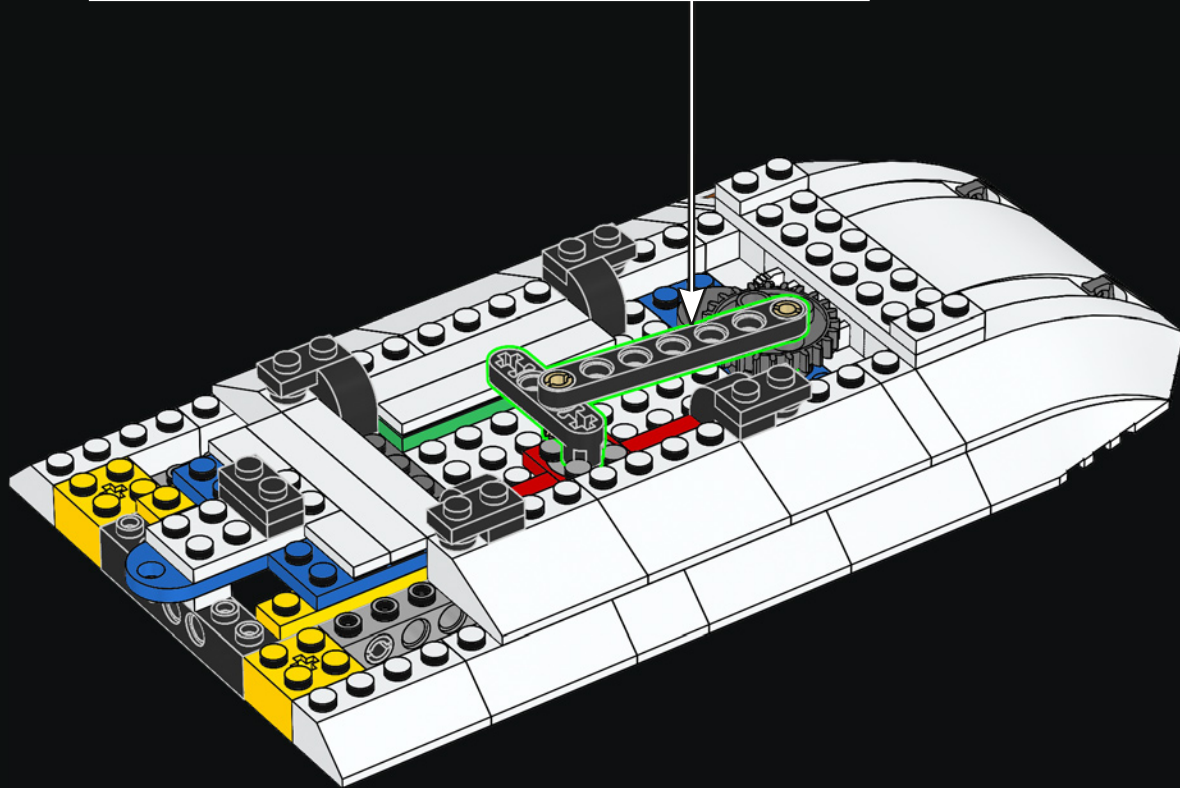
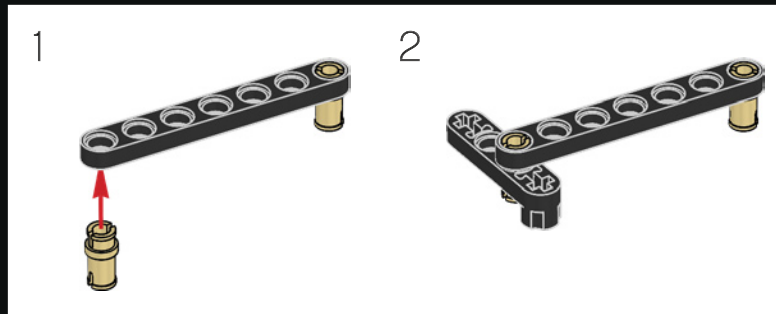

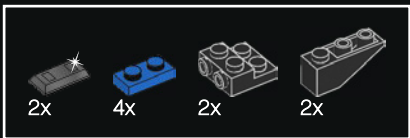

519

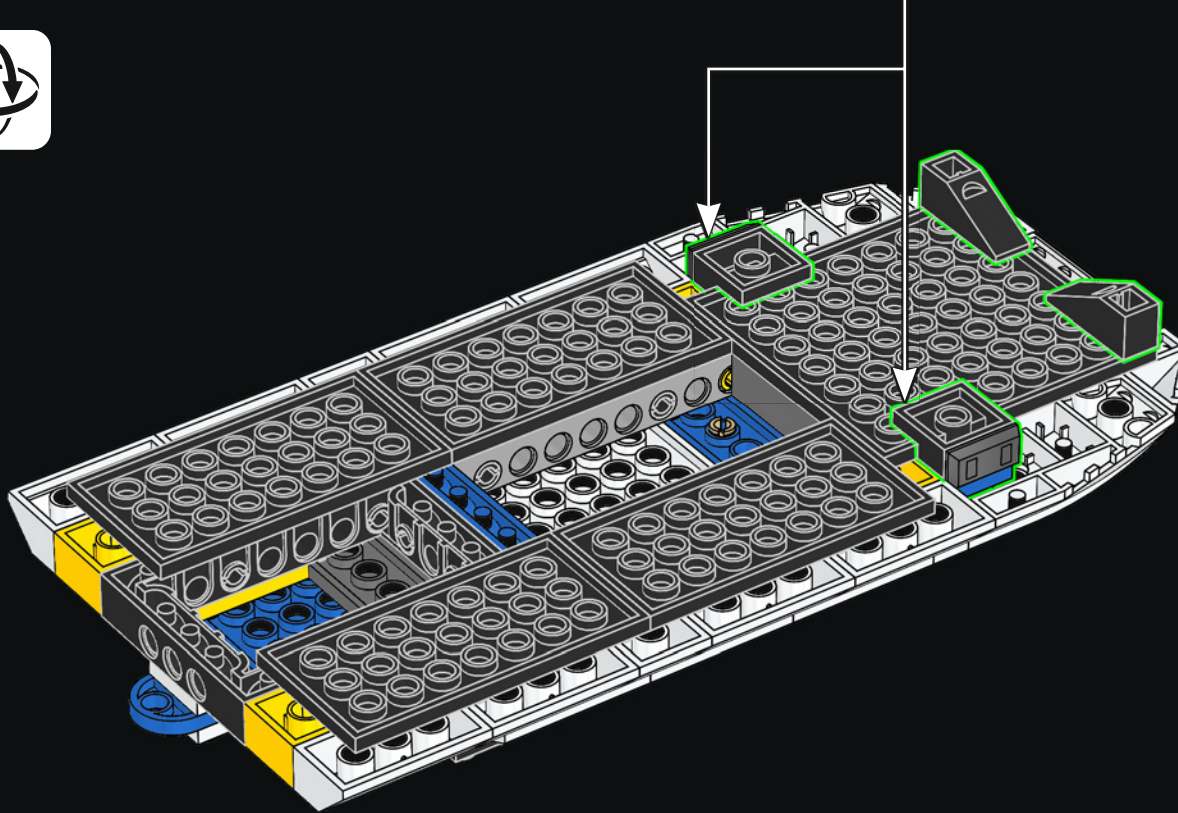
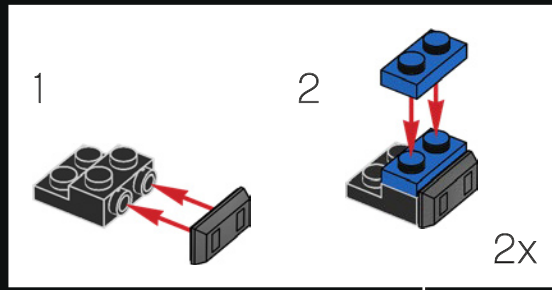



520

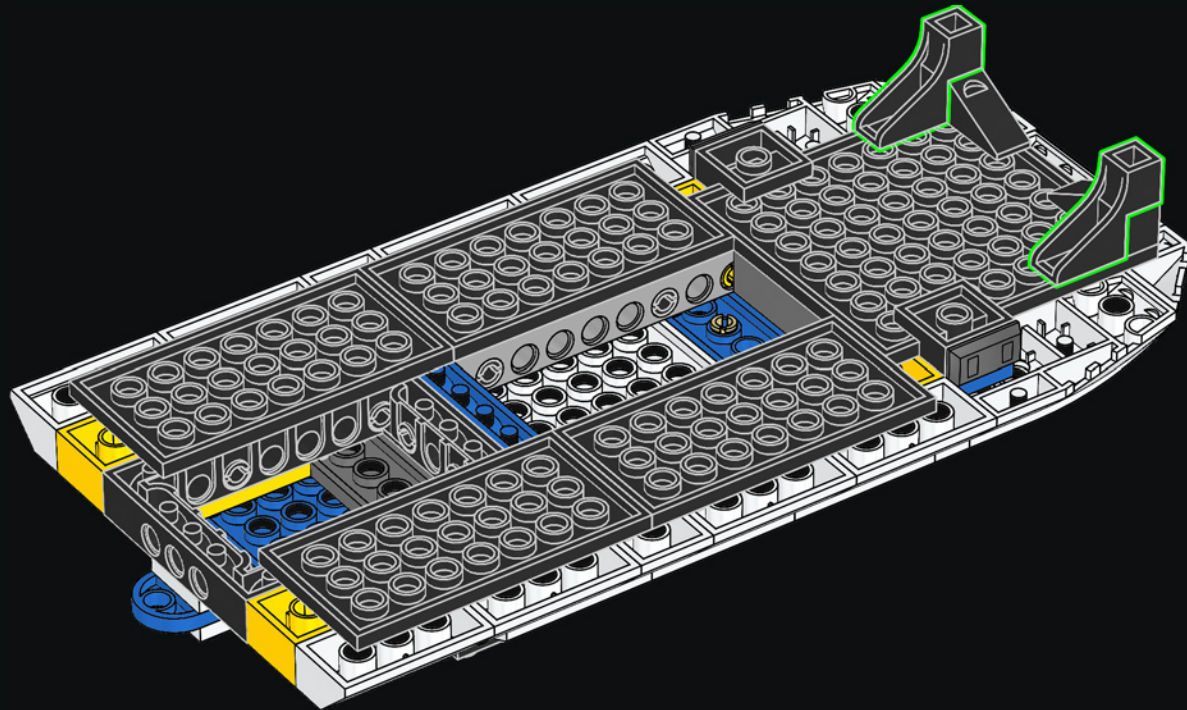

521

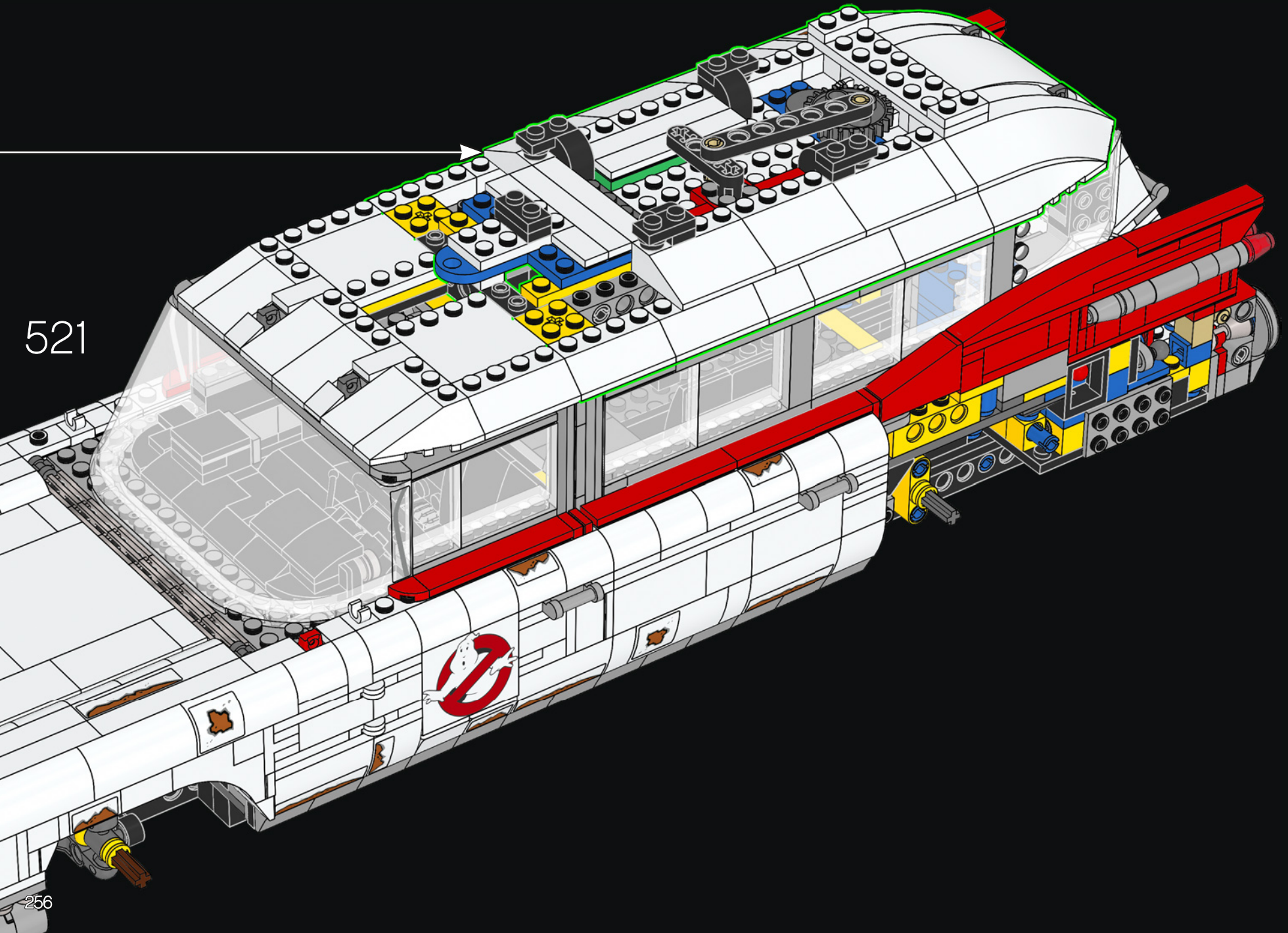

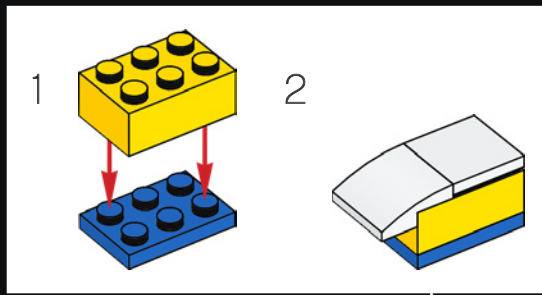
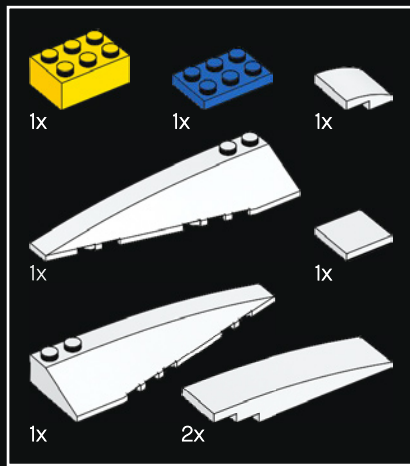

522

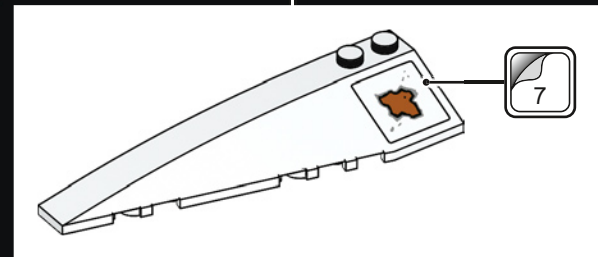
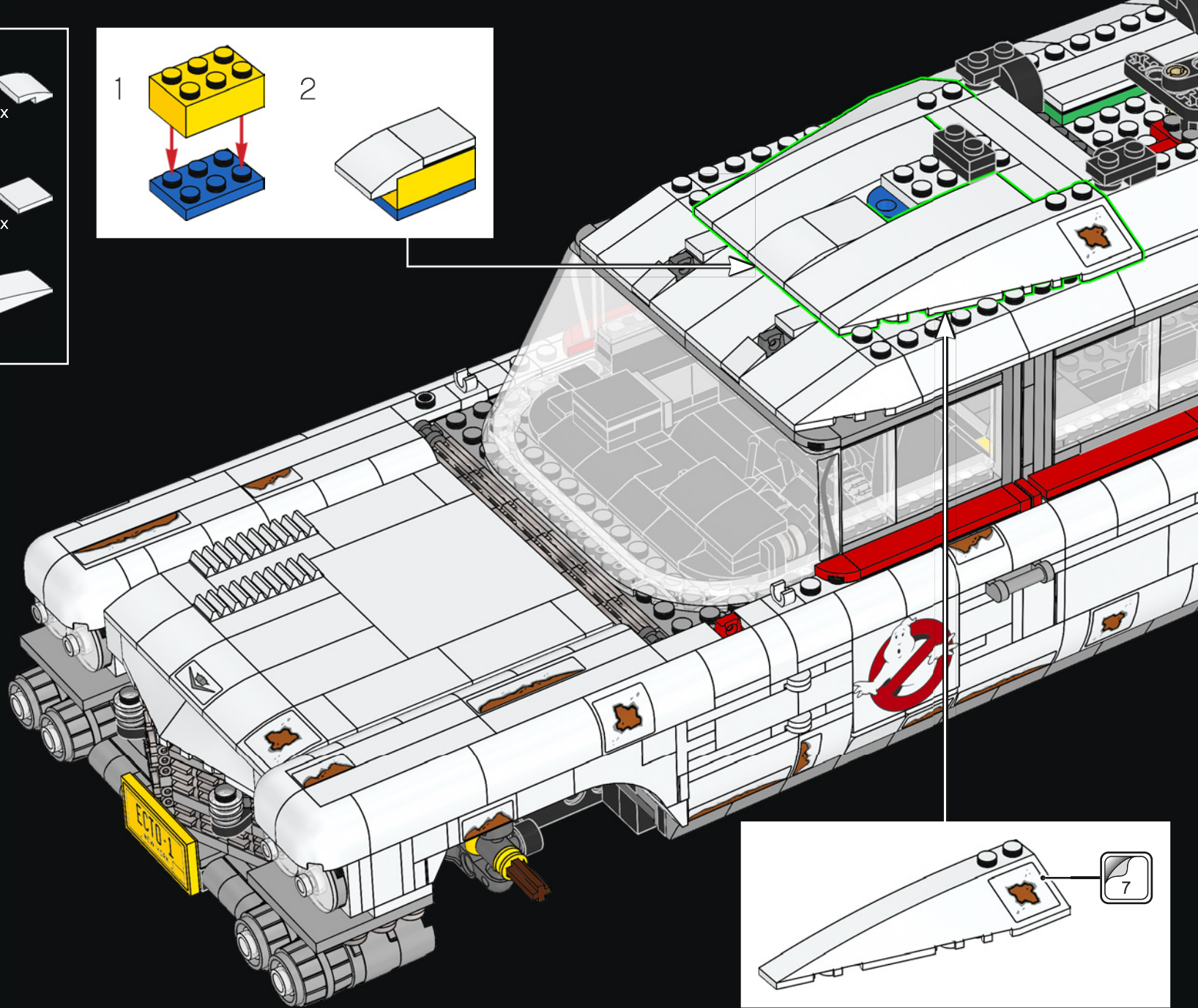

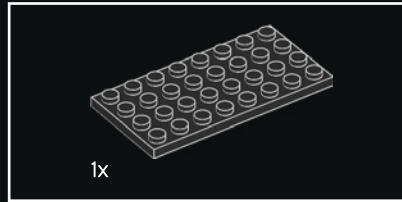
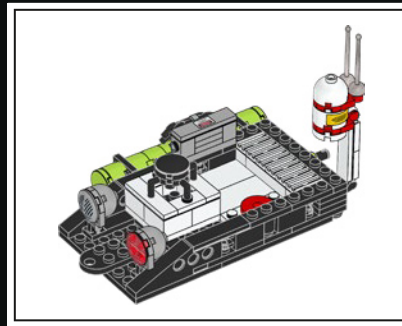
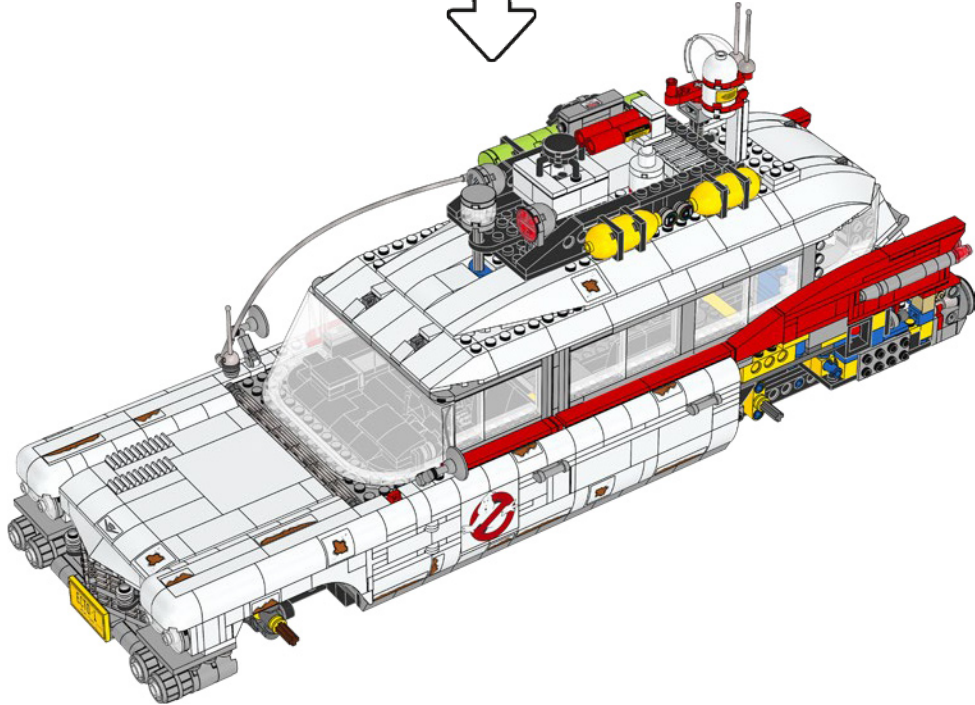
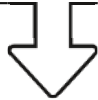

523

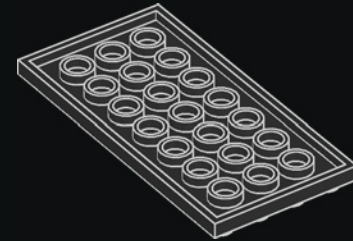

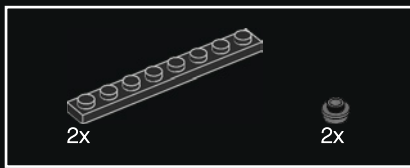

524

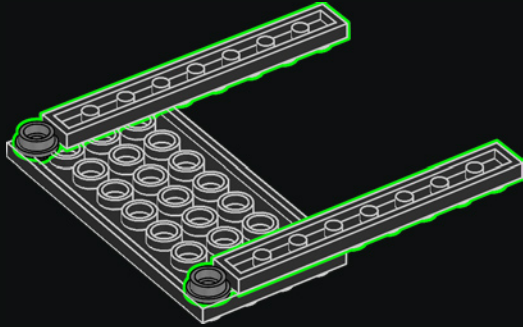

525

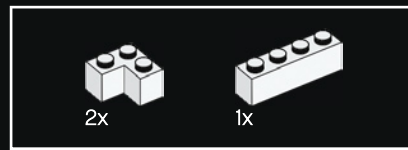
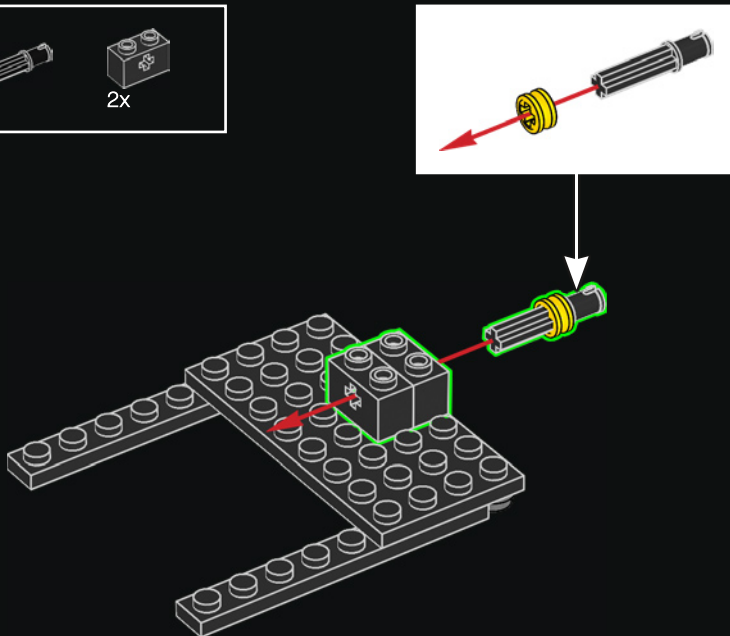

526

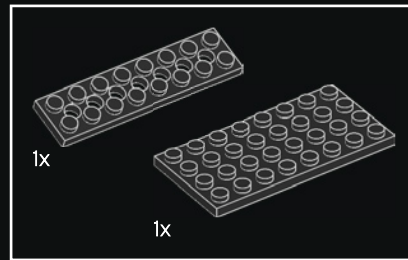
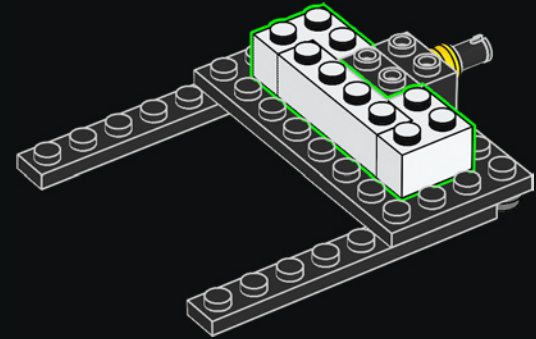

527

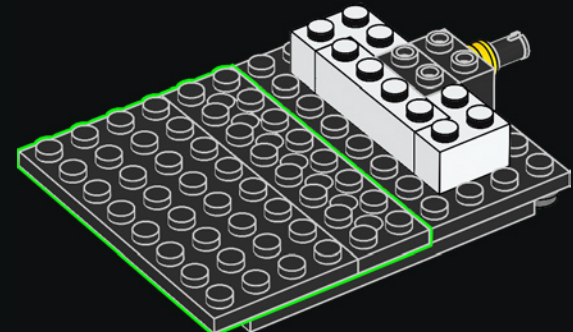

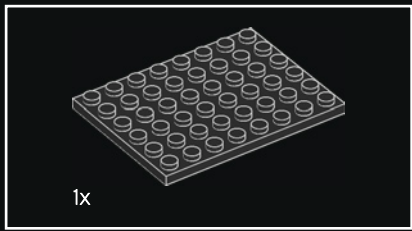

528

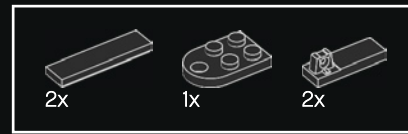
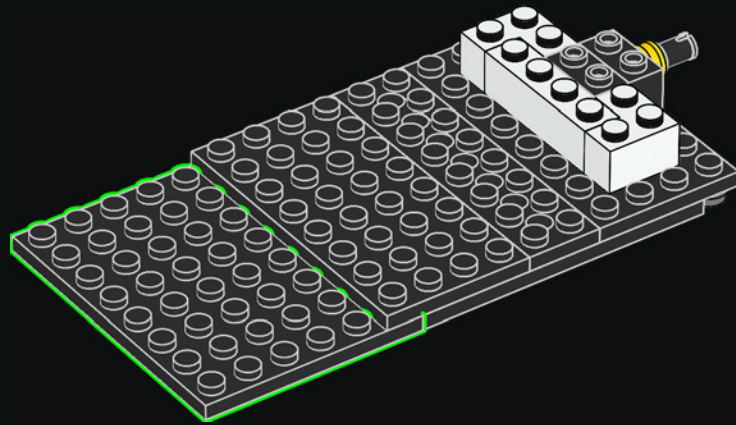

529

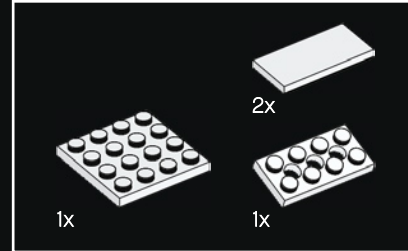
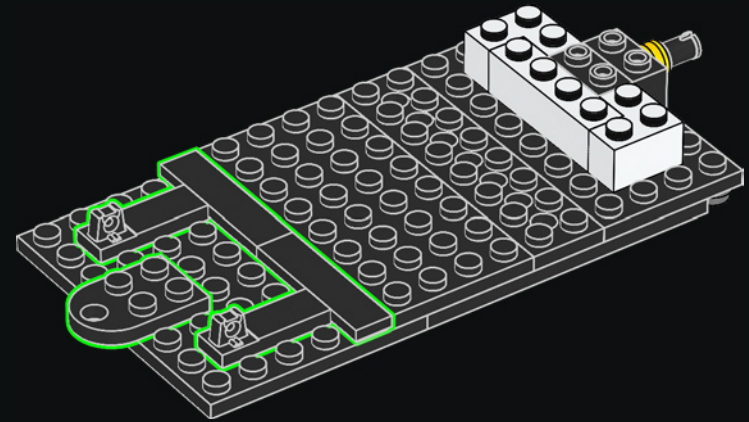

530

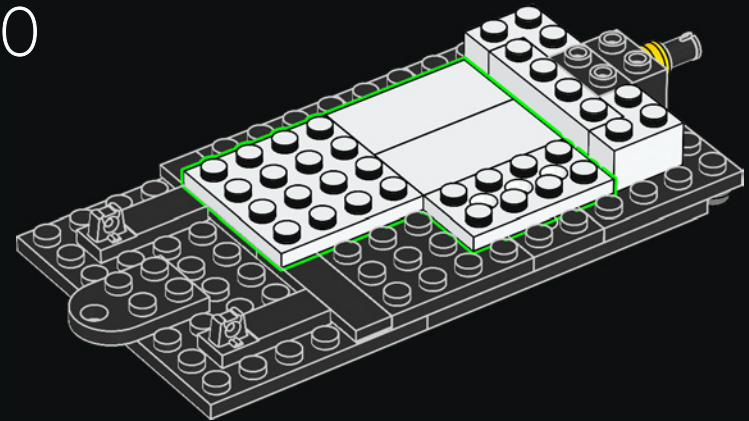

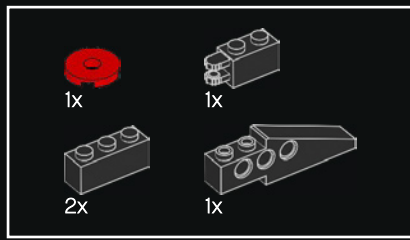

531

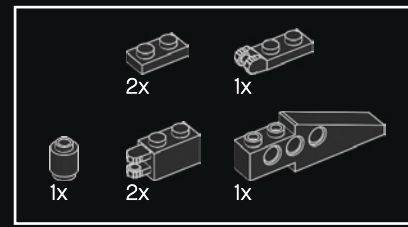
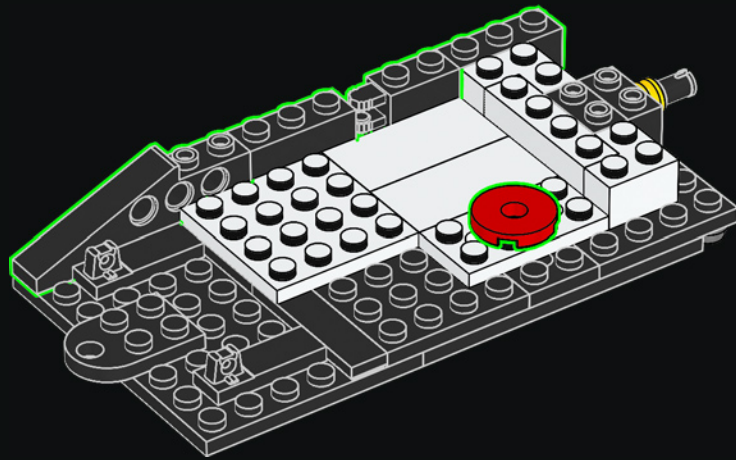

532

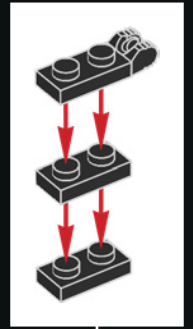
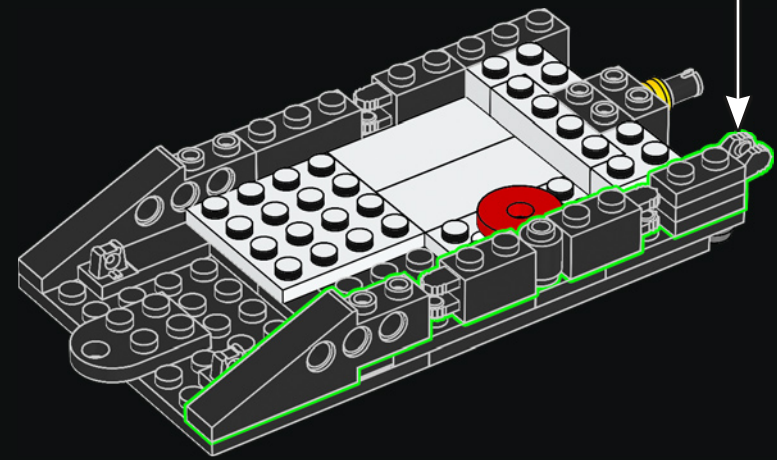

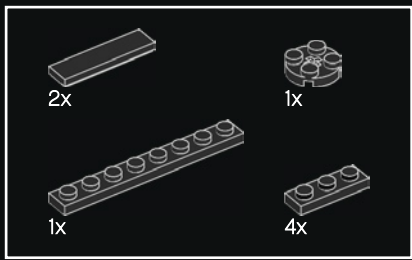

533

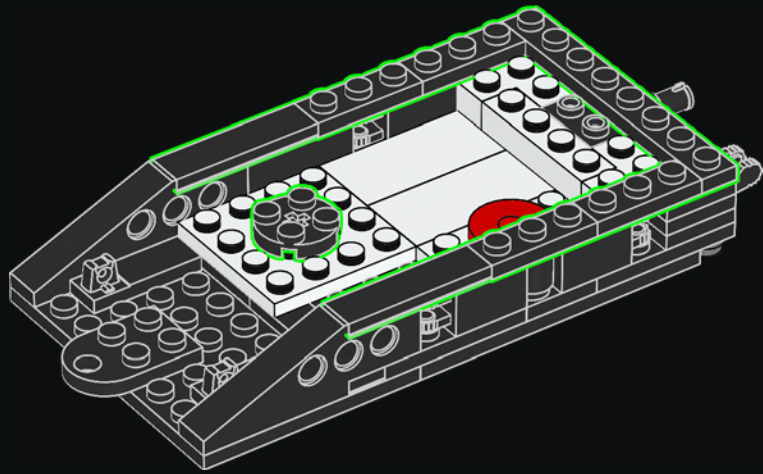

534

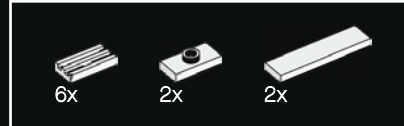
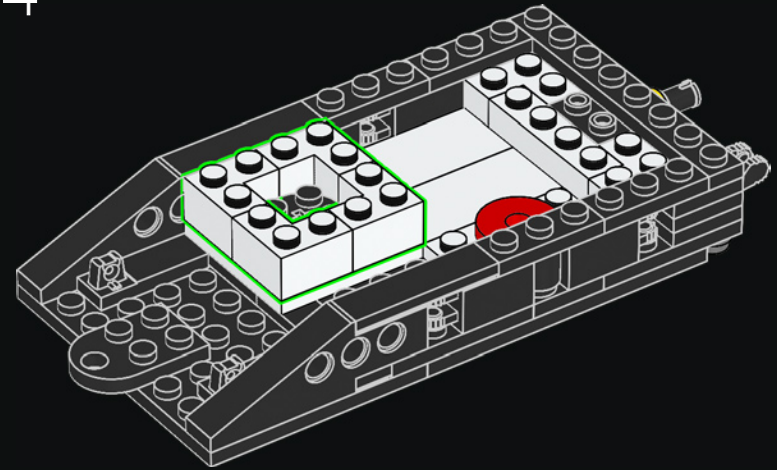

535

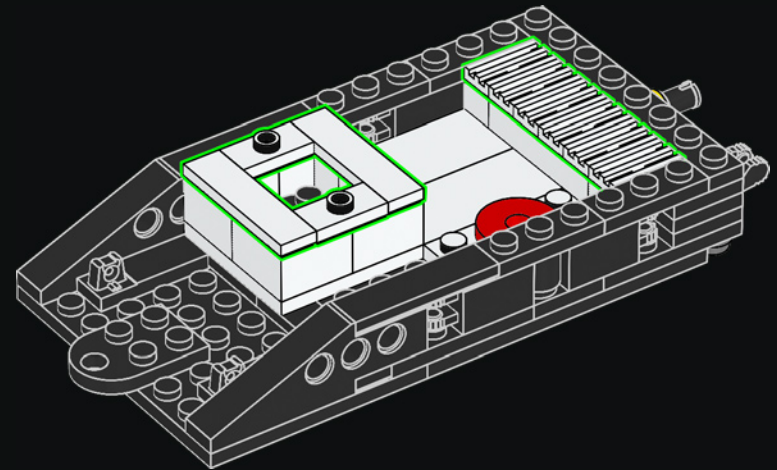

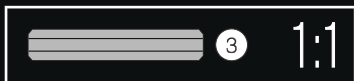
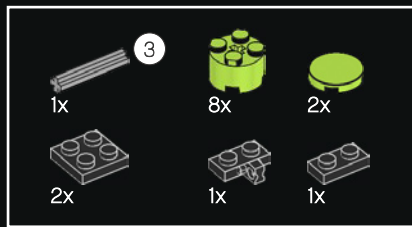

536

1



2

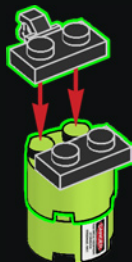

3

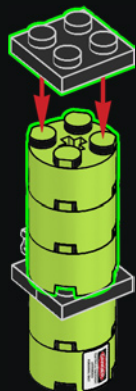

4

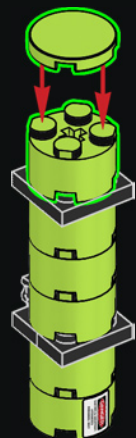

5

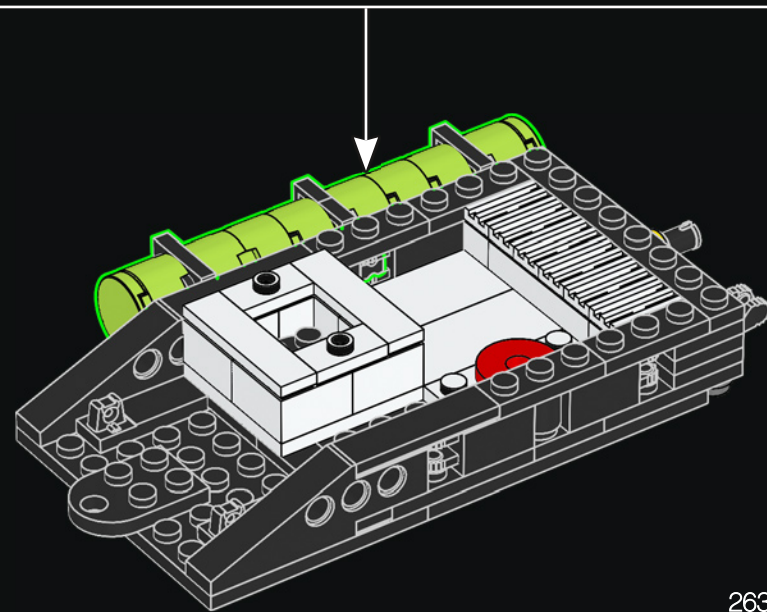
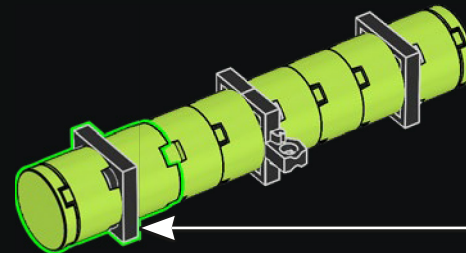
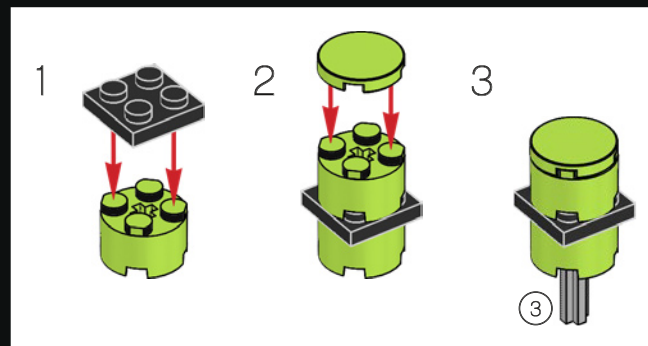

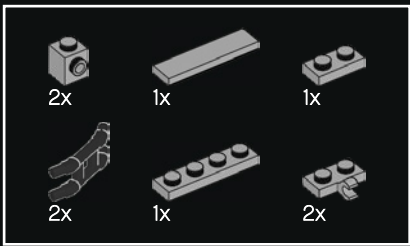

537

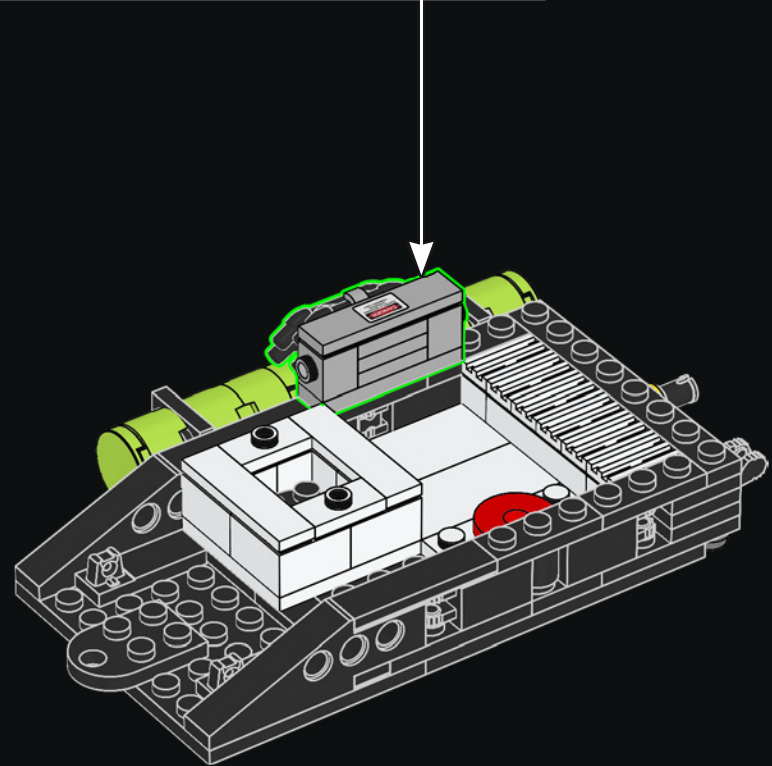
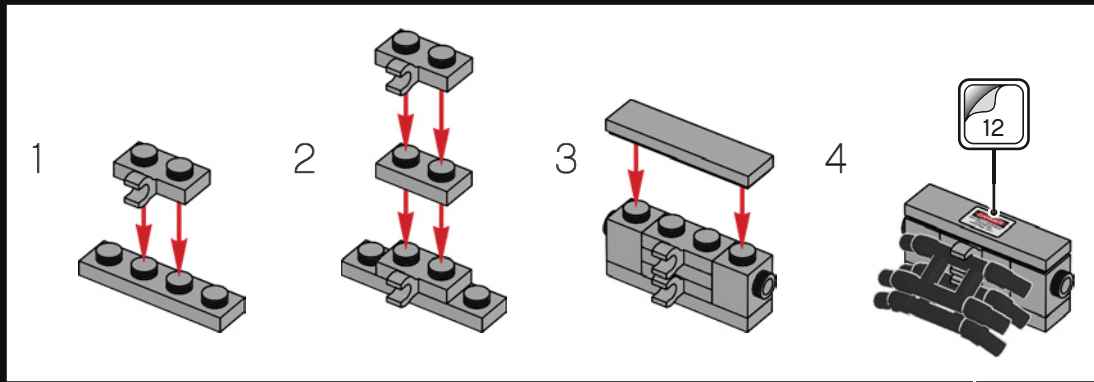



538

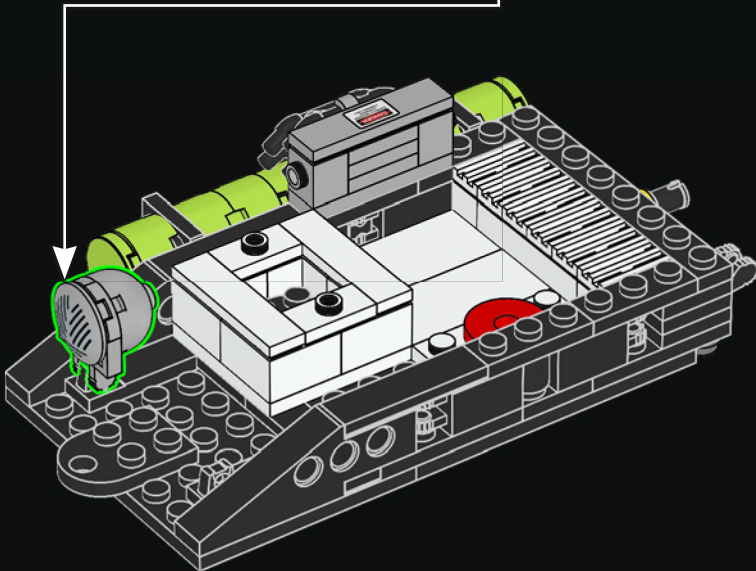
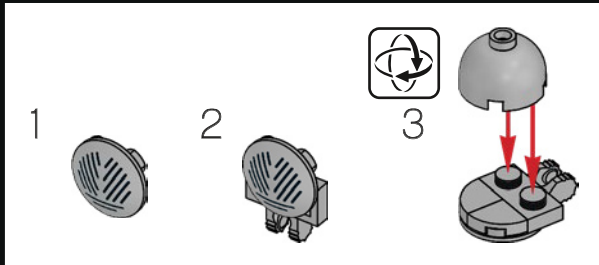

The pitch of this FEDERAL SIREN has been modified to set it apart from other emergency vehicles in New York.
 La fréquence de cette SIRÈNE FEDERAL a été modifiée pour la distinguer des autres véhicules d'urgence à New York.
 El tono de esta SIRENA FEDERAL se modificó para distinguirlo del resto de los vehículos de emergencias de Nueva York.



539

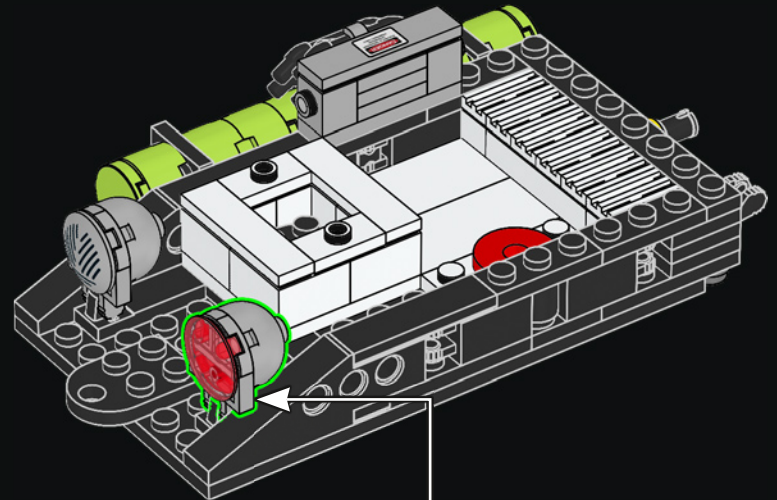

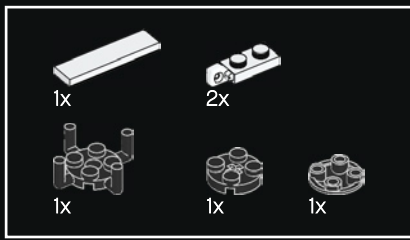

540

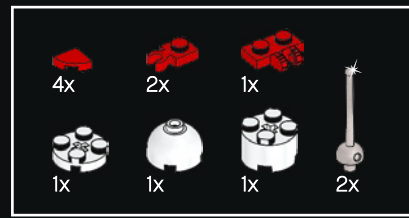
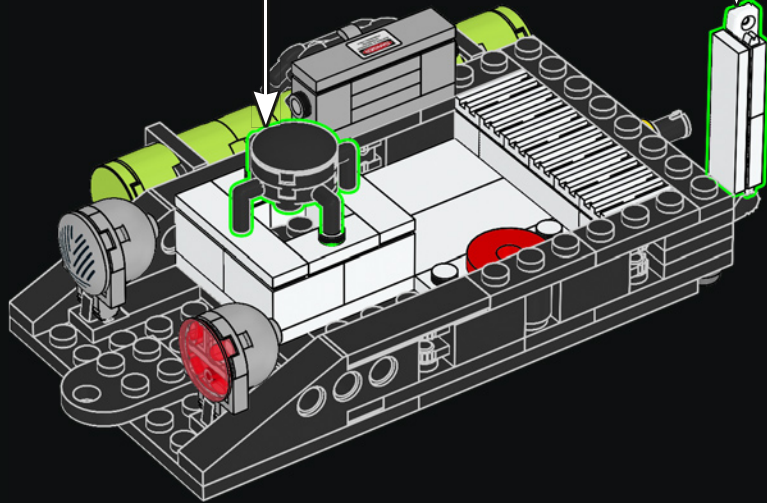
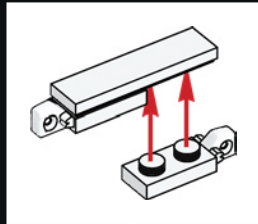
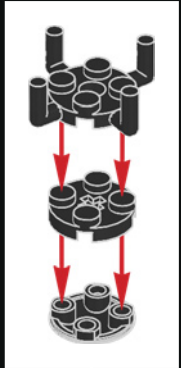

541

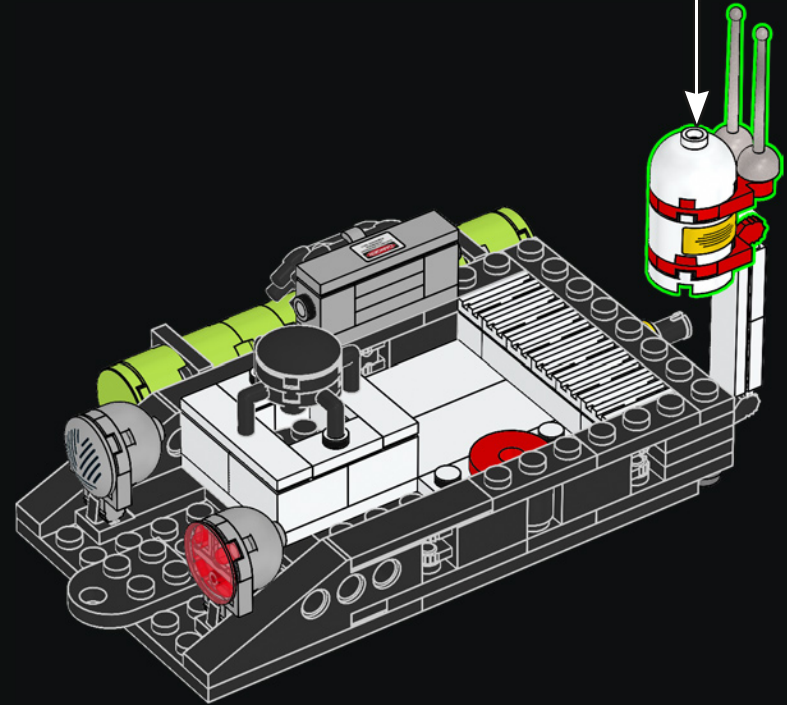
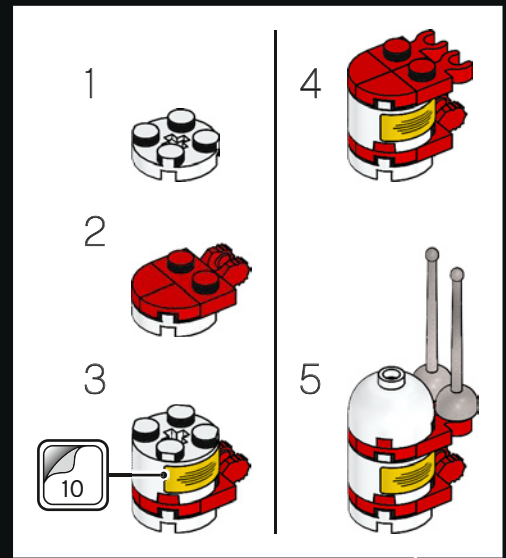



The MODIFIED MARINE RADOME ANTENNA sends out a sonar-like sweep to detect spectral particles.

L'ANTENNE RADÔME MARINE MODIFIÉE envoie un balayage en sonar pour détecter les particules spectrales.

La ANTENA RADOMO MARINA MODIFICADA hace barridos como un sonar para detectar partículas espectrales.

542

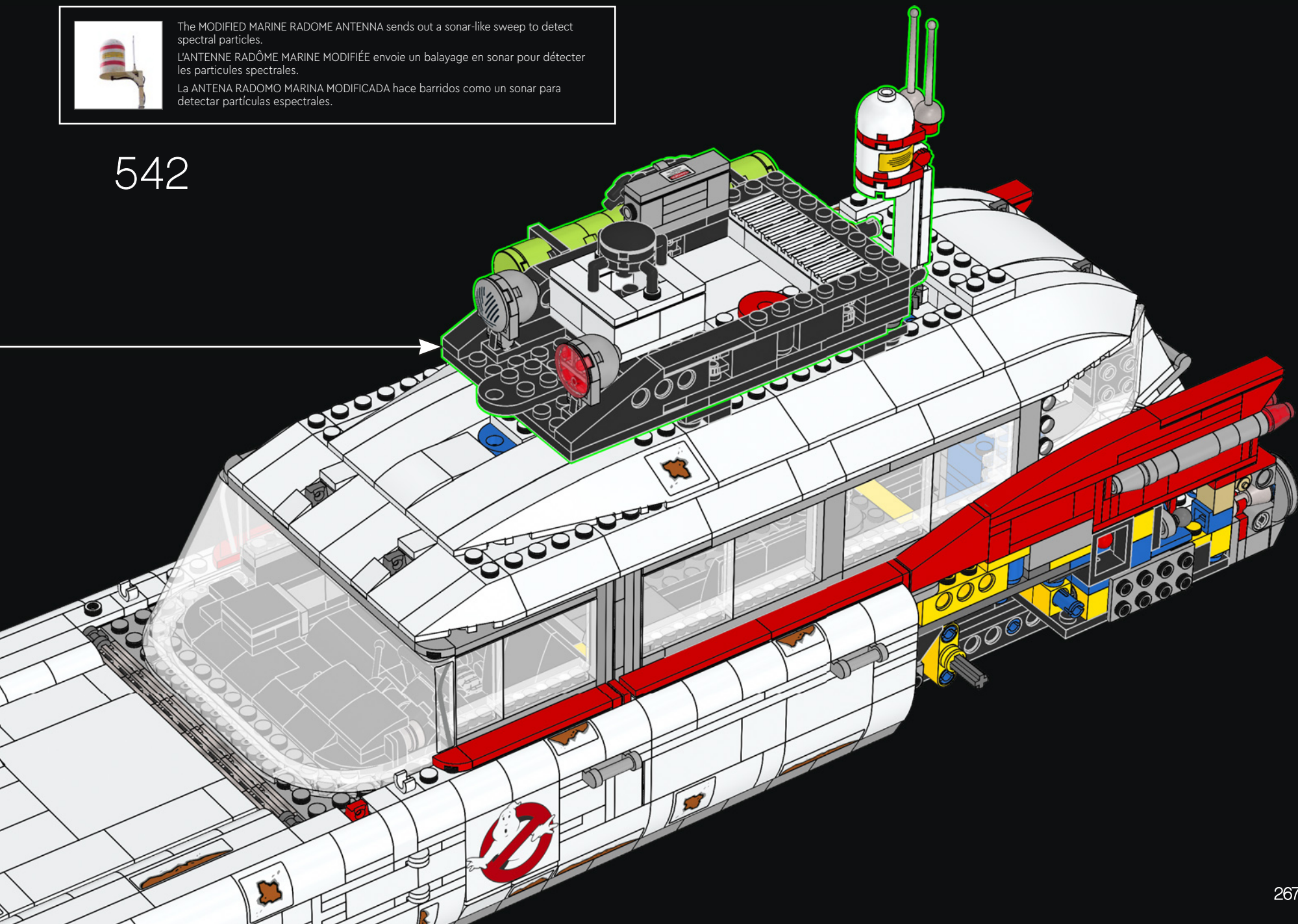

543

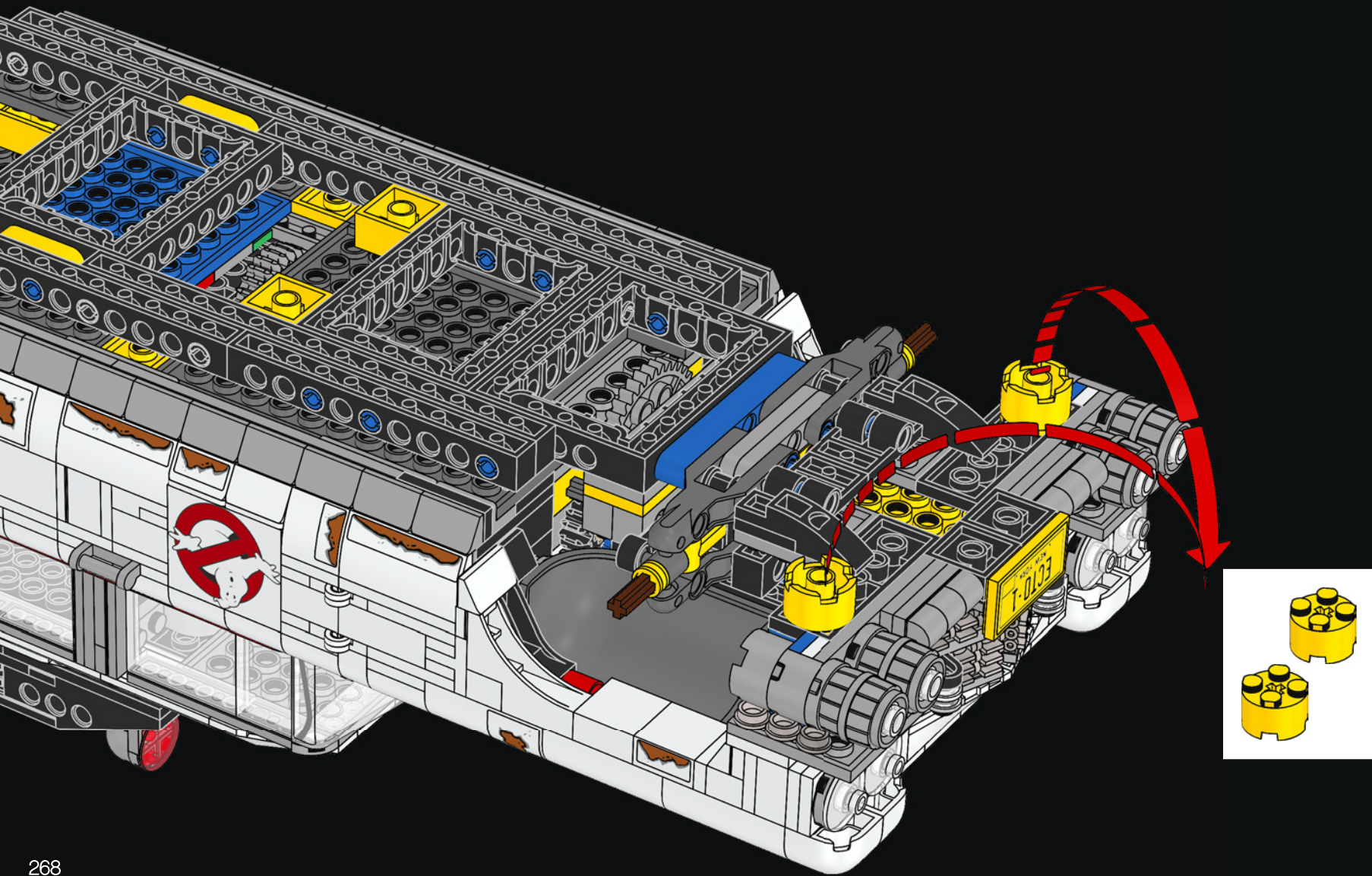

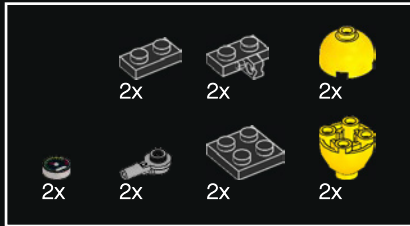
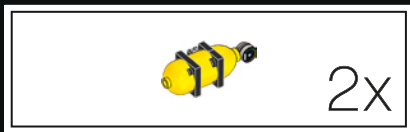

544

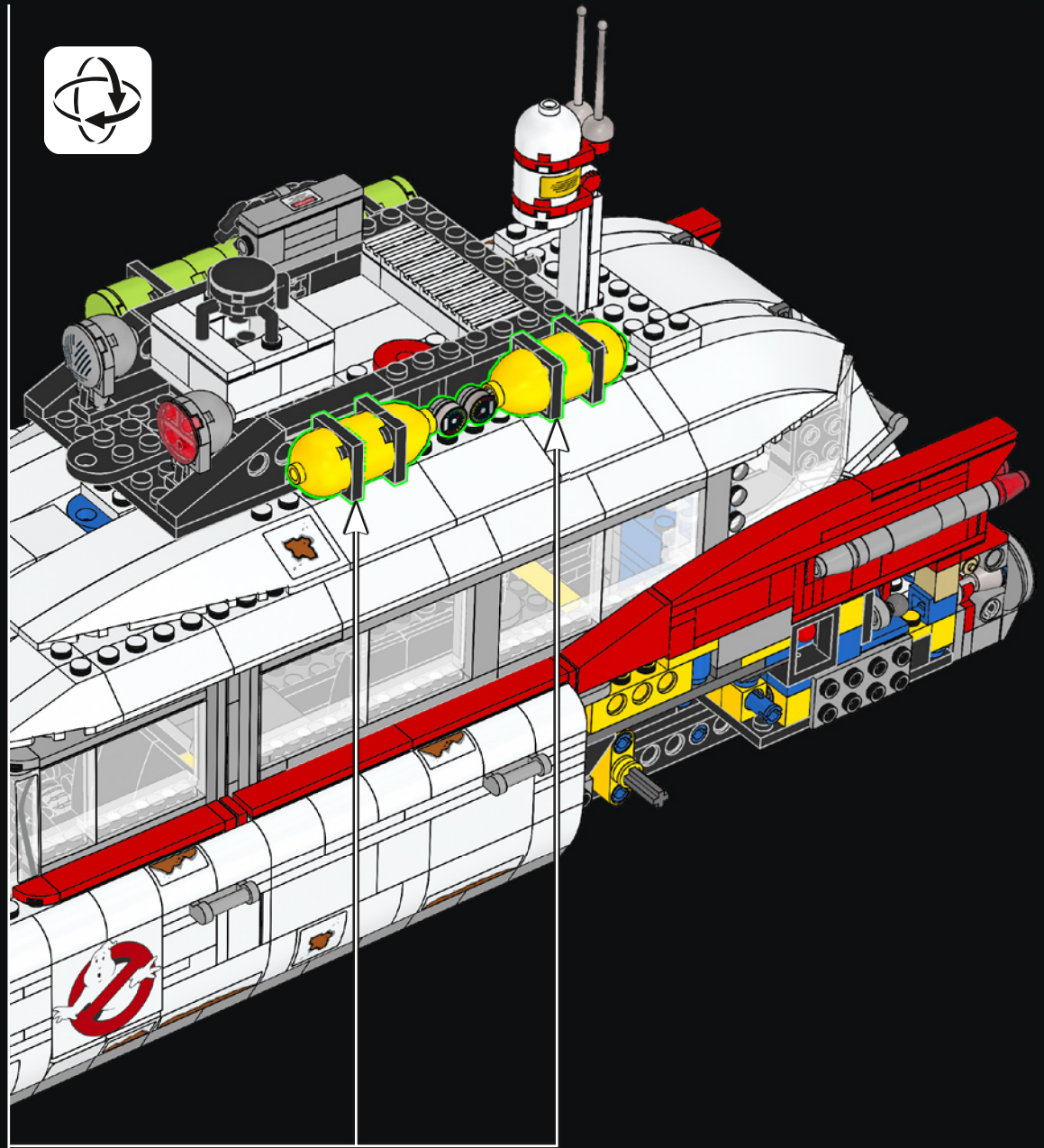
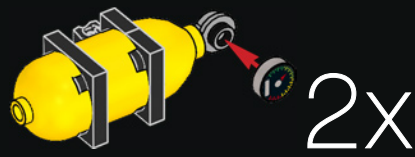
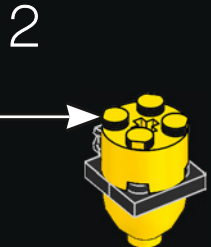
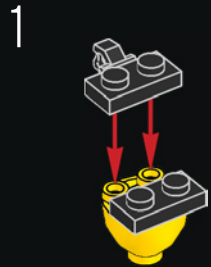



546



548

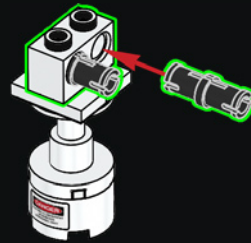

550

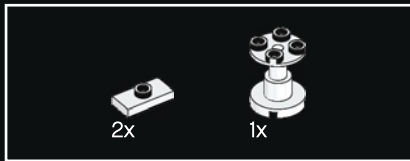
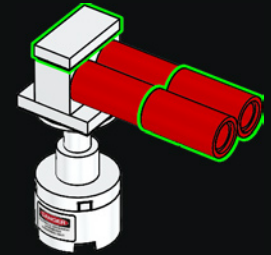

547



549

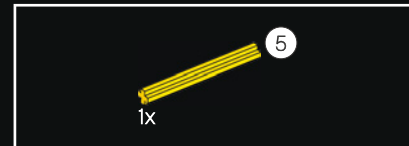
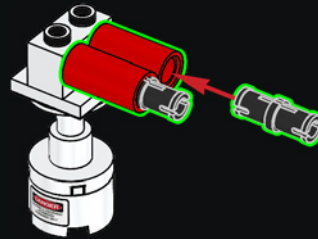

551

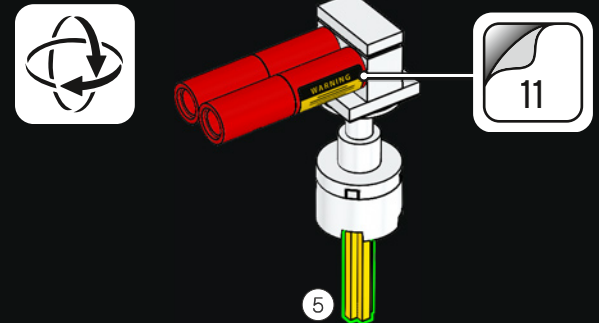



The T.U. ANTENNA, better known as the "SNIFFER", monitors psychokinetic energy.

L'ANTENNE T.U., mieux connue sous le nom de « DÉTECTEUR », capte l'énergie psychokinétique.

La ANTENA T. U., un dispositivo de detección formado por dos barras que sobresalen, registra la energía psicokinética.

552

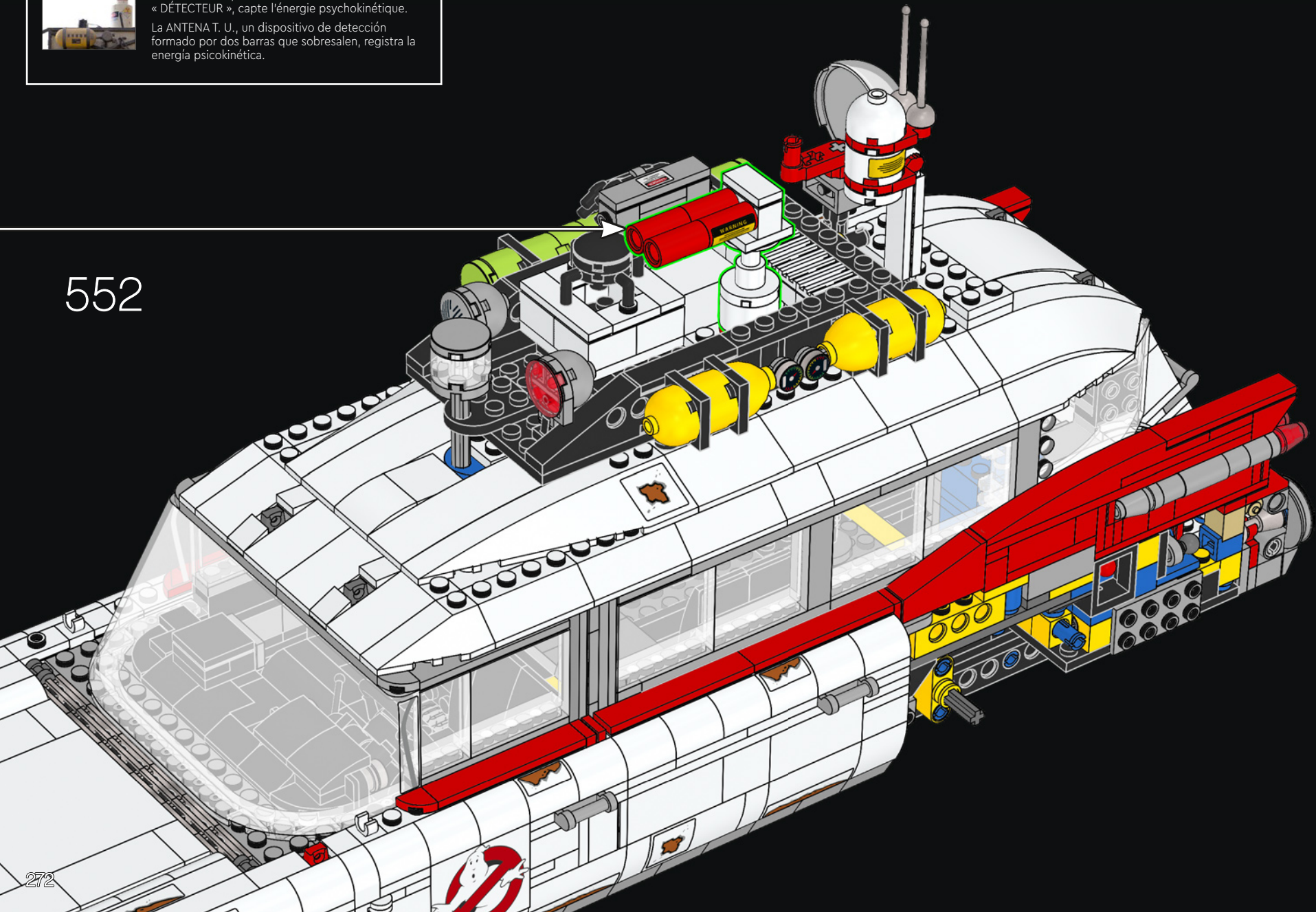

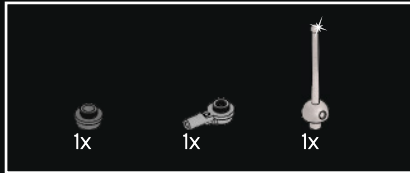
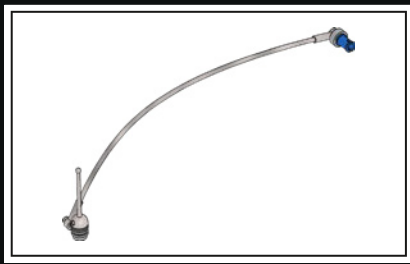

553

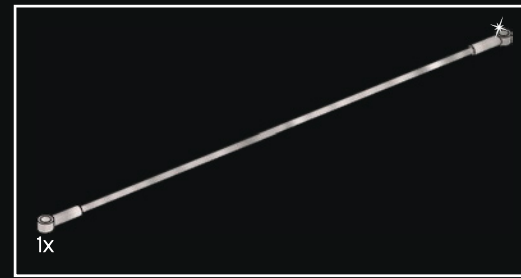

554

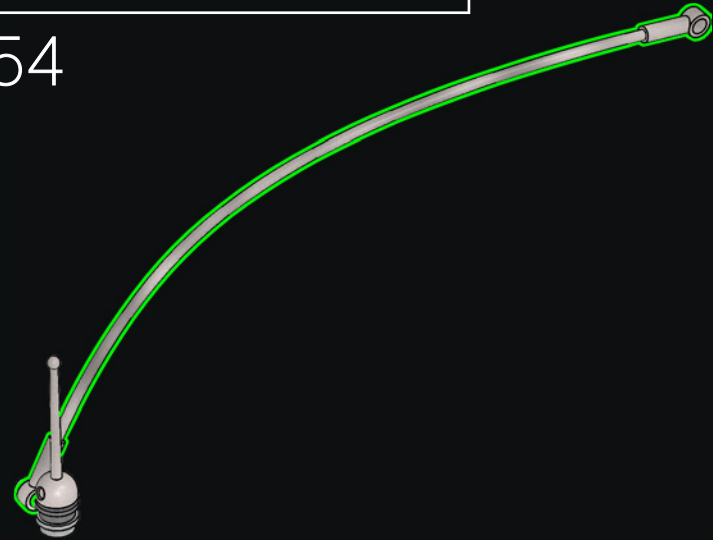

555





556

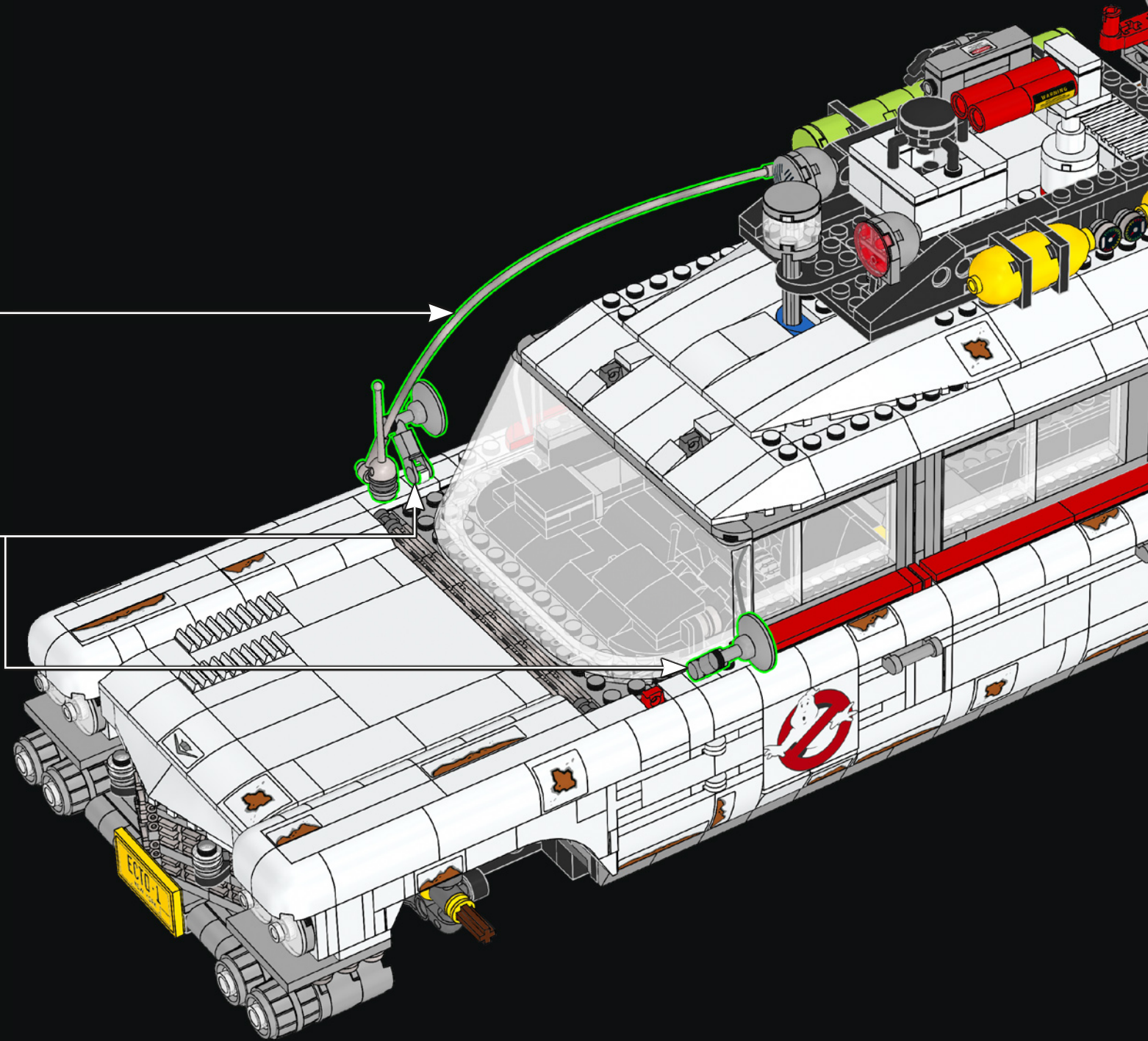
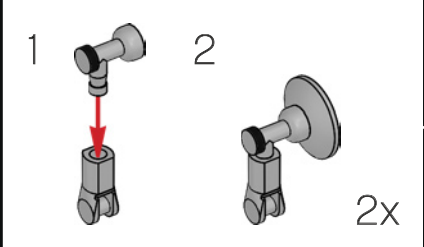

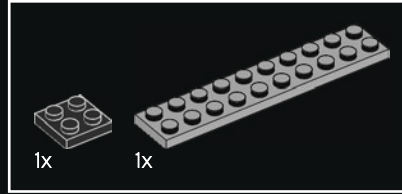
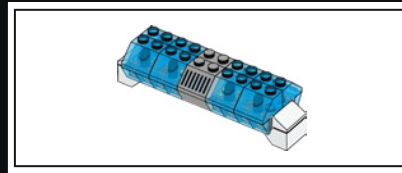
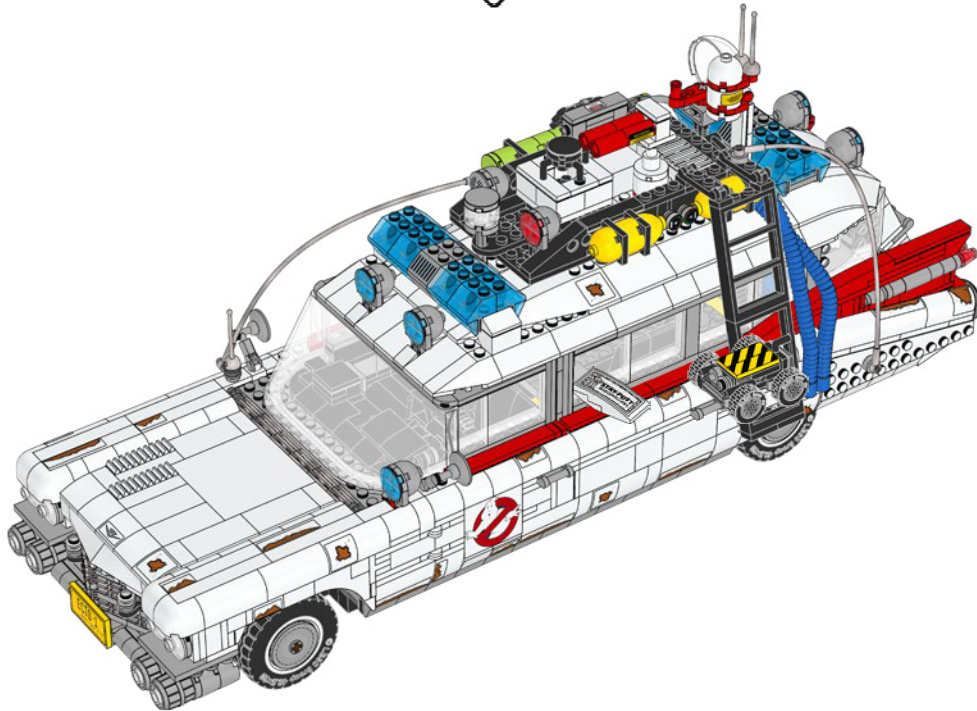
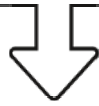

557

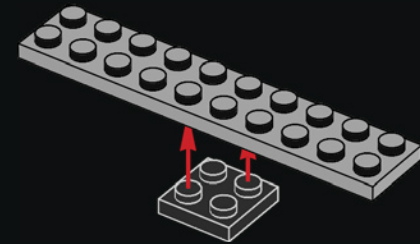

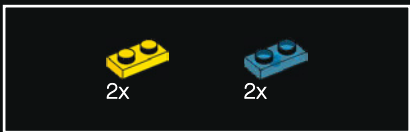

558

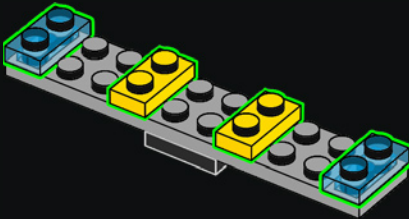

559

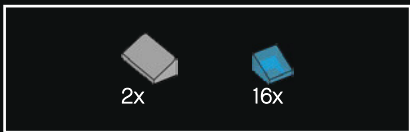
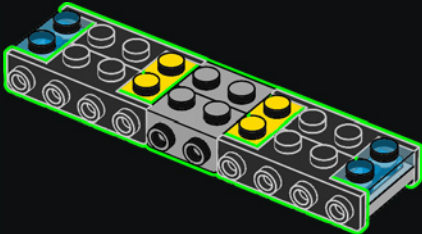

560

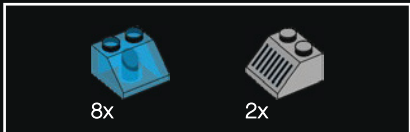
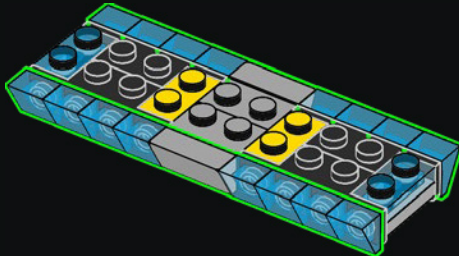

561

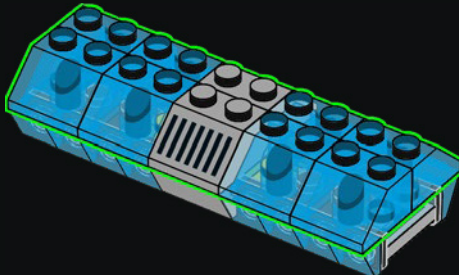

562

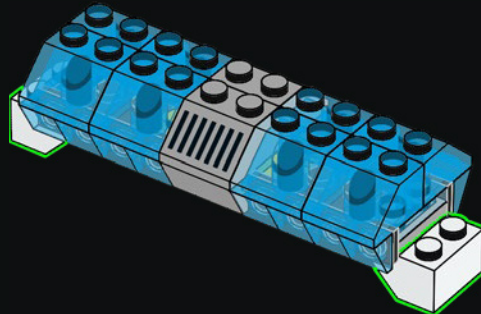

563

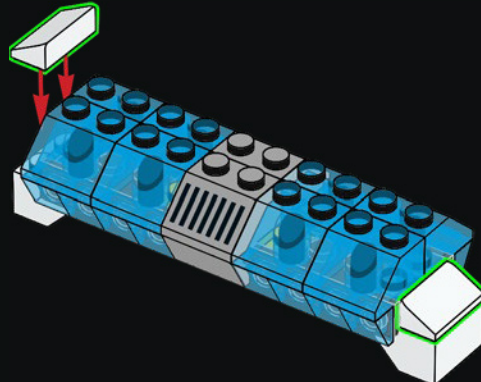

564

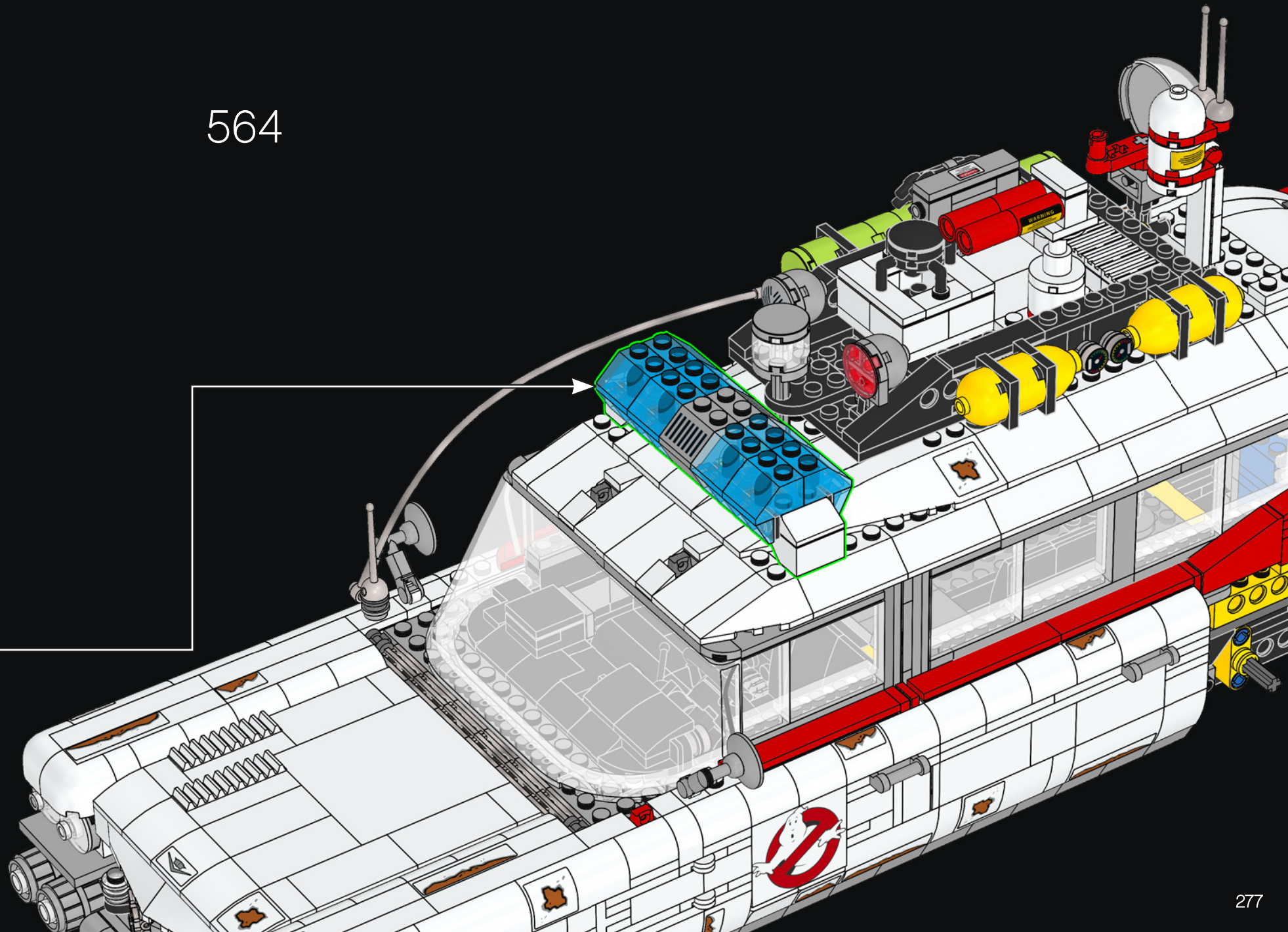



565

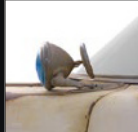
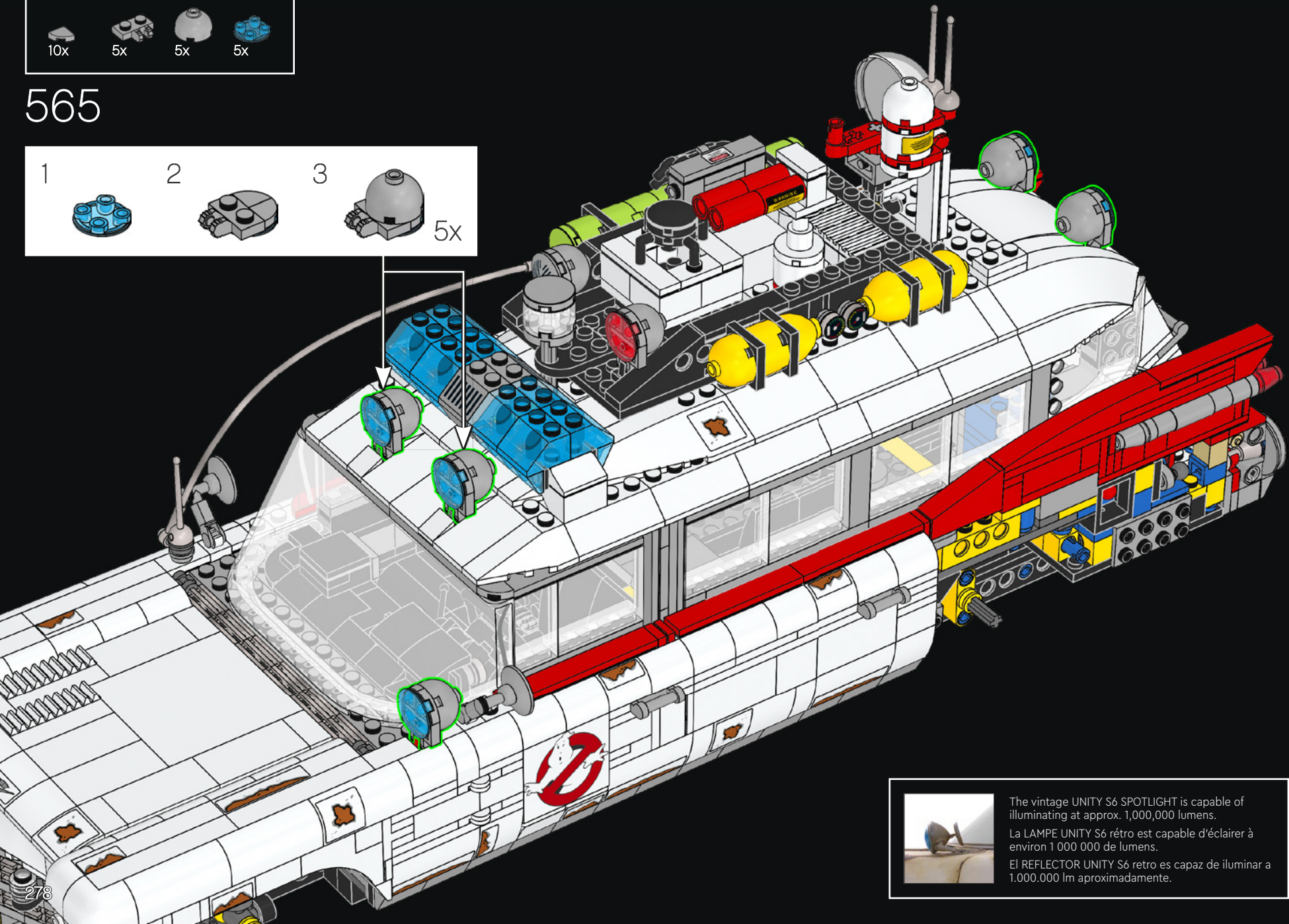

The vintage UNITY S6 SPOTLIGHT is capable of illuminating at approx. 1,000,000 lumens.
La LAMPE UNITY S6 rétro est capable d'éclairer à environ 1 000 000 de lumens.
El REFLECTOR UNITY S6 retro es capaz de iluminar a 1.000.000 lm aproximadamente.

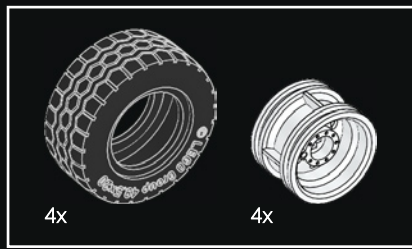

566

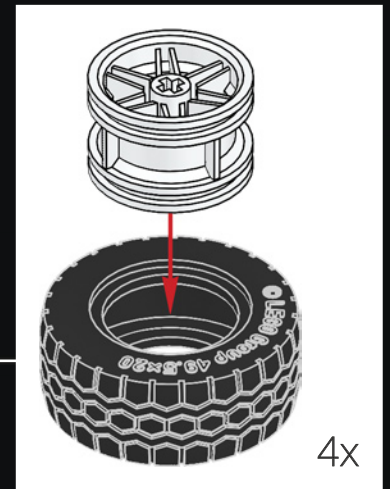
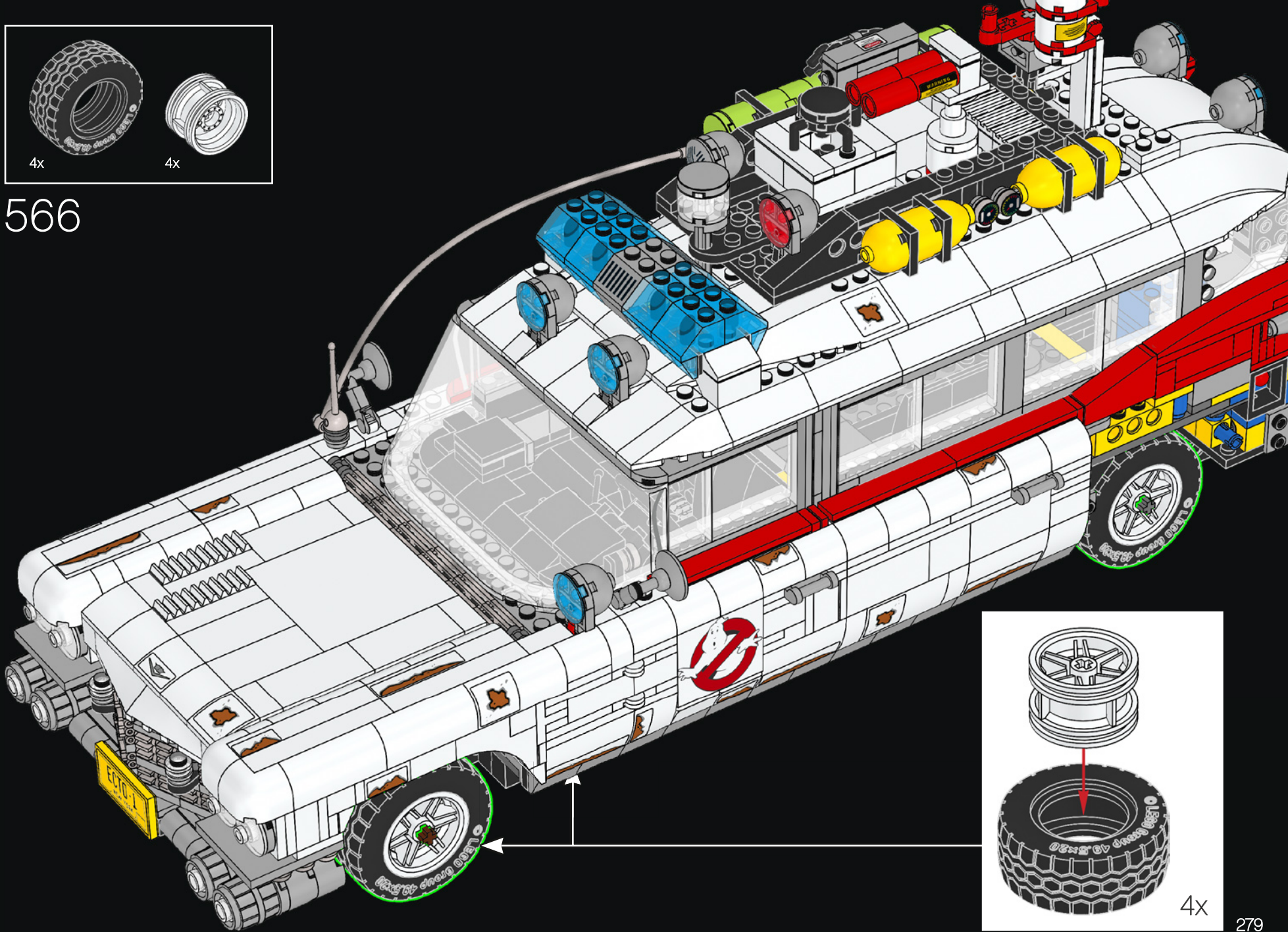



567

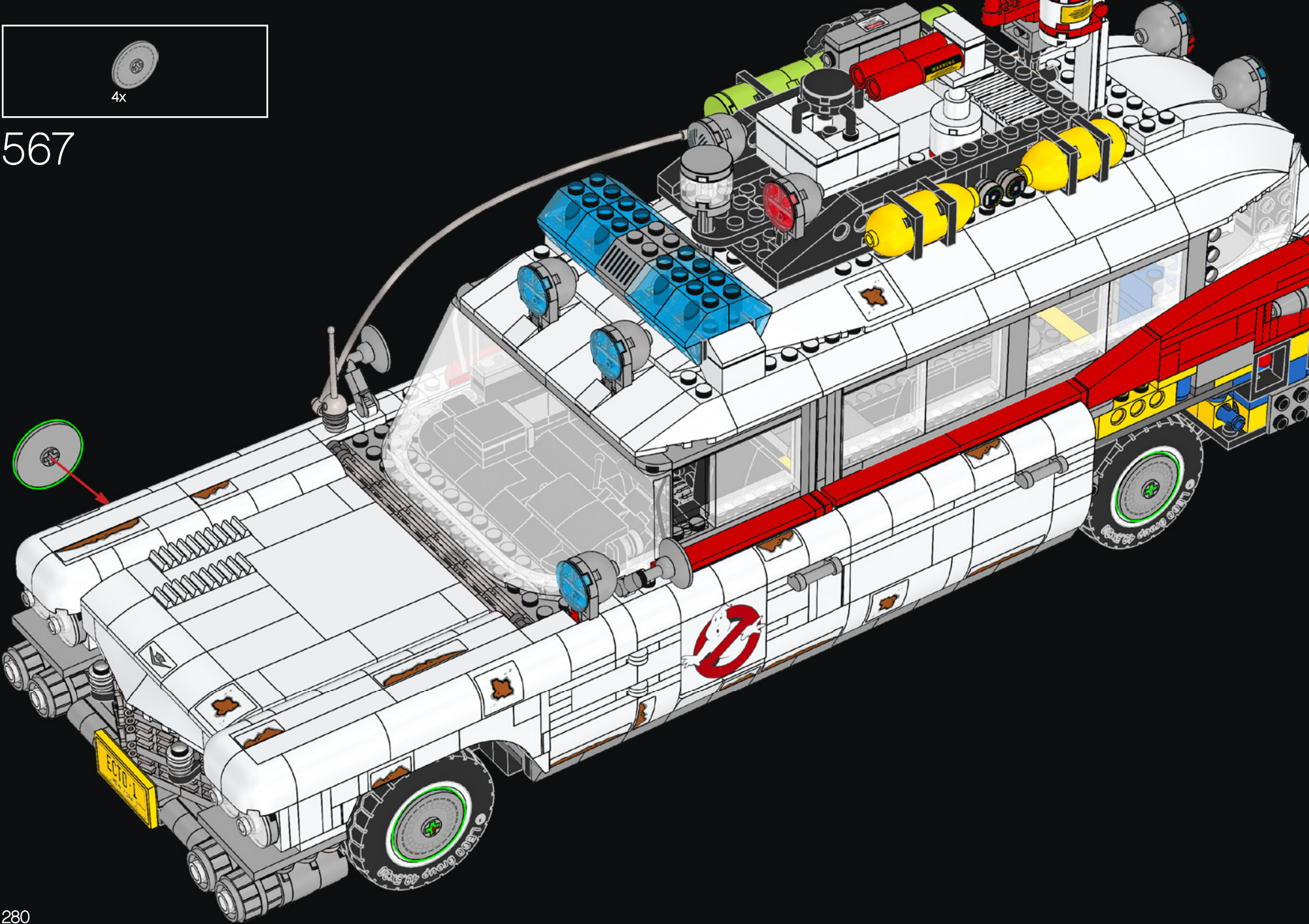

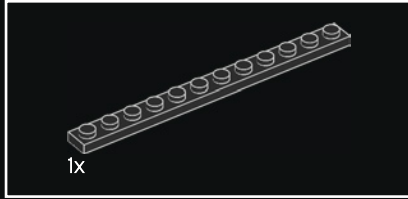
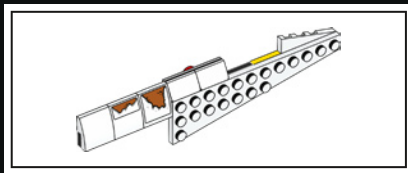

568

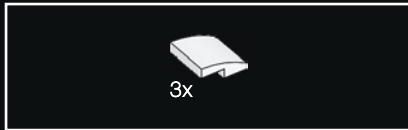
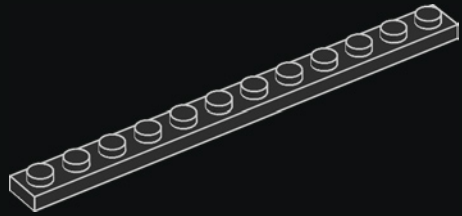

569

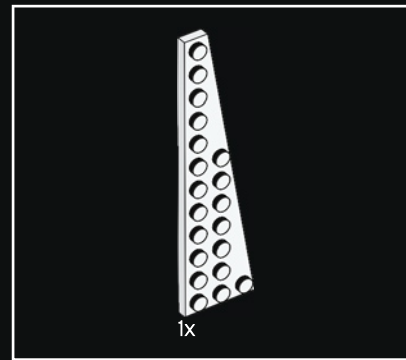
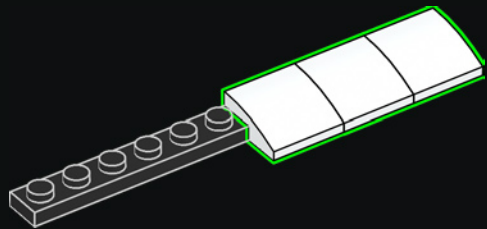

570

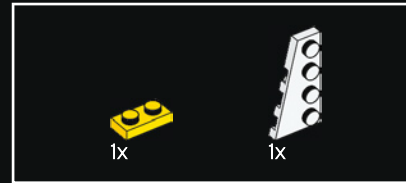
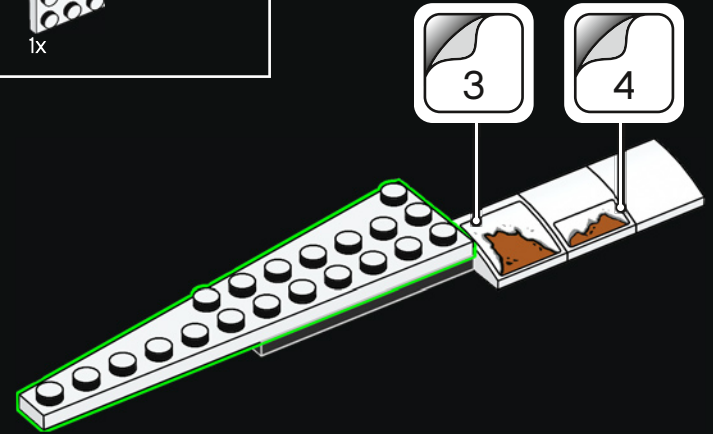

571

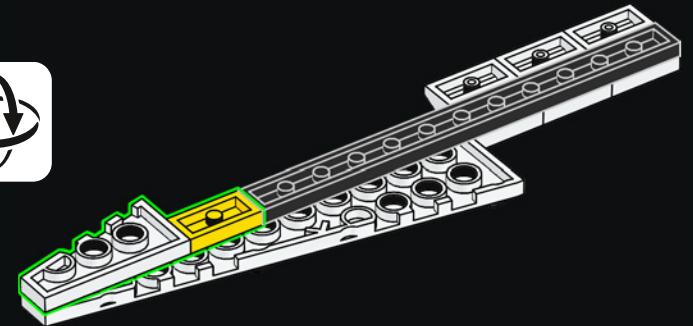

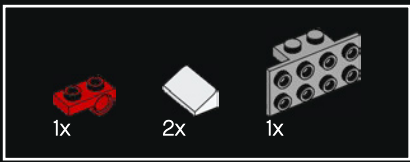

572

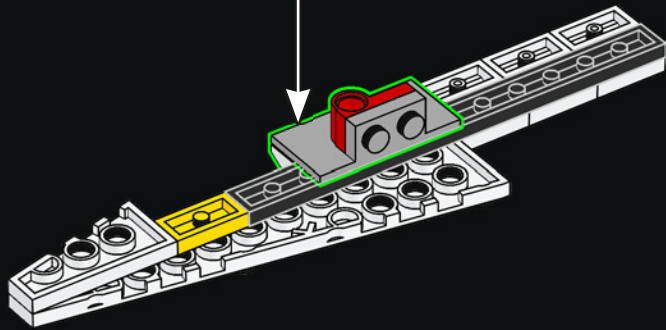
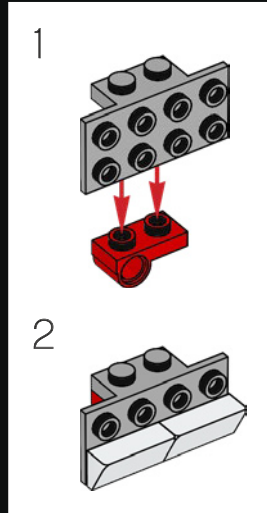

573

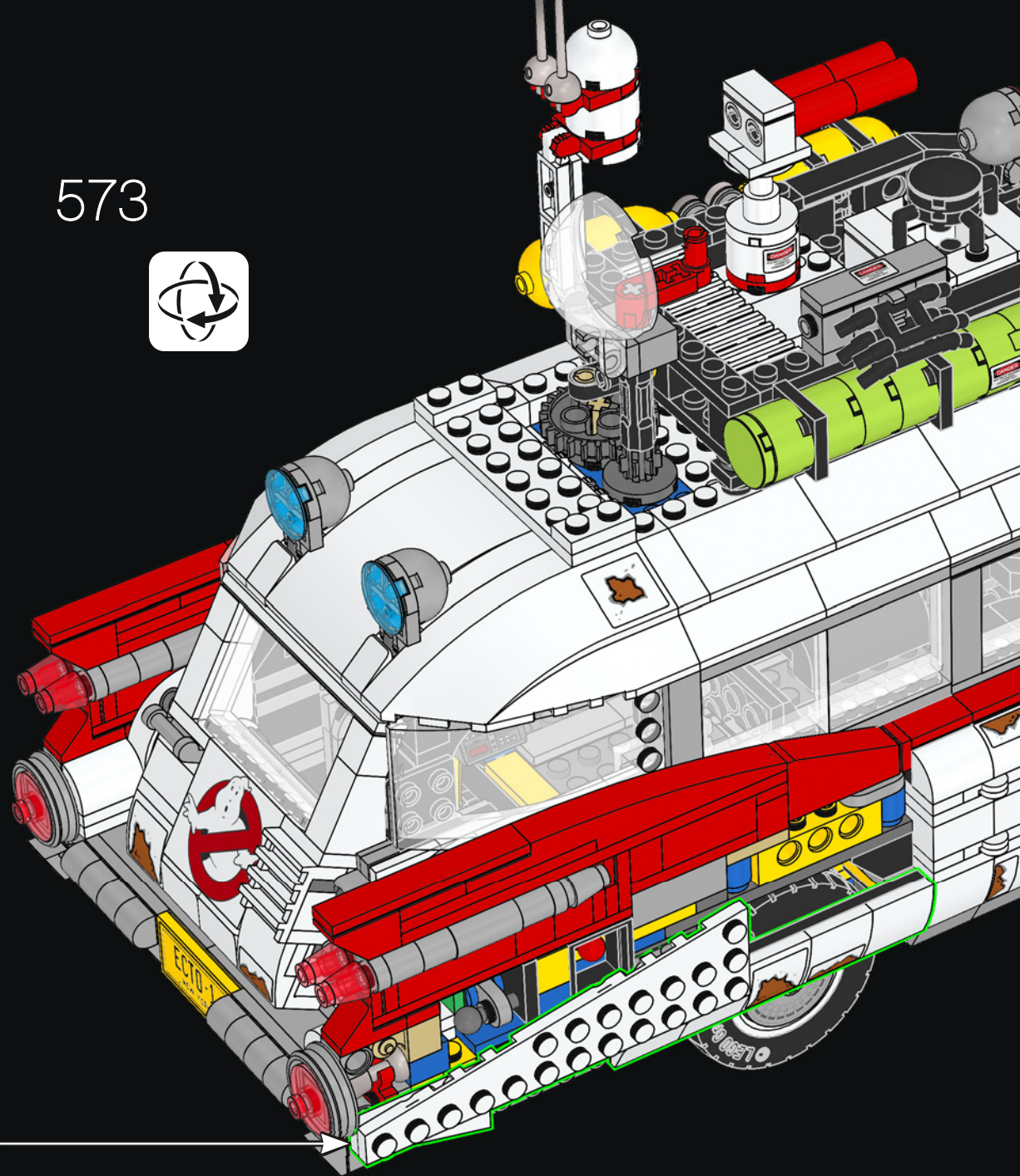

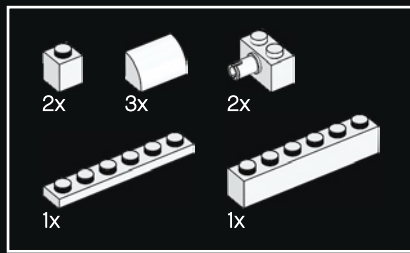

574

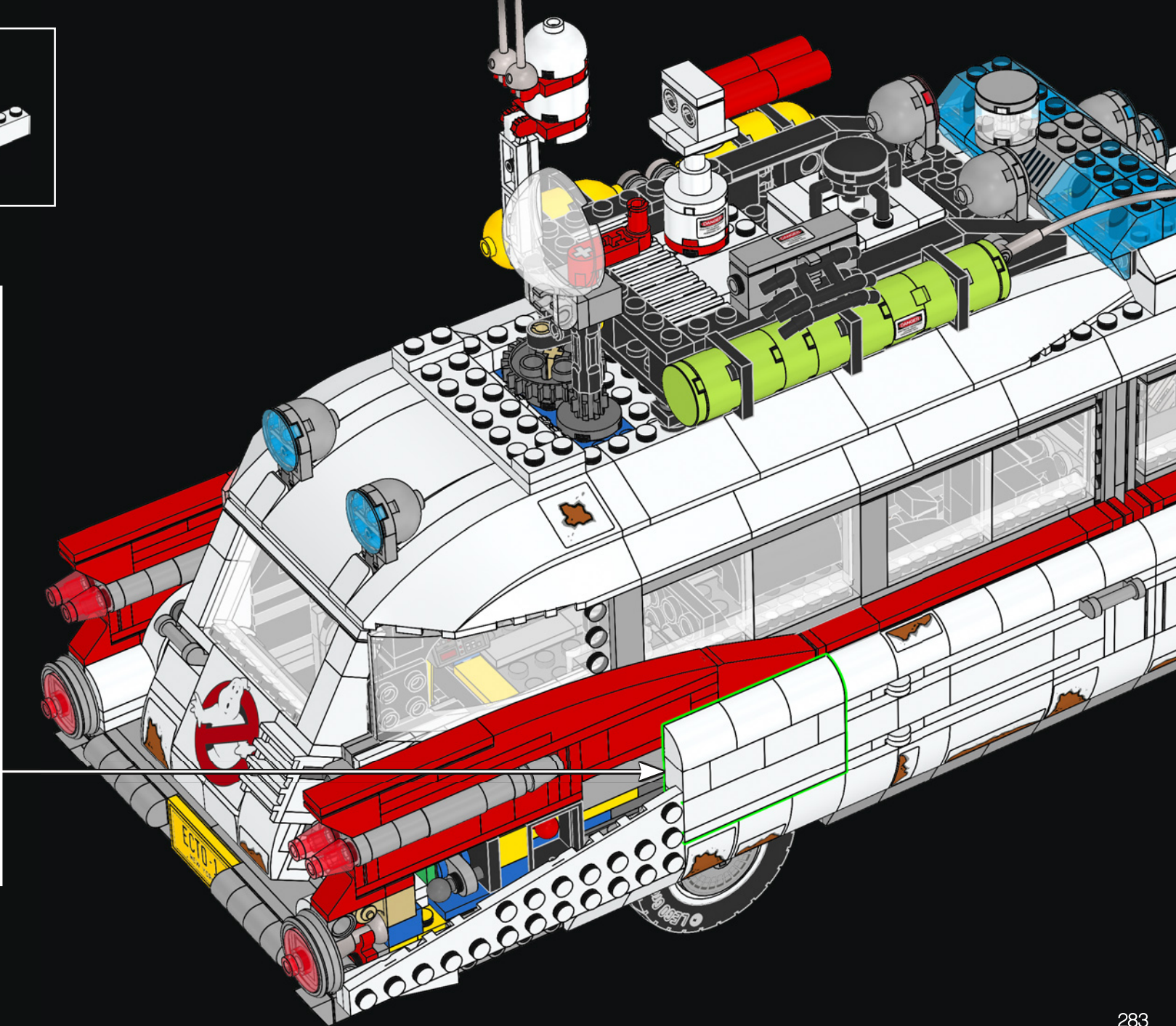
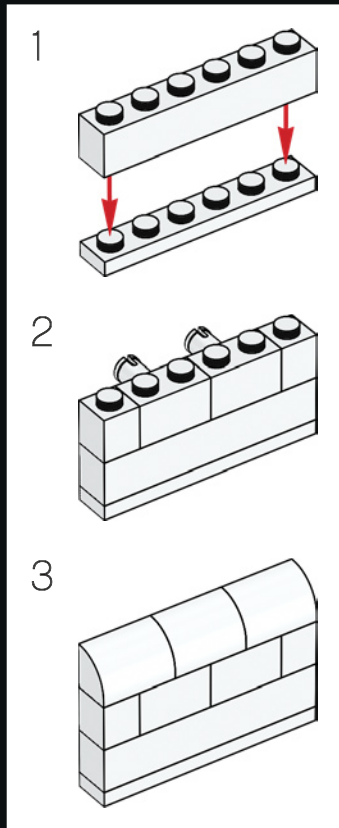

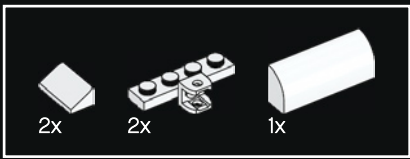

575

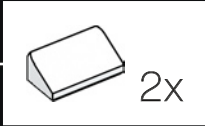
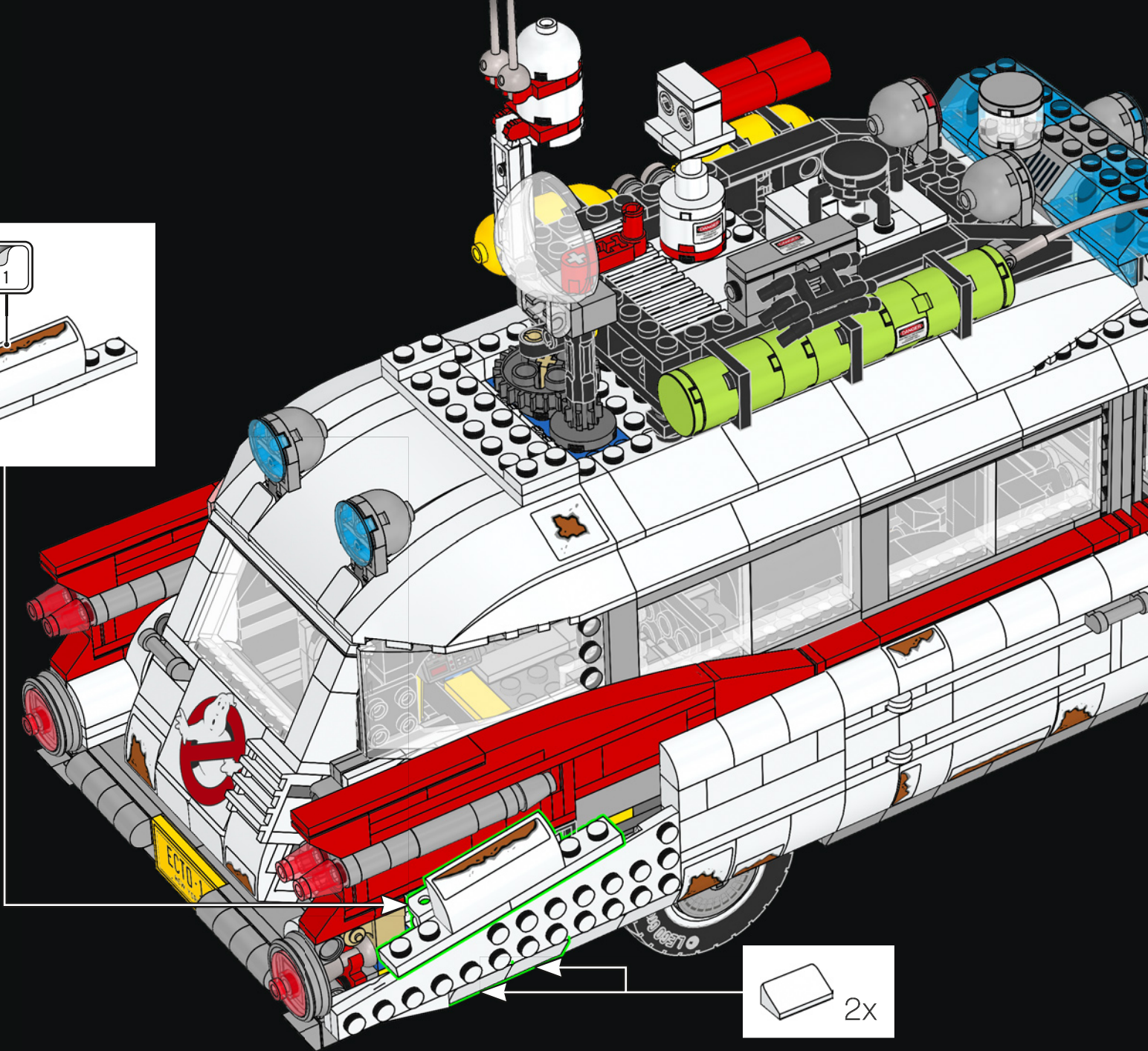
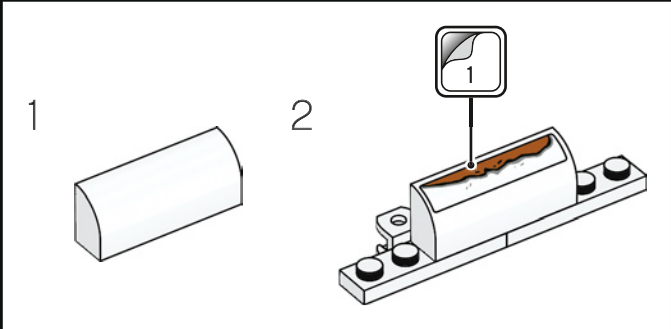

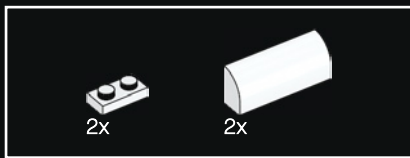

576

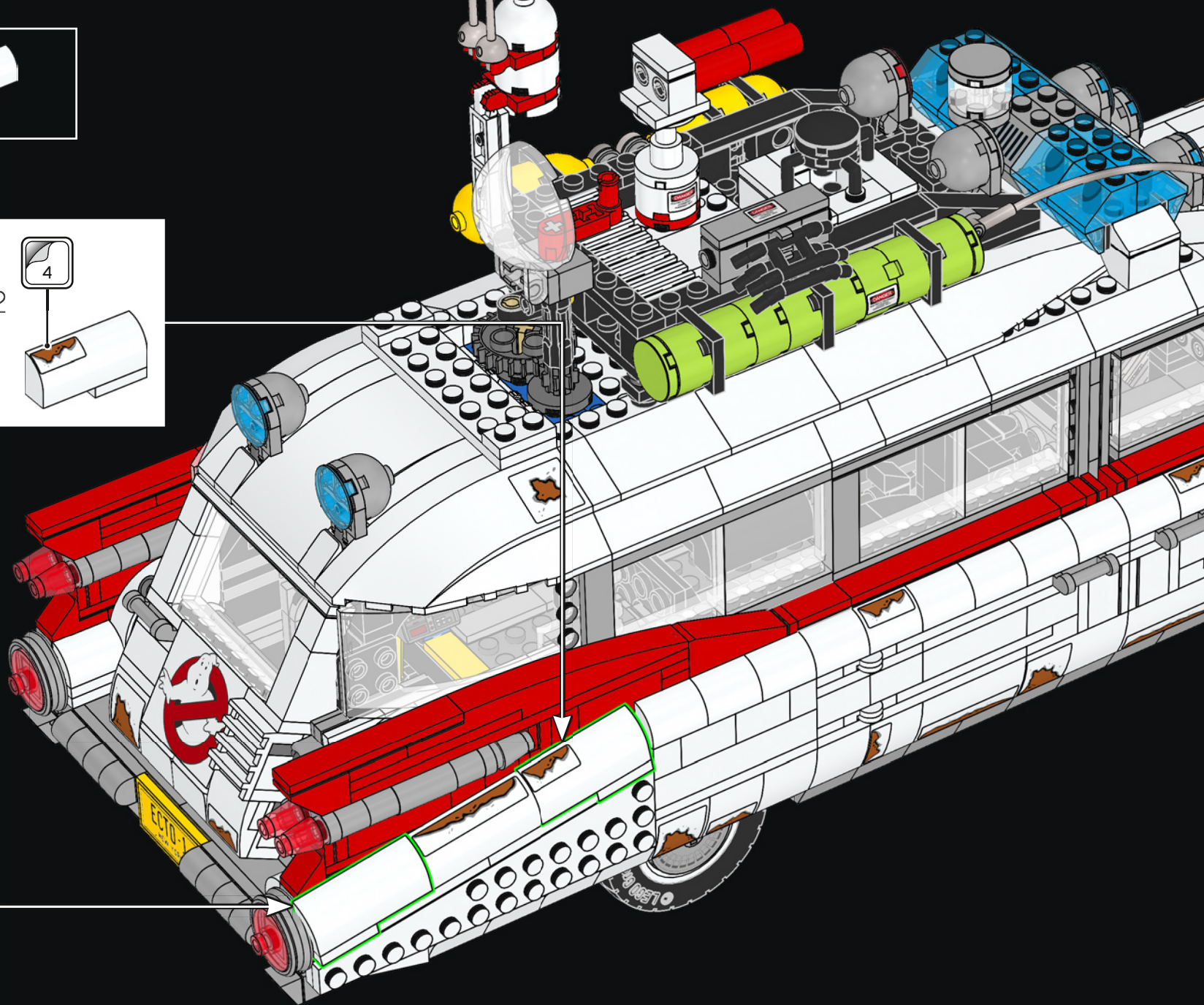
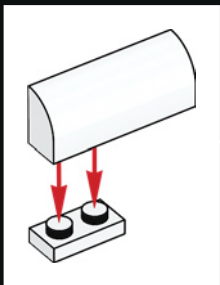
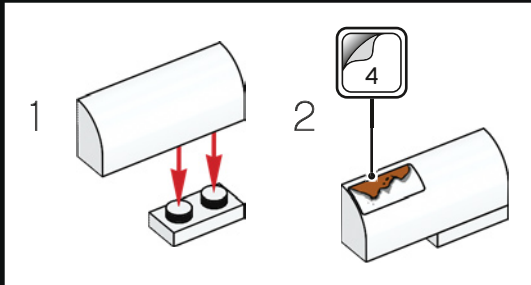

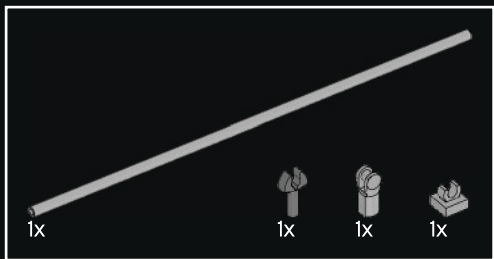

577

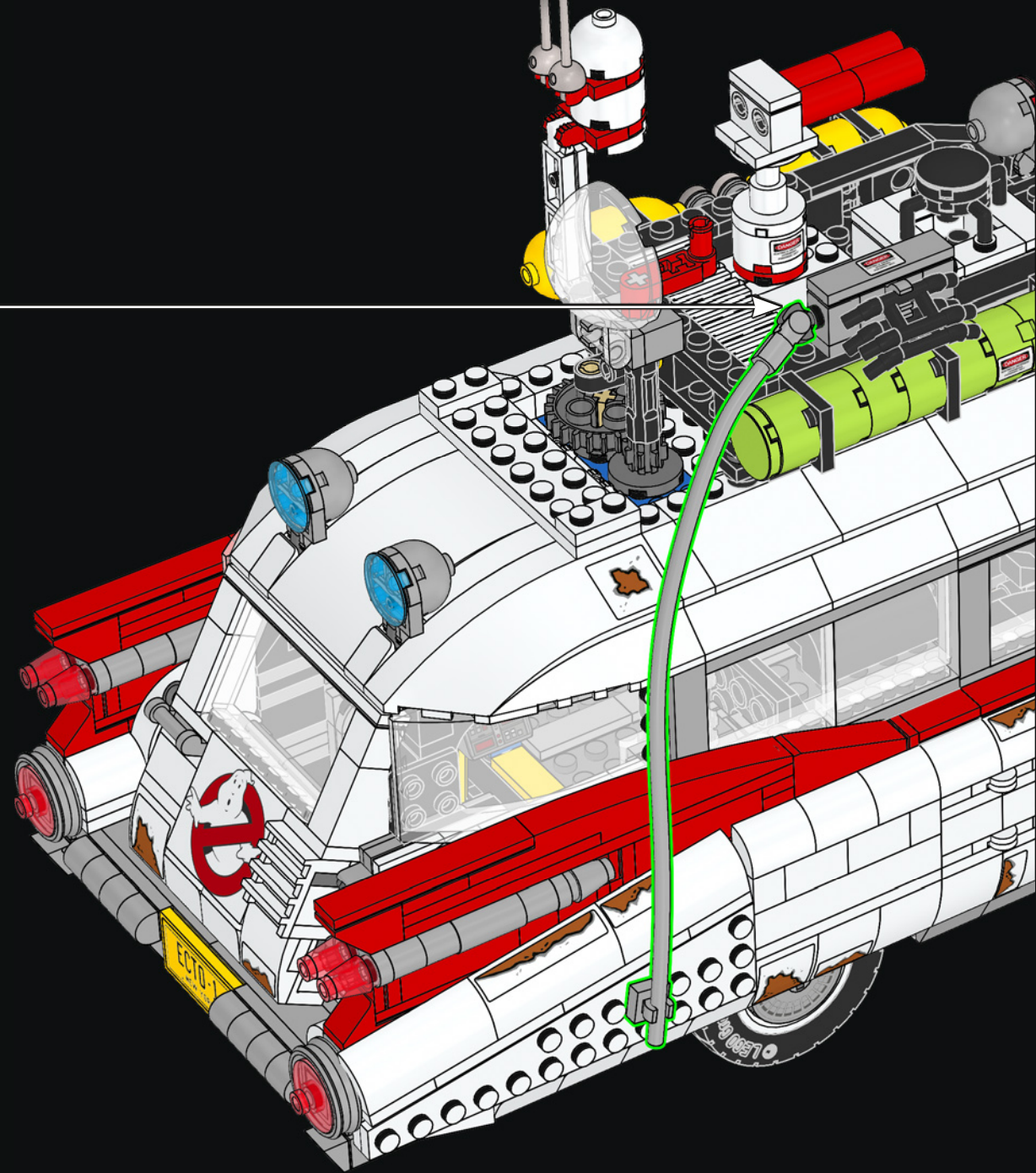
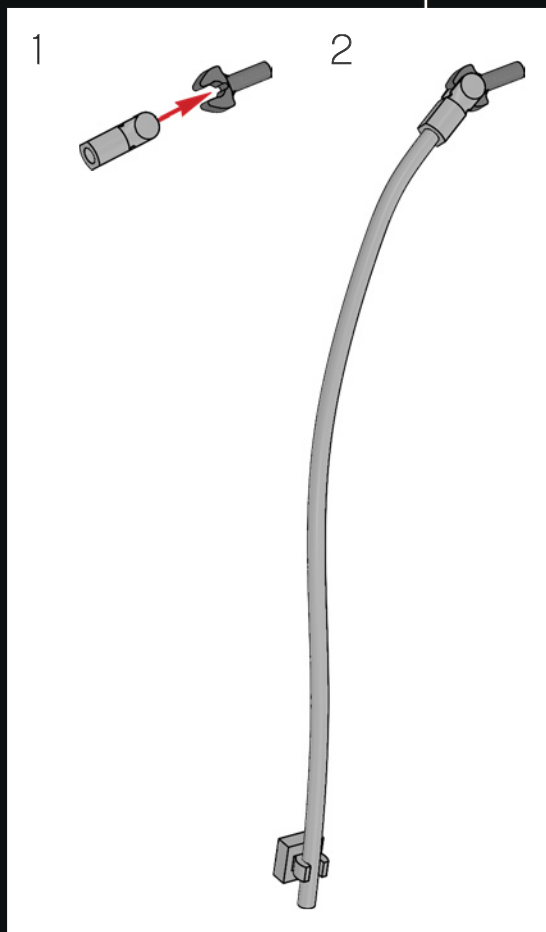

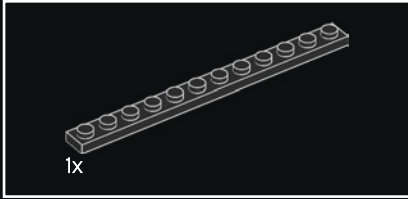
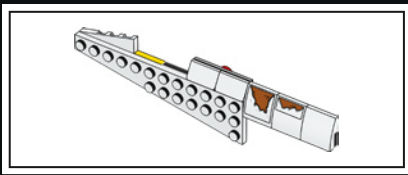

578

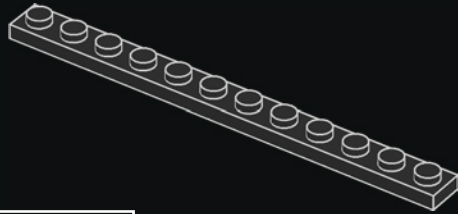

579

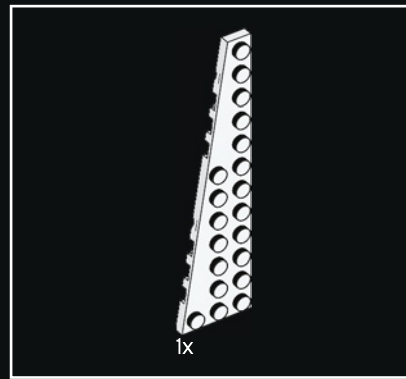
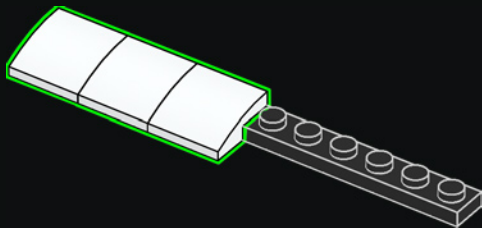

580

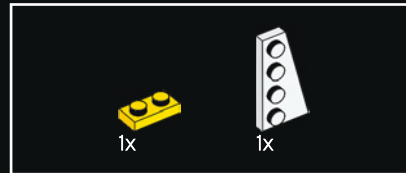
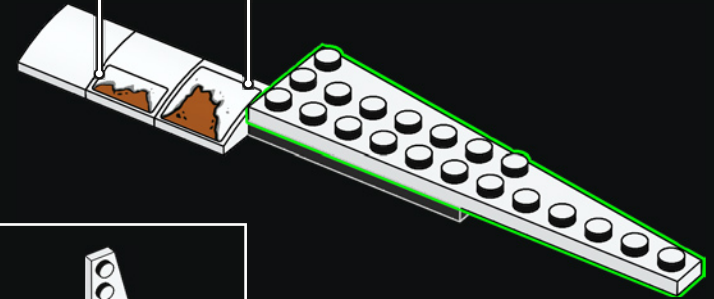

581

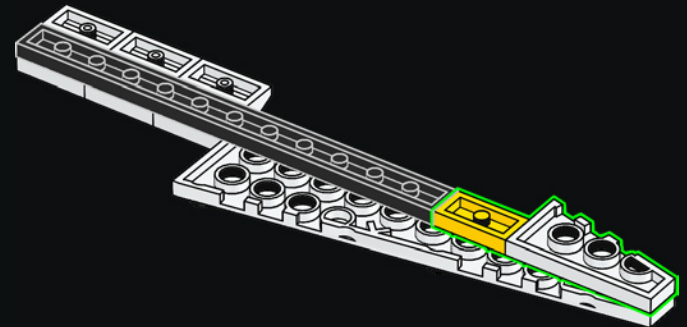

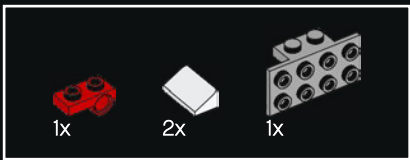

582

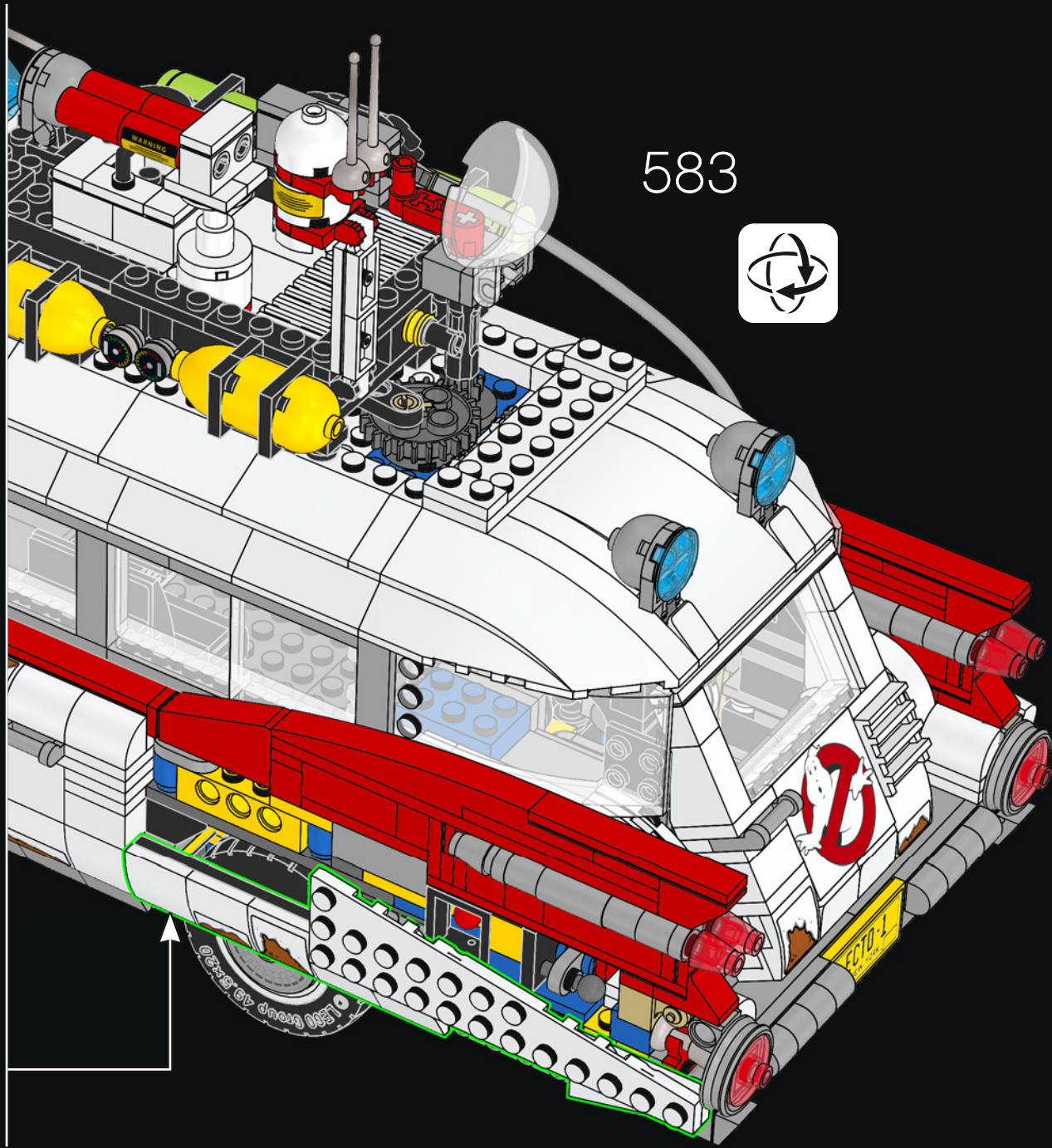
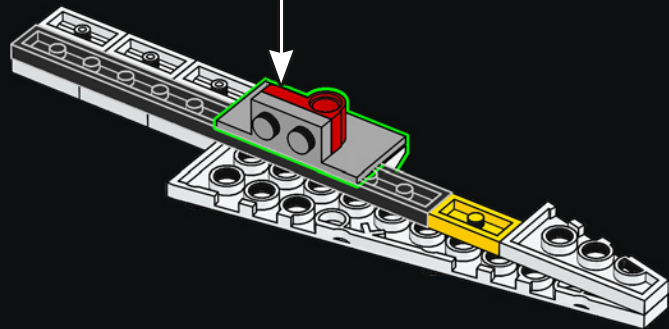
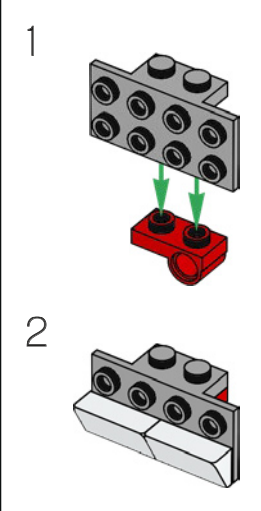

583





584

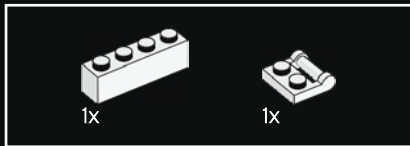
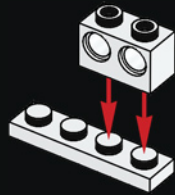

585

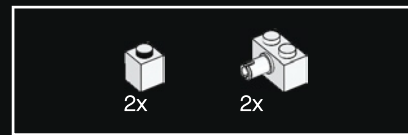
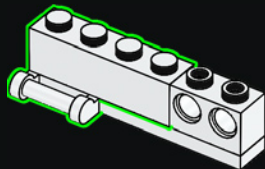

586

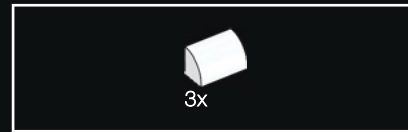
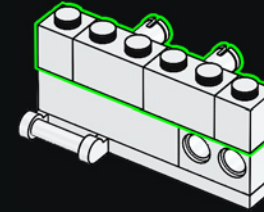

587

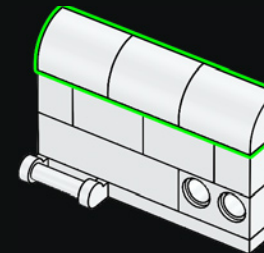

588

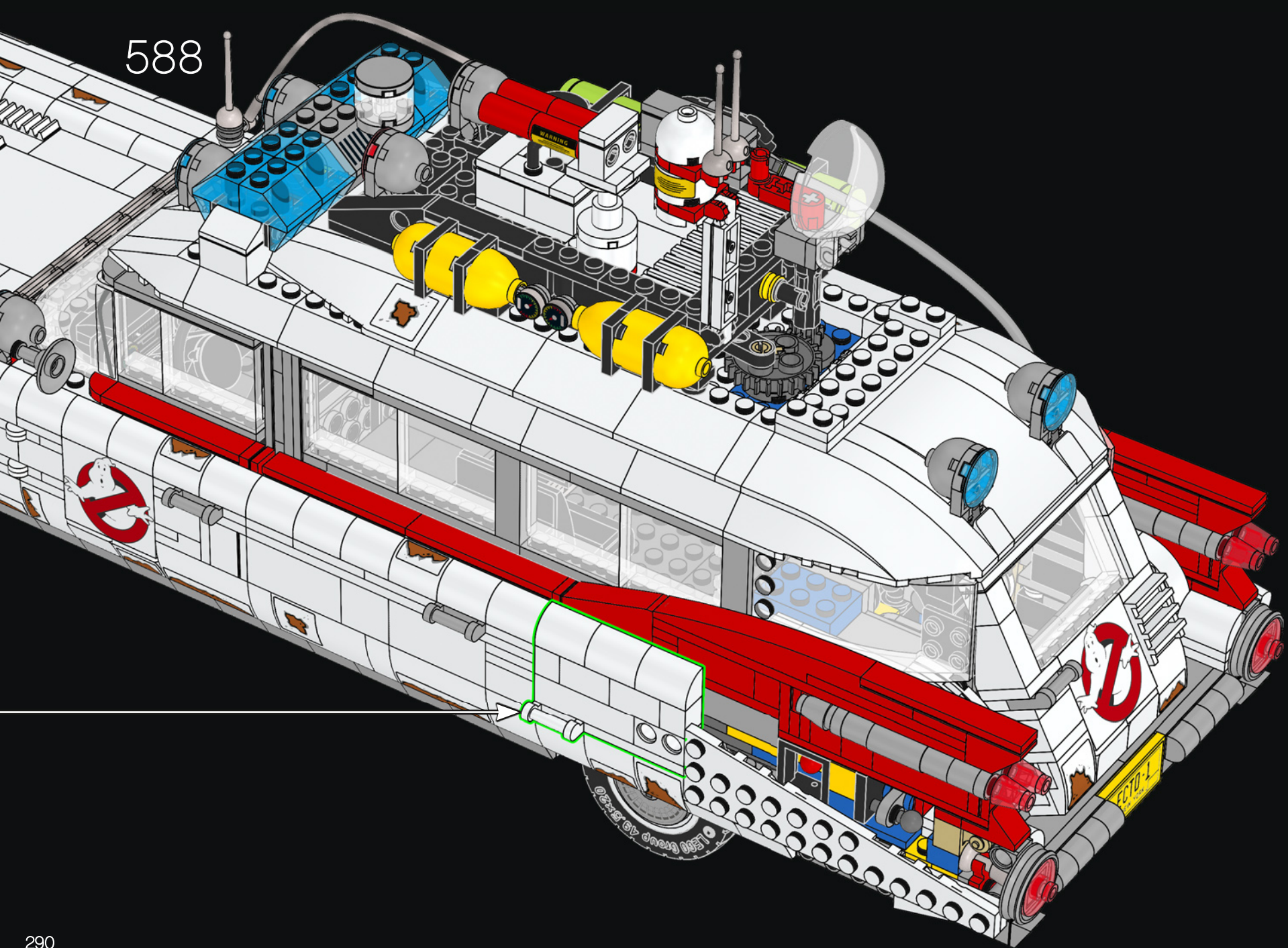

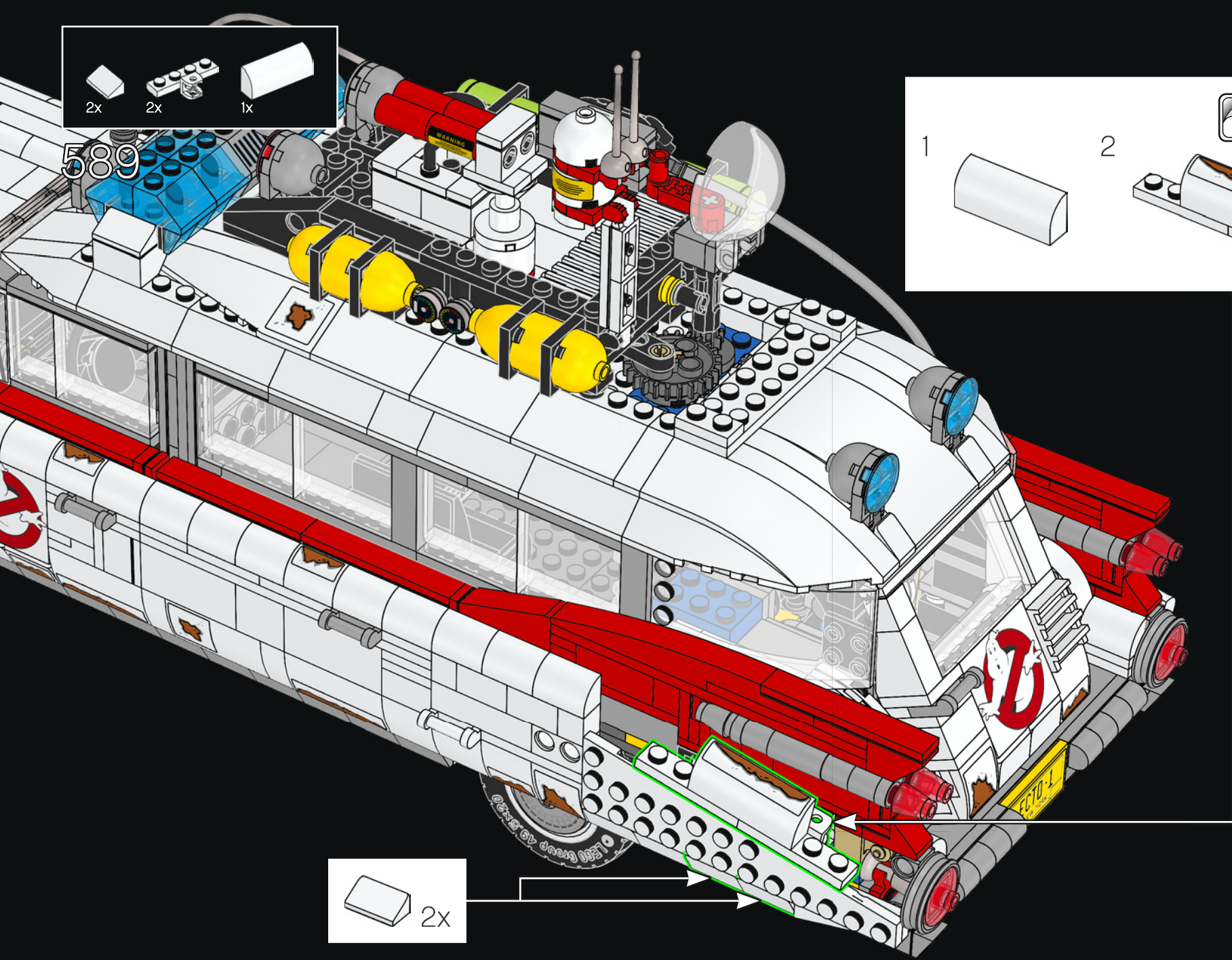

589

2x 2x 1x

1 2

1

2x

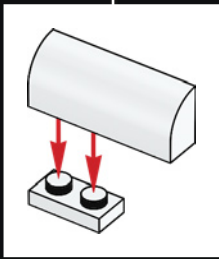
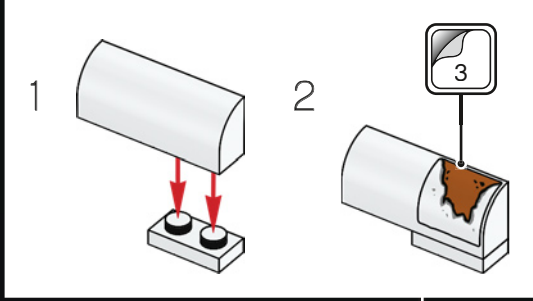
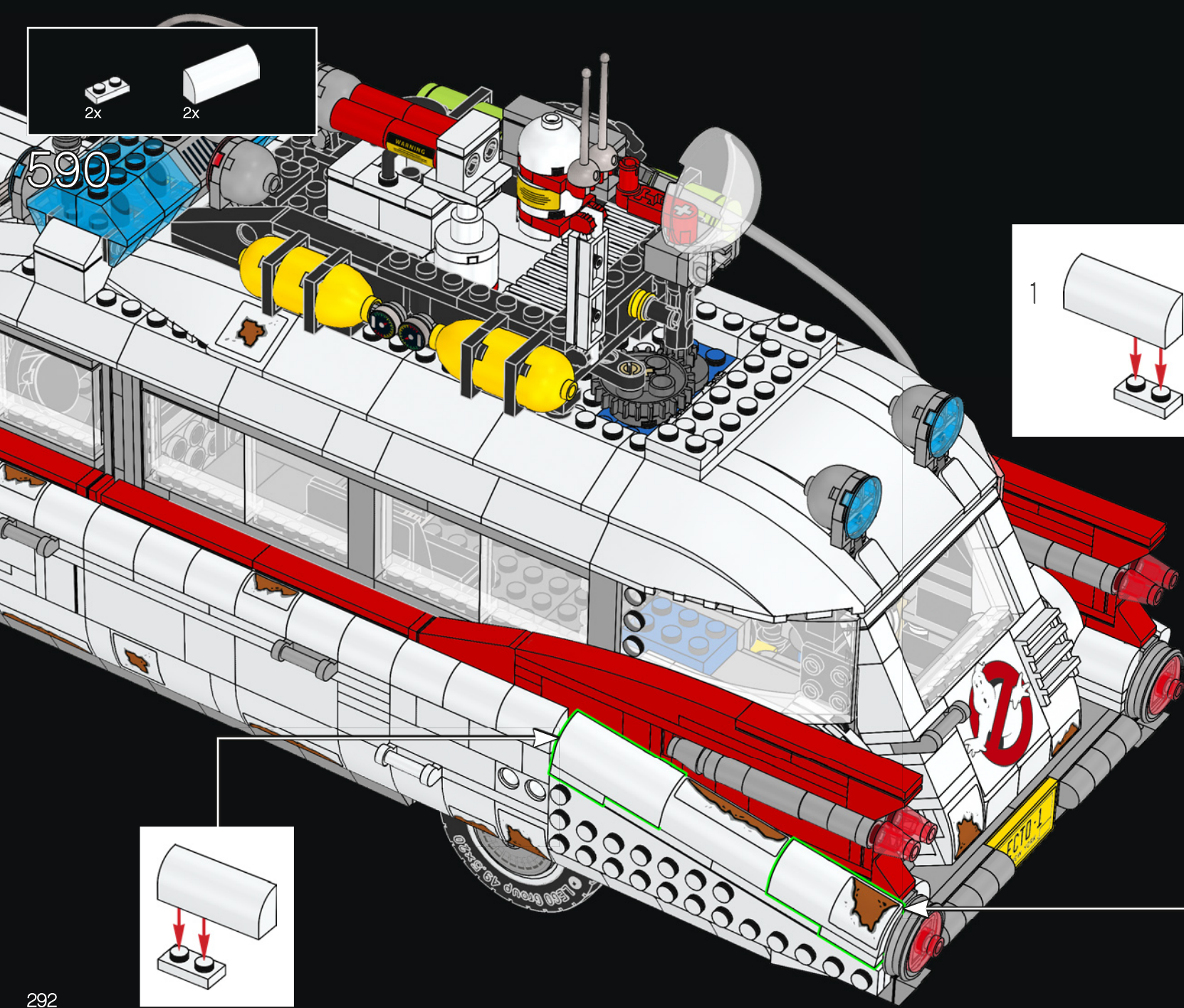

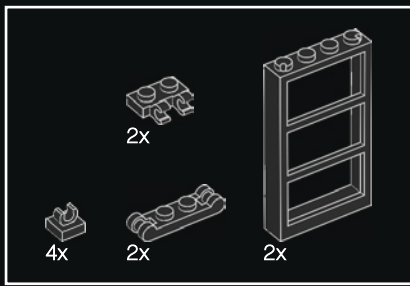

591

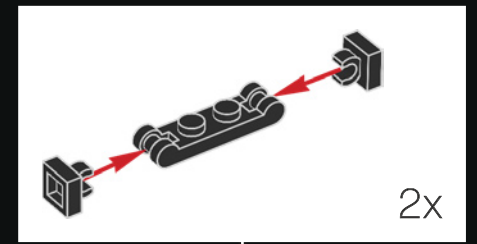
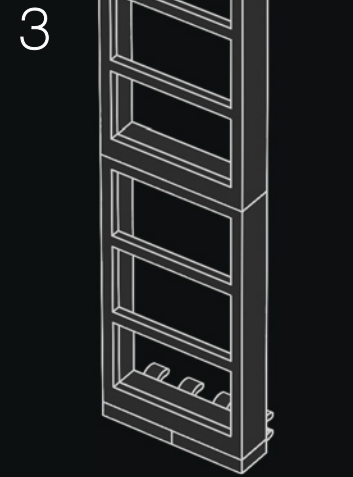
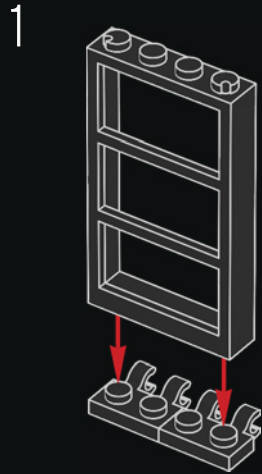

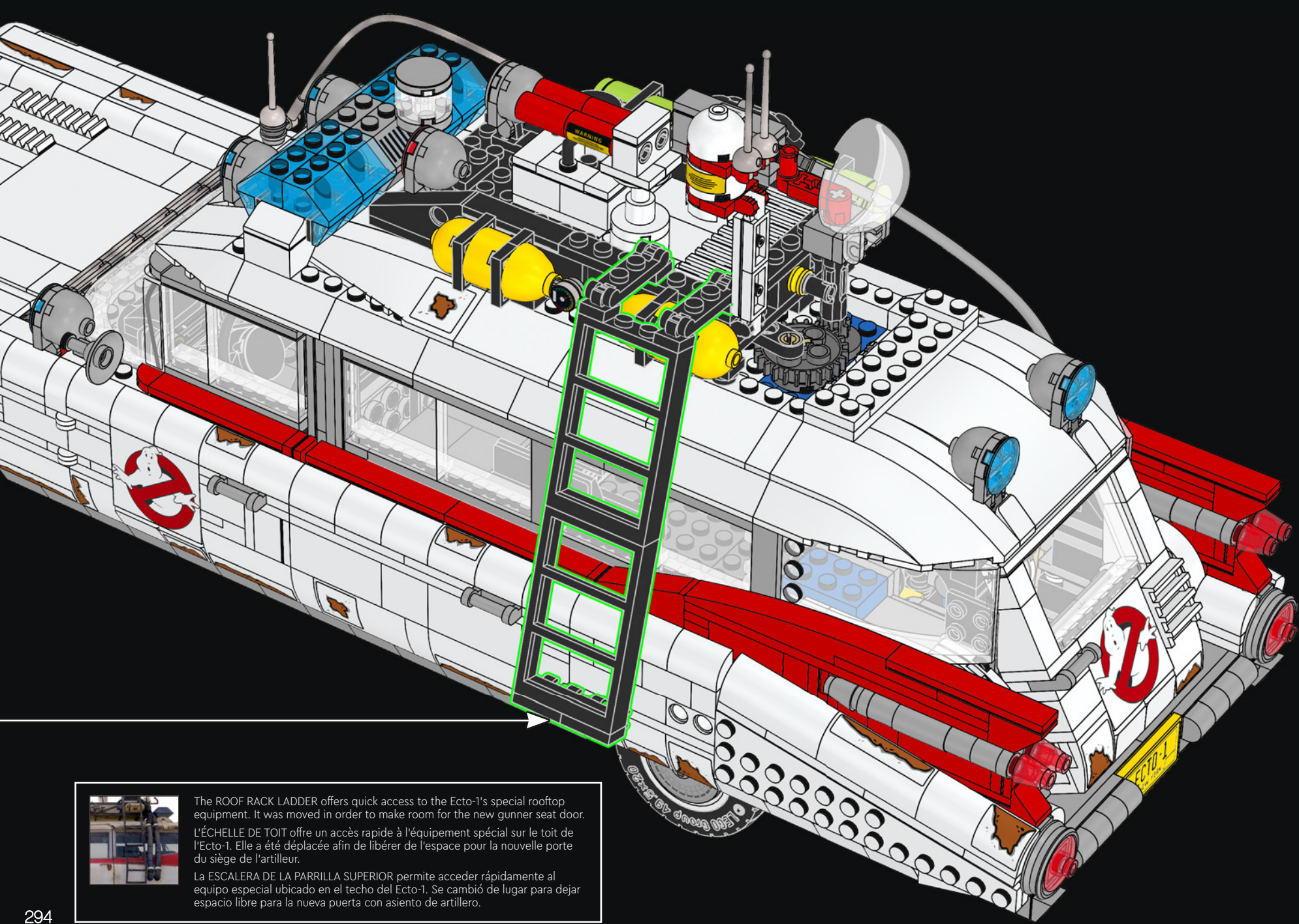

The ROOF RACK LADDER offers quick access to the Ecto-1's special rooftop equipment. It was moved in order to make room for the new gunner seat door.

L'ÉCHELLE DE TOIT offre un accès rapide à l'équipement spécial sur le toit de l'Ecto-1. Elle a été déplacée afin de libérer de l'espace pour la nouvelle porte du siège de l'artilleur.

La ESCALERA DE LA PARRILLA SUPERIOR permite acceder rápidamente al equipo especial ubicado en el techo del Ecto-1. Se cambió de lugar para dejar espacio libre para la nueva puerta con asiento de artillero.

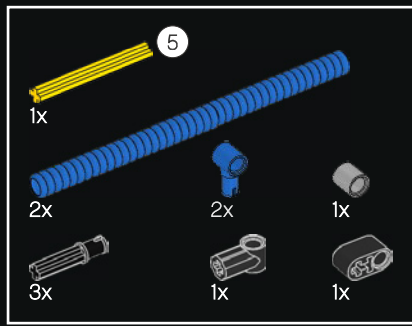

592

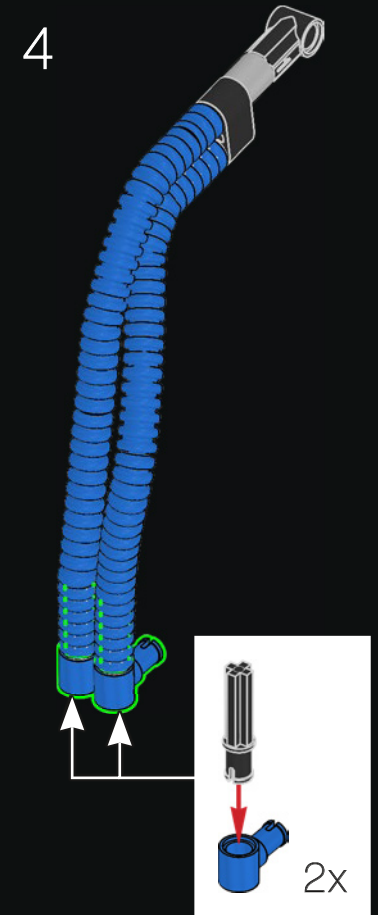
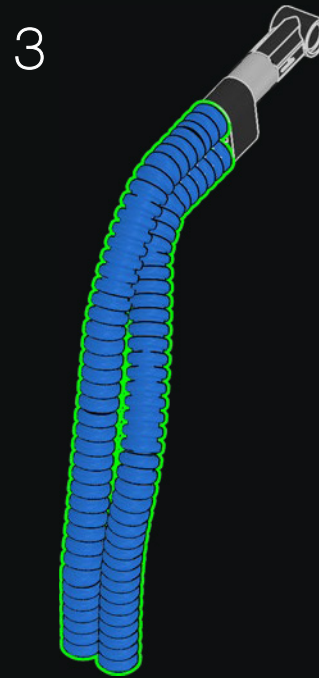
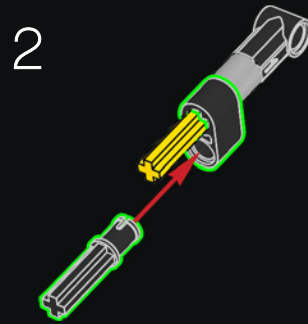
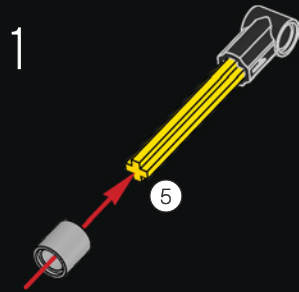

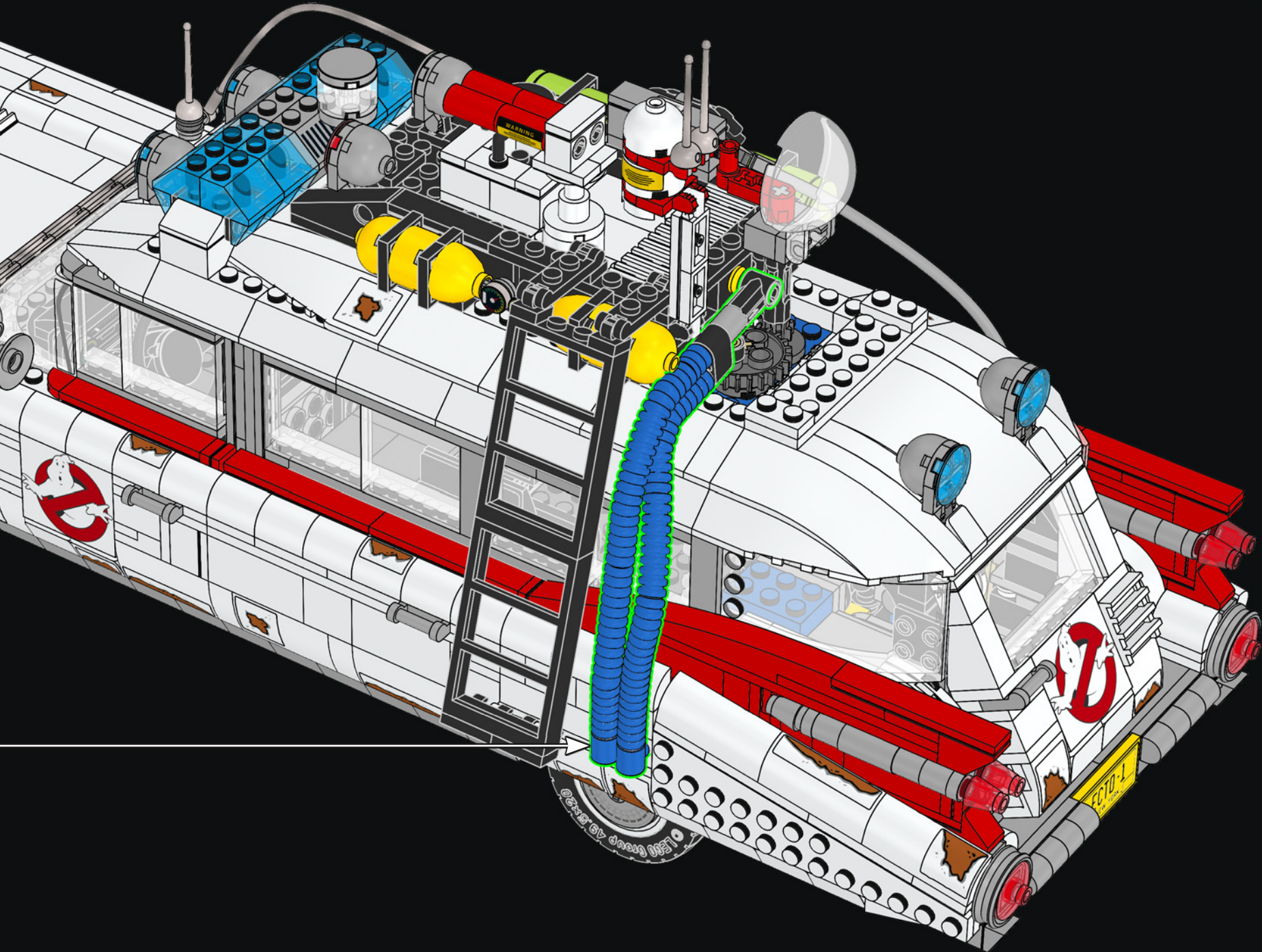

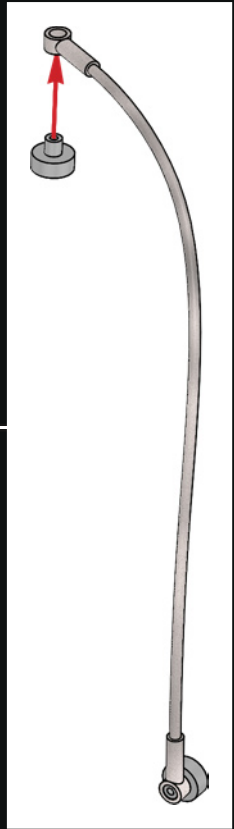
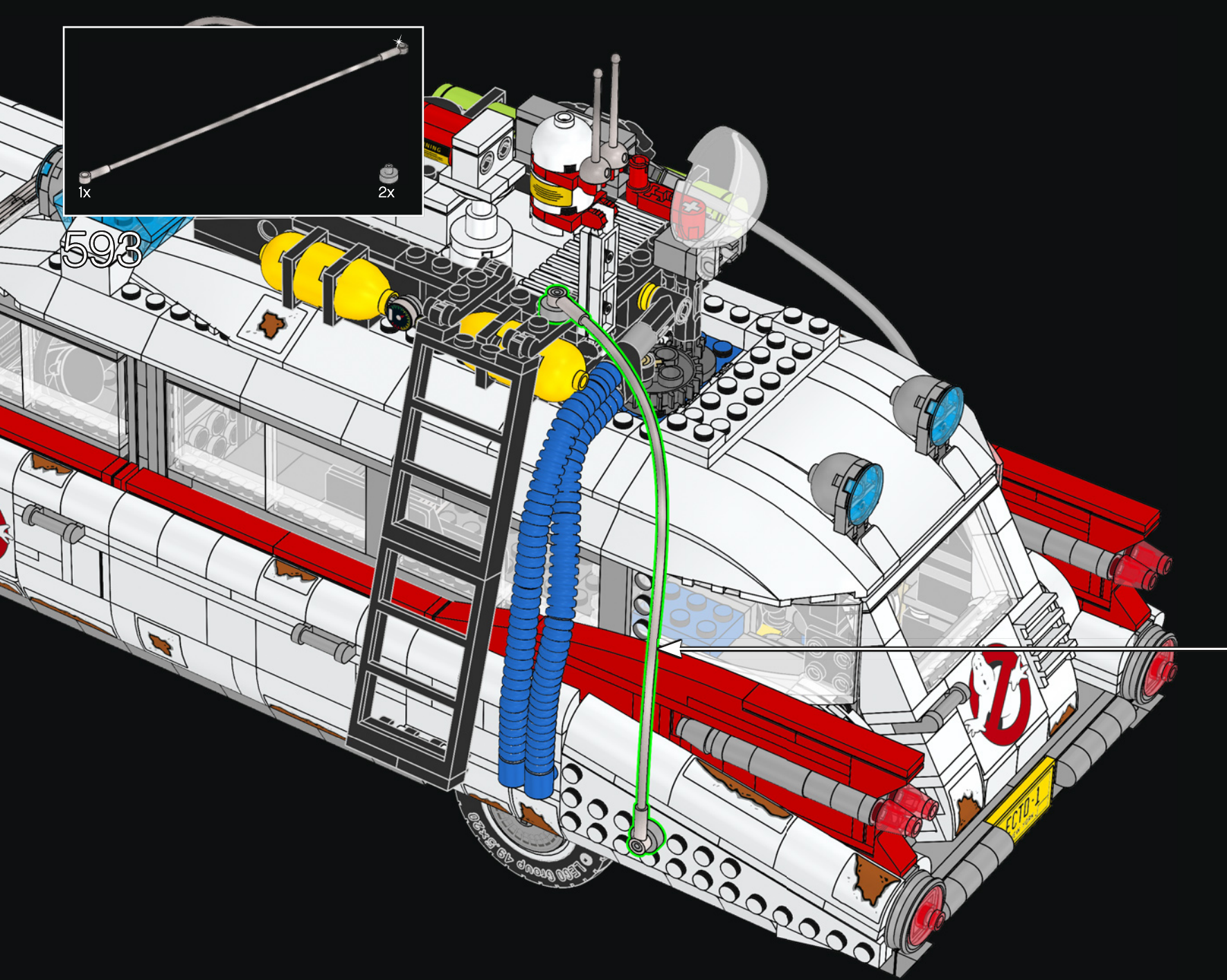

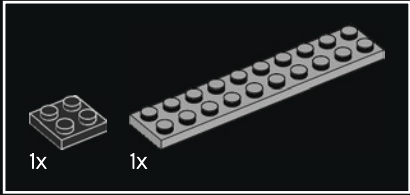
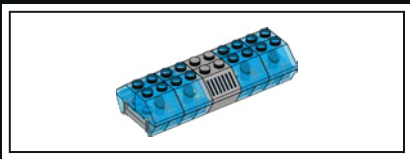

594

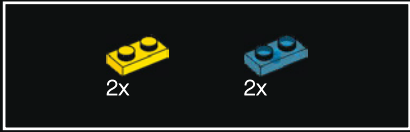
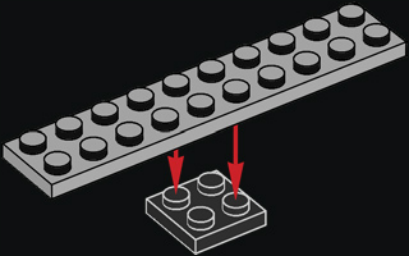

595

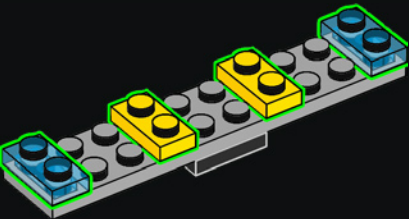

596

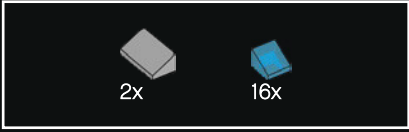
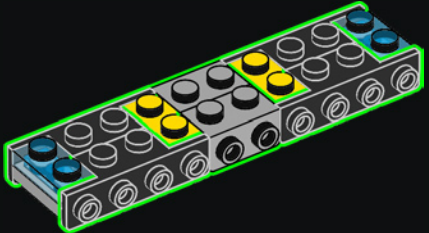

597

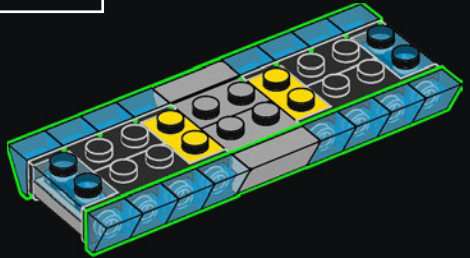

598

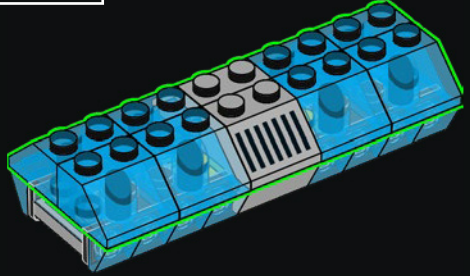

599

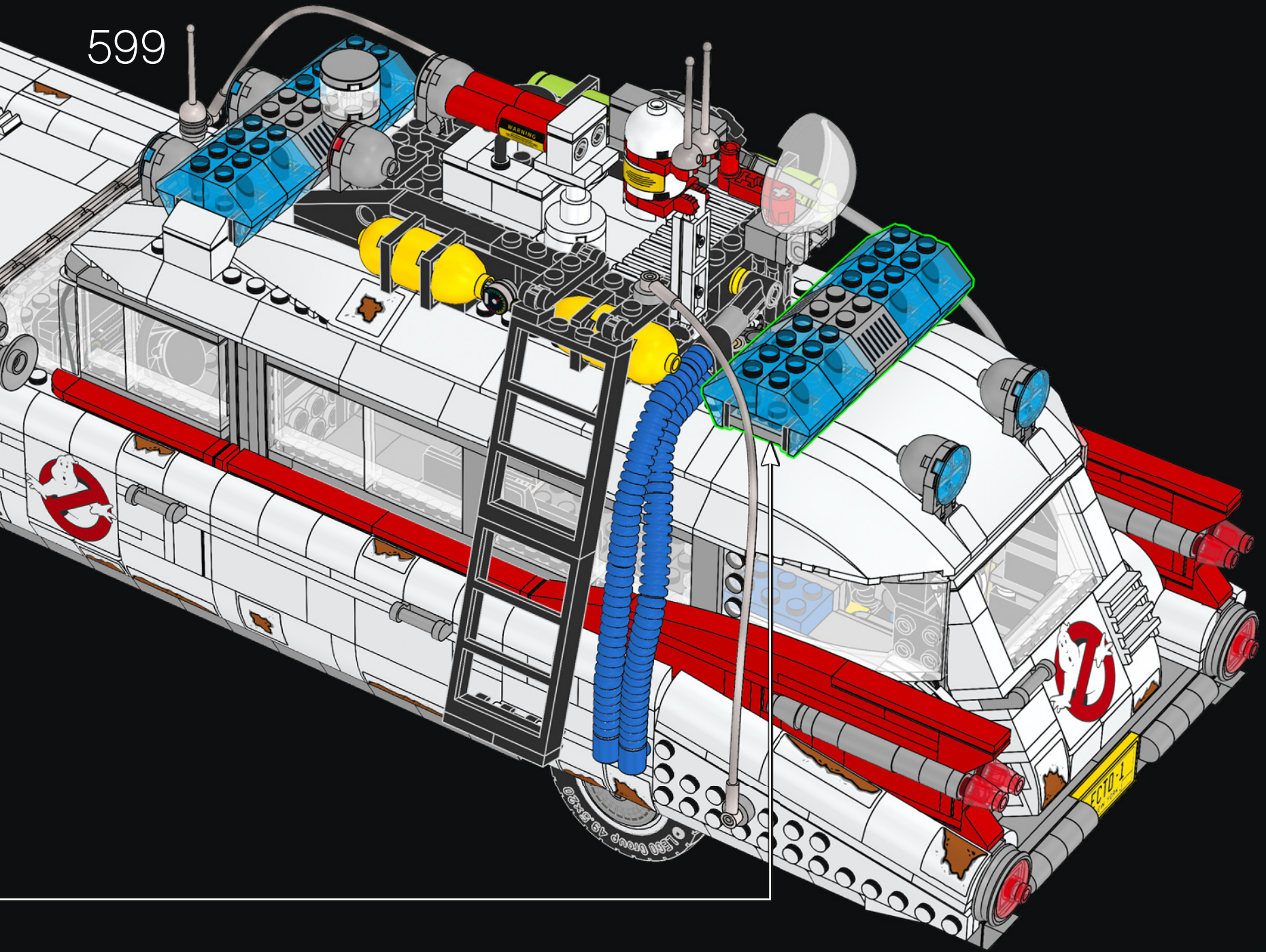

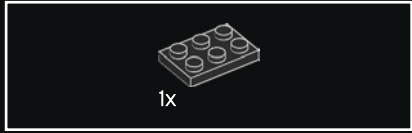

600

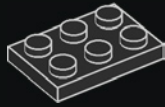

601

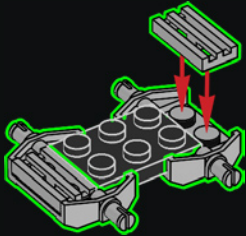

602

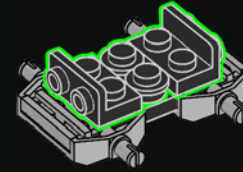

603

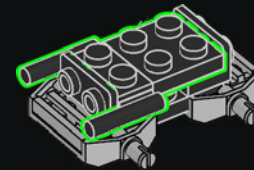



604

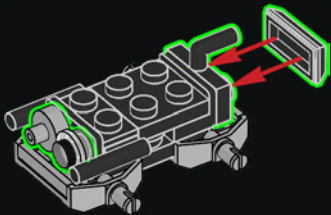

605

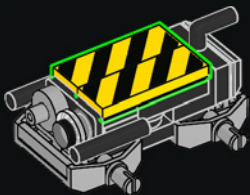

606

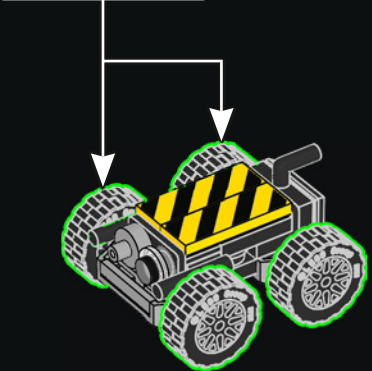
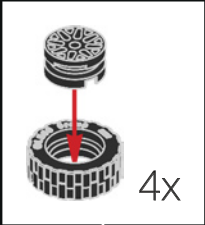

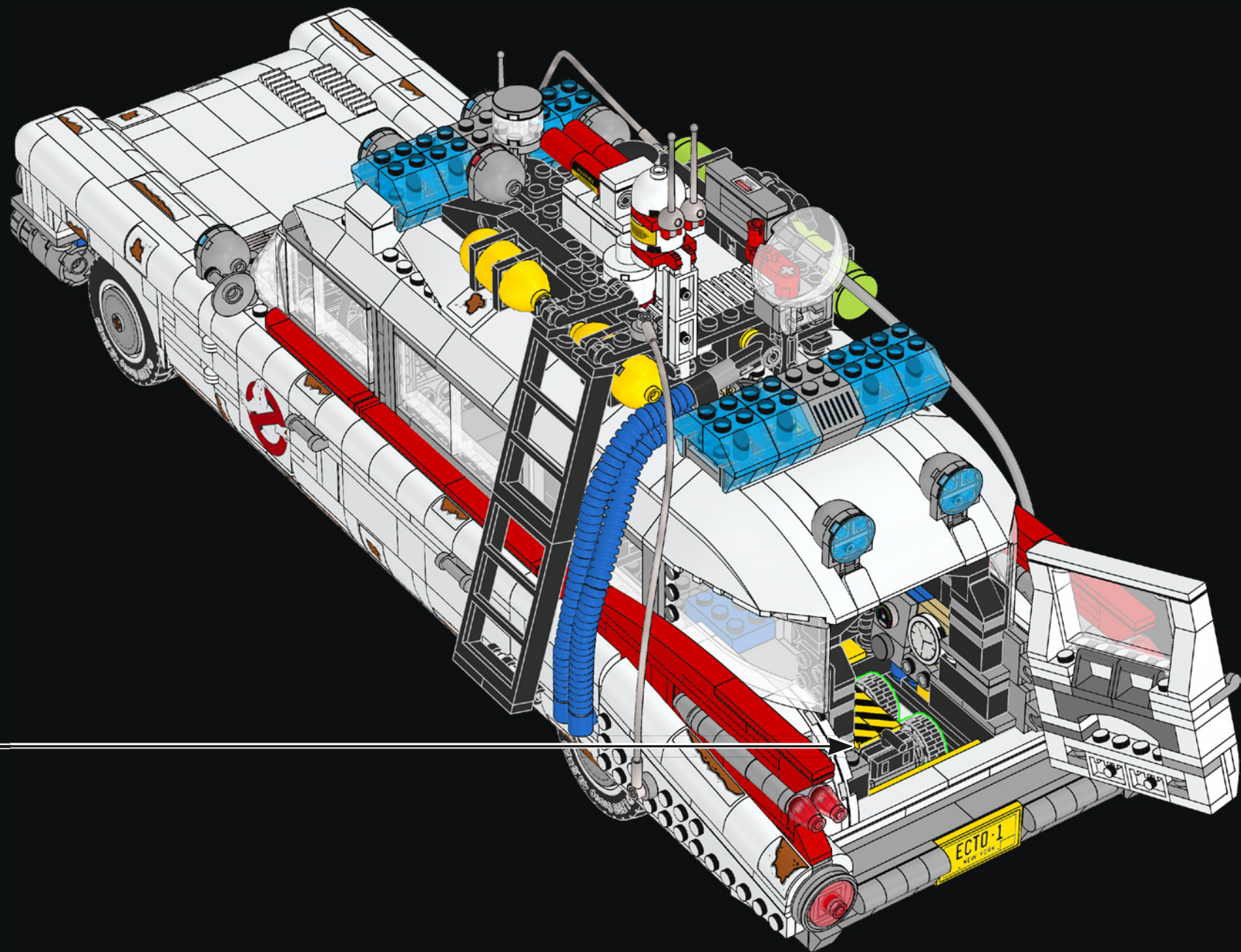

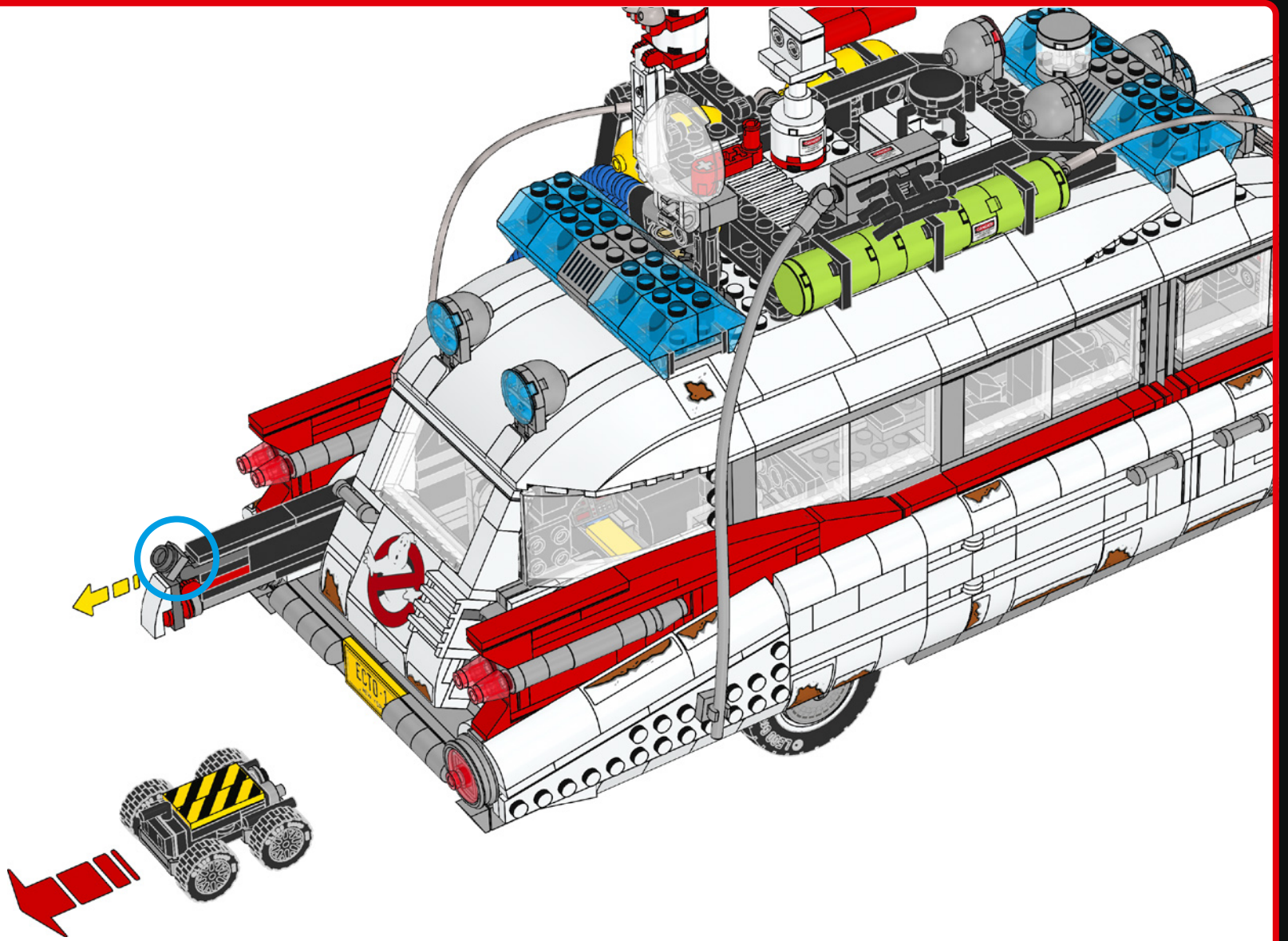



608

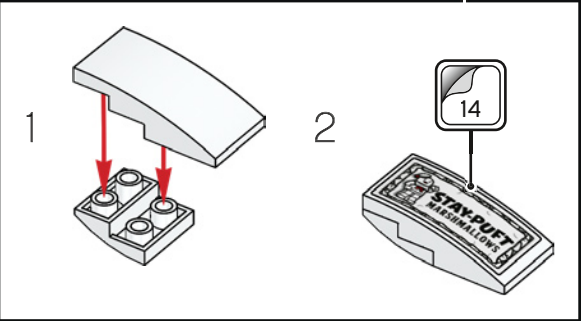
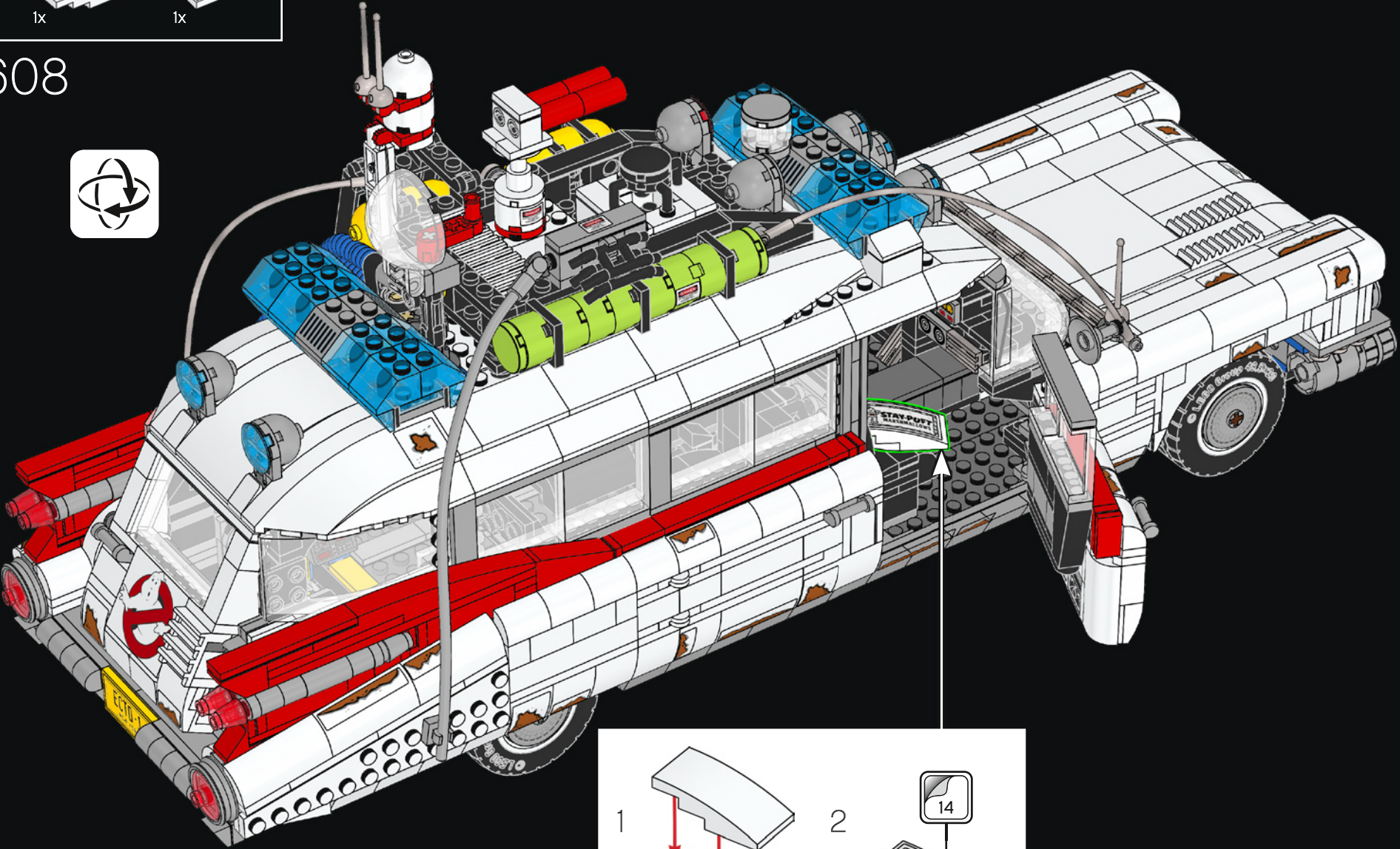

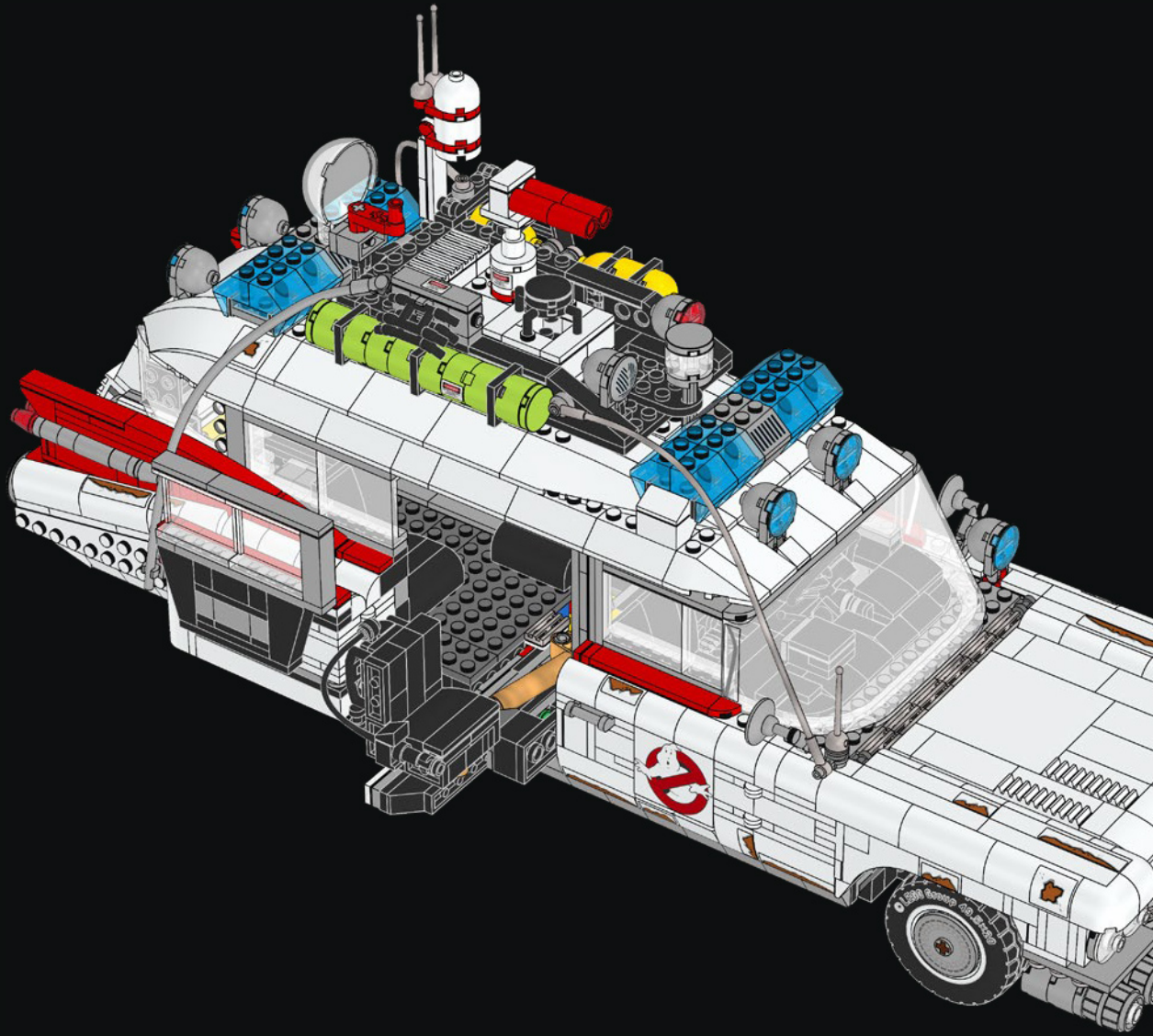
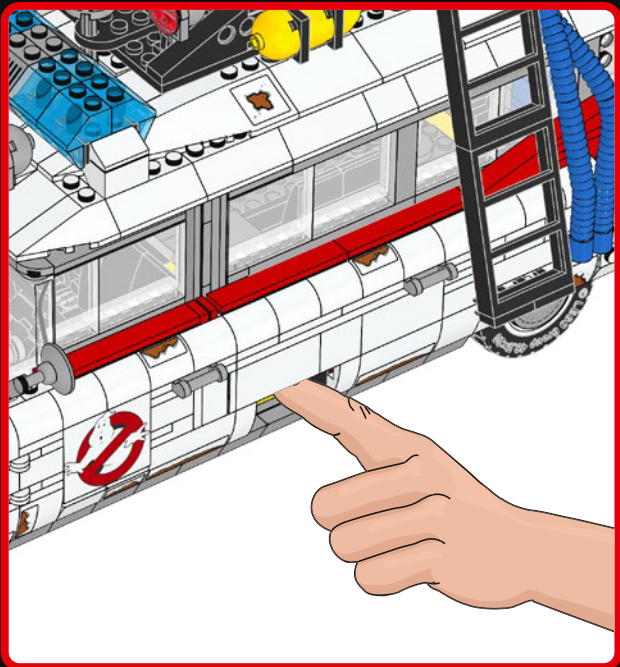
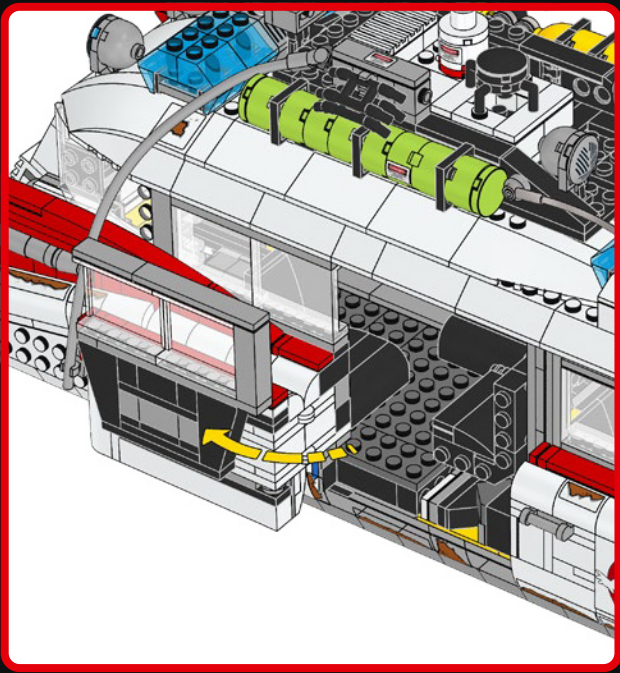

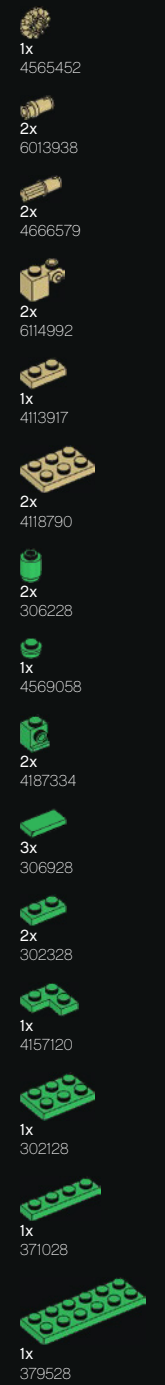

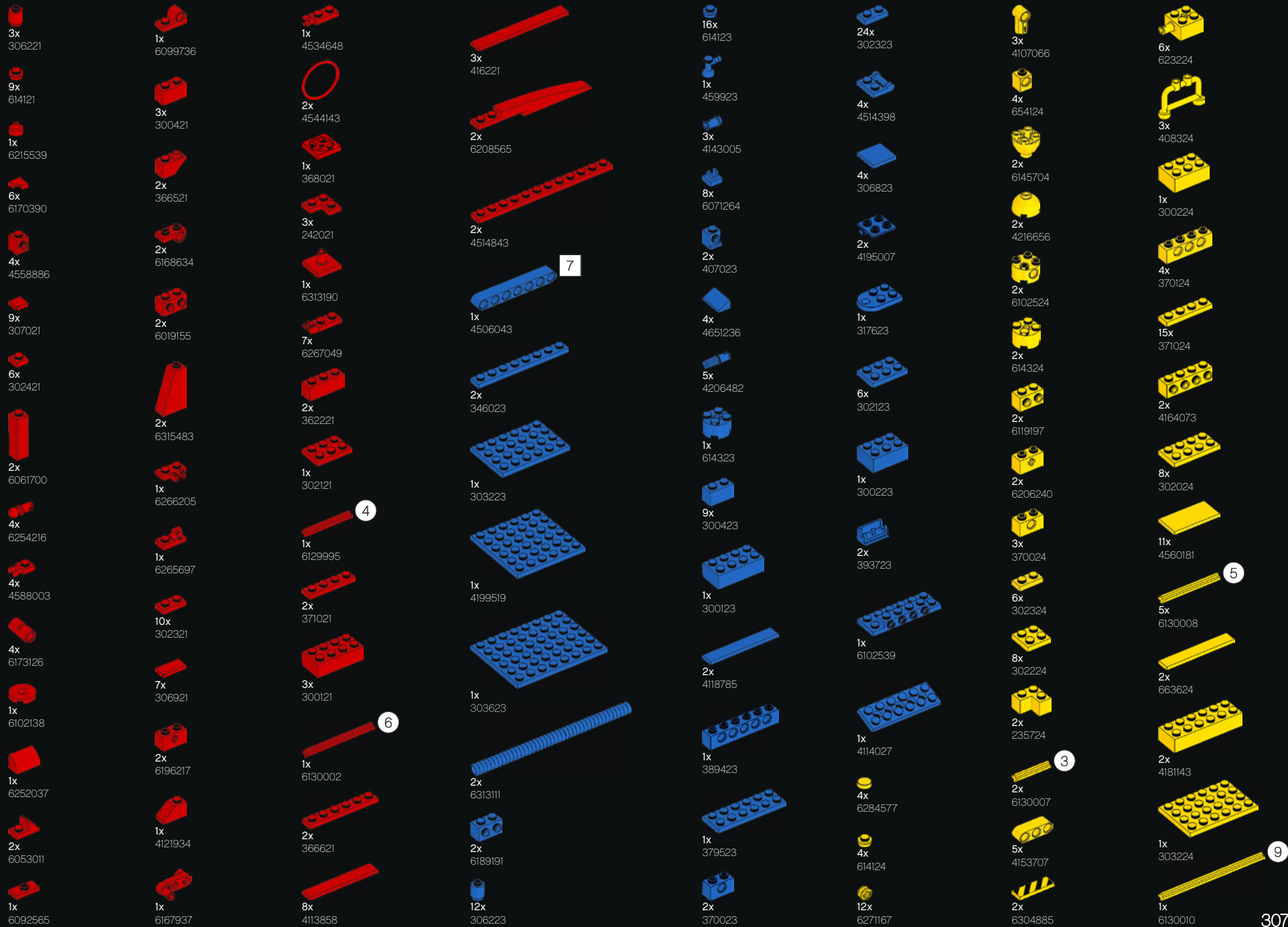

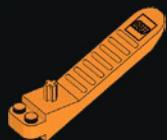

1x
6240515



18x
4514845

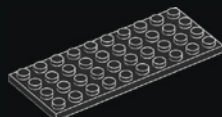

3x
303026



1x
6096303



1x
244526

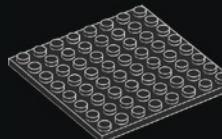

1x
416619



7x
370326

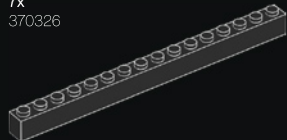

1x
246526



1x
73587



1x
4538456



1x
306226



2x
6186675



11x
614126



4x
362626



1x
6121485



1x
6273589



4x
4558954



3x
4504382



6x
302426



6x
6066102



4x
407026



3x
6234695



4x
4613162



4x
4177431

1x
6281993



5x
6210270



4x
6157554



1x
6284699



2x
4548180



1x
4278359



1x
6304888



5x
403226



2x
6070695



1x
6291069



1x
6122656



1x
6265091



2x
4512363



2x
6226706



1x
366526



1x
6268905



5x
6178922



1x
6114987



1x
6192309



1x
6156991



4x
4617848



36x
302326



4x
4636202



3x
6069000



3x
6092585



6x
6184784



3x
370026



3x
6266244



4x
300426



2x
366526



2x
4521439



4x
4144024



1x
6117973



7x
6020193



1x
4584274



8x
6000650



5x
6310268



1x
4535739



3x
6267131



1x
306826



8x
6053077



2x
6192346



7x
302226



3x
6061032



4x
366026



6x
6191630



3x
300326



2x
6133722



1x
242026



6x
235726



7x
6089119



1x
6267045



7x
6052126



1x
6313508



2x
6276951



1x
4142822



4x
6286381



3x
6199908



2x
6078610



13x
362226



16x
362326



2x
6265712



1x
428626



6x
428726



6x
4581280



1x
317626



8x
6168620



3x
6099483



2x
6162892



3x
302126



1x
383926



2x
300226



1x
4107136



19x
243126



6x
6039869



8x
301026



3x
4162443



2x
6037746



1x
370126



14x
371026



2x
6271169



2x
303726



1x
4515350



2x
4227684



1x
4159550



2x
6280168



1x
6299938



2x
6194233



16x
302026



5x
6174252



3x
4587844



8x
4647286



4x
300126



1x
6092878



2x
4629921



13x
366626



5x
300926



2x
6311889



9x
4243819



2x
6208787



1x
6271573



5x
4653049



1x
4495935



4x
6055626



1x
370226



3x
300826



12x
346026



1x
416226



2x
303226



2x
303426



1x
373826



1x
6155125

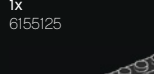

4x
447726

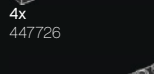

2x
273026



6x
303526



3x
4617860

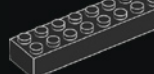

1x
383226



1x
303626



1x
4188143

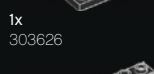

5x
4188143



5x
4188143



9x
6240030



1x
6168665



2x
6254254



1x
6273152



4x
6245306



2x
6211814



10x
6245269



1x
6244781



1x
6254638



2x
6311888



1x
6299933



4x
4544720



1x
6254635



2x
6245303



32x
6245256



5x
6171732



4x
6240215



16x
6244887



2x
6251292



2x
6092766



8x
4527943



2x
6135494



3x
6152107



1x
4211412



4x
4529241



8x
6284071



4x
6258831



17x
4211525



1x
6194808



3x
6275844



5x
6183784



2x
4211503



1x
4211483



7x
4211415



14x
6262085



4x
4521921



2x
6061702



8x
4211389



2x
6225242



2x
6248078



1x
4211758



13x
6248890



2x
6311384



1x
4211794



4x
6173127



34x
4568637



1x
4211475



4x
6278993



2x
6052200



7x
4211637



3x
4211807



1x
4540203



2x
4211526



6x
6183782



3x
6123815



2x
6313114



3x
4211388



1x
4227776



19x
4211398



2x
4211414



1x
6206249



2x
6225230



7x
6266209



2x
4211350



3x
6066097



2x
6285778



2x
4654046

2x
6123815

2x
6123809



2x
6043656

2x
6123809

4x
6117967

7

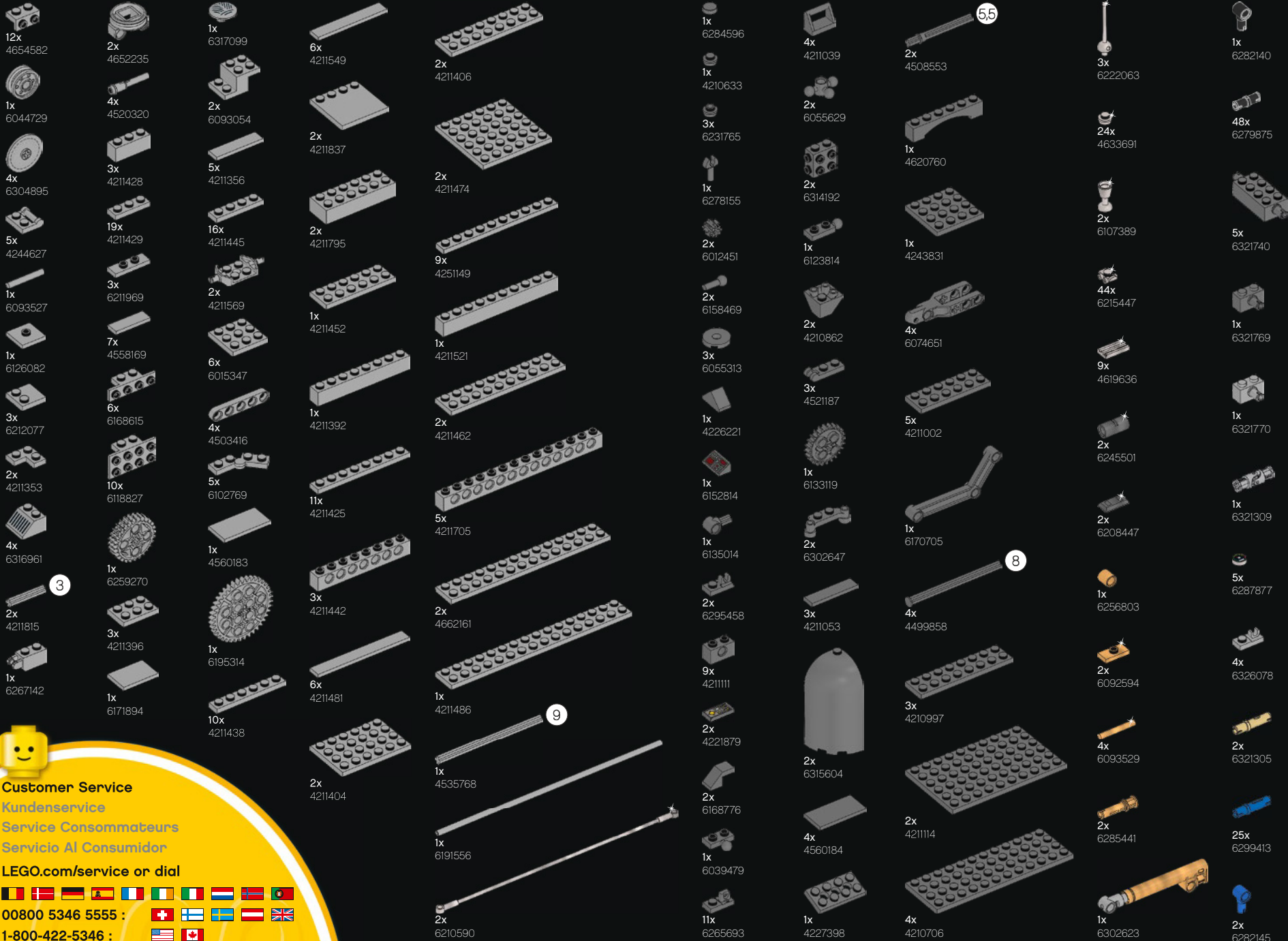
3

Customer Service
Kundenservice
Service Consommateurs
Servicio Al Consumidor
LEGO.com/service or dial



00800 5346 5555 :

1-800-422-5346 :



FEEDBACK AND WIN



FEEDBACK AND WIN

Your feedback will help shape the future development of this product series.

Please visit:

FEEDBACK UND GEWINNEN

Dein Feedback trägt zur Weiterentwicklung dieser Produktreihe bei.

Geh auf:

COMMENTEZ ET GAGNEZ

Vos commentaires nous aideront à concevoir les futurs produits de cette gamme.

Rendez-vous sur :

COMENTA Y GANA

Tu opinión nos ayudará a dar forma al desarrollo de esta serie de productos en el futuro.

Visita:

反馈有奖

您的反馈将有助于我们在今后改进本系列产品。

请访问：

[LEGO.com/productfeedback](https://www.lego.com/productfeedback)

By completing, you will automatically enter a drawing to win a LEGO® set.

Terms & Conditions apply.

Durch Ausfüllen nimmst du automatisch an der Verlosung eines LEGO® Preises teil.

Es gelten die Teilnahmebedingungen.

En envoyant vos commentaires, vous serez automatiquement inscrit(e) à un tirage au sort qui vous permettra de remporter un prix LEGO®.

Offre soumise à conditions.

Al contestar, participarás automáticamente en el sorteo y podrás ganar un set LEGO®.

Sujeto a Términos y Condiciones.

完成我们的反馈调查，即可自动进入抽奖环节，赢取乐高®套装。

适用《条款和条件》。



OFFICIAL
LICENSED PRODUCT

6440747