

2

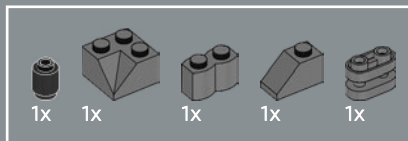

3

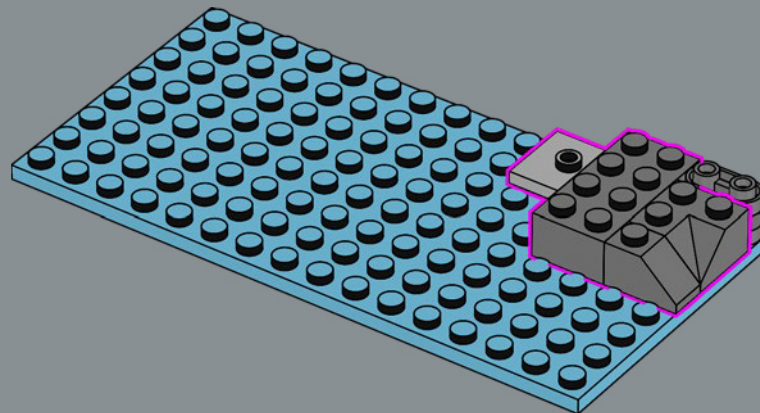

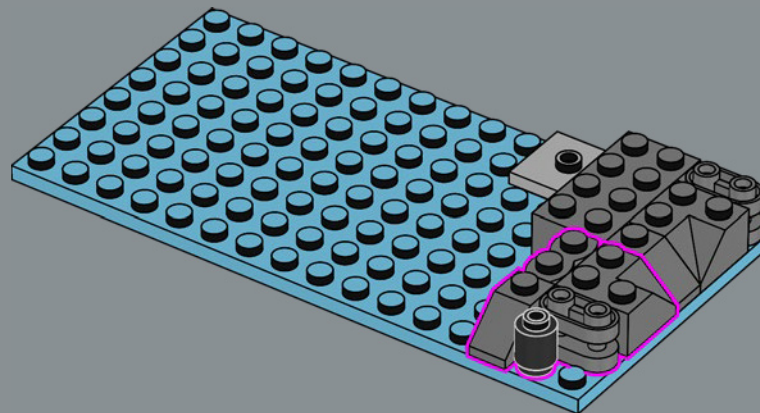
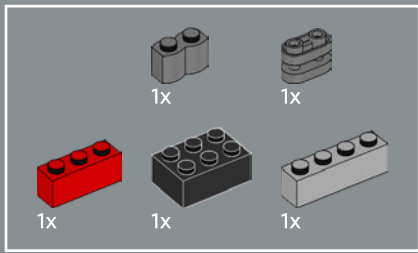

4

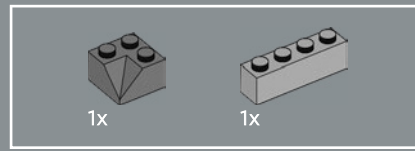
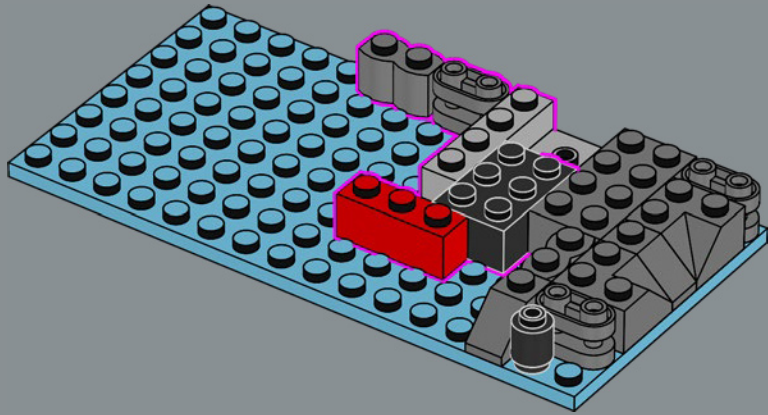

5

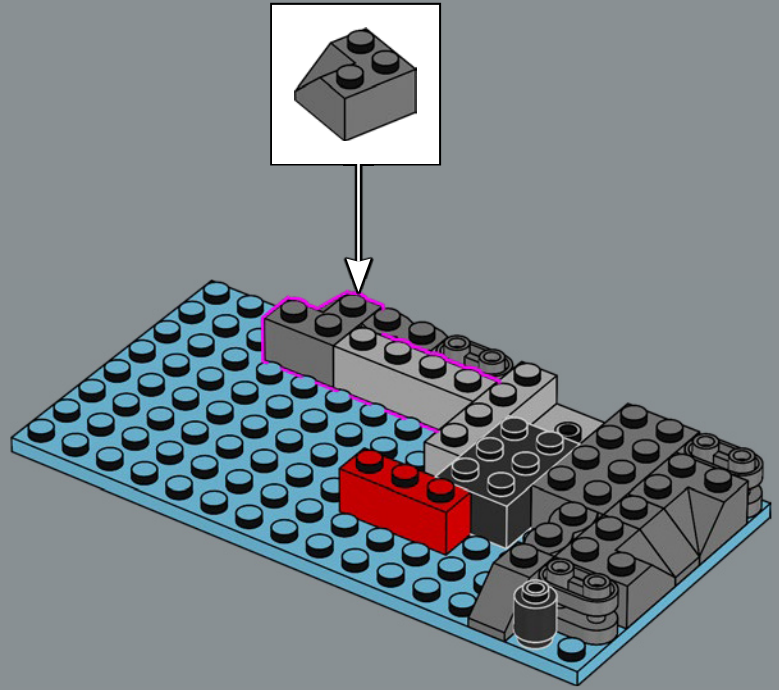

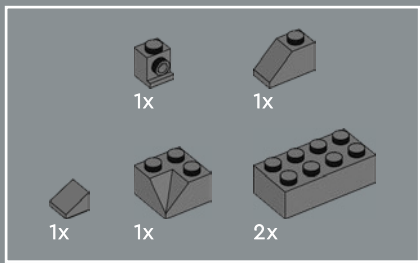

6

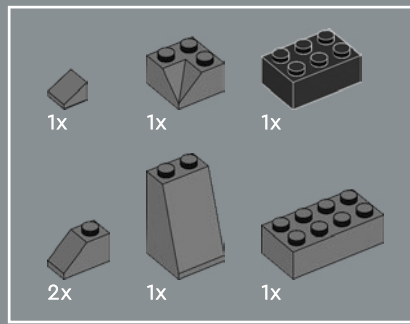
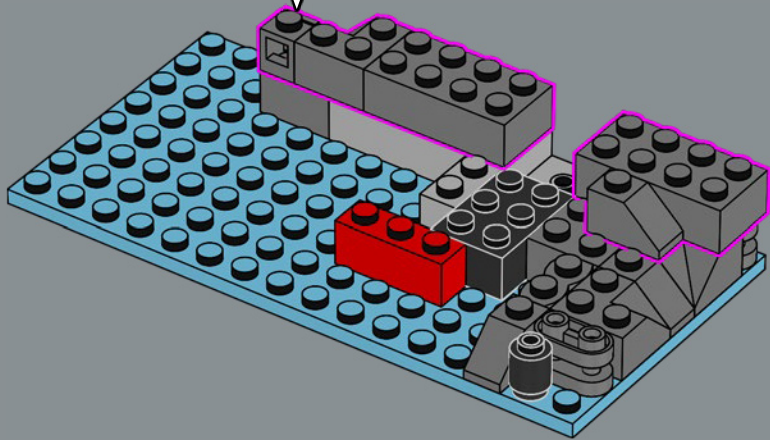
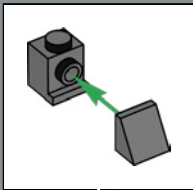

7

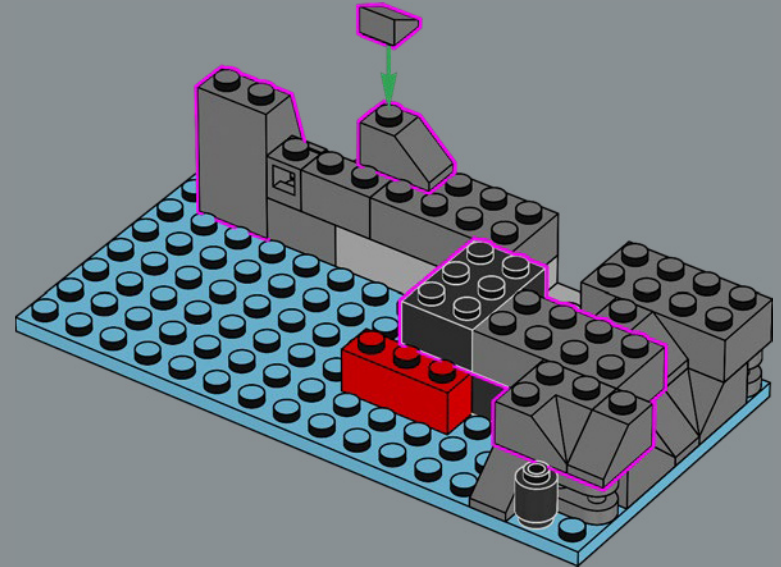

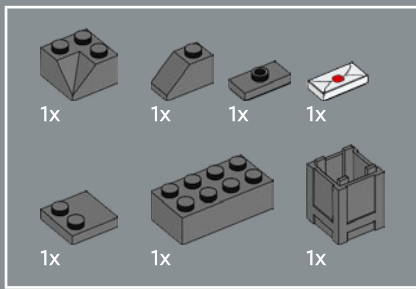

8

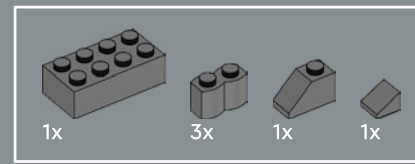
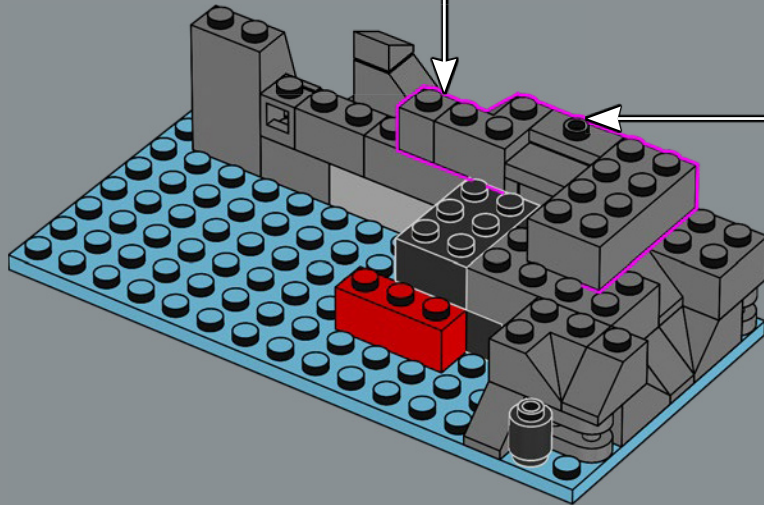
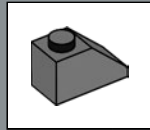
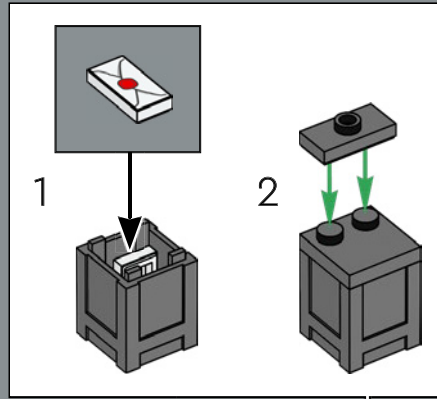

9

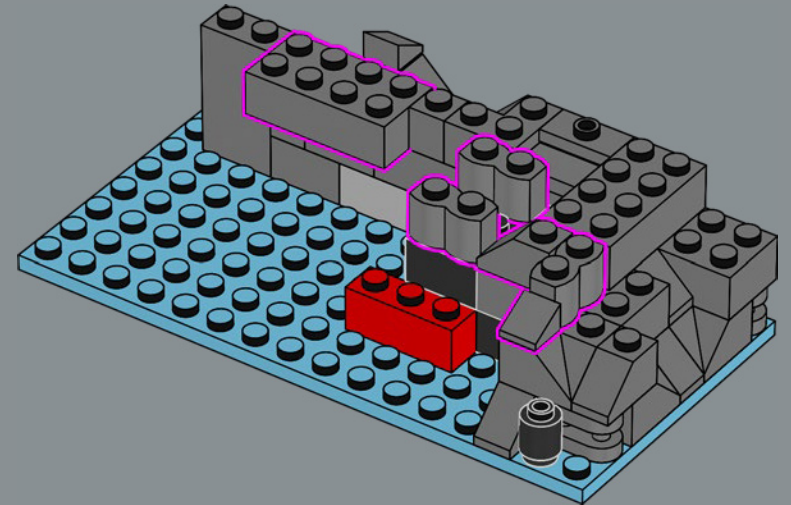

¿Una carta oculta? ¿Quién será el remitente?
¿Quién resolverá este misterio?

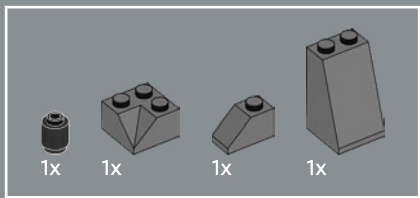

10

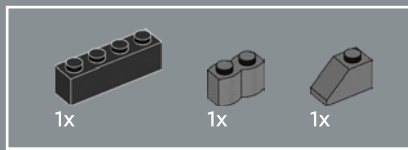
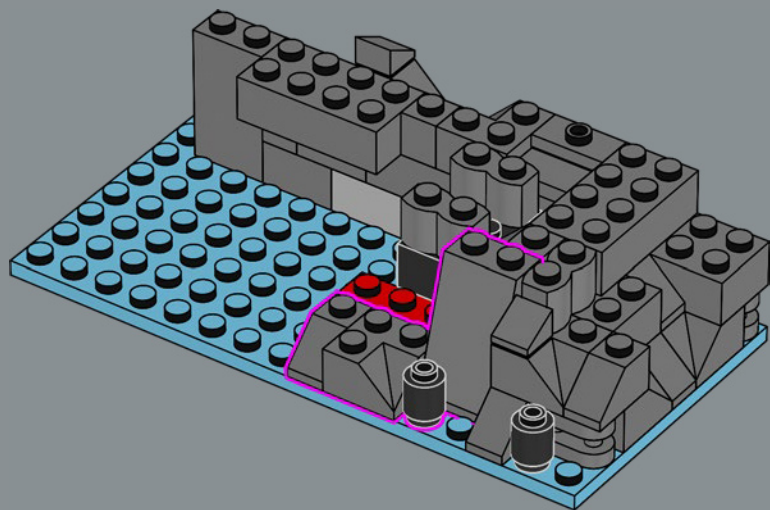

11

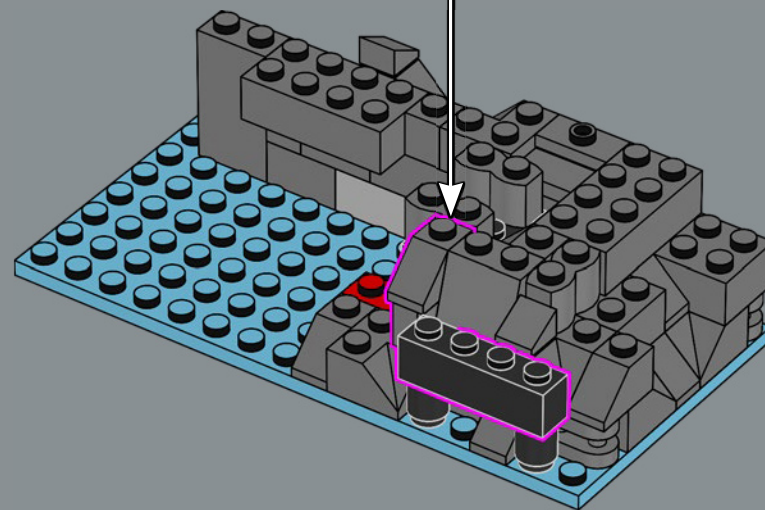
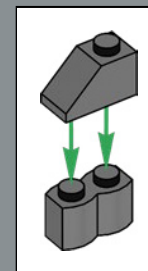

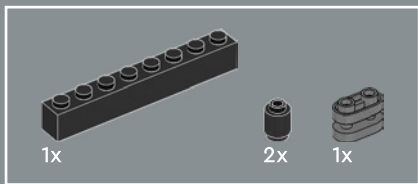

12

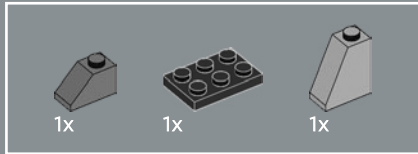
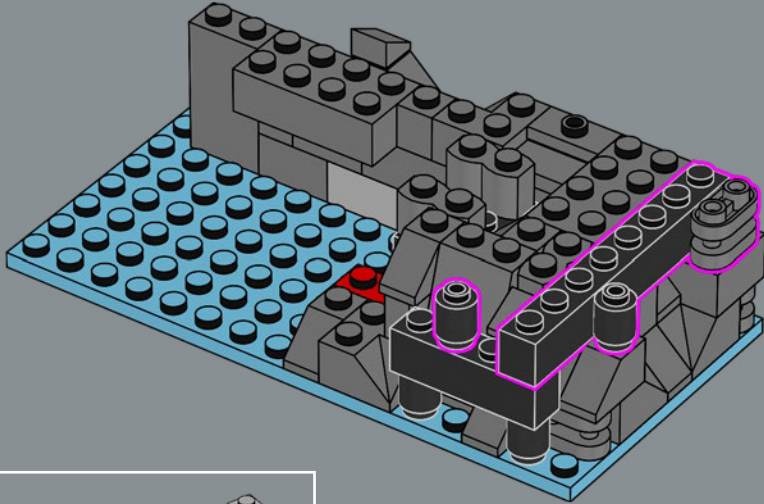

13

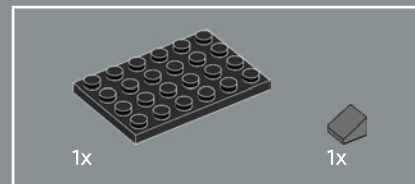
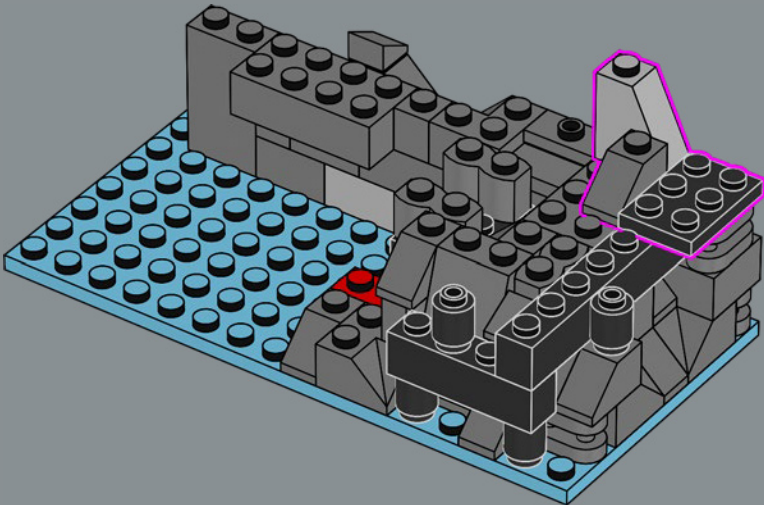

14

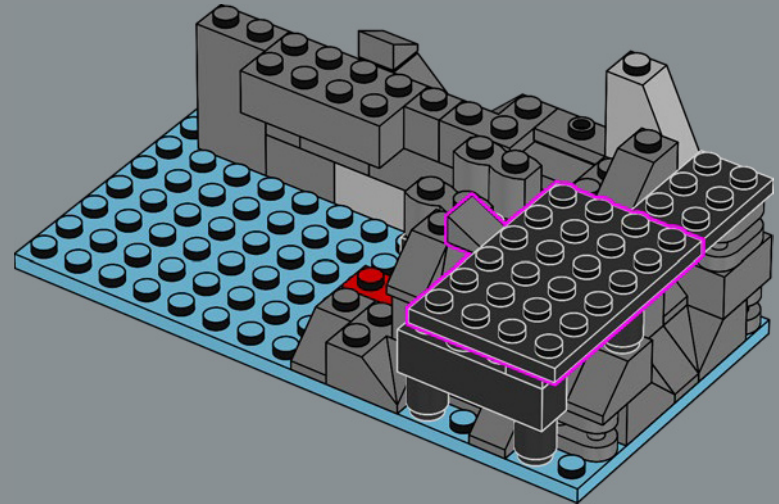

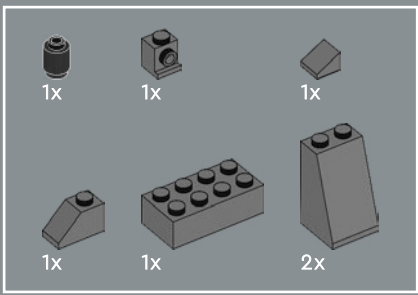

15

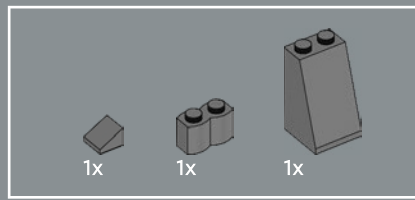
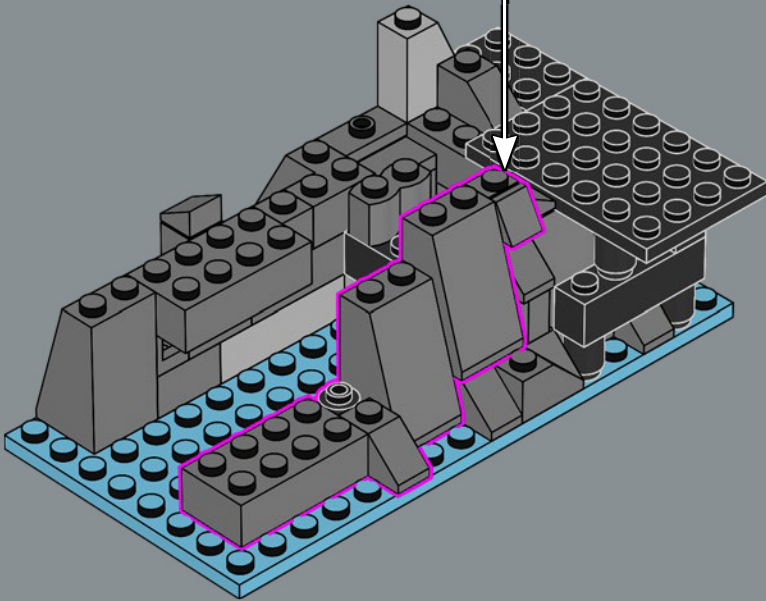
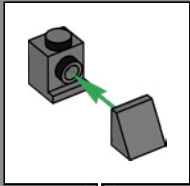

16

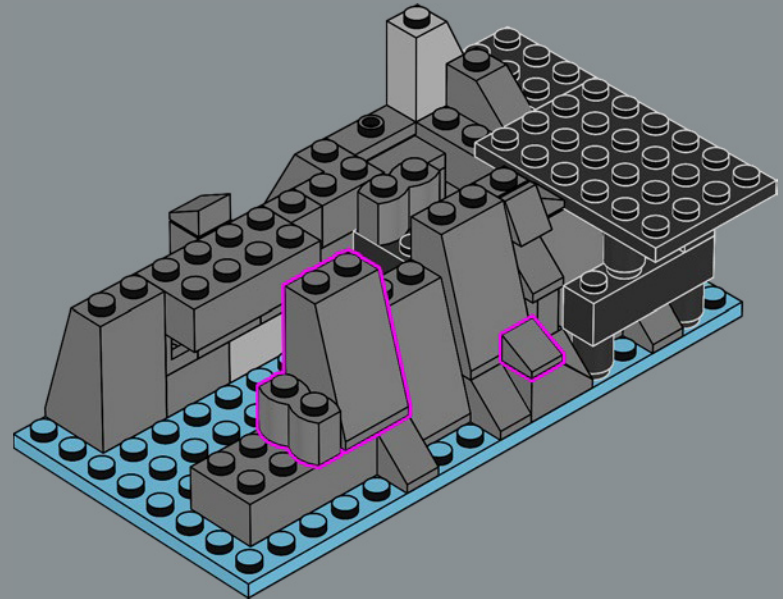

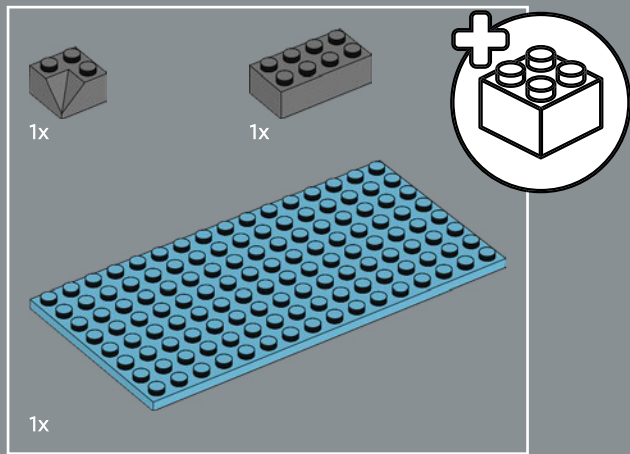

17

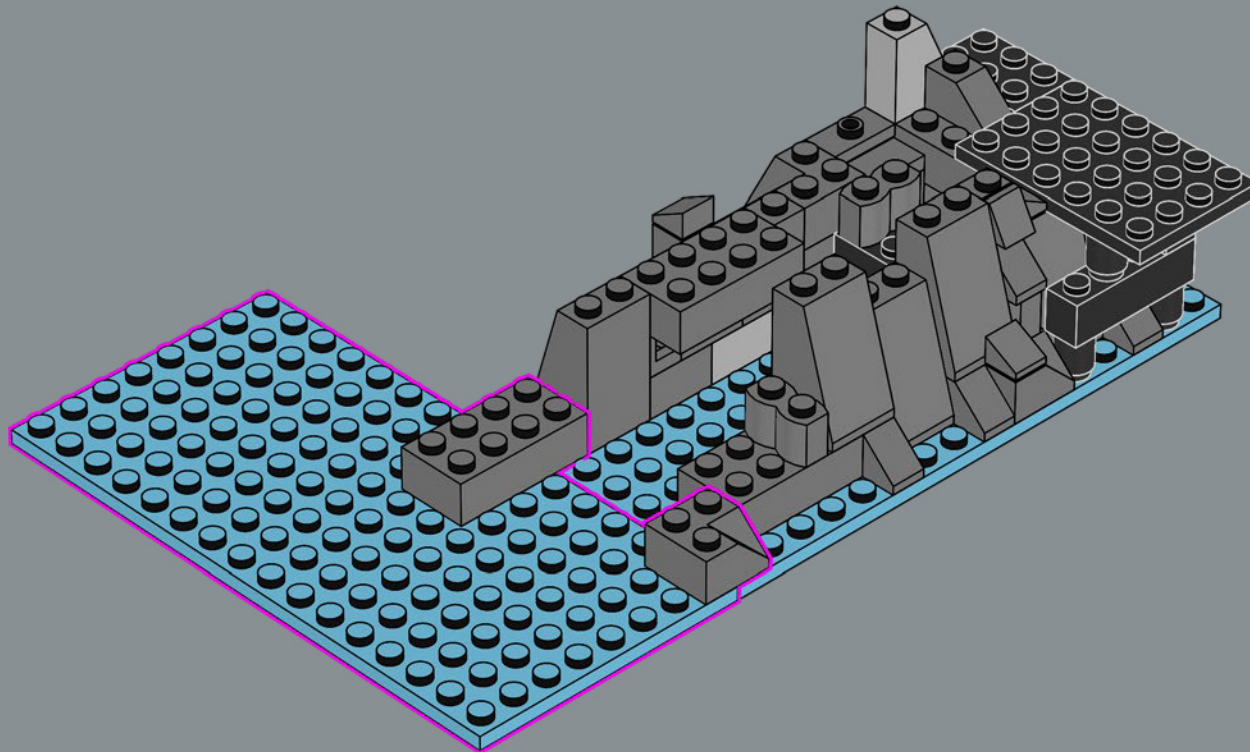

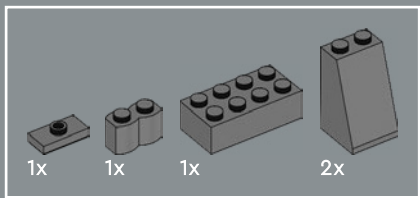

18

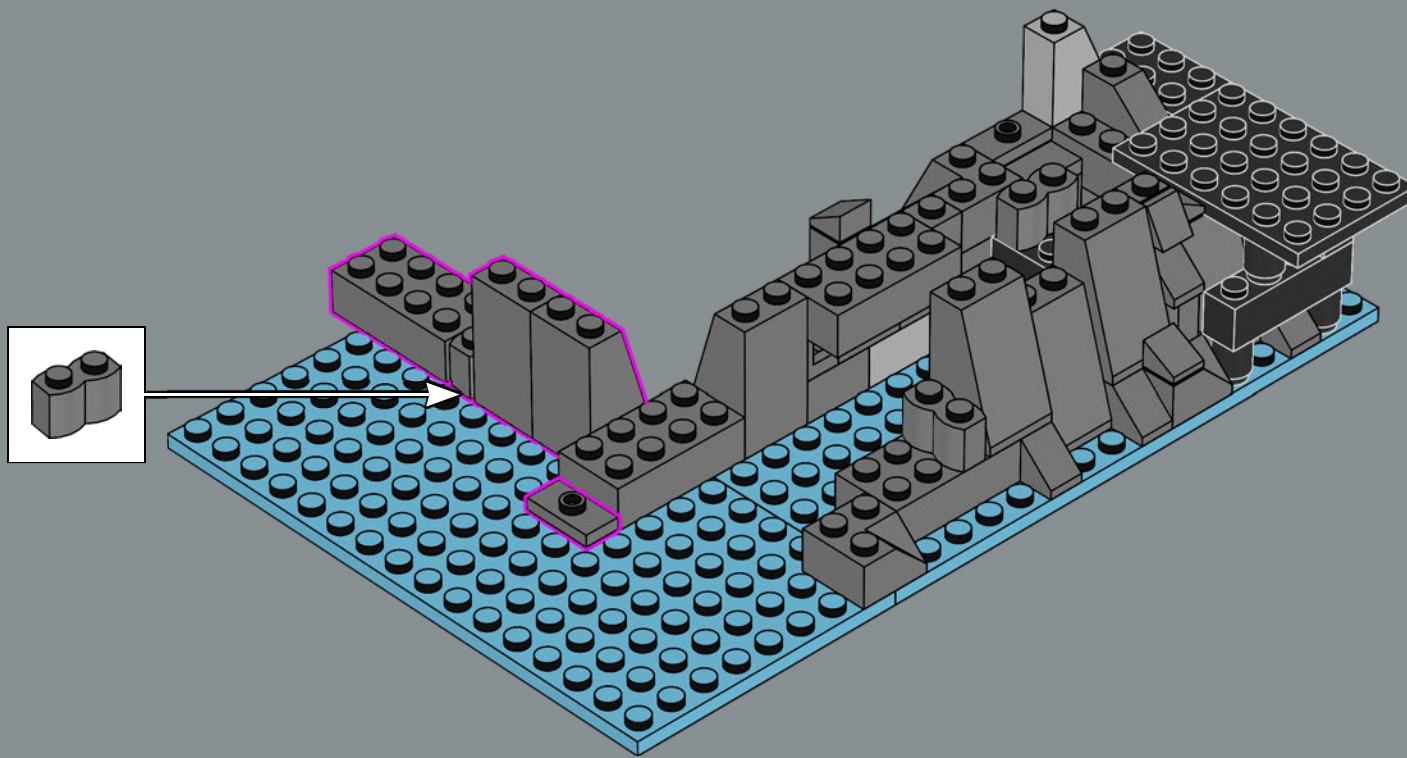

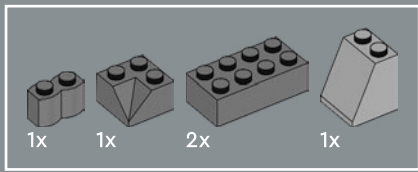

19

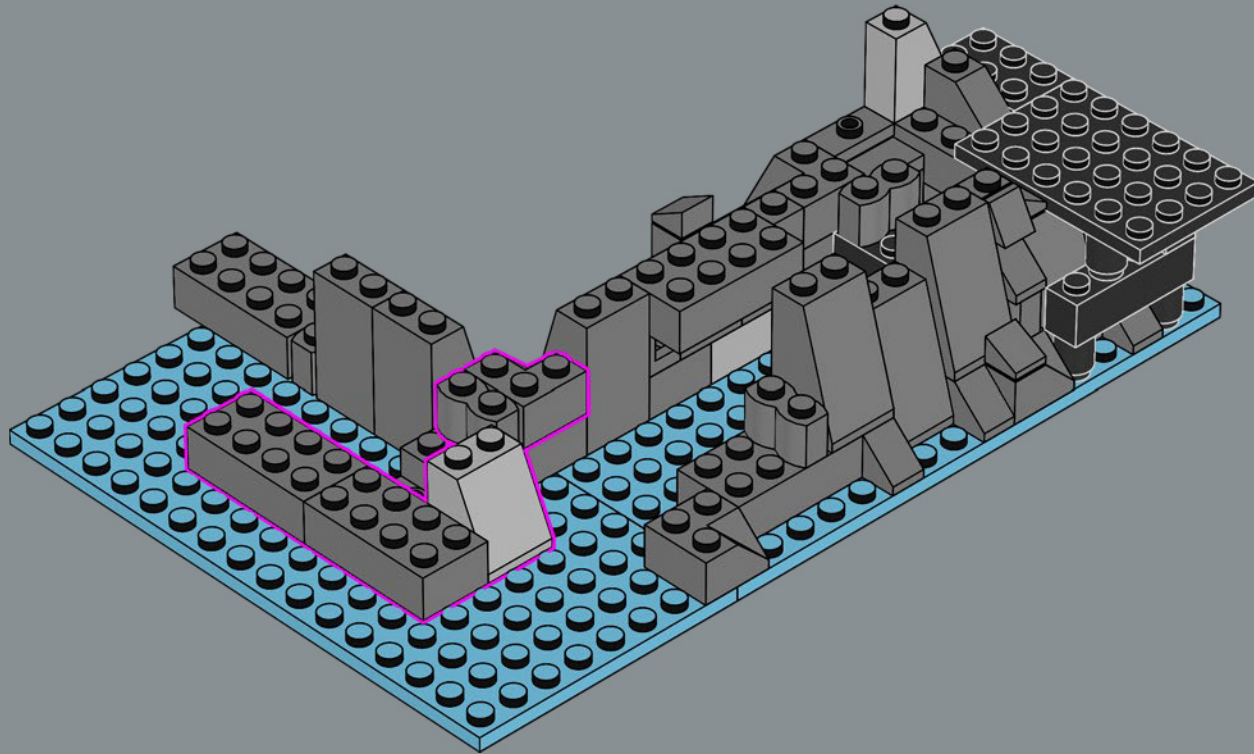

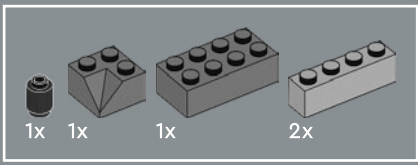

20

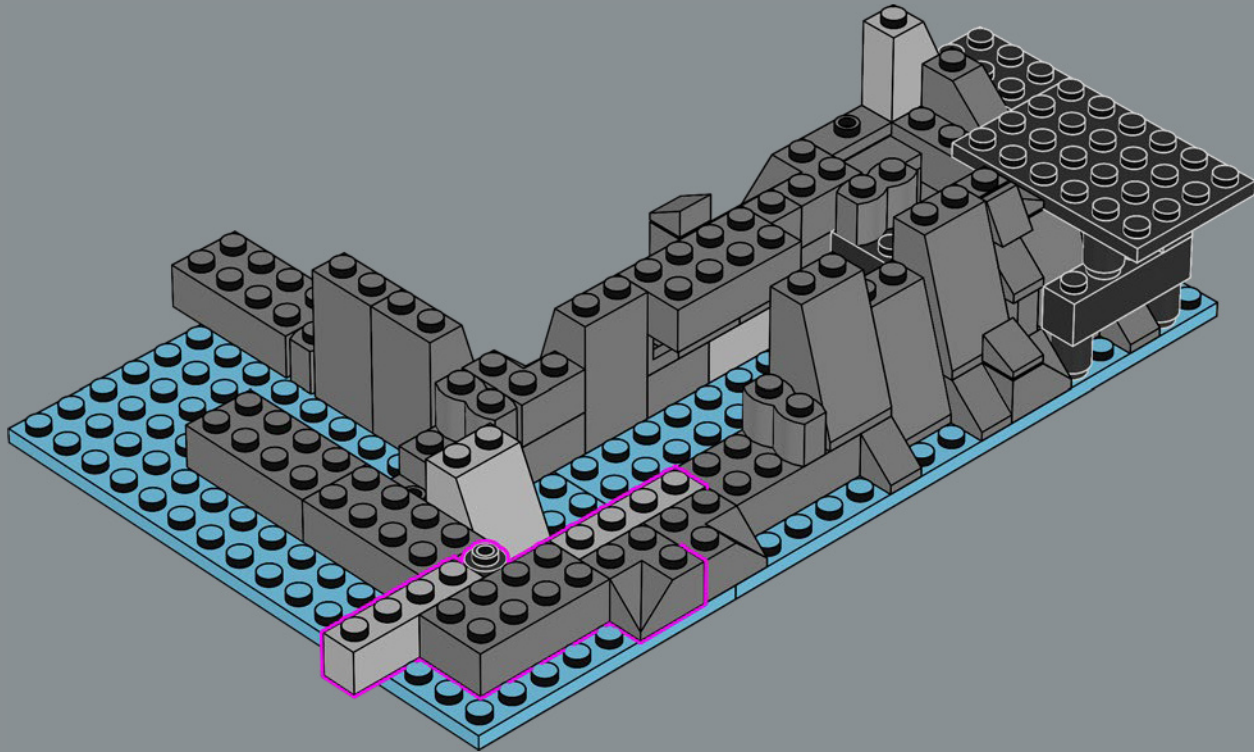

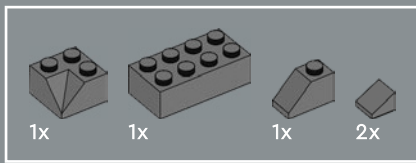

21

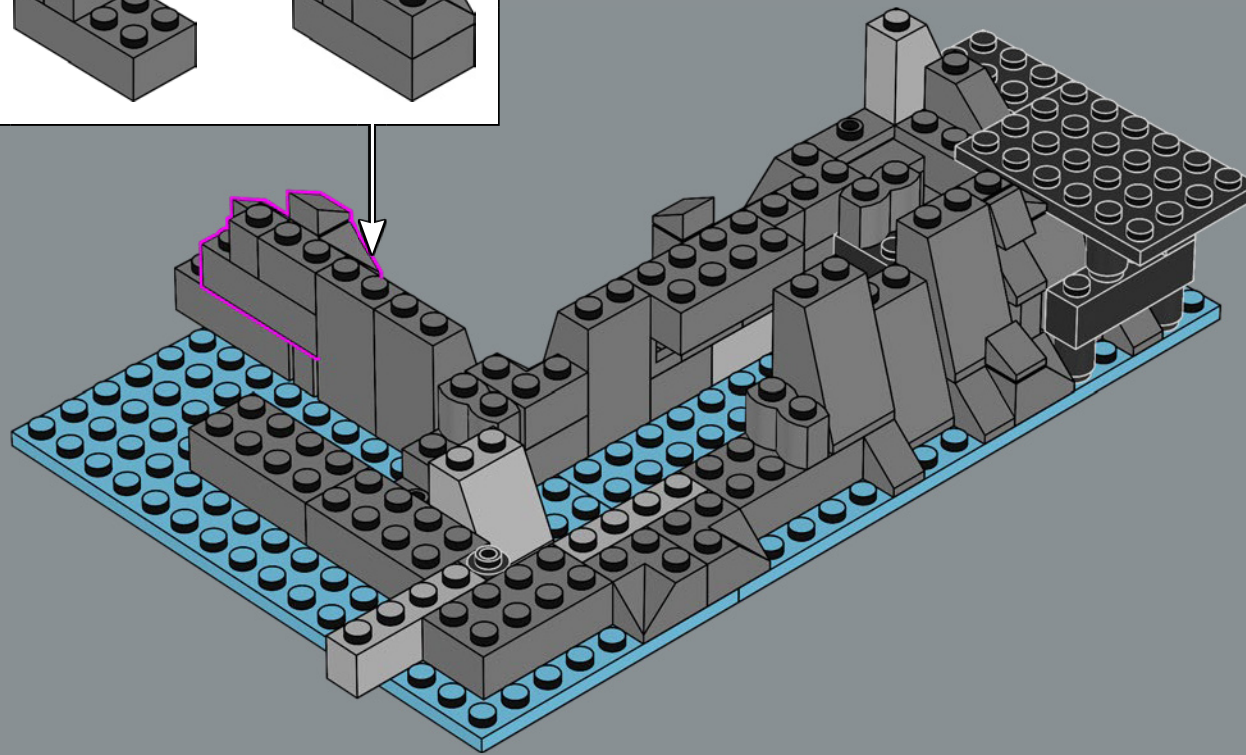
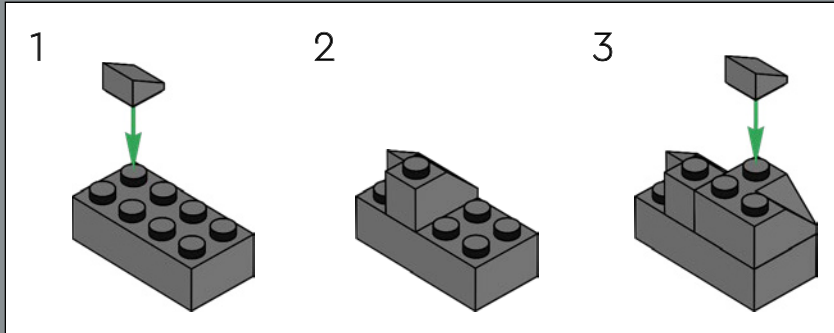

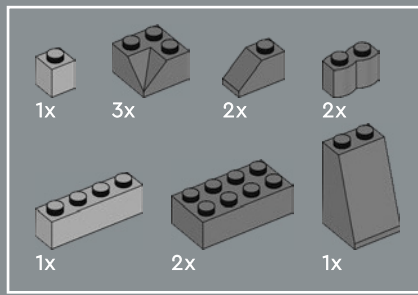

23

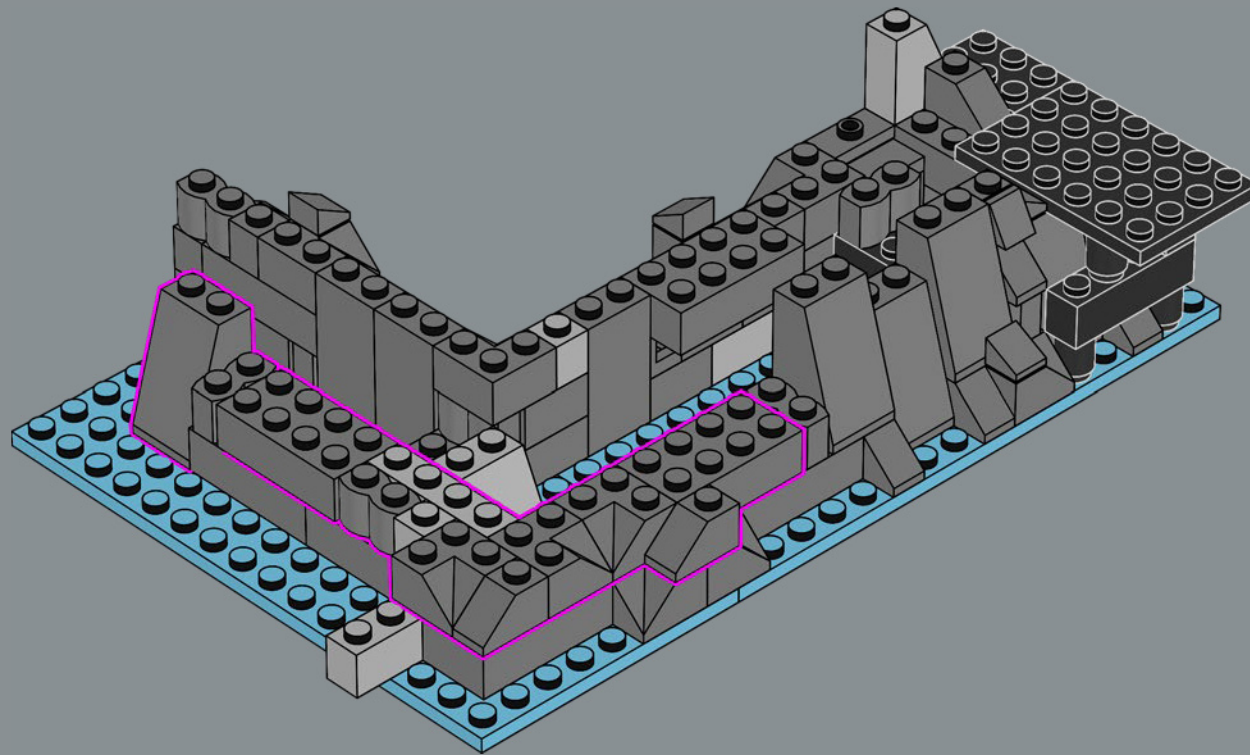

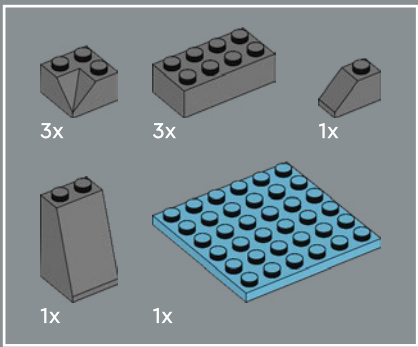

24

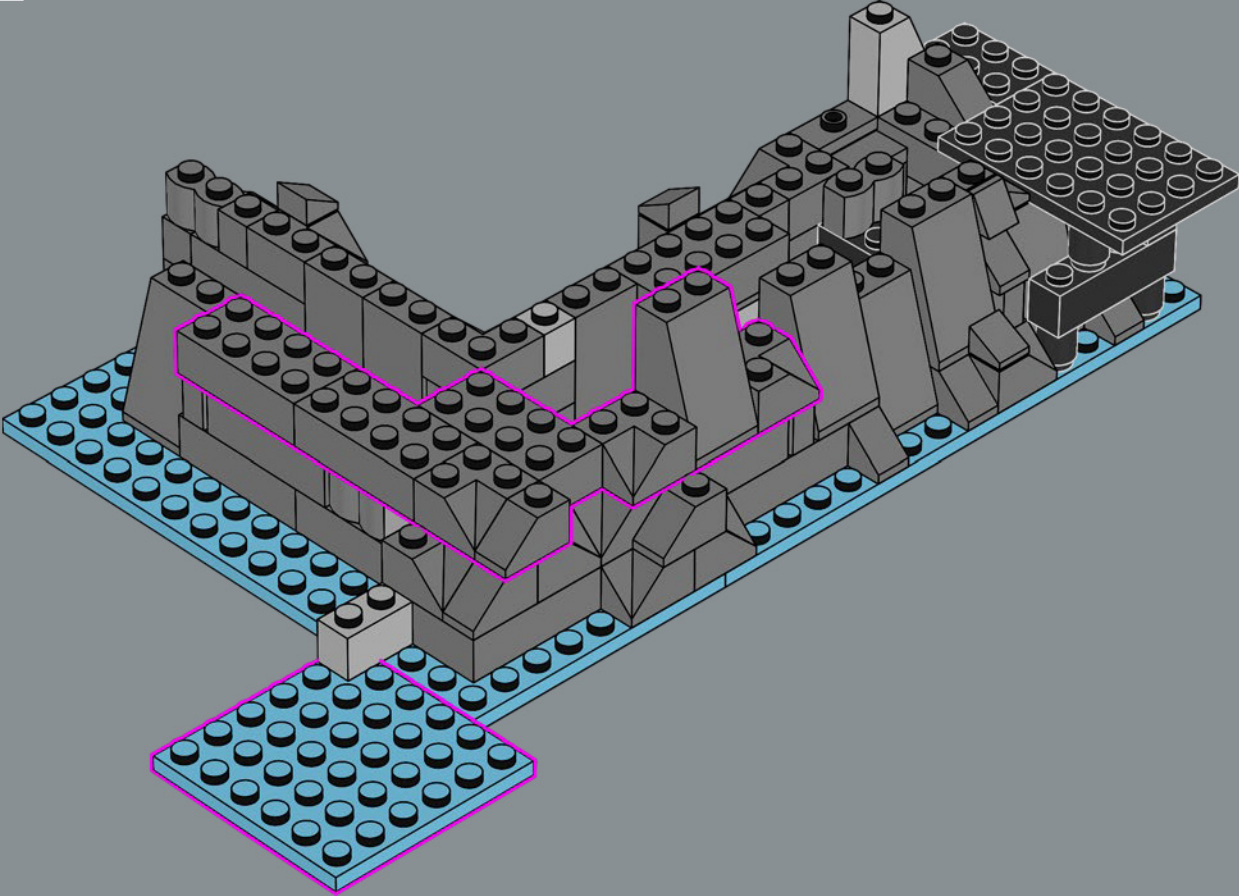

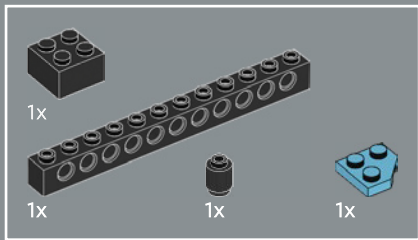

25

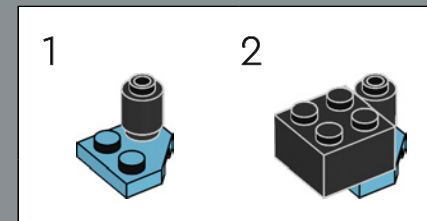
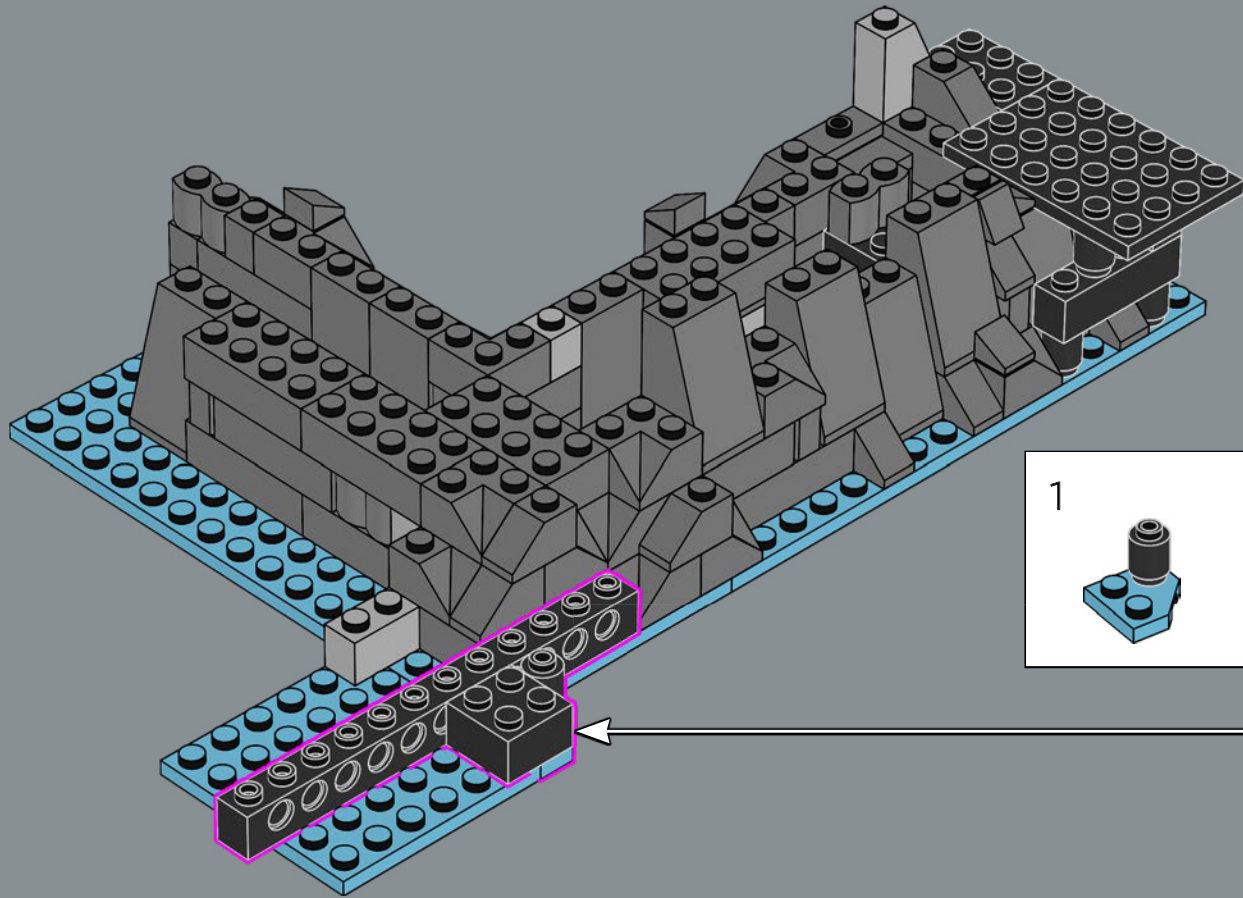

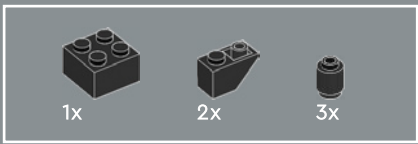

26

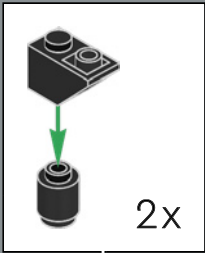
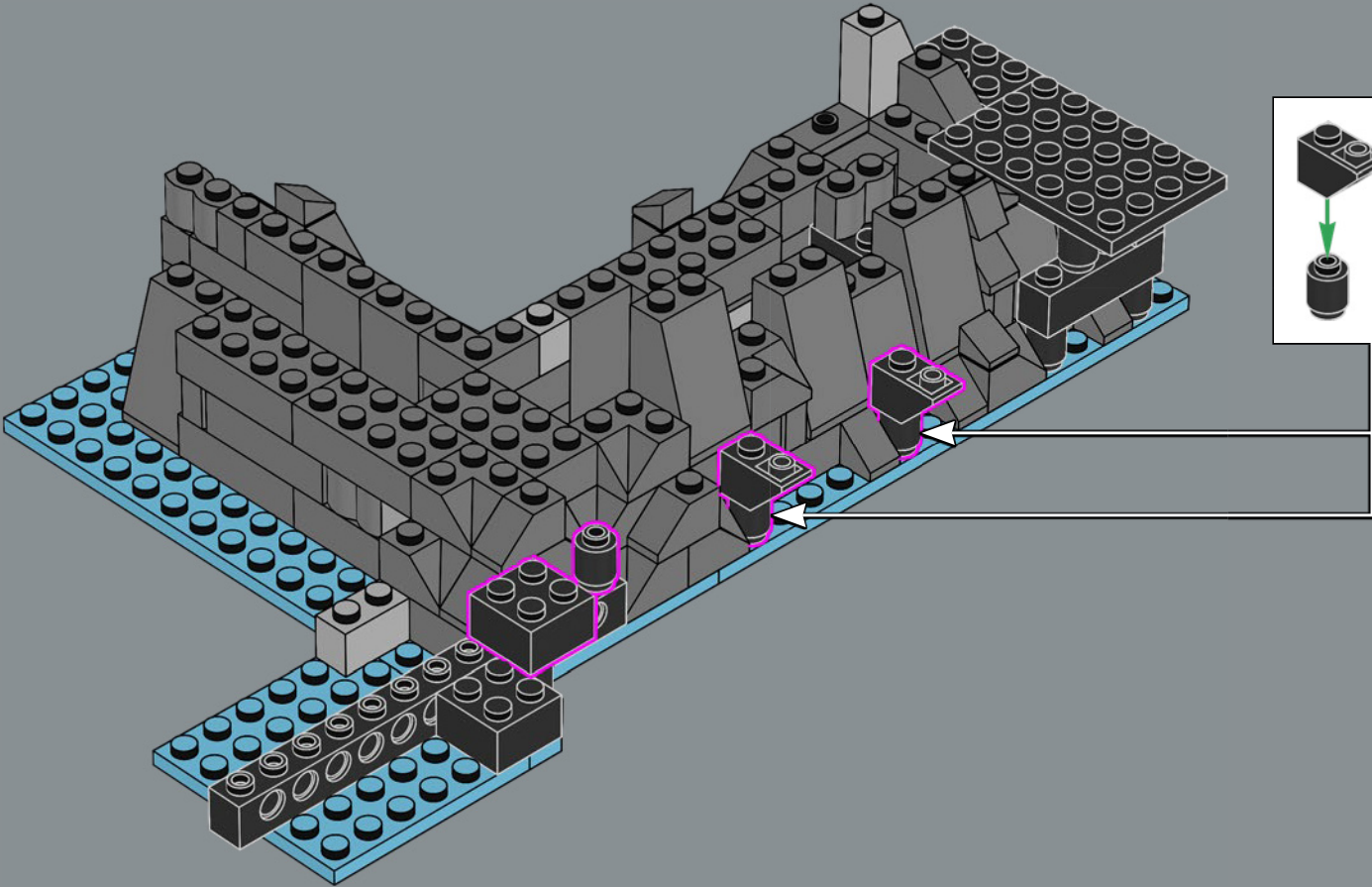

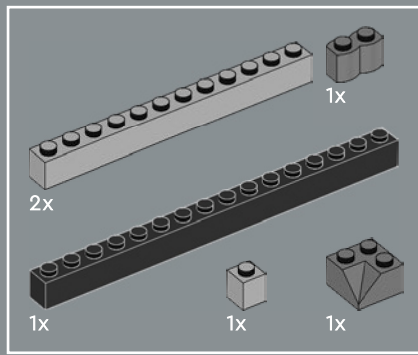

27

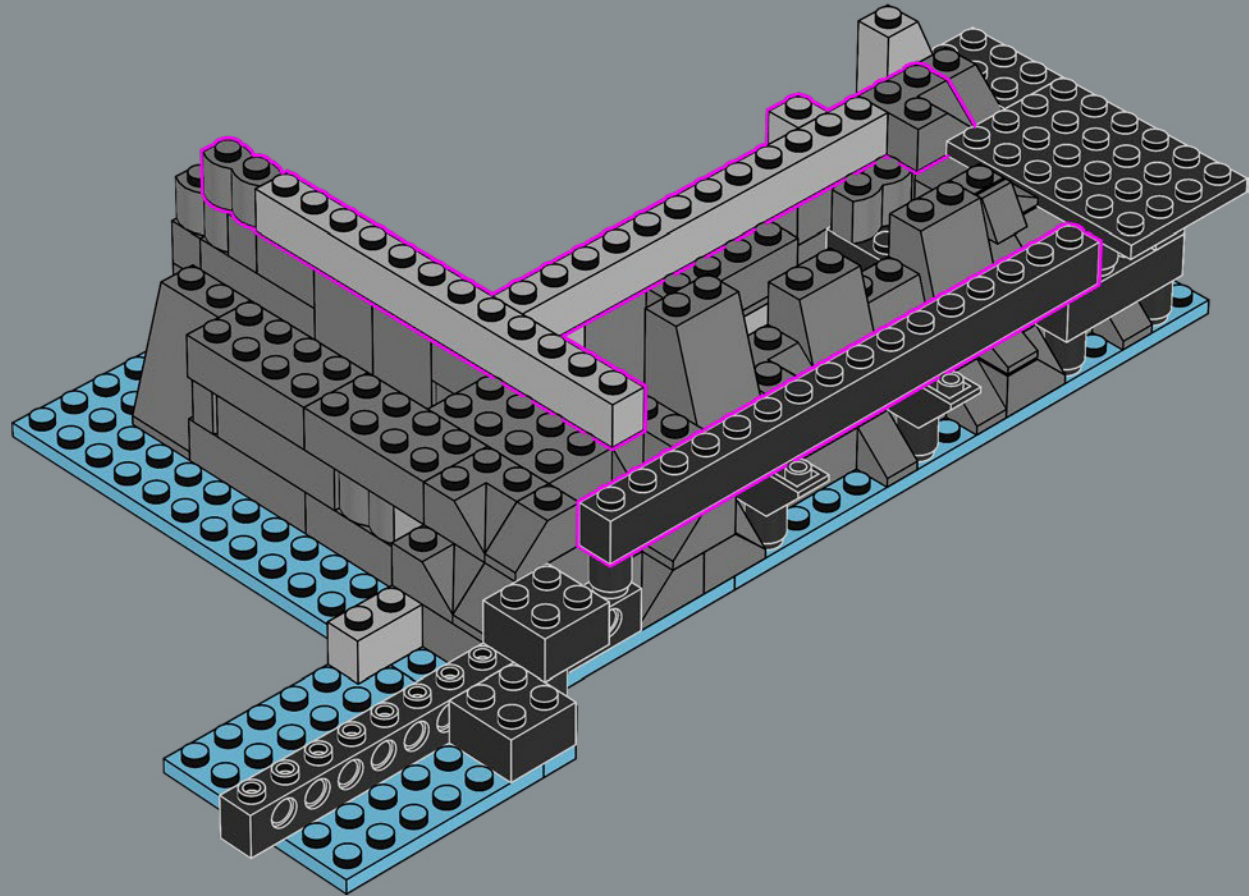

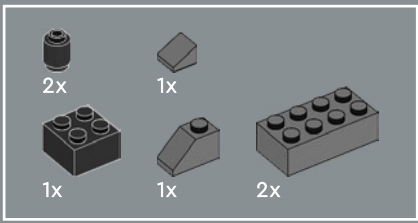

28

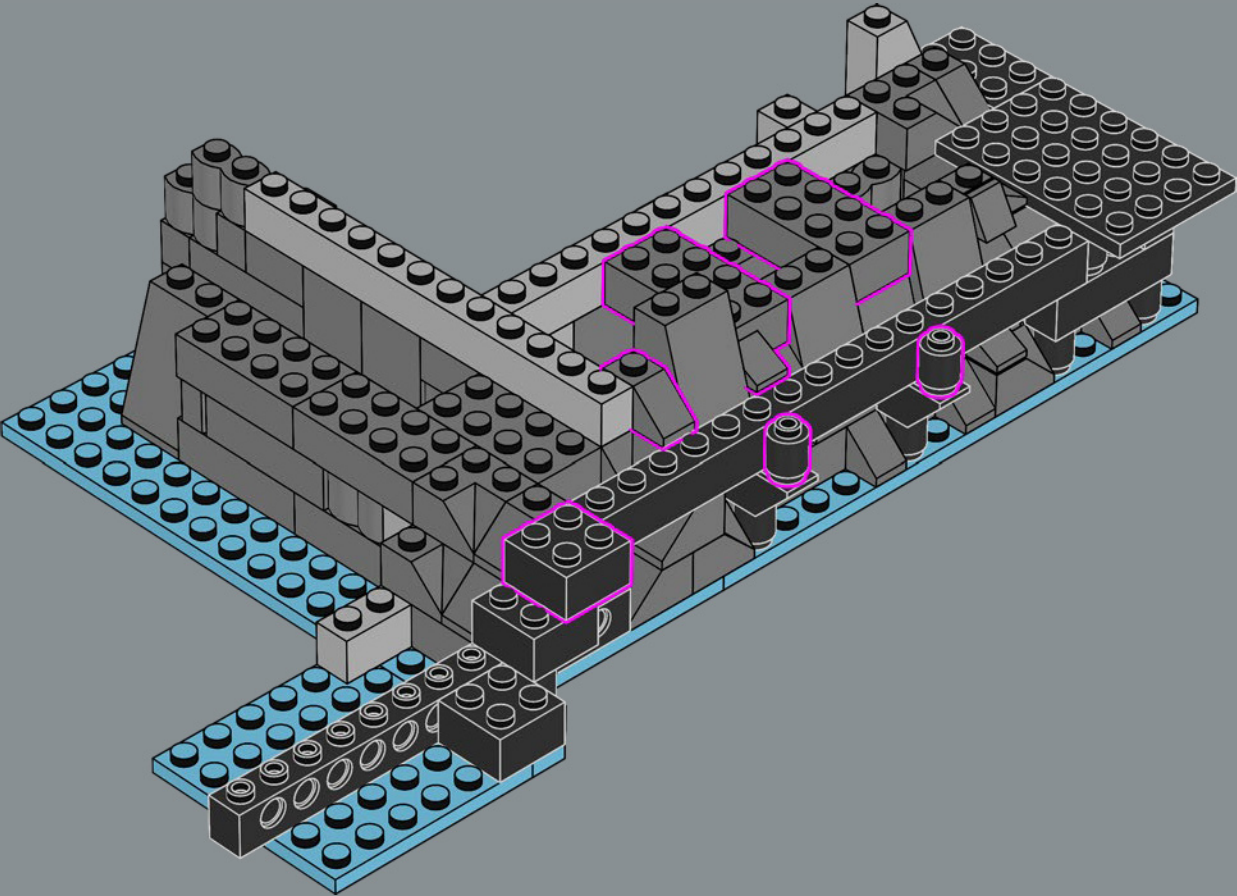

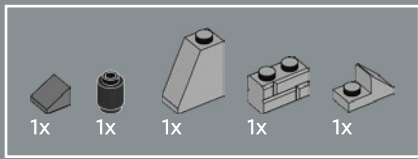

29

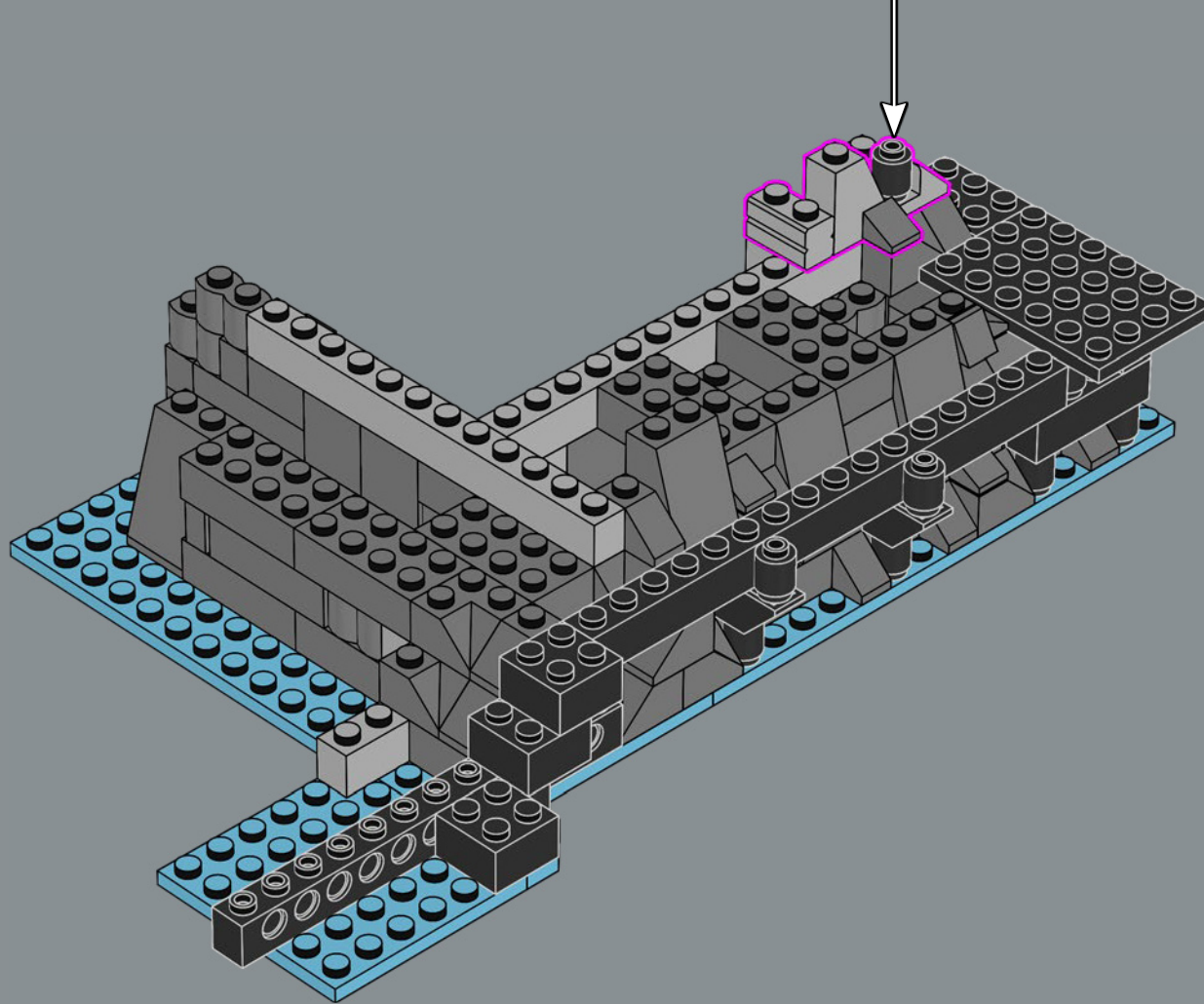
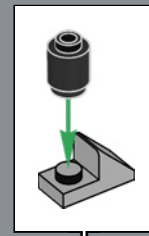

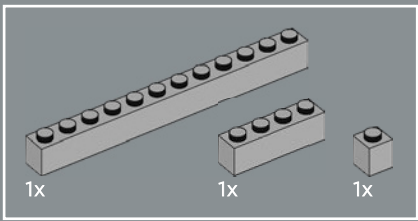

30

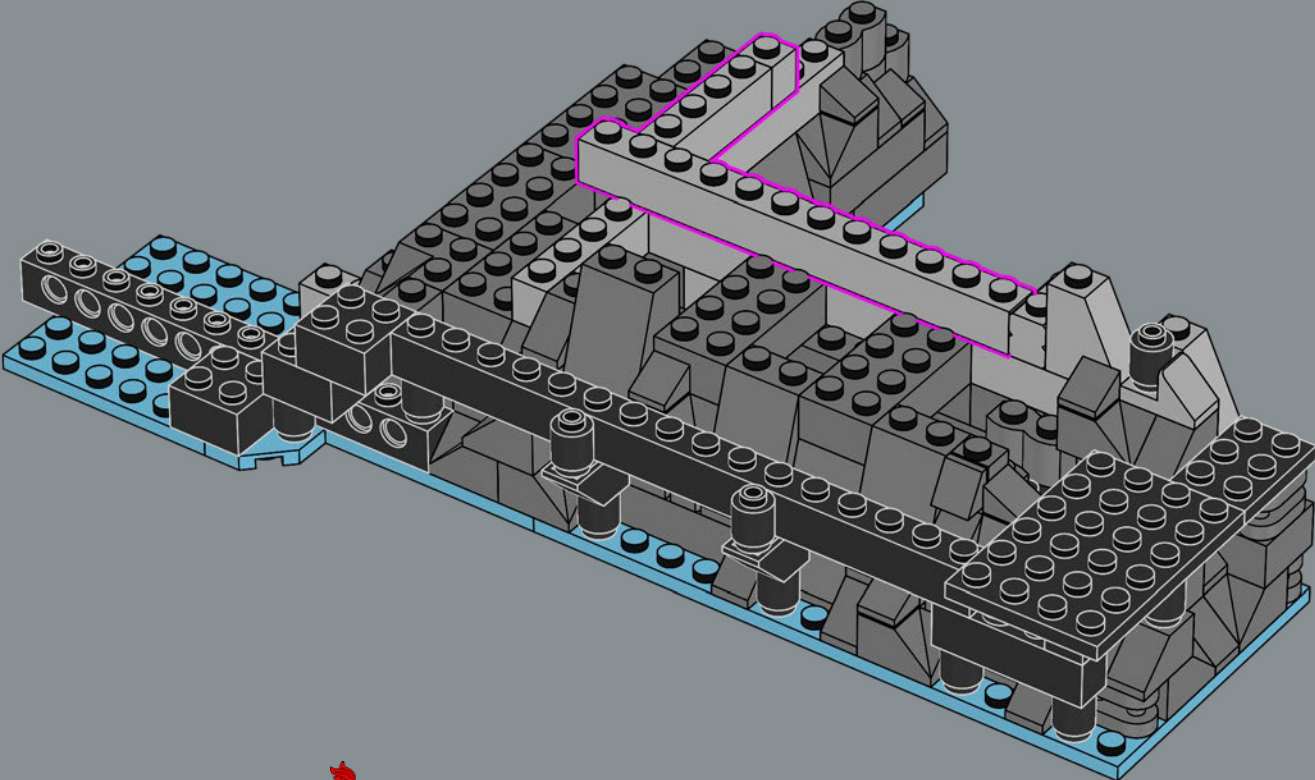

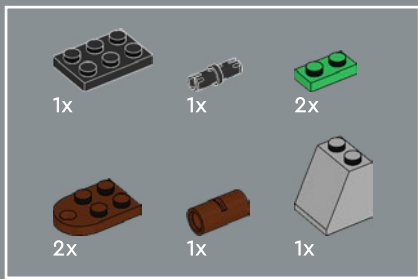

31

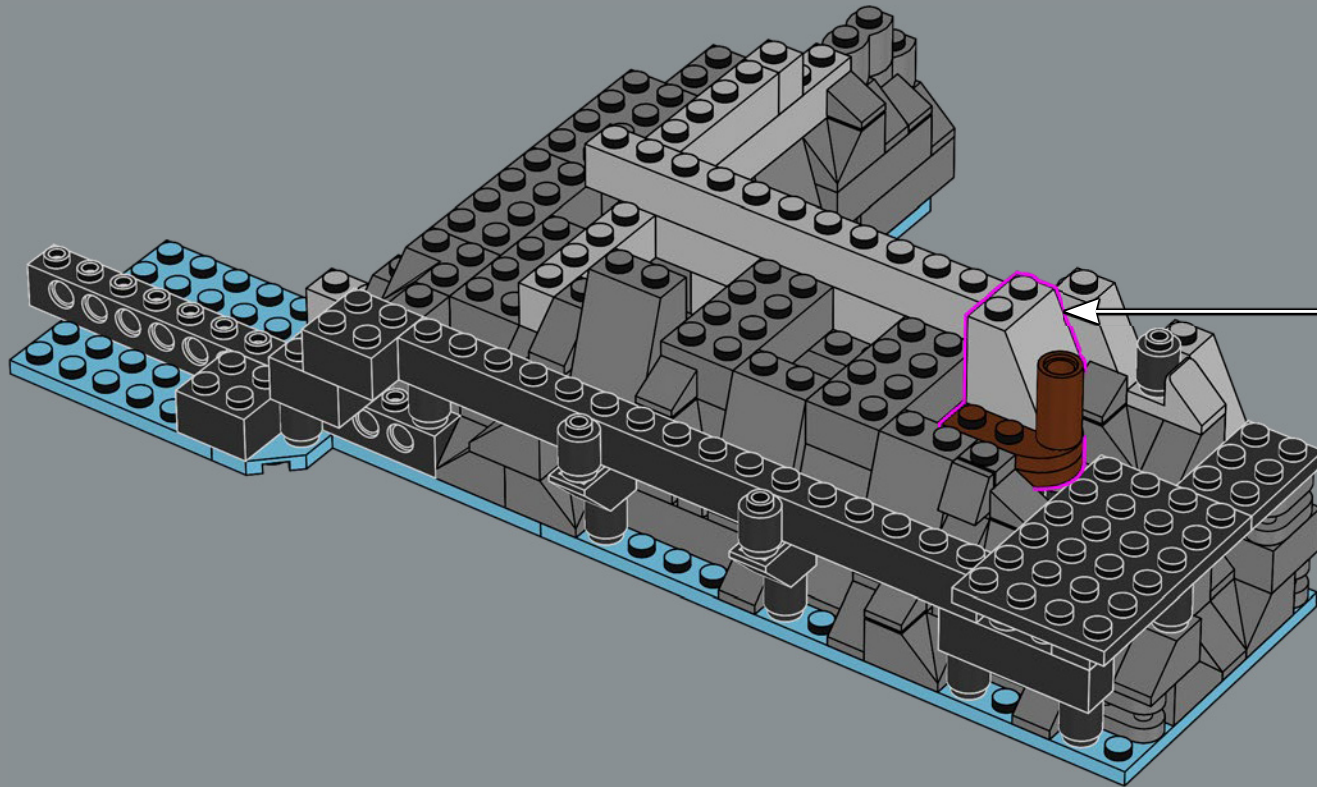
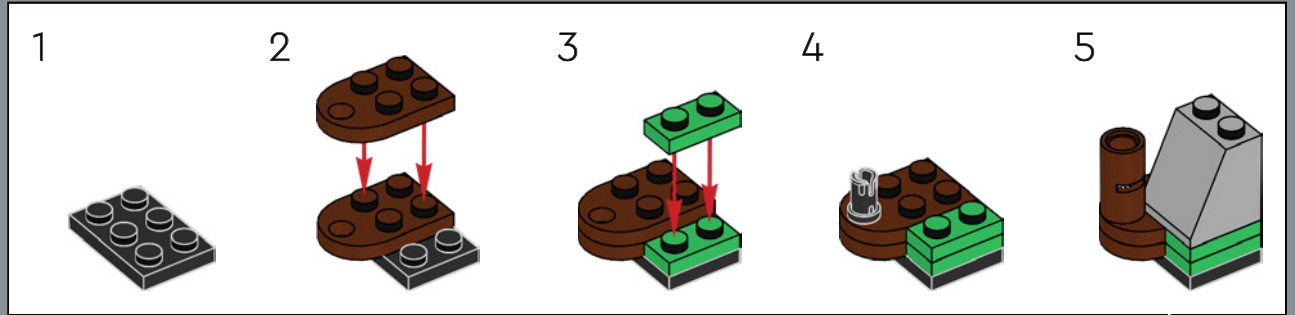

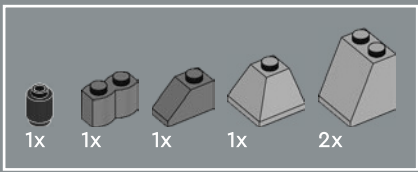

32

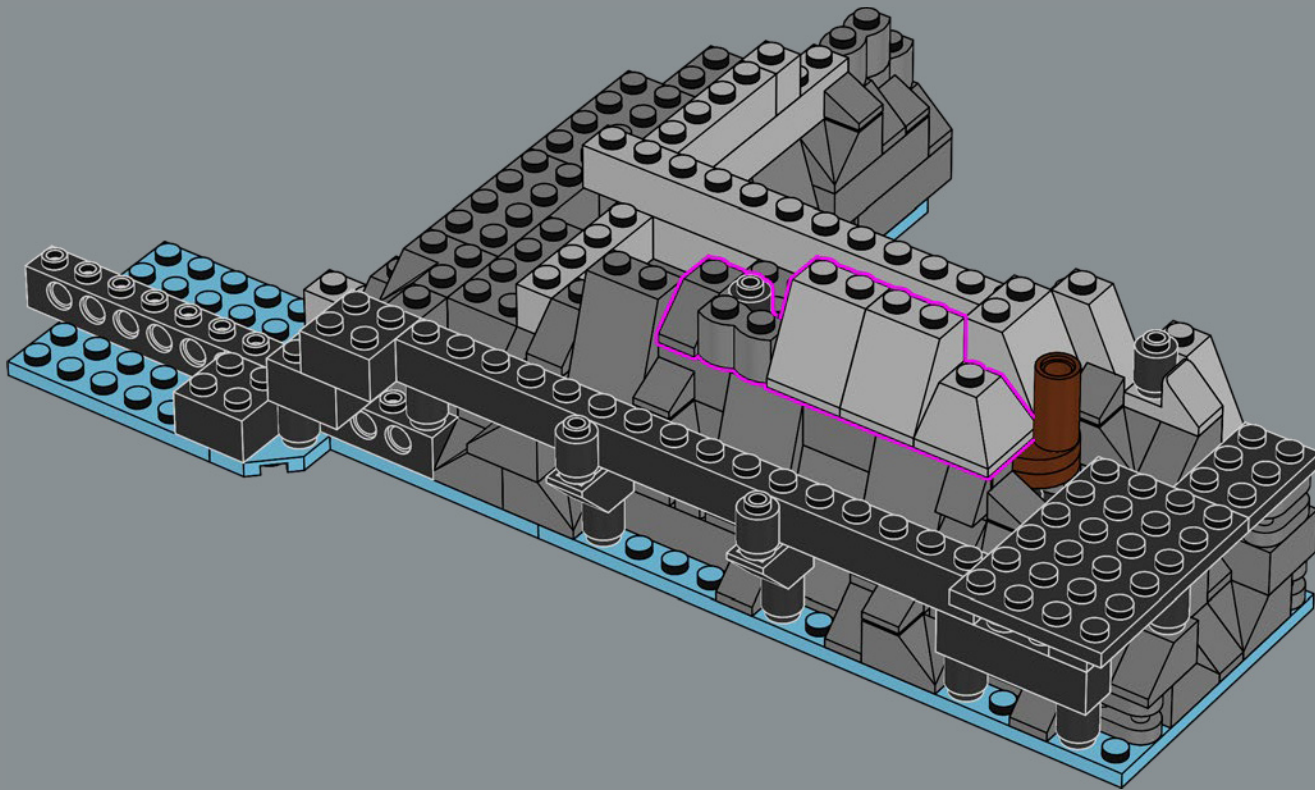

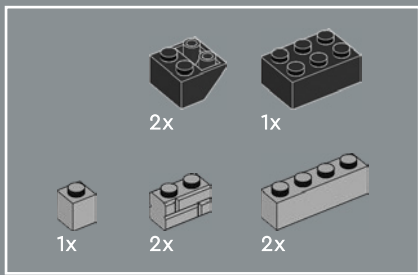

33

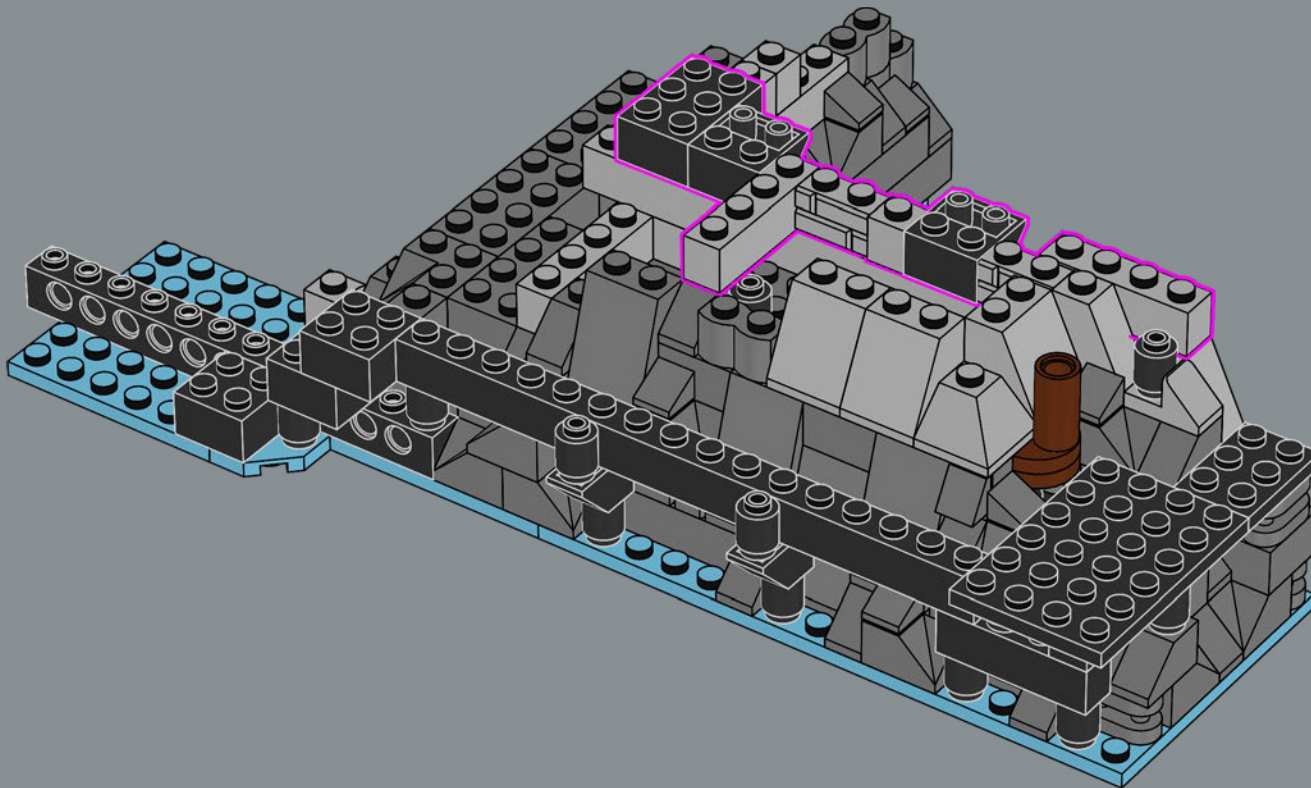

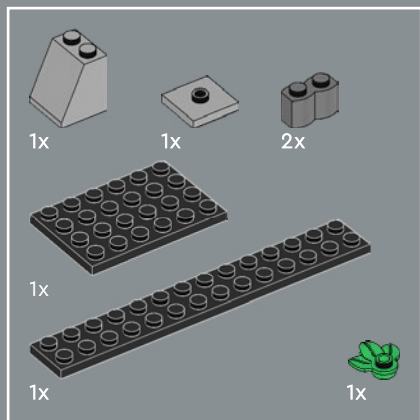

34

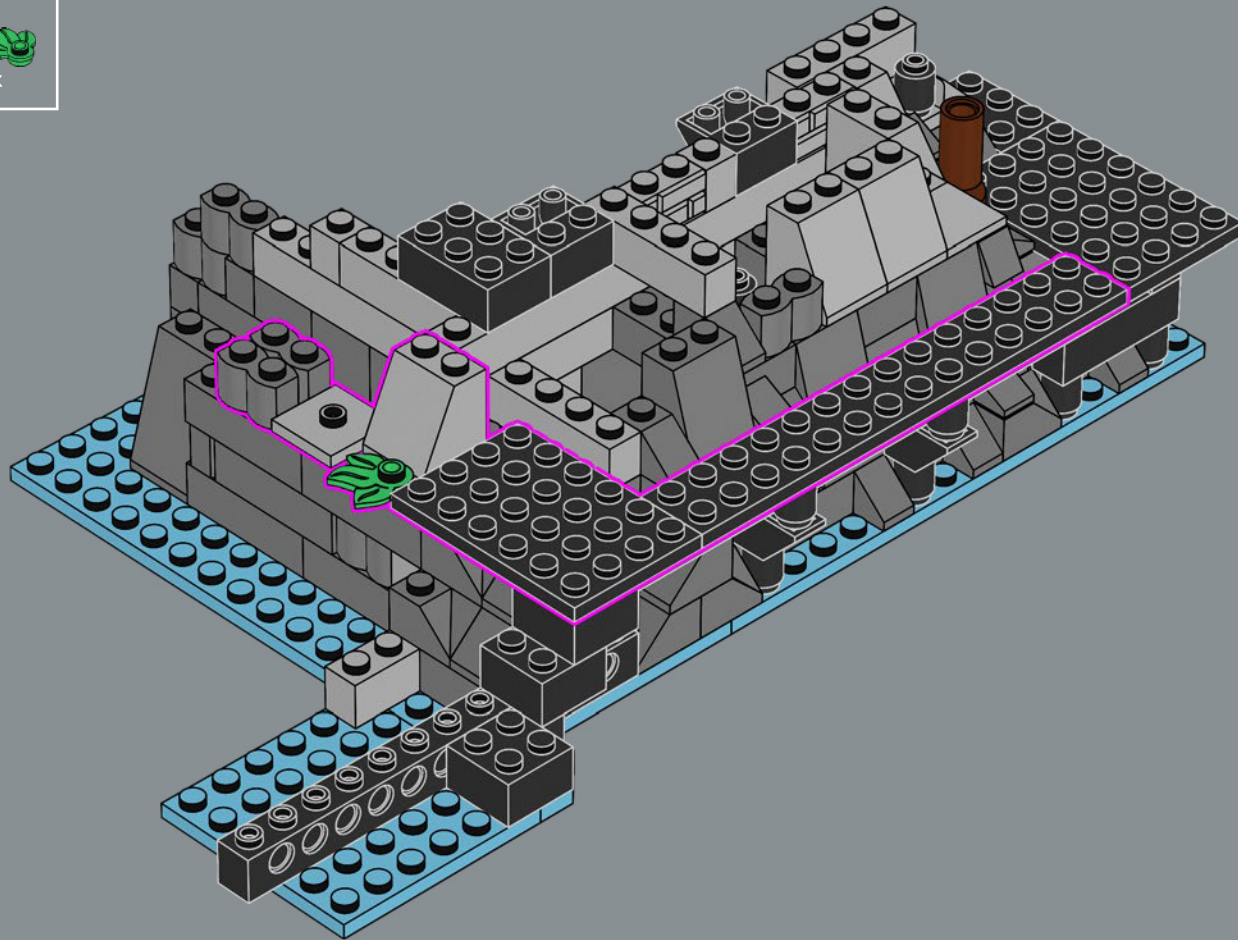

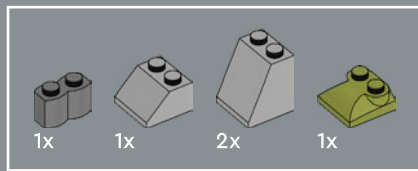

35

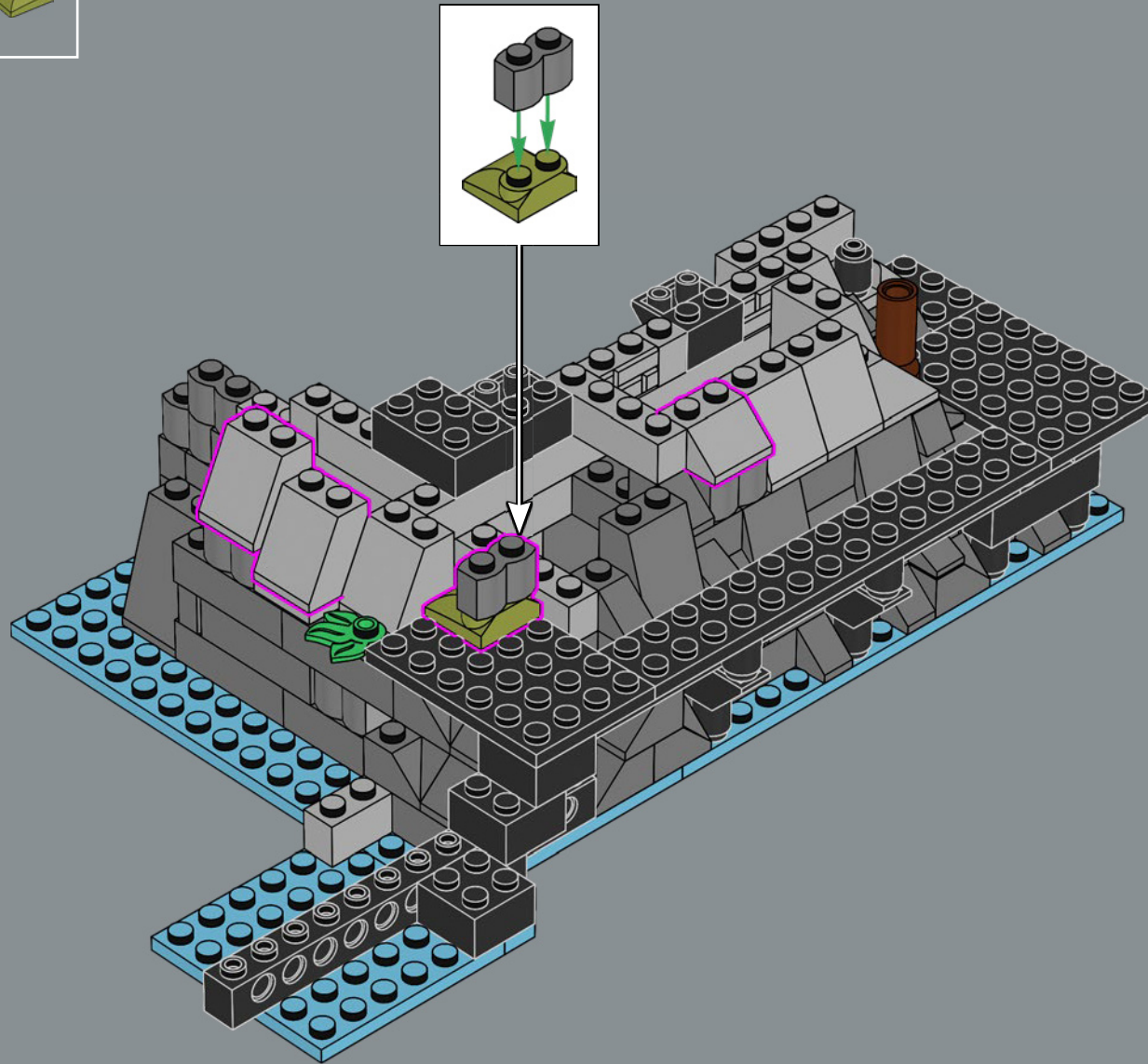

- 4x 
- 1x 
- 1x 

36

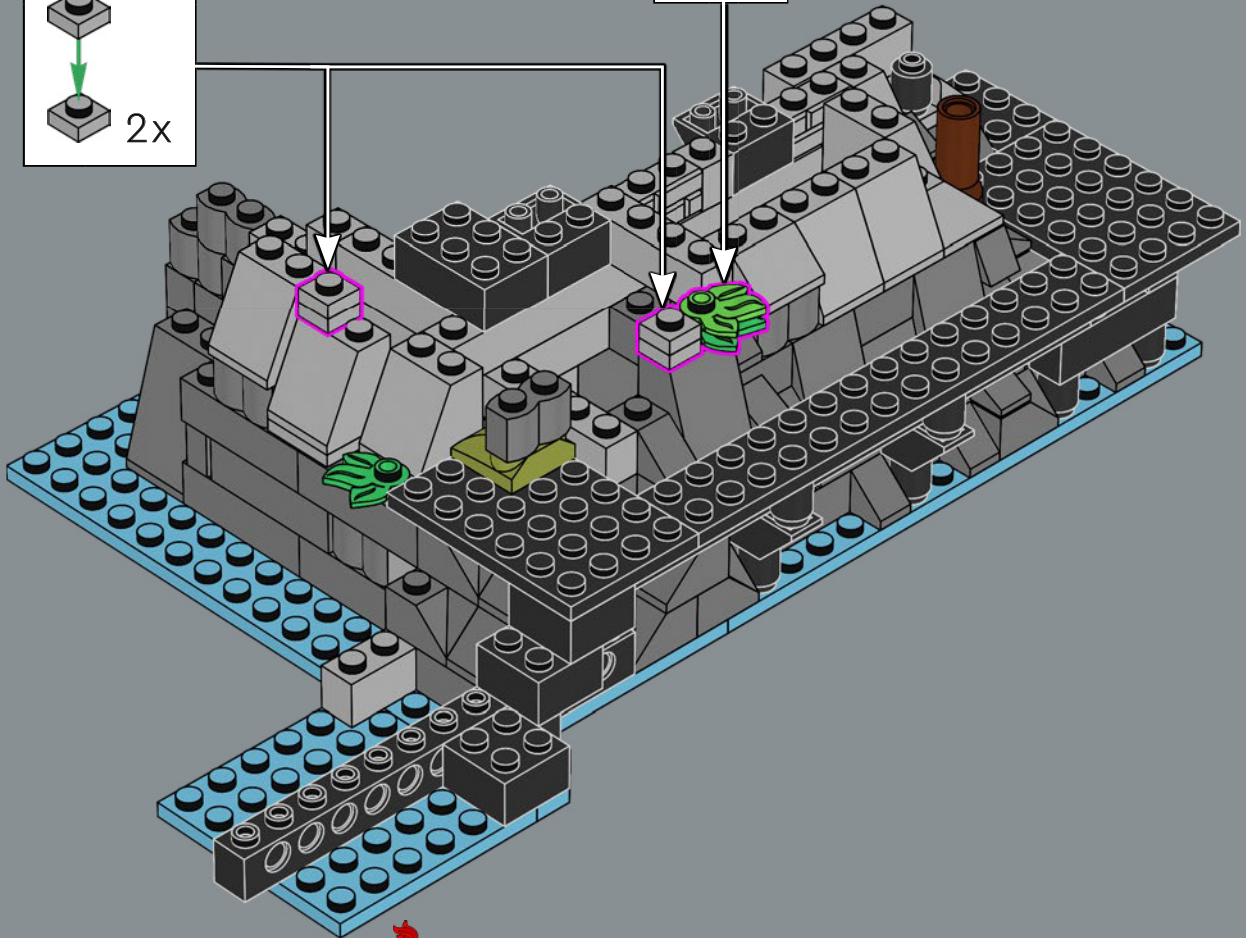
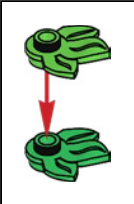
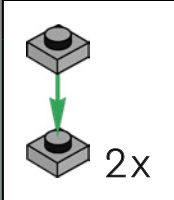

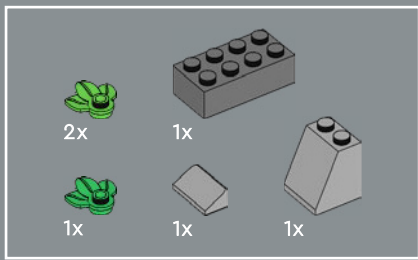

37

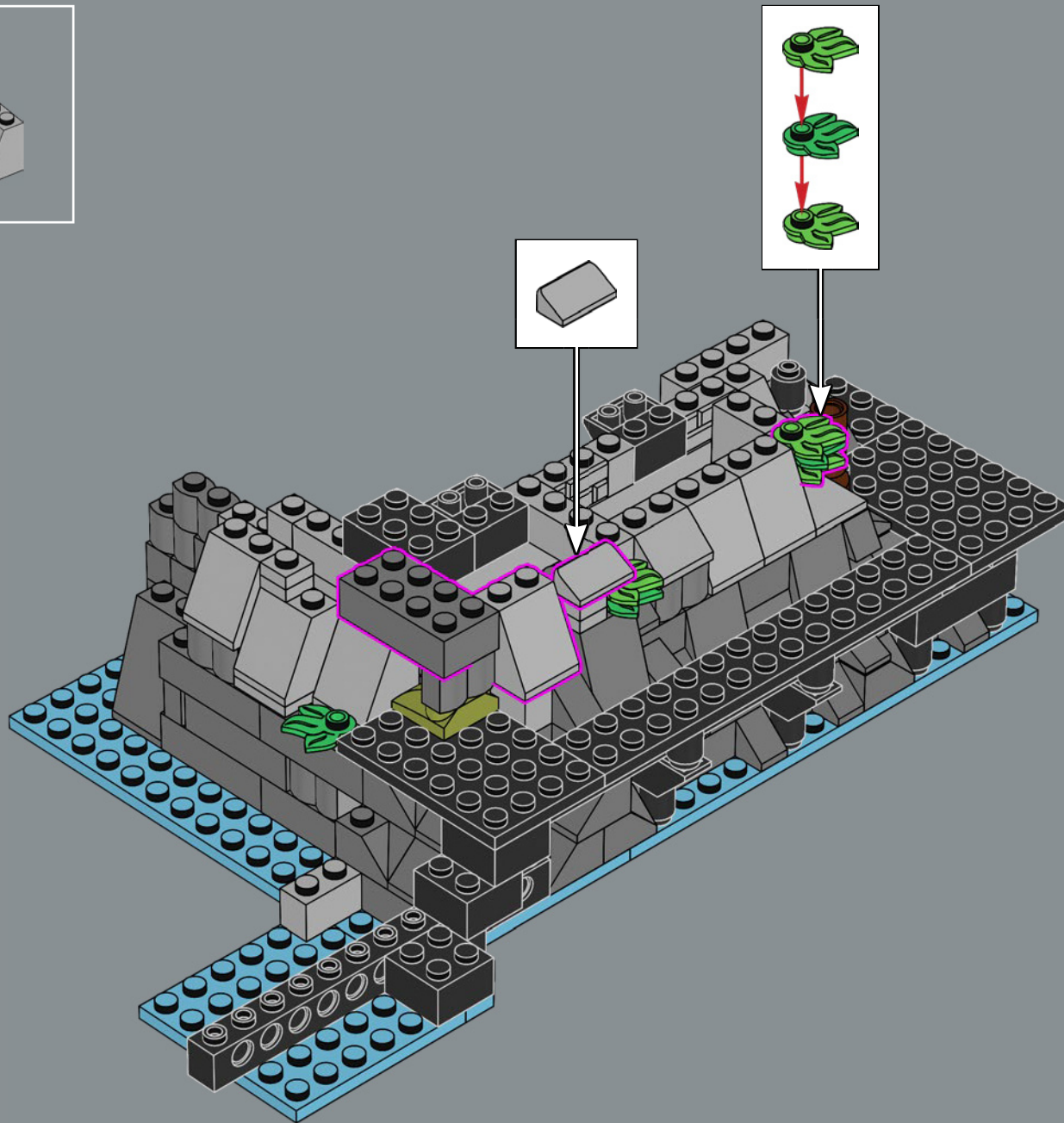

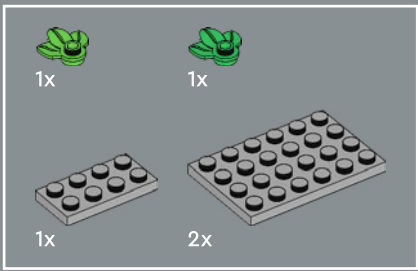

38

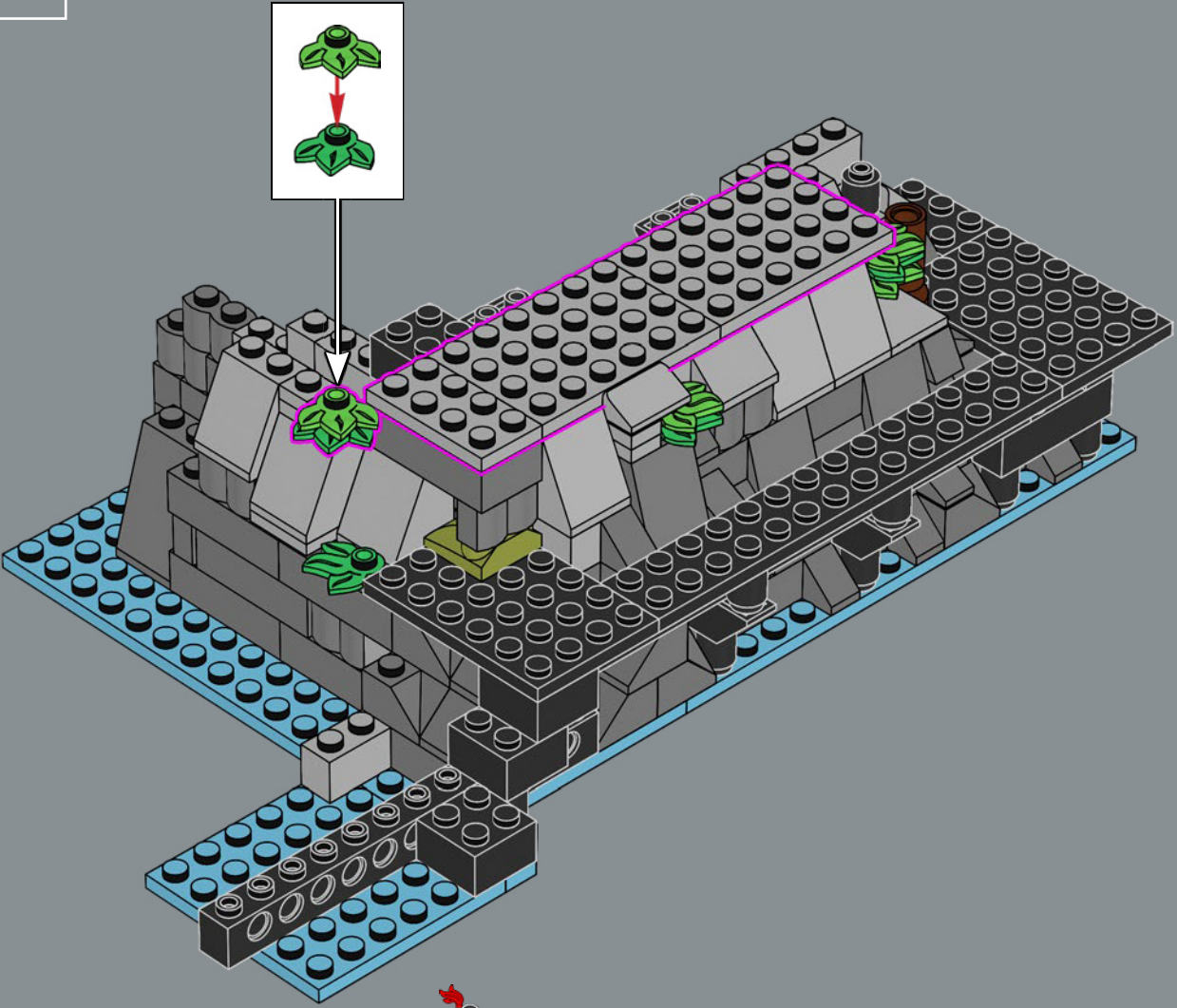

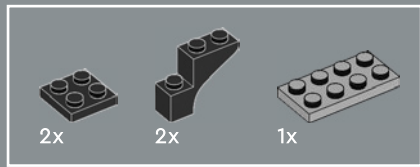

39

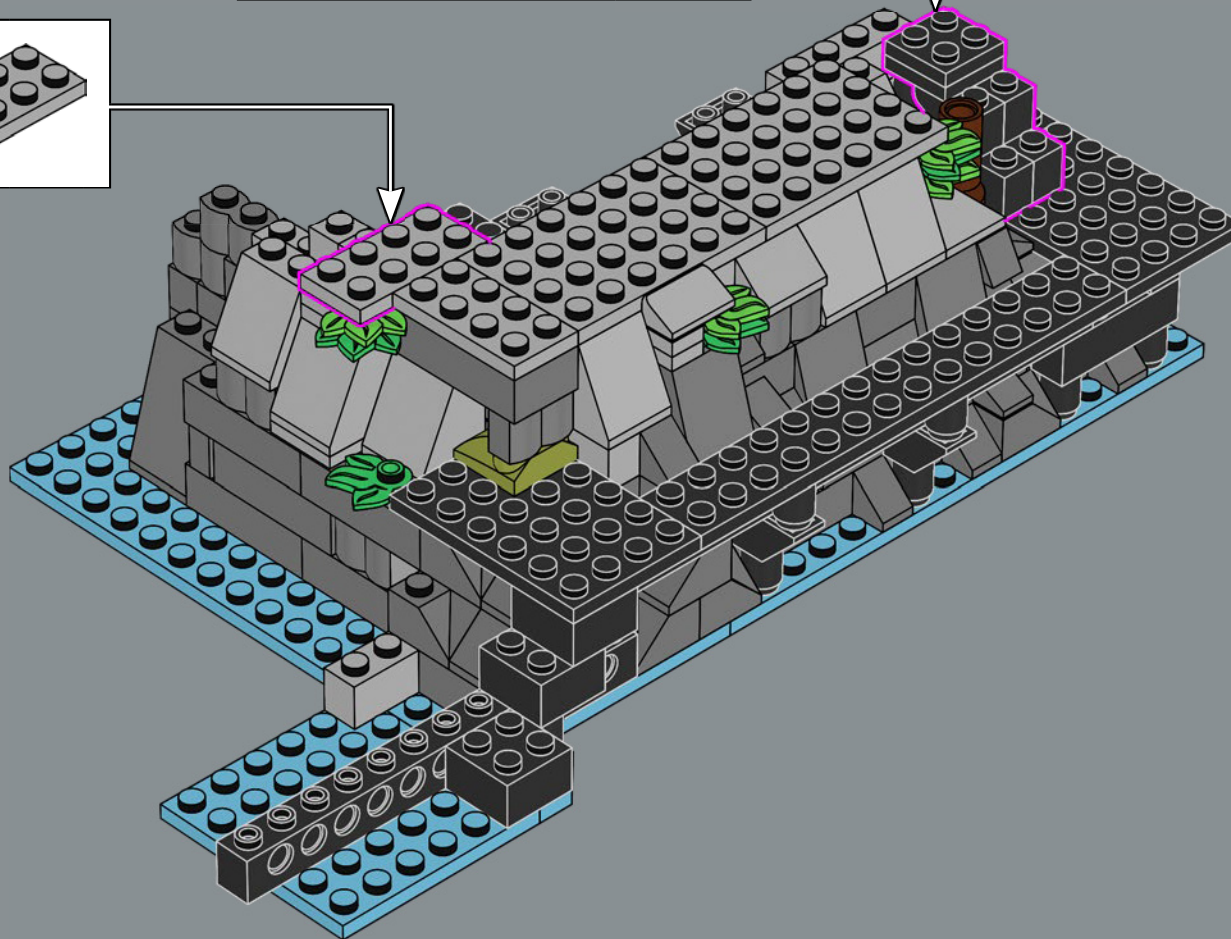
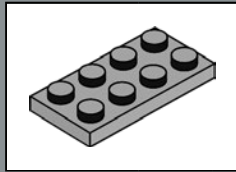
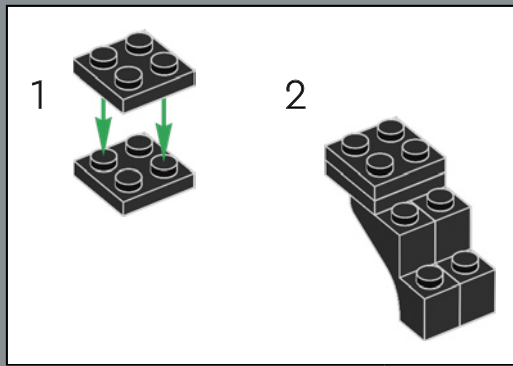

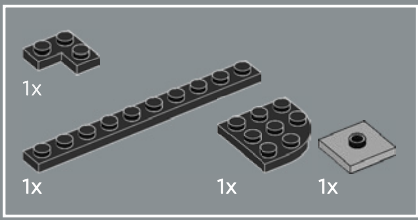

40

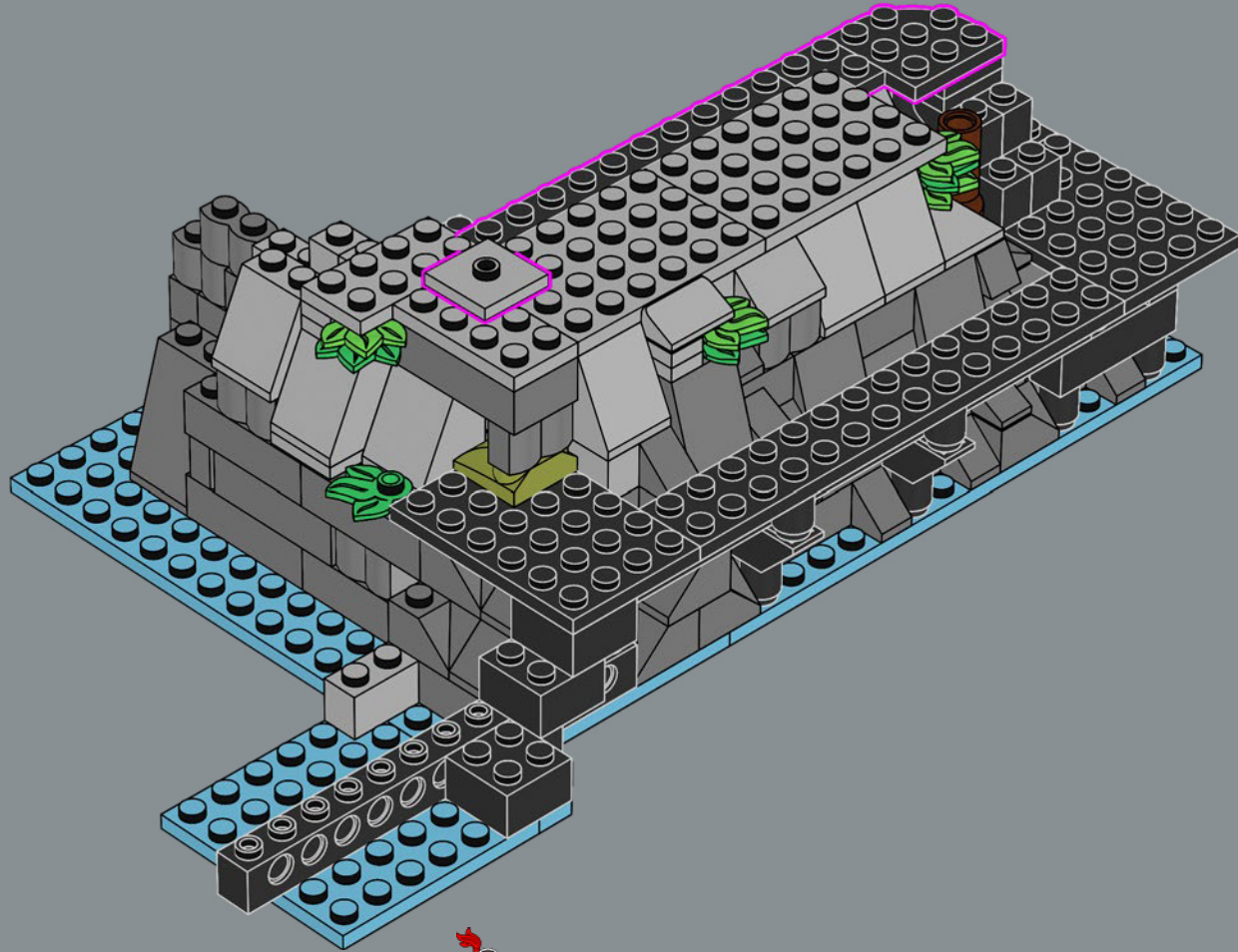

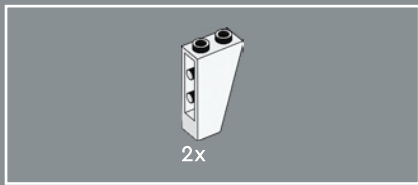

41

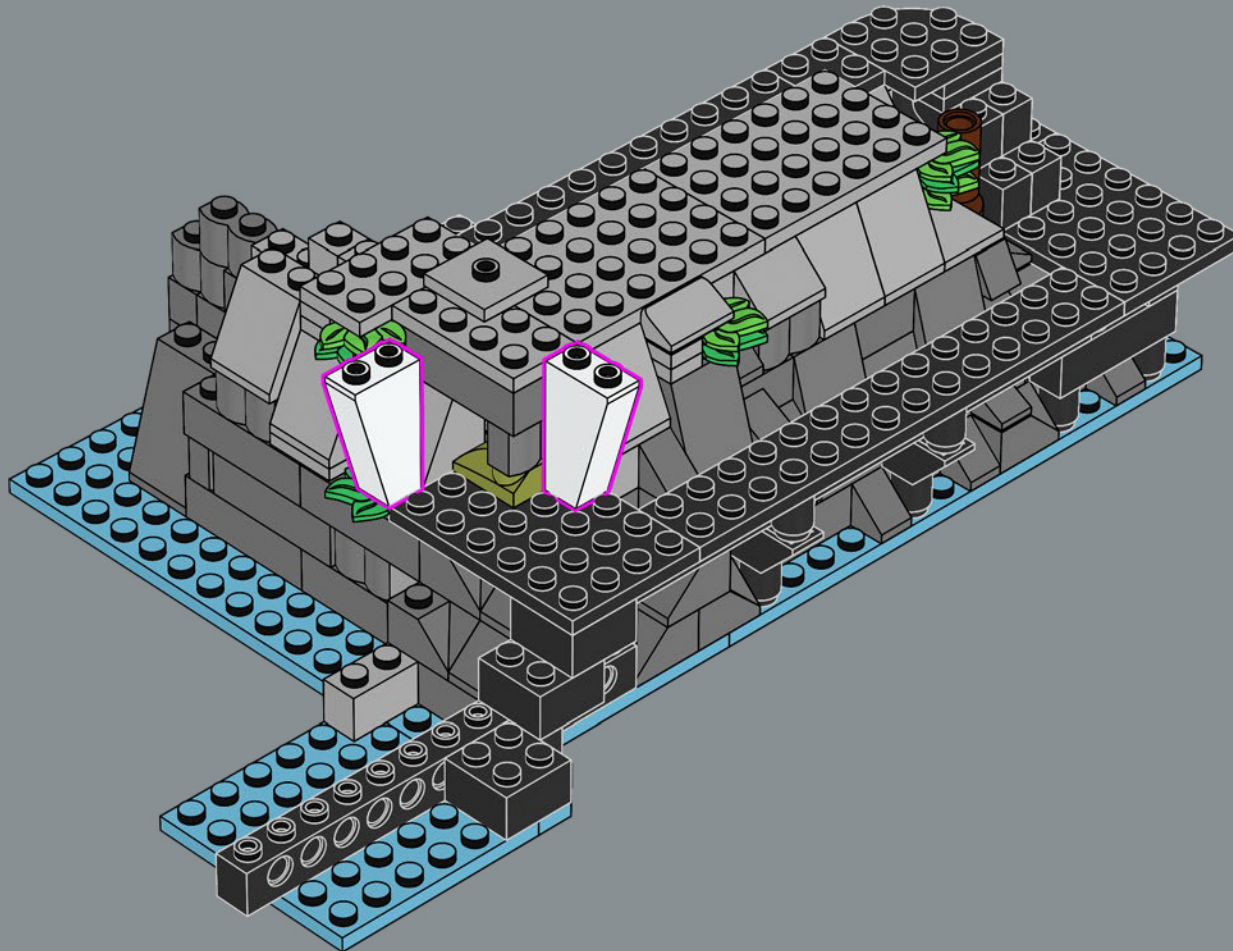

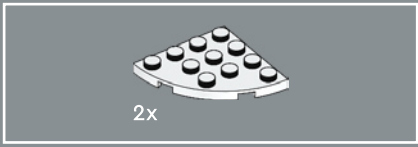

42

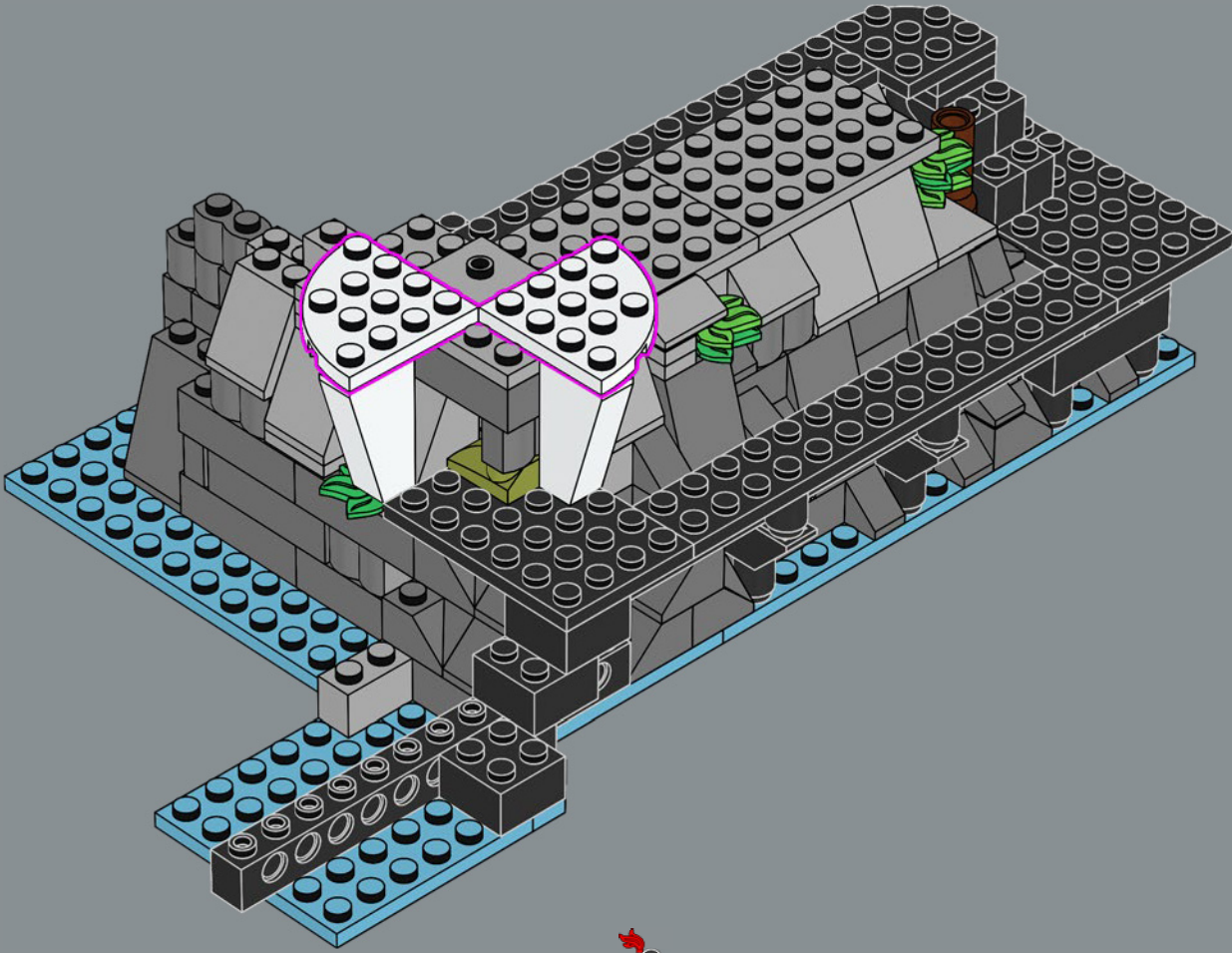

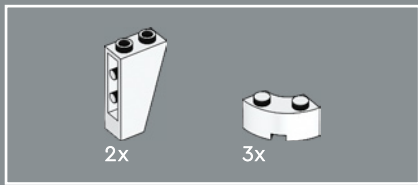

43

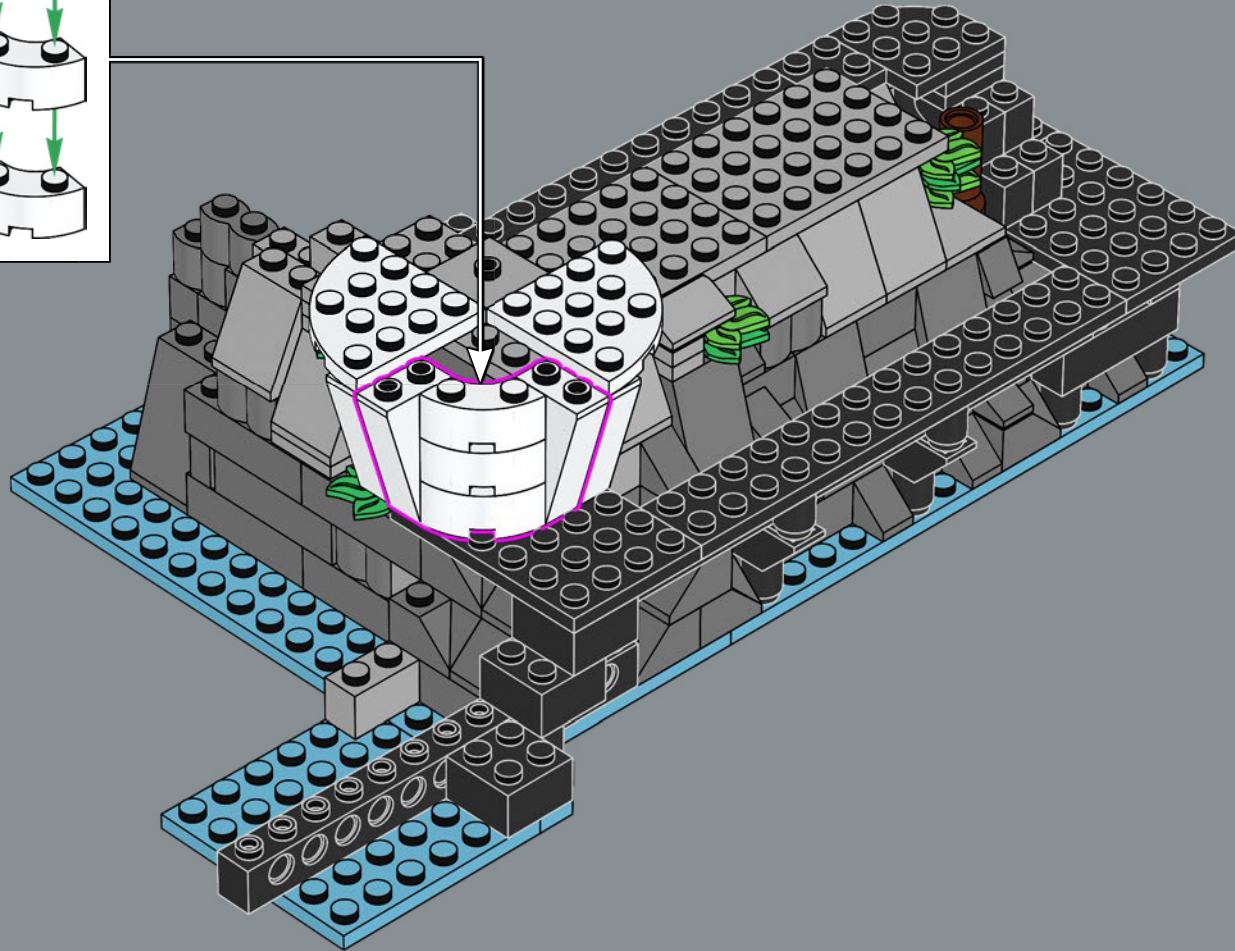
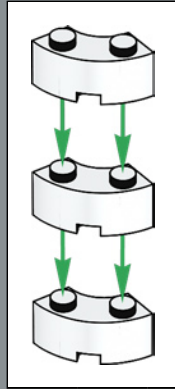



44

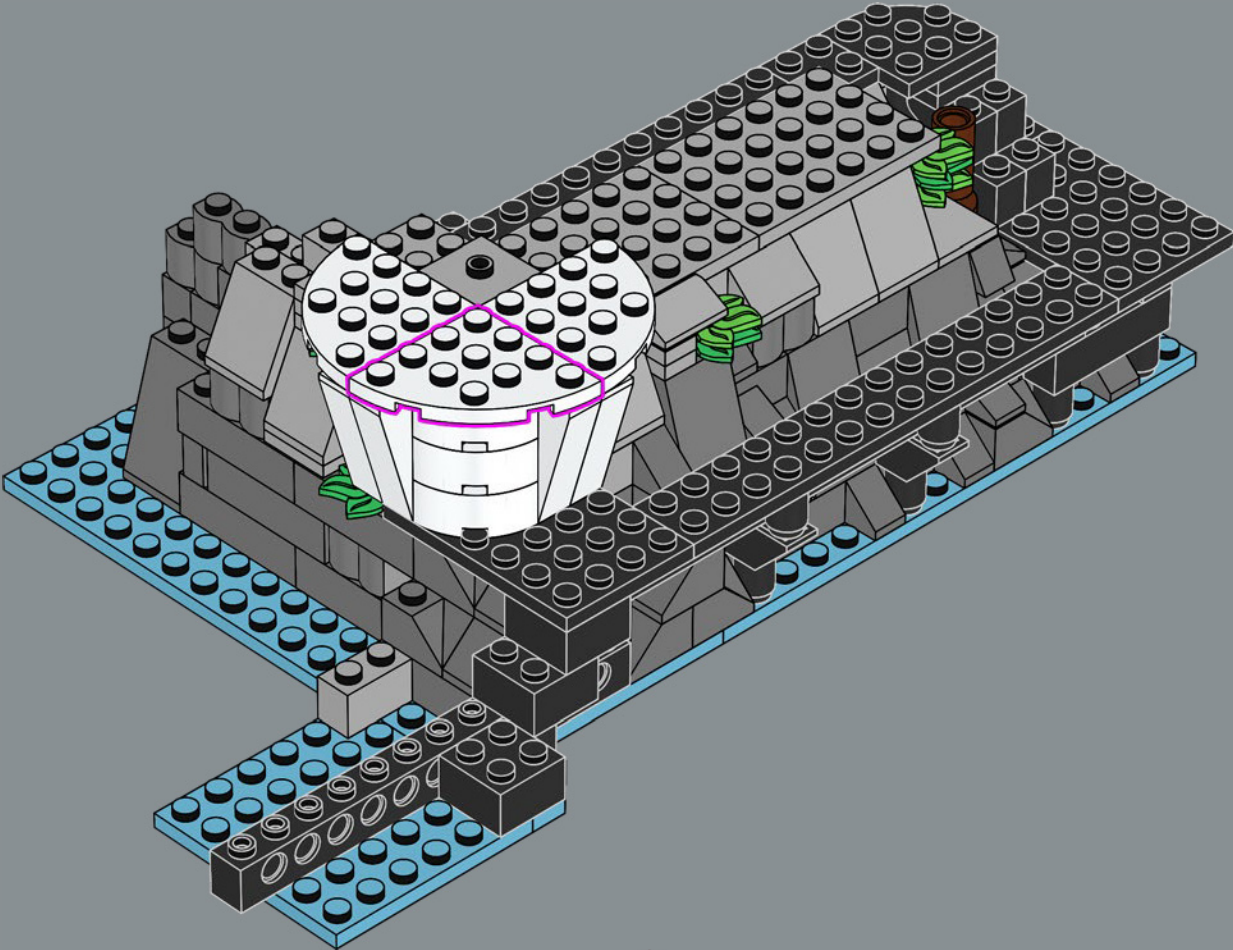

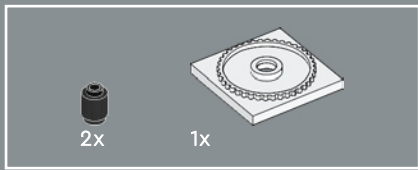

45

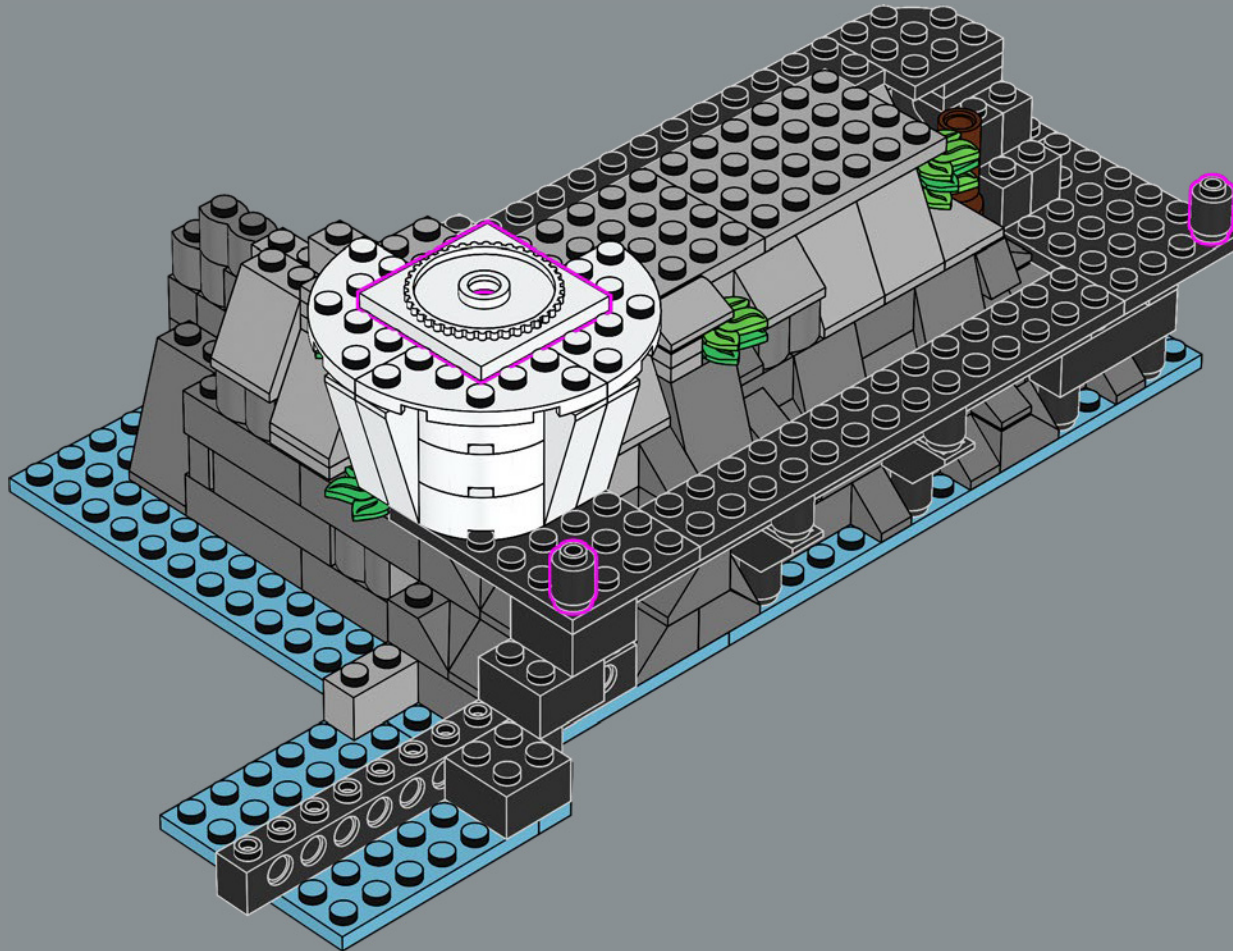

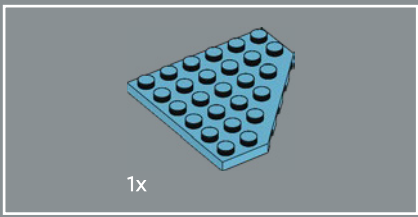

46

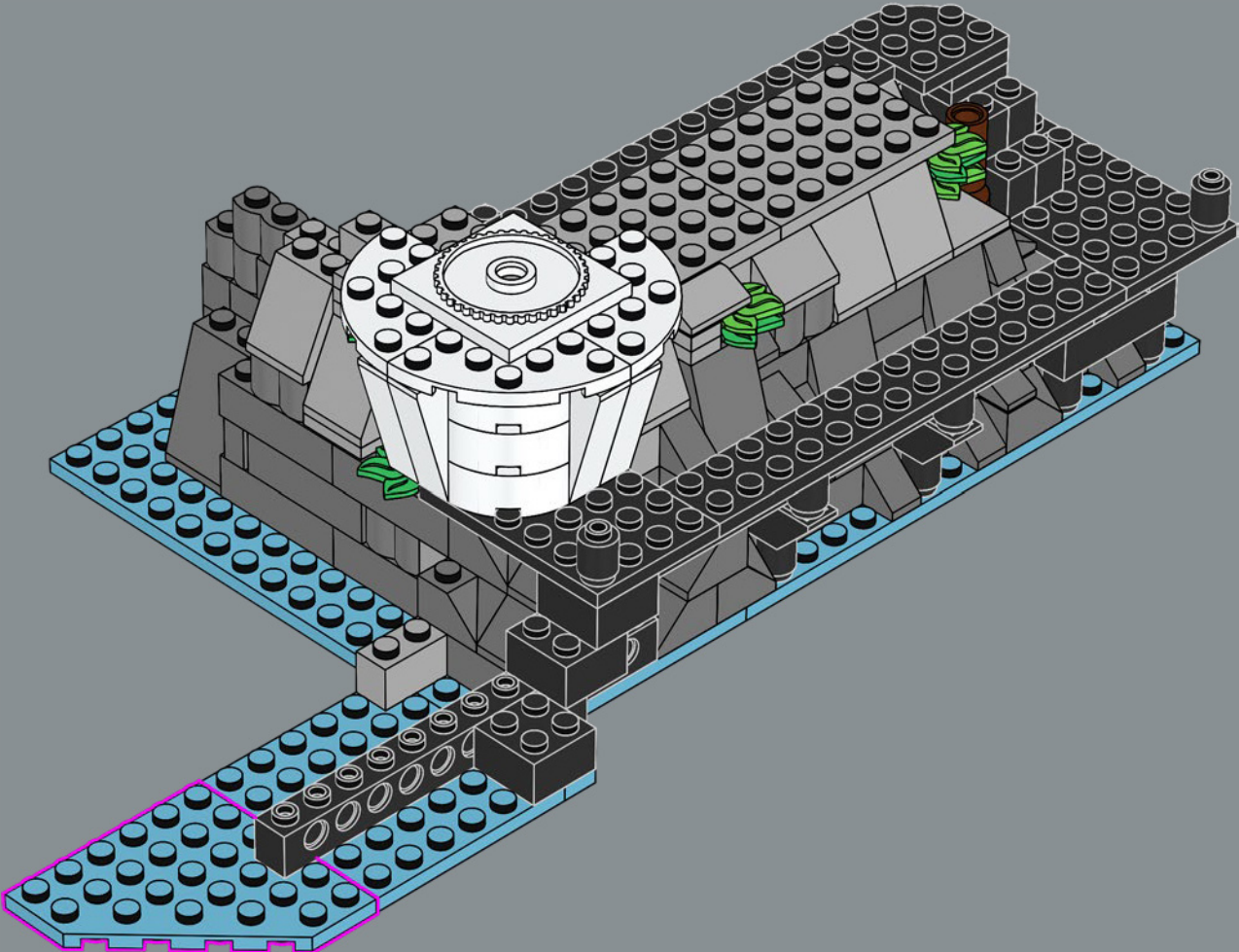

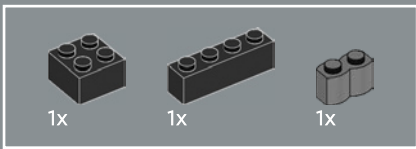

47

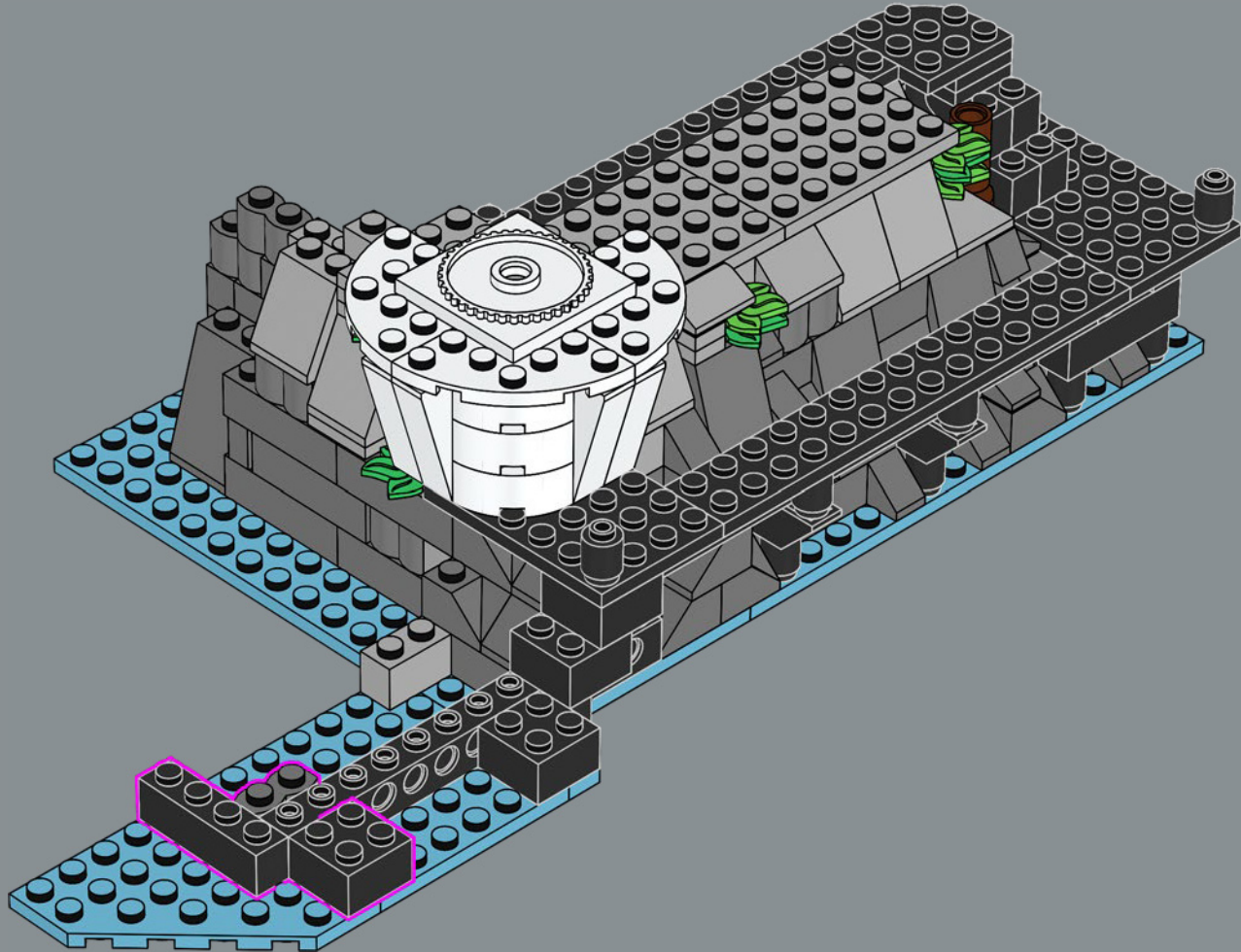

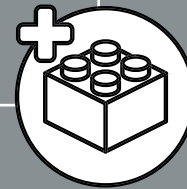
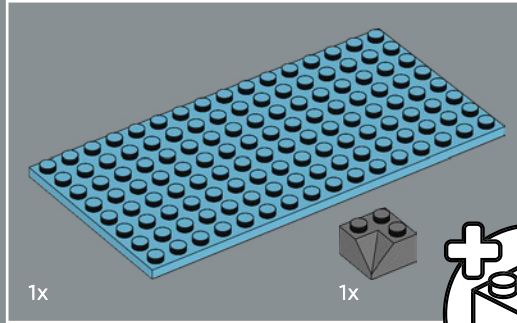
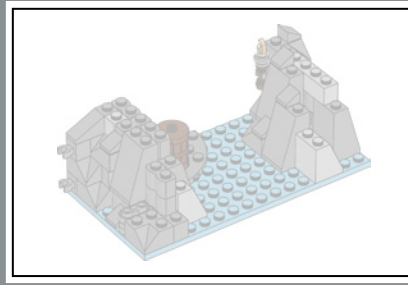
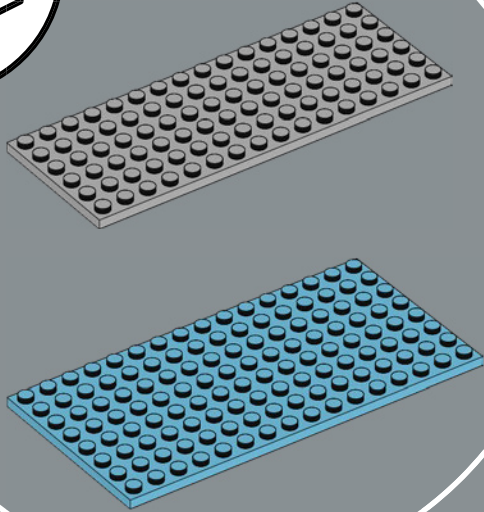
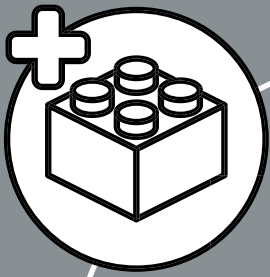

48

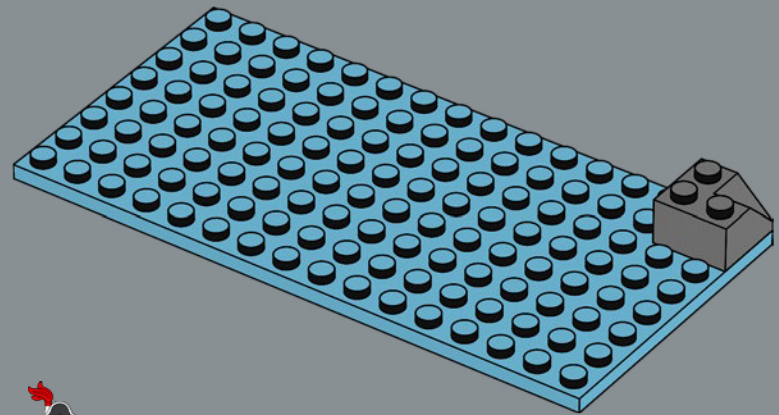



49

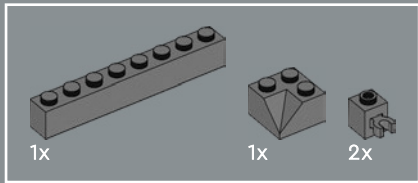
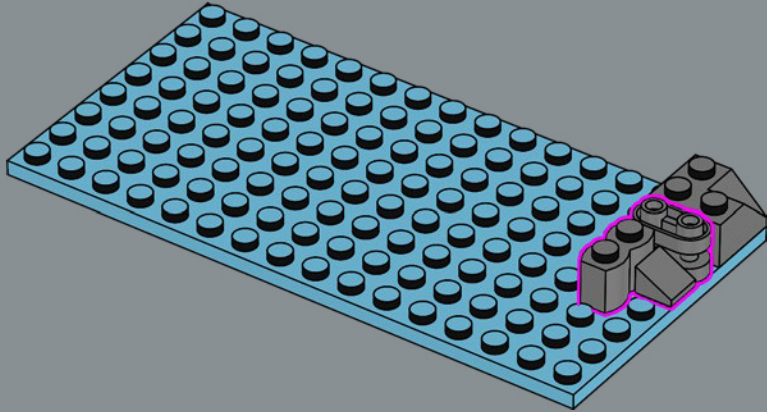

50

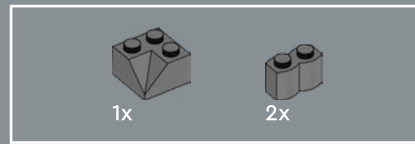
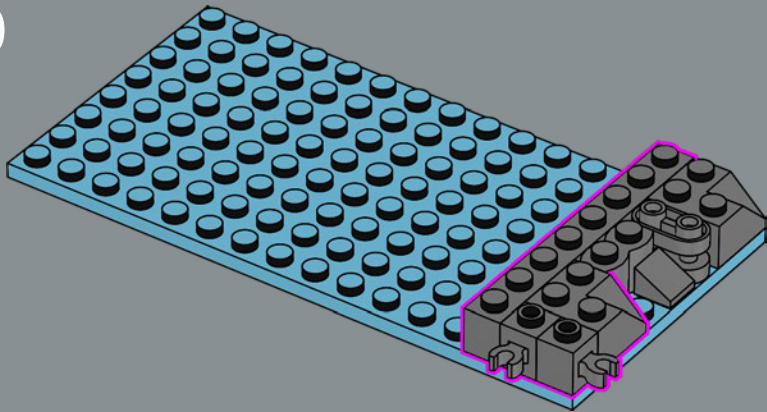

51

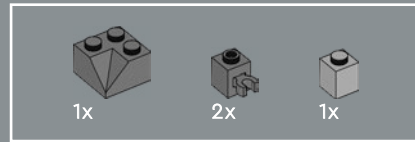
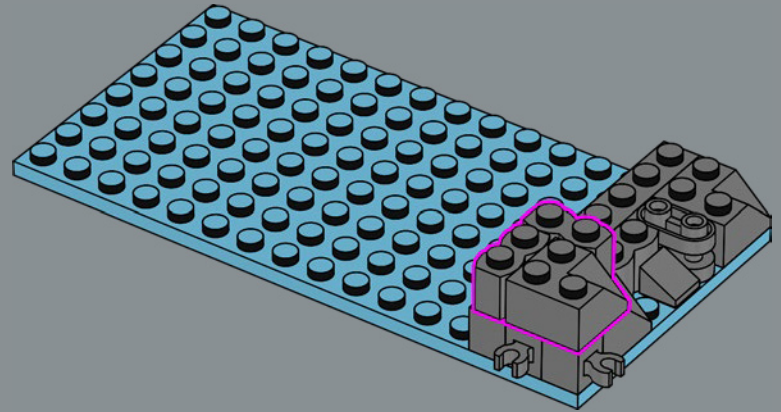

52

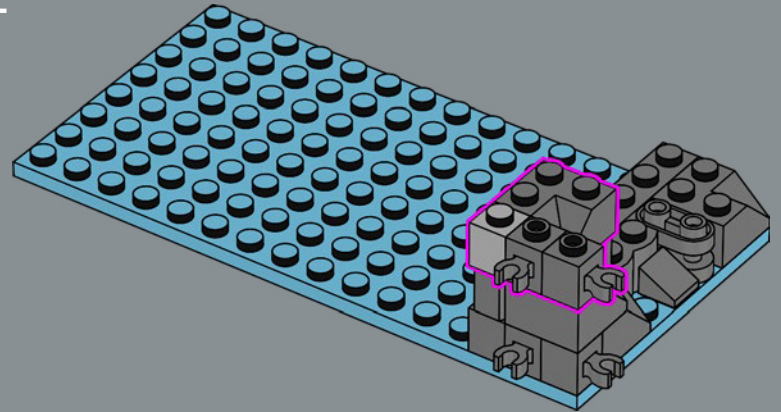

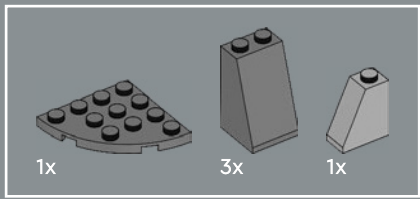

53

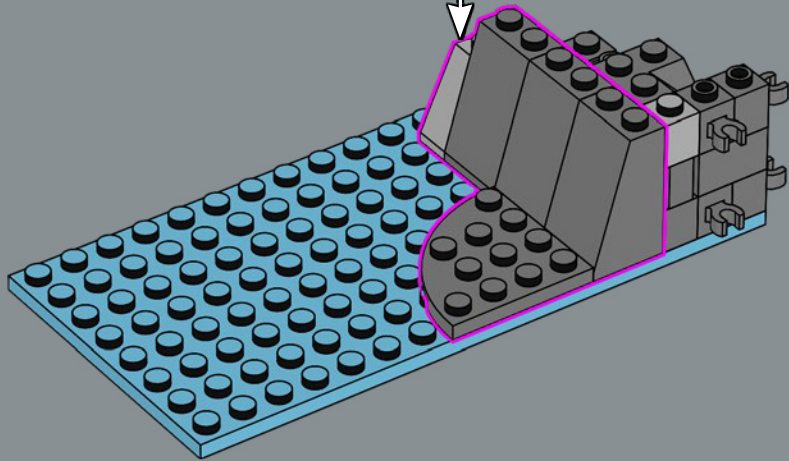
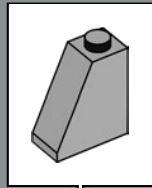

54

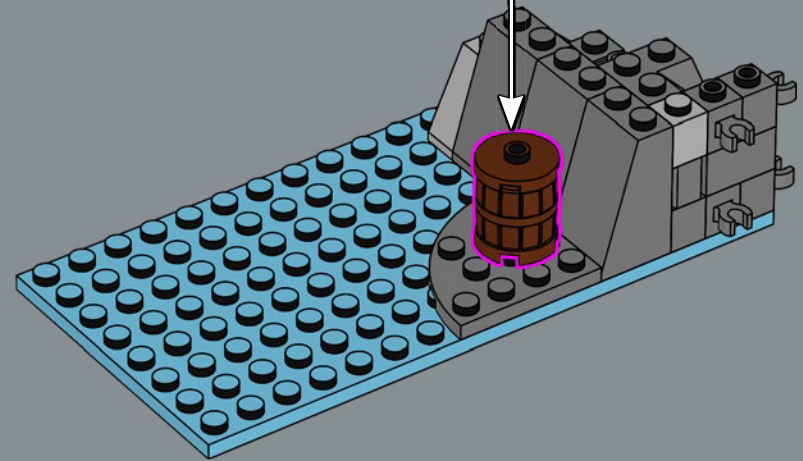
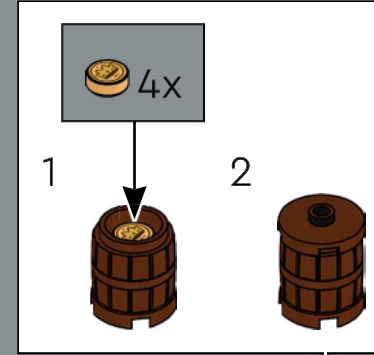

Los doblones de oro están bien escondidos en un lugar donde nadie podrá encontrarlos.



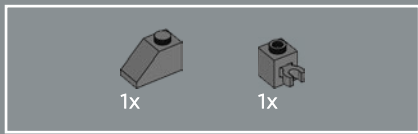

55

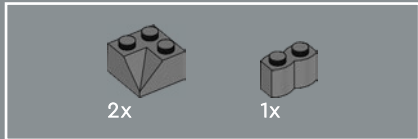
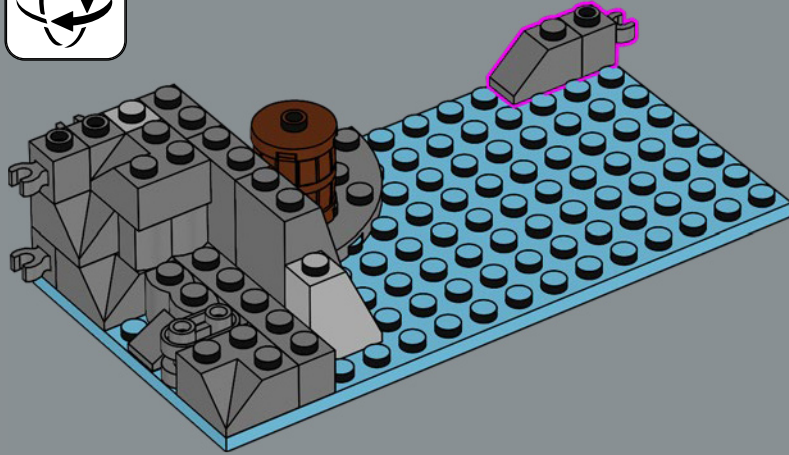

56

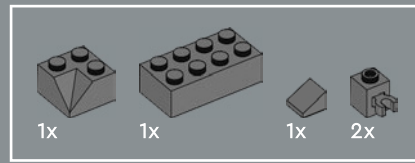
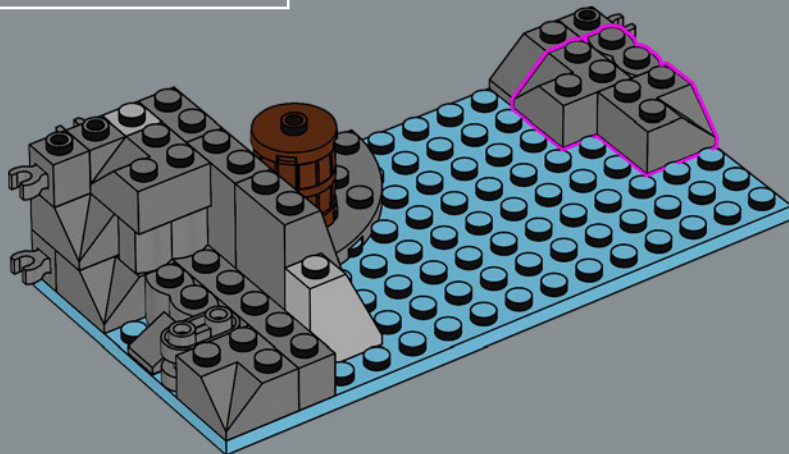

57

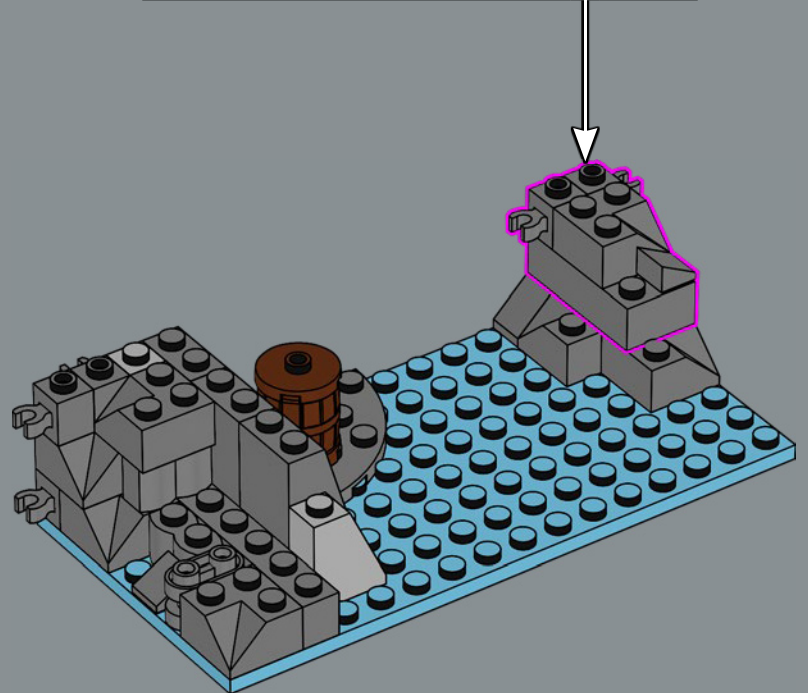
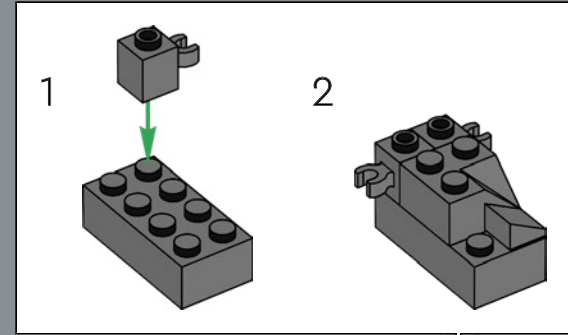

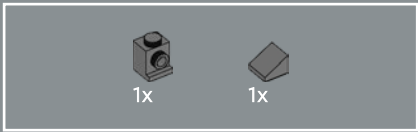

58

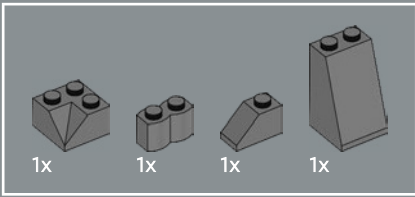
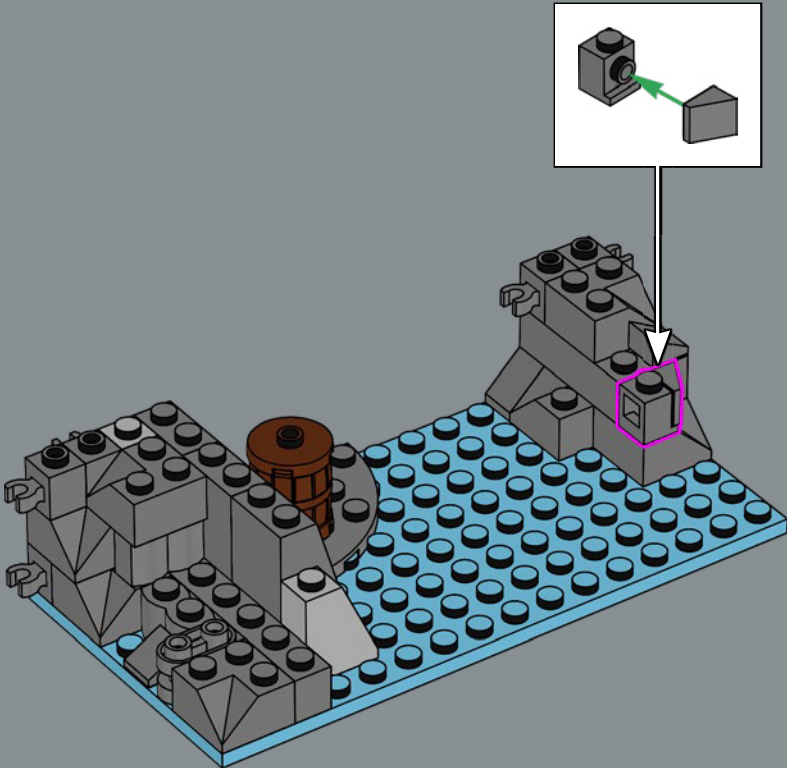
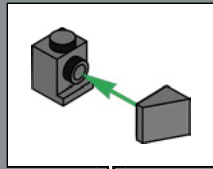

59

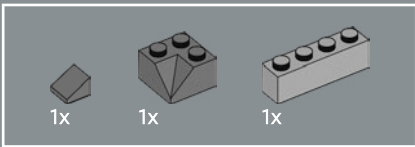
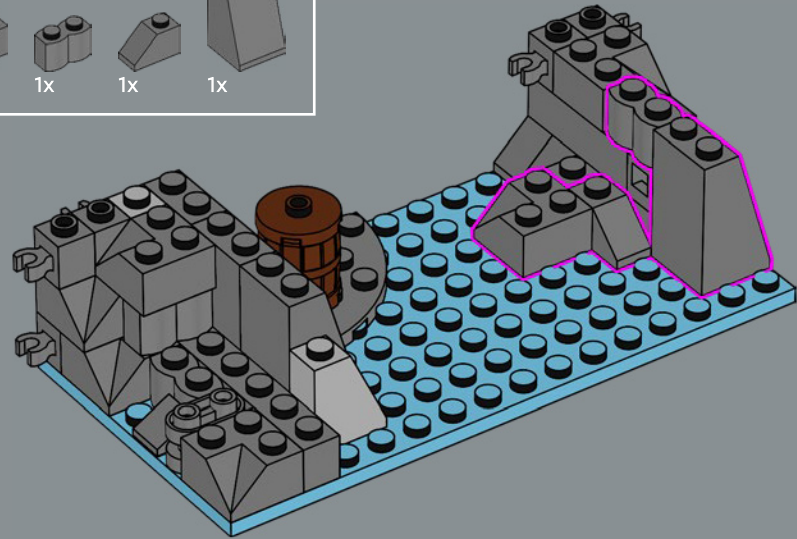

60

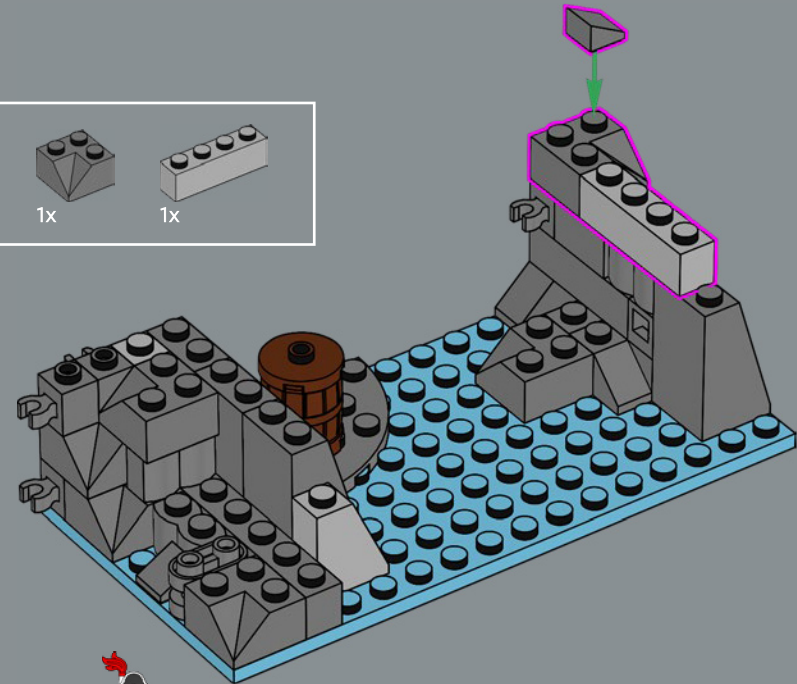

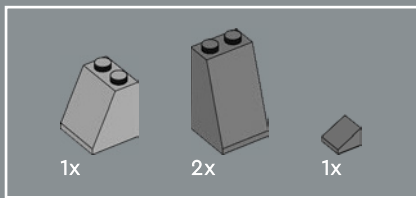

61

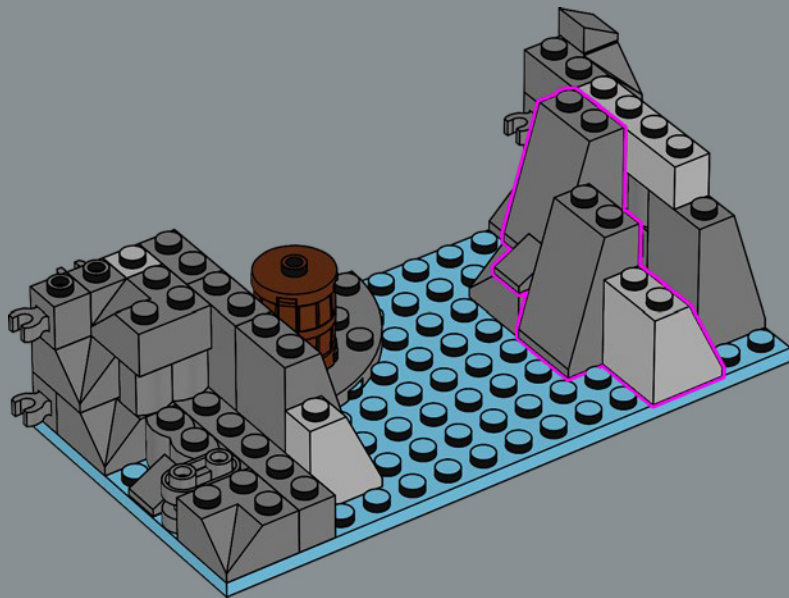

62

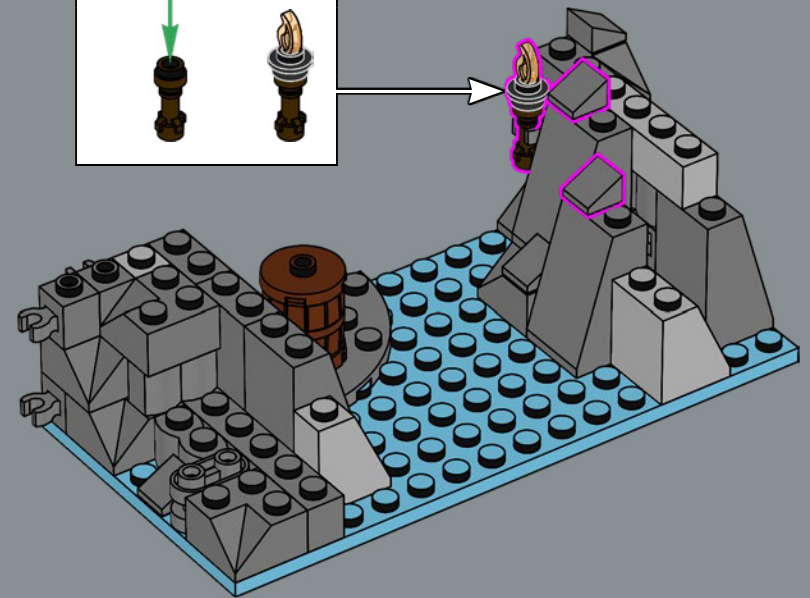
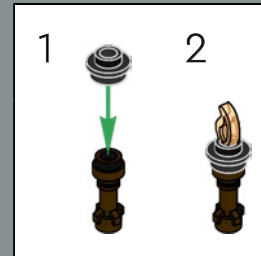

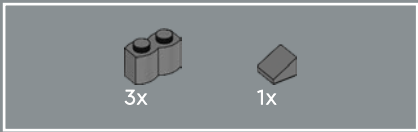

63

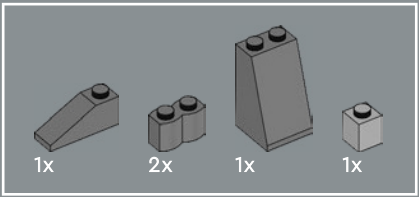
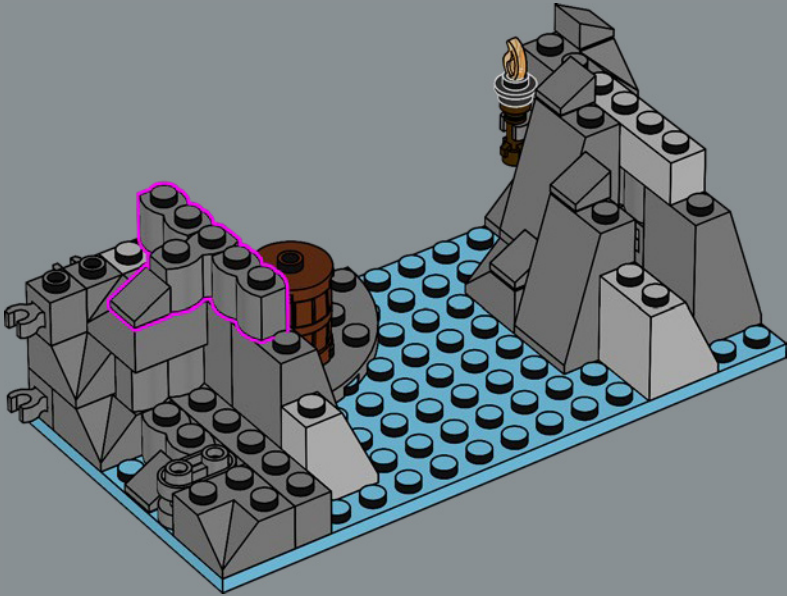

64

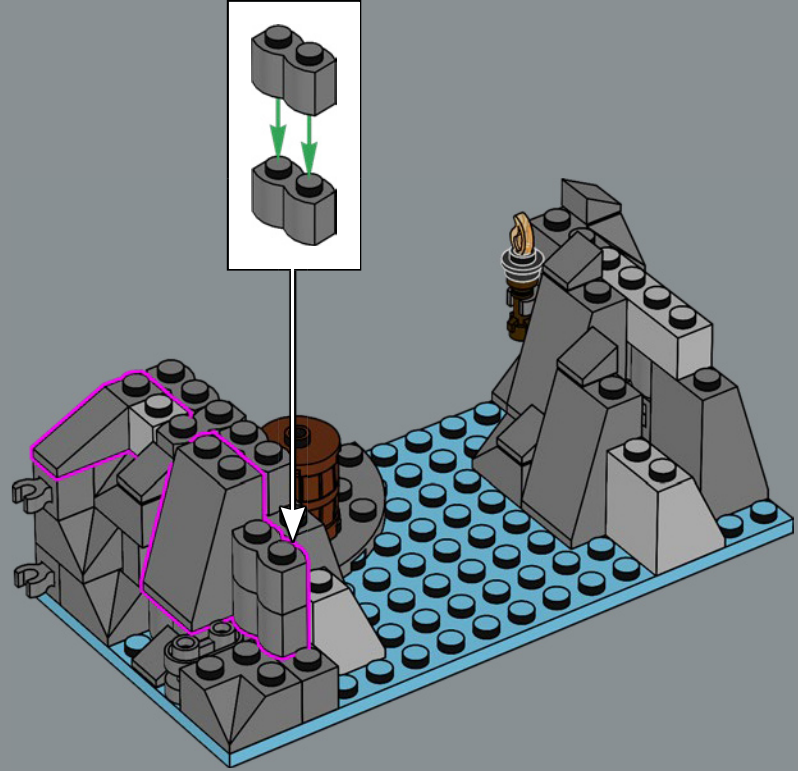

65

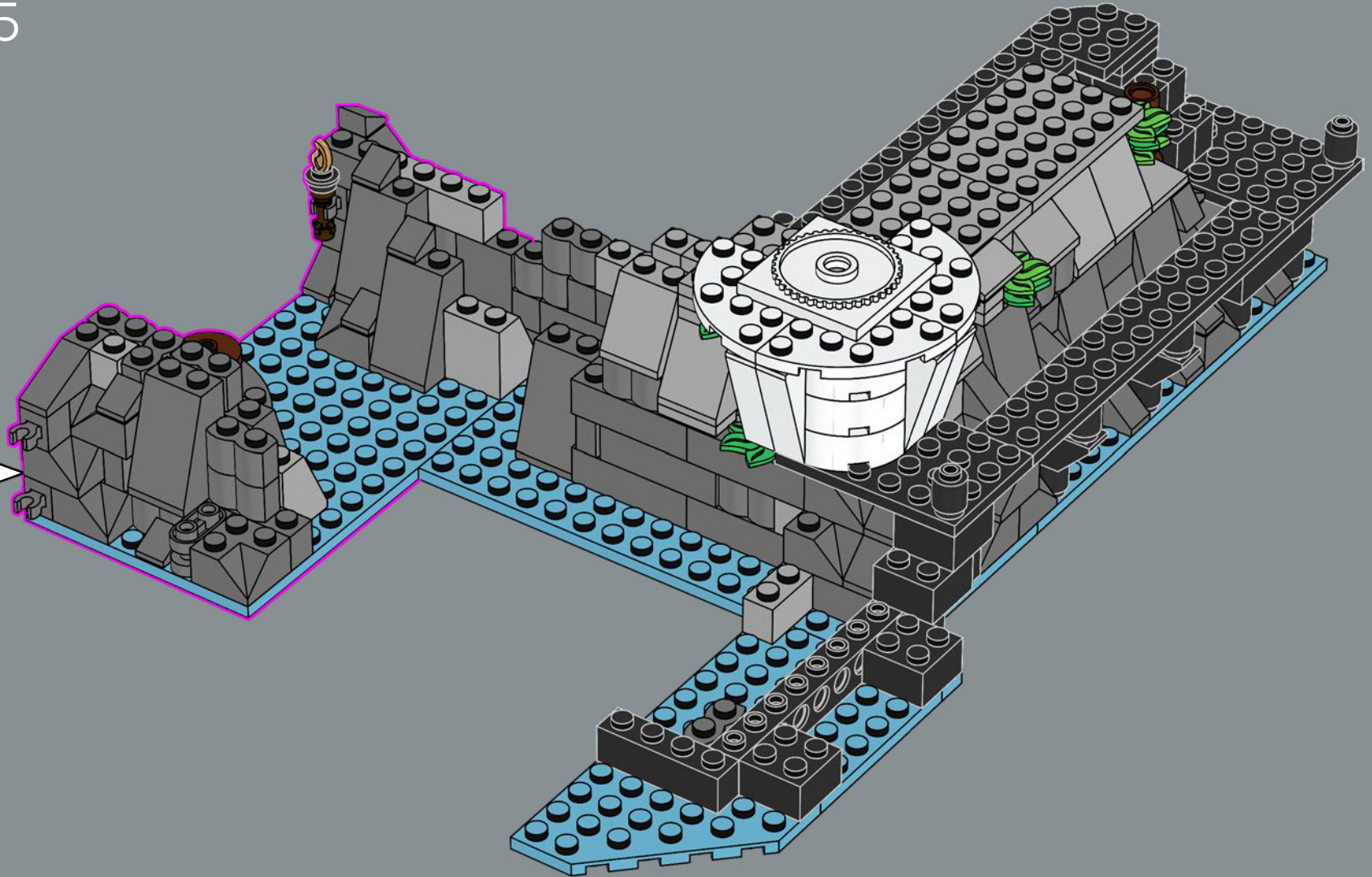

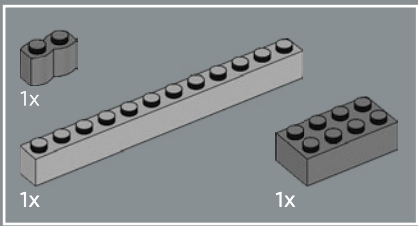

66

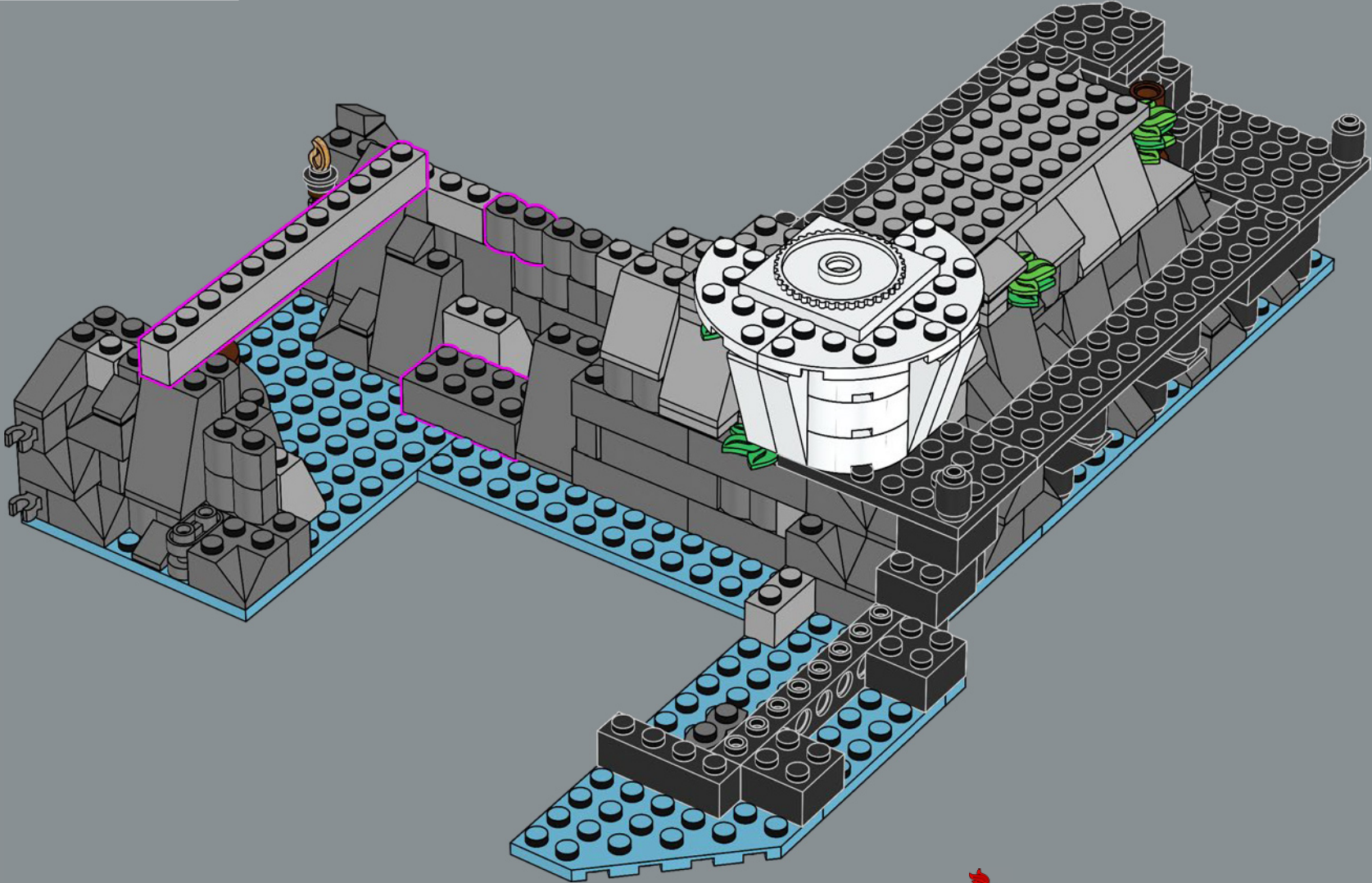

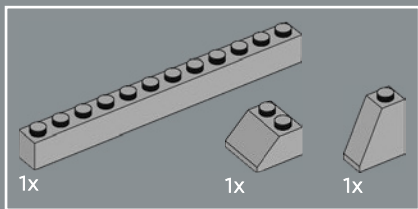

67

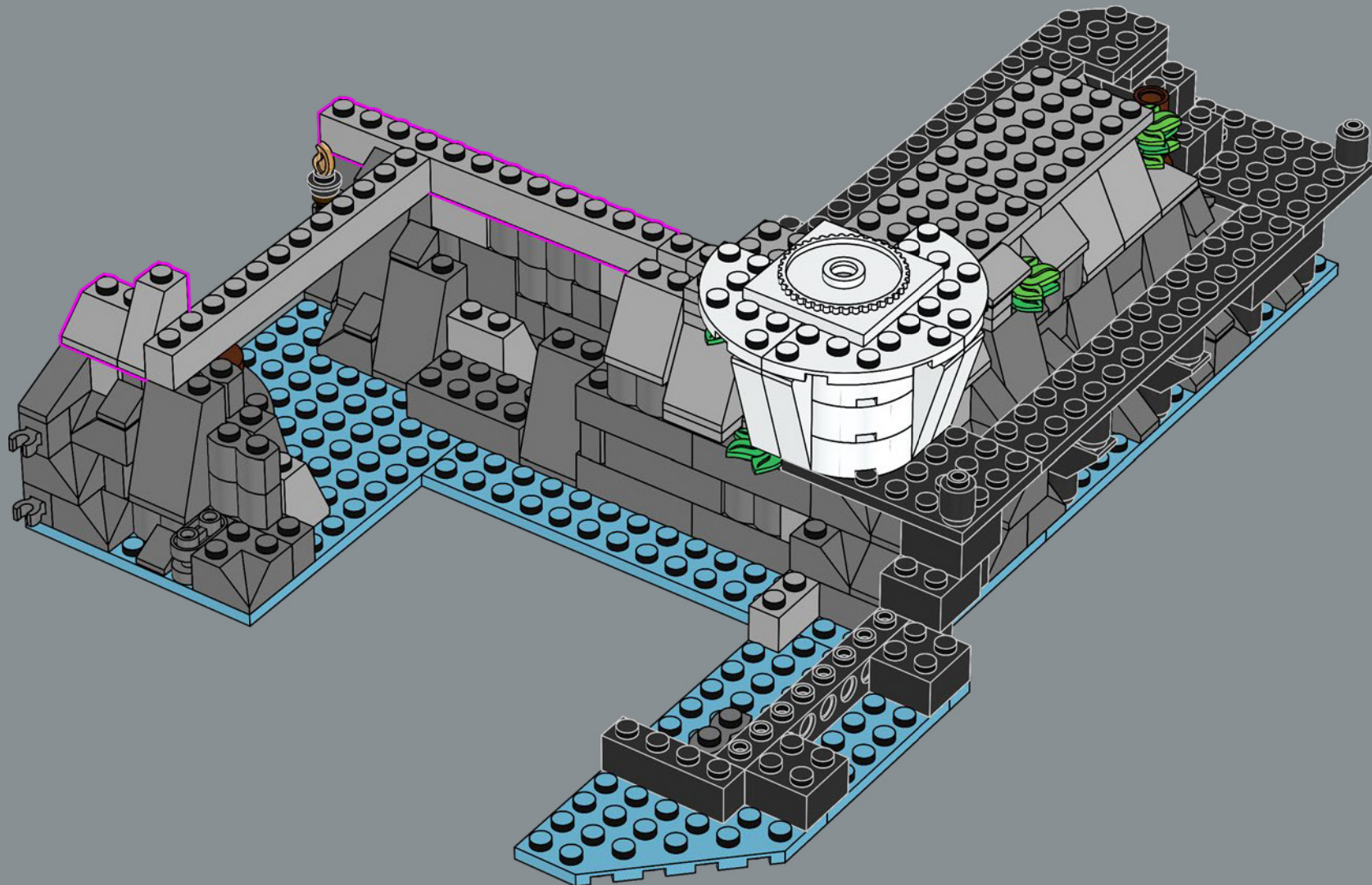

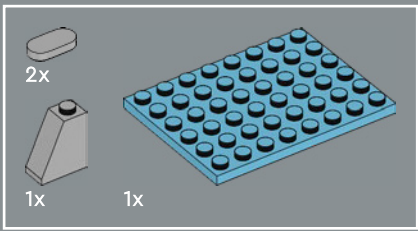

68

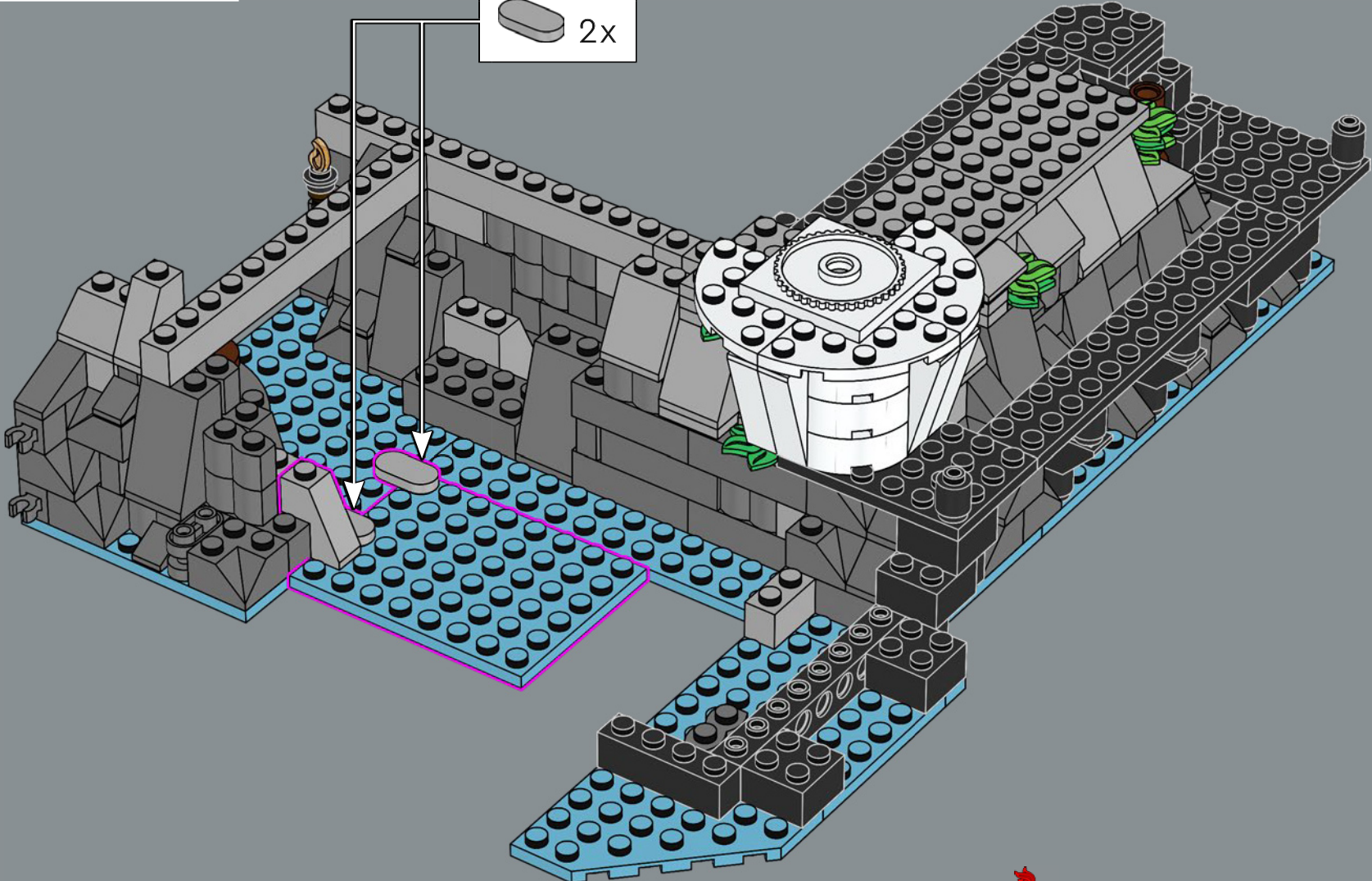

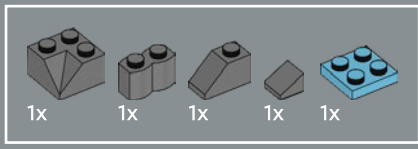

69

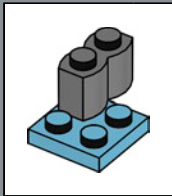
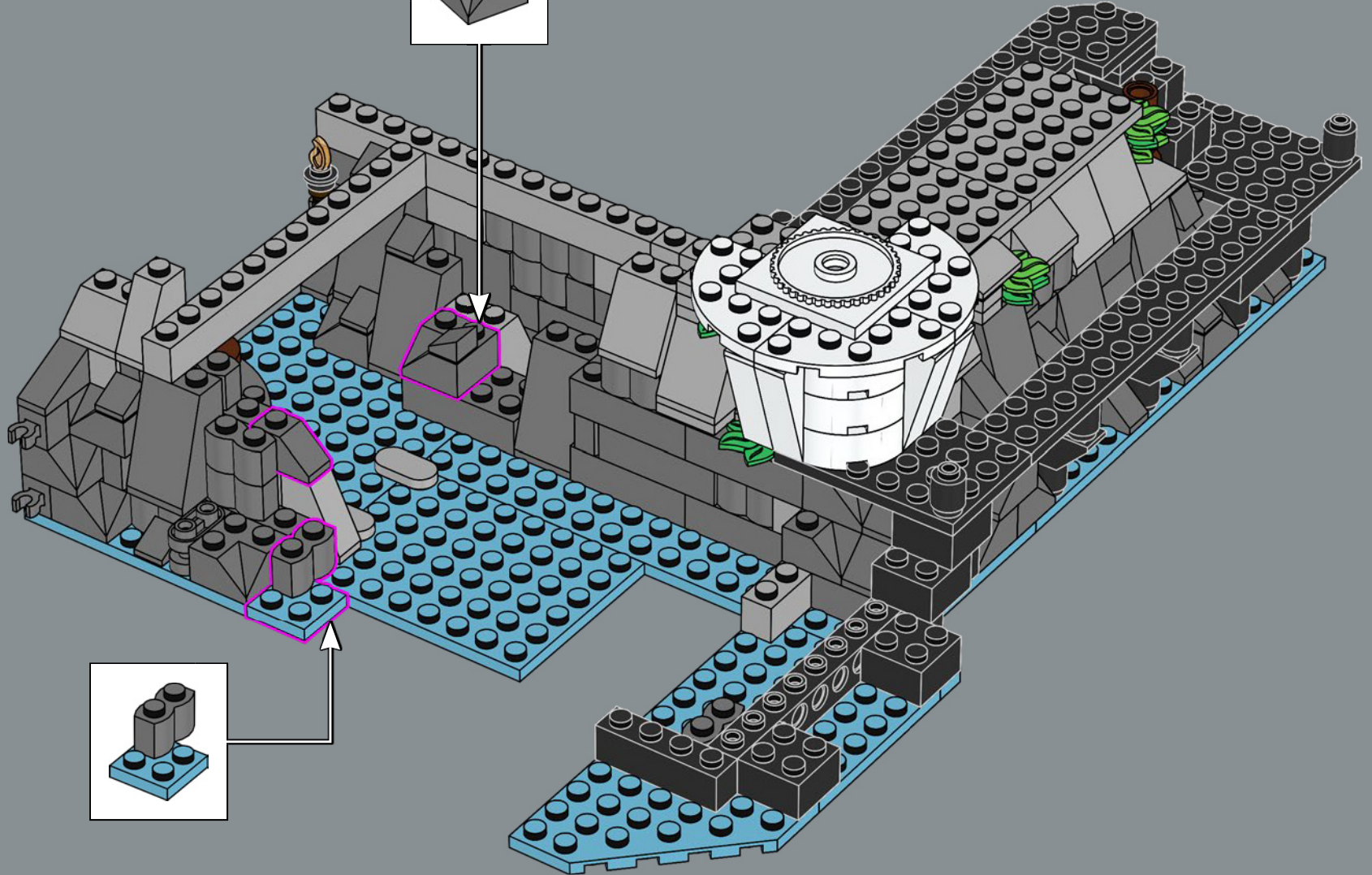
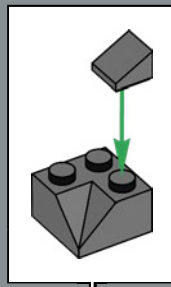

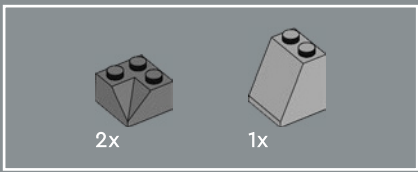

70

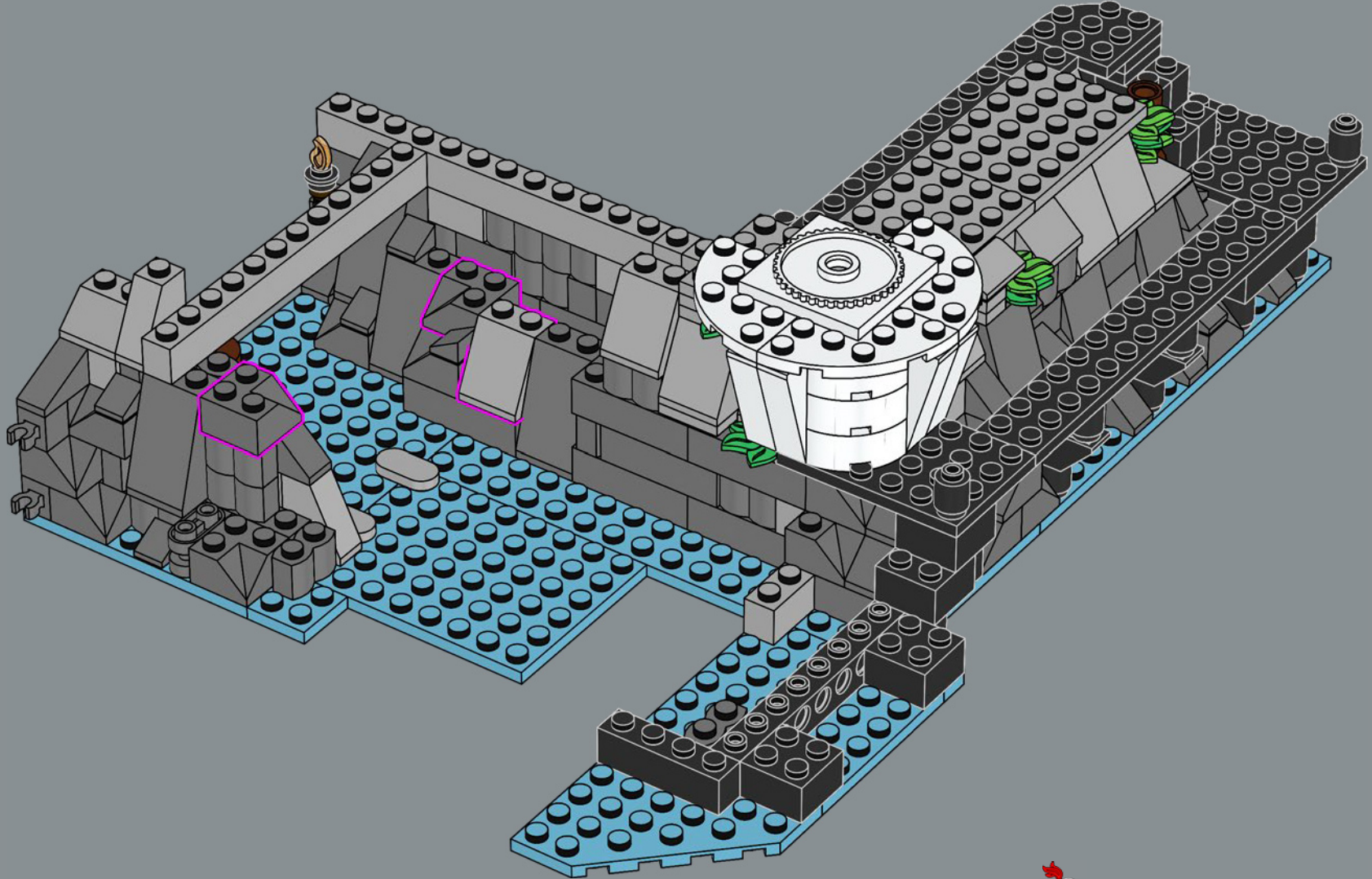

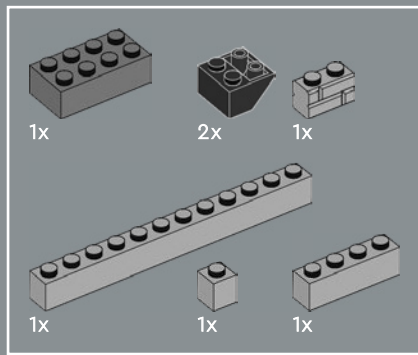

71

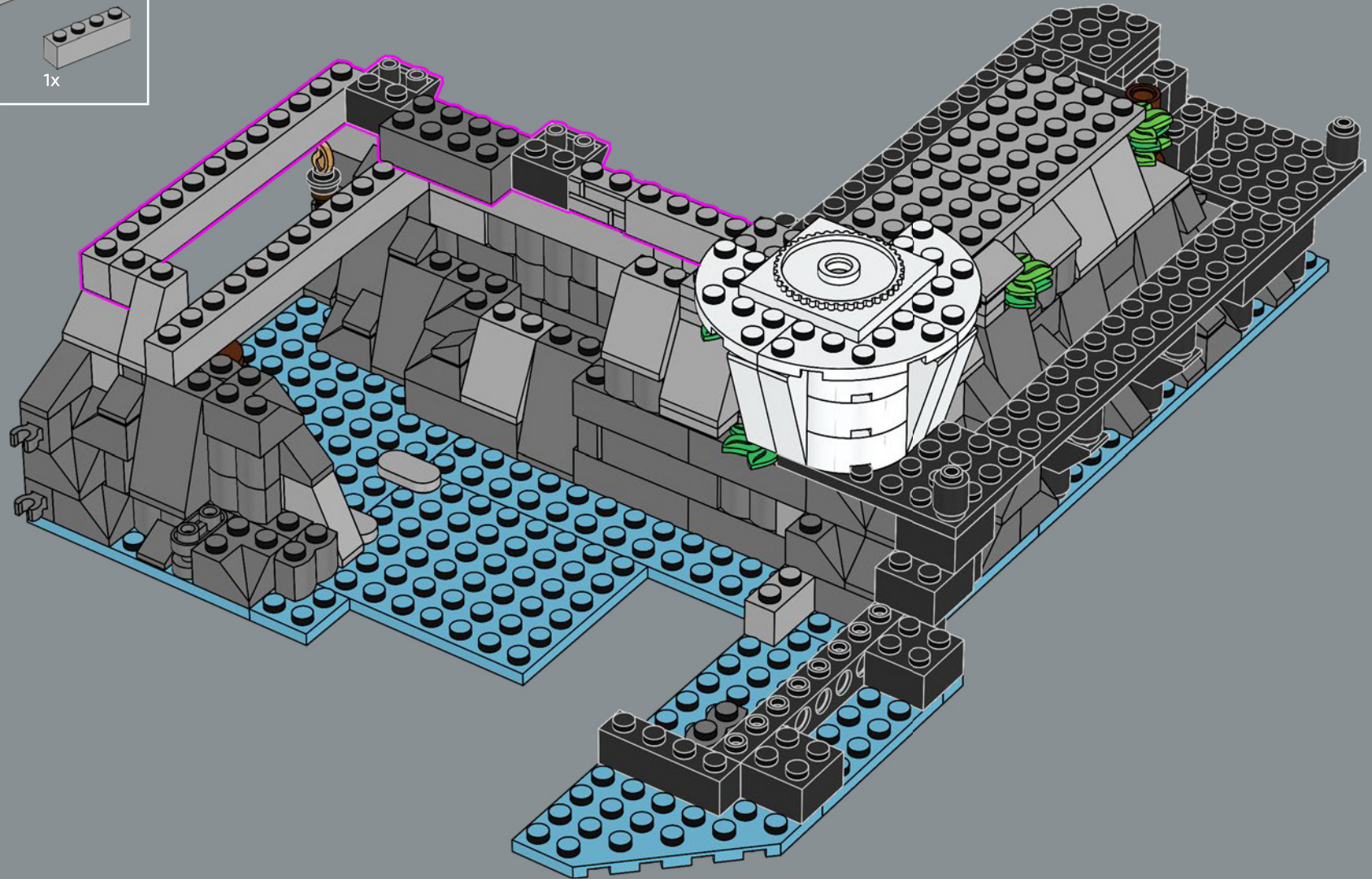

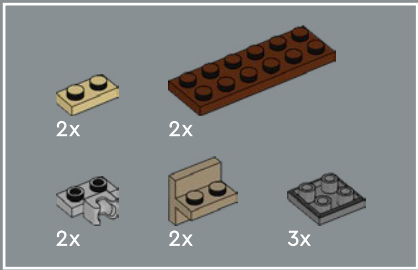

72

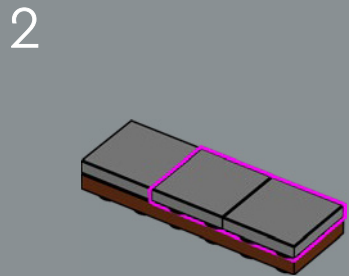
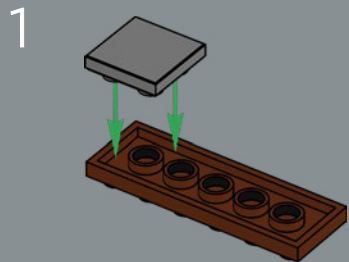

3

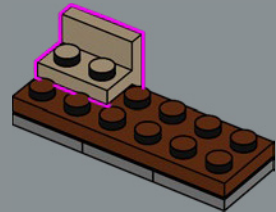

4

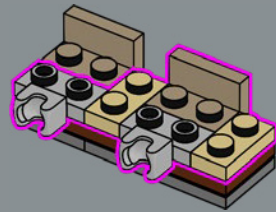

5

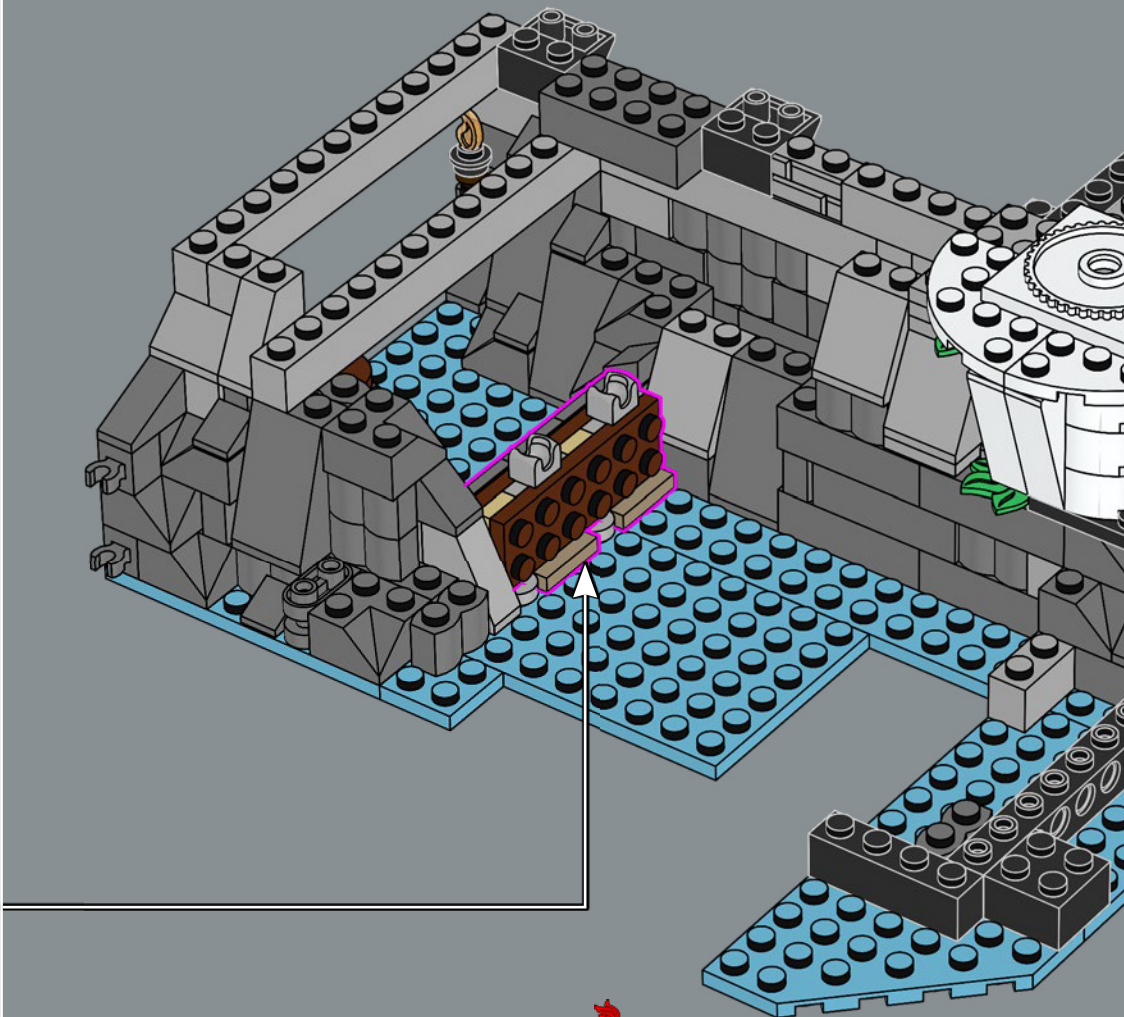
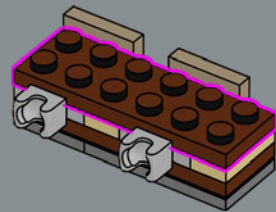

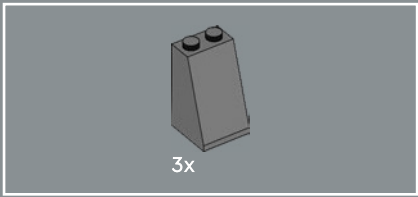

73

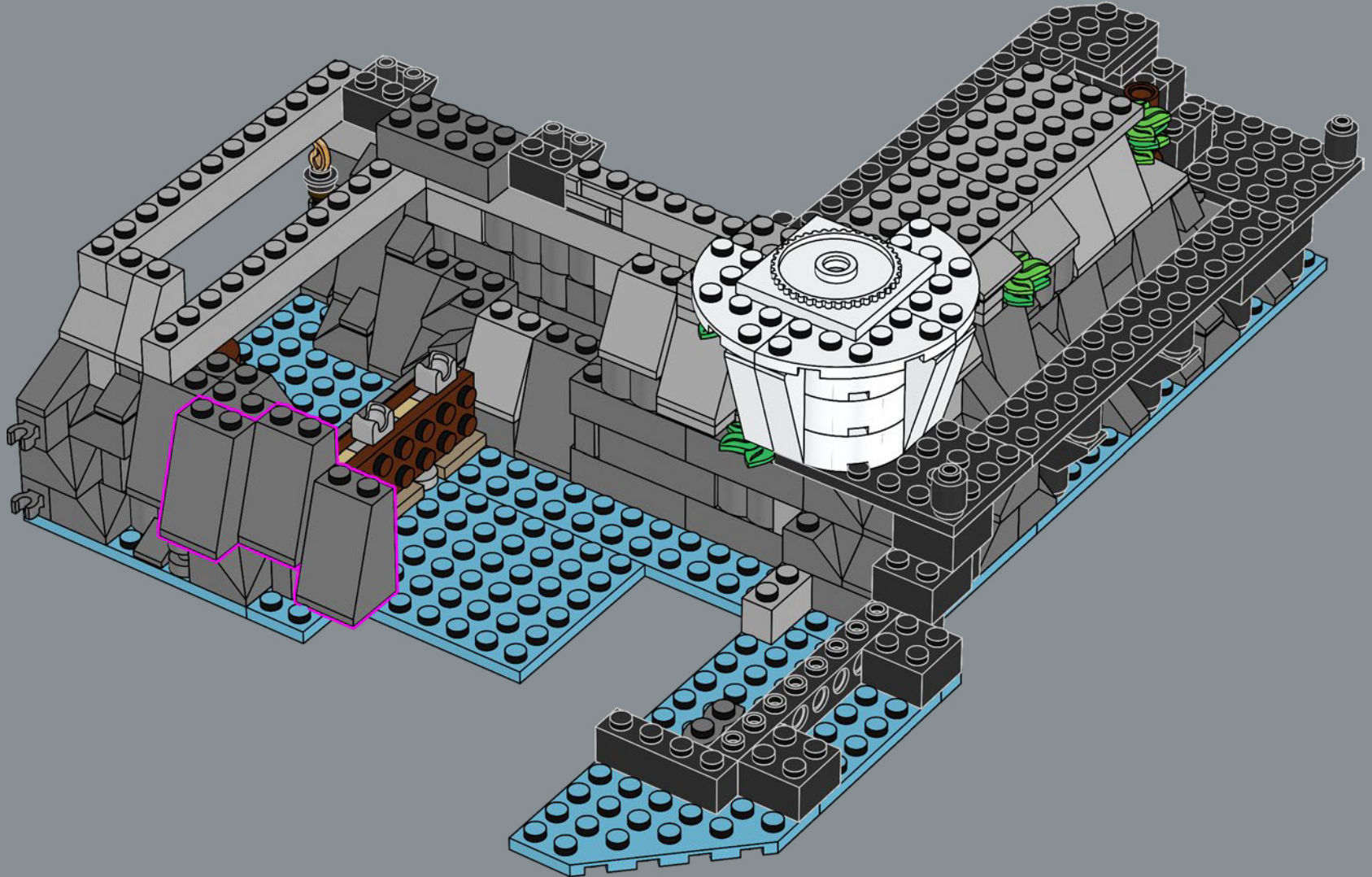

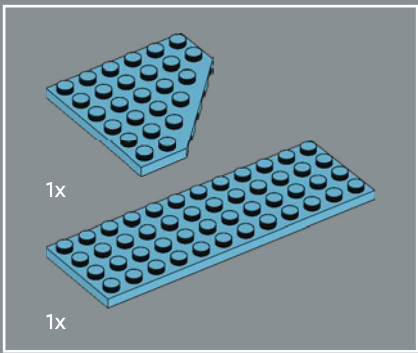

74

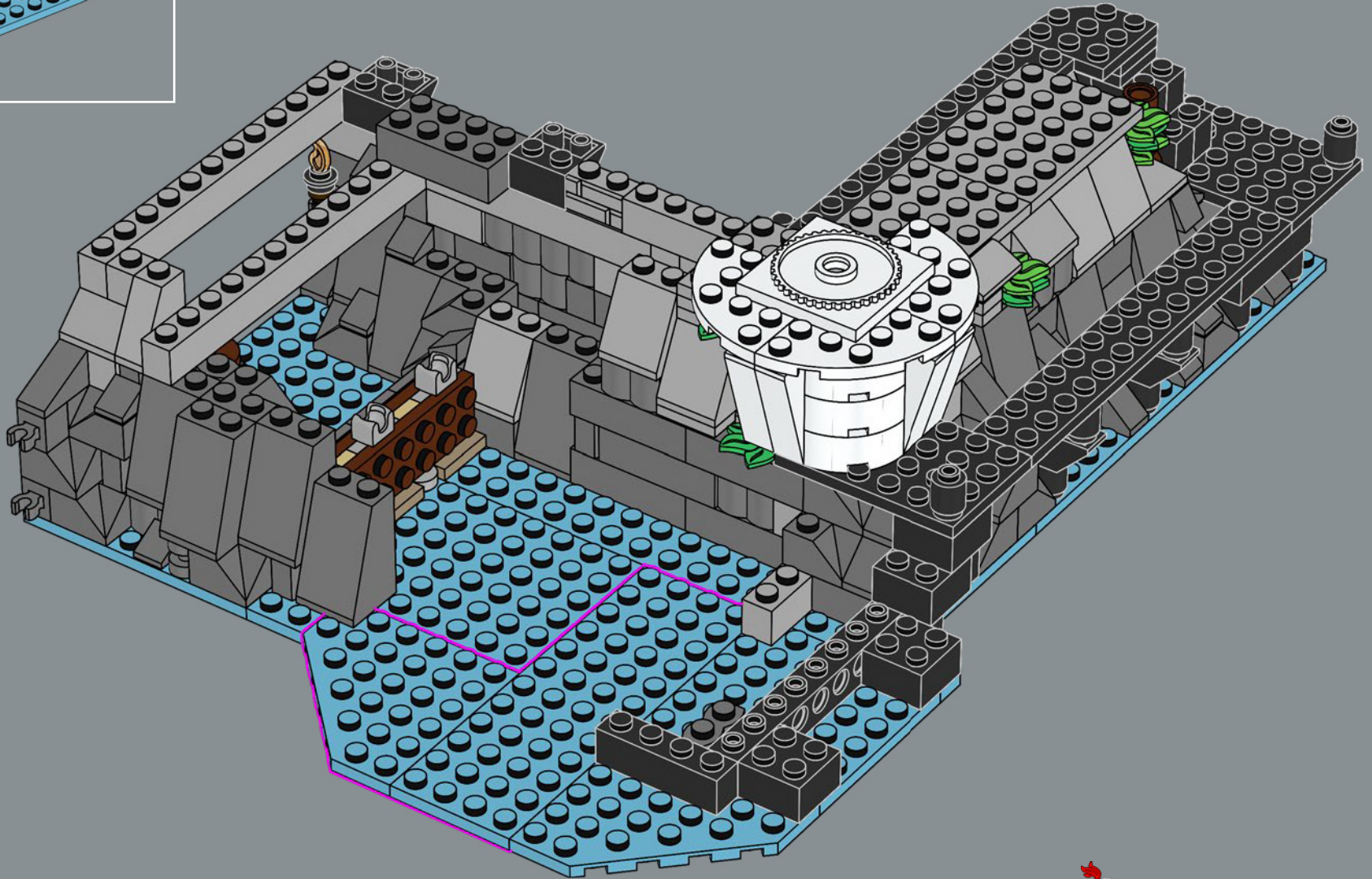

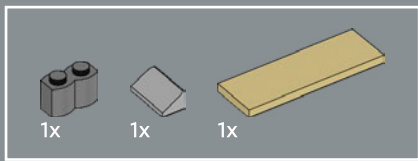

75

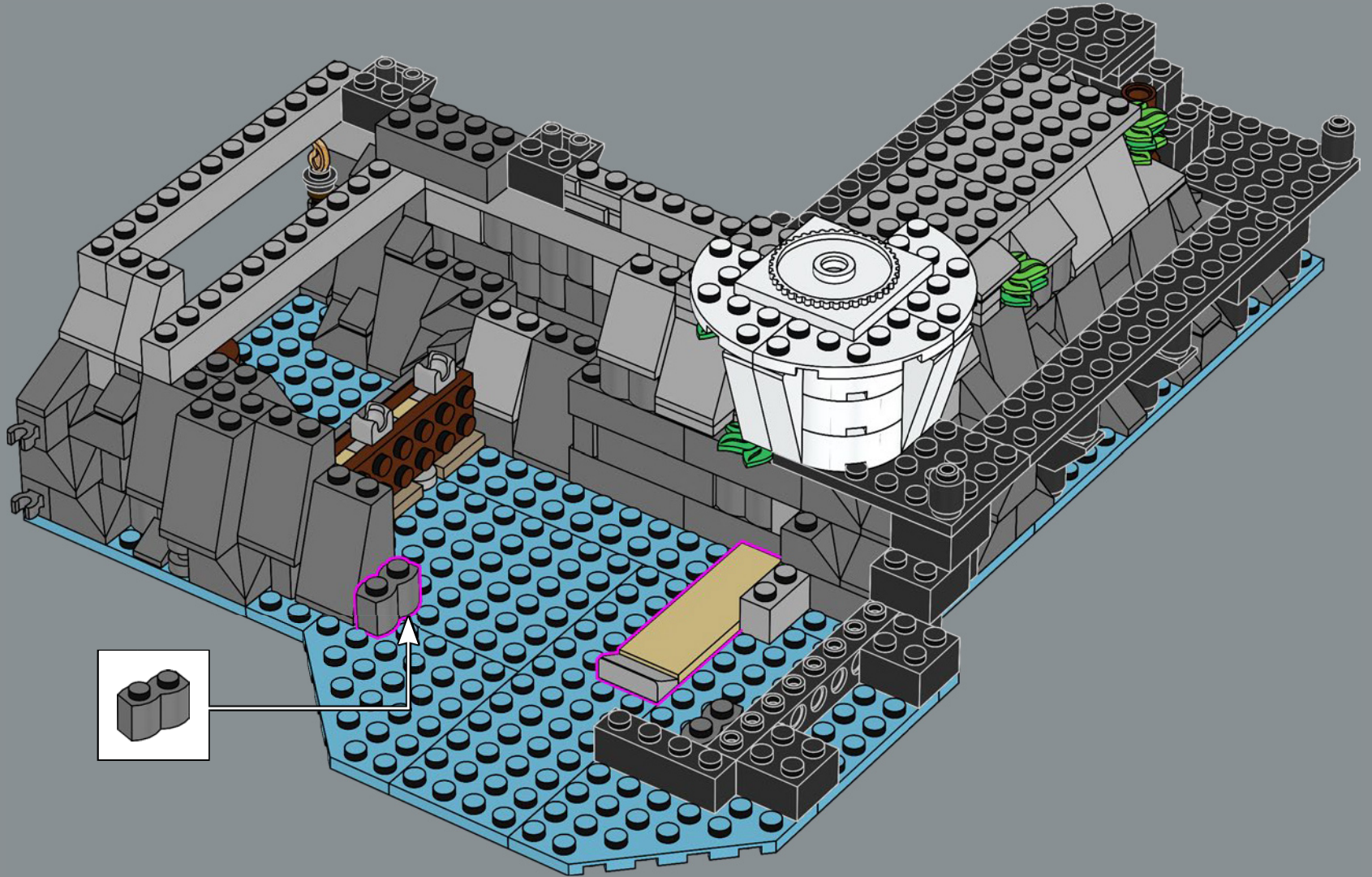

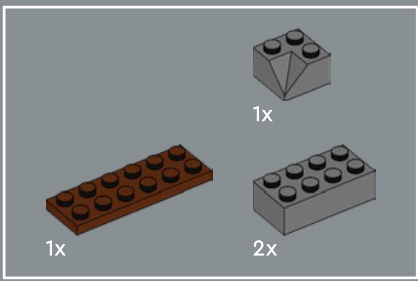

76

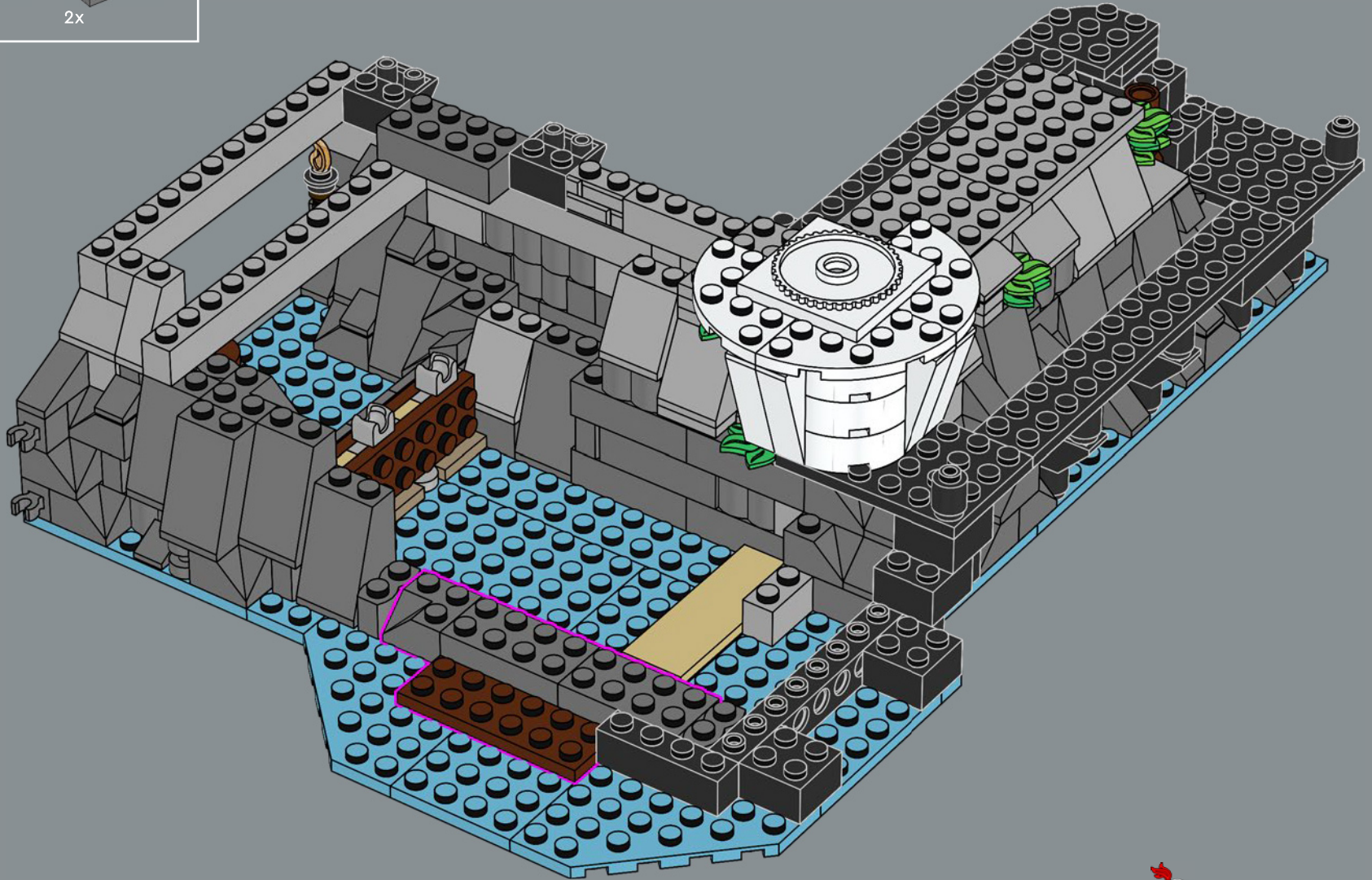

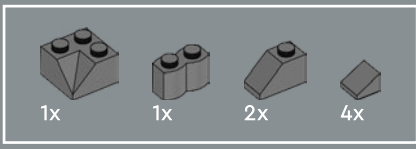

77

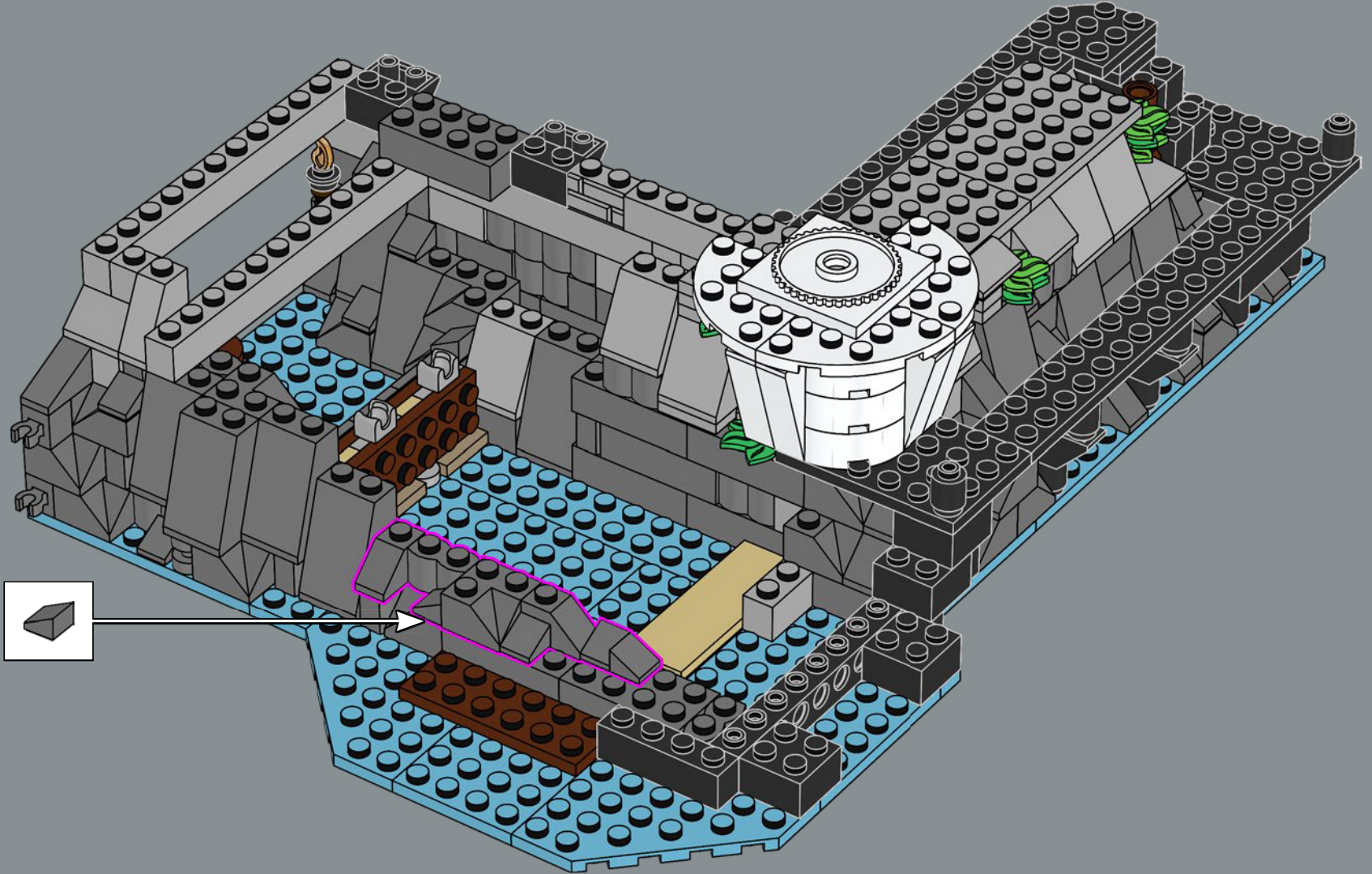

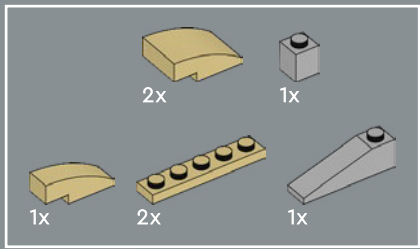

78

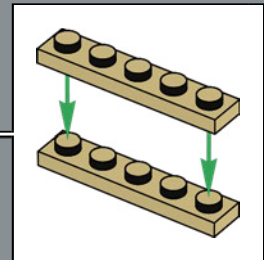
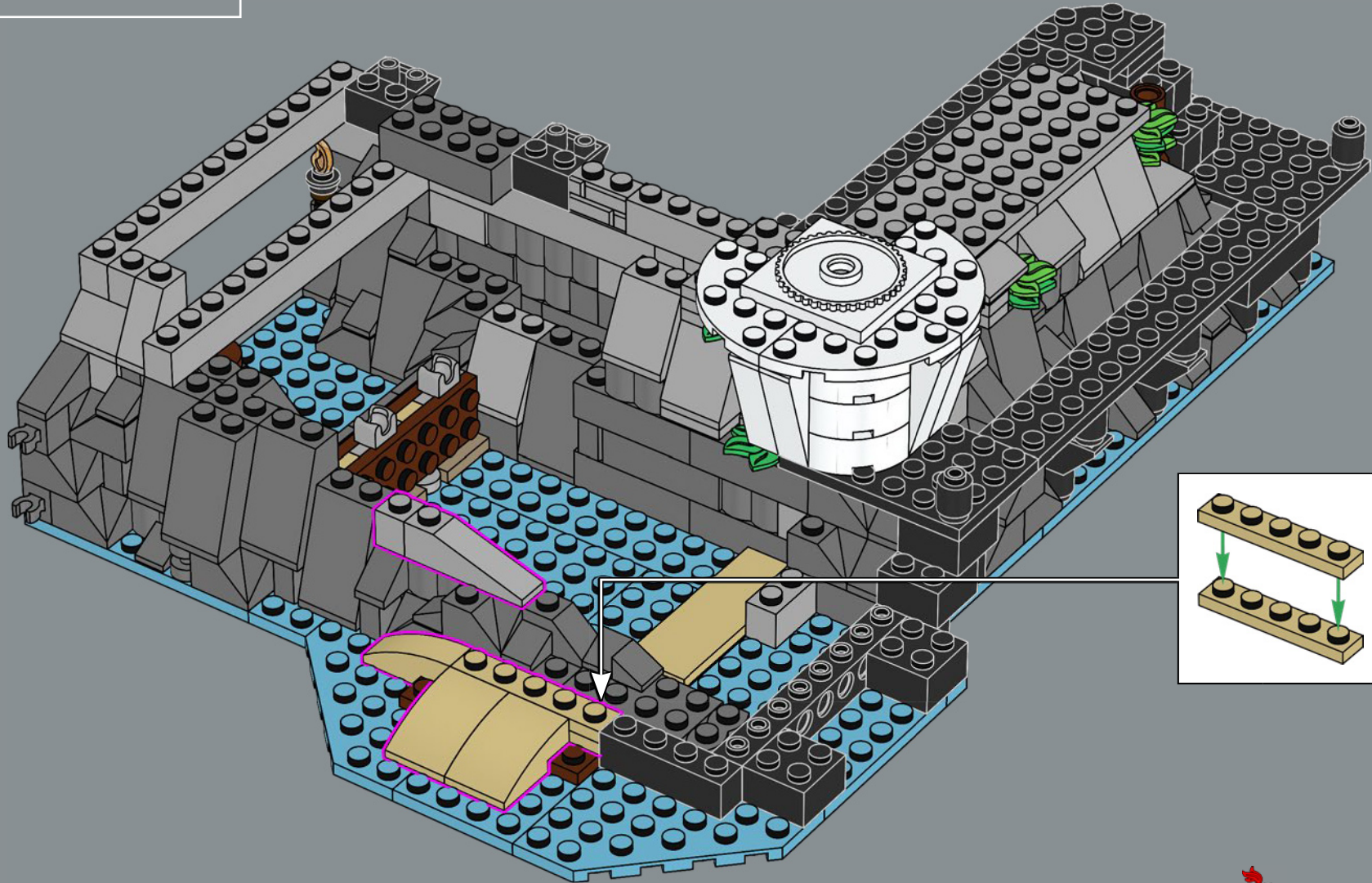

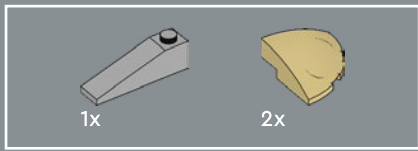

79

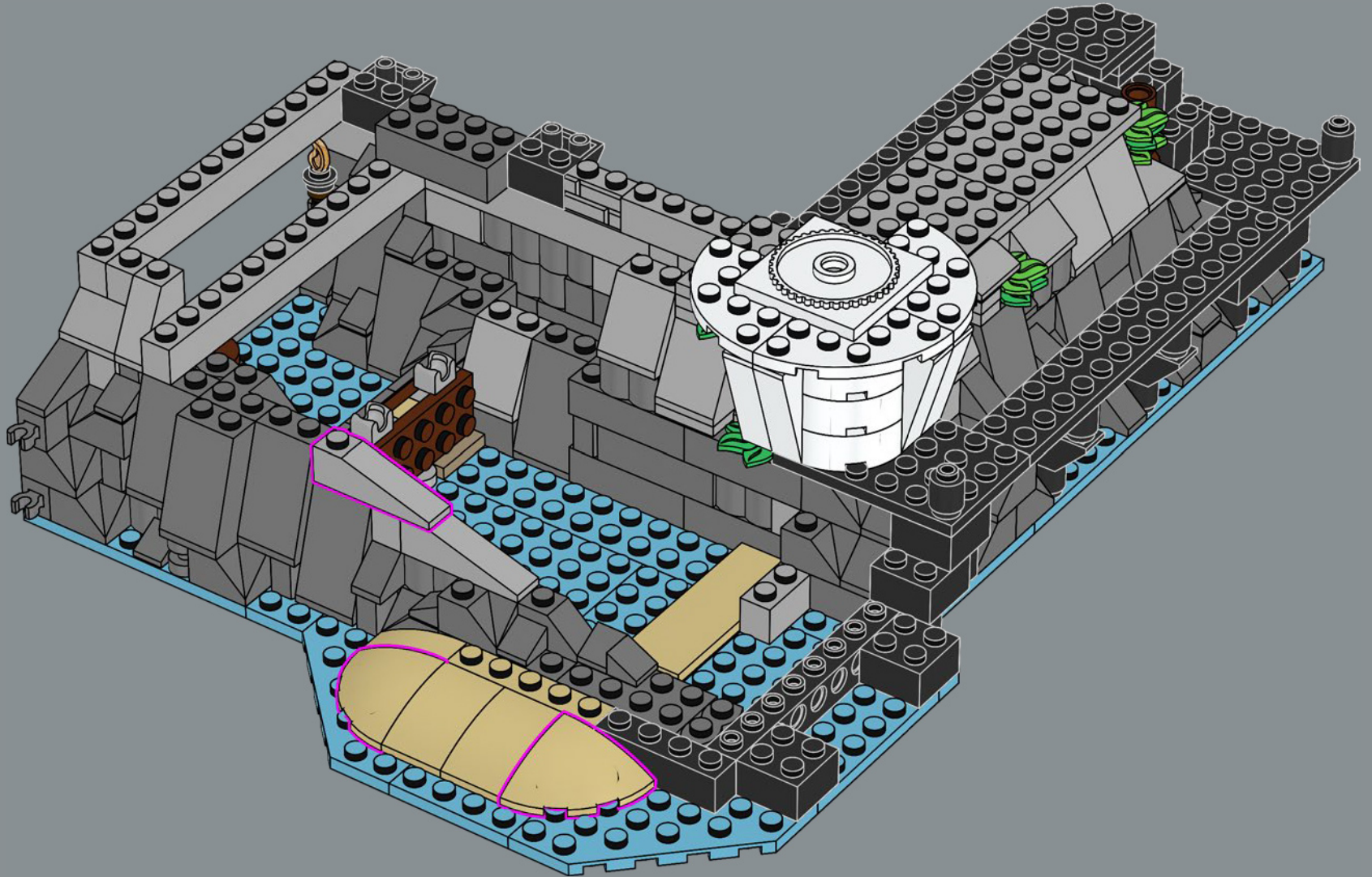

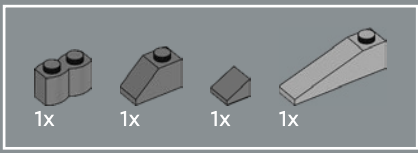

80

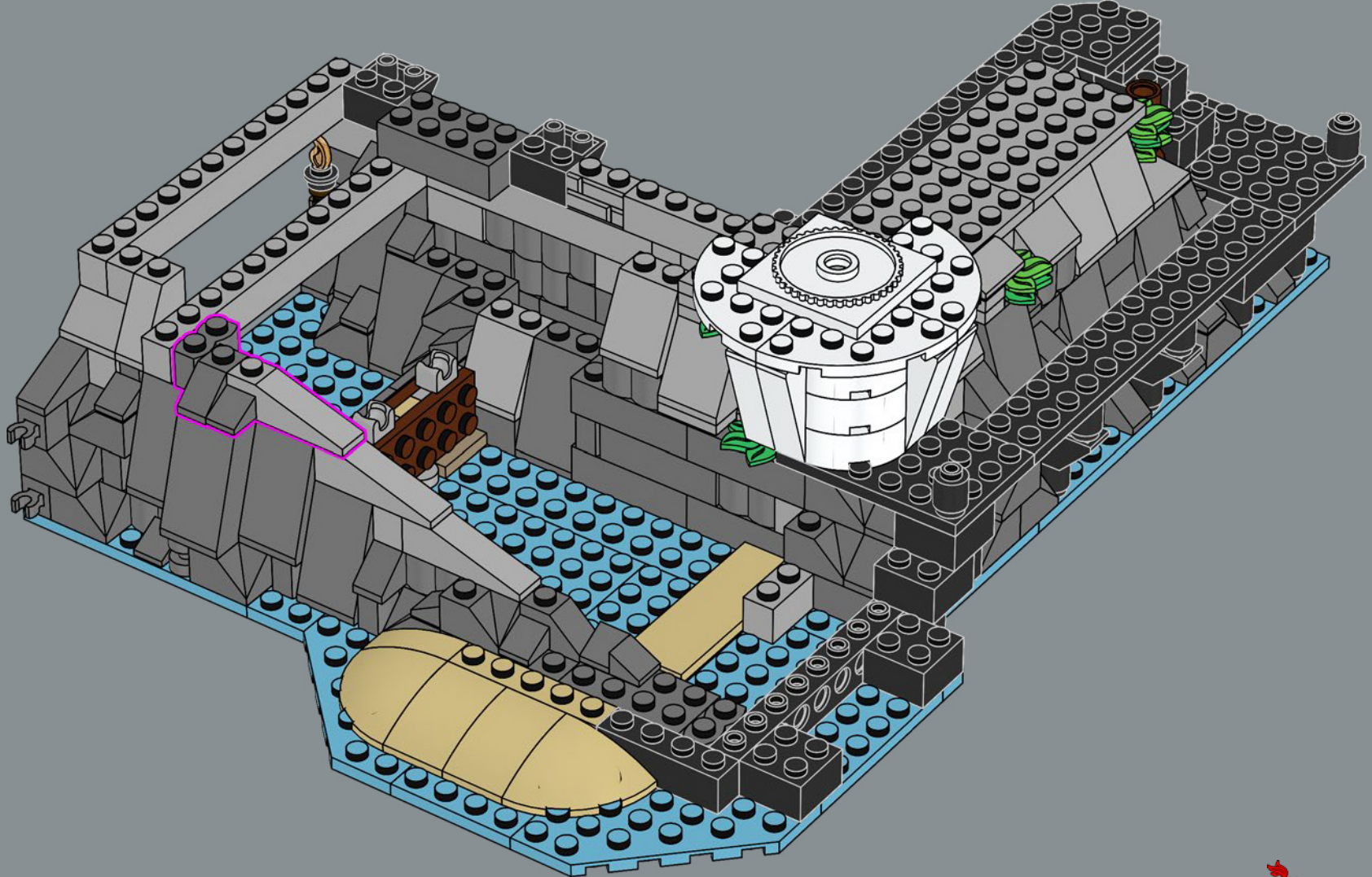

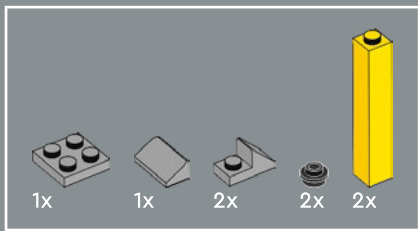

81

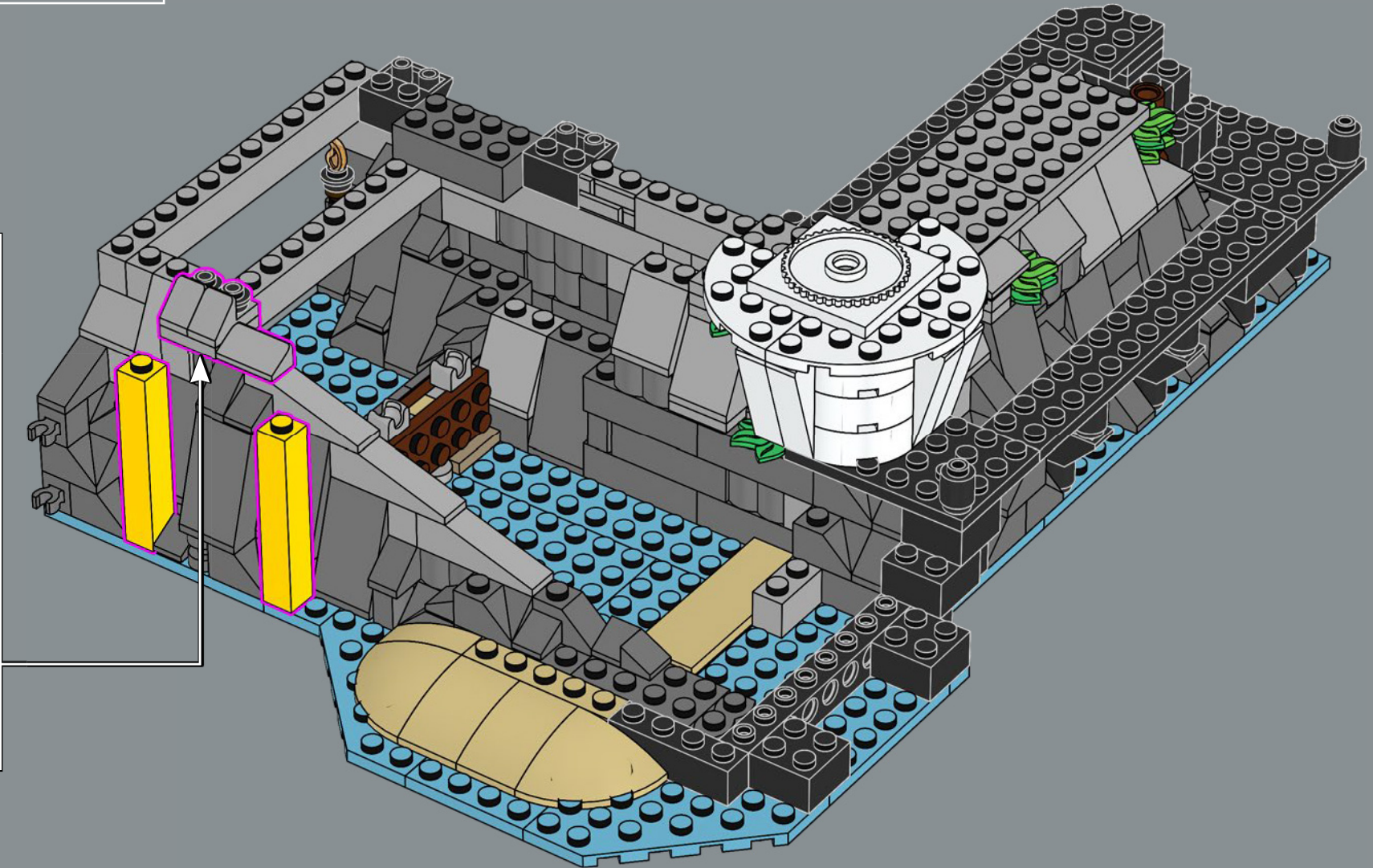
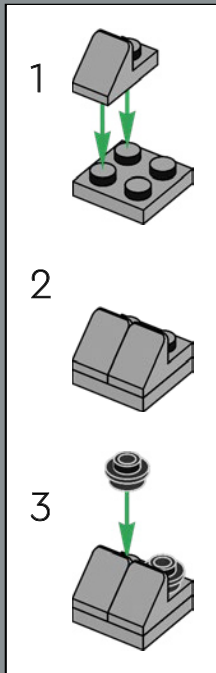

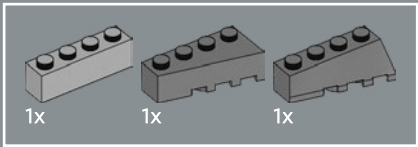

82

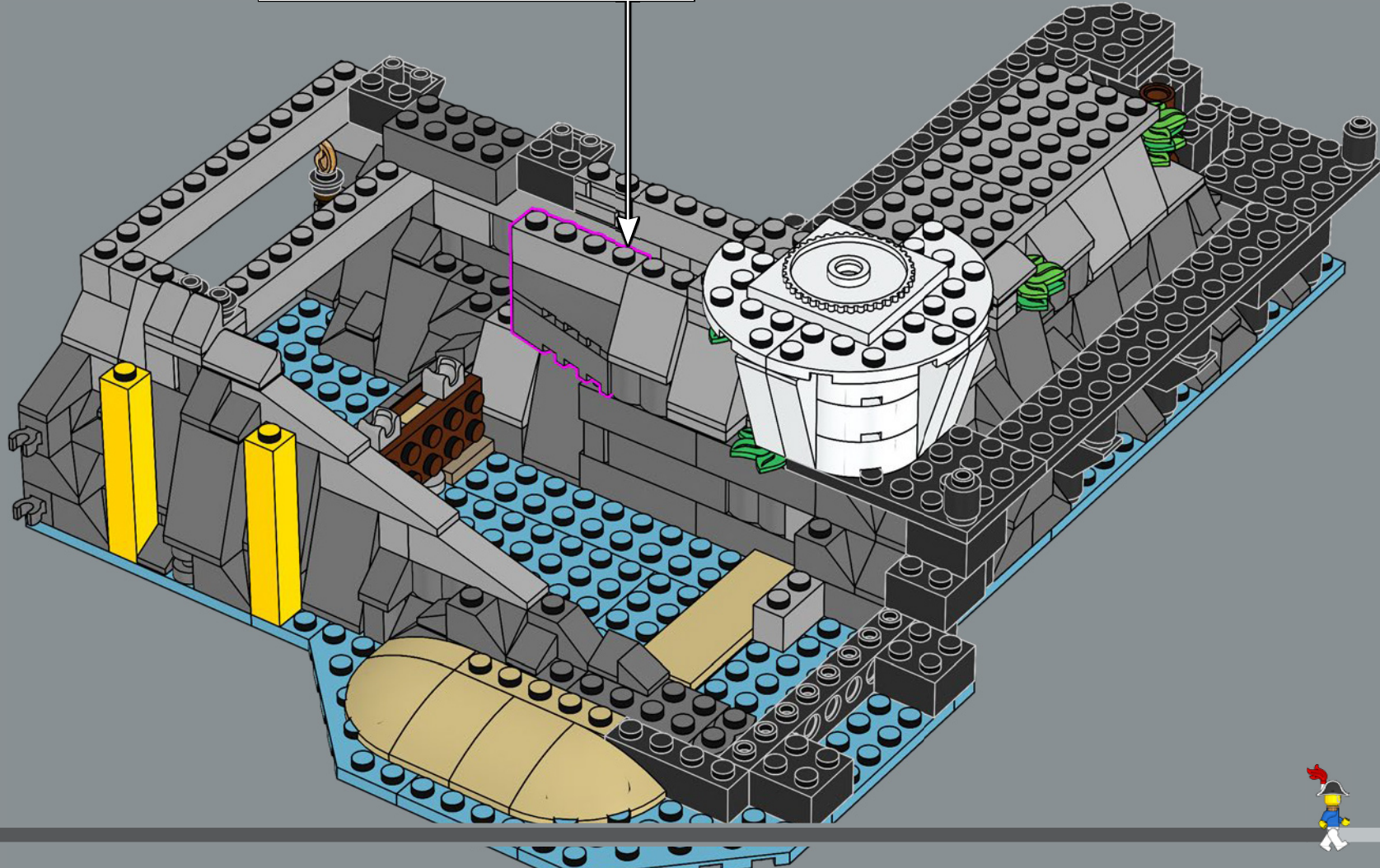
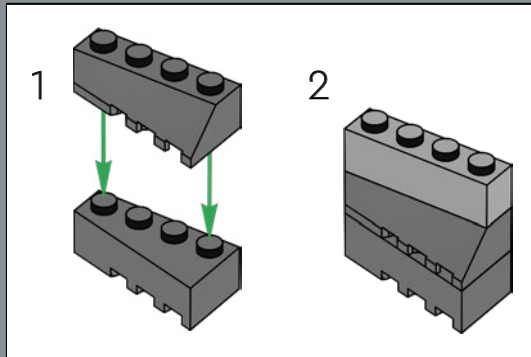

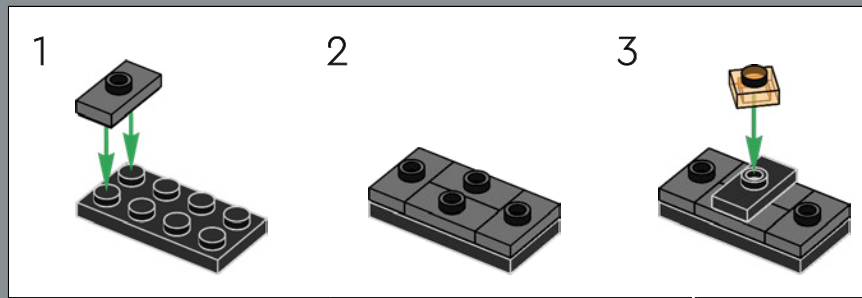
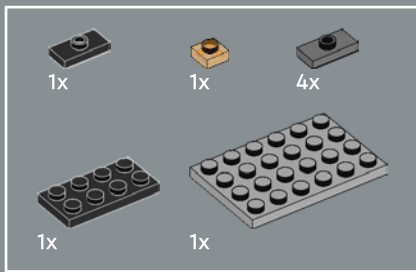

83

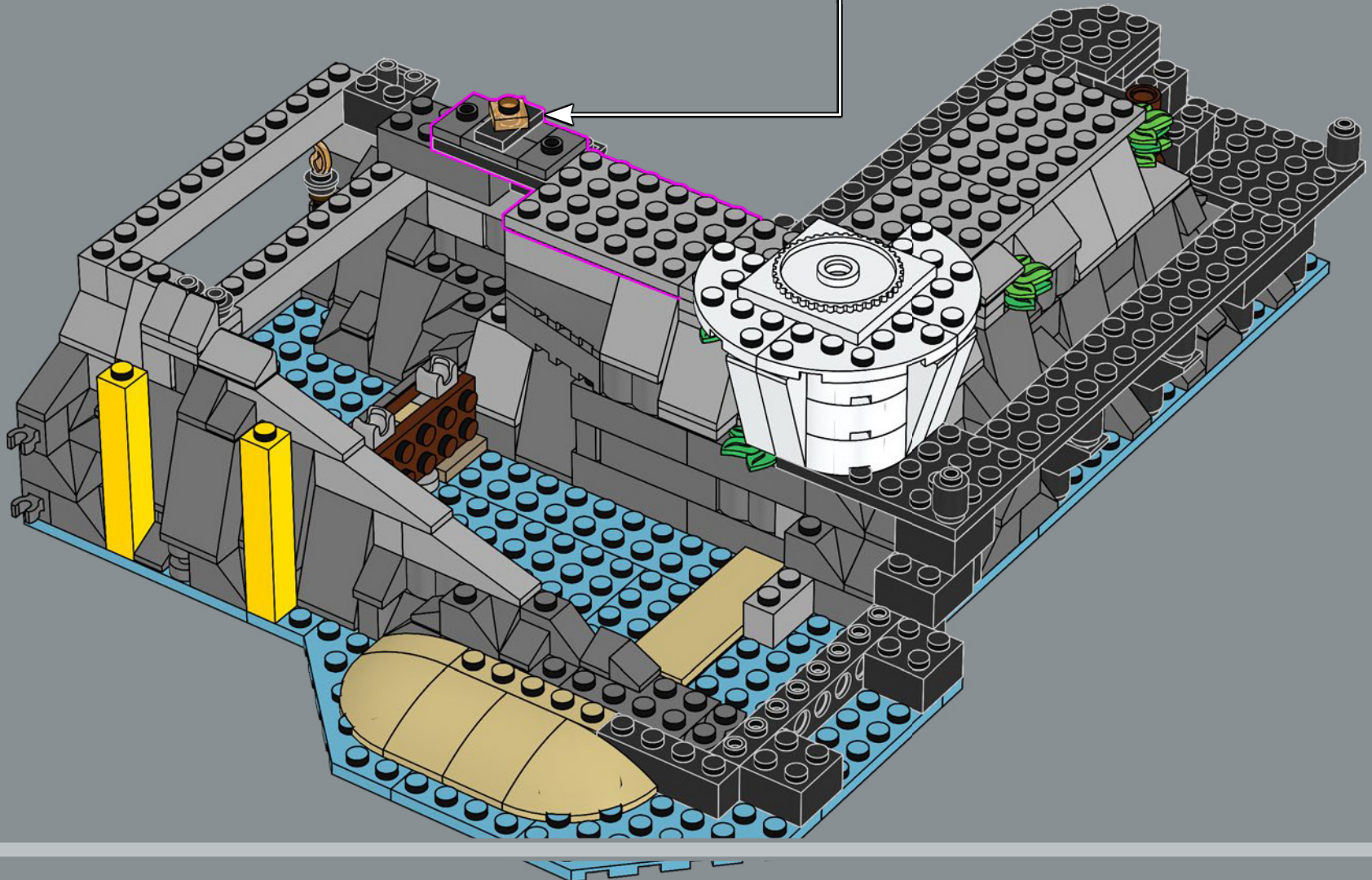

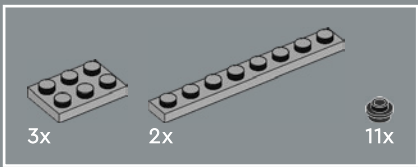

84

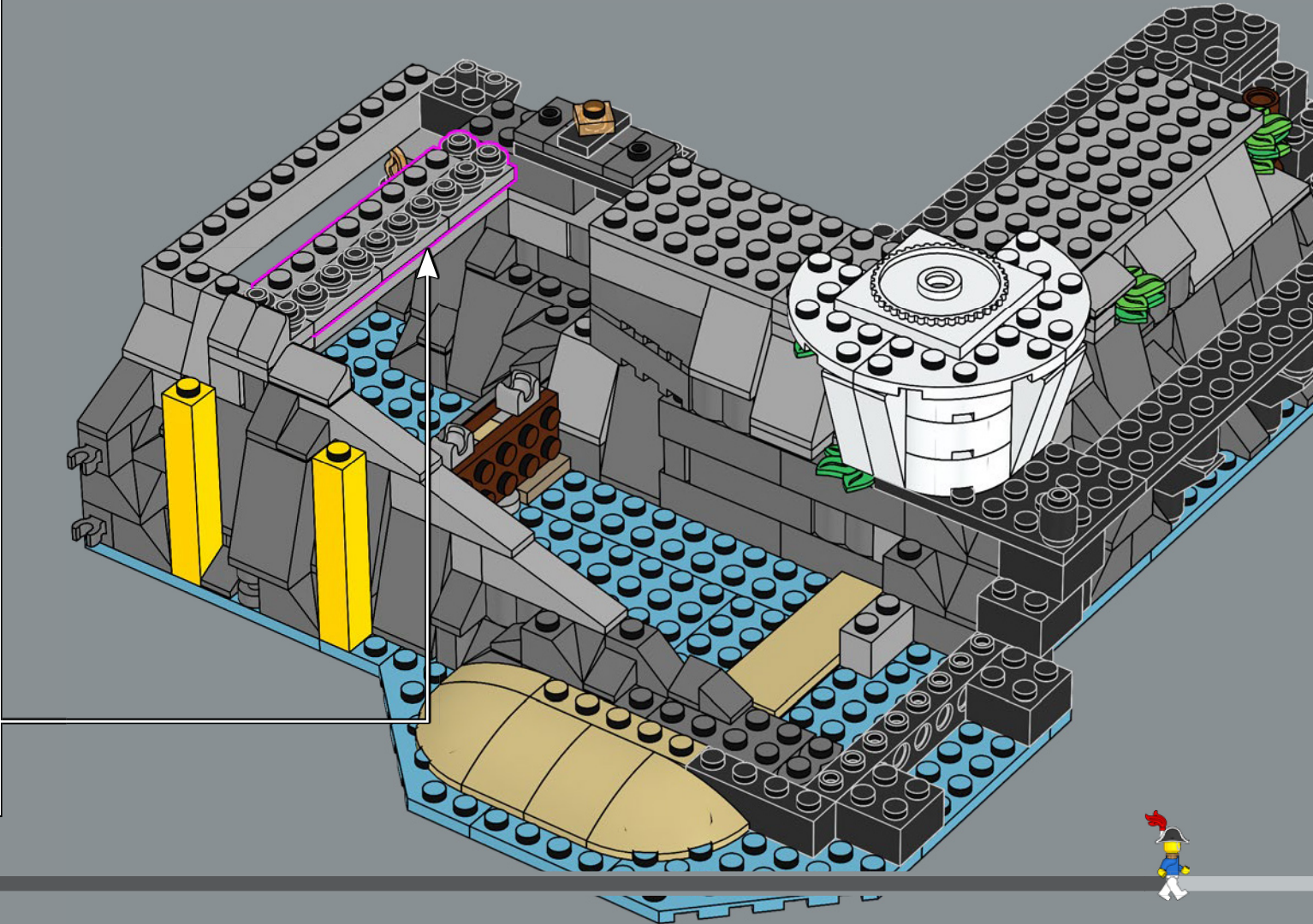
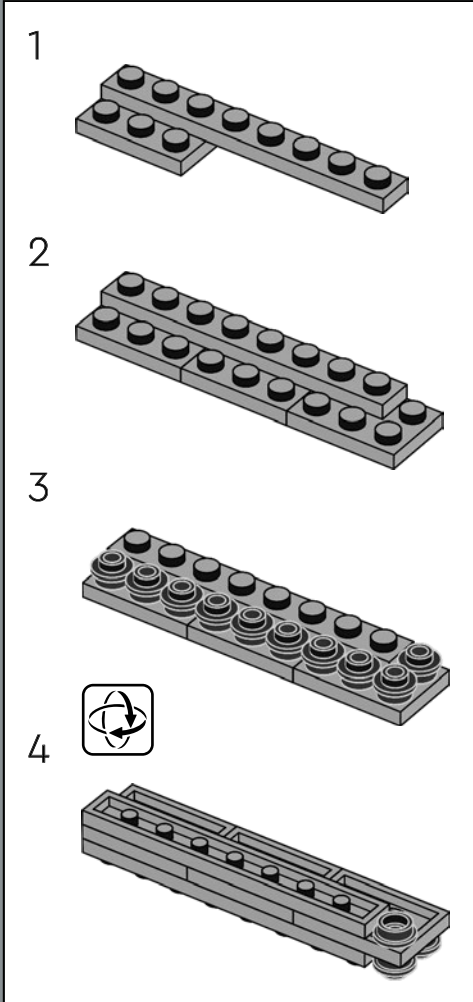

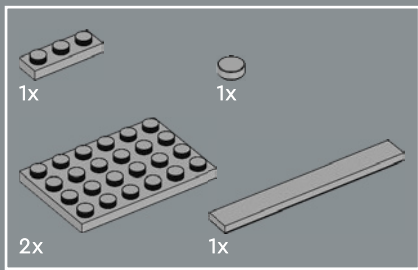

85

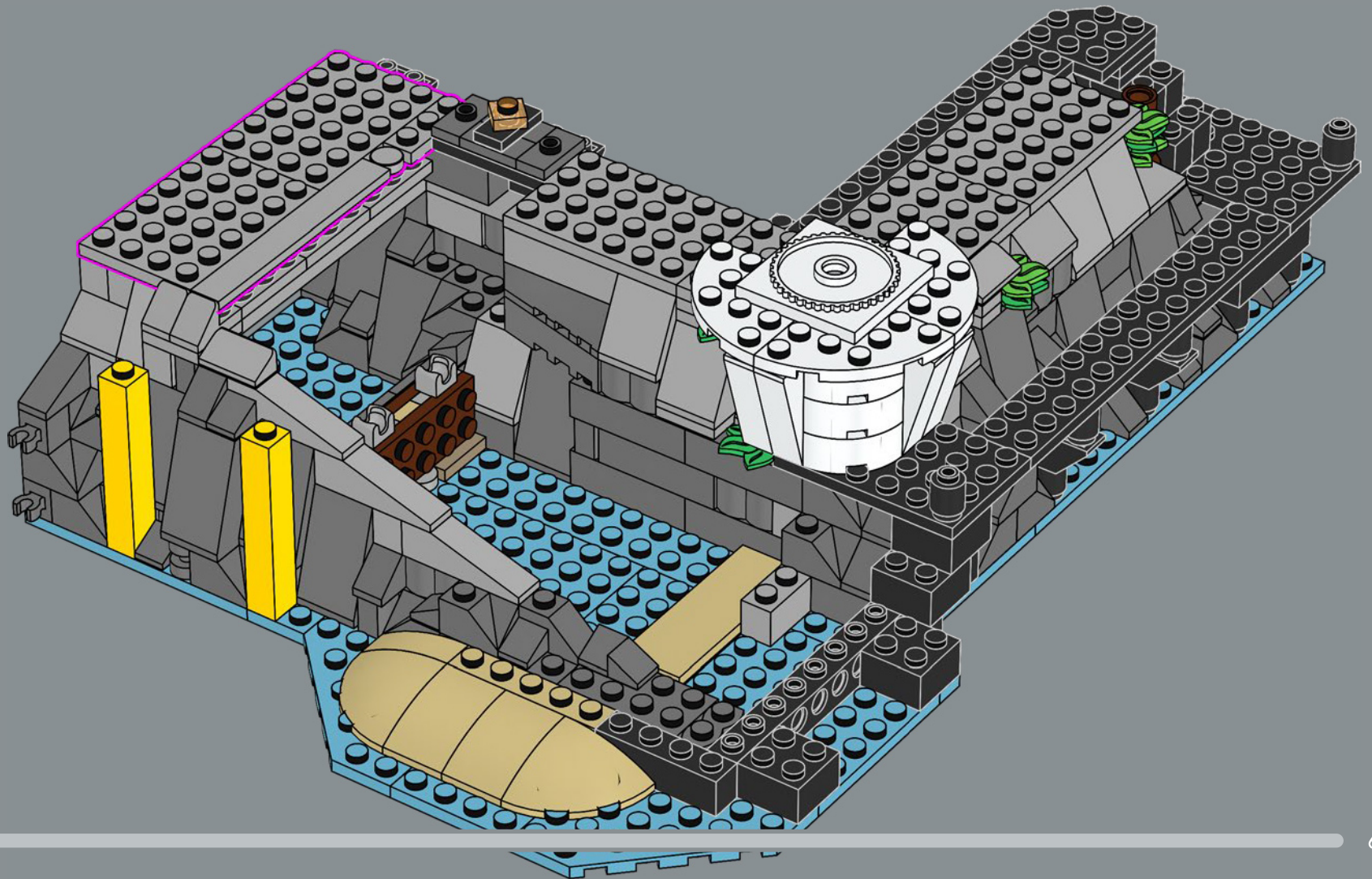

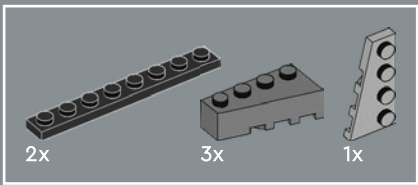

86

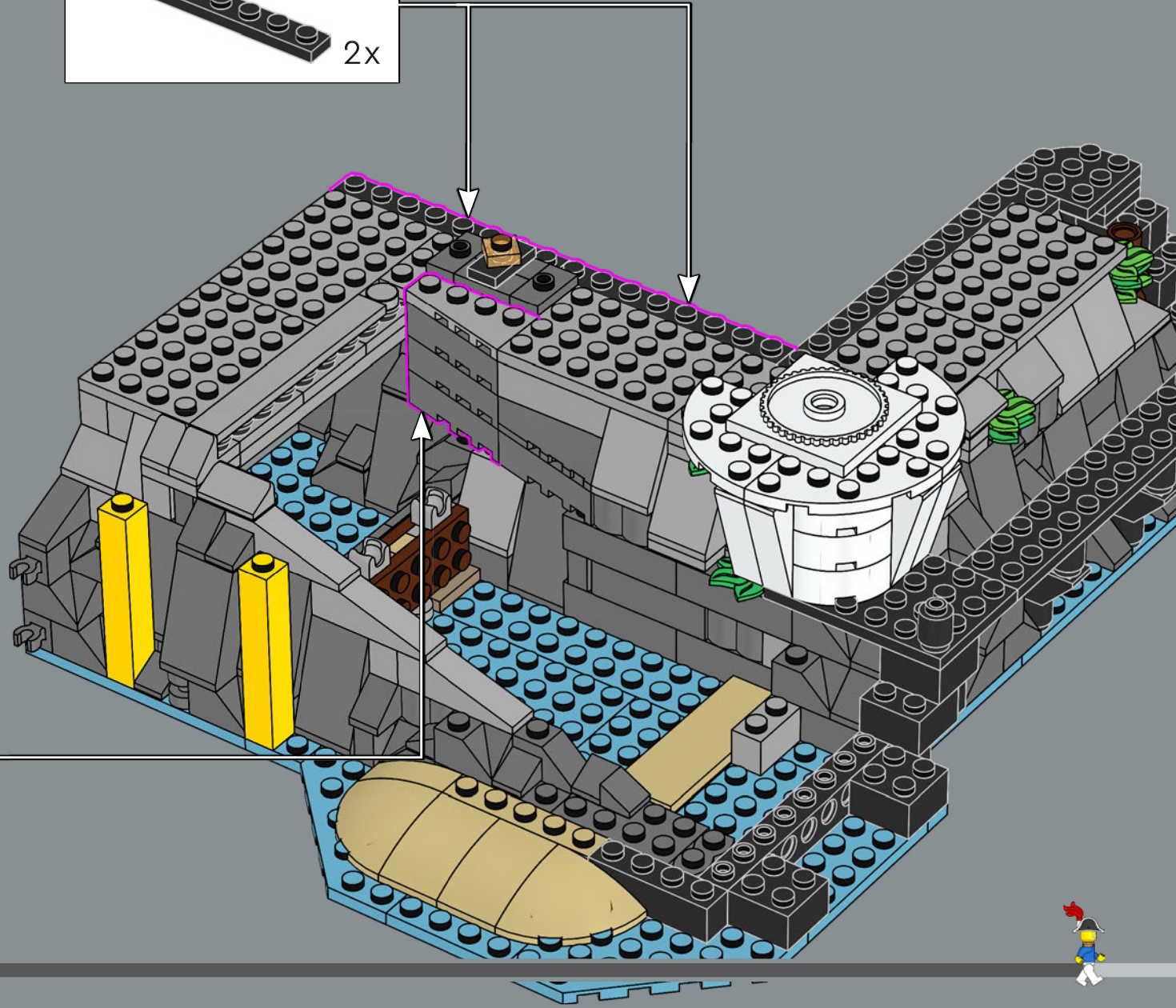
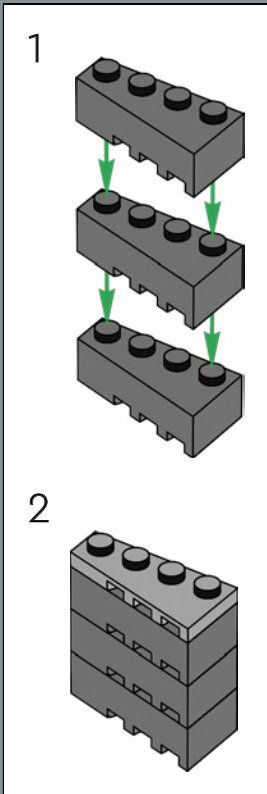
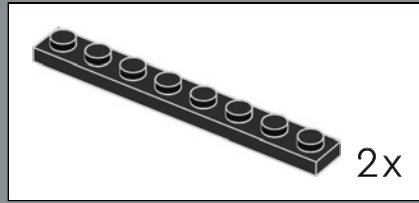

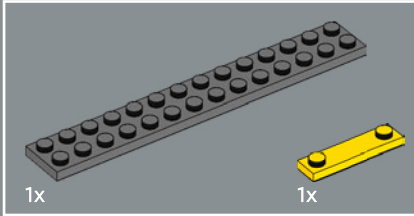
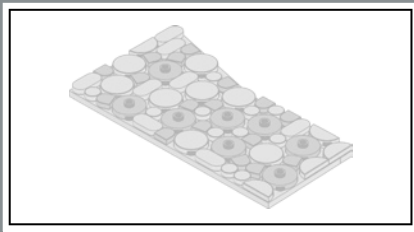

87

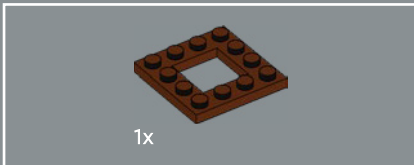
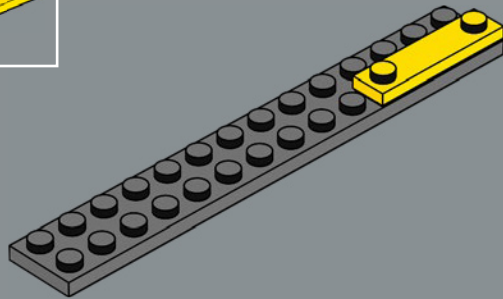

88

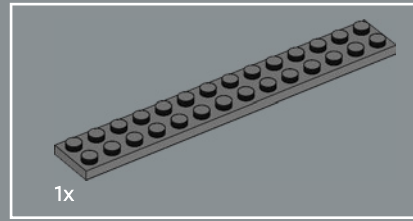
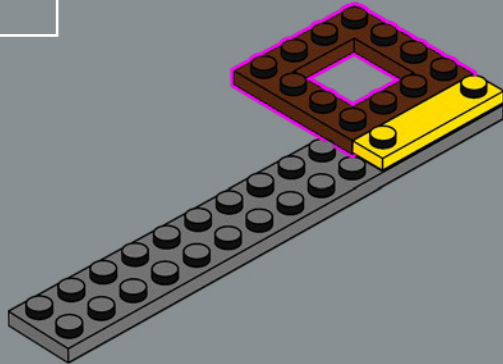

89

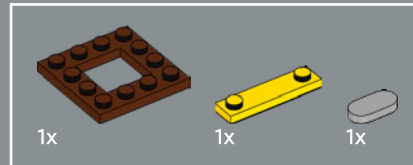
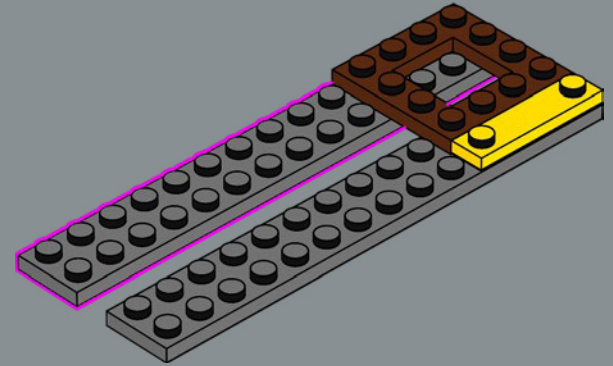

90

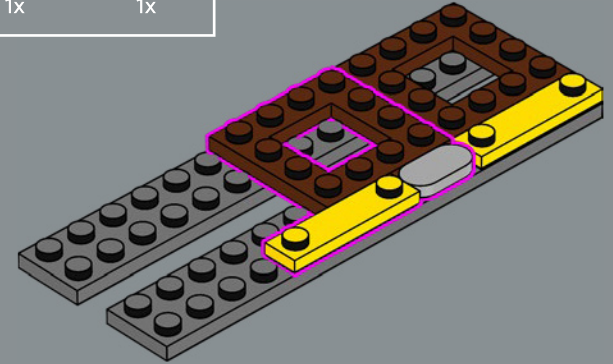

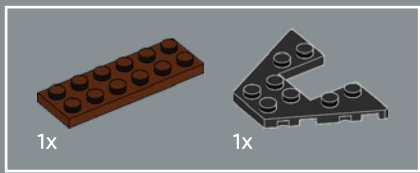

91

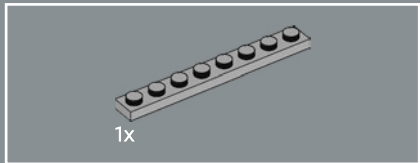
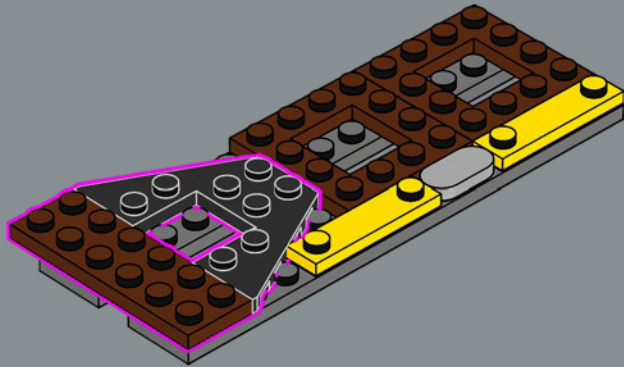

92

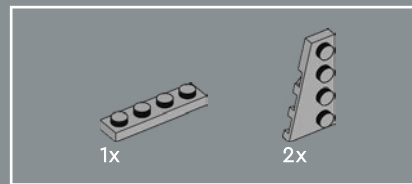
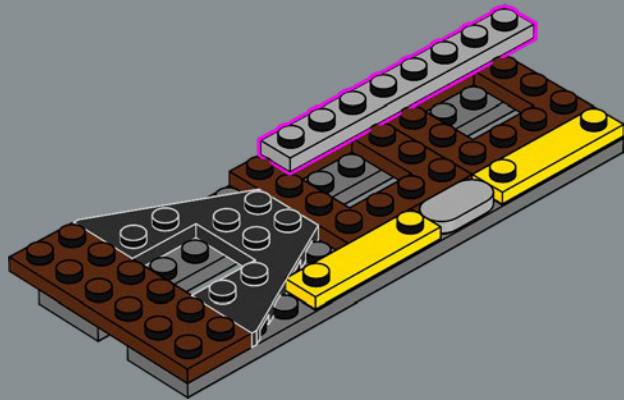

93

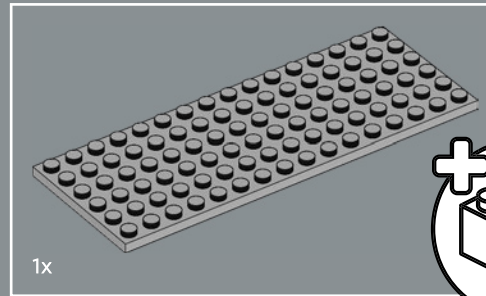
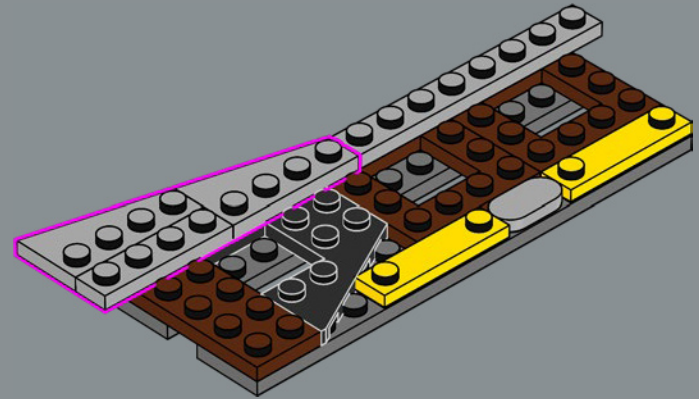

94

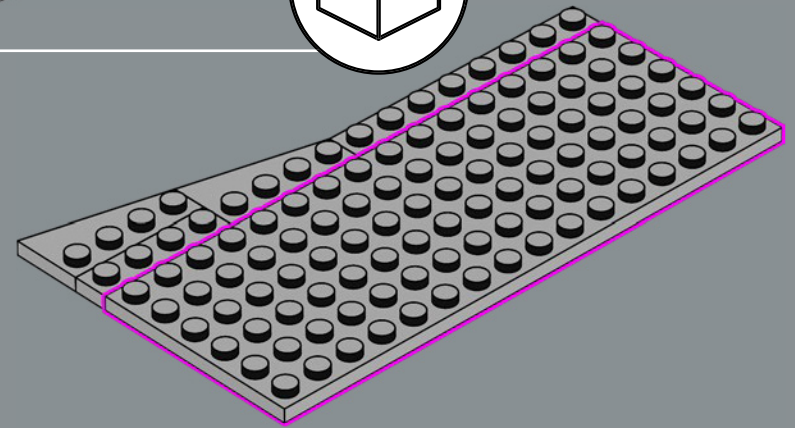

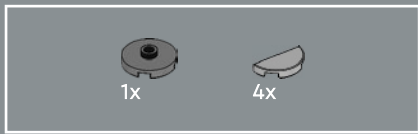

95

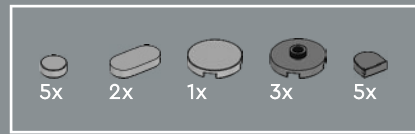
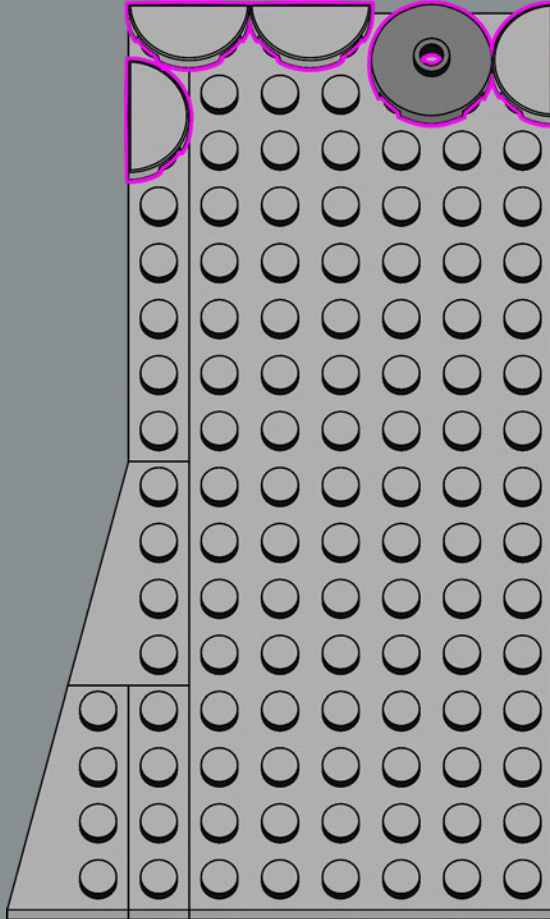

96

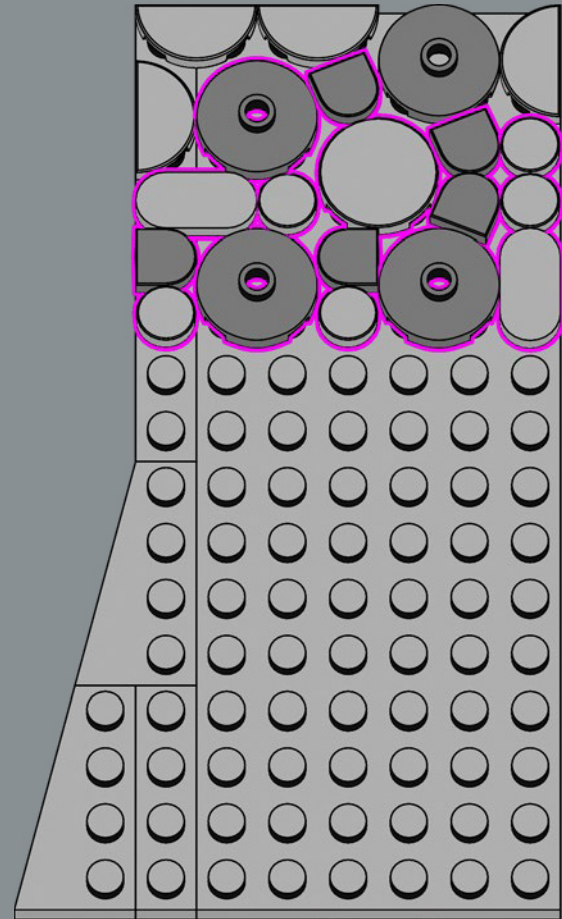

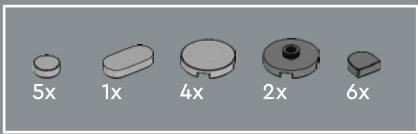

97

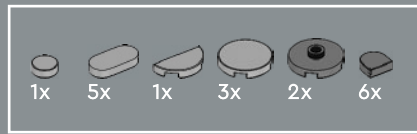
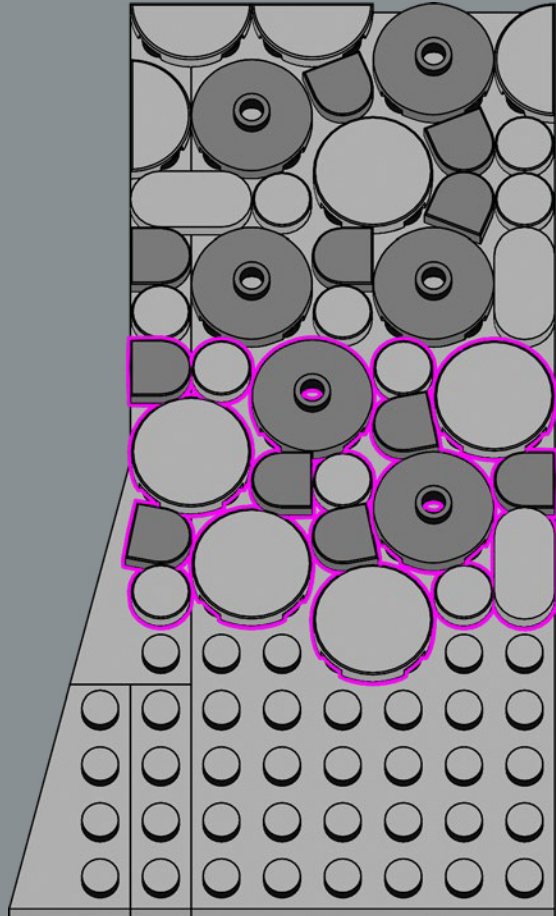

98

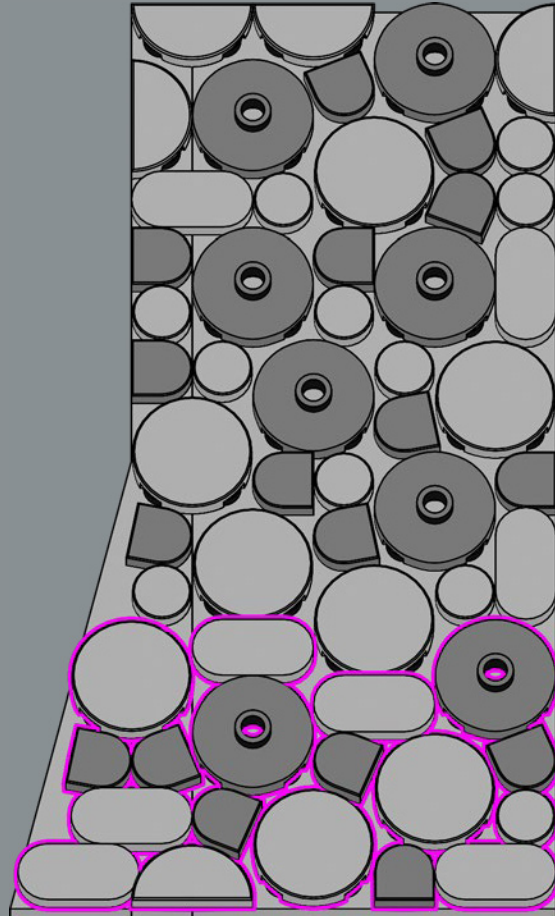

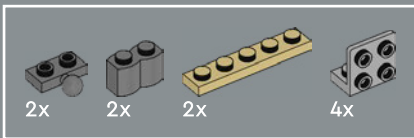

99

1

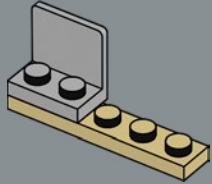

2

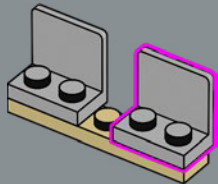

3

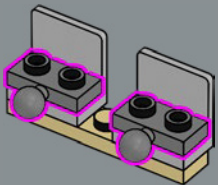

4

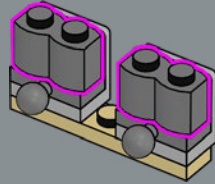

5

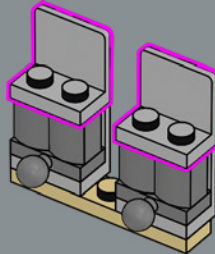

6

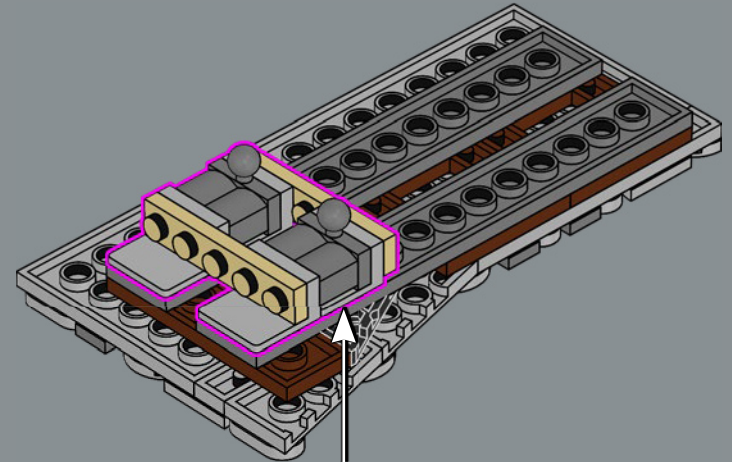
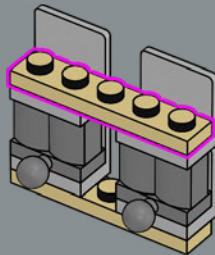



La rampa impresa original ahora está empedrada.

100

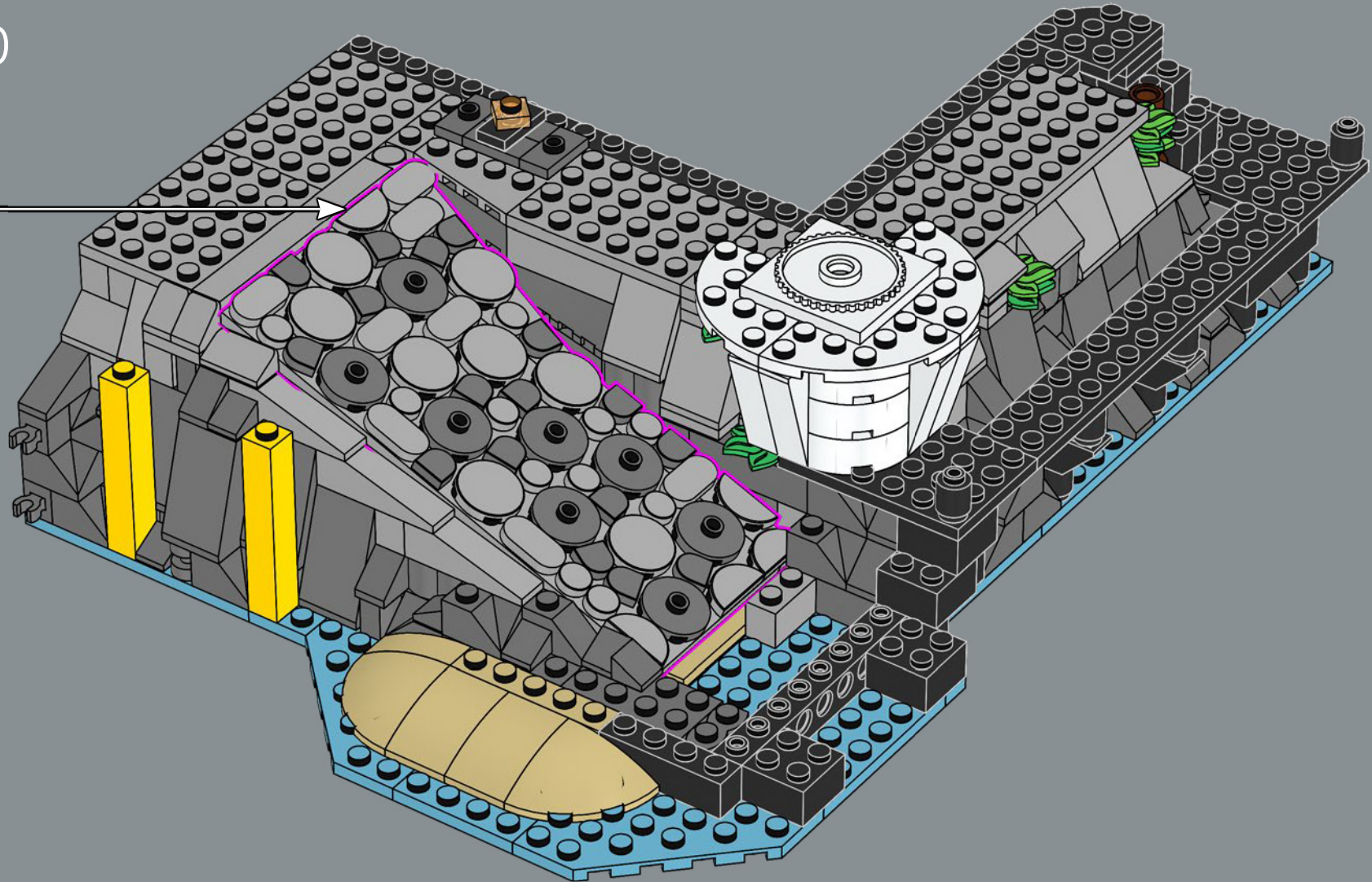
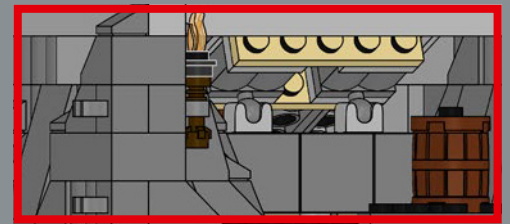

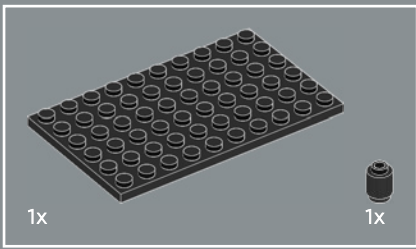

101

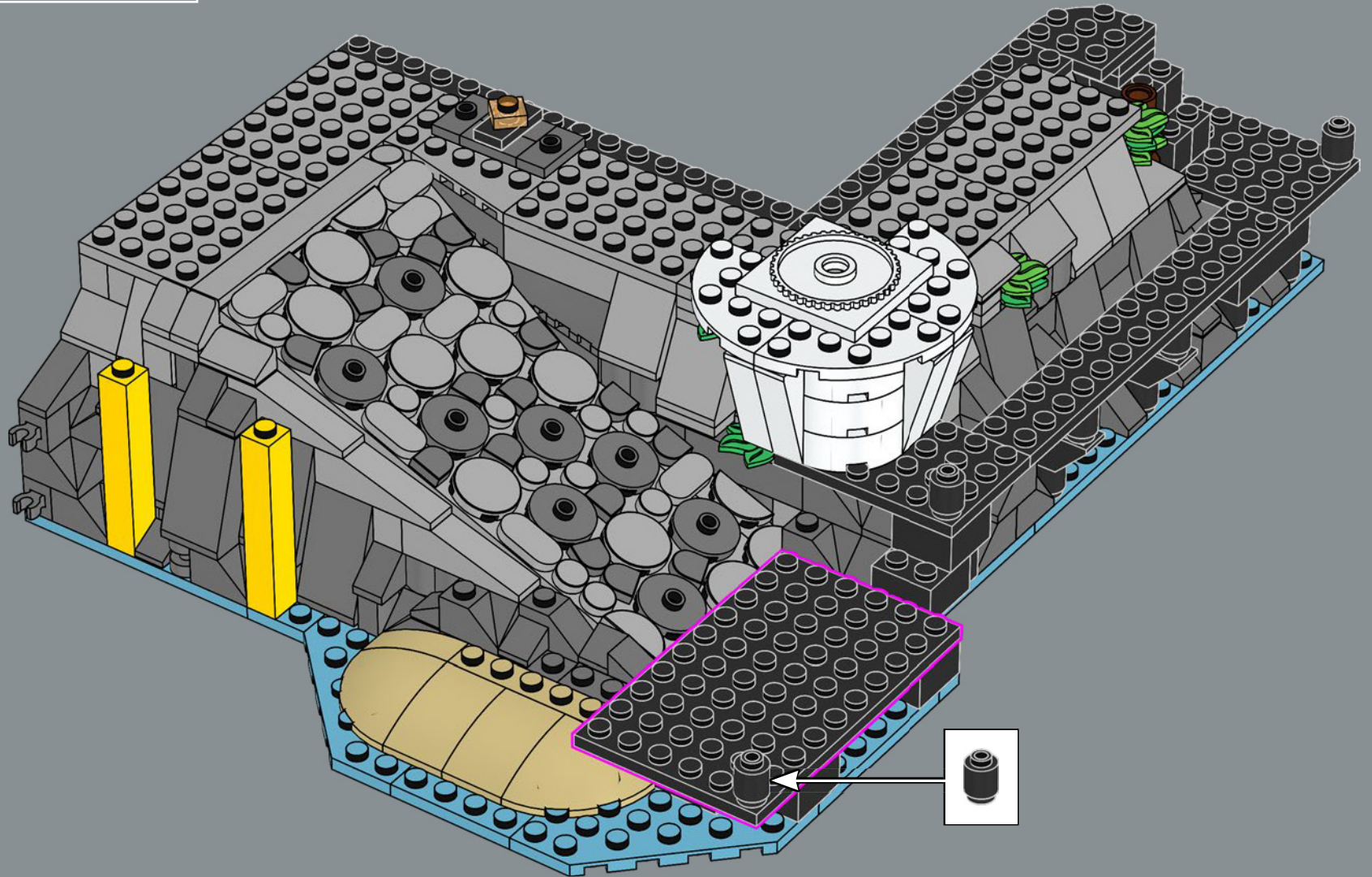

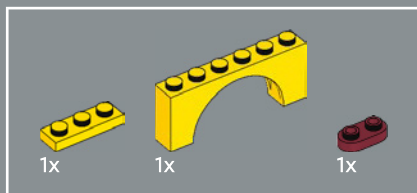

102

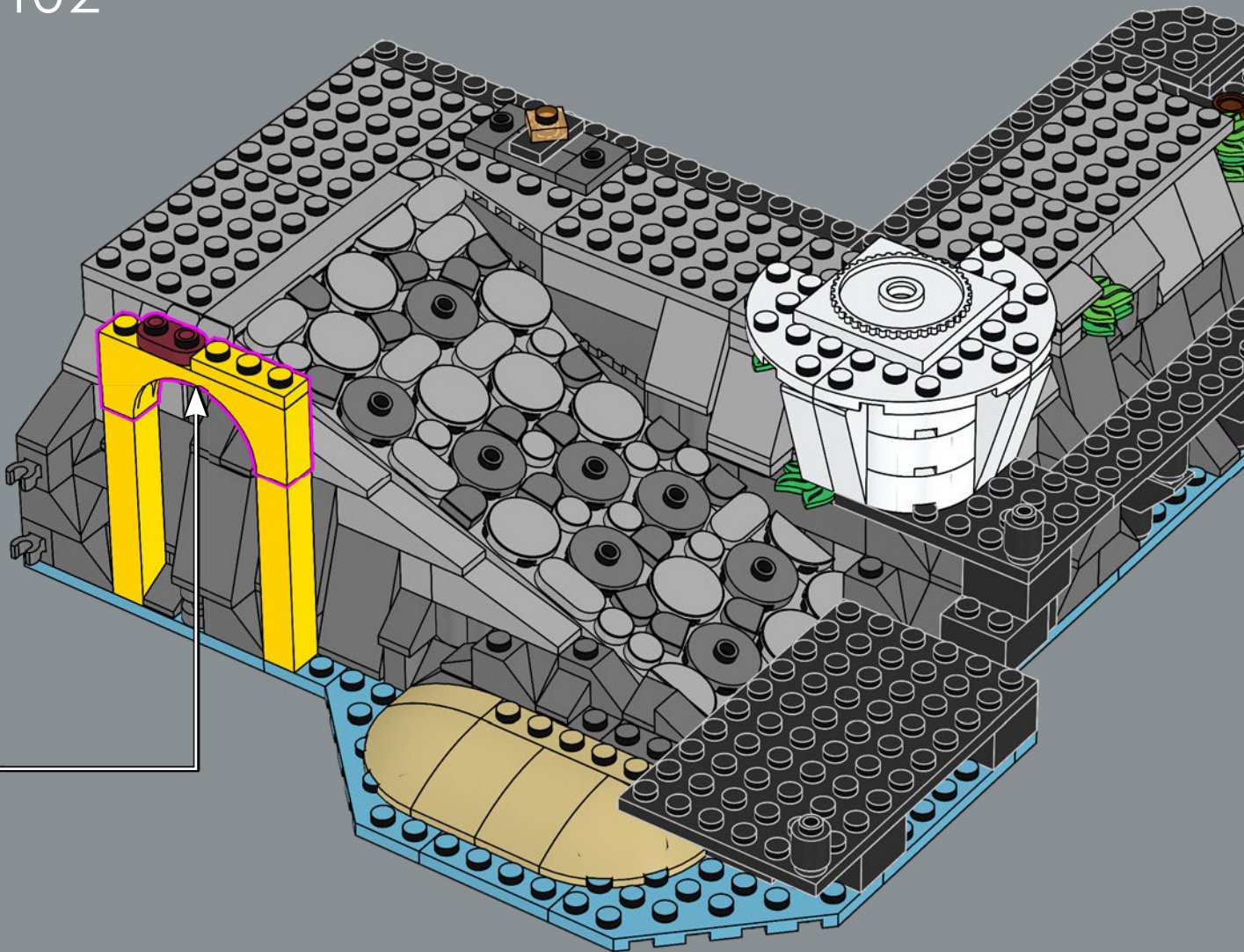
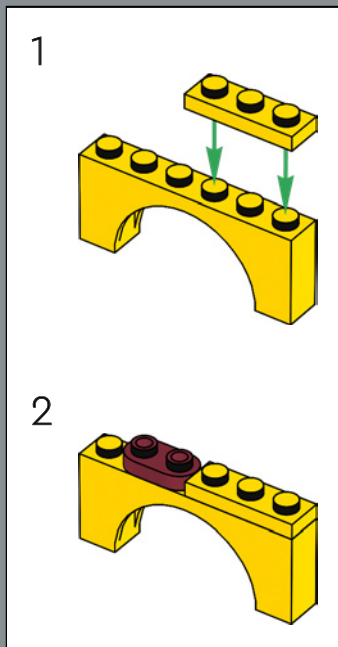

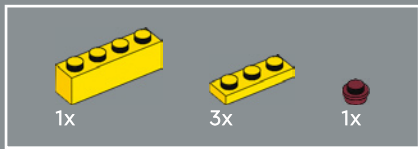

103

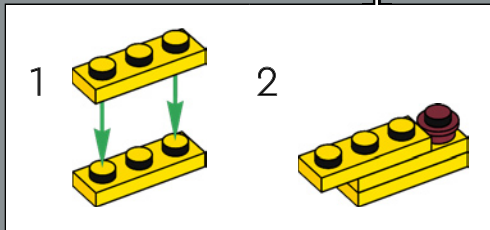
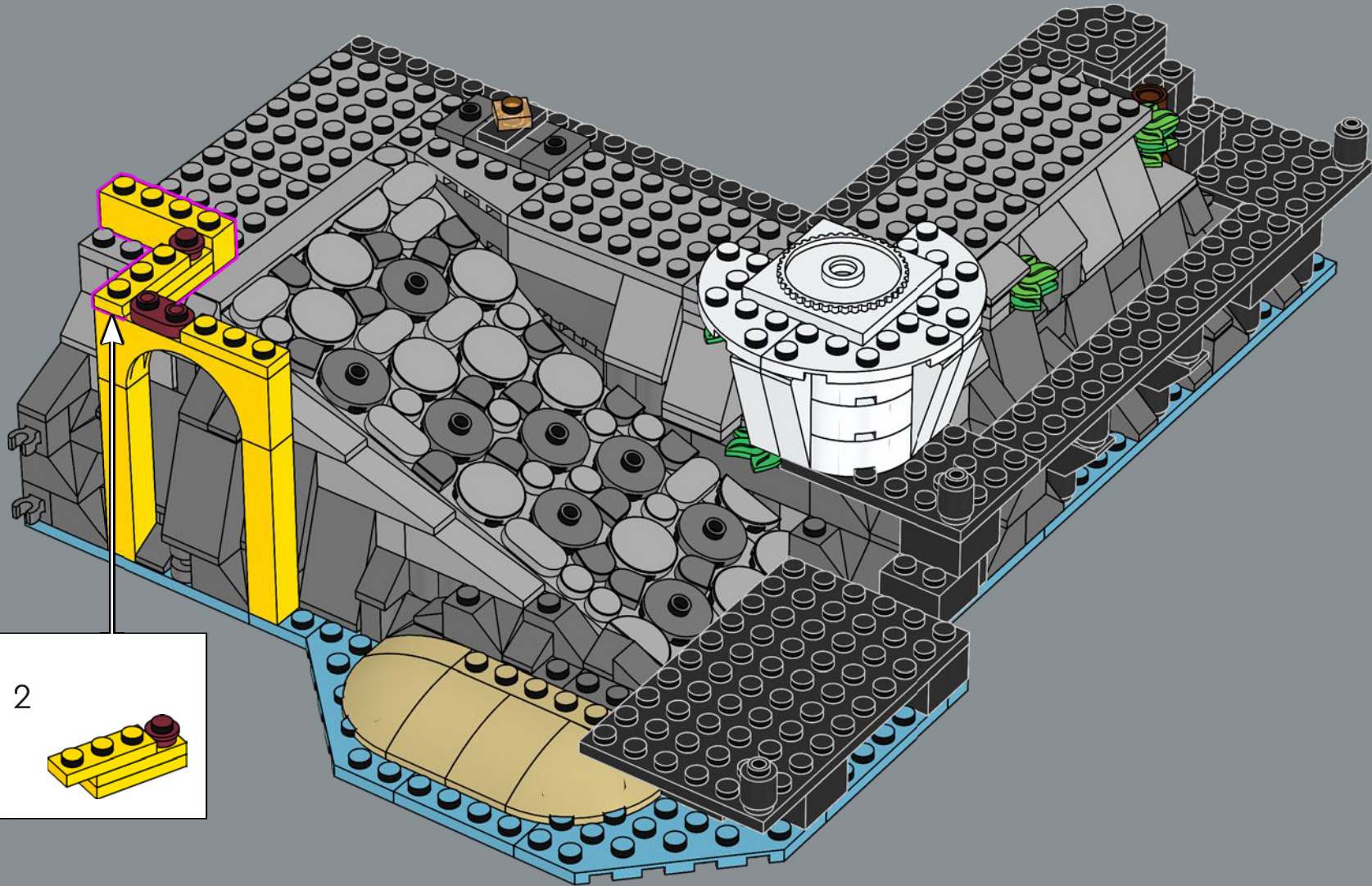

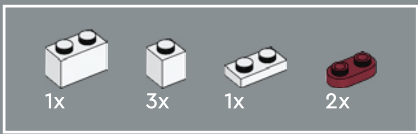

104

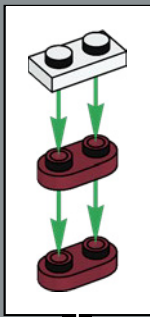

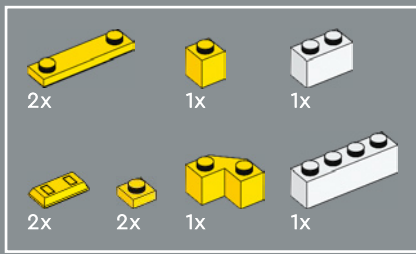

105

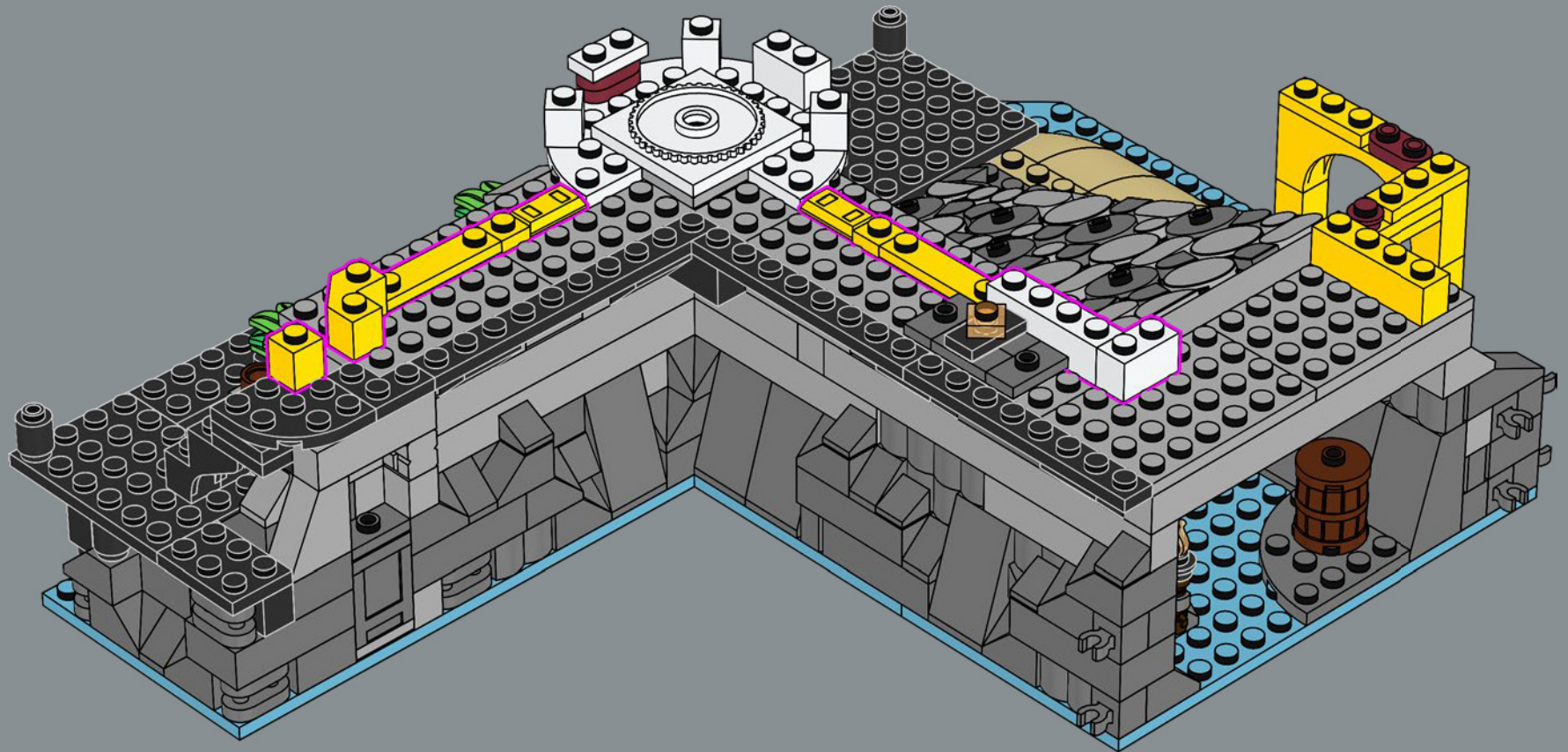

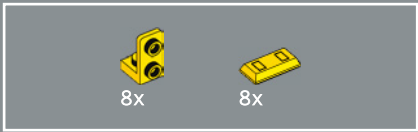

106

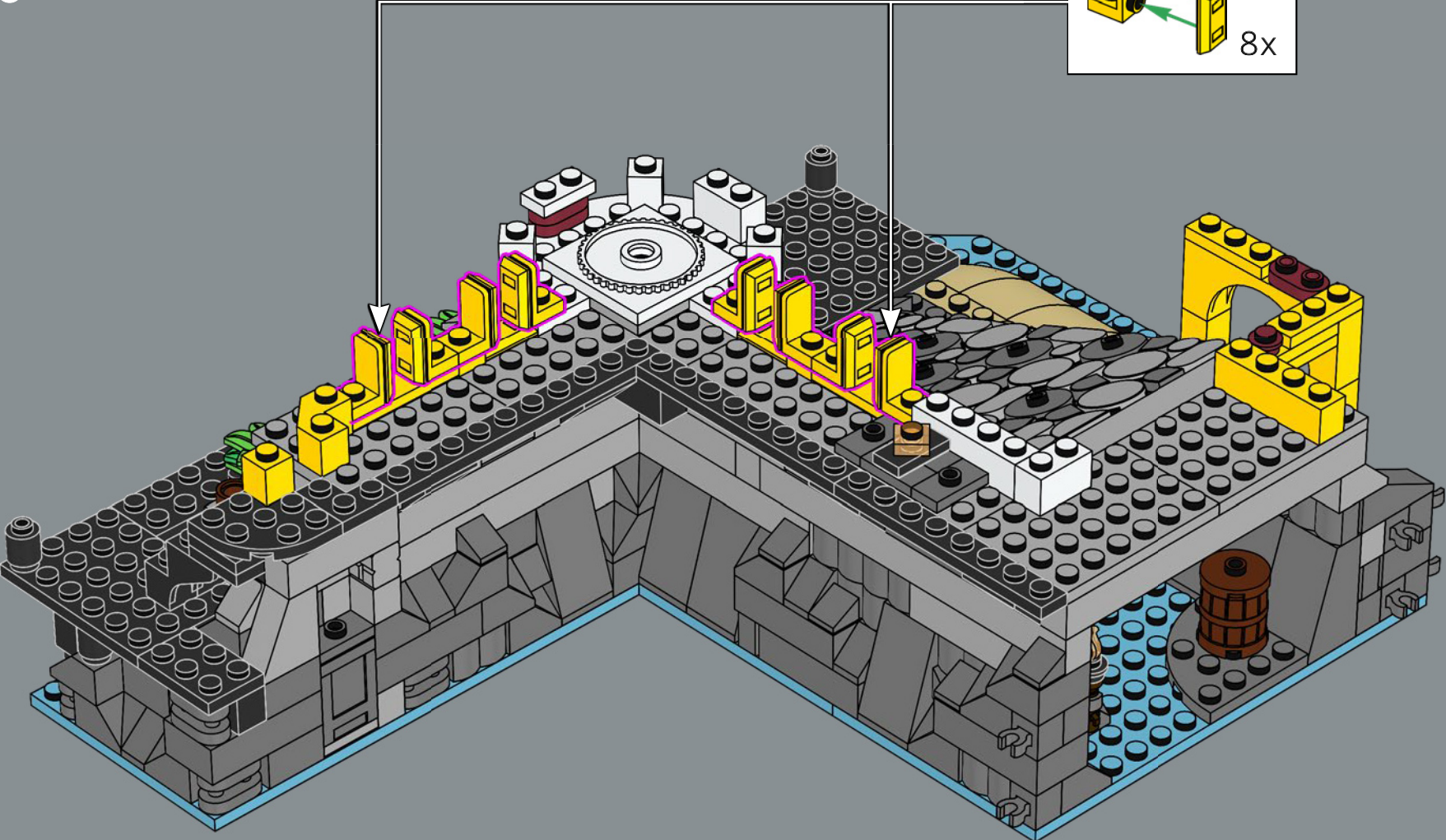
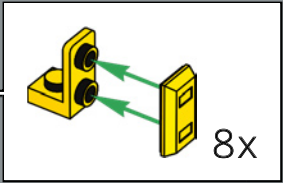

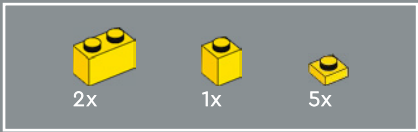

107

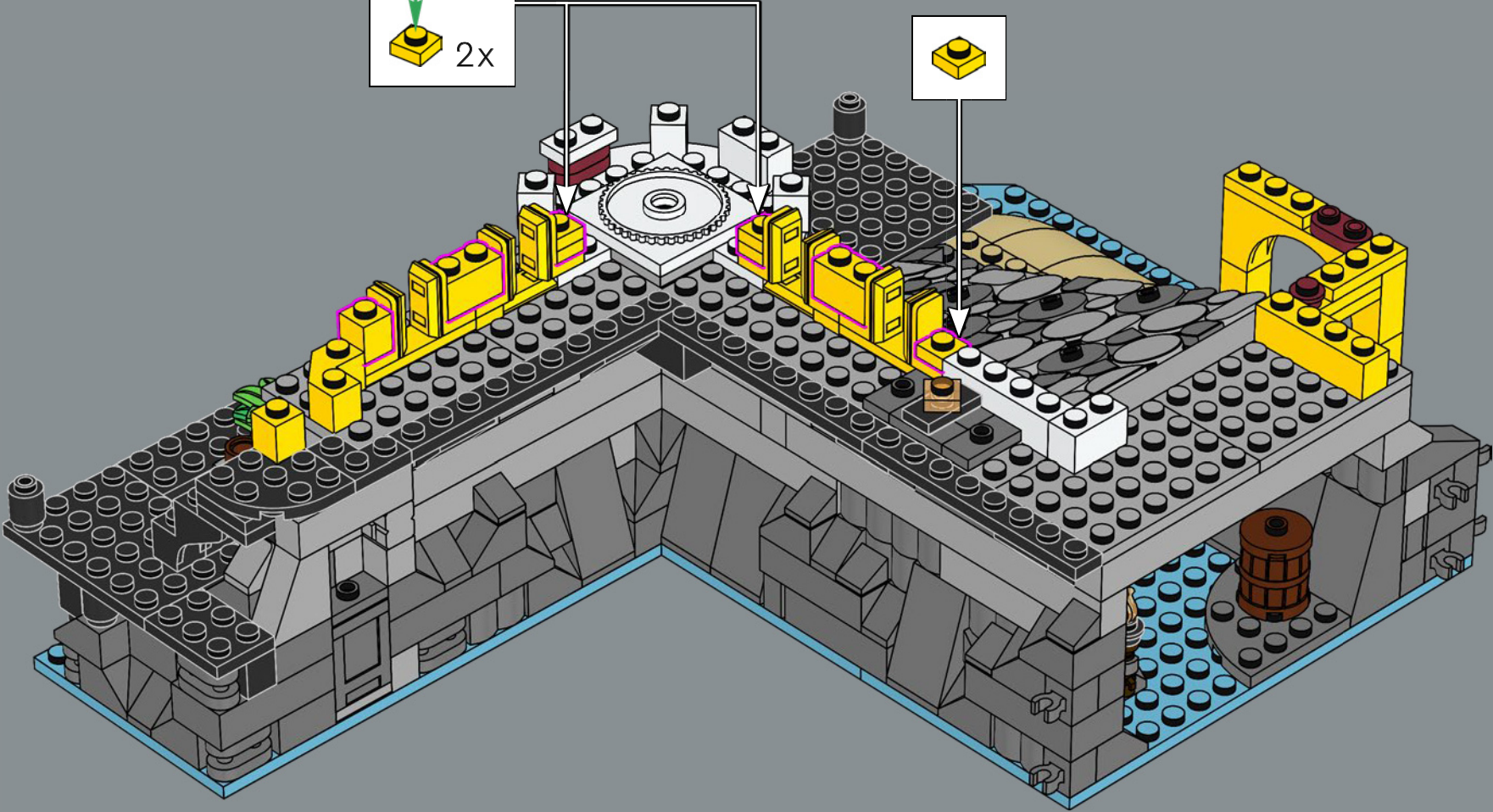
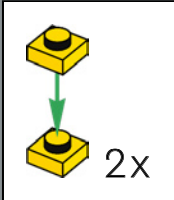



108

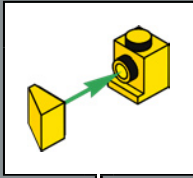
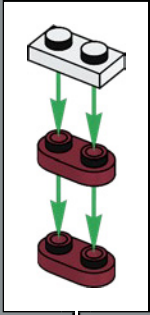

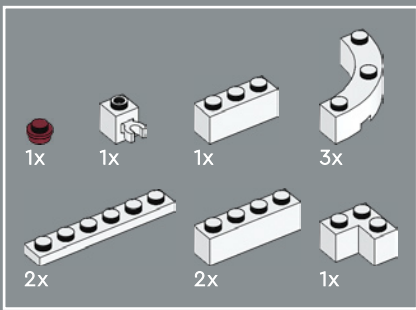

110

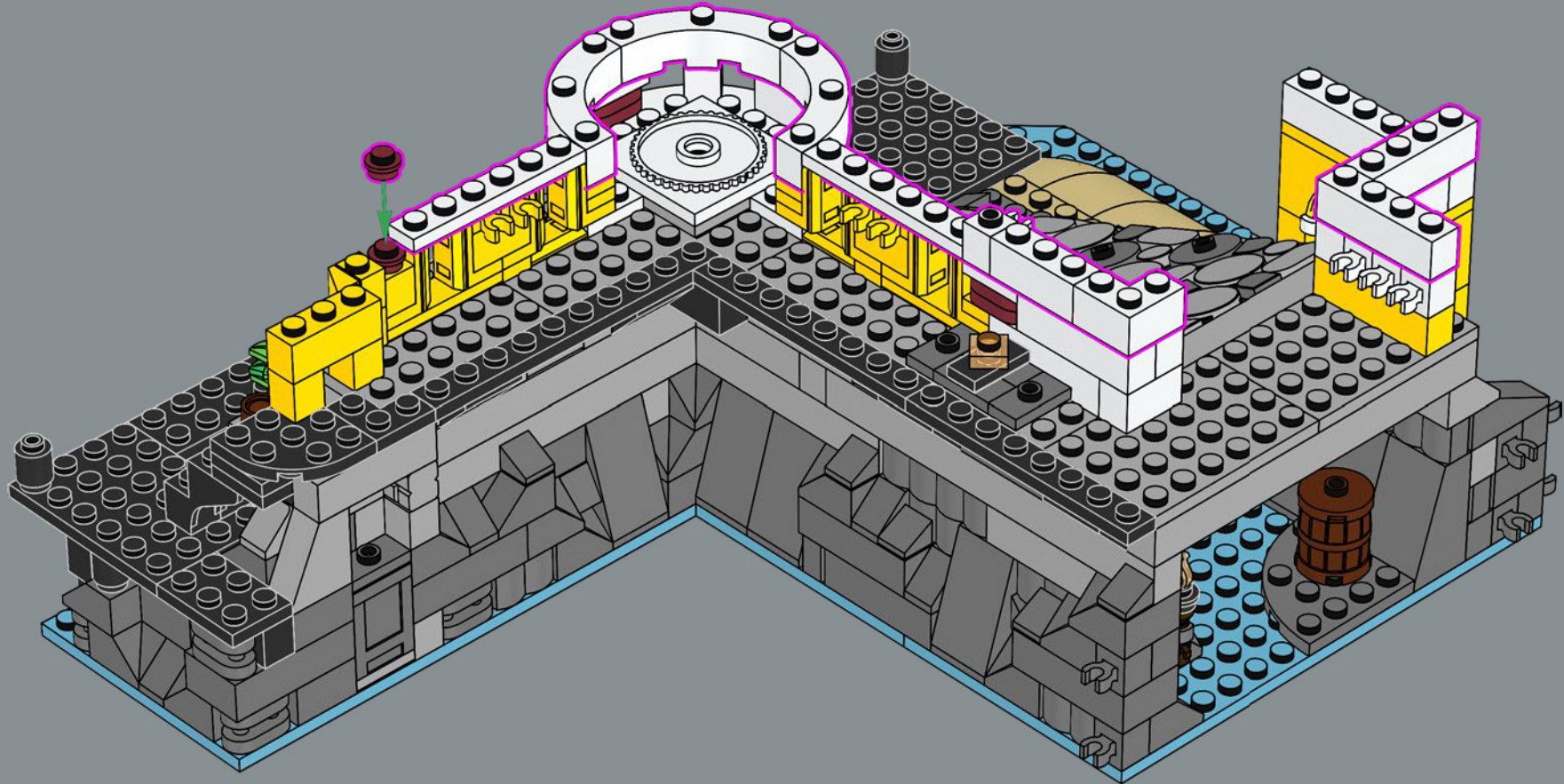

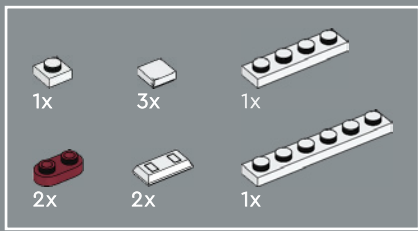

111

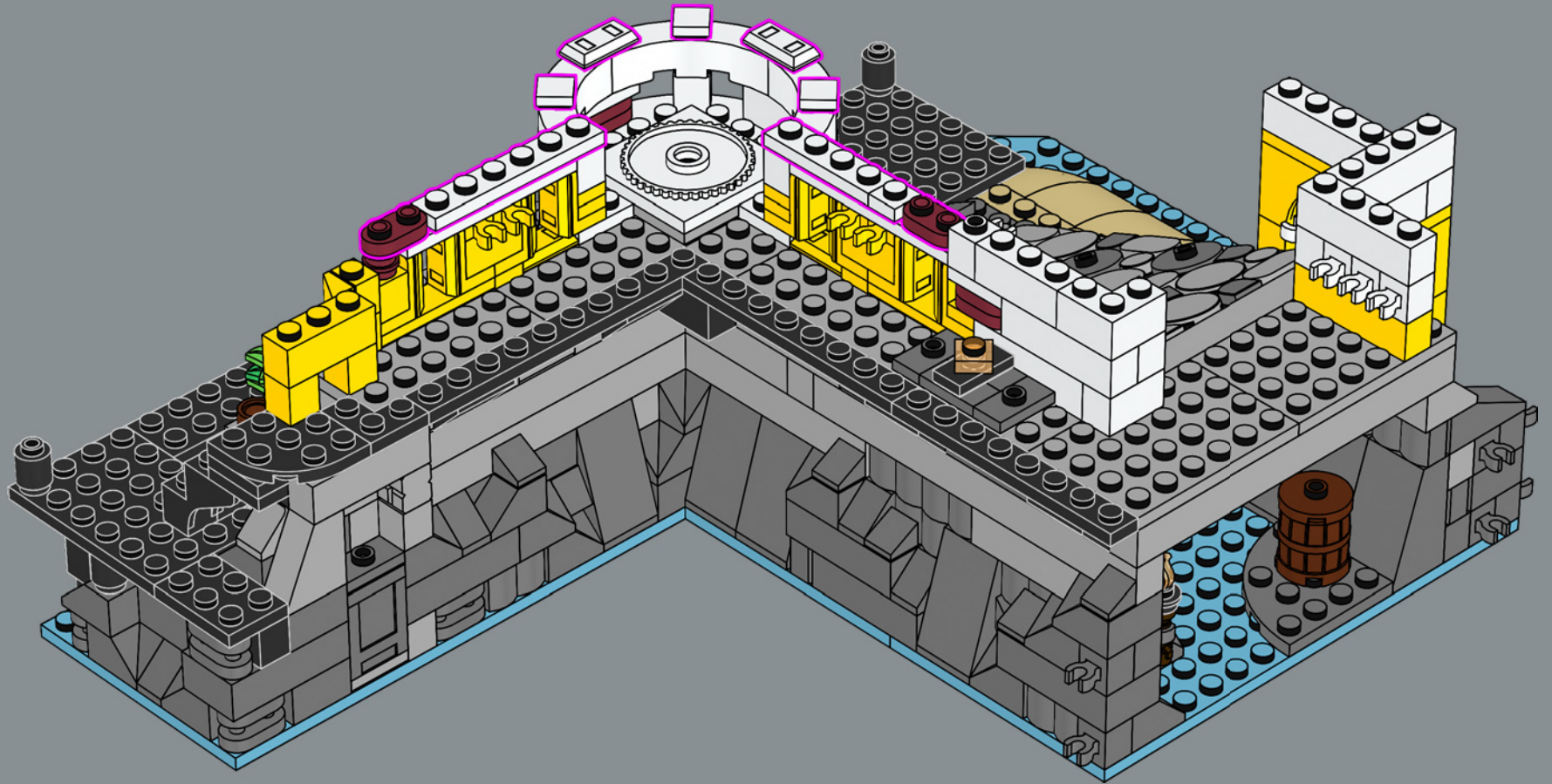

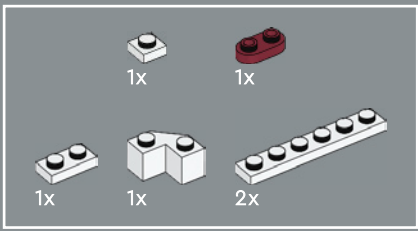

112

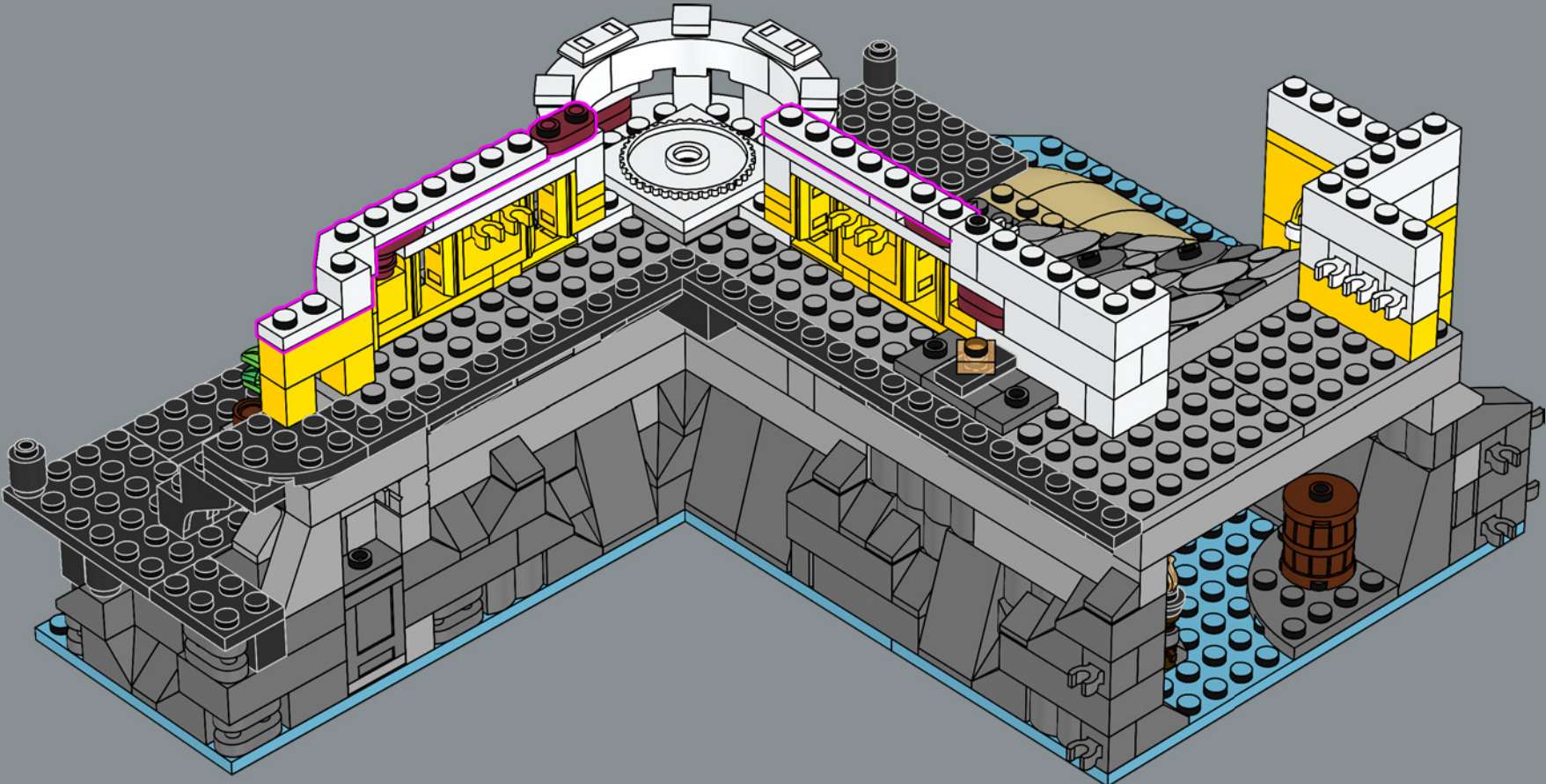

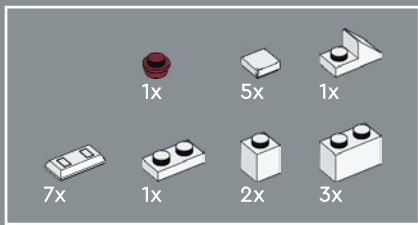

113

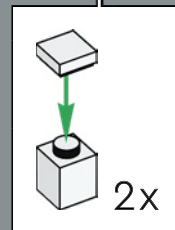
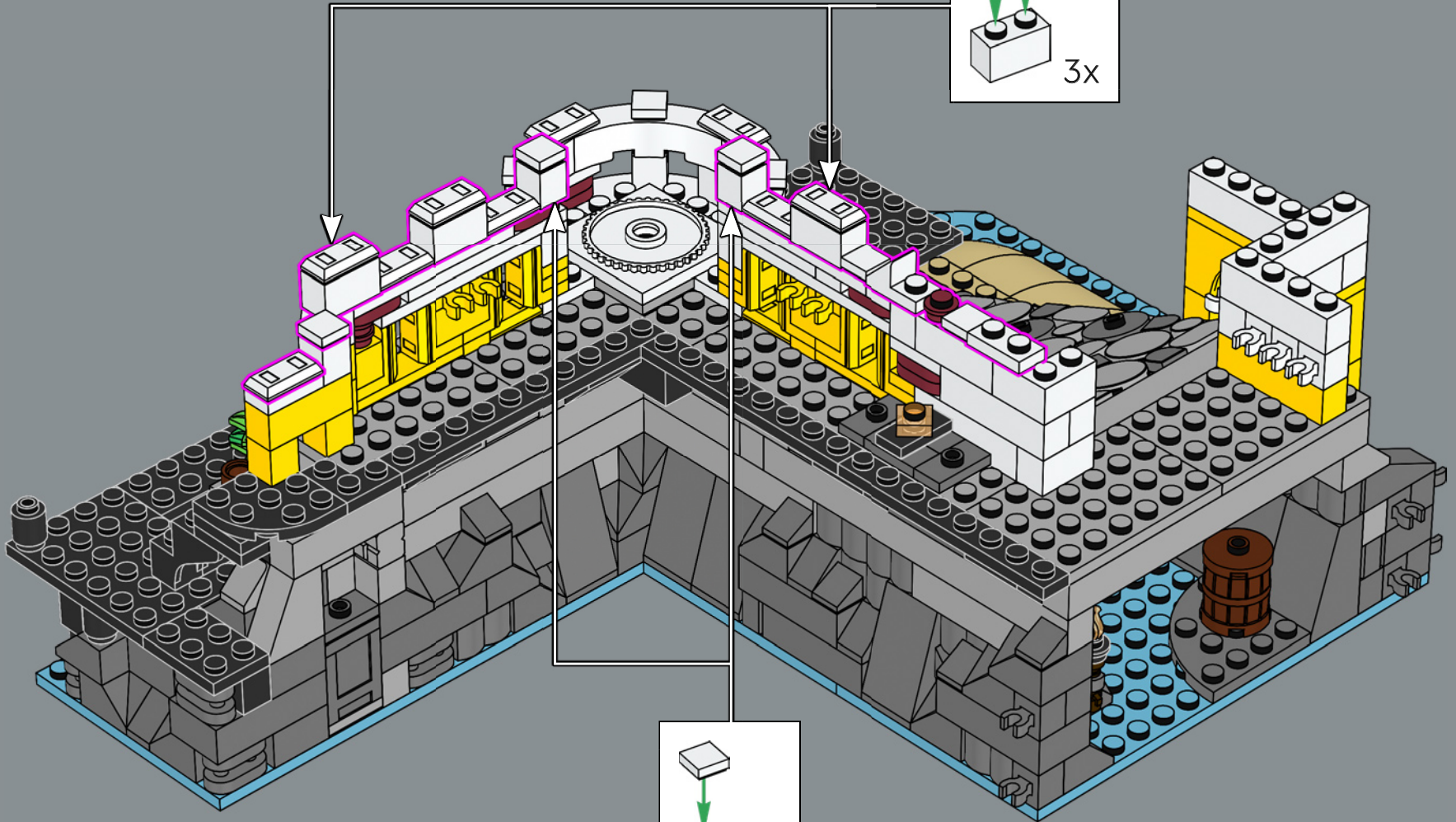
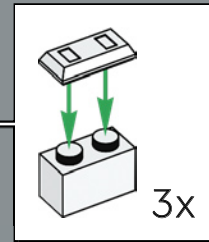

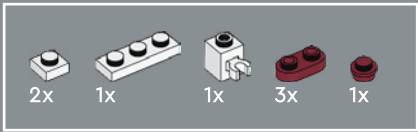

114

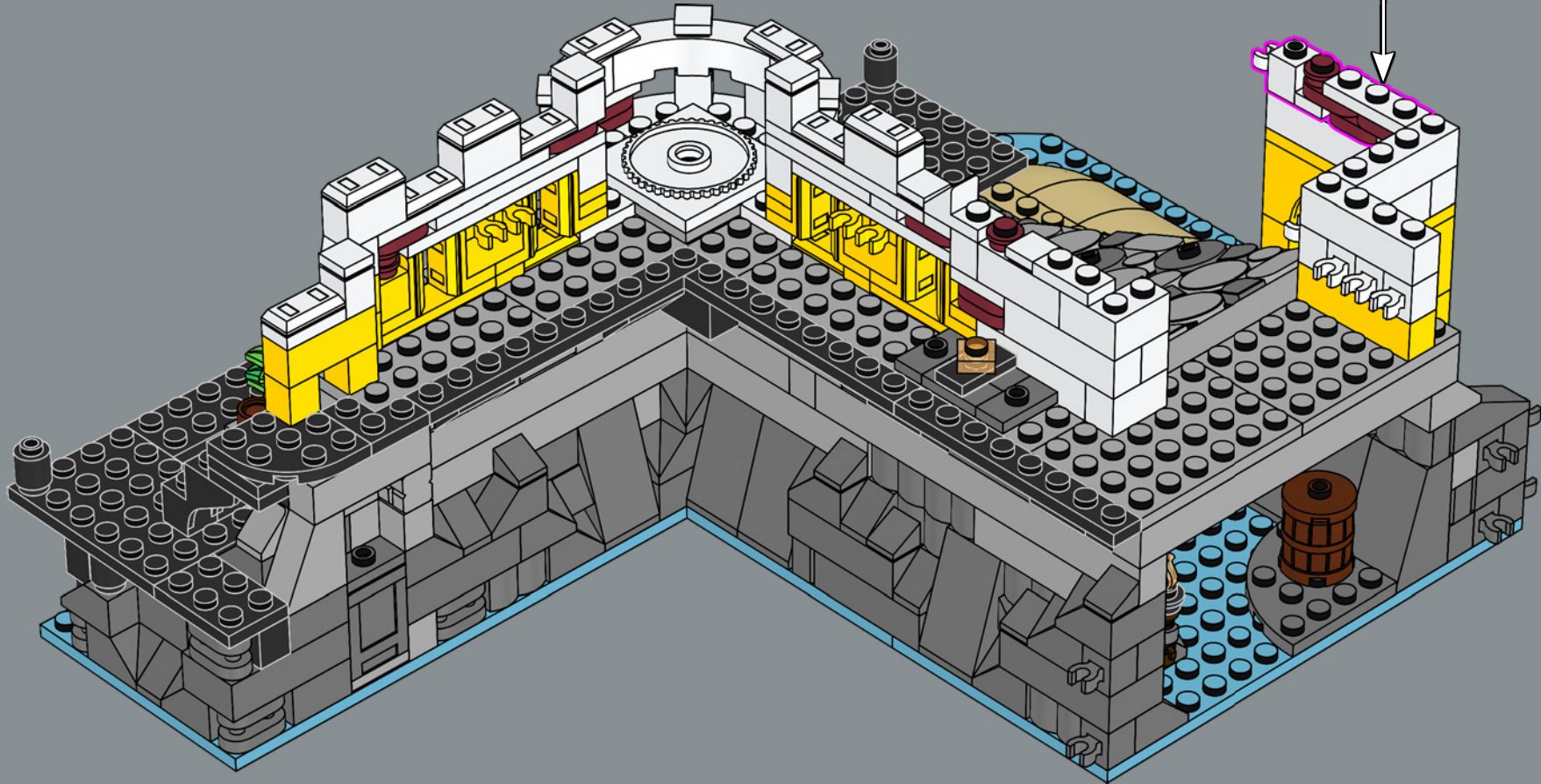
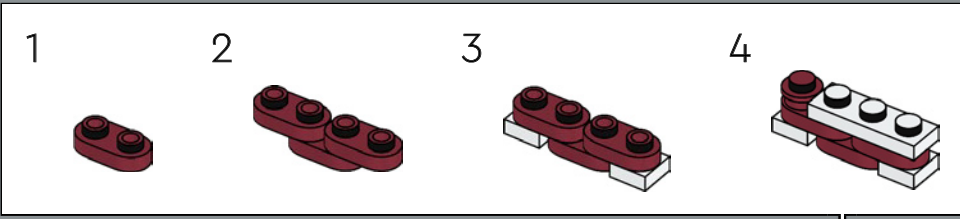

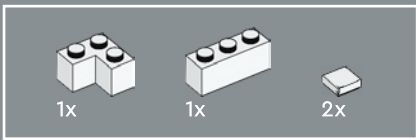

115

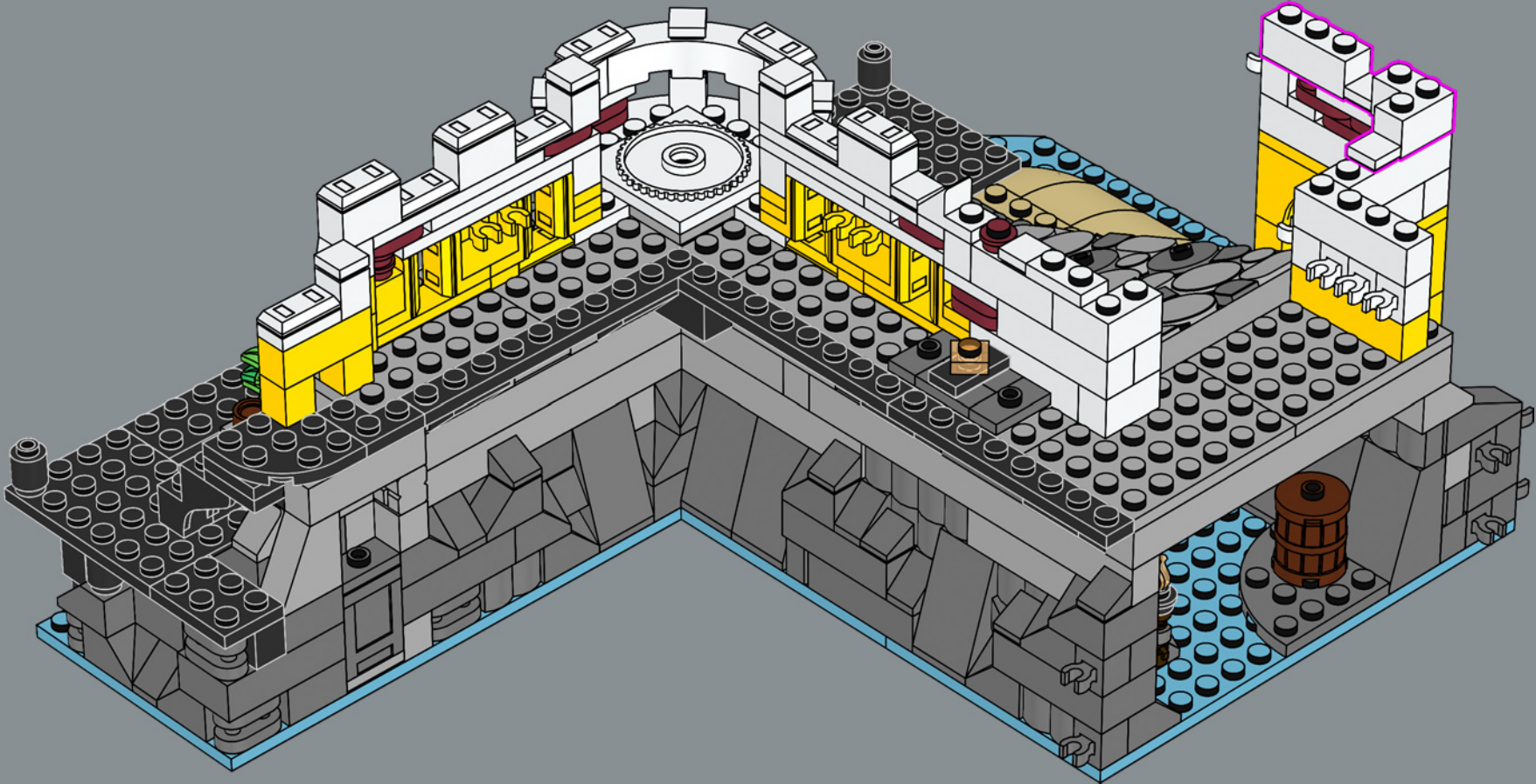

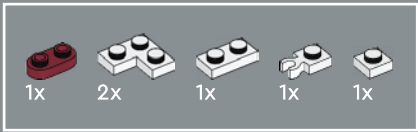

116

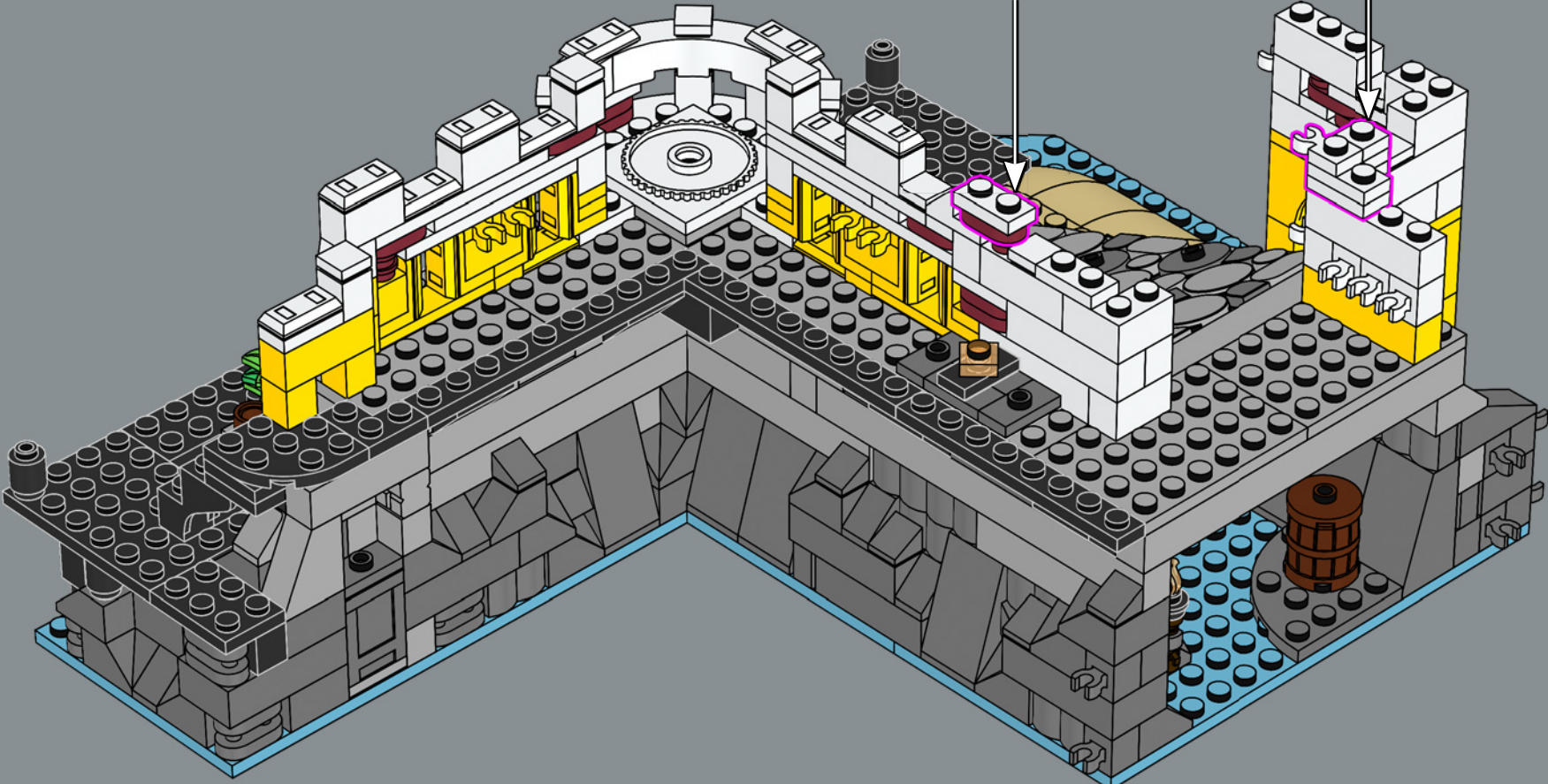
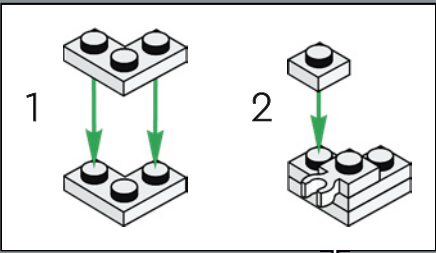
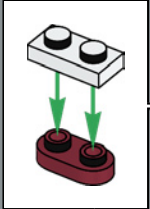



117

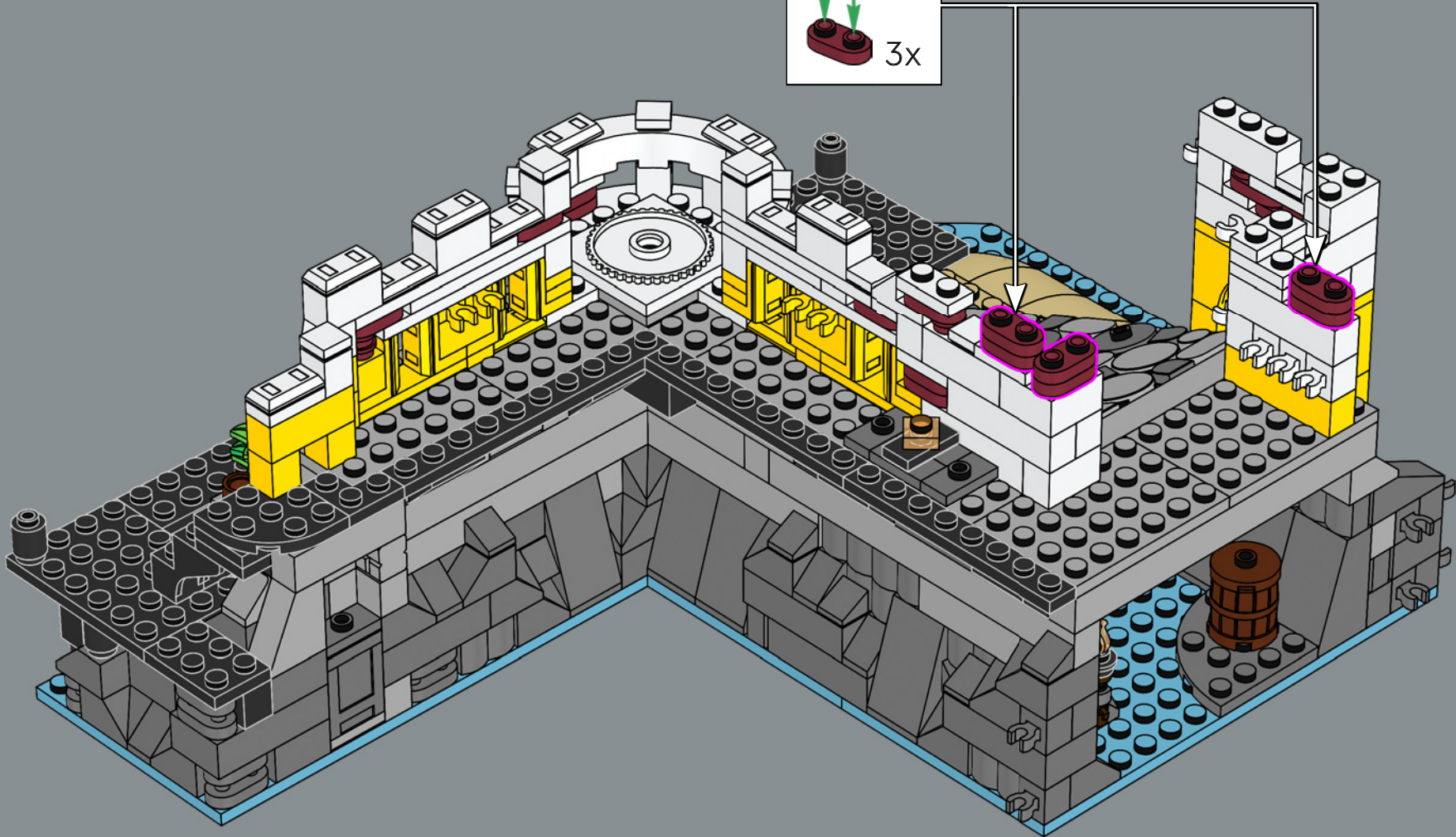
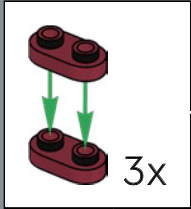

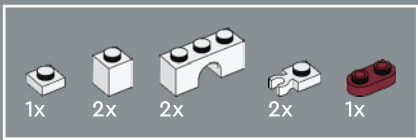

118

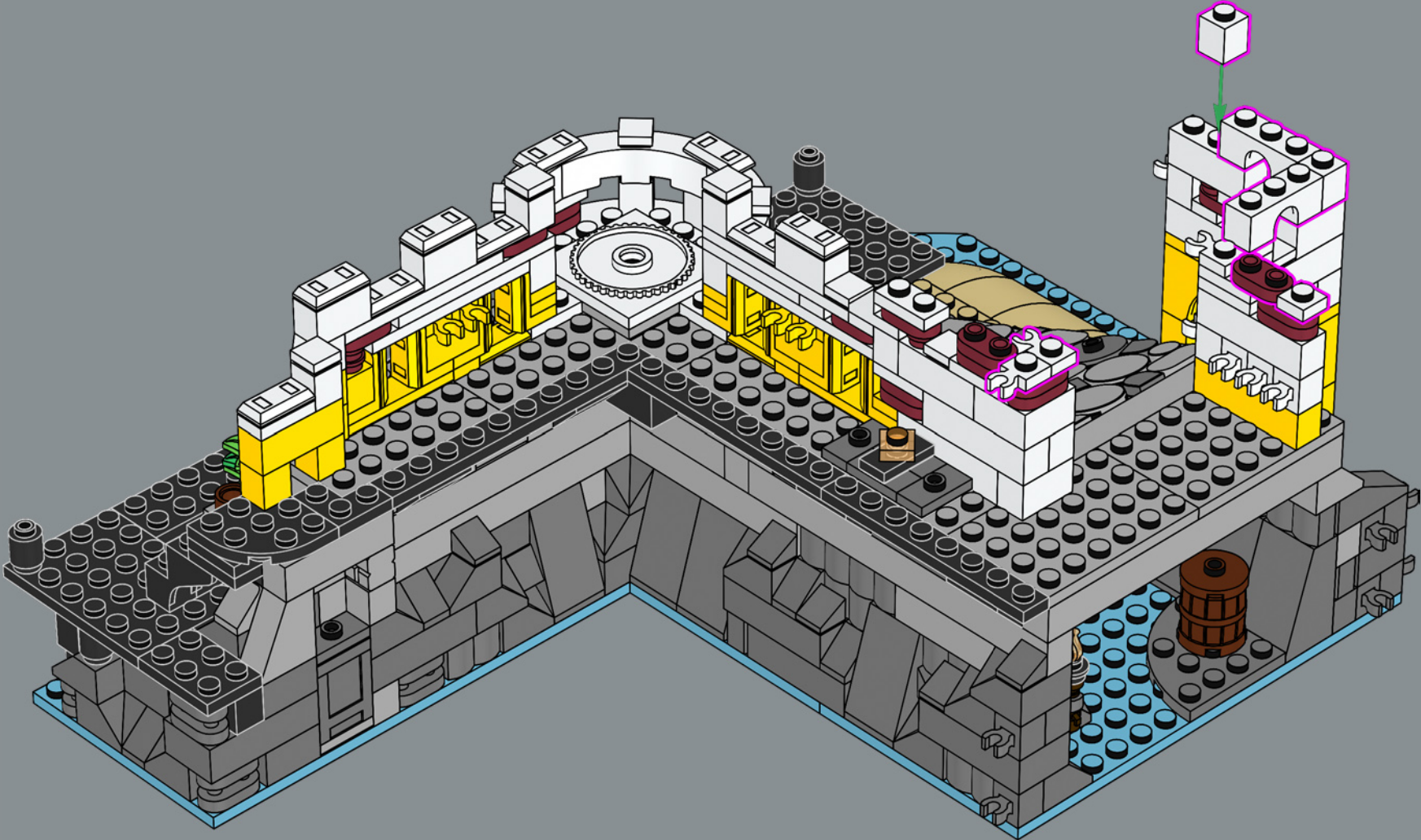

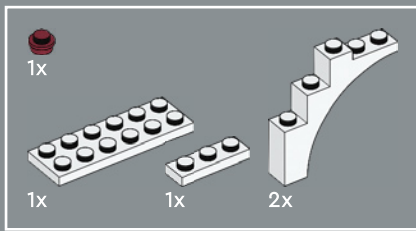

119

1

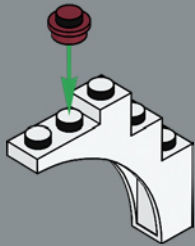

2

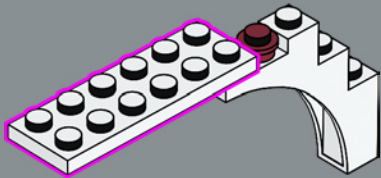

3

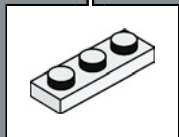
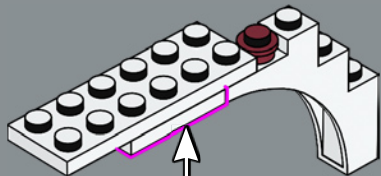

4

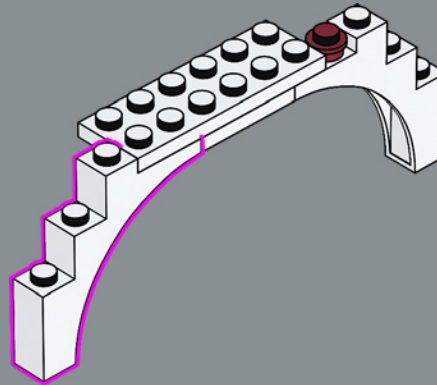

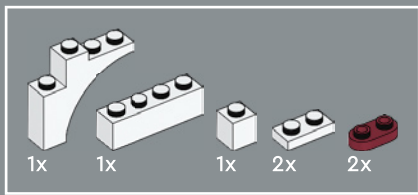

120

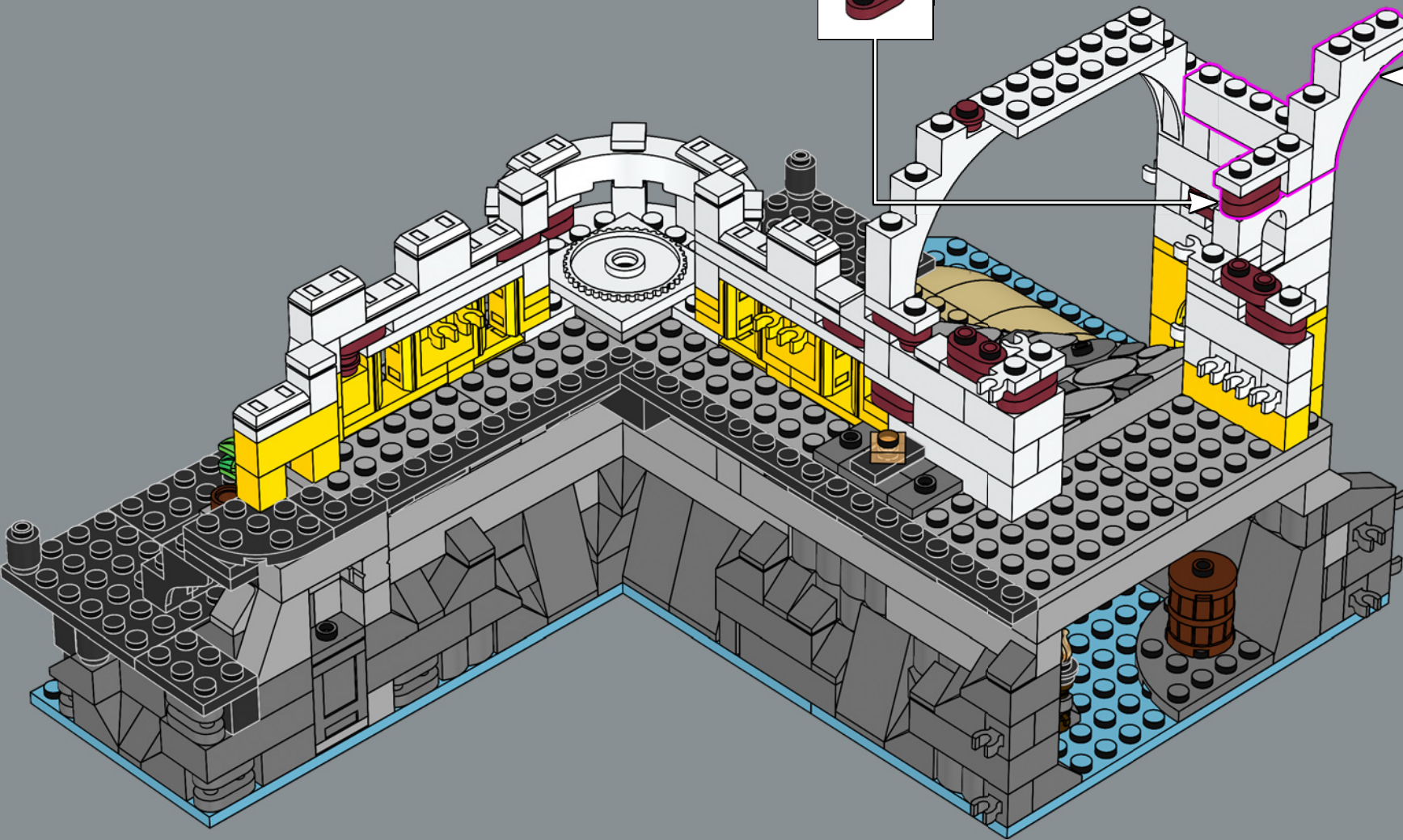
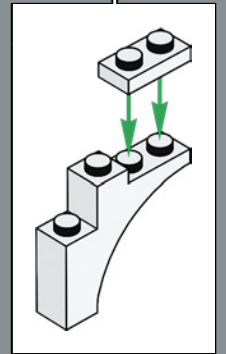
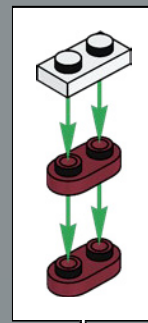

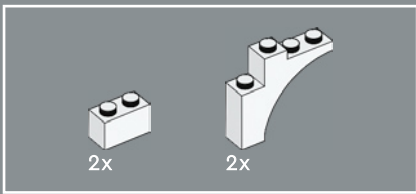

121

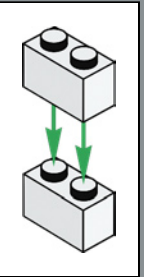
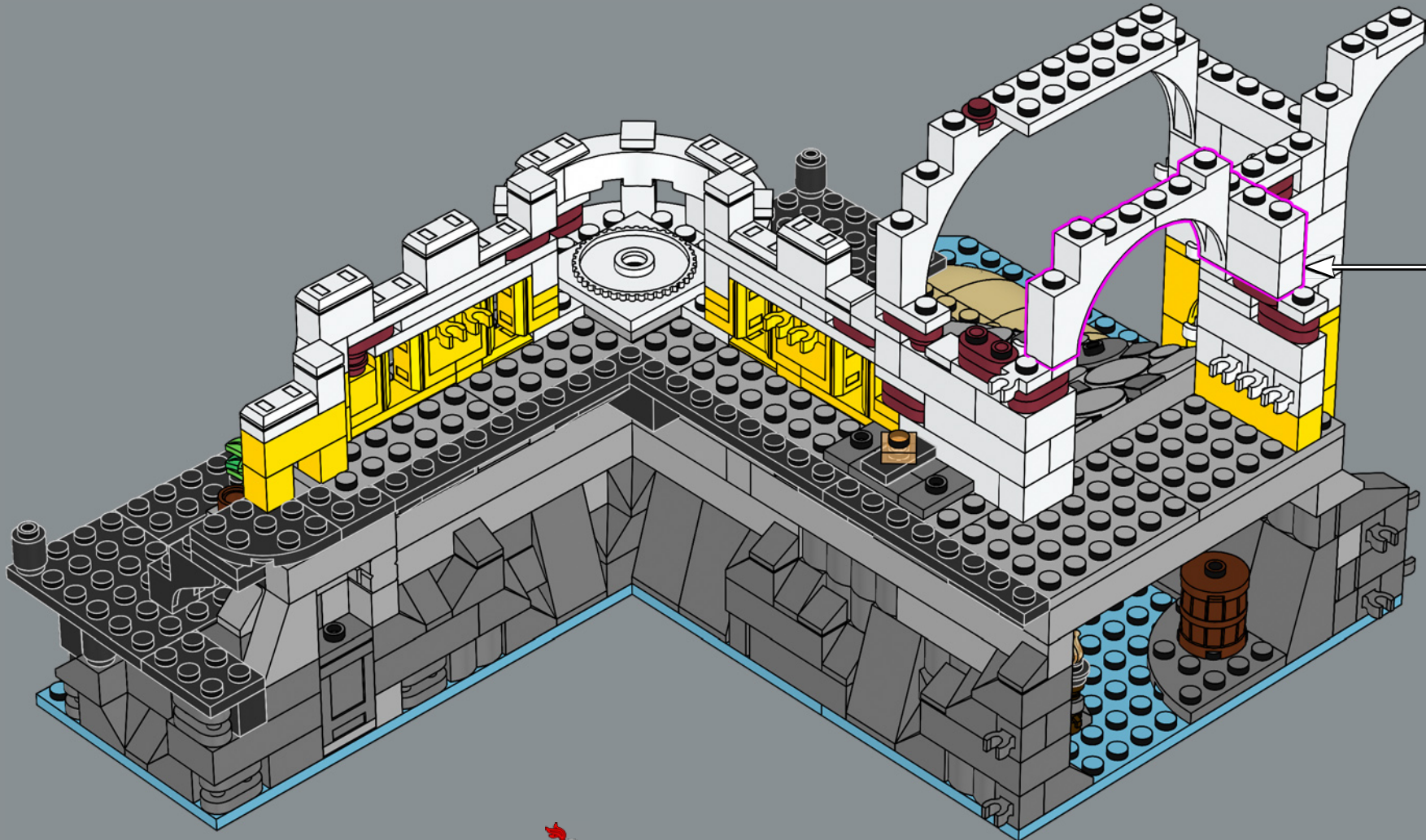

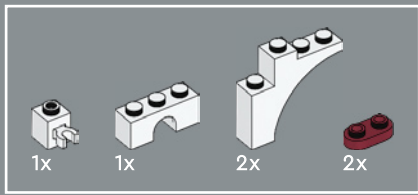

122

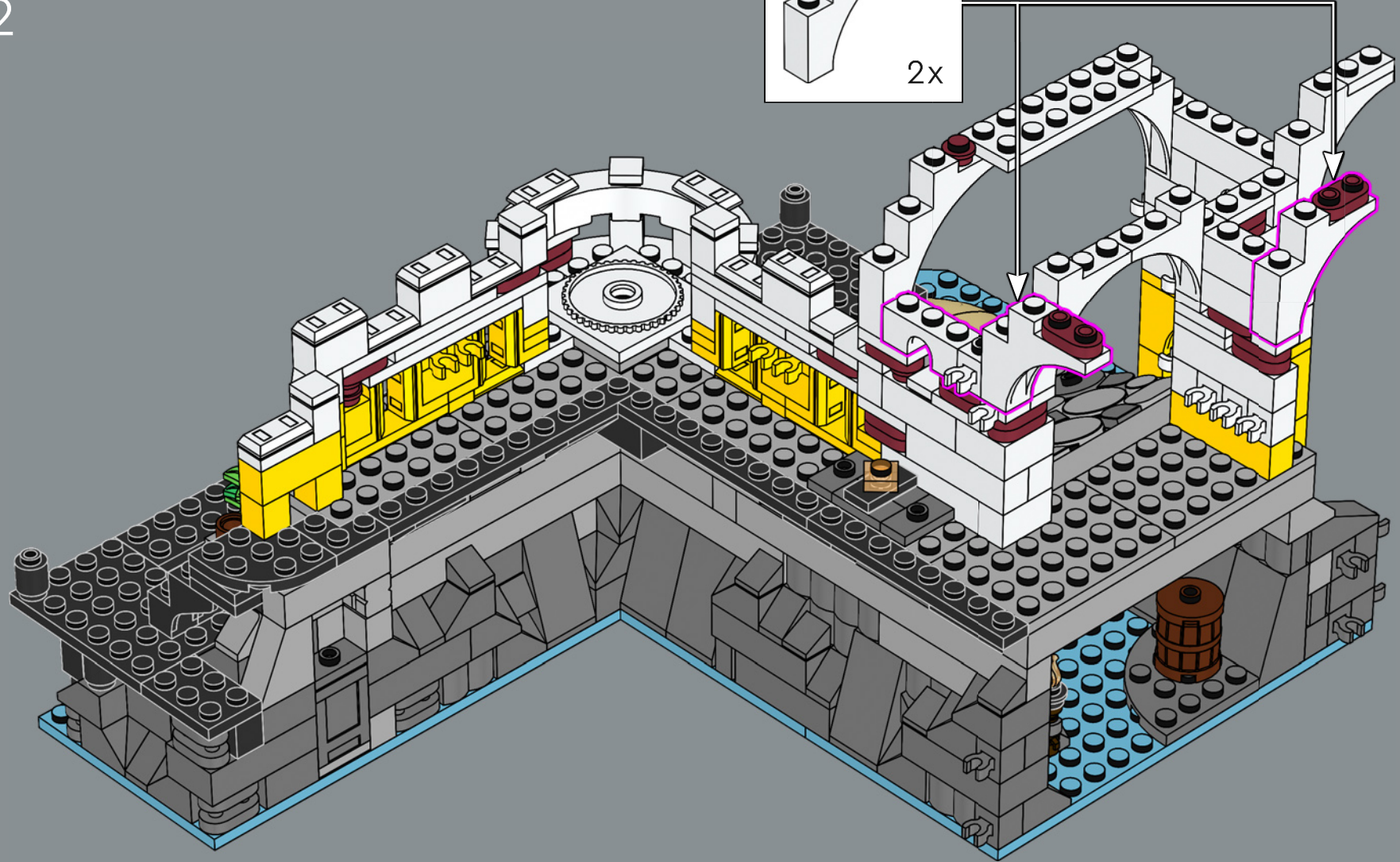
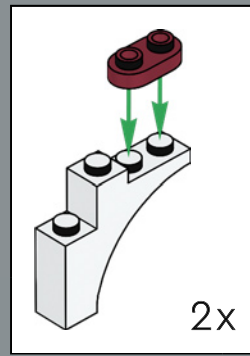



123

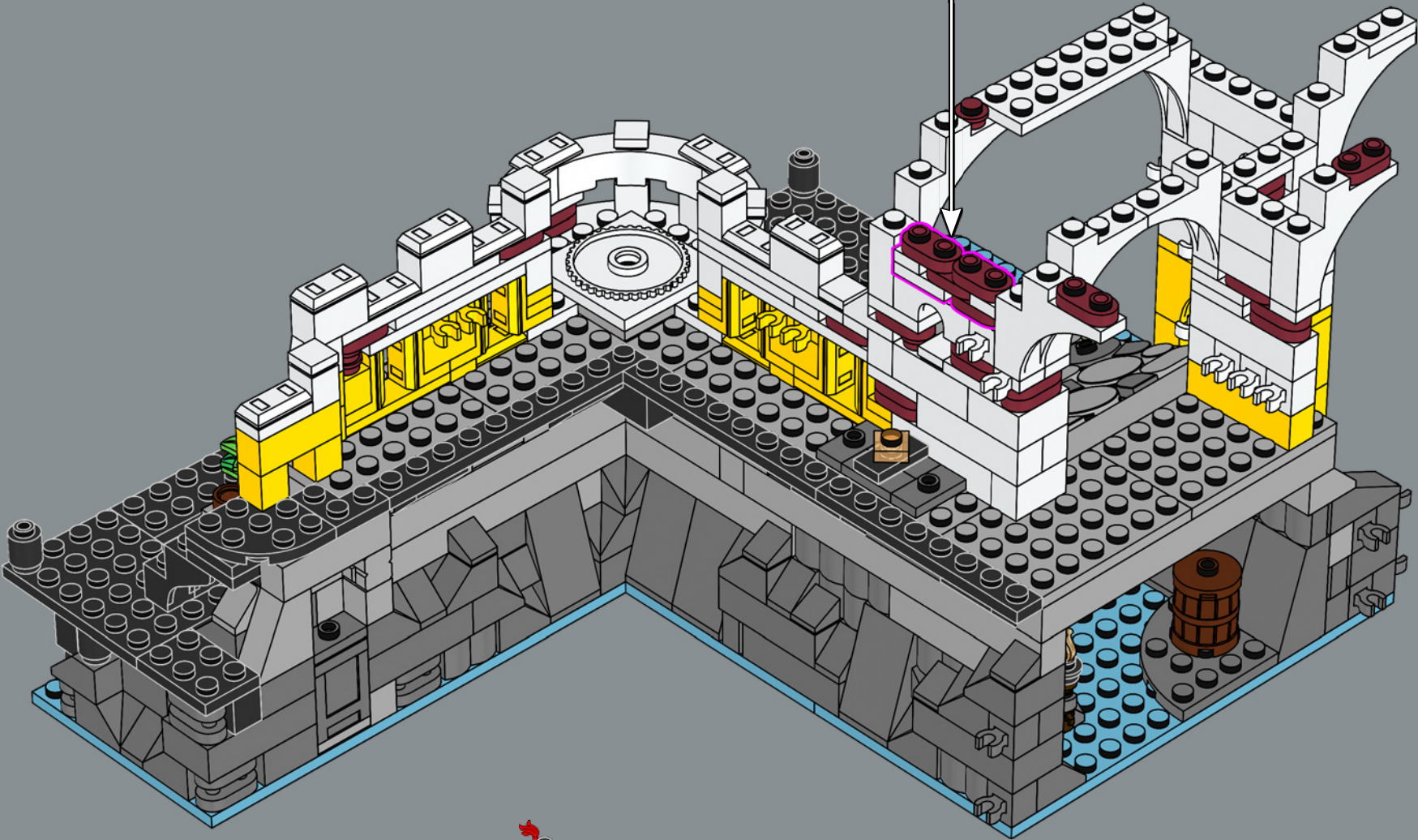
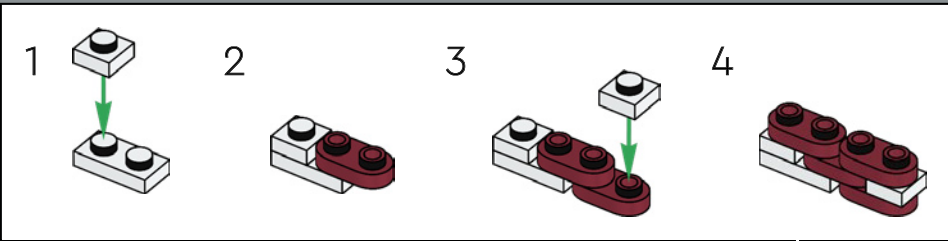

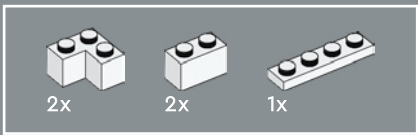

124

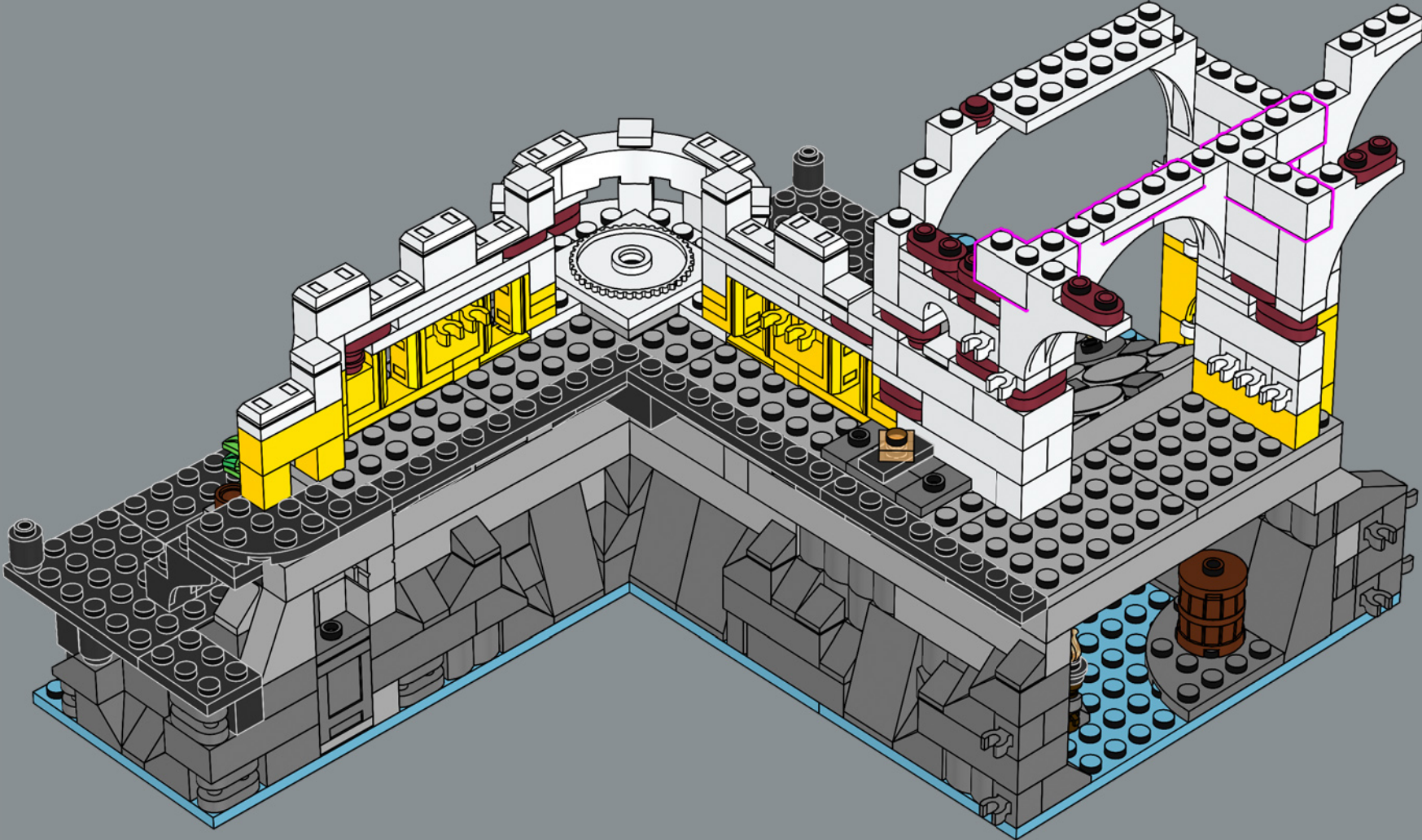

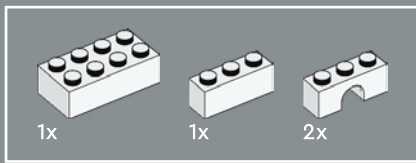

125

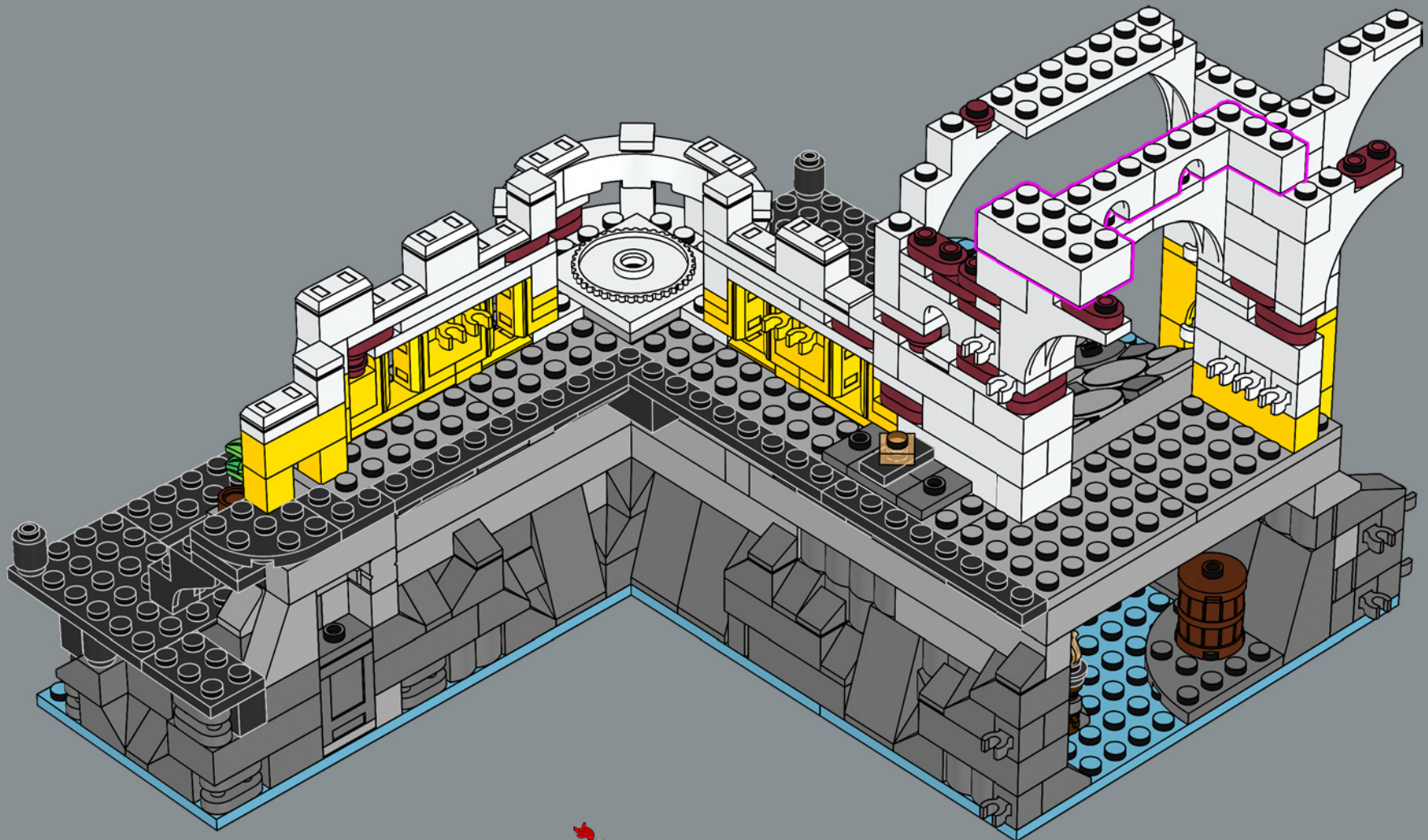

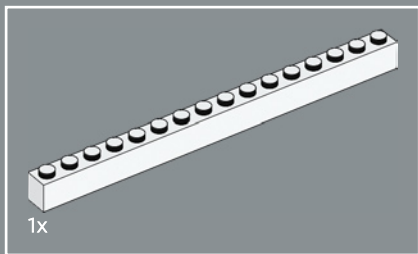

126

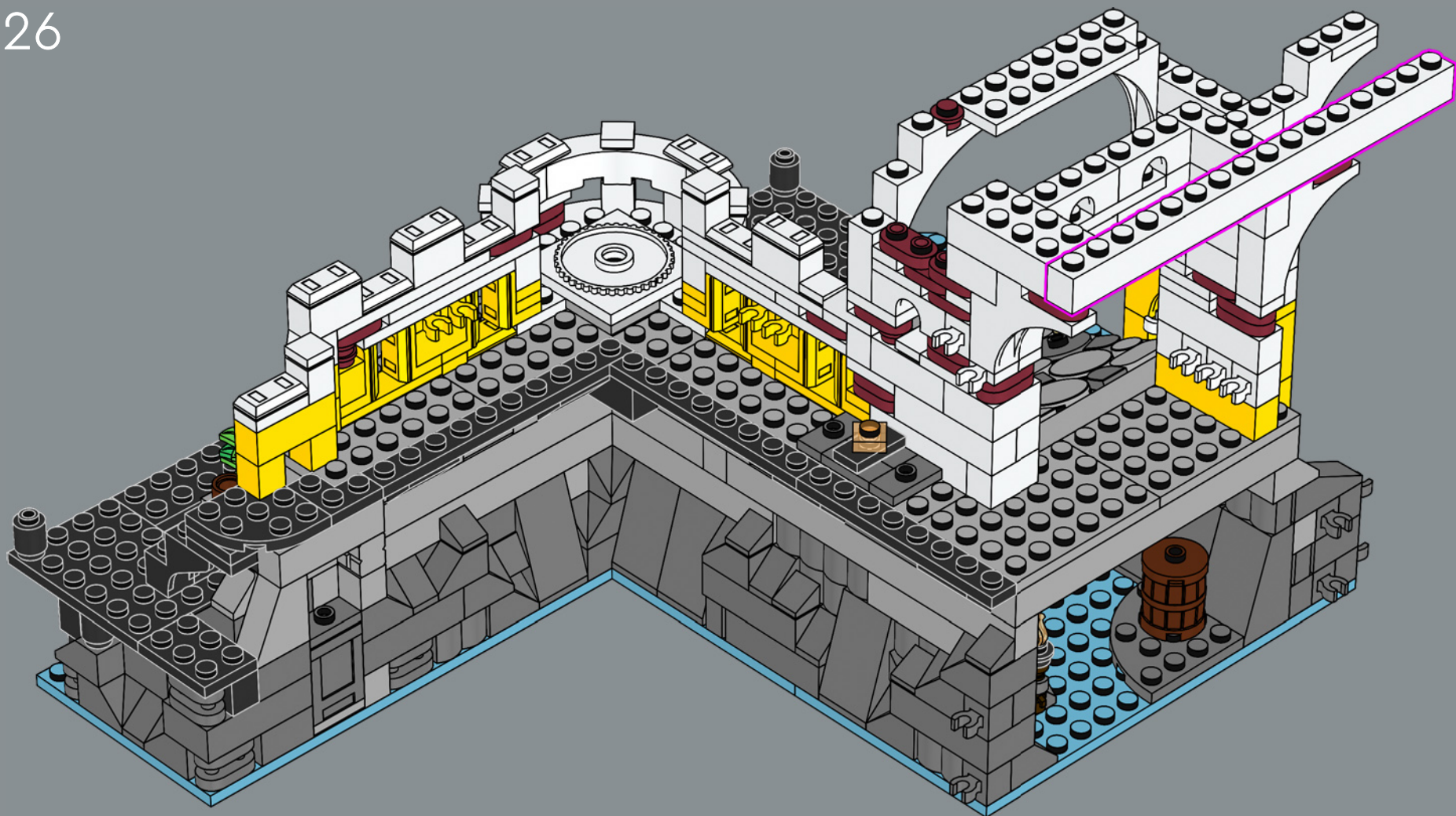

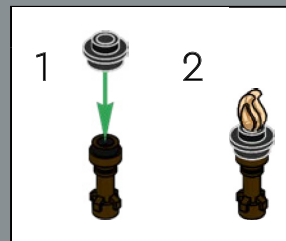
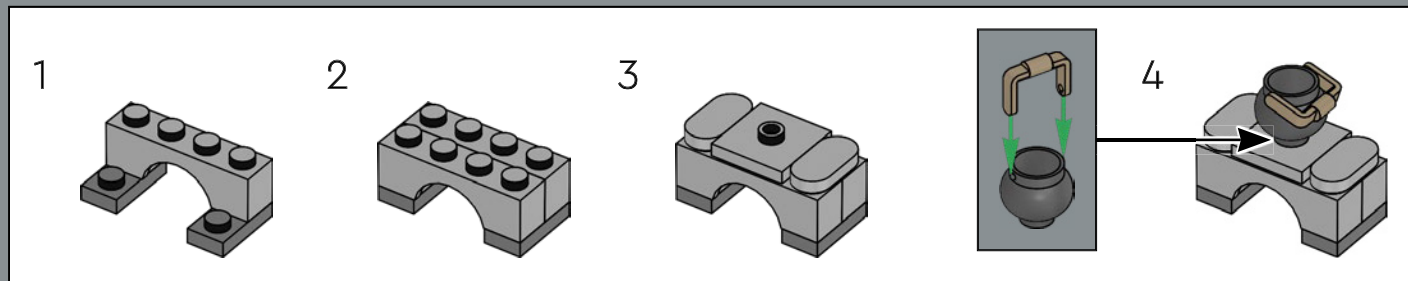
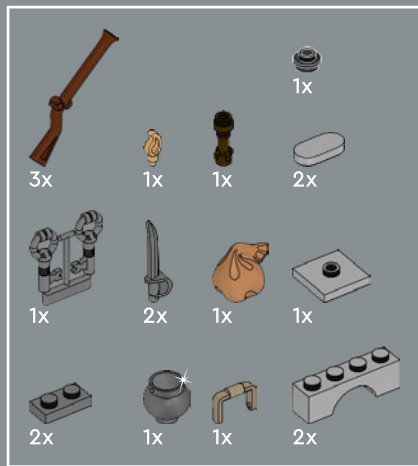

127



¡Los marineros, los piratas y los guardias también comen! ¿Qué se está cocinando? ¿Pescado? ¿Coco? ¿Plátanos?



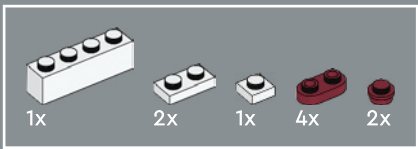

128

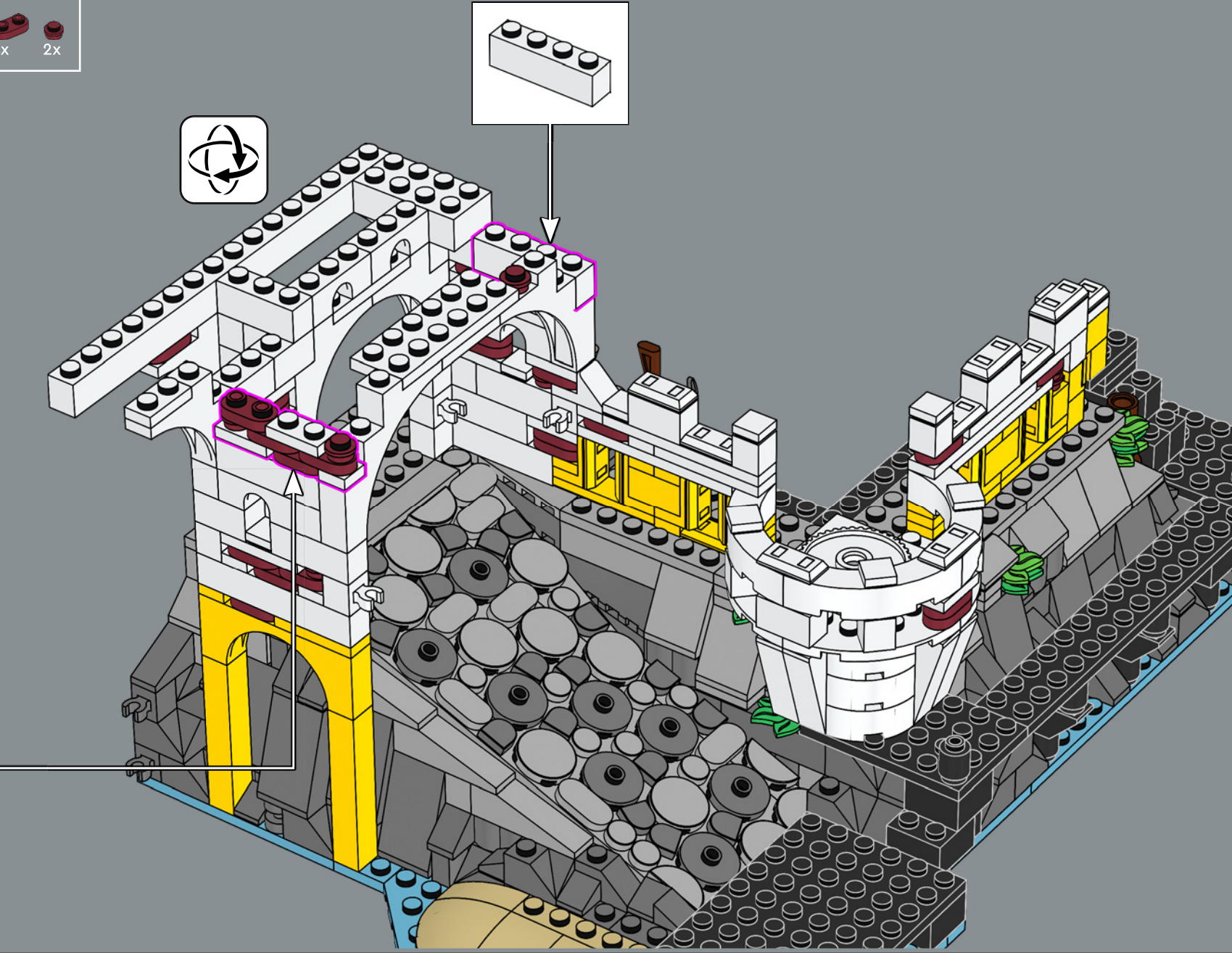
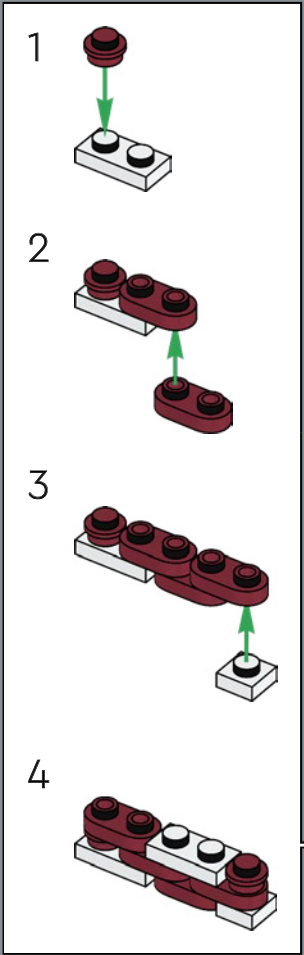
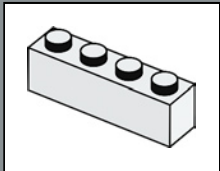

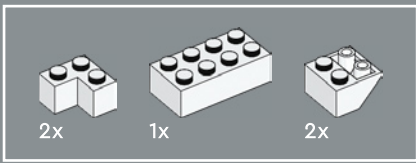

129

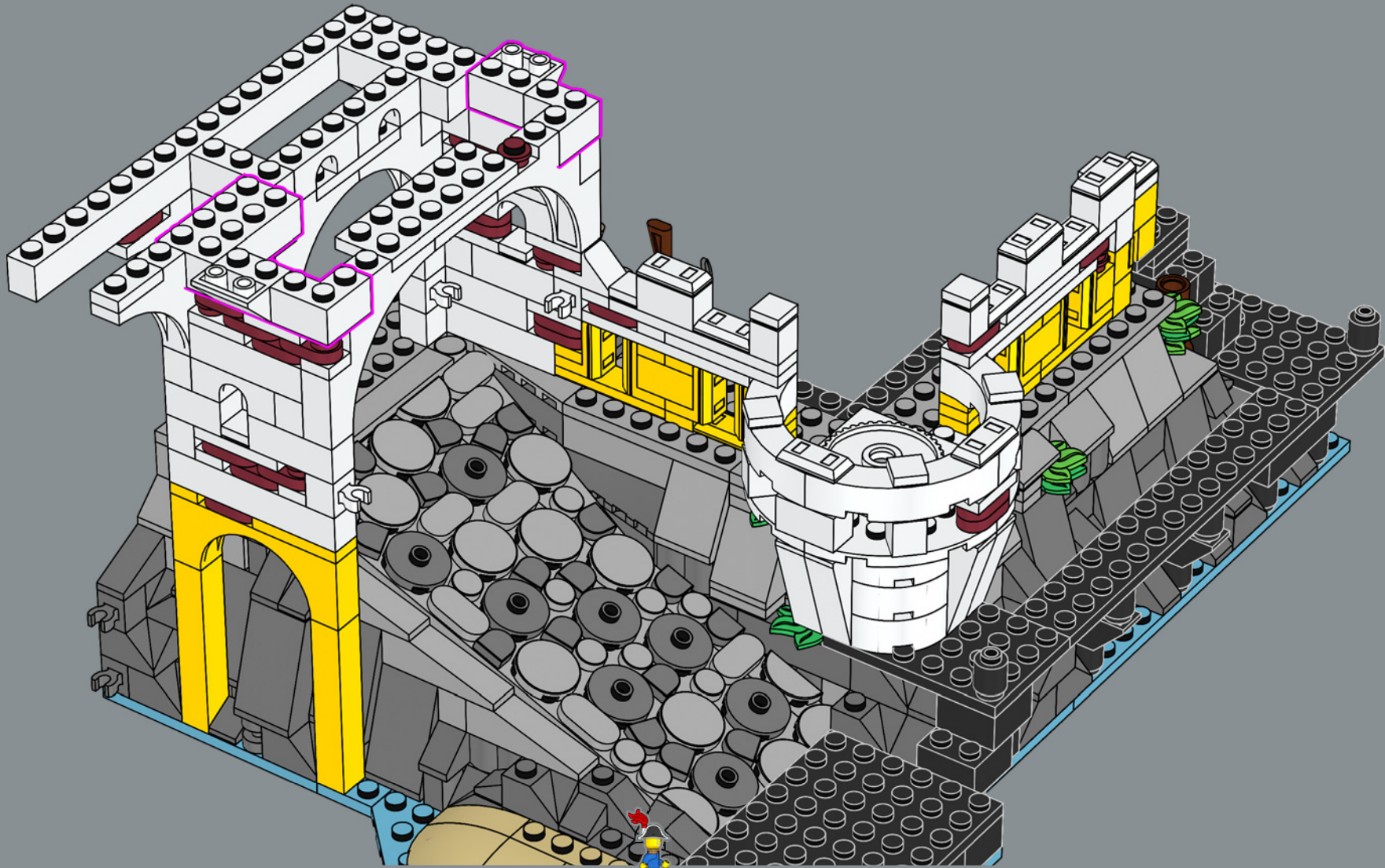

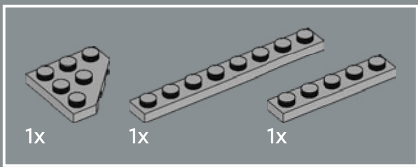

130

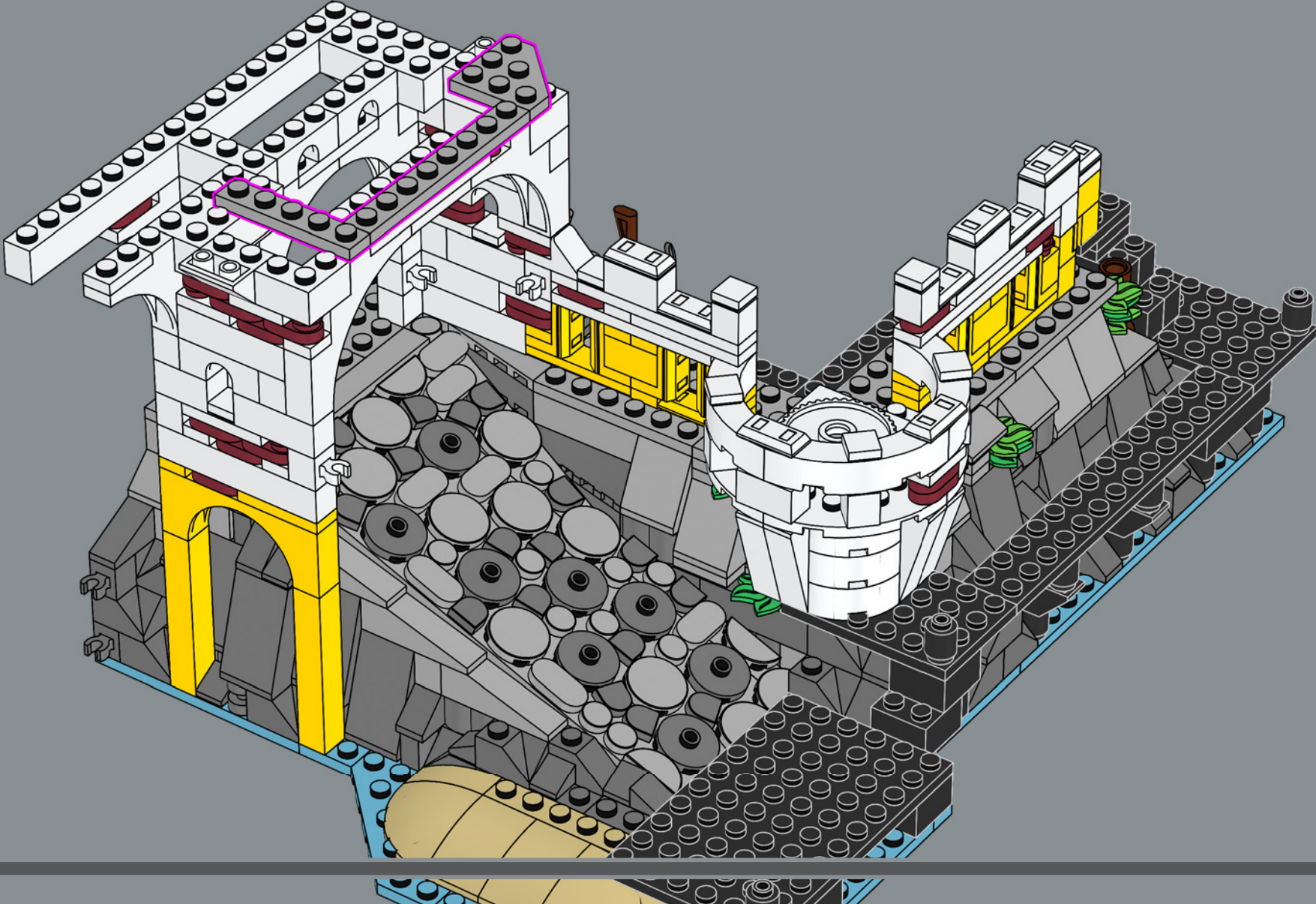

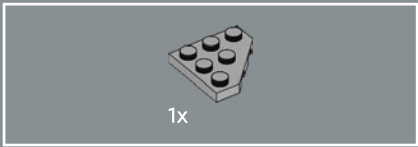

131

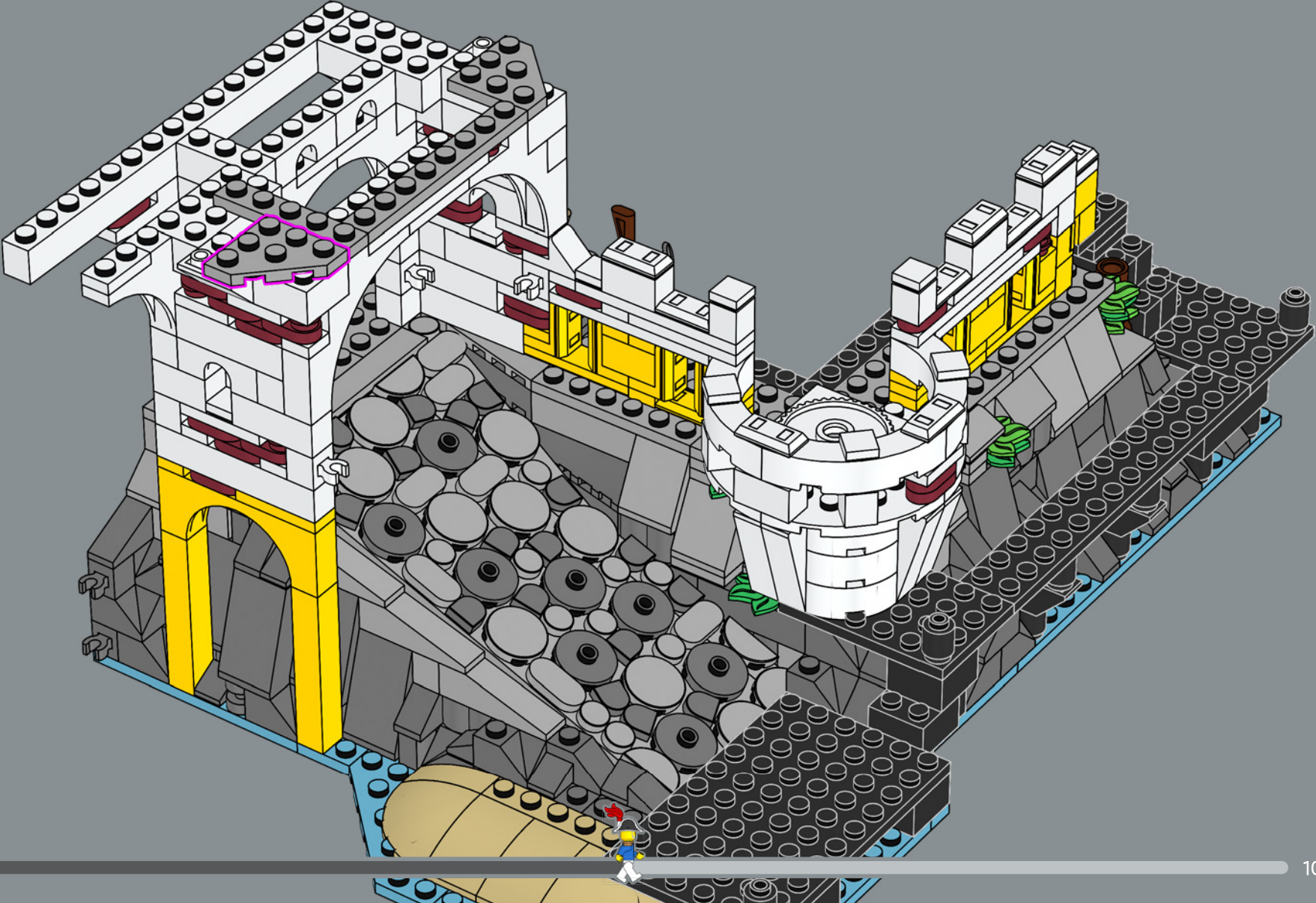



132

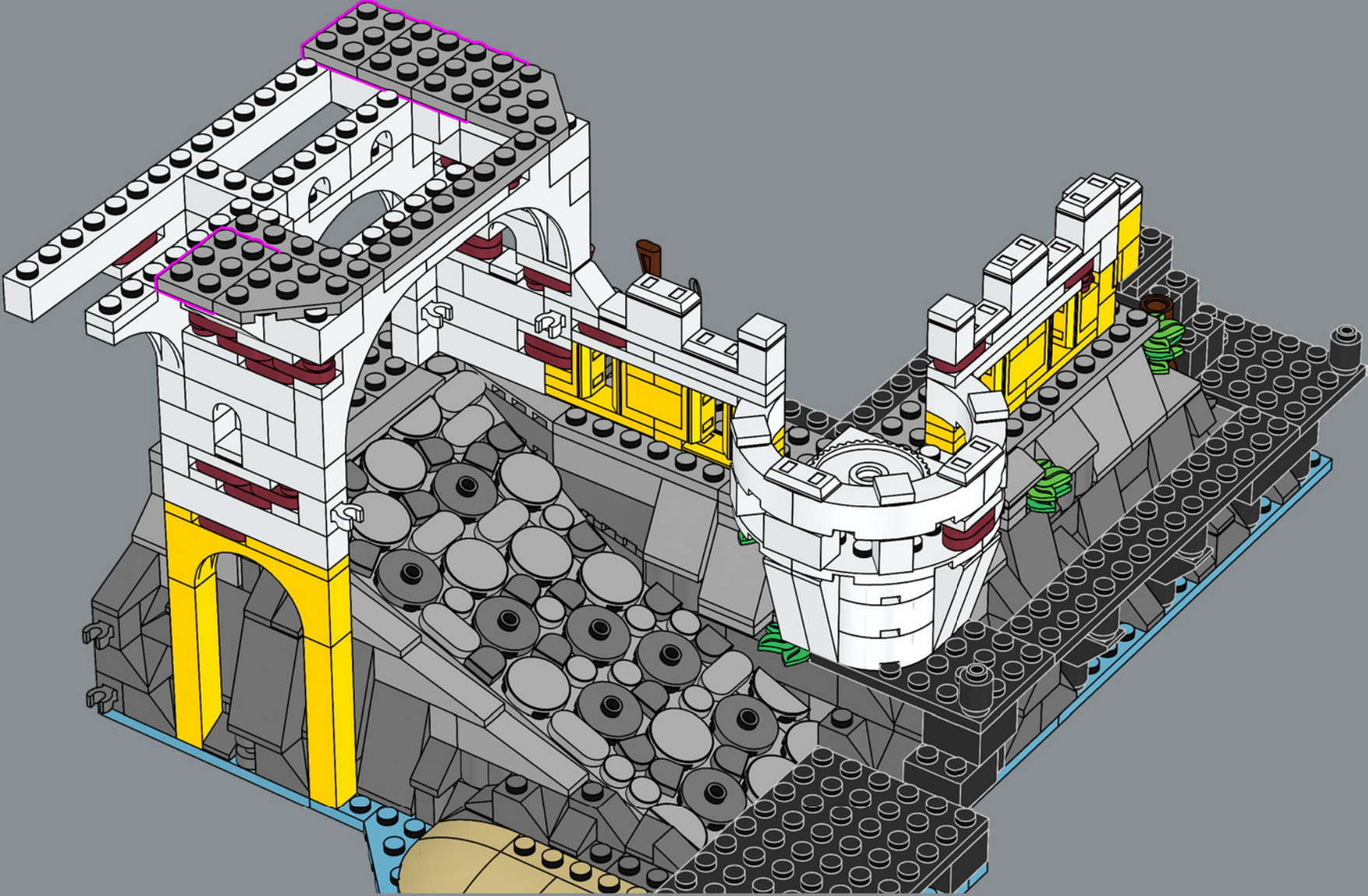

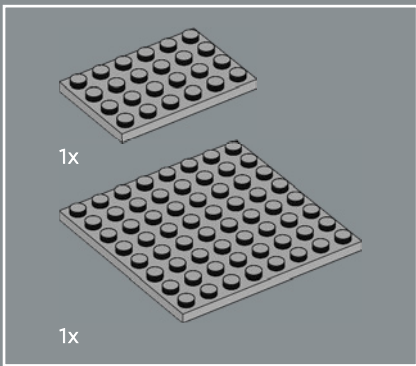

133

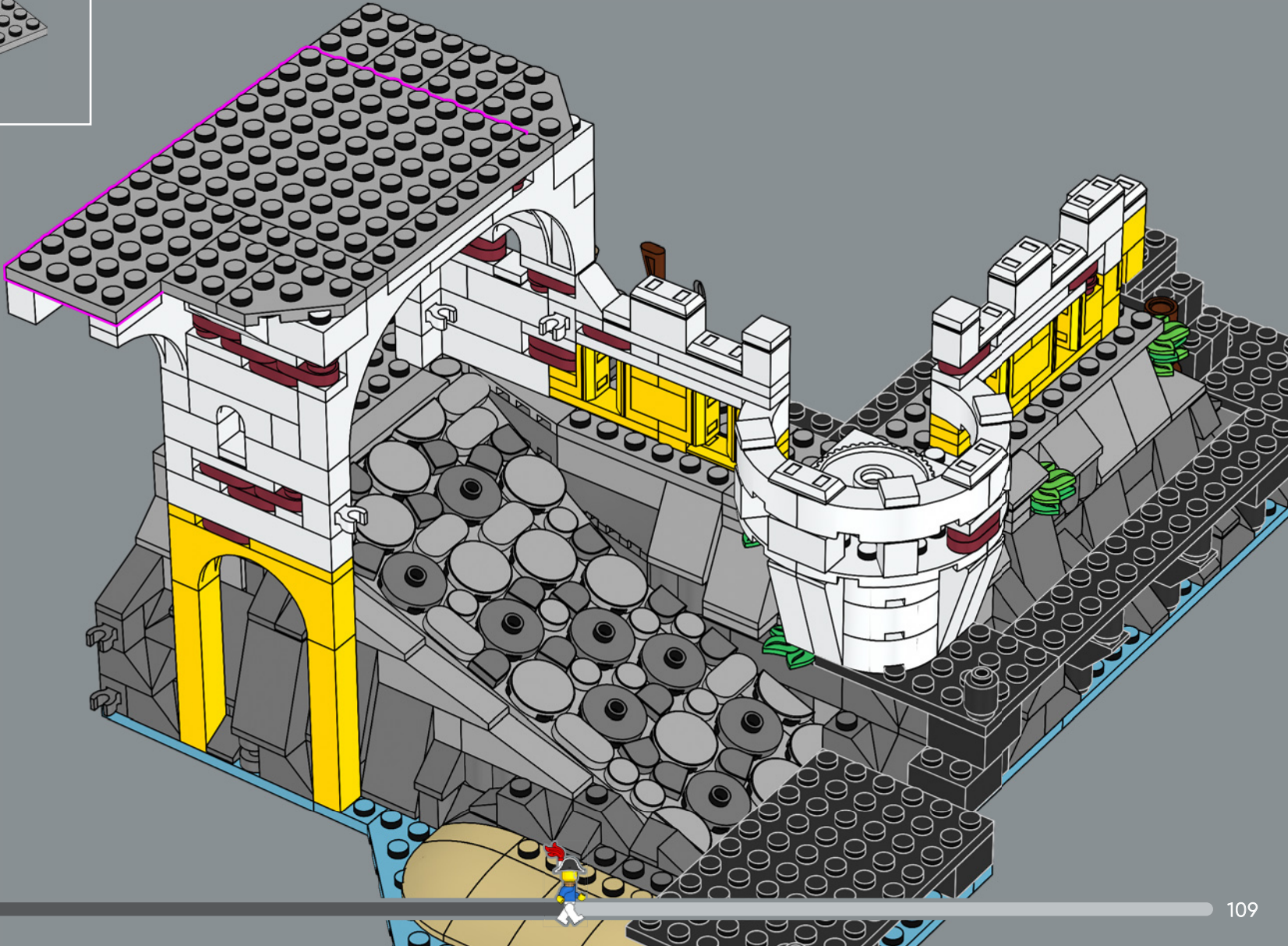

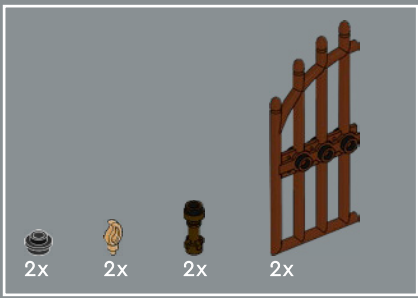

134

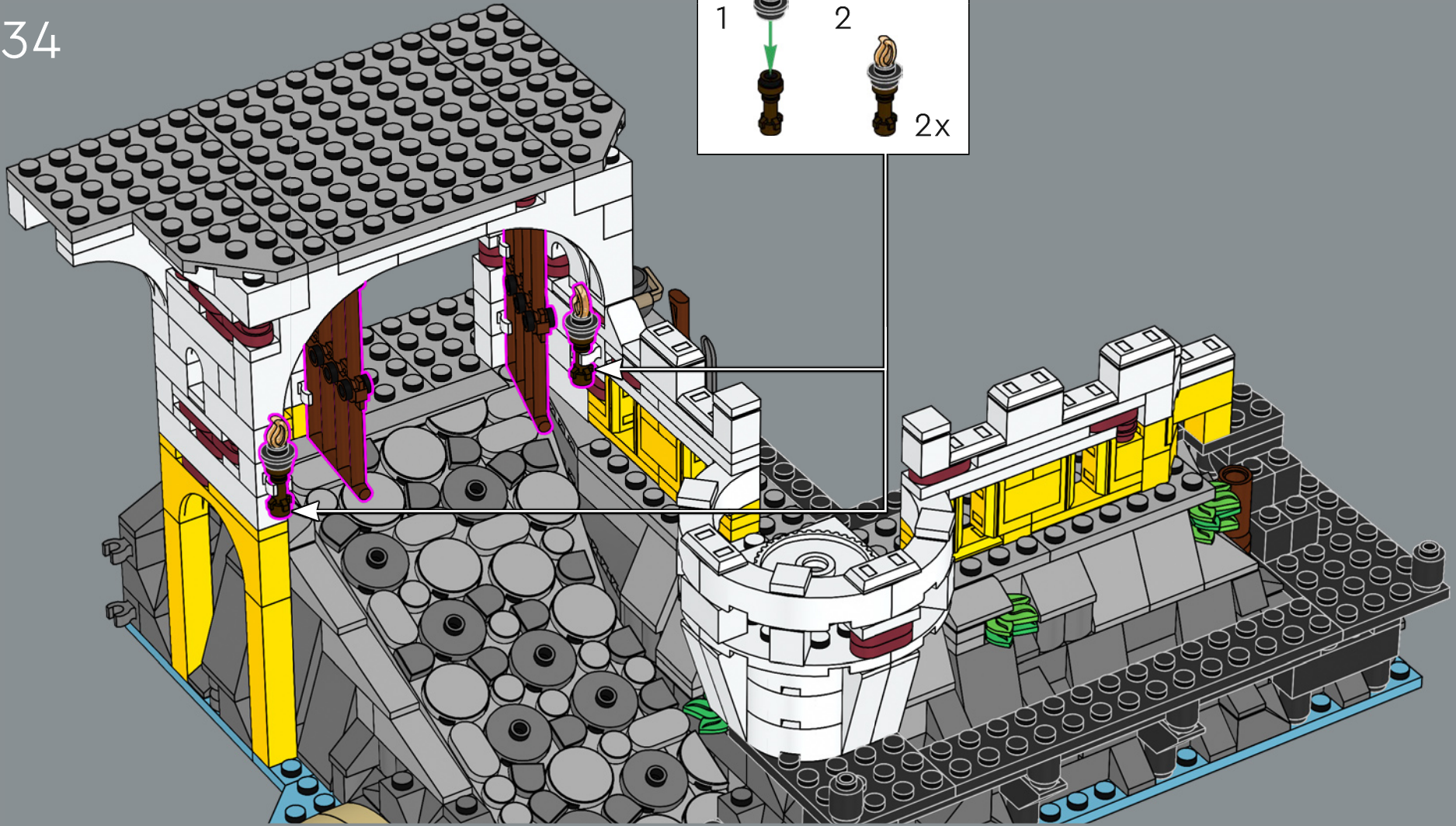
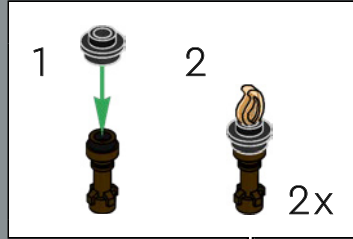

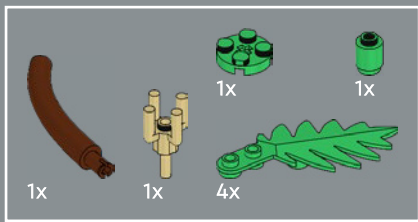

135

1

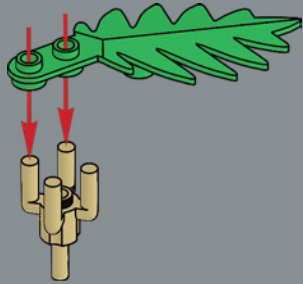

2

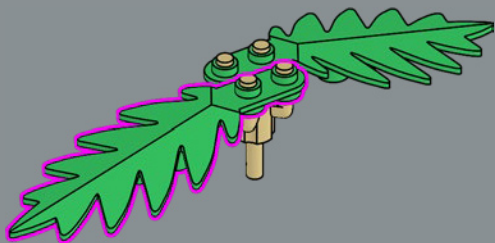

3



4



5



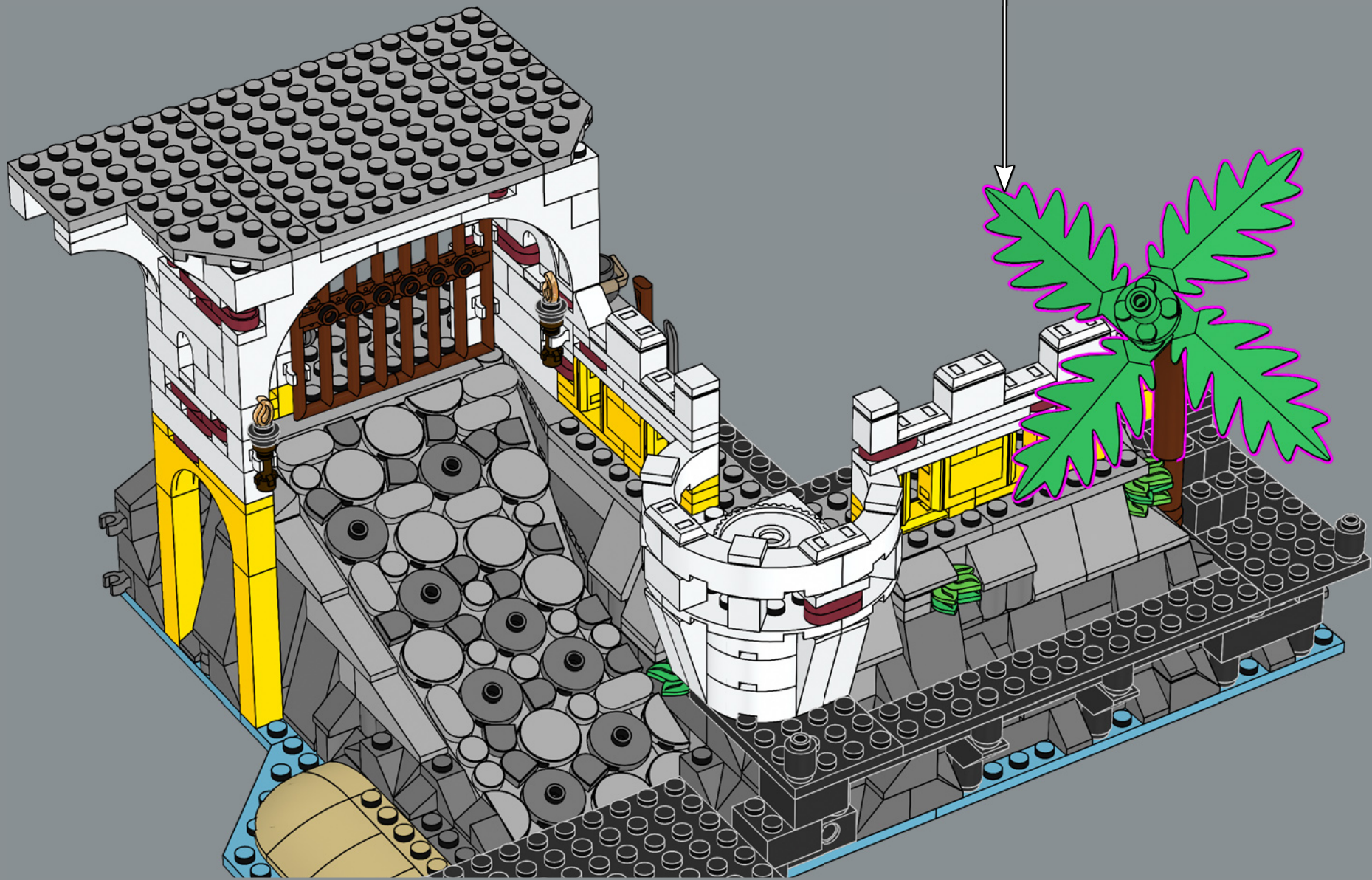

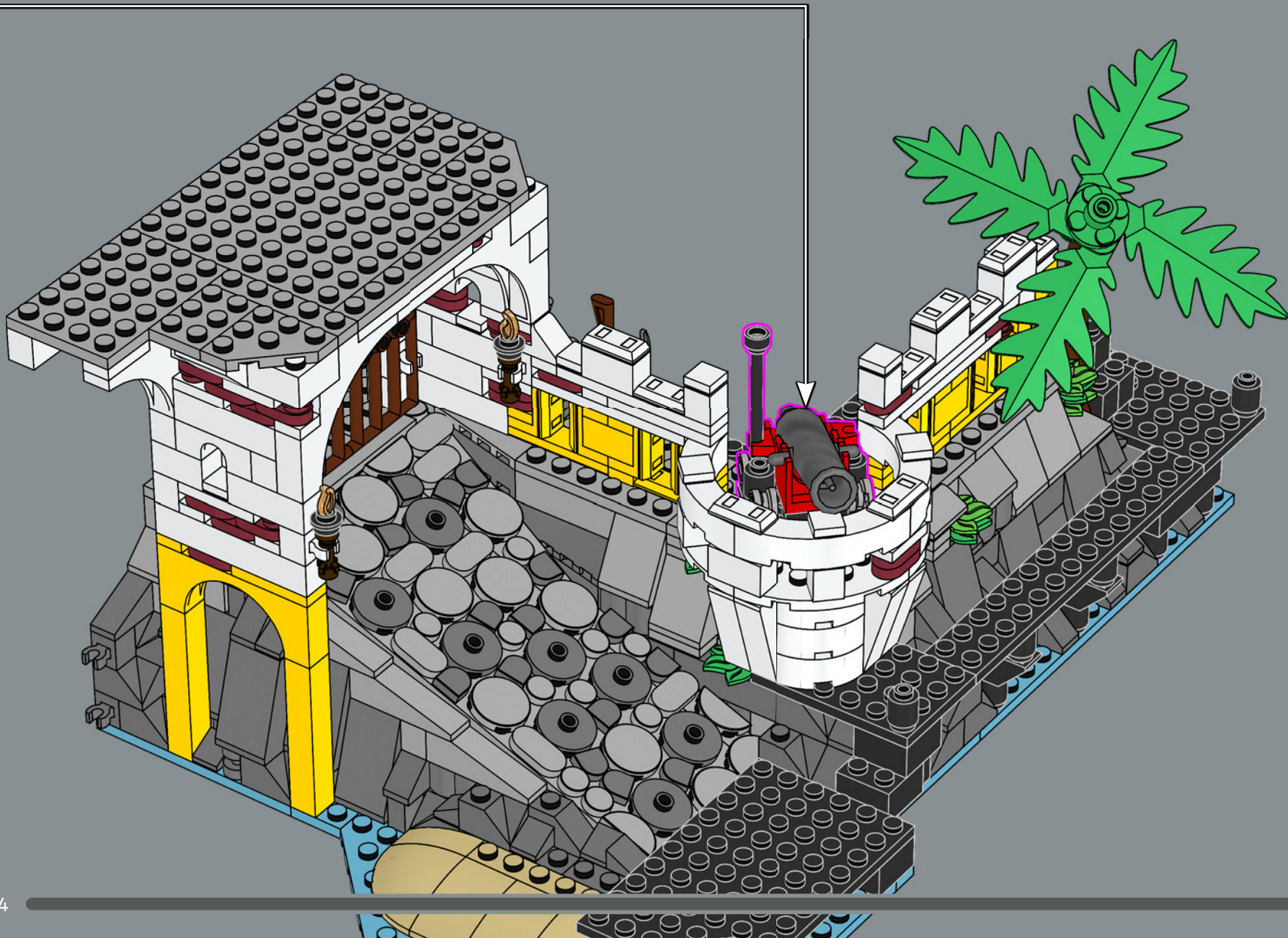

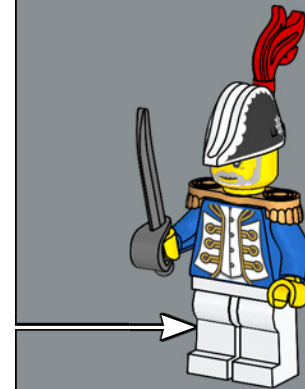
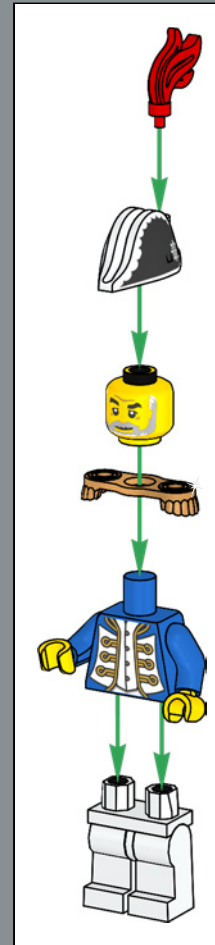

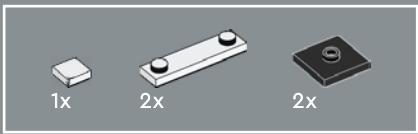

137

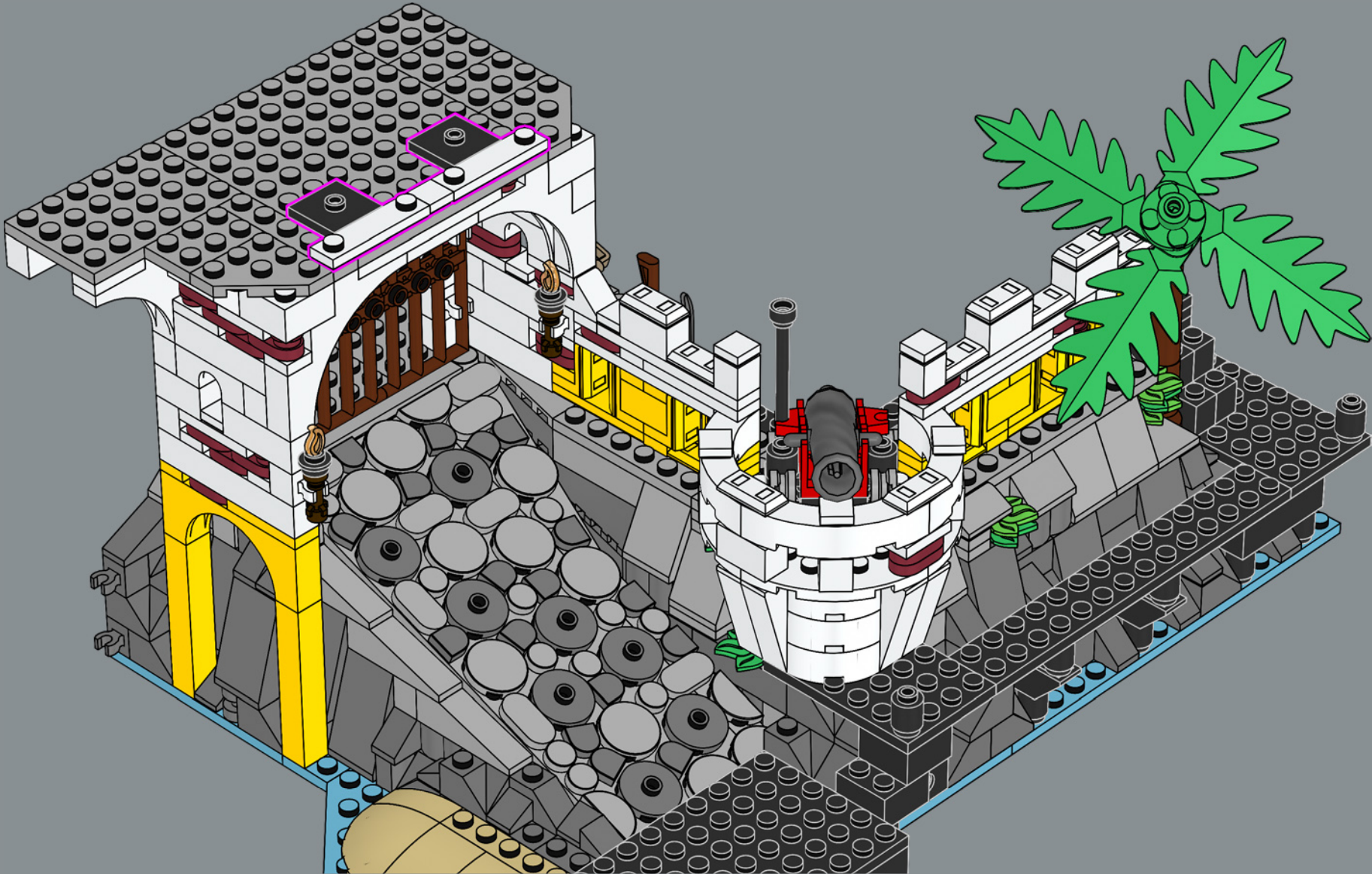

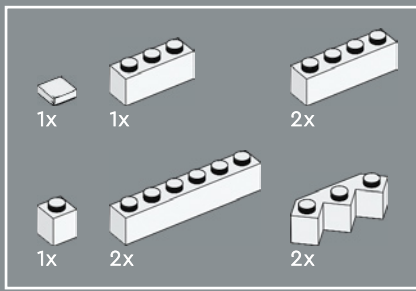

138



1x 5x 1x



139



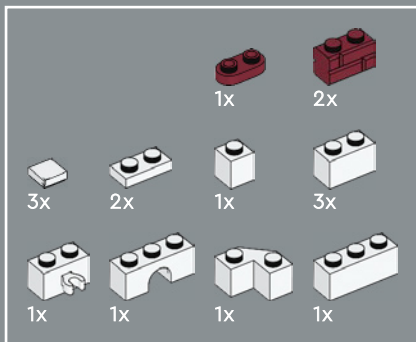

140

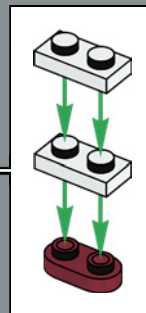

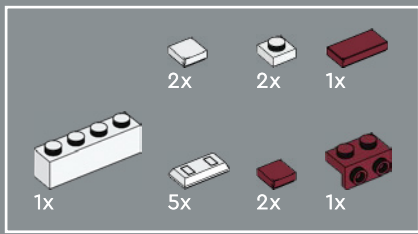

141

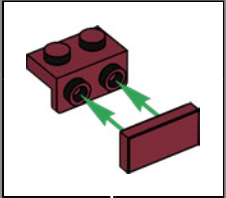

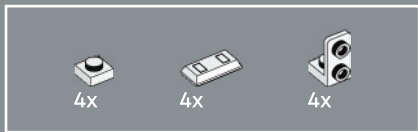

142

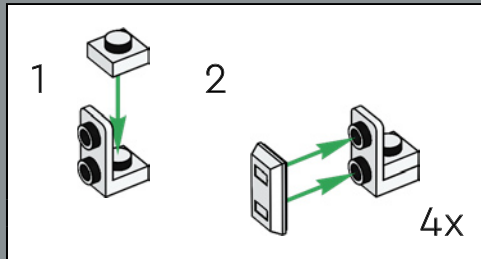

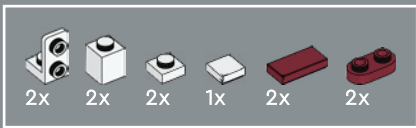

143

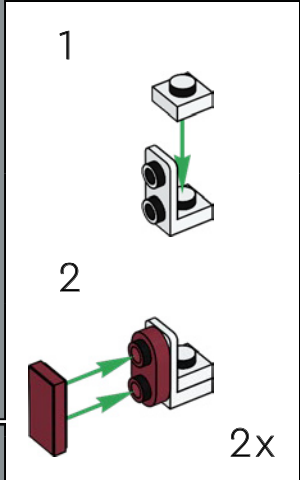

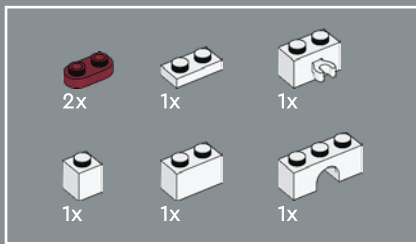

144



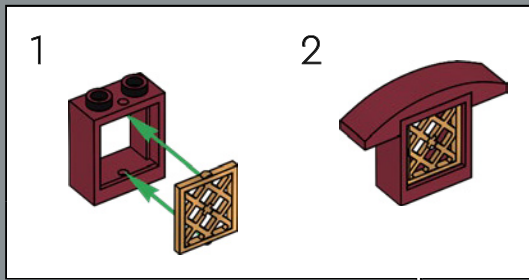
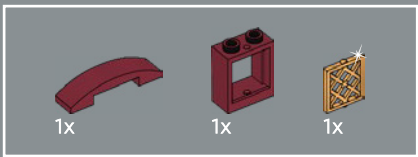



145

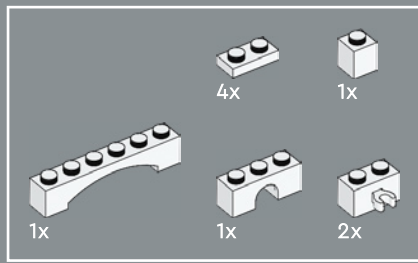

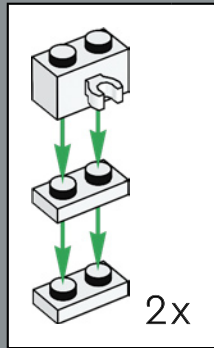

146



4x  1x 

147



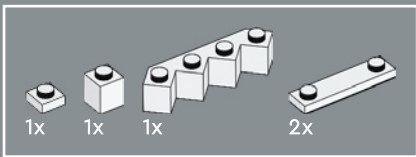

148

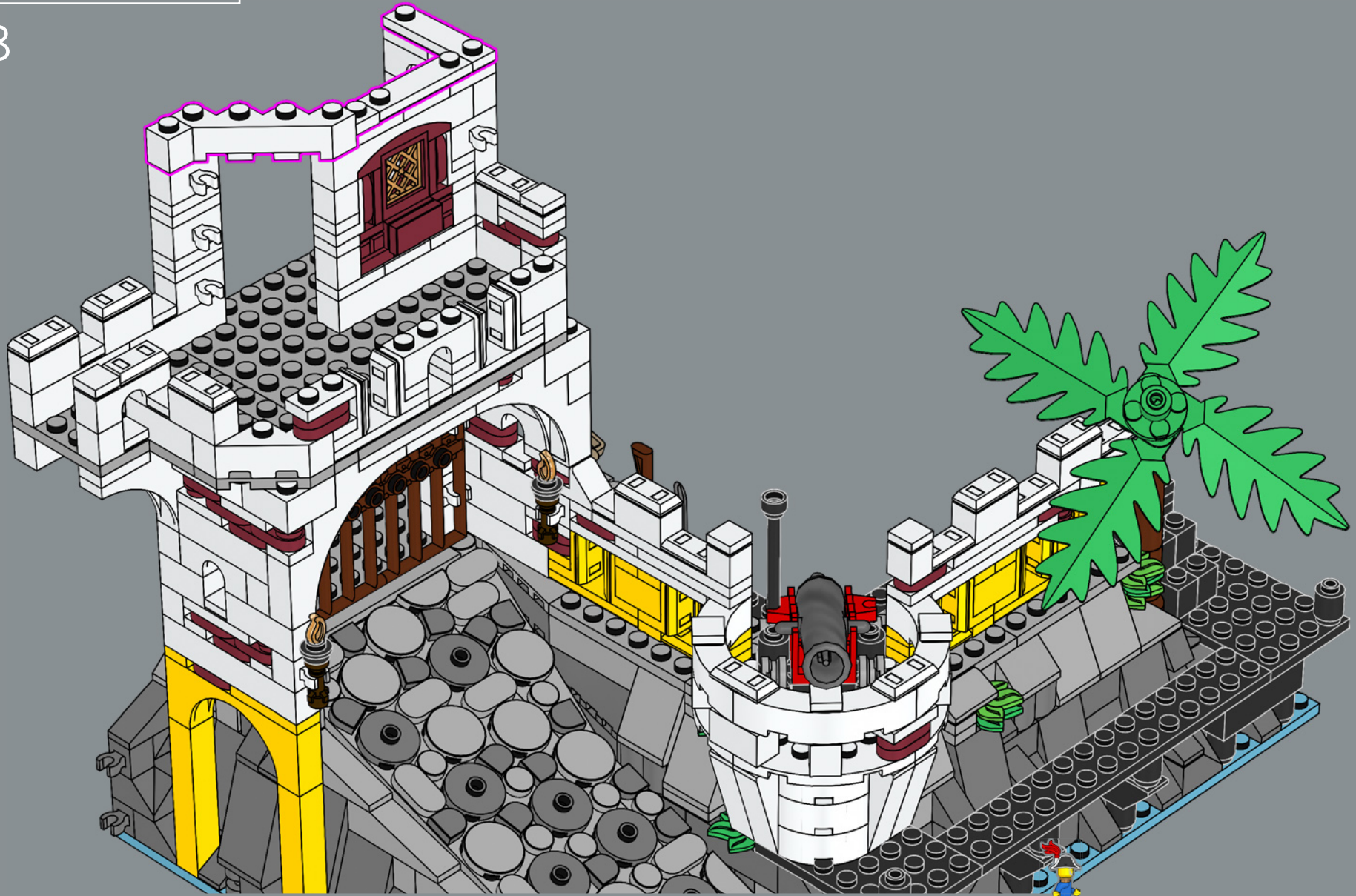

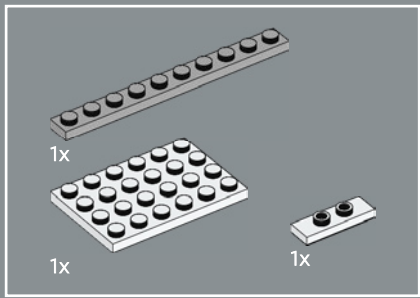

149

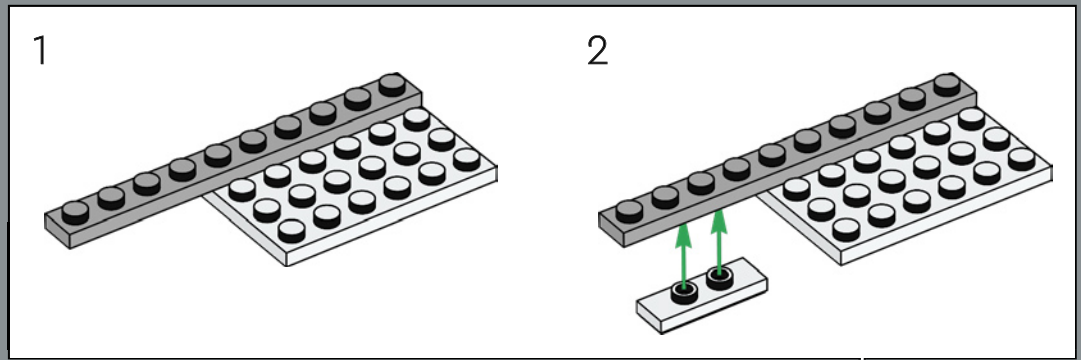

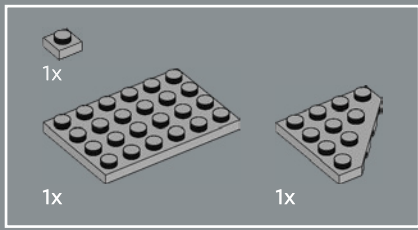

150



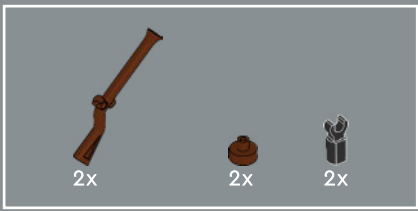

151

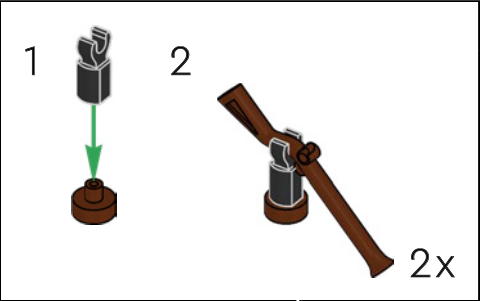

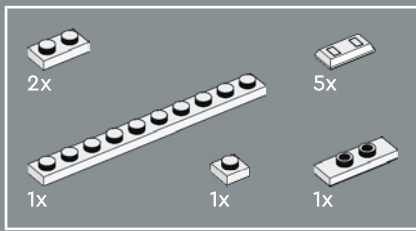

152

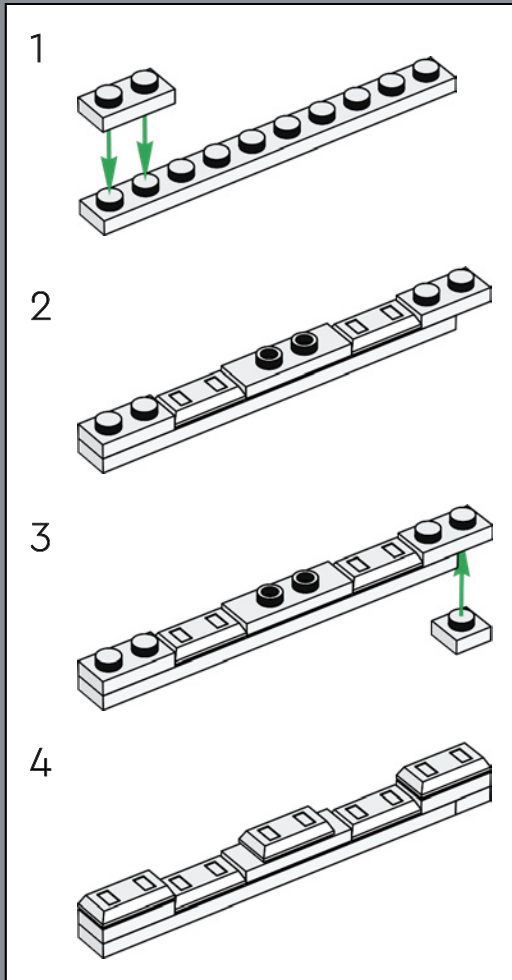

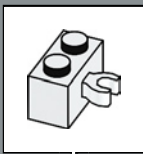
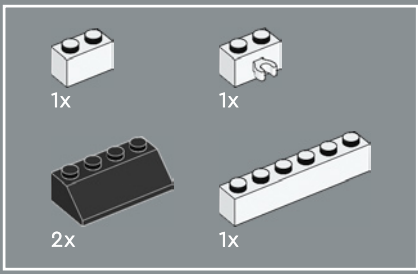

153



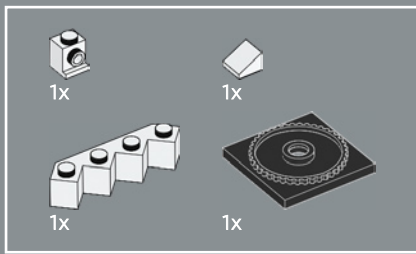

154



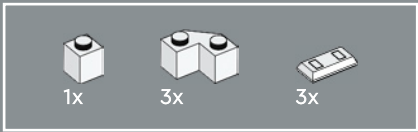

155





156



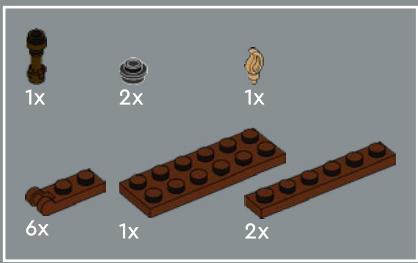

157

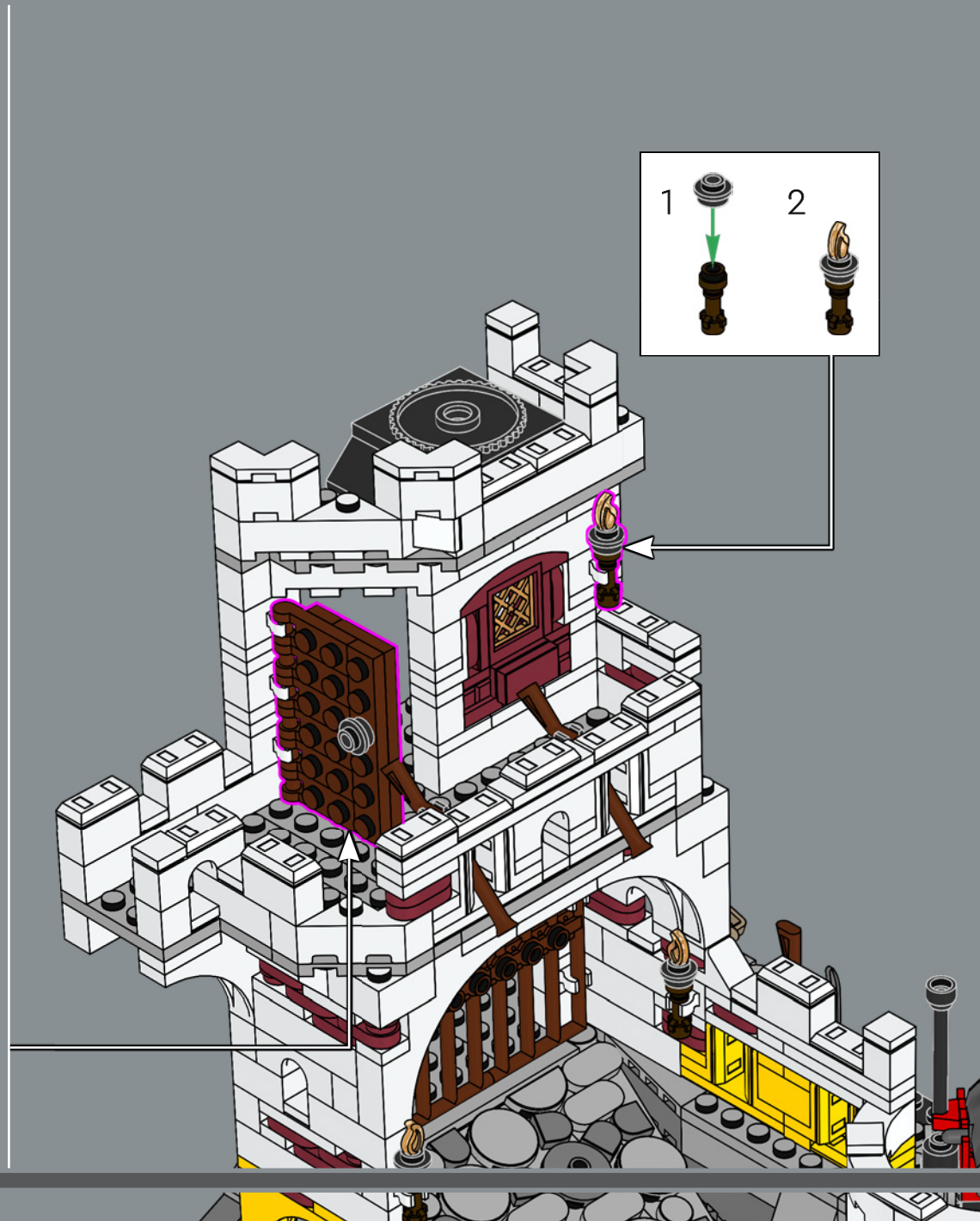
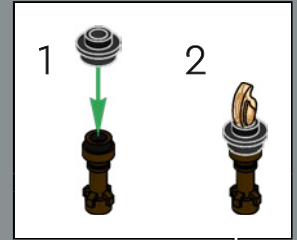
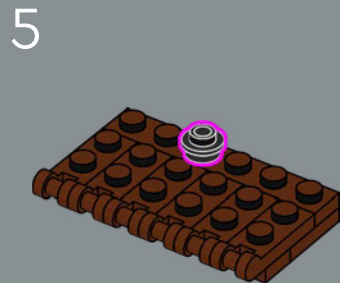
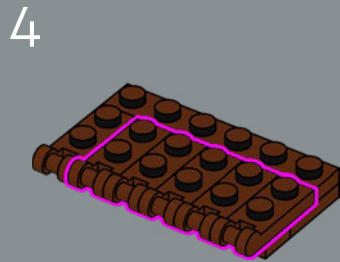
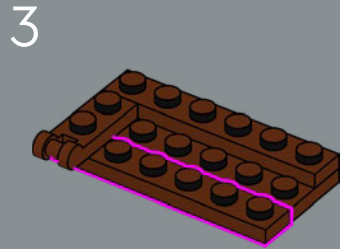
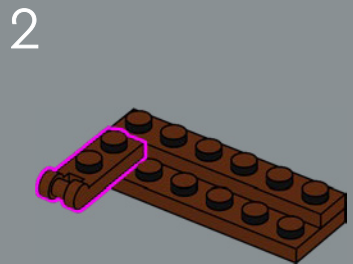
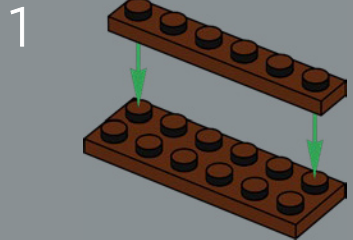



El despacho del gobernador alberga sus posesiones más preciadas, además de importantes documentos.

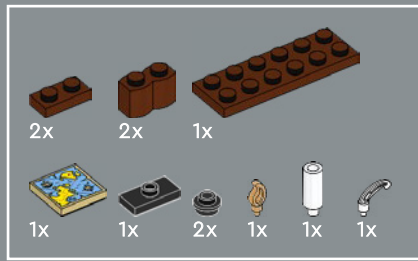

158

1

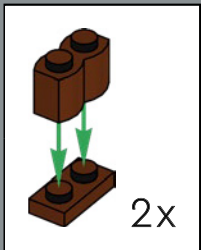
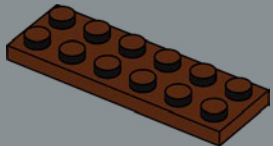

2

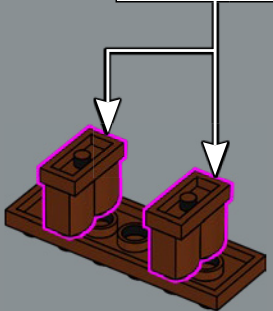

3



4

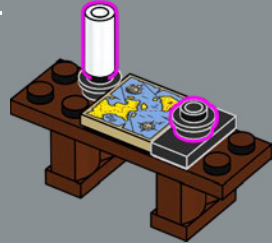

5



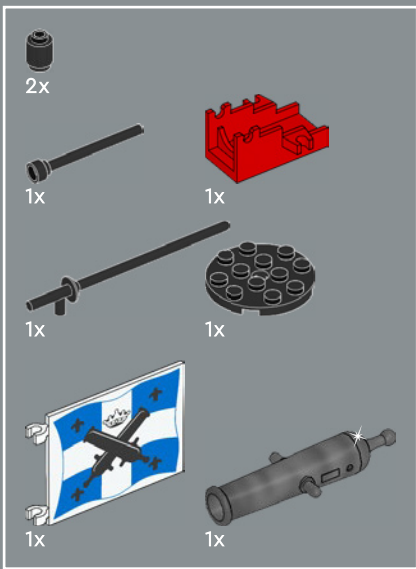

159

1



2

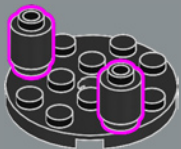

3

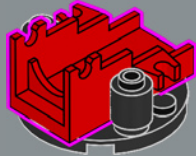

4

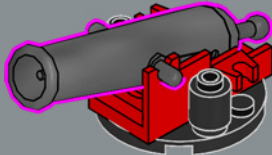

5

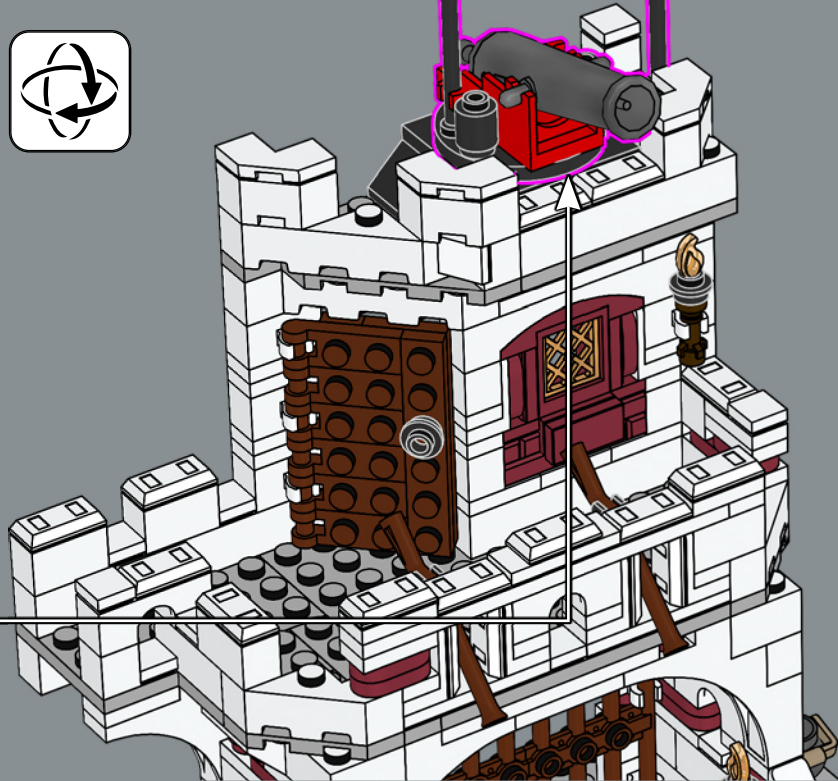
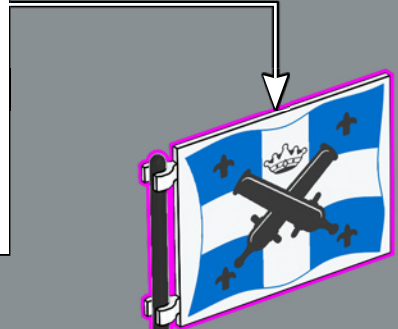
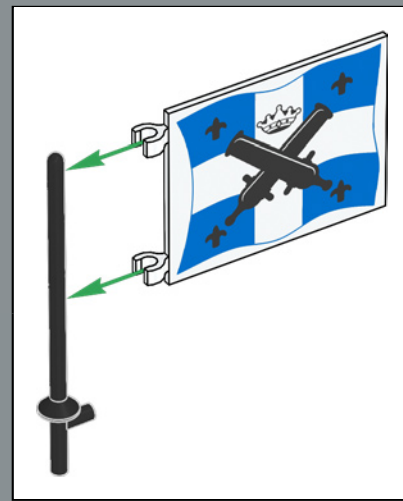
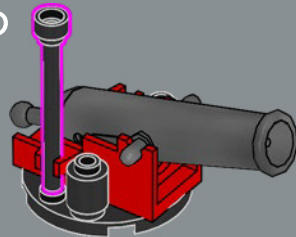





LEGO and the LEGO logo are trademarks of the LEGO Group.
©2023 The LEGO Group.