

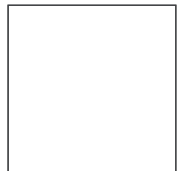

Booklet available in English on
Heft in deutscher Sprache erhältlich auf
Livret disponible en français sur
Libretto disponibile in italiano su
Folleto en español disponible en
如需中文版手册, 请访问





LEGO.com/sustainable-packaging



FR

DONNEZ
OU
RECYCLEZ



ASSOCIATION

OU



MAGASIN

OU



DÉCHÈTERIE

Adresses sur quefairedemesdechets.fr



BUILDER



Apple and the Apple logo are trademarks of Apple Inc., registered in the U.S. and other countries and regions. App Store is a service mark of Apple Inc. Google Play and the Google Play logo are trademarks of Google LLC. Tencent and the Tencent logo are trademarks of Tencent Inc.

Q LEGO.com/devicecheck



Q LEGO® Builder

A UNIVERSAL EXPRESSION OF LOVE

🌹 Millennia ago, Aphrodite, the ancient Greek goddess of love, was said to be so beautiful that roses would rise to greet her wherever she appeared. Ever since then, red roses have been shared as symbols of love. With their beauty, delicate scent and lush, velvety petals, a gift of roses always makes your loved one feel special and cherished on a romantic first date, Valentine's day, anniversaries, birthdays, and memorable milestones and moments we share.





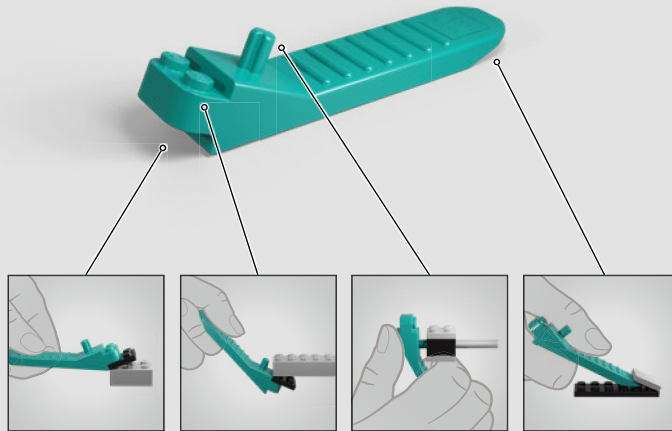



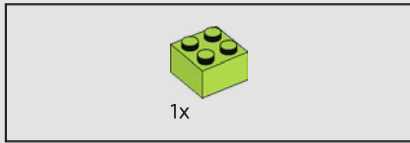
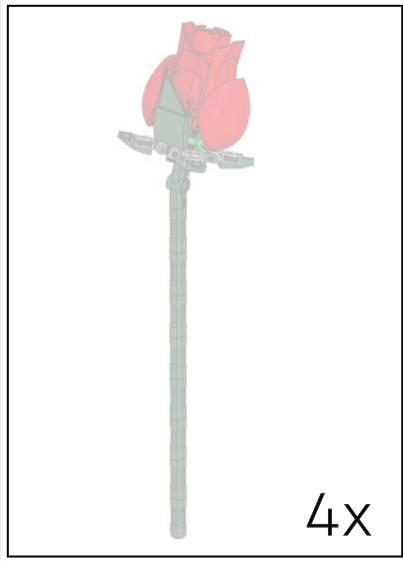

1

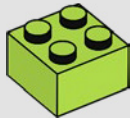

2

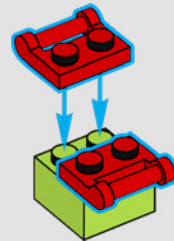

In 2006, the rare Juliet rose sold for 15.8 million dollars.



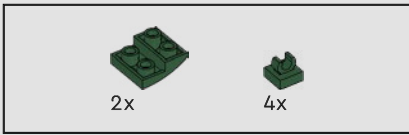

3

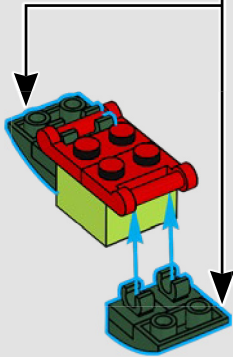
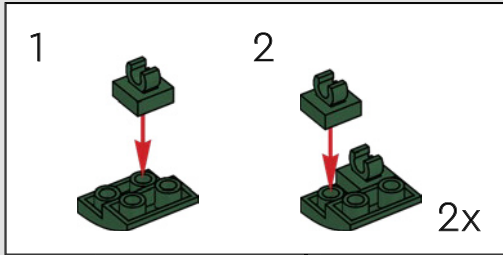

4

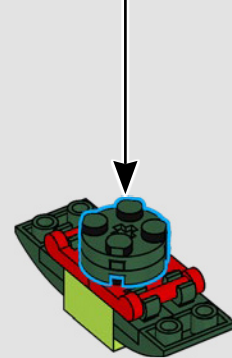
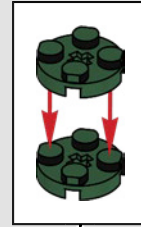



5

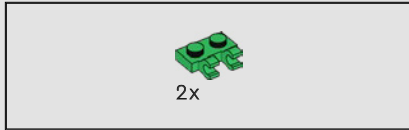
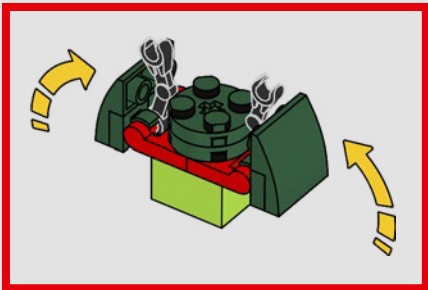
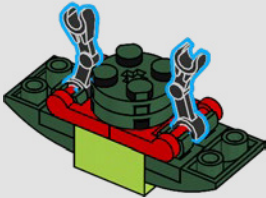

6

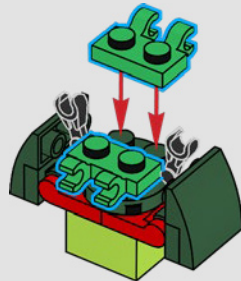

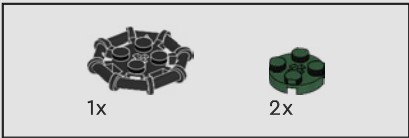

7

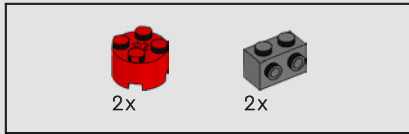
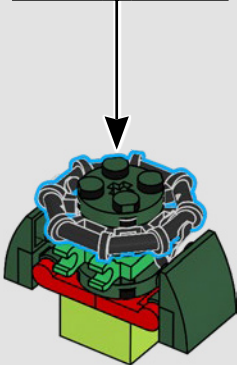
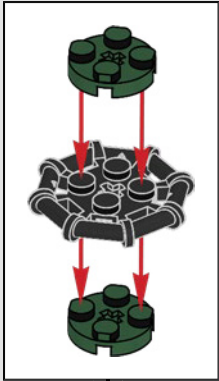

8

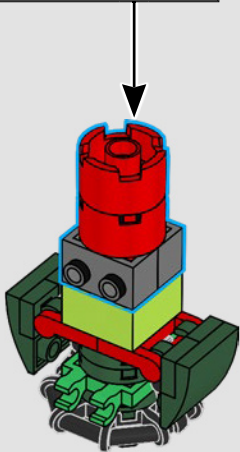
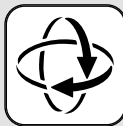
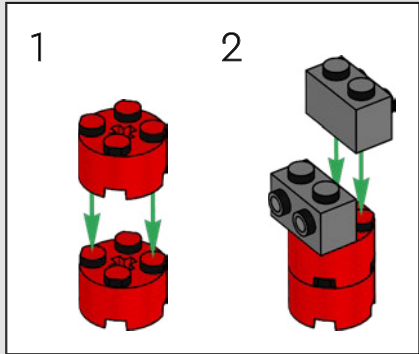

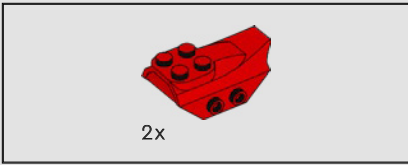

9

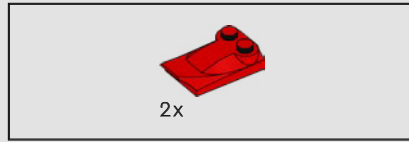
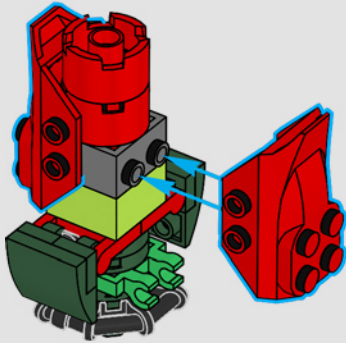

10

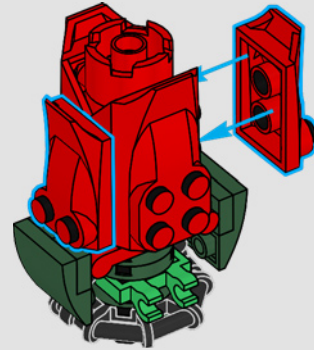

The world's largest rose bush is a Lady Banks (*Rosa banksiae*) in Tombstone, Arizona, USA. Trunk circumference: 4.09 m (13 ft. 5 in.), height: 2.75 m (9 ft.), coverage: 743 m² (8,000 ft²)!



11

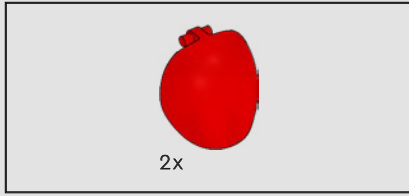
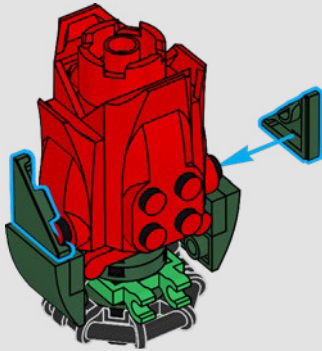

12

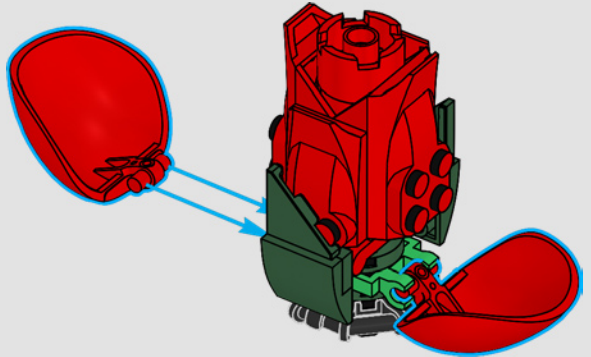



13

Protective sepals caress the delicate rosebud in its early stages.
As the bud opens, the sepals release their protective grasp.

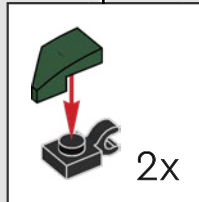
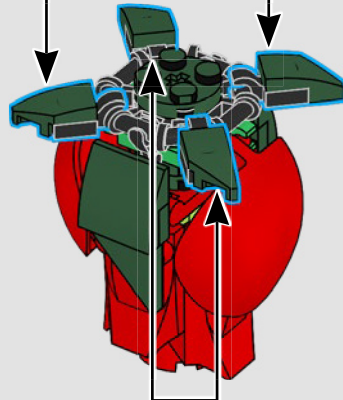
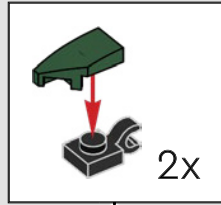

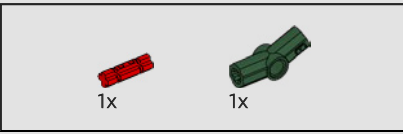
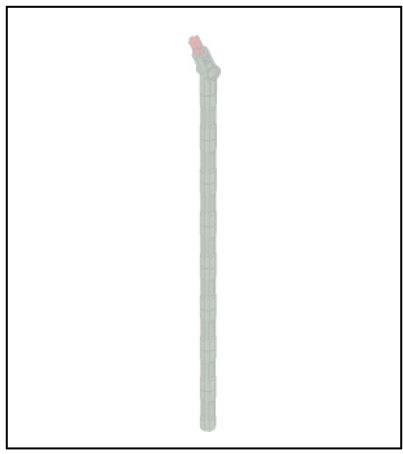

14

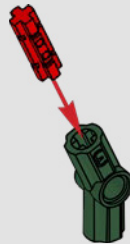

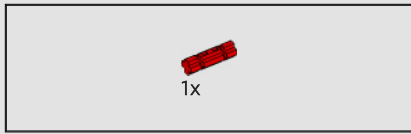

15

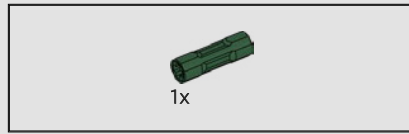
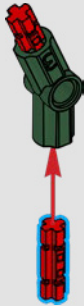

16



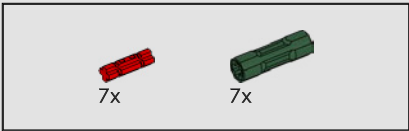

17

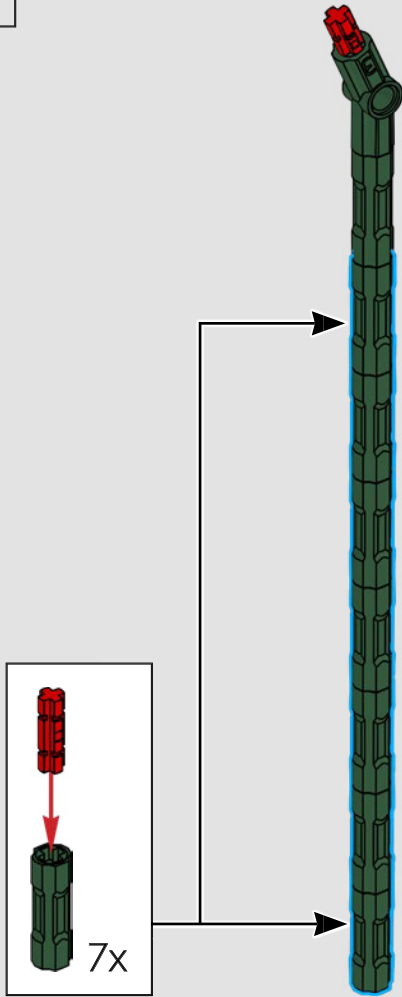



18

No one knows the exact origin of the abstract symbol for a heart, but it appeared on Greek vessels as early as 400 BCE.

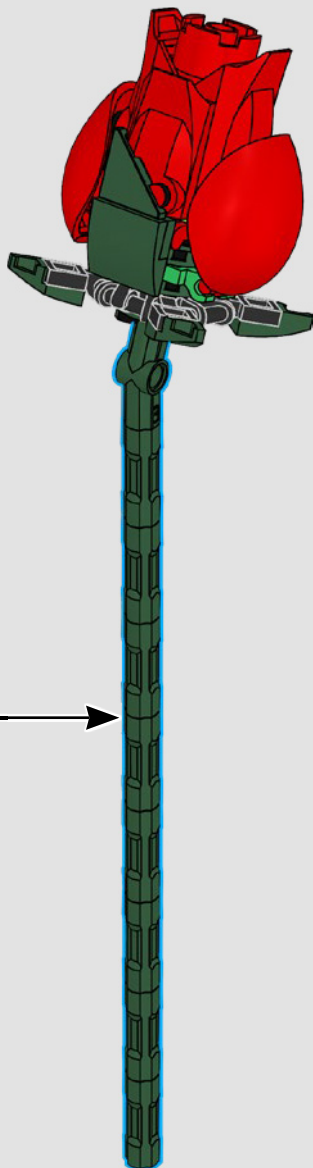

4x

