





[LEGO.com/sustainable-packaging](https://www.lego.com/sustainable-packaging)



 **FR**
DONNEZ
OU
RECYCLEZ

 OU  OU 
ASSOCIATION MAGASIN DÉCHÈTERIE

Adresses sur [quefairedemesdechets.fr](https://www.quefairedemesdechets.fr)

LEGO® VIP

1. SIGN UP
INSCRIVEZ-VOUS
REGÍSTRATE

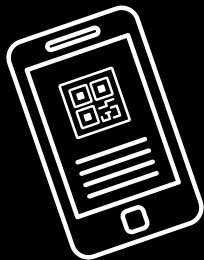

2. EARN POINTS
FOR PURCHASES
GAGNEZ DES
POINTS POUR
VOS ACHATS
GANA PUNTOS
POR TUS COMPRAS



3. REDEEM POINTS FOR REWARDS,
EXPERIENCES, DISCOUNTS & MORE
ÉCHANGEZ DES POINTS CONTRE DES
RÉCOMPENSES, DES EXPÉRIENCES,
DES RÉDUCTIONS ET PLUS ENCORE
CANJEA PUNTOS POR RECOMPENSAS,
EXPERIENCIAS, DESCUENTOS Y
MUCHO MÁS

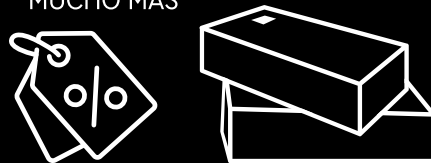

LEGOLAND®





KREATIVE BAUMEISTER BRAUCHEN KEINEN GRÜNEN DAUMEN

„Diese ebenso schlichten wie erfolgreichen terrakottafarbenen Blumentöpfe sind die jüngsten Neuzugänge zu unserer LEGO® Botanik Kollektion. Drei Gruppen von legendären und exotischen Pflanzen im Miniatur-Format holen den klassischen LEGO Charme in deine vier Wände. Dieser lebendige Mix aus Zimmerpflanzen, die es feucht mögen, in der Wüste heimischen Sukkulenten und seltsamen fleischfressenden Pflanzen funktioniert gleichermaßen als ein großes Ensemble oder in kleineren Dreiergruppen, die das ganze Jahr ihre leuchtenden Farben behalten. Die Anleitungen wurden so konzipiert, dass du auch deine Freunde und deine Lieben mitbauen lassen kannst. Hoffentlich macht es euch riesigen Spaß, gemeinsam eine Pflanzenschau zu erschaffen!“

THEO BONNER
LEGO® Modelldesigner





TROPISCHE PFLANZEN

▣ Tropische Regenwälder bedecken nur ungefähr 6 Prozent der Erdoberfläche. Dennoch sind dort fast zwei Drittel aller Pflanzenarten heimisch. Hierzu zählen auch Heilpflanzen, die zur Behandlung diverser Krankheiten verwendet werden. Das feuchtwarme Klima lässt tausende üppige Blumen, Bäume und Sträucher gedeihen, die Tieren und Menschen gleichermaßen als Behausung und Nahrung dienen.



(Oxalis triangularis)

DREIECKIGER GLÜCKSKLEE

Eine in Argentinien, Bolivien, Brasilien, Paraguay und Peru heimische mehrjährige Pflanze.



(Crassula ovata)

GELDBAUM

Eine in Südafrika und Mosambik beheimatete Sukkulente.



(Anthurium andraeanum)

**GROßE
FLAMINGOBLUME**

Eine in Kolumbien und Ecuador heimische Blütenpflanze.

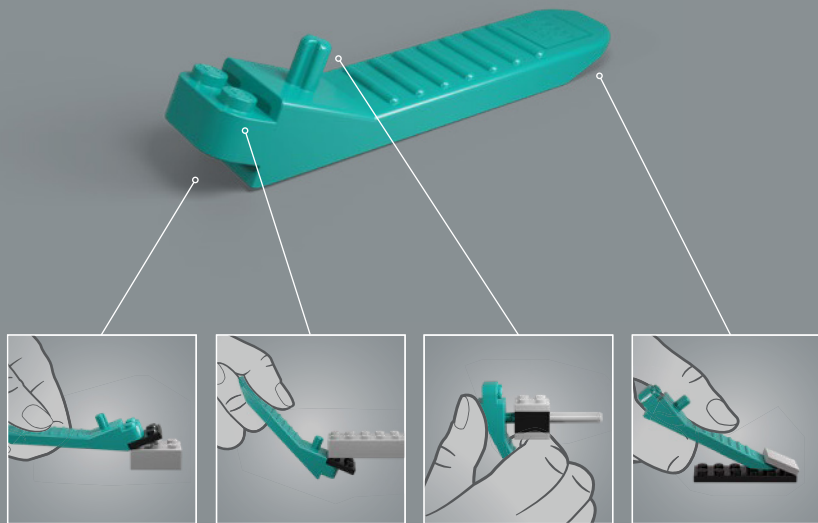

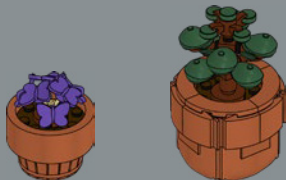

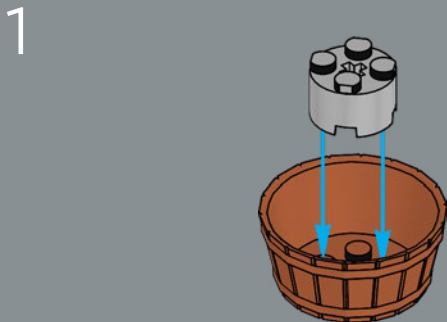
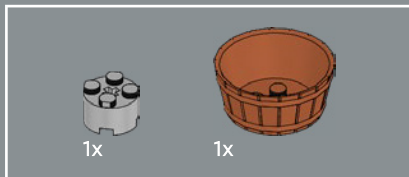

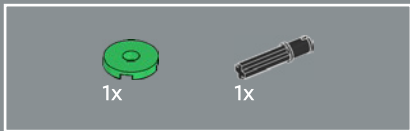

2

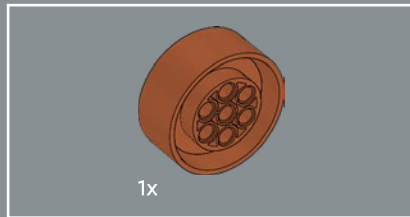
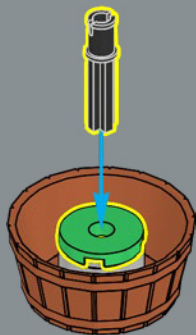

3

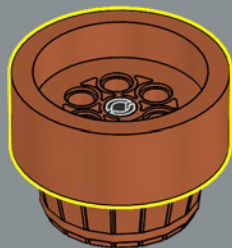



4

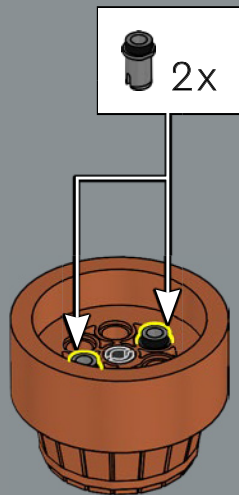

5

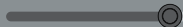



6

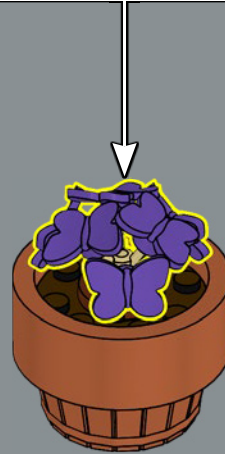
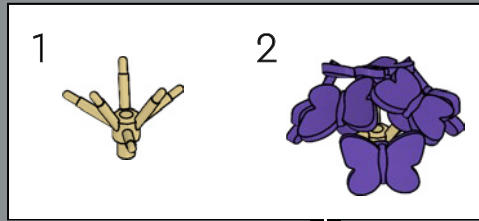

Auf den ersten Blick könnte man *Oxalis triangularis* mit einer Gruppe von Schmetterlingen verwechseln. Deshalb war es naheliegend, den legendären Look der Pflanze mithilfe des LEGO® Schmetterlings in einer brandneuen Farbe darzustellen.

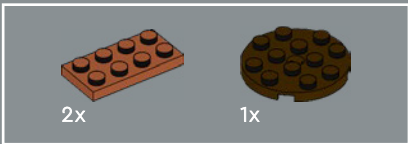
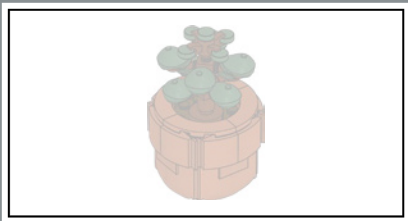

1

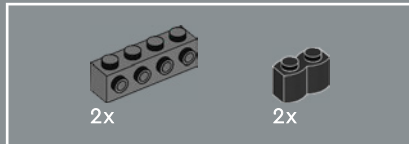
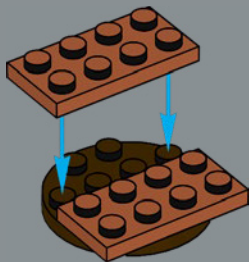

2

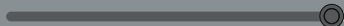
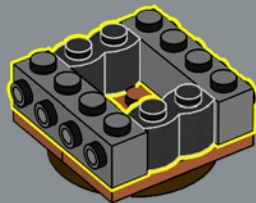

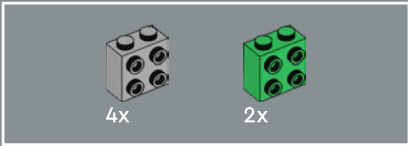

3

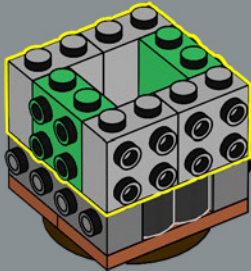

4

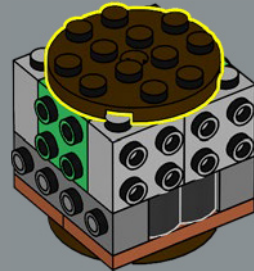

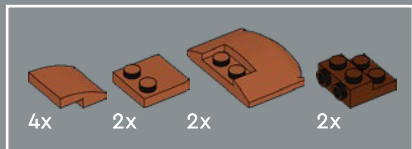

5

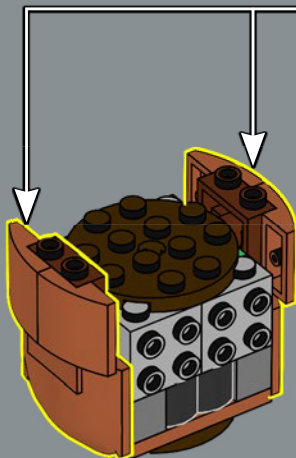
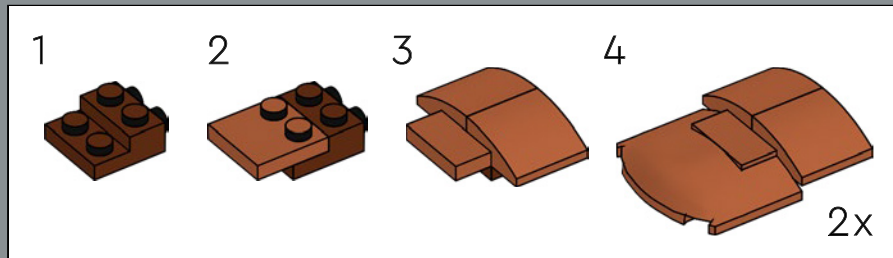

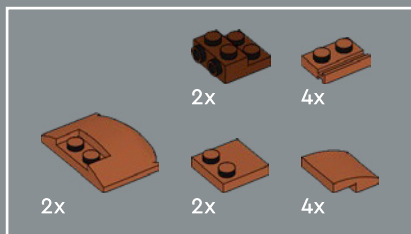

6

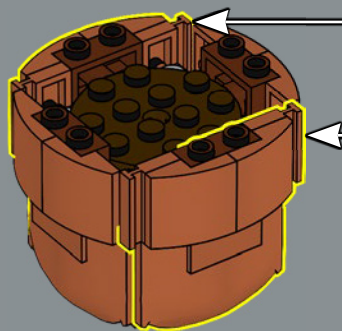
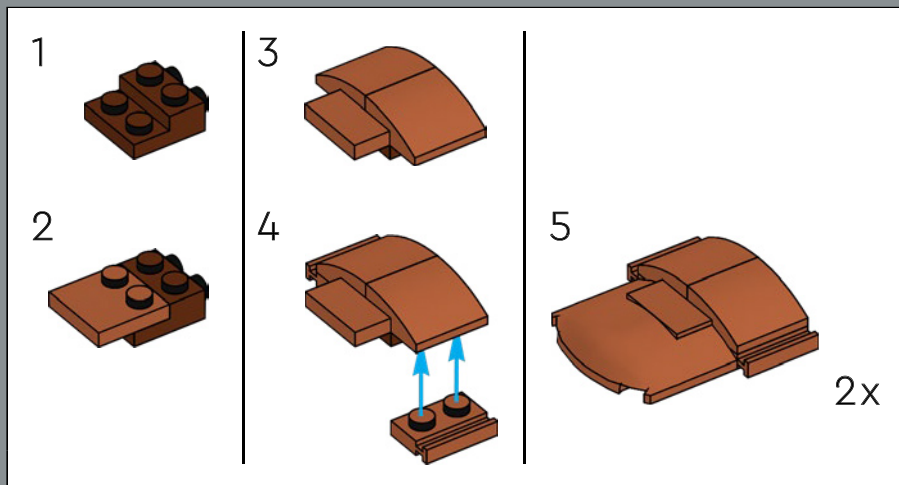

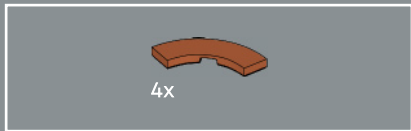

Hast du schon mal in Erwägung gezogen, die Kunst der Bonsai-Zucht zu erlernen? Geldbäume wachsen schnell, sind sehr genügsam und lassen sich nach Herzenslust zuschneiden.

7

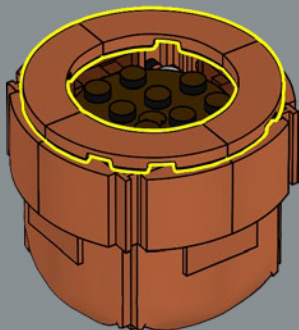



8



9

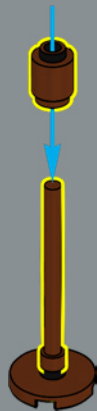



10

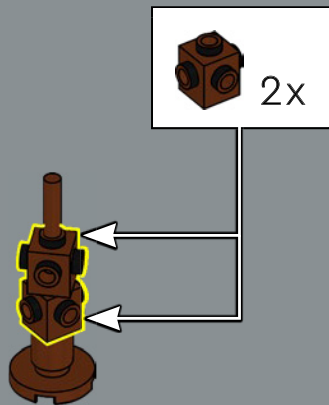

11

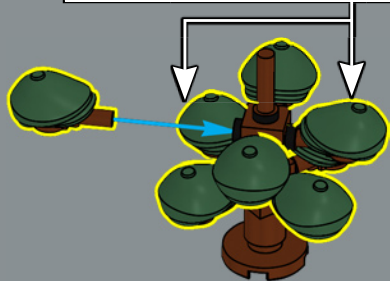
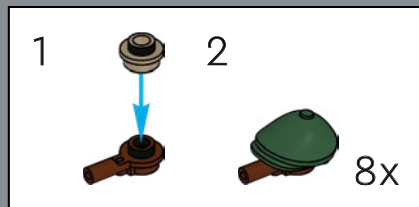



12

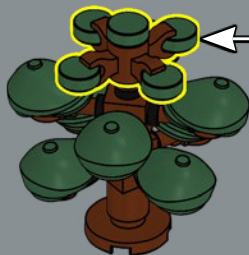

13

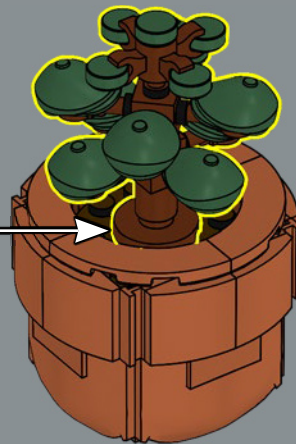

Extrablatt! Extrablatt! Lies alles über diese Sensation! Schiebermütze in neuer Farbe! Wir haben acht LEGO® Schiebermützen benutzt, um die dicken Blätter des Geldbaums nachzubilden. Am Zeitungsjungen (einer unserer LEGO Minifiguren zum Sammeln) konnte man dieses Element zum ersten Mal bestaunen.

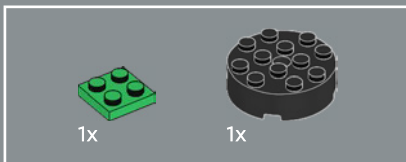
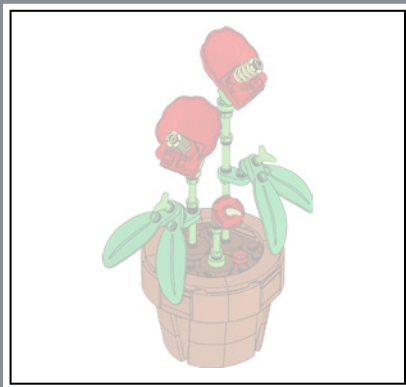

1

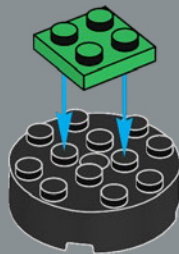

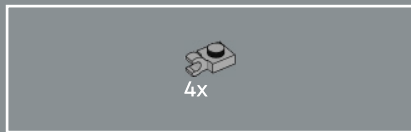

2

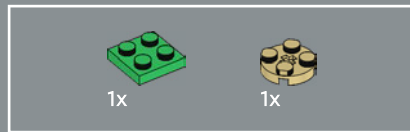
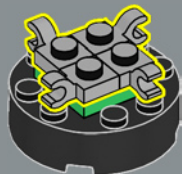

3

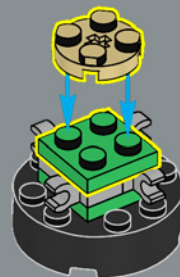

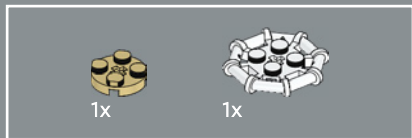

4

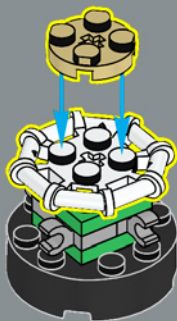

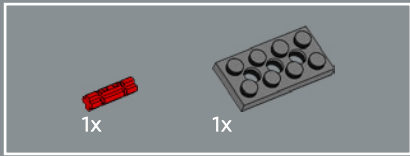

5

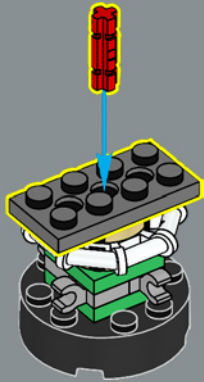

6



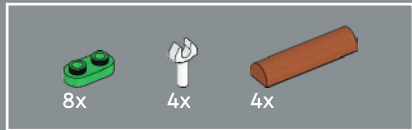

7

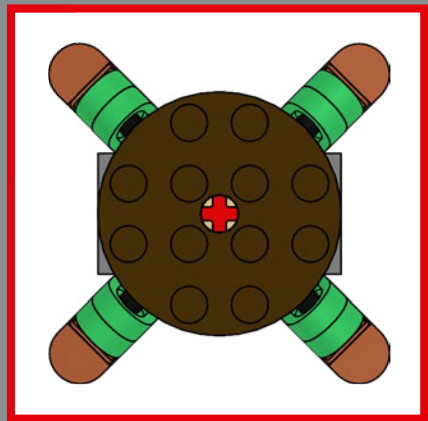
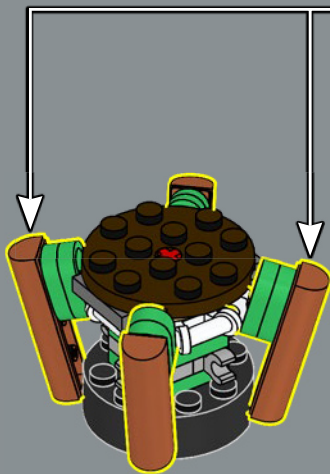
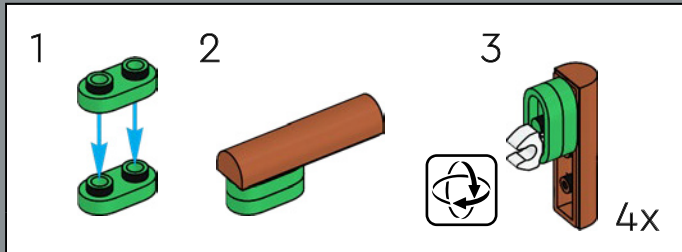

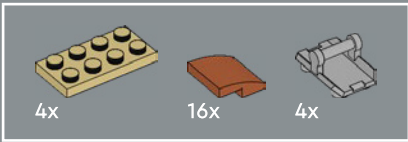

8

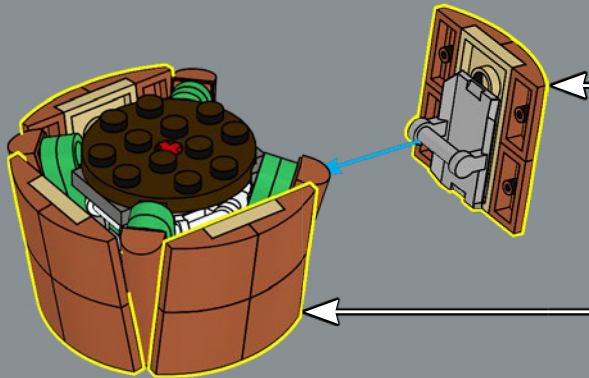
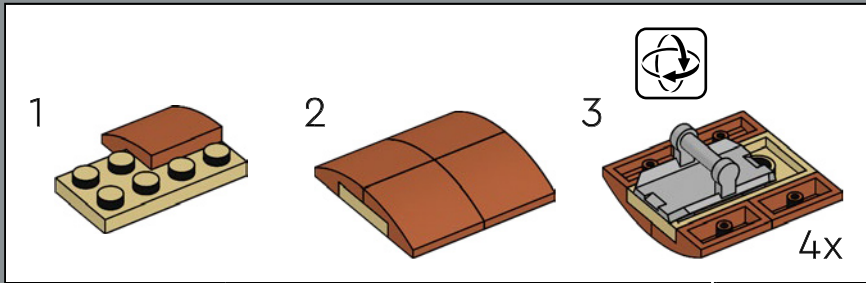

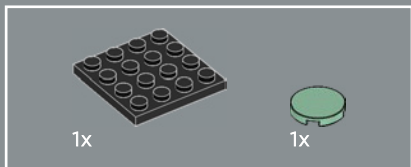
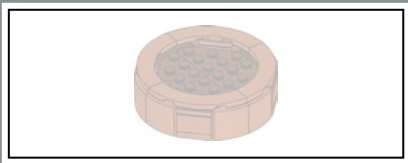

9

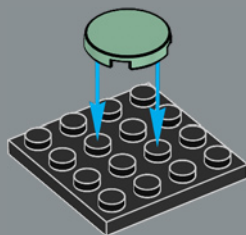



10

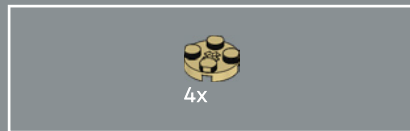
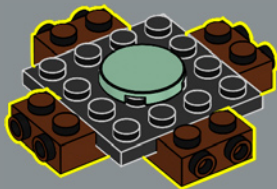

11

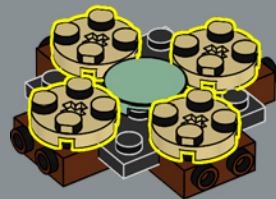

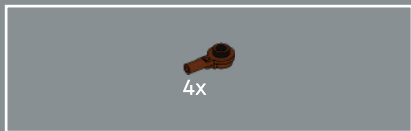

12

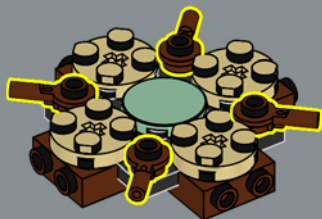

13

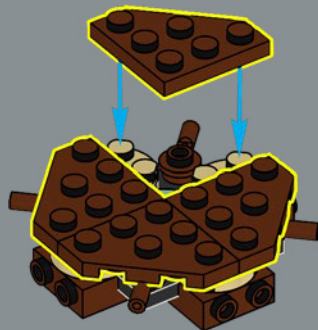



14

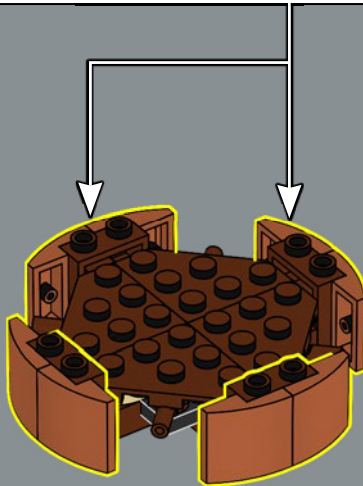
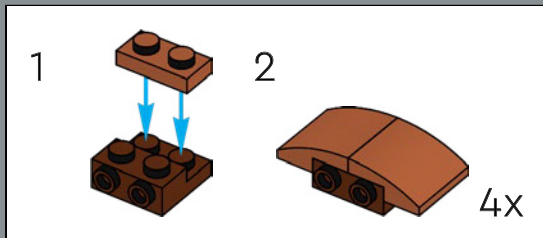



15

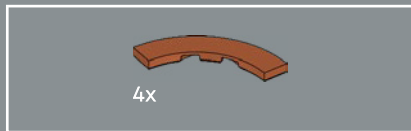
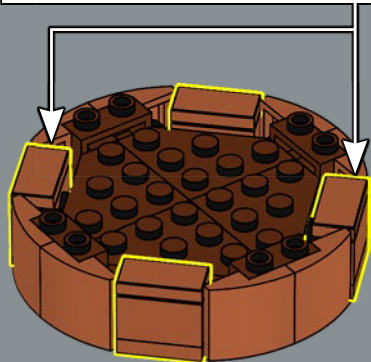
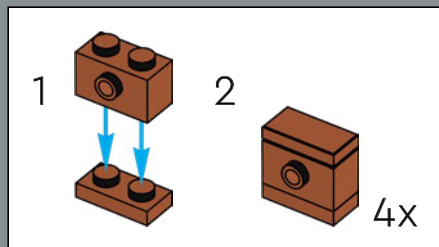

16

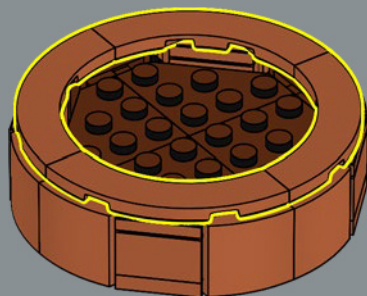

Große Flamingoblumen werden häufig von Blattläusen und Spinnmilben befallen. Deshalb kann ein gefräßiger Marienkäfer im Blumentopf deine Pflanze vor Schäden bewahren.

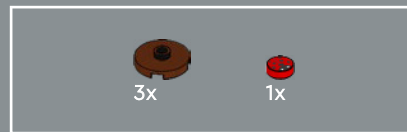

17

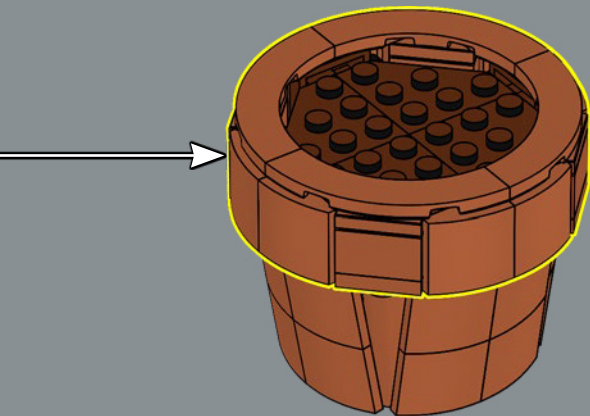

18

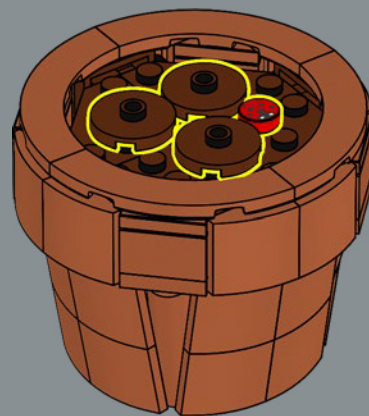



19

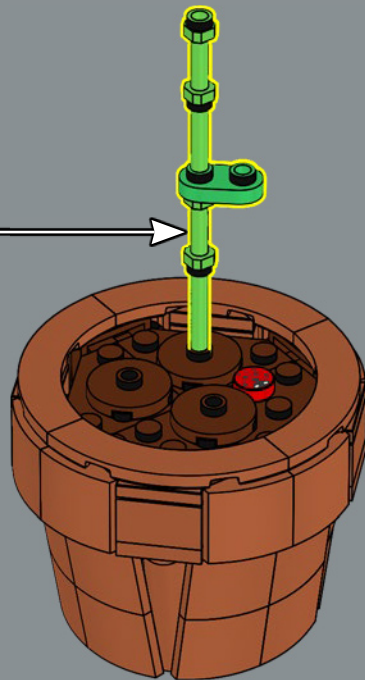
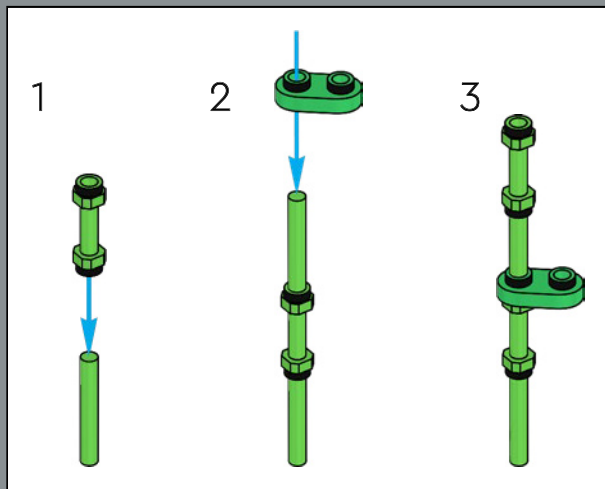

Vielleicht ist dir die Große Flamingoblume eher als Anthurie bekannt. Uns gefällt die Alliteration in den beiden englischen Namen „Flamingo Flower“ und „Painter’s Palette“!

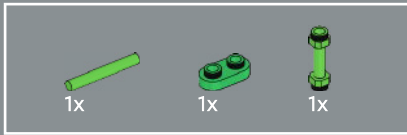

20

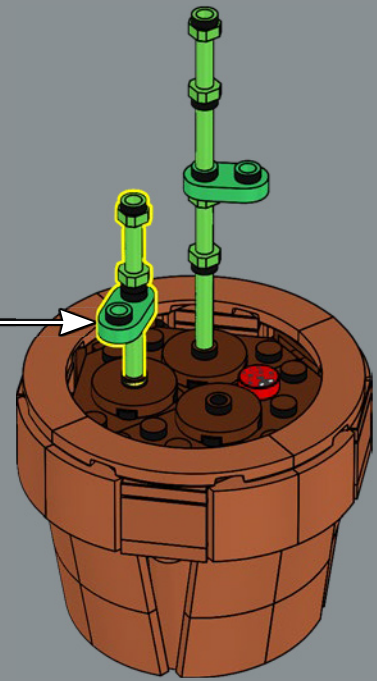
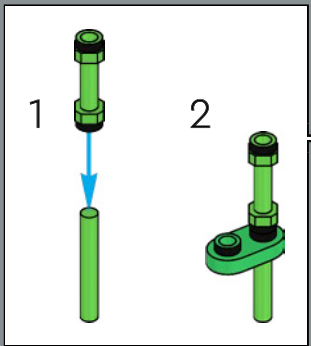

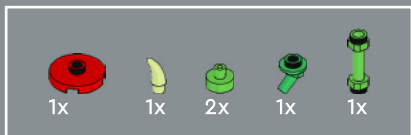

21

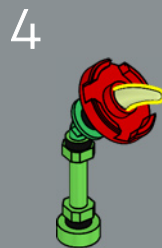
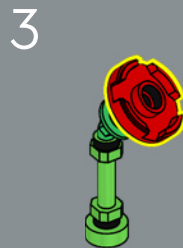
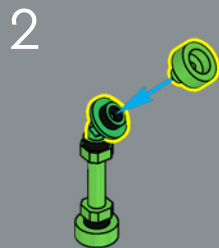
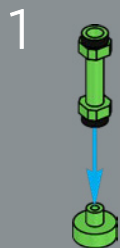

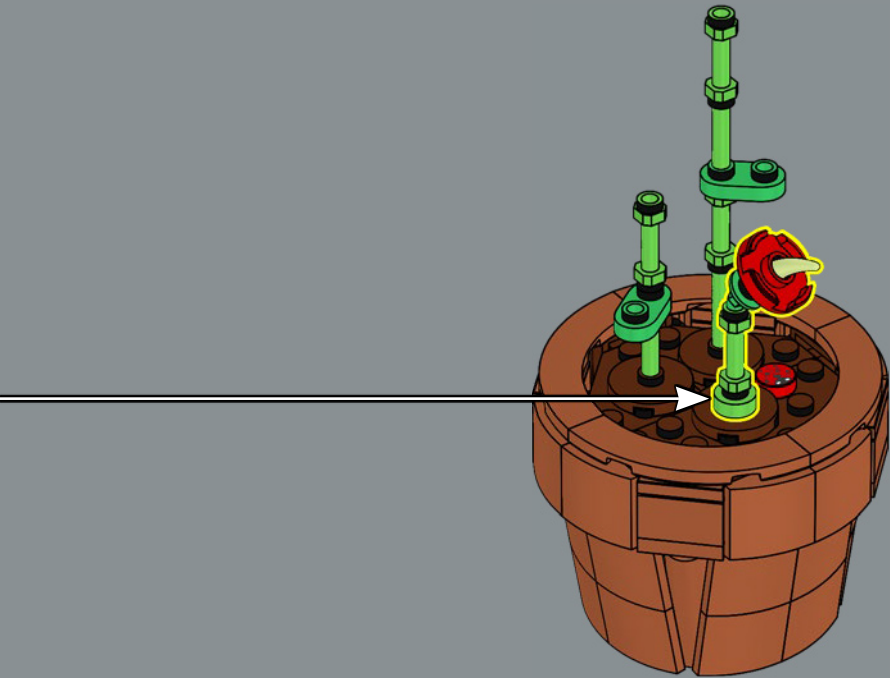

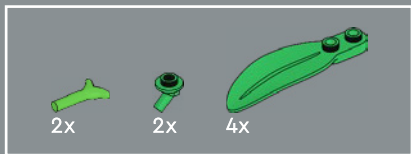

22

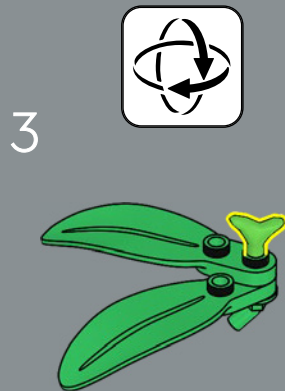
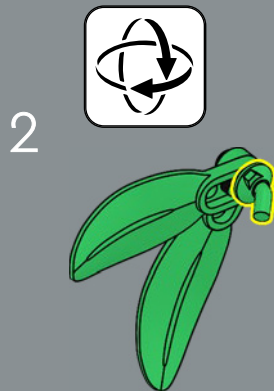
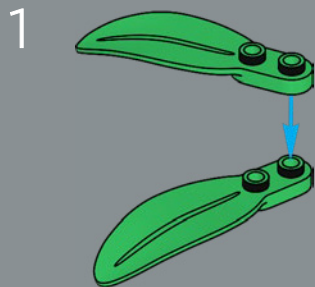

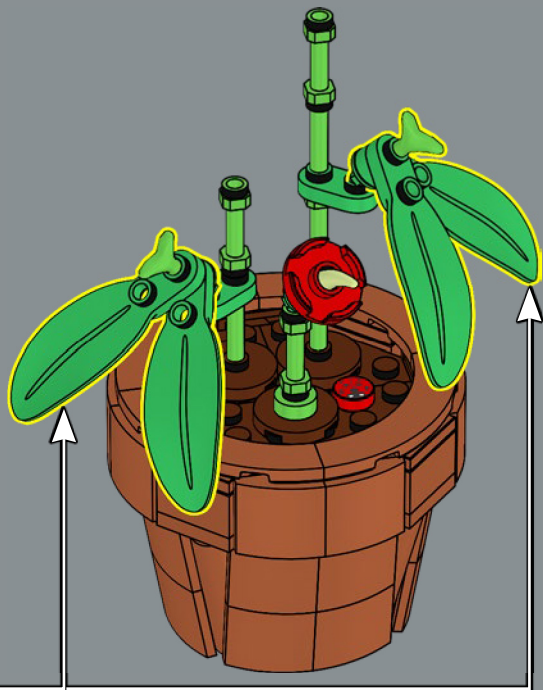



2x



2x



8x



2x



2x



2x



4x



4x



2x



2x

23

1

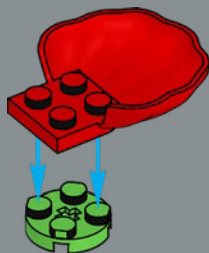

2

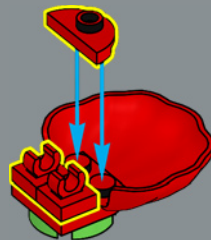

Zur Darstellung der gezahnten Blüte des
Geldbaums haben wir LEGO® Muschelemente
in einer neuen Farbe benutzt.

3

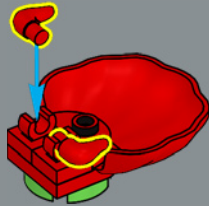

4

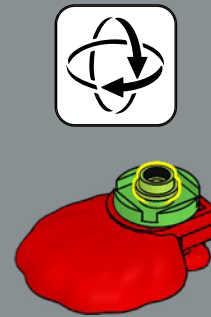

5

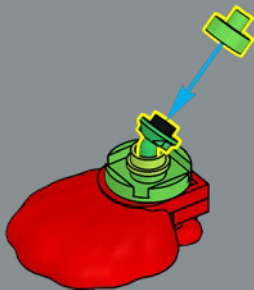

6

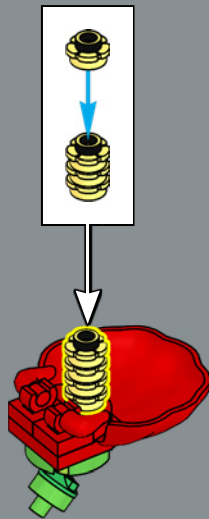

2x

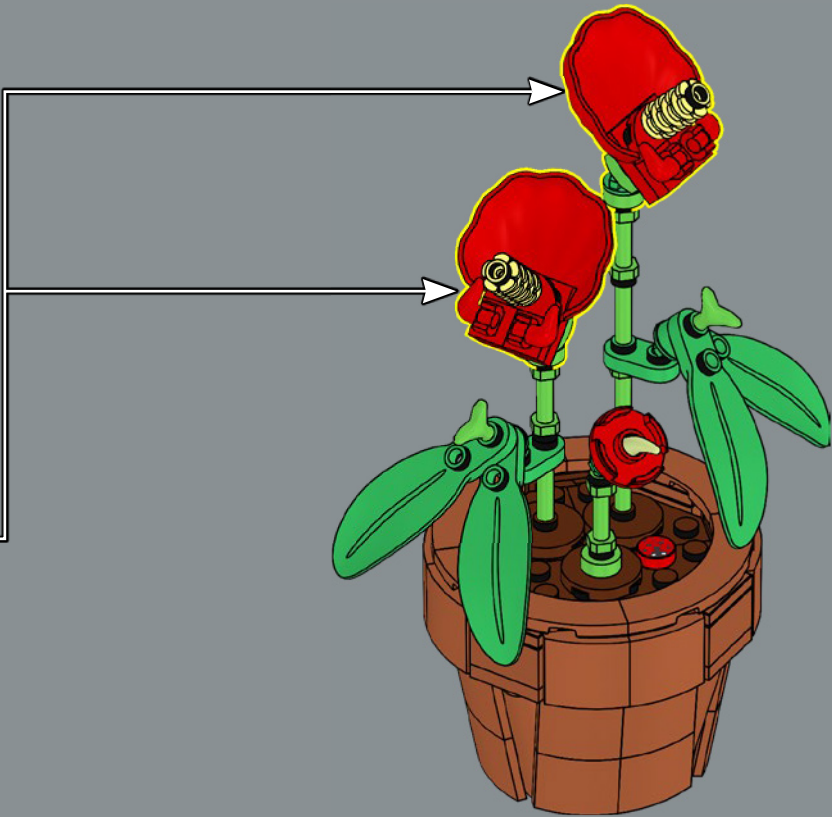



LEGO and the LEGO logo are trademarks of the LEGO Group. ©2024 The LEGO Group.