



Friends⁺



41013



WARNING: CHOKING HAZARD.
Small parts. Not for children under 3 years.



AVERTISSEMENT : RISQUE D'ÉTOUFFEMENT.

Contient des petites pièces. Ne convient pas aux enfants de moins de 3 ans.

ADVERTENCIA: PELIGRO DE ASFIXIA.

No recomendado para niños menores de 3 años.
Contiene piezas pequeñas.



1

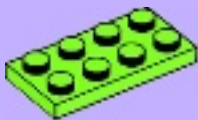

2



3



1x



1x



1x

3

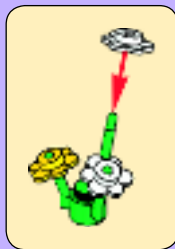

4

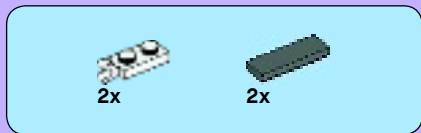

4

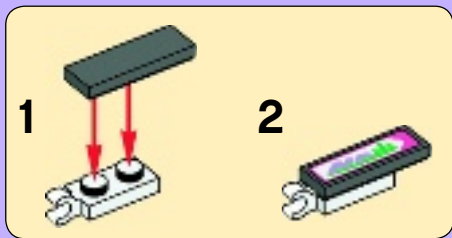
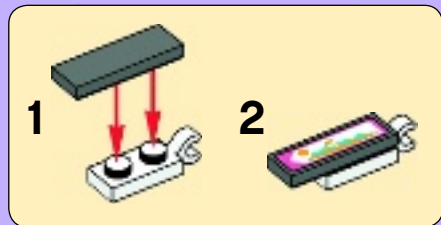

5



1

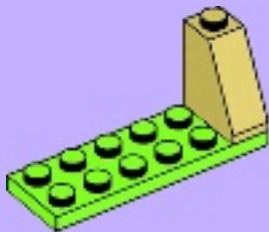

6



2

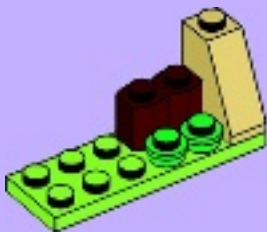



3

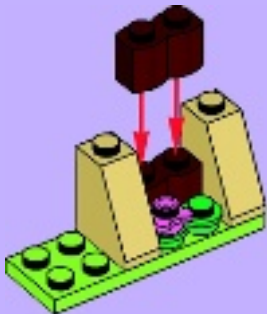

4





2x



1x

1



2



5



8



1x



2x

6



1x

7





1x



2x

8



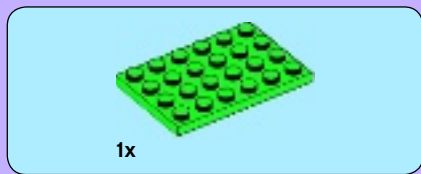

1x

1



1x

2x

2





1x



2x



1x

3

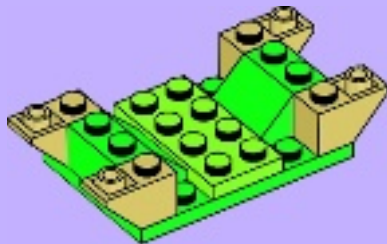



2x

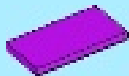

2x

4

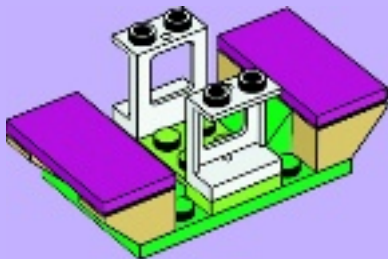

1x

5



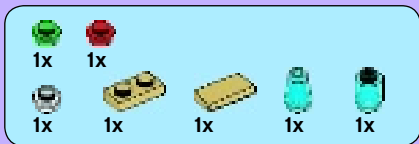

6

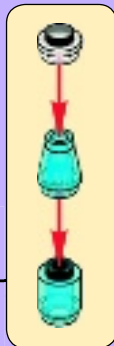
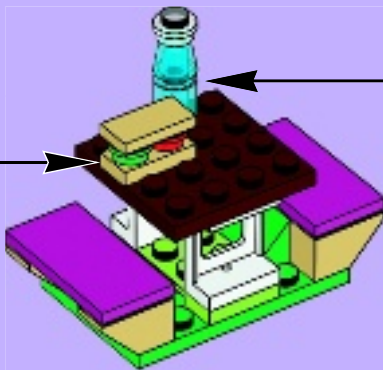



7

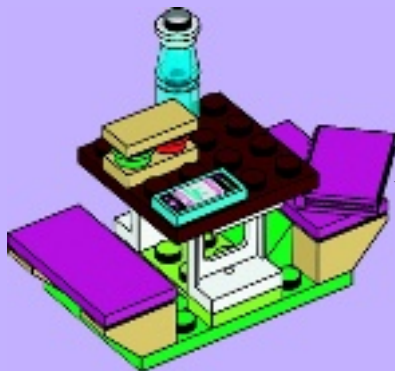



1x



1x



1x

1



2



8

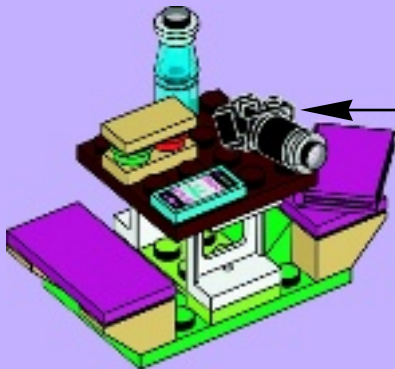



1

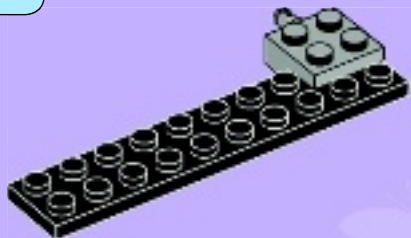



3x

2

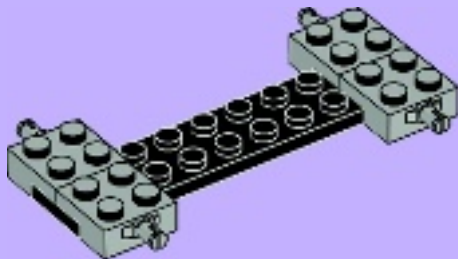



2x

3

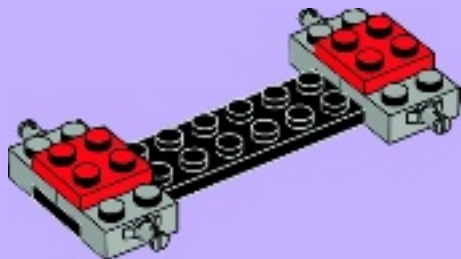

2x



2x

4

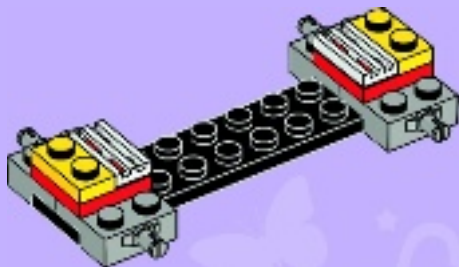

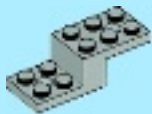

2x

5

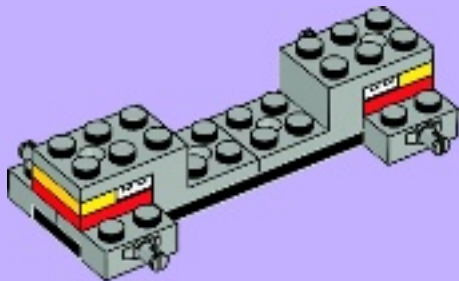

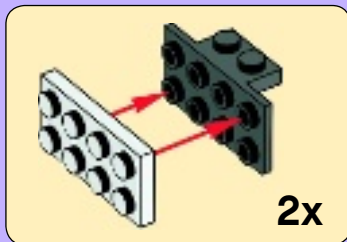
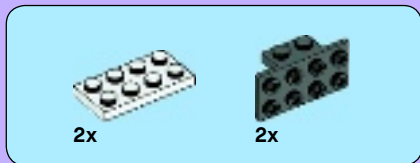

6

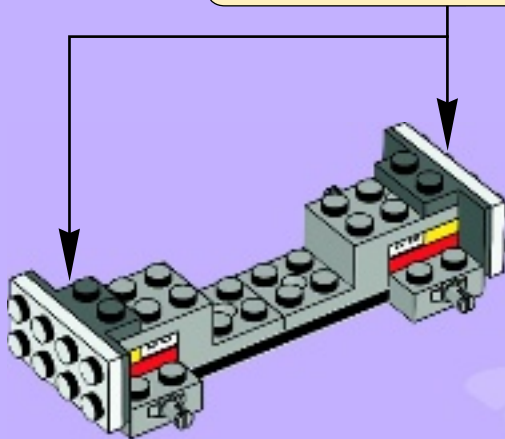



4x

7

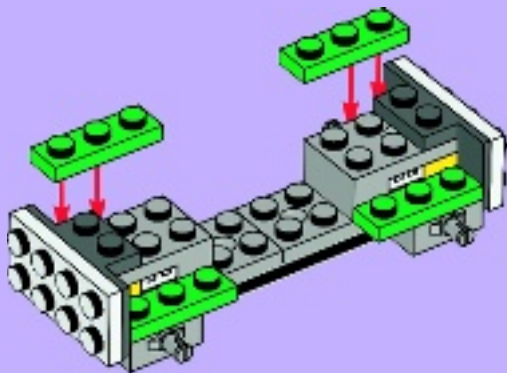



4x

8

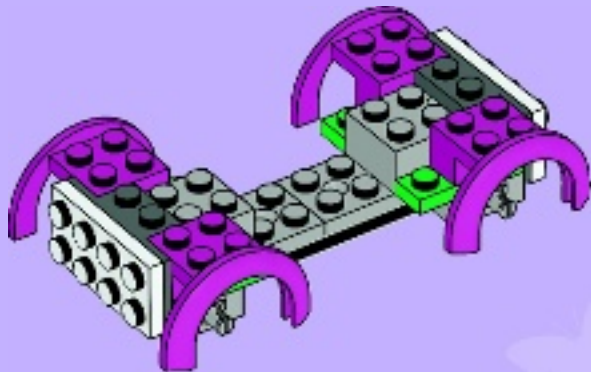



4x



2x

9

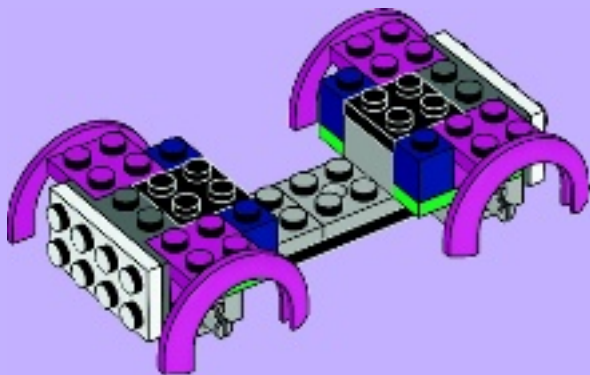

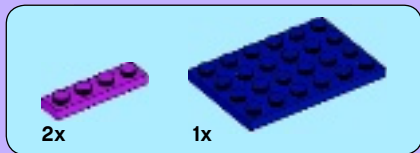

1

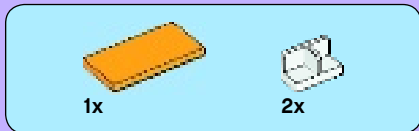
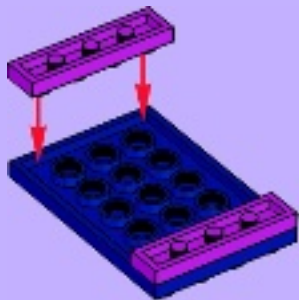

2

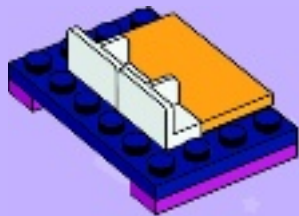
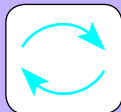



1x



1x

3

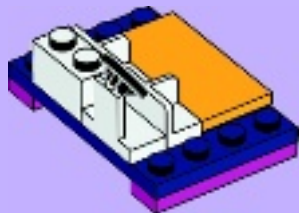

26



2x



4x

4

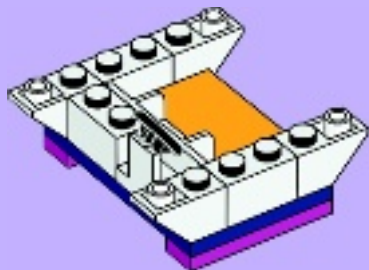

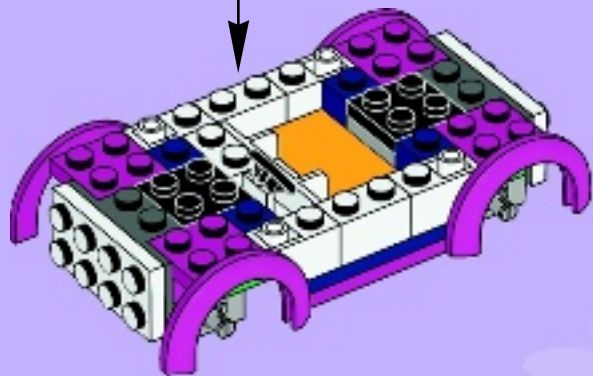

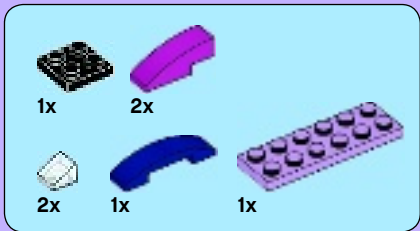

10

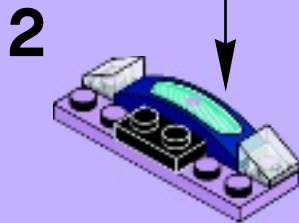
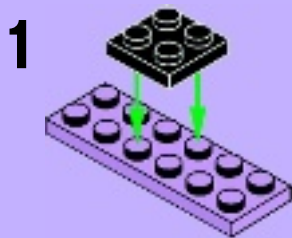

3

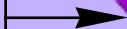
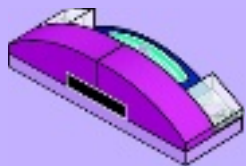

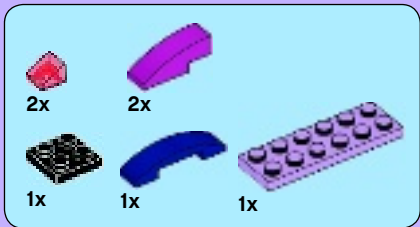

11

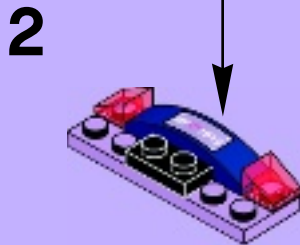
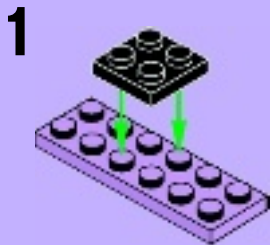

3

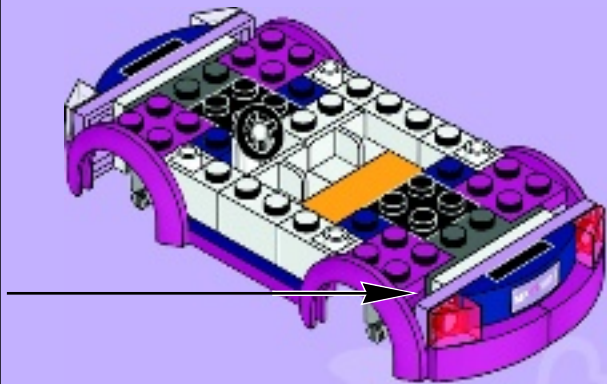
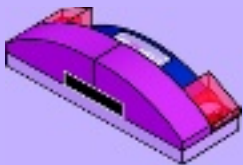



2x

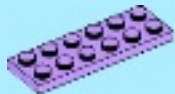

1x



1x

12

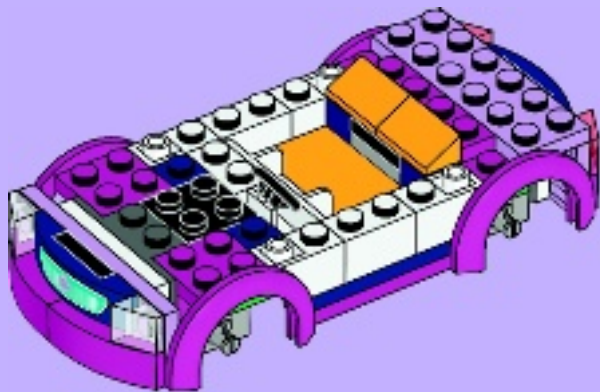



2x



2x



1x

13

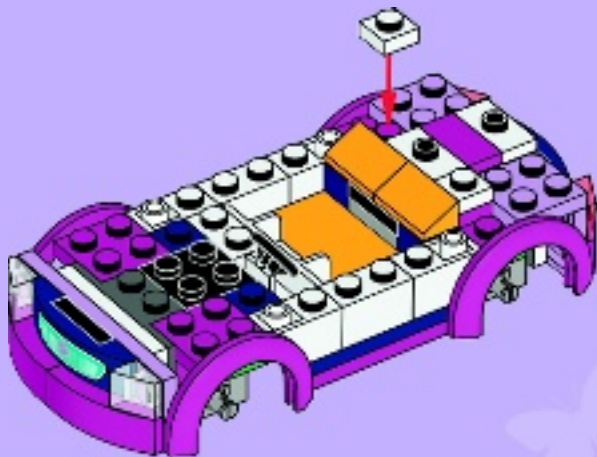

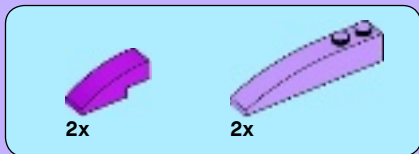

14





15

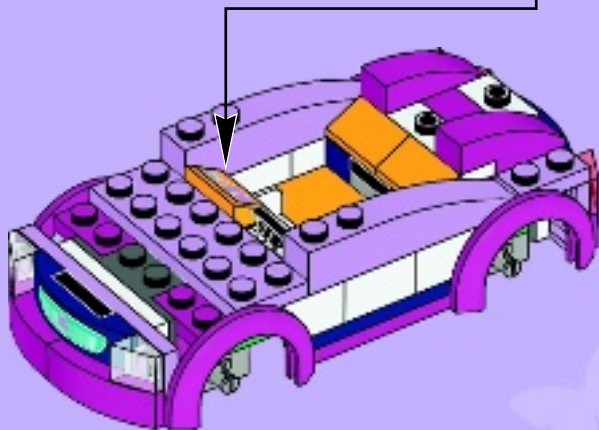



1x



2x



2x

16

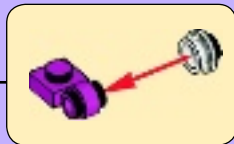
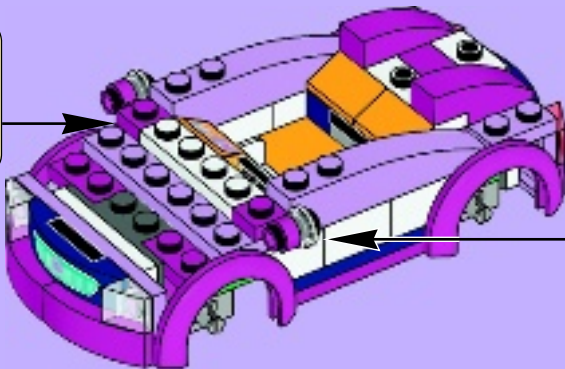
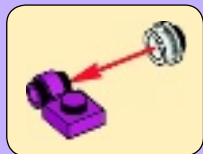



4x



1x



1x

17





2x

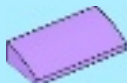

1x

18

1

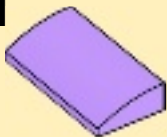

2

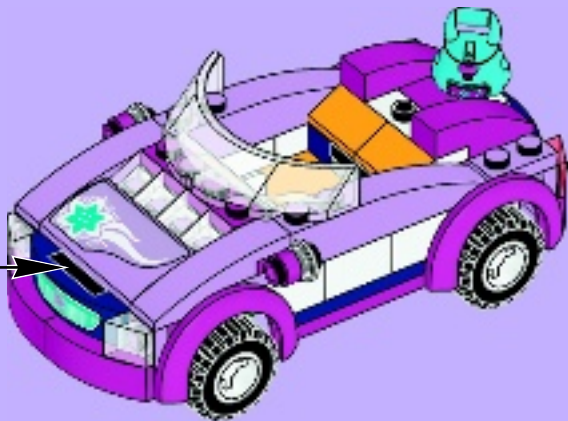

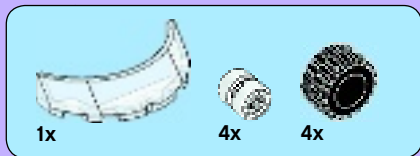

19

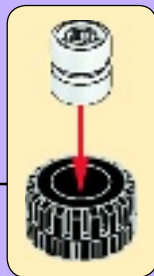
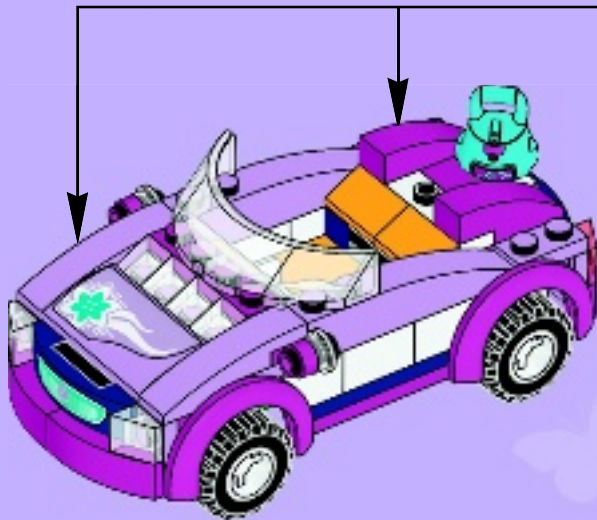





Andrea



Mia



Stephanie



Friends



Emma



Olivia



Friends



41006



41013



41010





41009



41005



41015



■ 41005



■ 41006



■ 41009



■ 41010

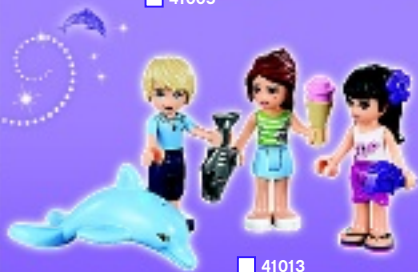

■ 41013



■ 41015



Friends

LEGO.com/friends





2x
4507685



1x
4113261



3x
300401



4x
366501



2x
302401



2x
379401



1x
371001



3x
302001



2x
241201



2x
4535737



2x
6036409



4x
4170457



1x
9551



1x
3006843



1x
4567331



4x
4159196



2x
4626200



1x
4113917



1x
4114026



2x
4613974



1x
614121



2x
302324



1x
4599537



1x
306226



4x
302226



1x
383226



1x
4106552



4x
4568644



2x
303928



4x
4107758



1x
4116671



3x
4569058



2x
374128



6x
4244362



4x
3005740



1x
4523573



2x
4244363



2x
4537936



1x
4621548



1x
4550362



6x
6037650



4x
6037652



2x
6037651



1x
4611415



2x
4651898



1x
6023827



4x
6037648



1x
4243784



4x
4255413



2x
6037886



1x
6037887



3x
6024286



2x
6020073



1x
4621543



2x
4211180



4x
4211183



1x
4243838



2x
6028811



1x
6003098



4x
6018081



2x
4568734



2x
4648067



1x
6038640



2x
4216479



1x
4596243



1x
4622871



1x
6038778



1x
6017069



2x
6037654



2x
6037657



4x
6037649



1x
6037655



2x
4619655



1x
6037410



Customer Service

Kundenservice

Service Consommateurs

Servicio Al Consumidor

LEGO.com/service or dial



: 00800 5346 5555

: 1-800-422-5346



Win!

Go to www.LEGOsurvey.com/product to fill out a survey for a chance to win a cool LEGO® Product.

No purchase necessary.

Open to all residents where not prohibited.



www.LEGOsurvey.com/product

Gewinne!

Nimm an der Umfrage auf www.LEGOsurvey.com/product teil und hab die Chance ein cooles LEGO® Produkt zu gewinnen!

Die Teilnahme am Gewinnspiel führt zu keinerlei Kaufverpflichtungen. Teilnahme in allen nicht ausgeschlossenen Ländern möglich.

6051010



LEGO.com

Win!

Ga naar www.LEGOsurvey.com/product, vul een enquêteformulier in en maak kans op een cool LEGO® product.

Geen aankoopverplichting. Iedereen mag deelnemen, uitgezonderd ingezetenden van landen waar een enquêteverbod geldt.

Gagne!

Visite www.LEGOsurvey.com/product pour répondre à un questionnaire et avoir une chance de gagner un produit LEGO® très cool!

Aucune obligation d'achat. Ouvert à tous les résidents des pays autorisés.

当てよう!

www.LEGOsurvey.com/product にアクセスして、アンケートにご記入ください。当選者にはレゴ®製品を差し上げます。

お買い上げの必要はありません。禁止されていない限り、すべての皆様にご利用いただけます。

LEGO and the LEGO logo are trademarks of the/ont des marques de commerce de/son marcas registradas de LEGO Group. ©2013 The LEGO Group.