



# Friends



41030



[LEGO.com/friends](http://LEGO.com/friends)



**WARNING: CHOKING HAZARD.**  
Small parts. Not for children under 3 years.

⚠ **AVERTISSEMENT : RISQUE D'ÉTOUFFEMENT.**

Contient des petites pièces. Ne convient pas aux enfants de moins de 3 ans.

⚠ **ADVERTENCIA: PELIGRO DE ASFIXIA.**

No recomendado para niños menores de 3 años.  
Contiene piezas pequeñas.

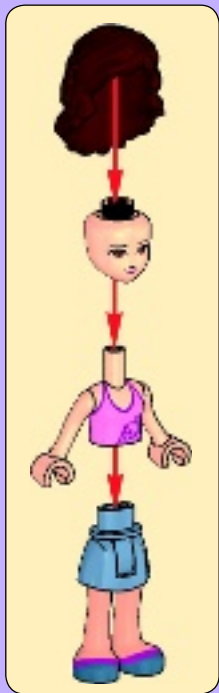



1x



1x

# 1



1x

# 2



3



1x

3

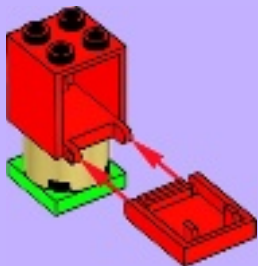

4



2x

4





1



2





4x

3

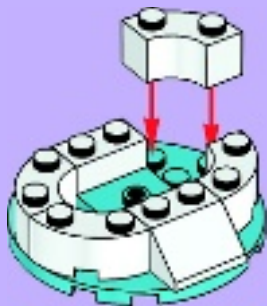

6



1x



1x



1x

4





4x



1x



1x

5



6



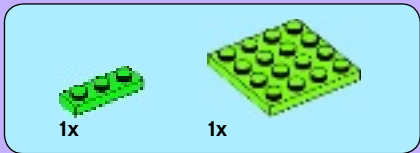

1

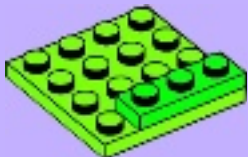

8



2

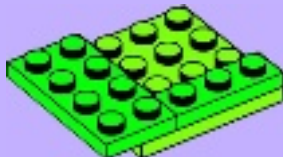





3

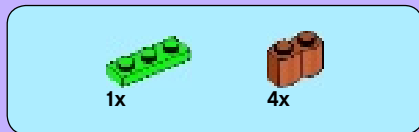
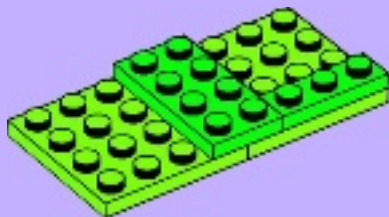

4

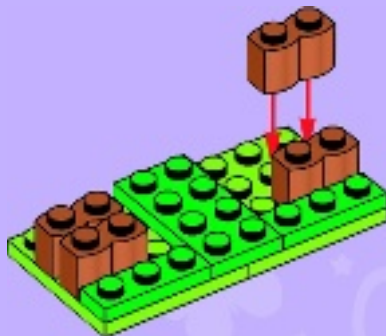



1x



2x



2x

# 5

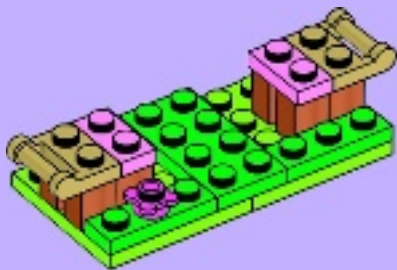

10



2x

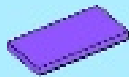

2x

# 6

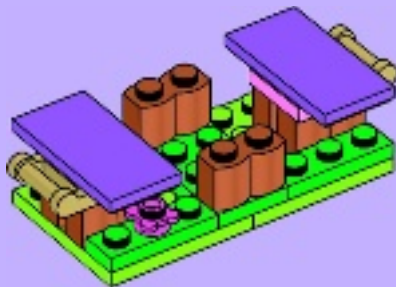



7

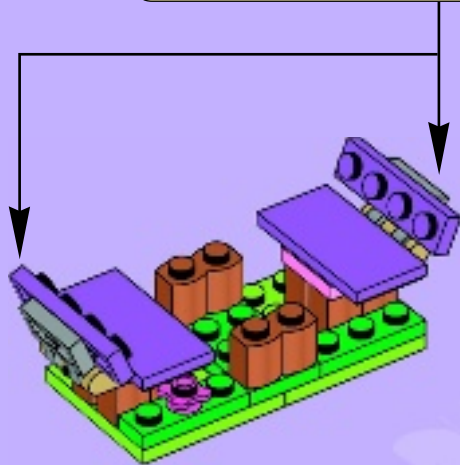



2x

8

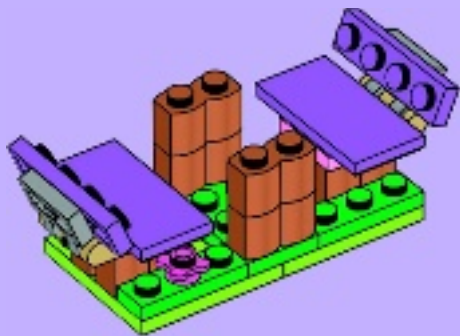



2x

9

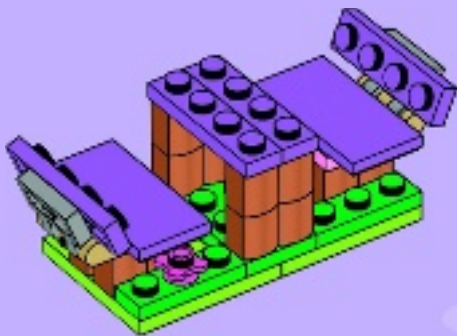



1x



1x



1x



1x



1x

# 10

1



2

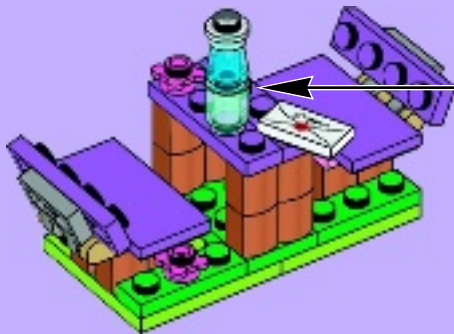

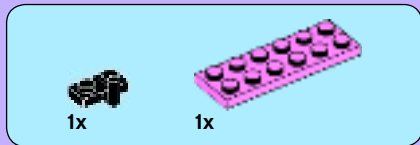

1

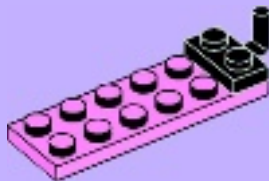

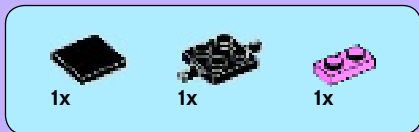

2

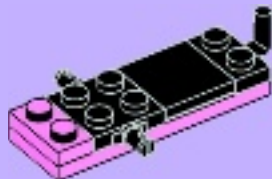

3

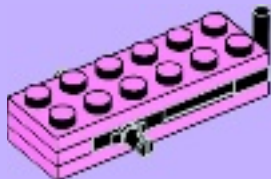





1x



2x

4

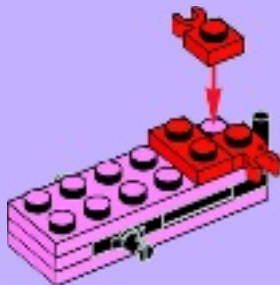

2x



2x

5





2x



2x

6

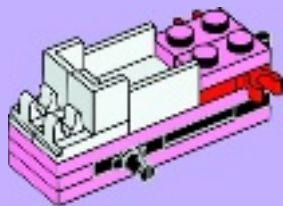

18



1x

7

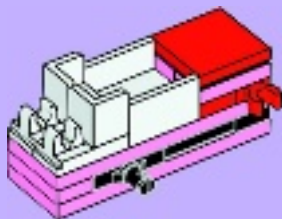



1x

1



1x

2

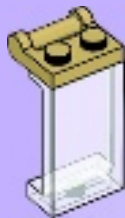



1x

3

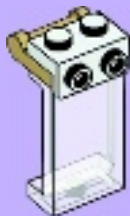

20



2x



1x



1x

4



8

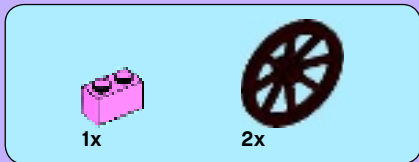
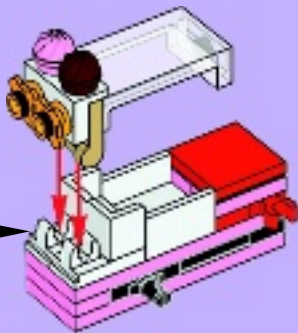

9





2x

10





2x

# 11

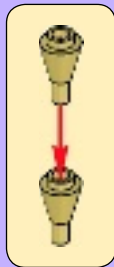

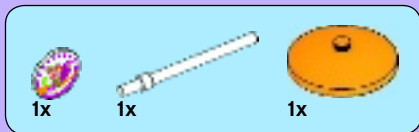

# 12





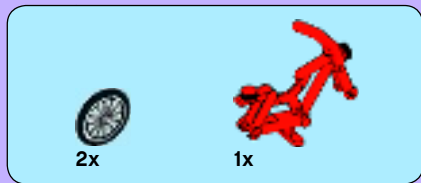

1

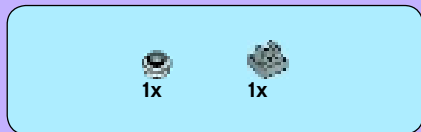

2



13

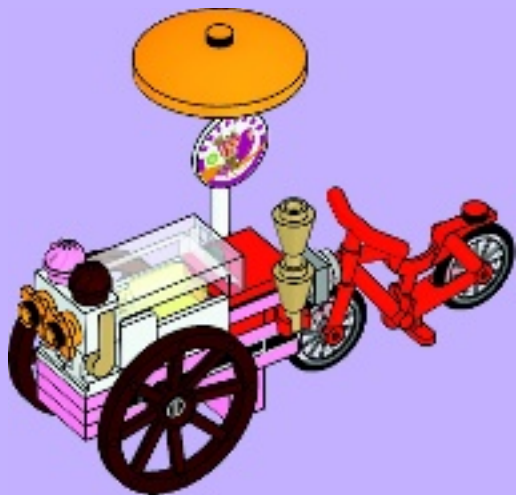





Friends

# Heartlake City



41058



41034



41031



41030





■ 41030



■ 41031



■ 41034



■ 41058



Friends



41058

**LEGO**

Friends





# Friends

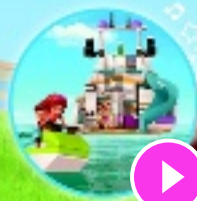

  
[LEGO.com/friends](http://LEGO.com/friends)

Apple, the Apple logo and iPad are trademarks of Apple Inc., registered in the U.S. and other countries. App Store is a service mark of Apple Inc. Apple, le logo Apple et iPad sont des marques de commerce d'Apple Inc., déposées aux États-Unis et dans d'autres pays. App Store est une marque de service d'Apple Inc. Apple, el logotipo de Apple e iPad son marcas comerciales de Apple Inc. registradas en EE. UU. y otros países. App Store es una marca de servicio de Apple Inc. Google Play is a trademark of Google Inc. Google Play est une marque de commerce de Google Inc. Google Play es una marca comercial de Google Inc.





# Friends



video  
games

NINTENDO 3DS NINTENDO DS

© 2014 The LEGO Group. ™ & © WBEI. (s14) "3DS", "DS" ™ & © 2014 Nintendo.  
All rights reserved/Tous droits réservés/Todos los derechos reservados.

 WB GAMES LOGO, WBIE LOGO, WB SHIELD: ™ & © Warner Bros. Entertainment Inc.  
(s14)



Visit [www.esrb.org](http://www.esrb.org) for  
rating information



1x  
6050914



4x  
4567449



2x  
303901



1x  
4119410



2x  
4598527



1x  
6018774



2x  
623101



2x  
486501



1x  
6081986



1x  
4125220



3x  
4217562



2x  
6017003



2x  
4651524



1x  
302321



1x  
306821



2x  
4588003



1x  
4521851



1x  
4261628



1x  
4558856



1x  
4569733



1x  
460026



1x  
302228



2x  
4107758



1x  
302028



1x  
302228



1x  
6010737



2x  
3005740



2x  
4183544



1x  
4155537



2x  
4568173



2x  
4622574



2x  
4556157



1x  
6030711



1x  
6096137



1x  
6043921



1x  
6049687



1x  
6071304



1x  
4649422



8x  
4651231



1x  
4655241



1x  
4567331



1x  
306826



4x  
4619524



2x  
4651902



1x  
6060731



2x  
4211279



1x  
6074384



1x  
6003002



6x  
4624184



2x  
4216479



1x  
6060795



1x  
4517993



5x  
4654128



2x  
4625633



2x  
4504850



1x  
6029690



1x  
6003008



**Customer Service**

**Kundenservice**

**Service Consommateurs**

**Servicio Al Consumidor**

**LEGO.com/service or dial**



**: 00800 5346 5555**

**: 1-800-422-5346**