

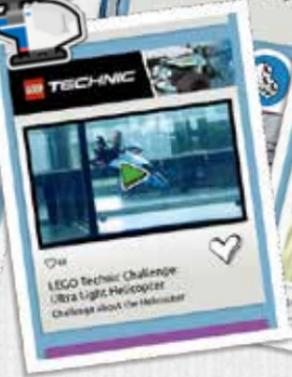

# TECHNIC

42071





1



2

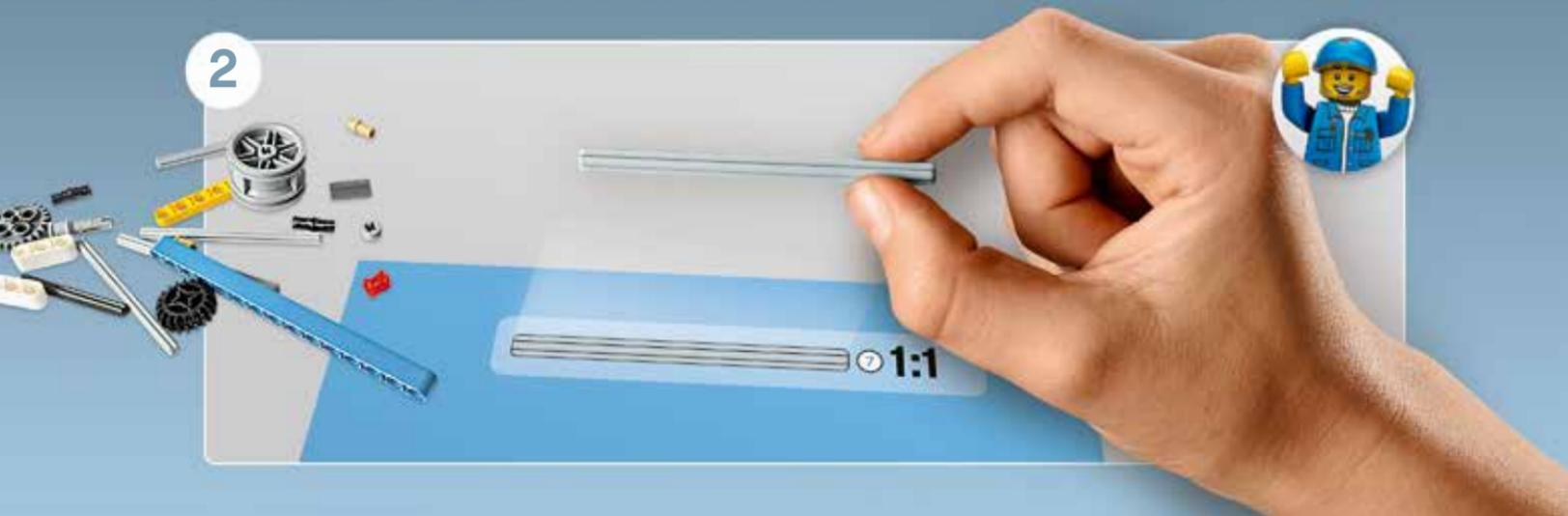

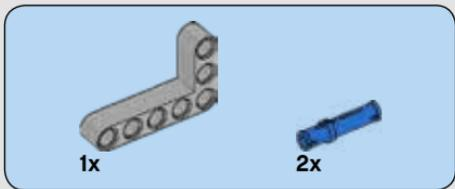
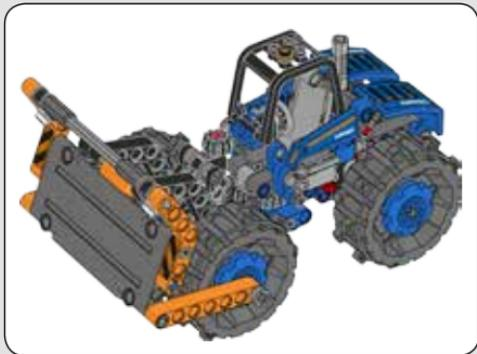

1

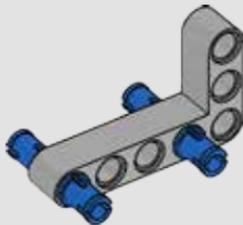

4

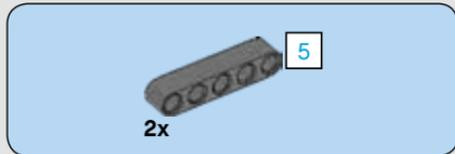

2

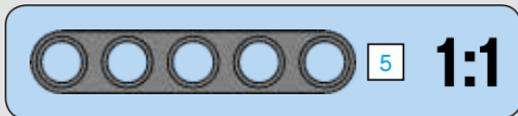
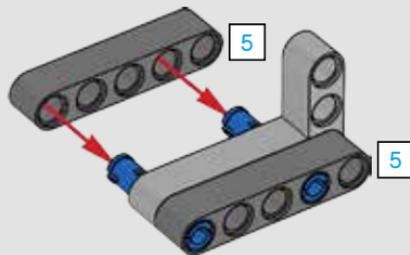

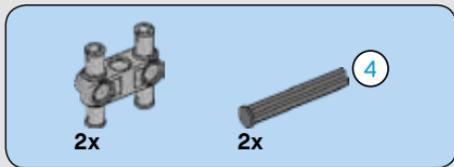

3

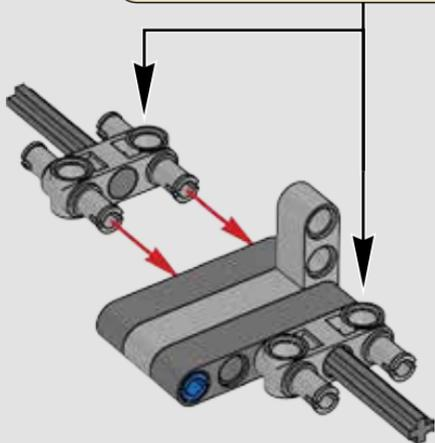
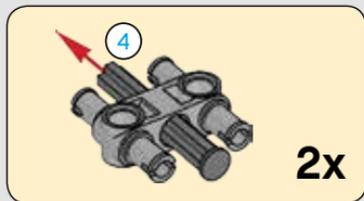

4

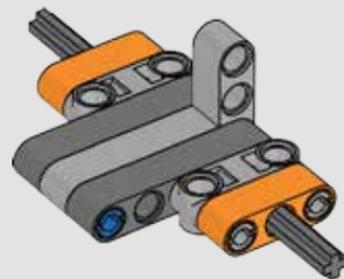

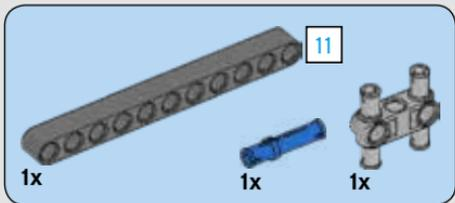
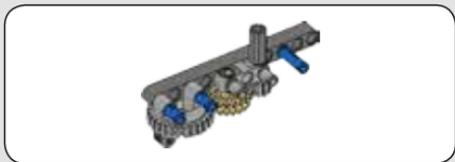

5

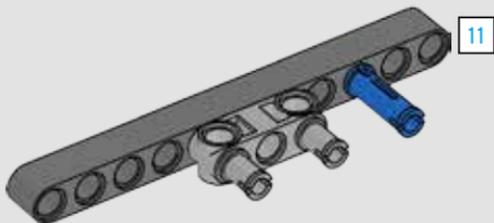

6

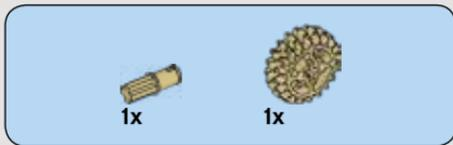
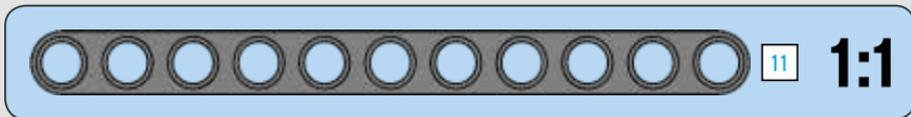

6

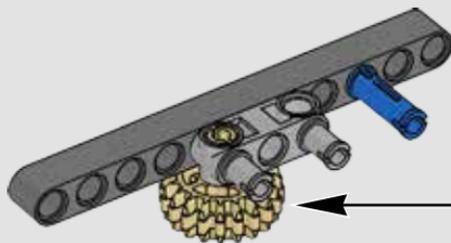
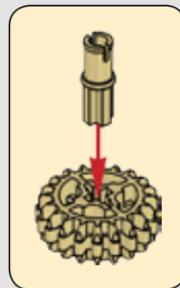

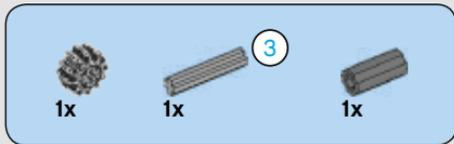

7

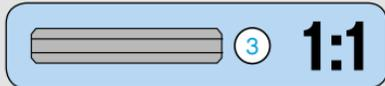
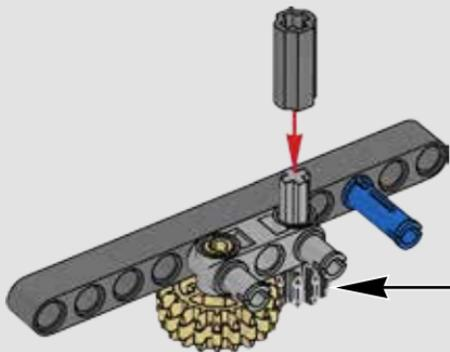

8

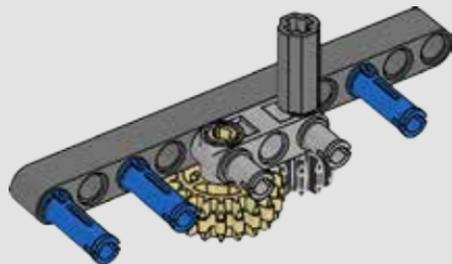

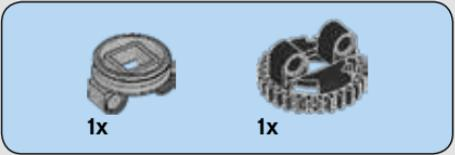

9

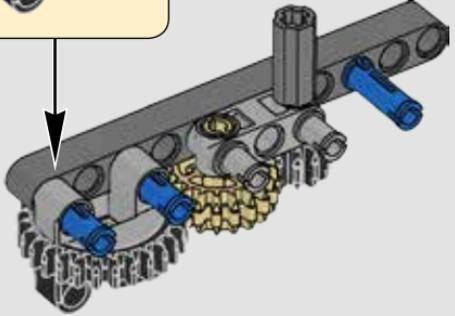
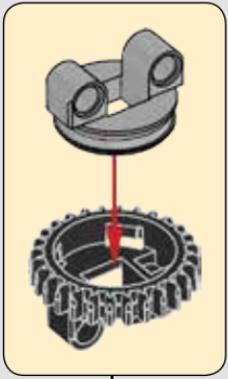

8

10

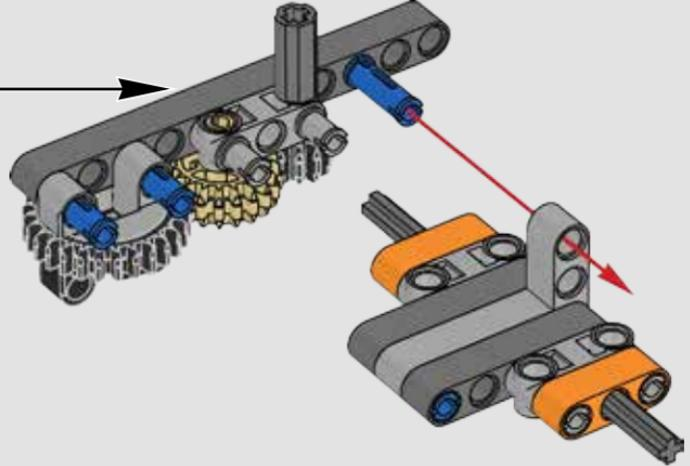



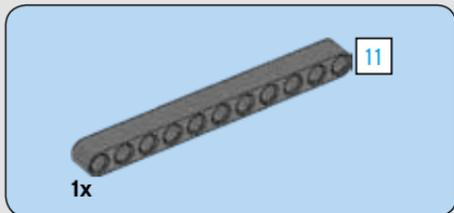

11

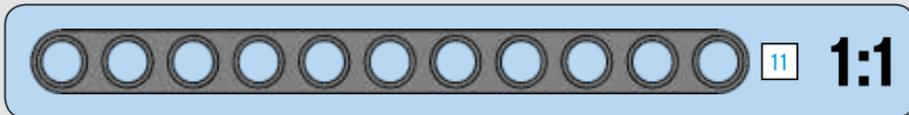
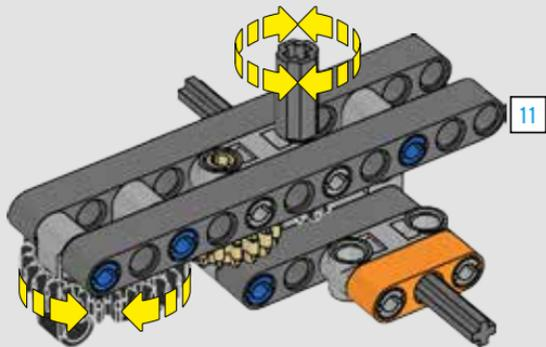

12

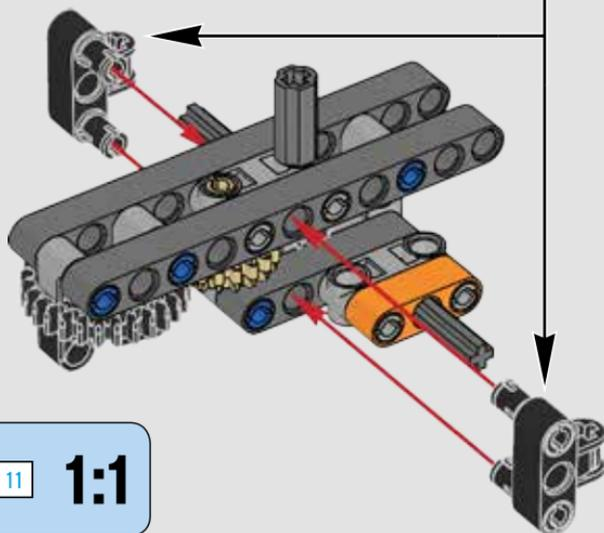
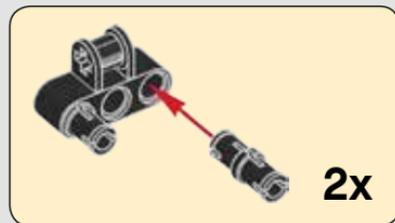

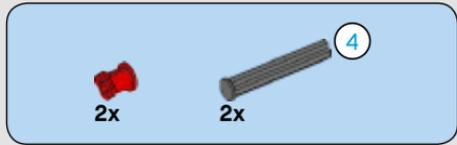

13

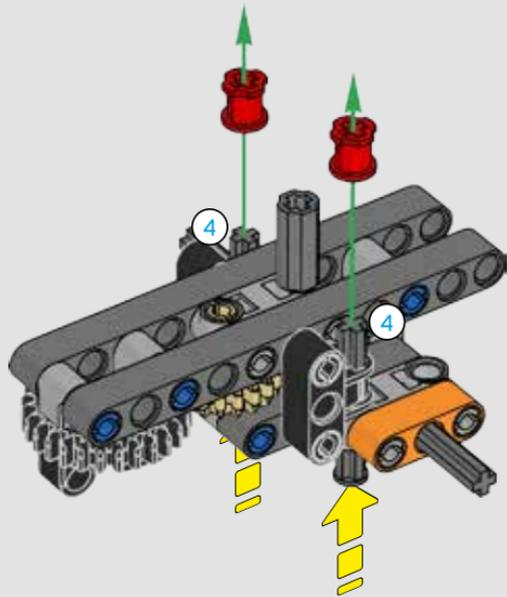

10

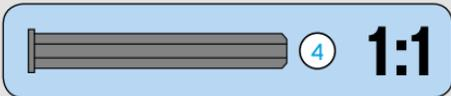

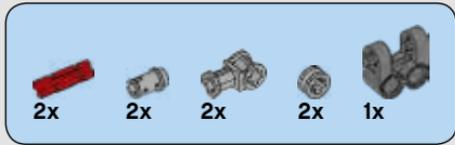

# 14

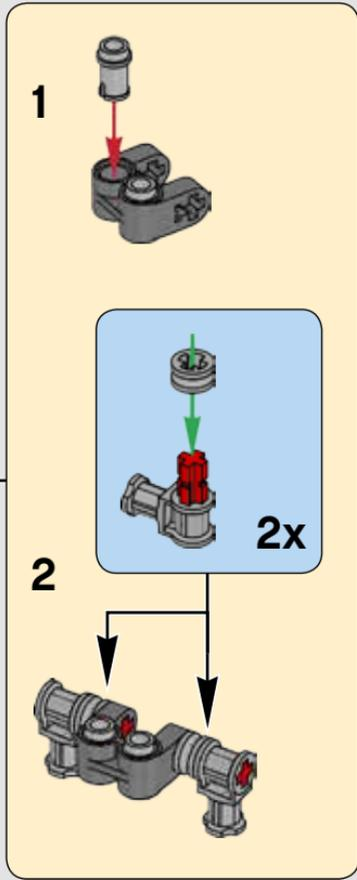
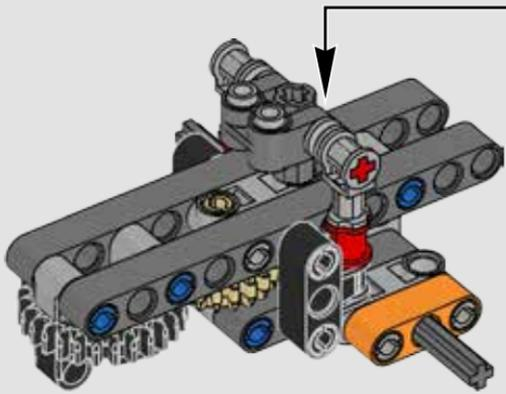

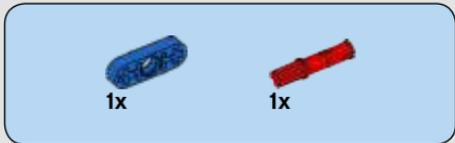

15

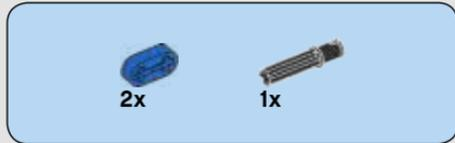

16

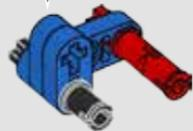
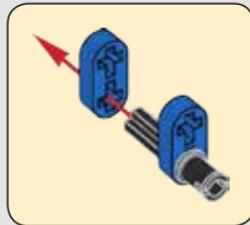

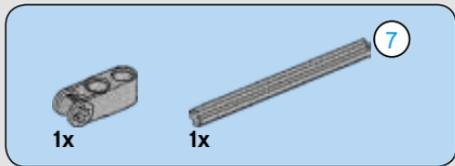

17

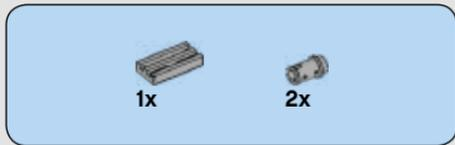
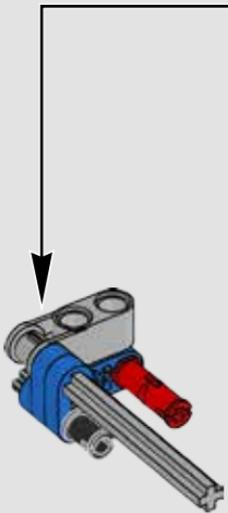
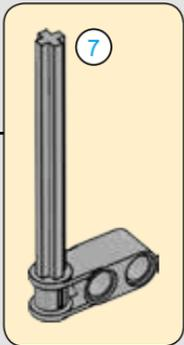

18

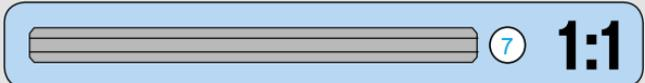
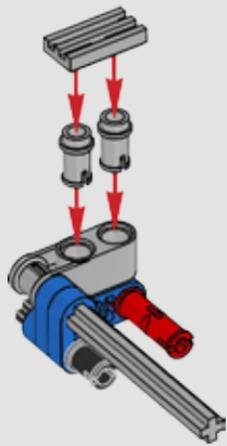

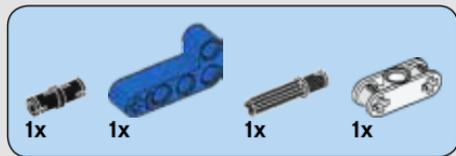

19

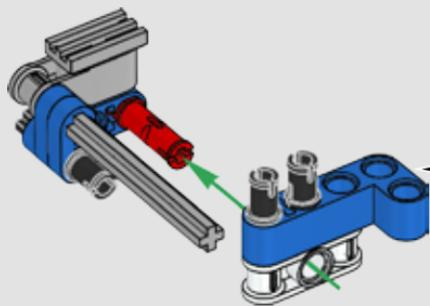
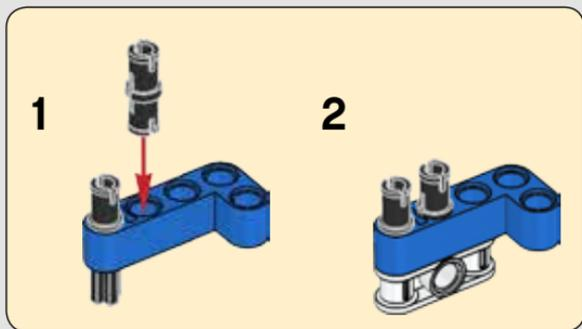

20

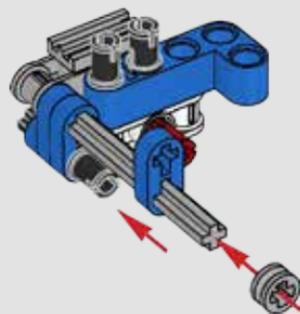

# 21

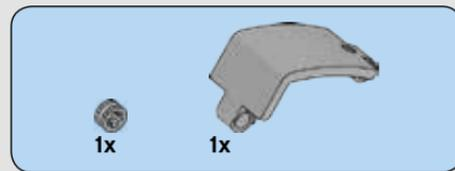
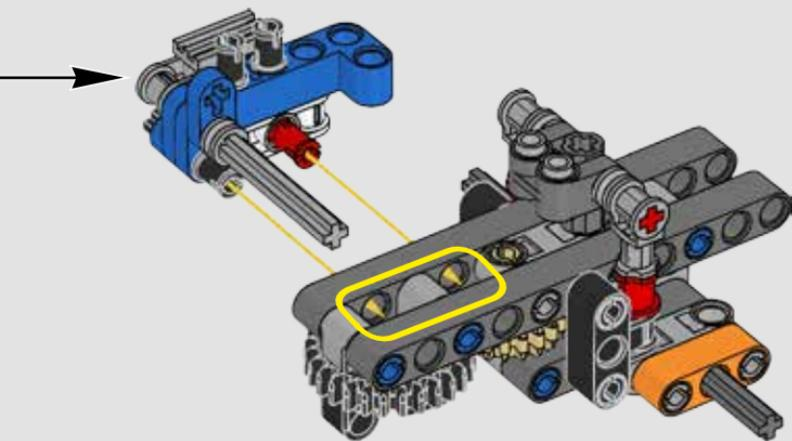

# 22

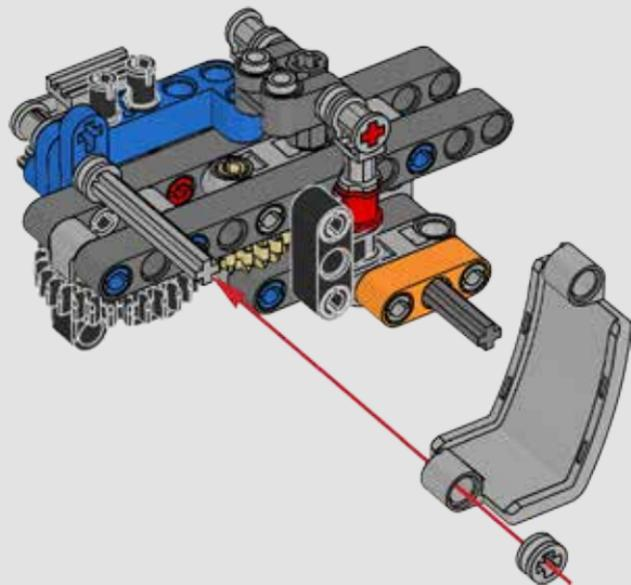

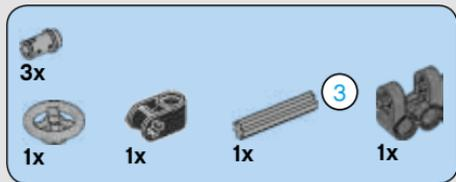

23

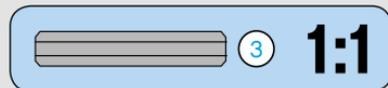
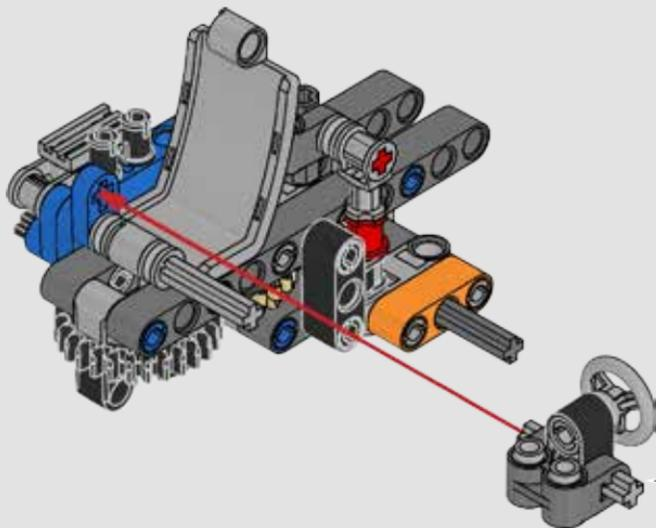
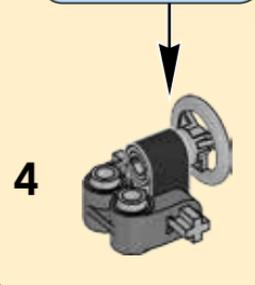
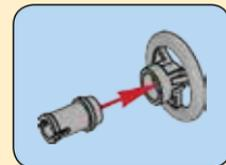
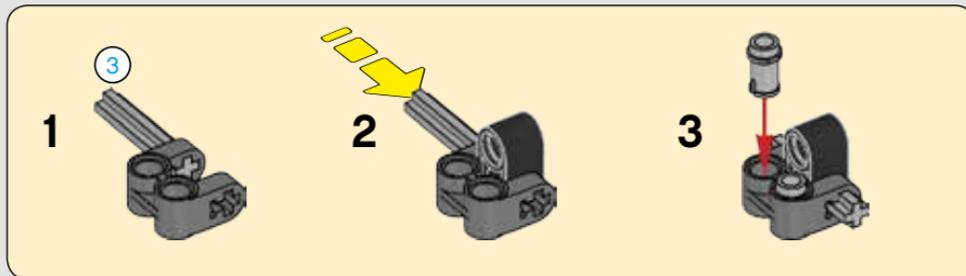





1x

# 24

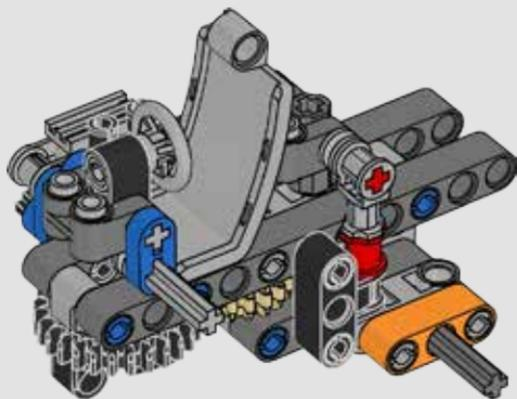

2x



1x

# 25

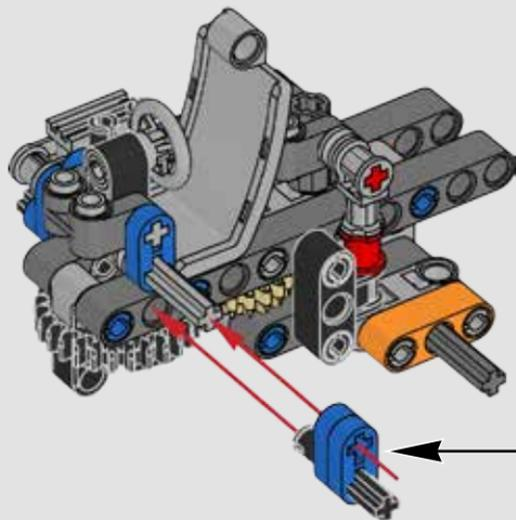
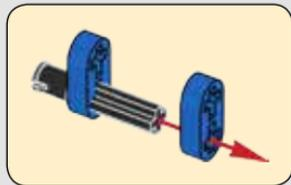

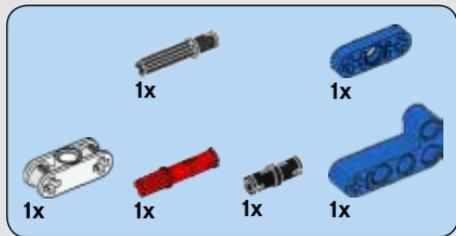

26

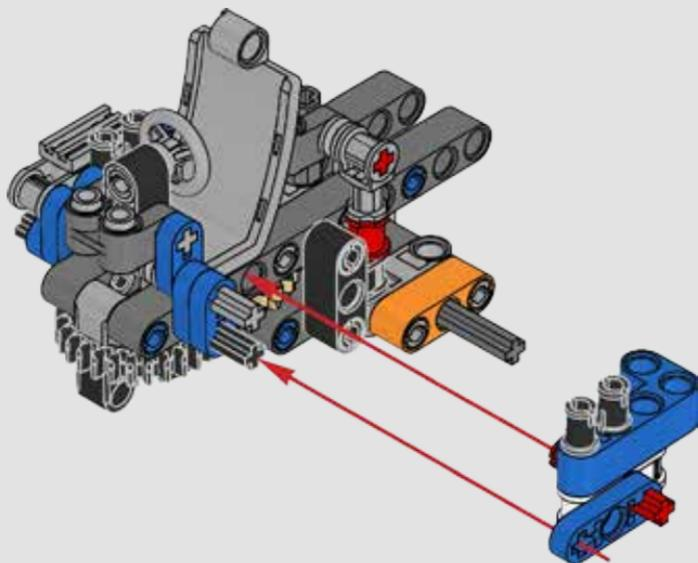
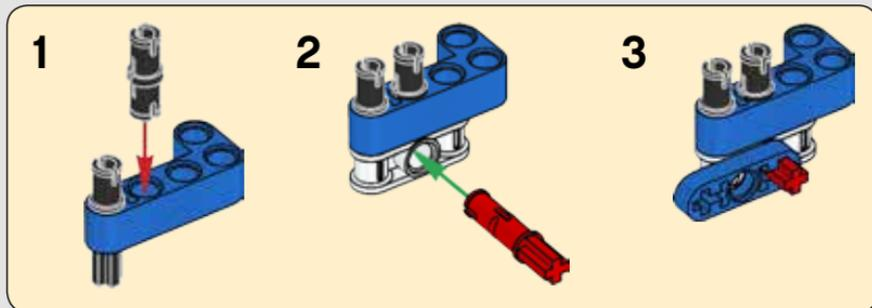



27

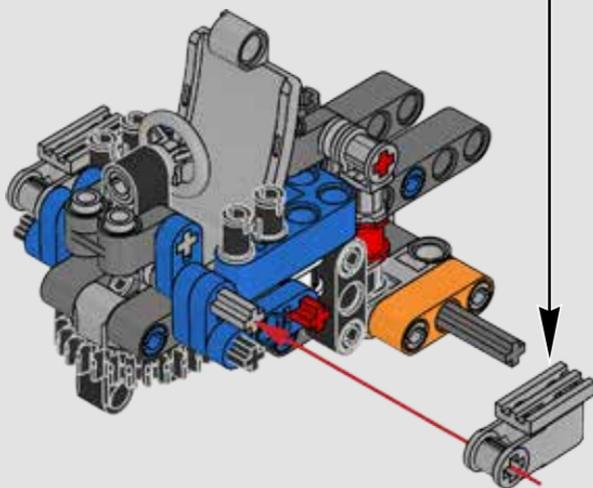
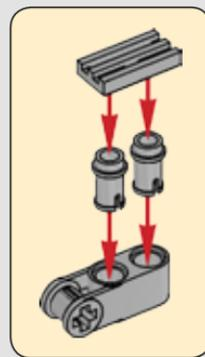

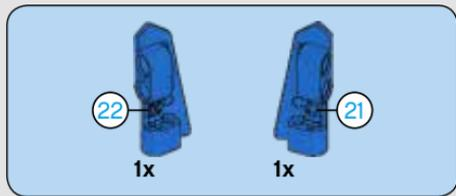

28

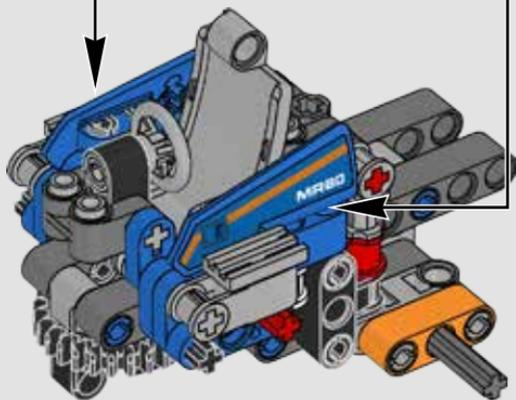

29

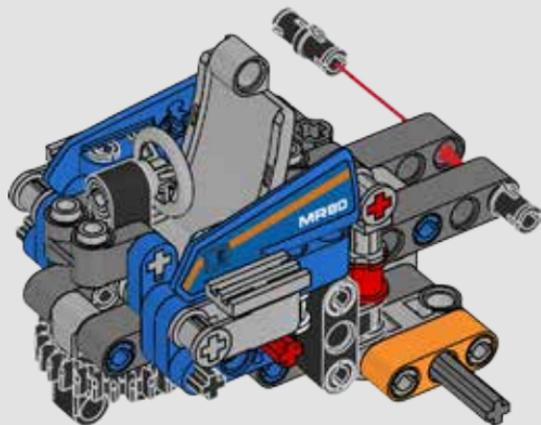

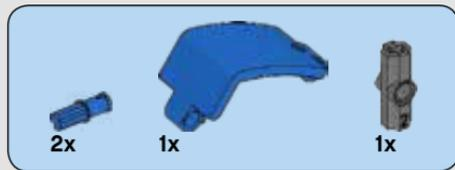

30

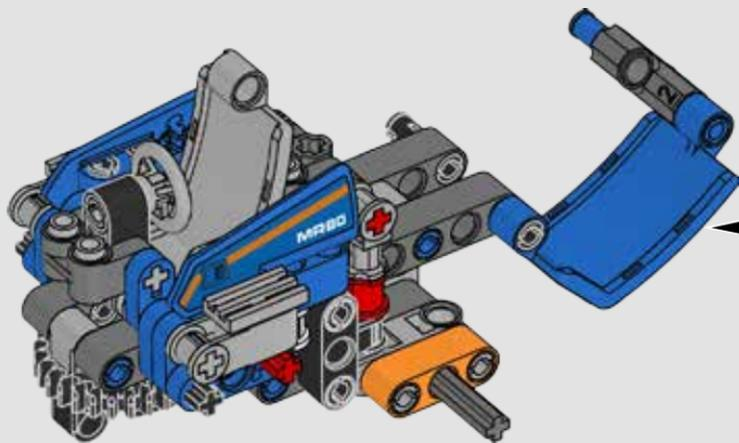
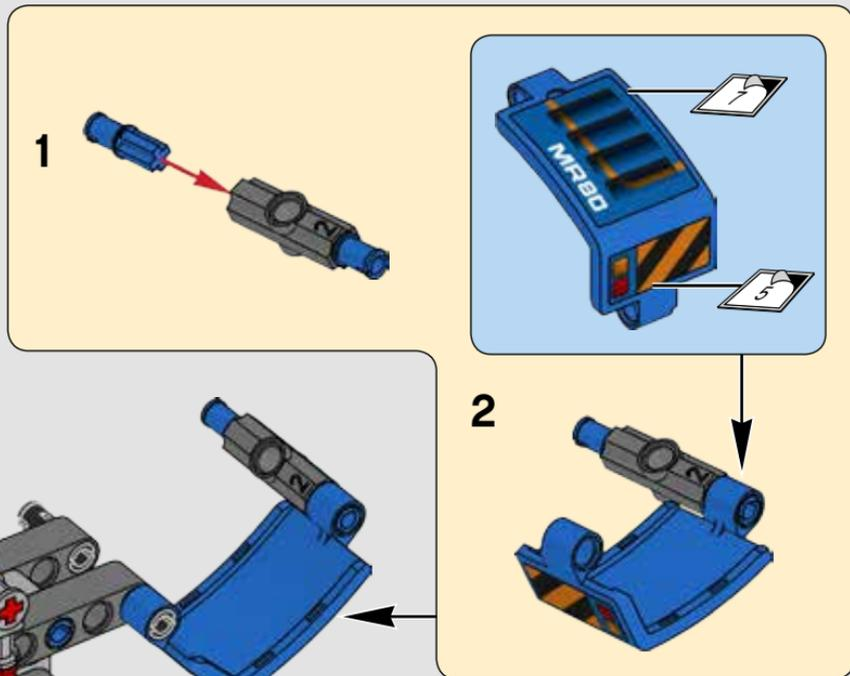

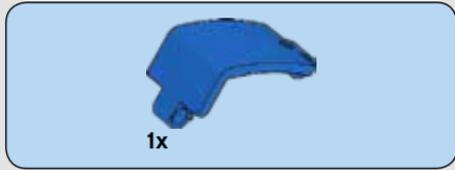

31

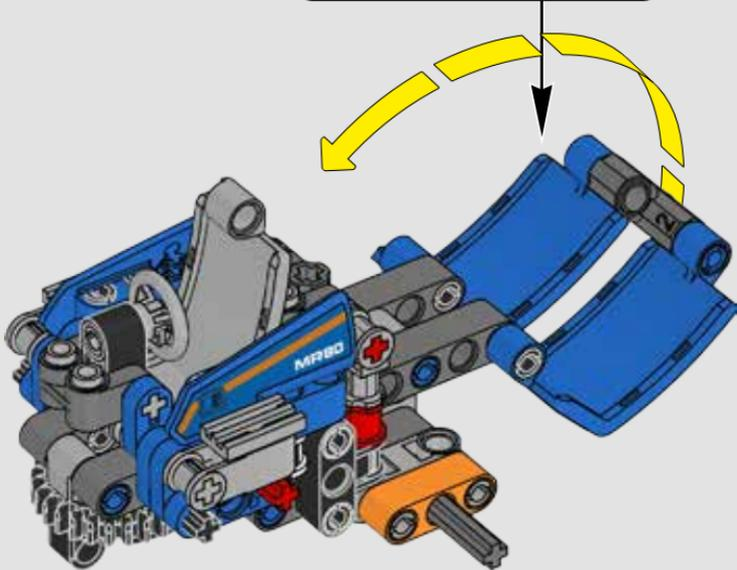
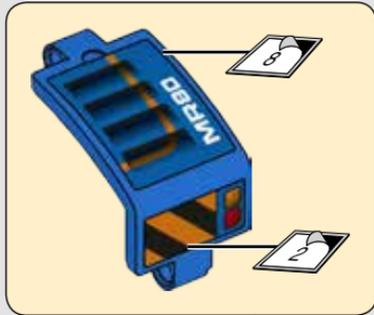

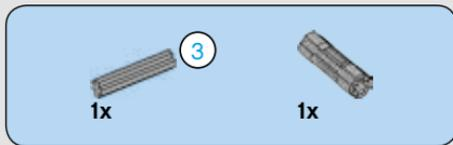

32

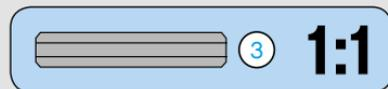
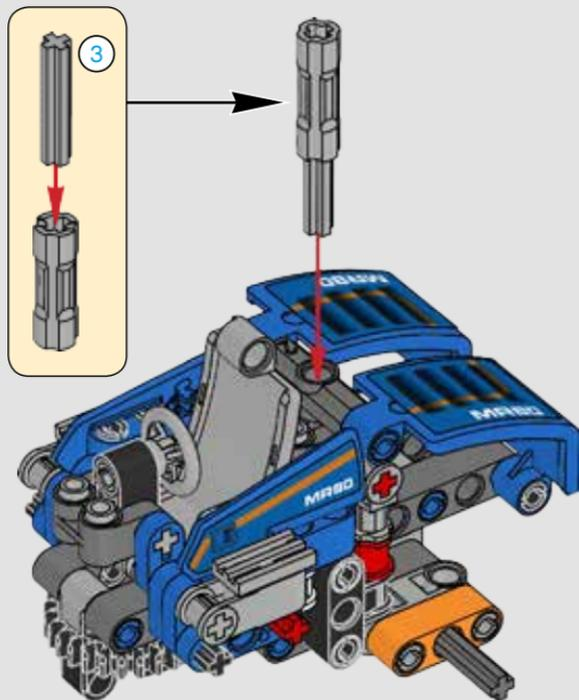

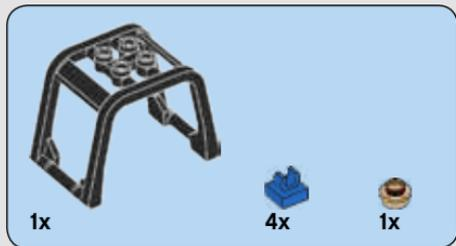

33

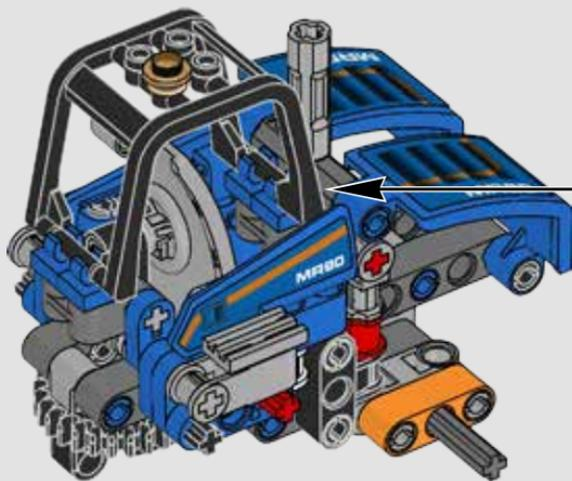
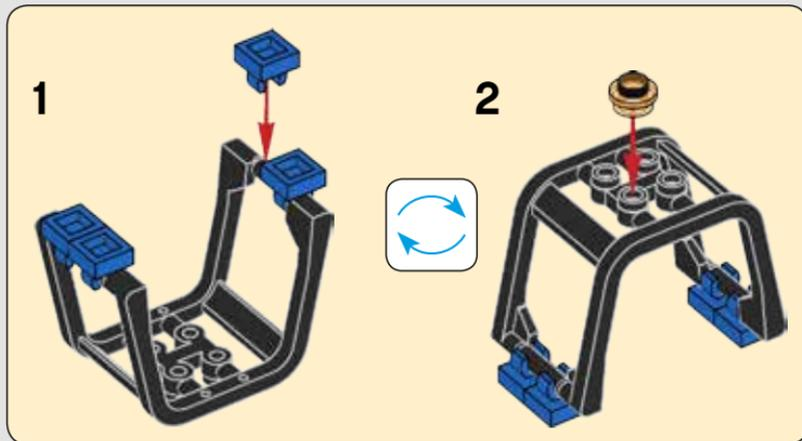



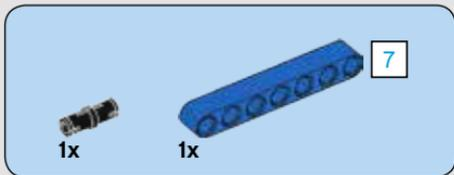

34

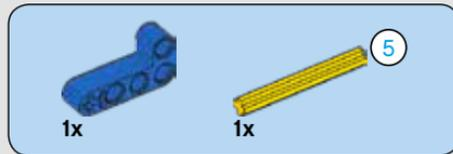
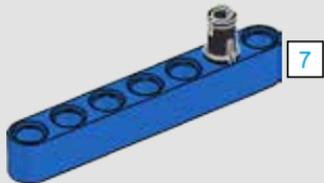

35

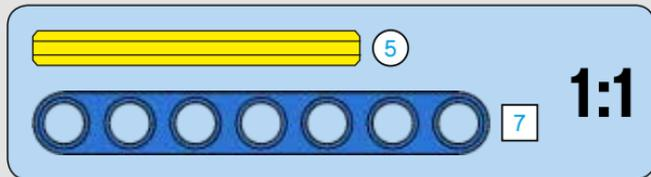
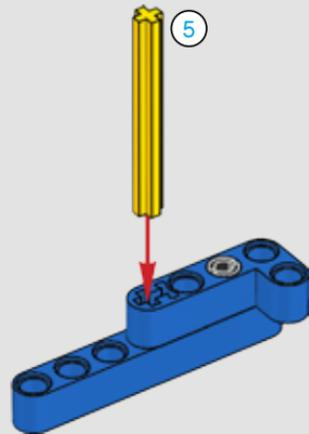



2x

36

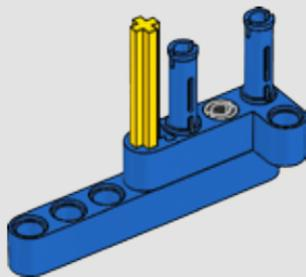

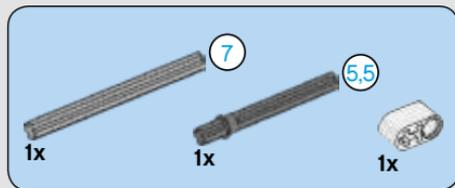

**37**

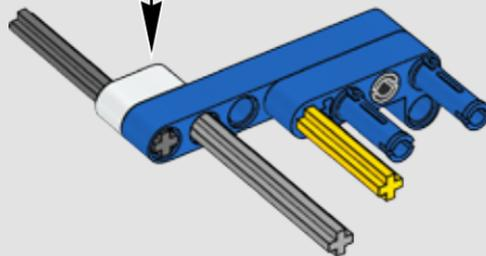
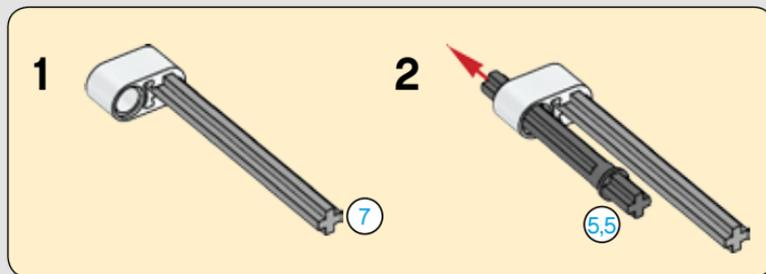

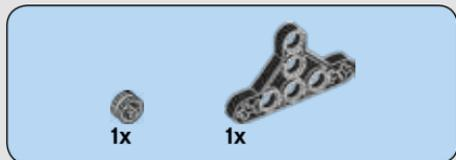

38

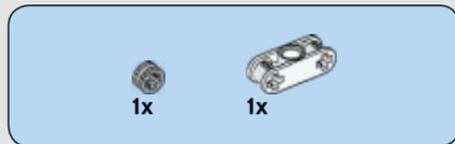
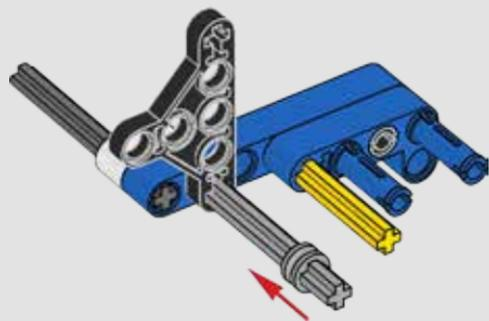

39

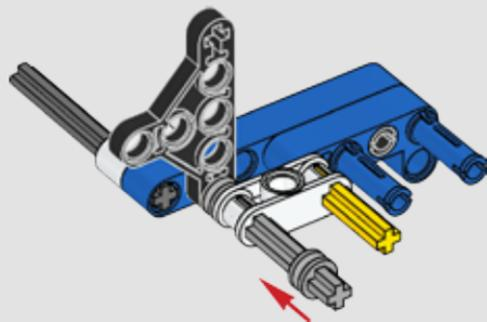

40

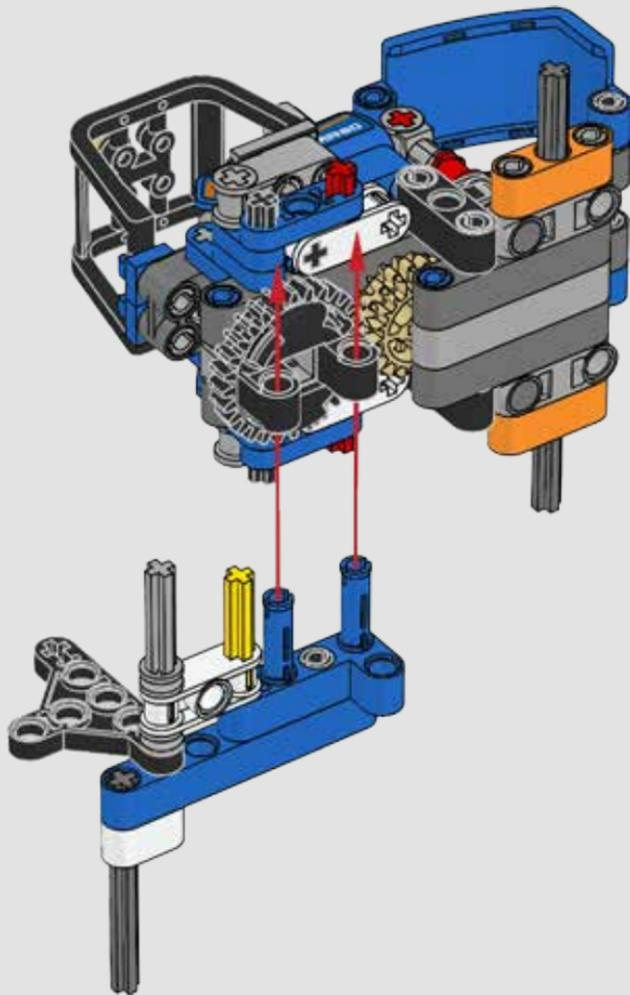

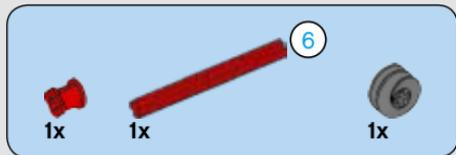

41

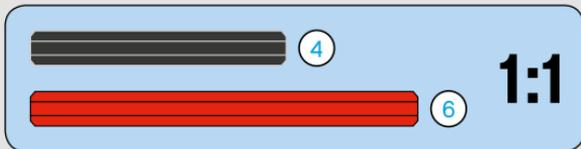

30

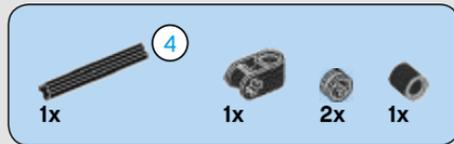

42

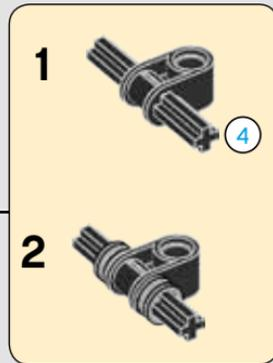
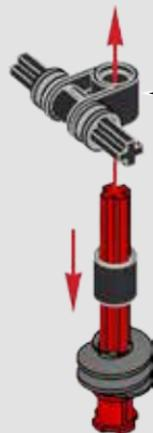



1x

43



44

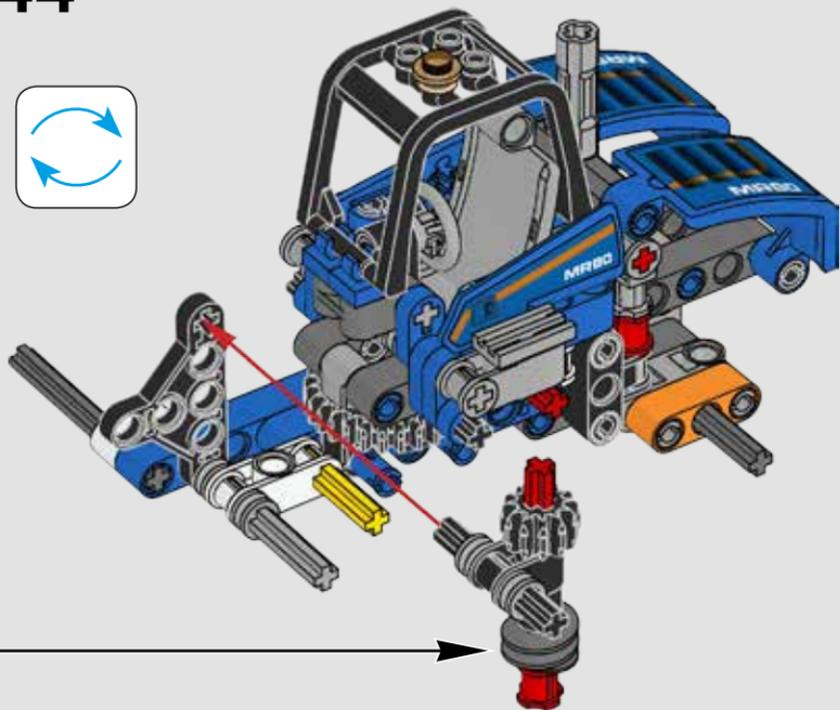

45

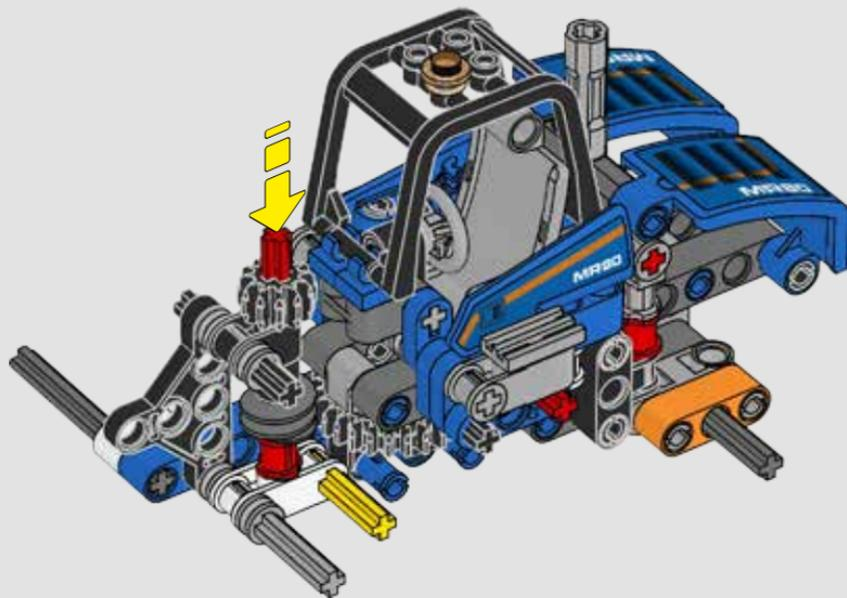







1x

47

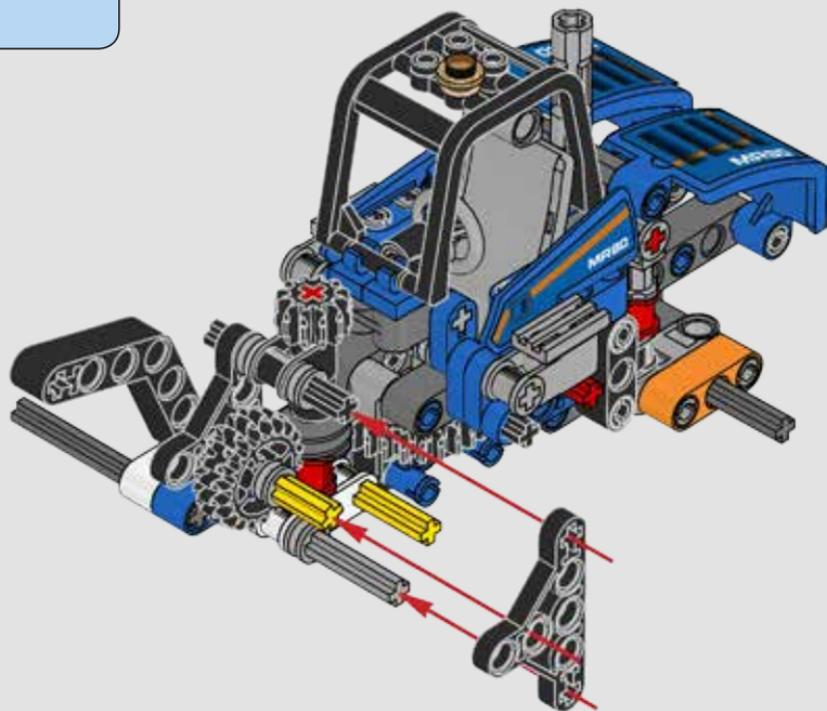

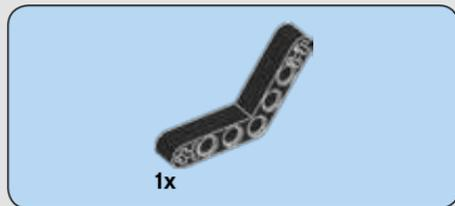

48

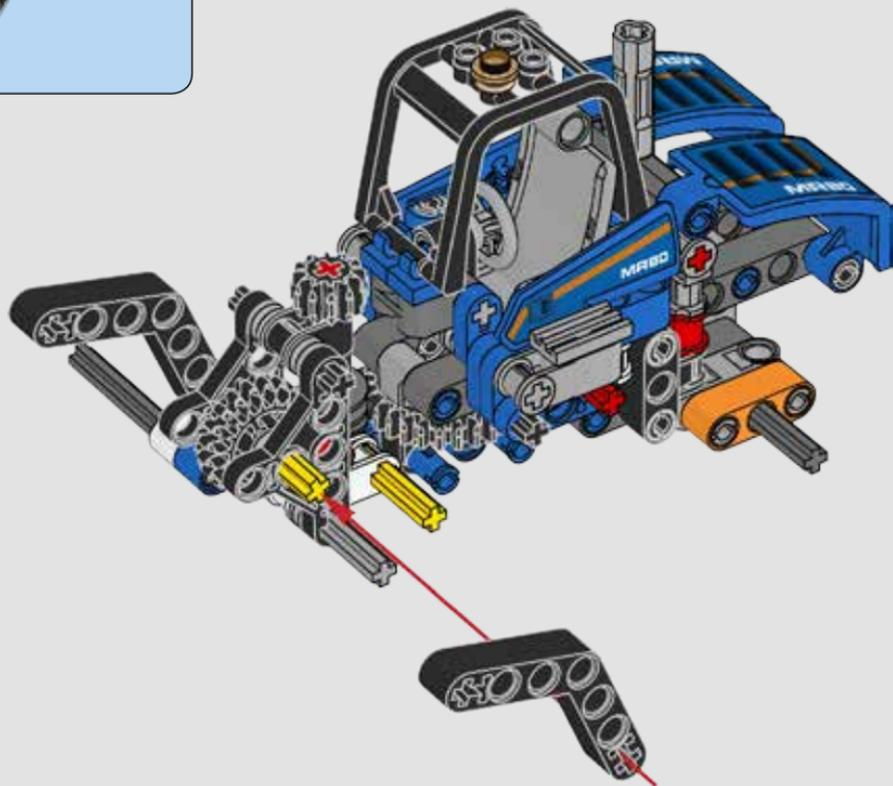

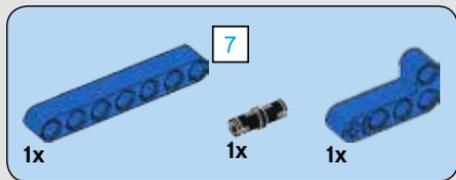

49

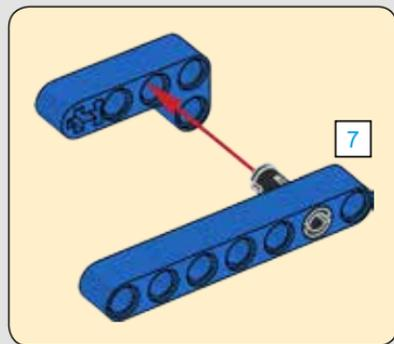
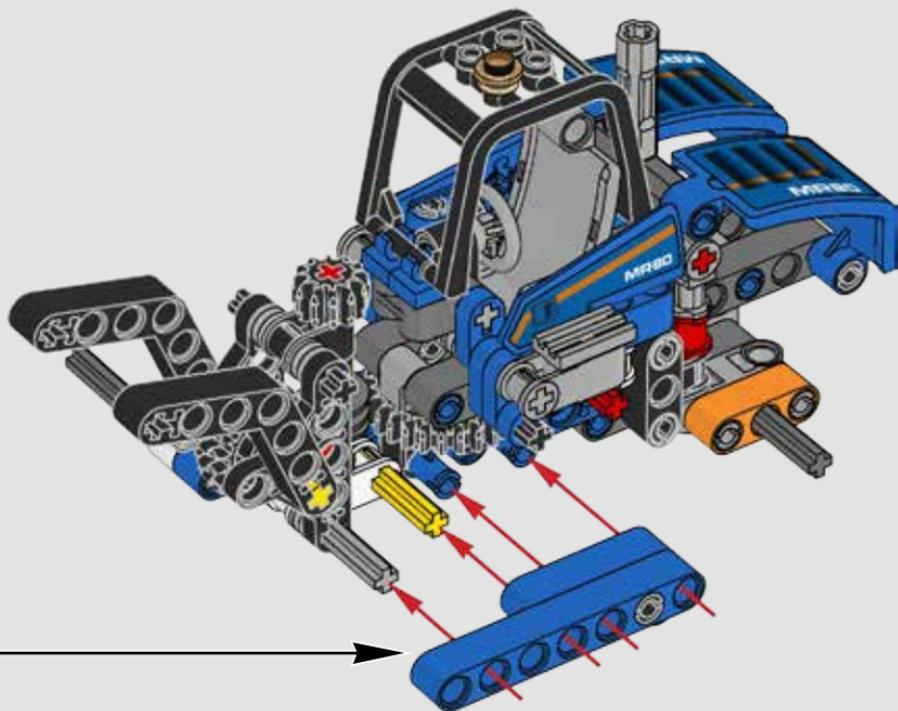

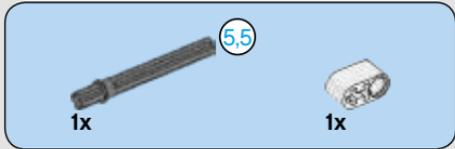

50

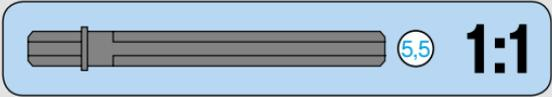
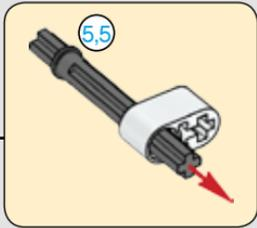
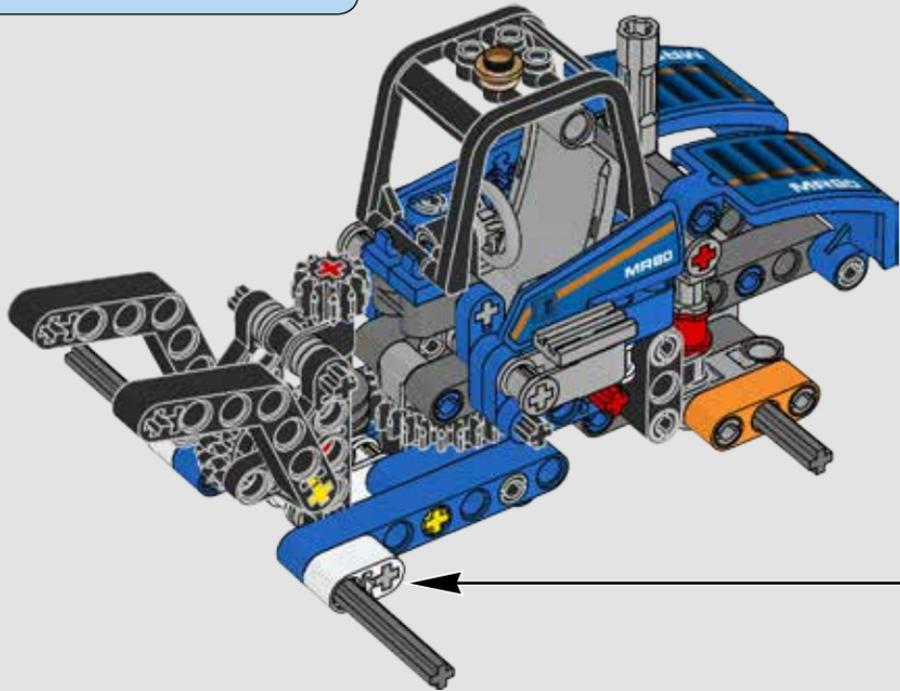

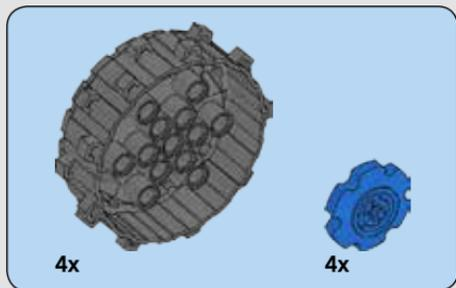

51

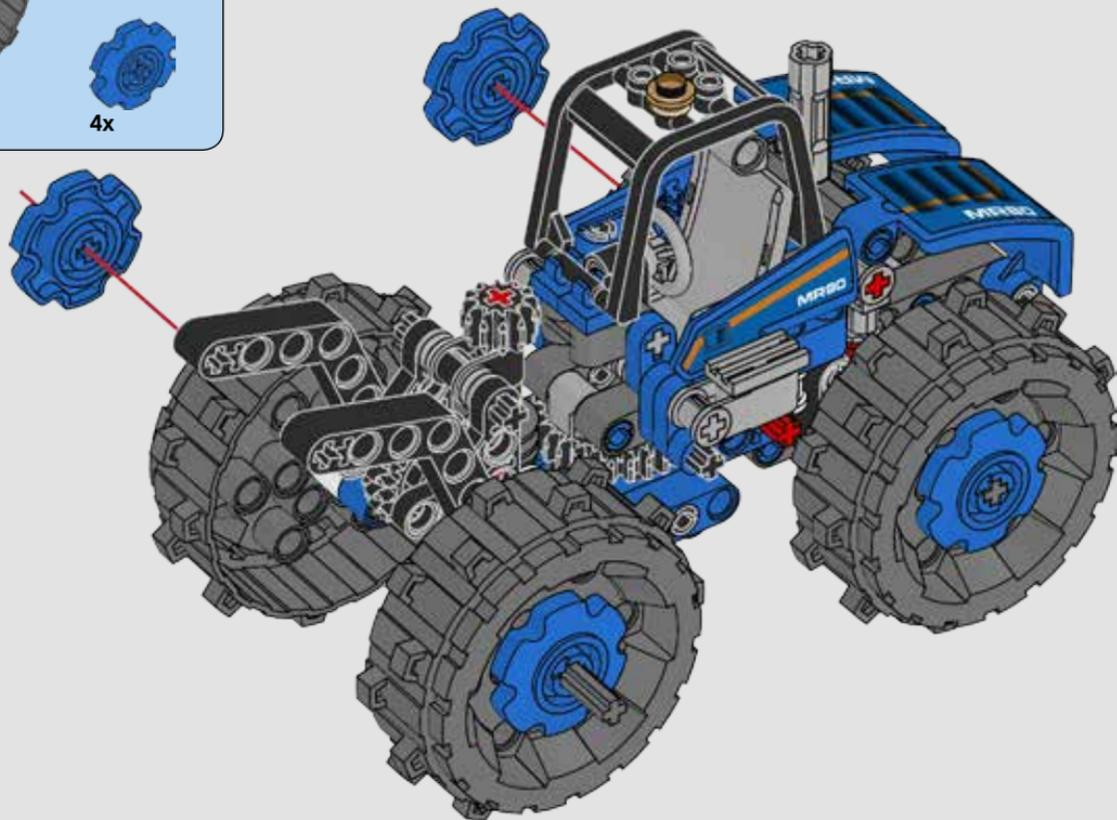



2x



2x

# 52



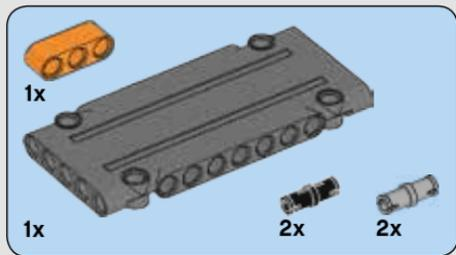

53

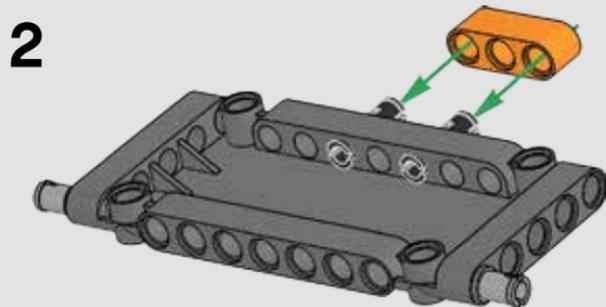
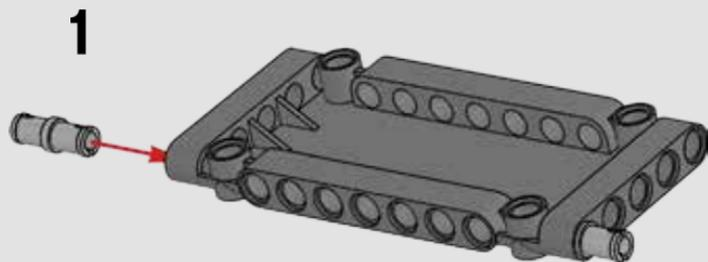



54

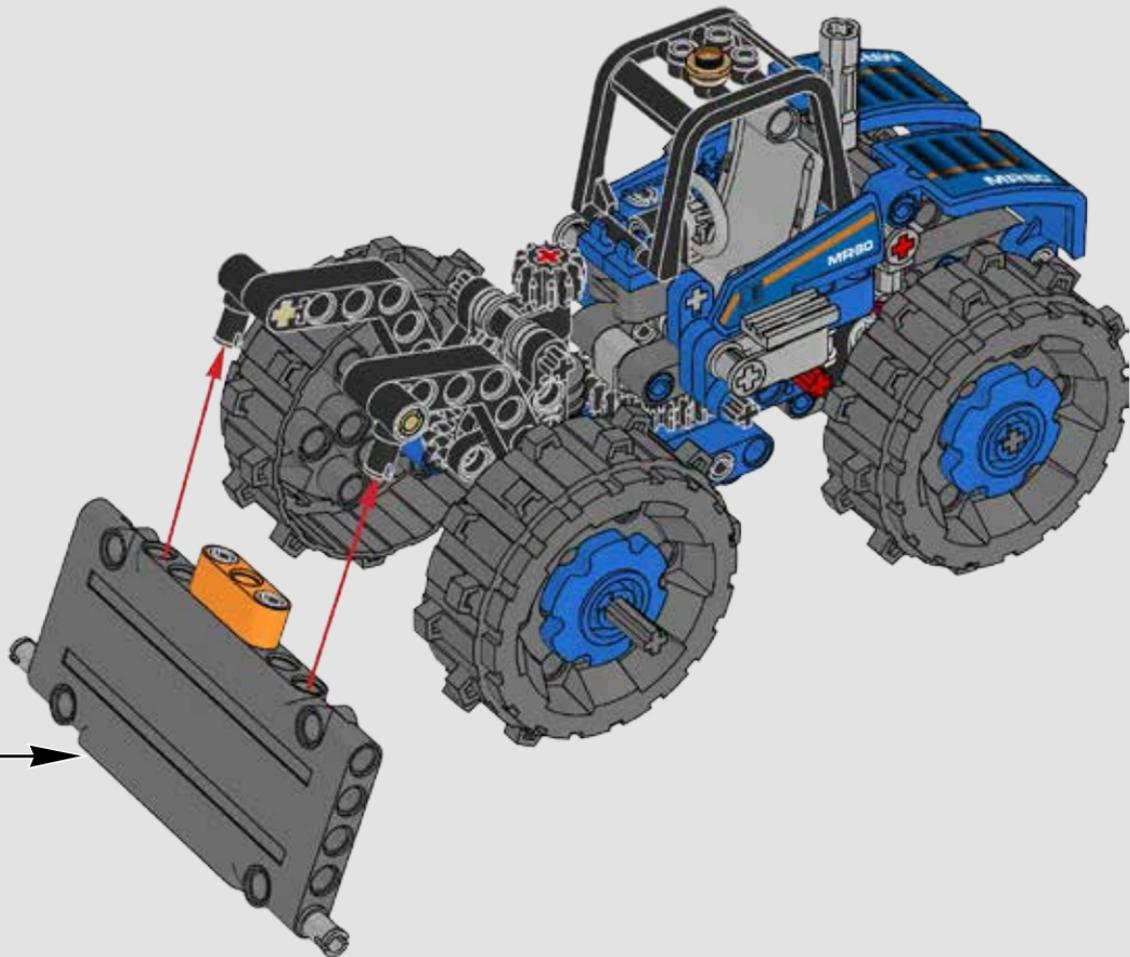

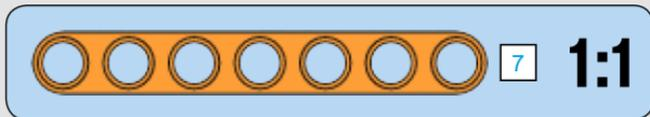
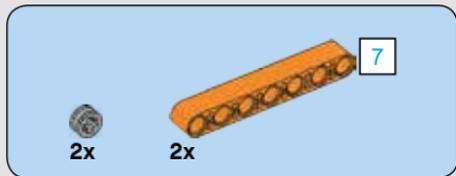

55

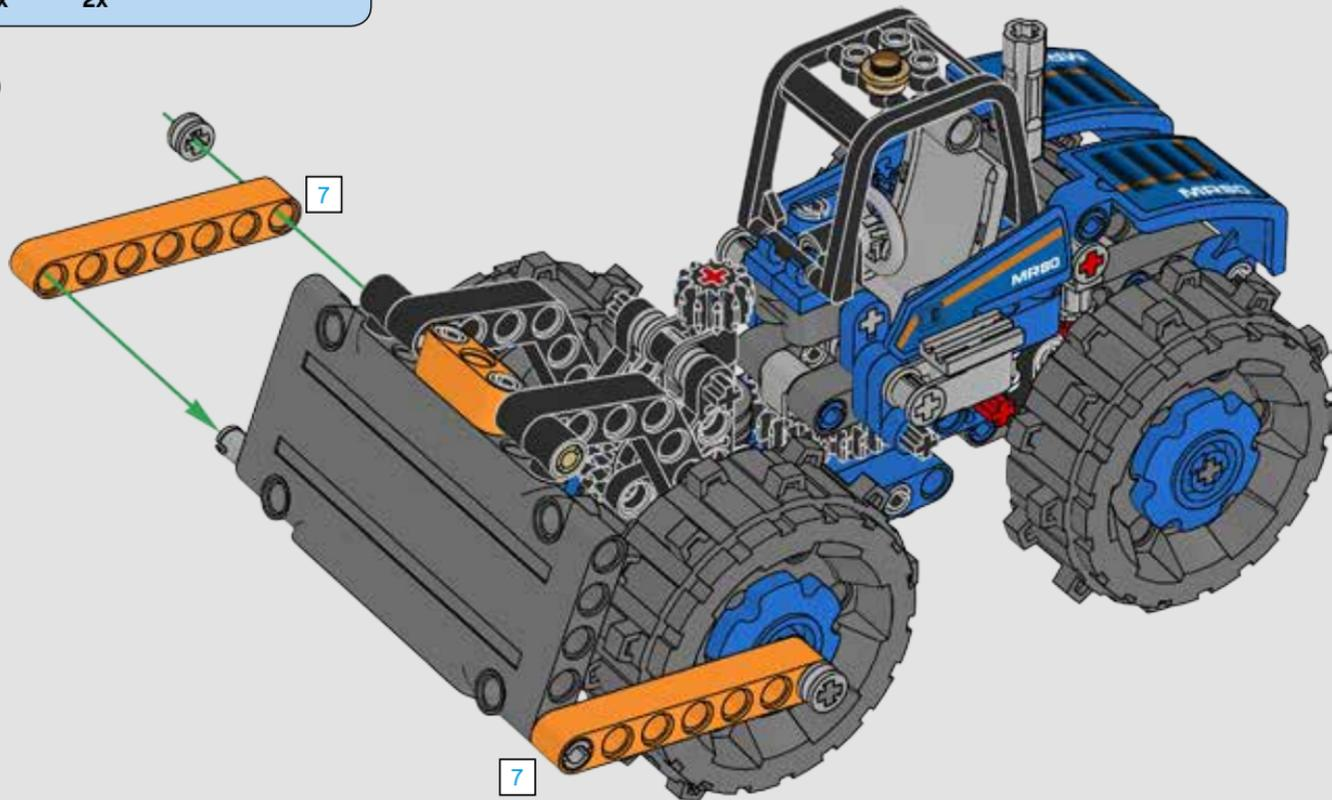

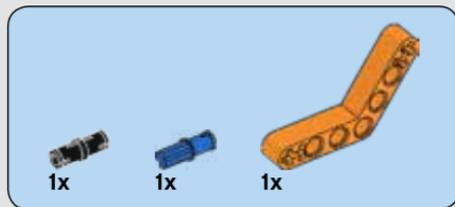

56

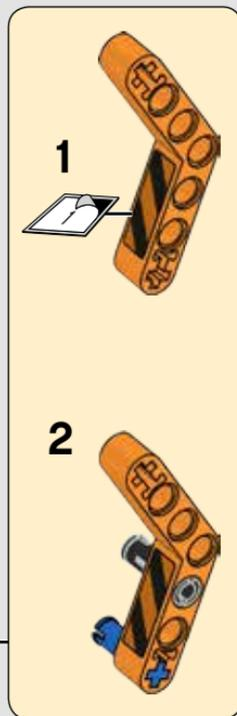
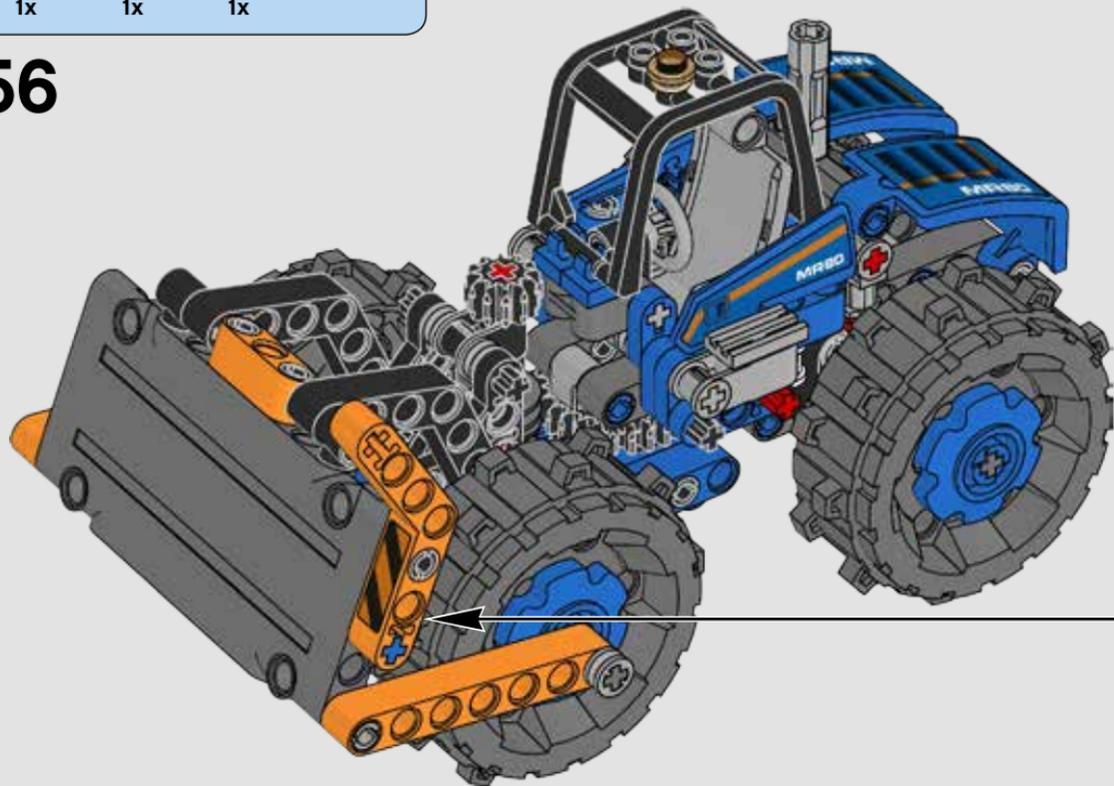

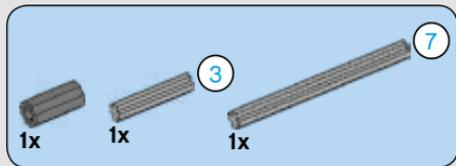

57

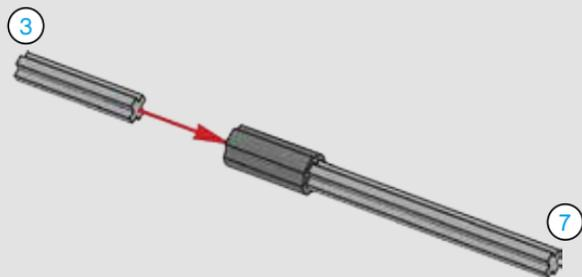

44

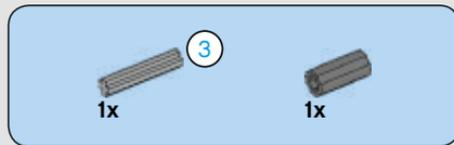

58

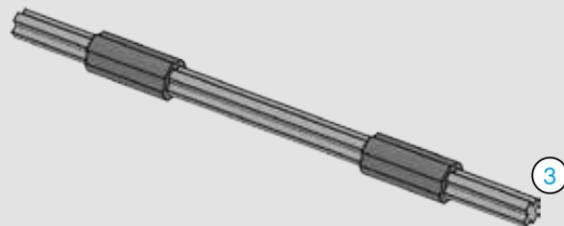



2x



2x

# 59



2x

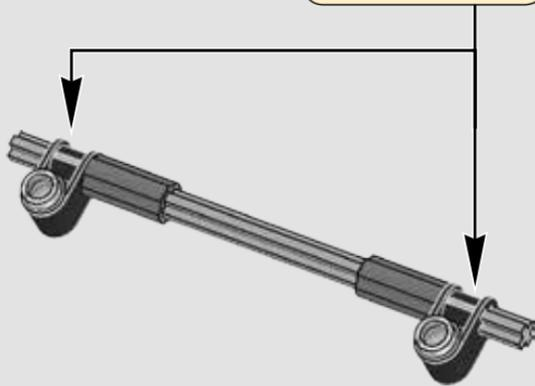

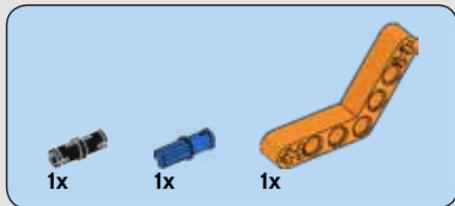

60

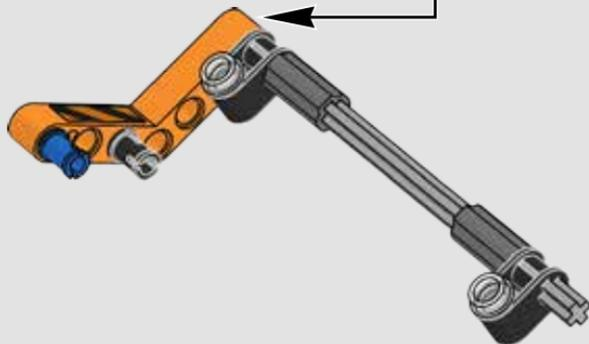
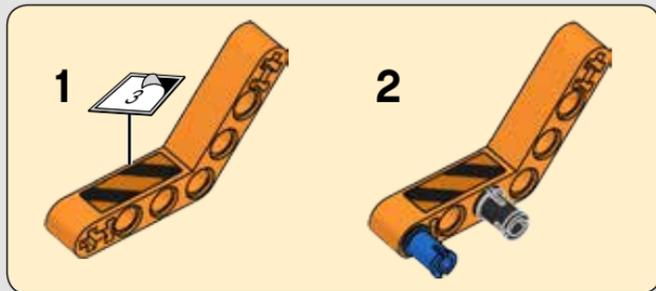

61

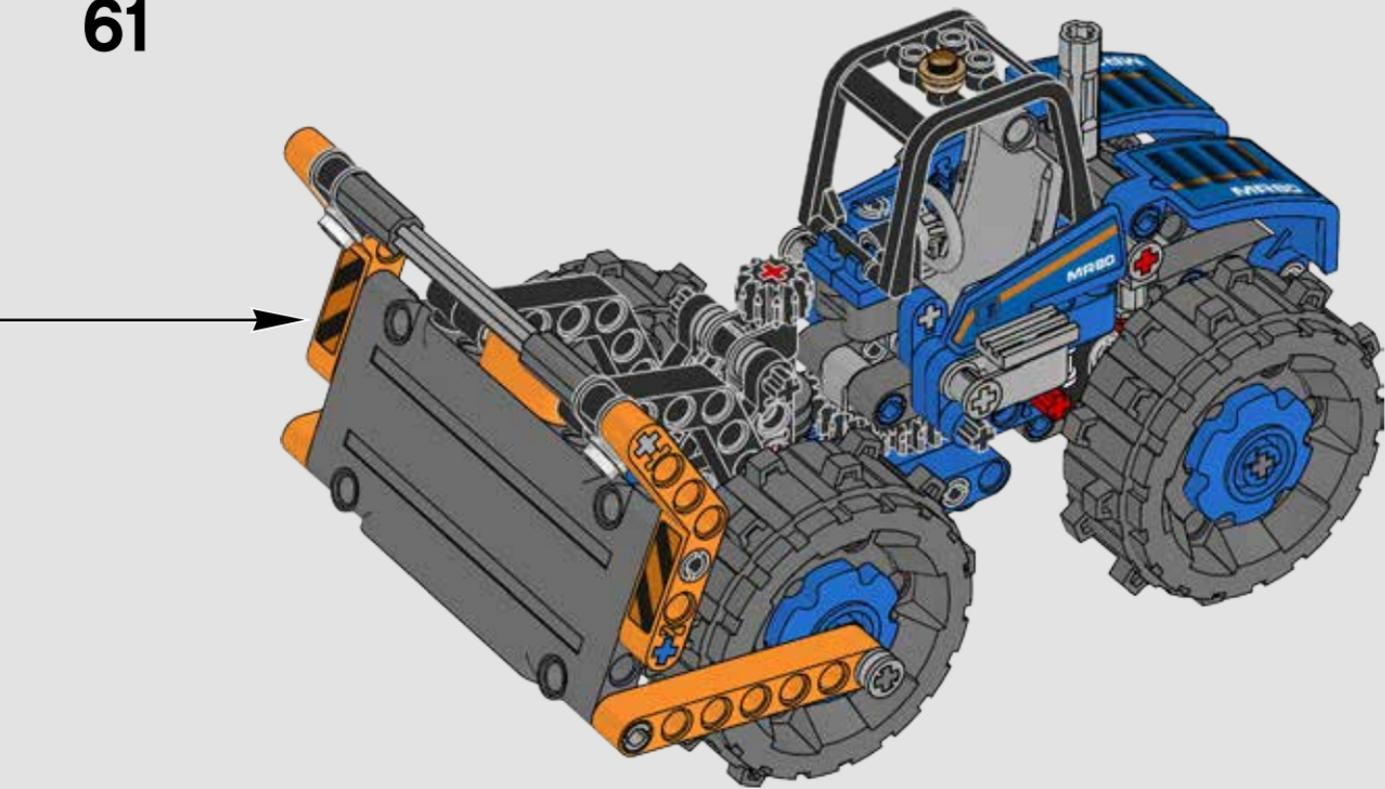

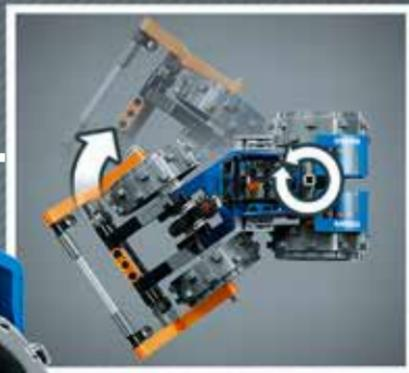
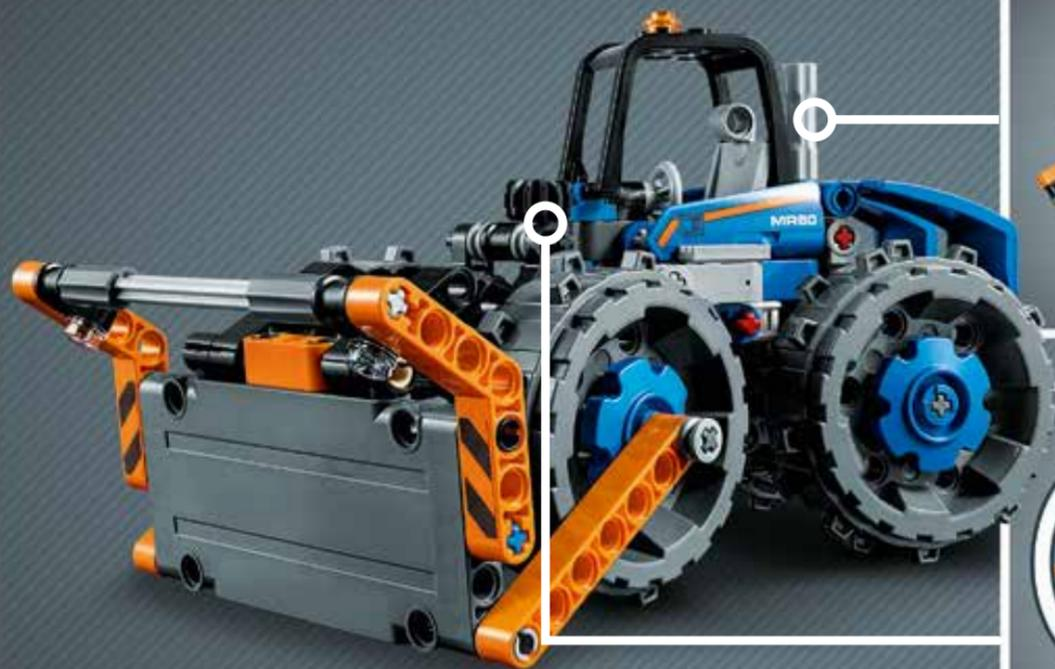





# TECHNIC

42074



42073



42072



42084



42071







**Customer Service**

**Kundenservice**

**Service Consommateurs**

**Servicio Al Consumidor**

**LEGO.com/service or dial**



**: 00800 5346 5555**

**: 1-800-422-5346**

# WIN

GO TO [WWW.LEGO.COM/PRODUCTFEEDBACK](http://WWW.LEGO.COM/PRODUCTFEEDBACK) AND  
GIVE US YOUR SHORT **FEEDBACK** ABOUT THIS  
LEGO® SET FOR A CHANCE TO WIN  
A COOL LEGO PRIZE.

Terms & Conditions apply



## [LEGO.com/productfeedback](http://LEGO.com/productfeedback)

### GEWINNE

Erzähle uns auf  
[www.LEGO.com/productfeedback](http://www.LEGO.com/productfeedback)

etwas über die Erfahrungen, die du mit  
diesem LEGO® Set gemacht hast, und  
sichere dir die Chance auf einen coolen  
LEGO Preis!

Es gelten die Teilnahmebedingungen

### GAGNE

Rends-toi sur  
[www.LEGO.com/productfeedback](http://www.LEGO.com/productfeedback)

et donne-nous quelques commentaires sur  
ce produit LEGO® pour avoir une chance  
de gagner un prix LEGO !

Voir Conditions Générales

### GANAN

Visita  
[www.LEGO.com/productfeedback](http://www.LEGO.com/productfeedback)

y envíanos tu opinión acerca de este set  
LEGO®. ¡Participarás en el sorteo de un  
premio LEGO!

Términos y Condiciones aplicables

### 获取奖品

登录  
[www.LEGO.com/productfeedback](http://www.LEGO.com/productfeedback)

给出关于此乐高®套装的简短反馈，  
就有机会获得炫酷乐高奖品

《条款及条件》适用

LEGO and the LEGO logo are trademarks of the/ont des marques de commerce du/son marcas registradas de LEGO Group. ©2018 The LEGO Group.

6221056/6221058