



Disney

43221





Get excited about our new packaging!

We're switching from plastic to paper-based packaging. That's why you might find a mix of paper and plastic in our boxes!

Nos nouveaux emballages vous emballeront !

Nous passons des emballages en plastique aux emballages à base de papier. C'est pourquoi vous pourriez trouver un mélange de papier et de plastique dans nos boîtes !

¡Te presentamos nuestros nuevos empaques!

Estamos sustituyendo las bolsas de plástico por bolsas con base de papel. ¡Por eso, puedes encontrar una mezcla de papel y de plástico en nuestras cajas!

[LEGO.com/sustainable-packaging](https://www.lego.com/sustainable-packaging)

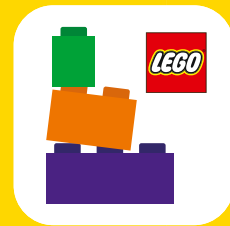

BUILDER



Apple and the Apple logo are trademarks of Apple Inc., registered in the U.S. and other countries and regions. App Store is a service mark of Apple Inc. Google Play and the Google Play logo are trademarks of Google LLC. Tencent and the Tencent logo are trademarks of Tencent Inc.

[LEGO.com/devicecheck](https://www.lego.com/devicecheck)

EN Ask parents' permission before going online | DE Eltern um Erlaubnis bitten, bevor du online gehst | FR Demande l'autorisation d'un parent avant d'aller en ligne | IT Chiedi il permesso ai tuoi genitori prima di andare online | ES Pídeles permiso a tus papás antes de conectarte a Internet | PT Pede autorização aos pais antes de acederes online | ZH 上网前应先征得父母的同意 | PL Poproś rodziców o zgodę, zanim wejdiesz do Internetu | CS Než půjdeš na internet, požádej rodiče o svolení | SK Skôr než pôjdeš na internet, vypýtaj si povolenie od rodičov | HU Kérj szülői engedélyt, mielőtt online csatlakoznál! | RO Cere permisiunea părinților înainte de a te conecta online | BG Поискайте разрешение от родител, преди да влезете онлайн | LV Pirms došanās tiešsaistē palūdz atļauju vecākiem | ET Enne Interneti kasutamist küsi vanematelt luba | LT Prieš prisijungdami prie interneto, atsklauskite tėvų

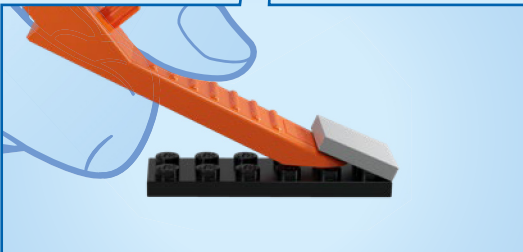
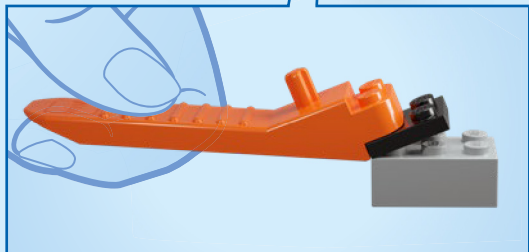
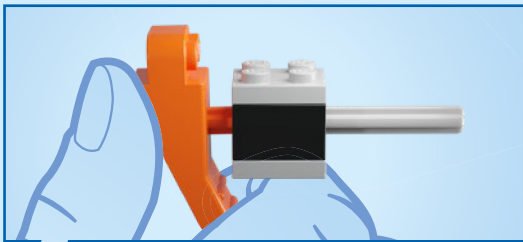
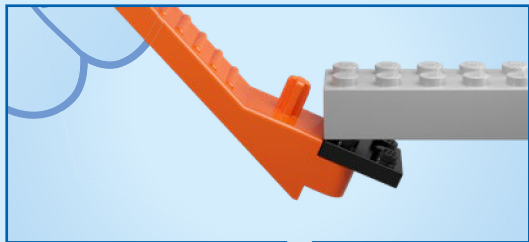

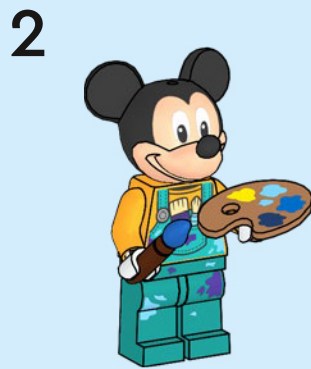
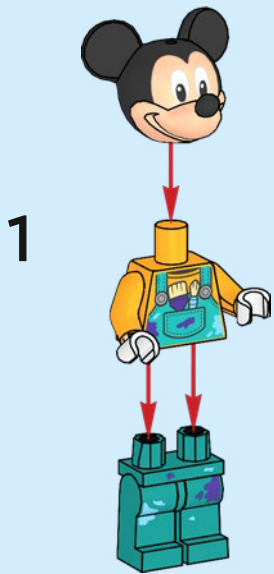

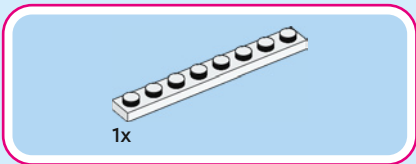
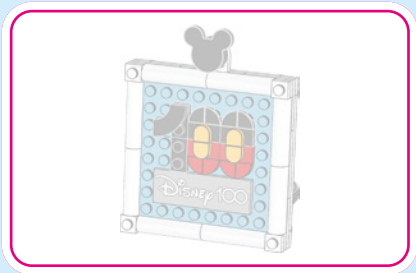

1

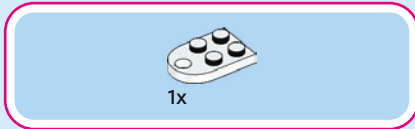
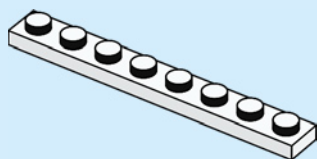

2

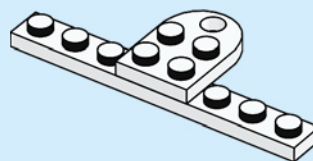



3

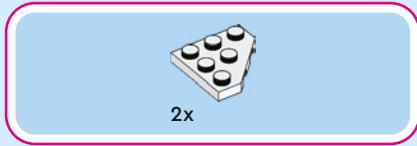
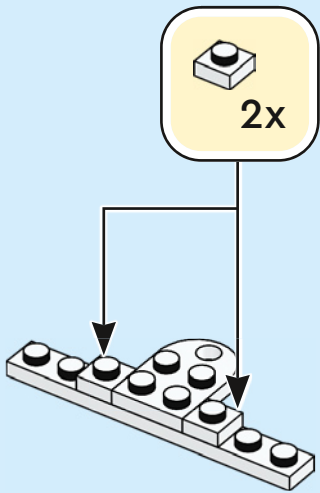

4

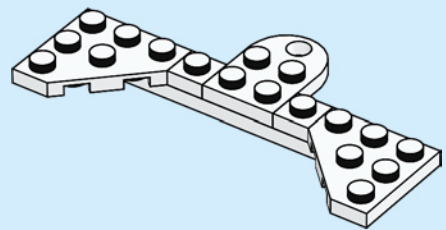



5

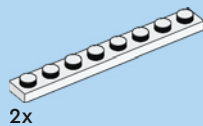
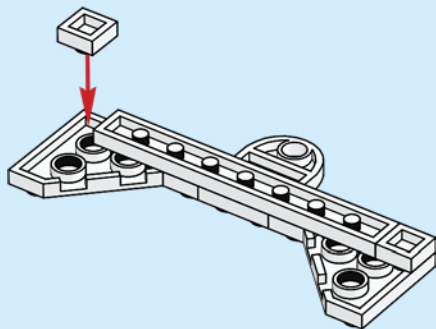

6

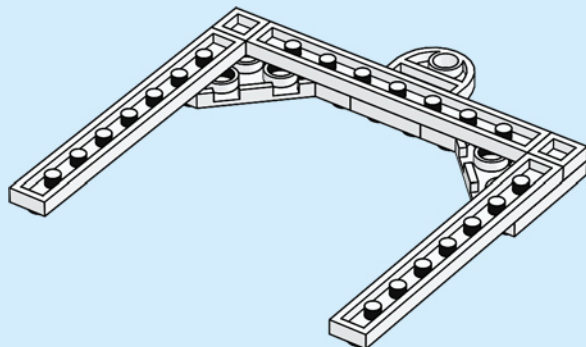

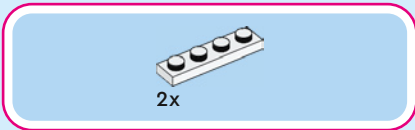

7

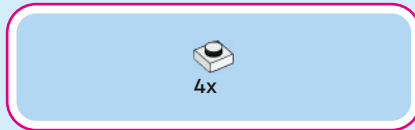
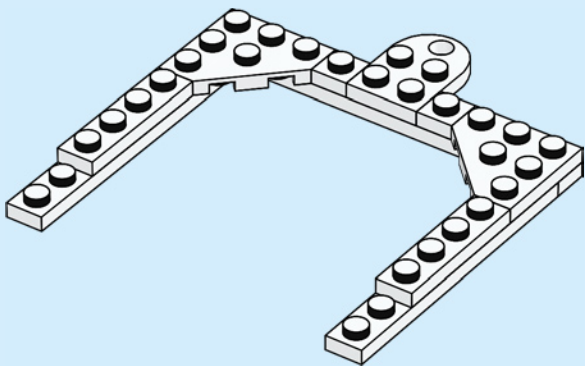

8

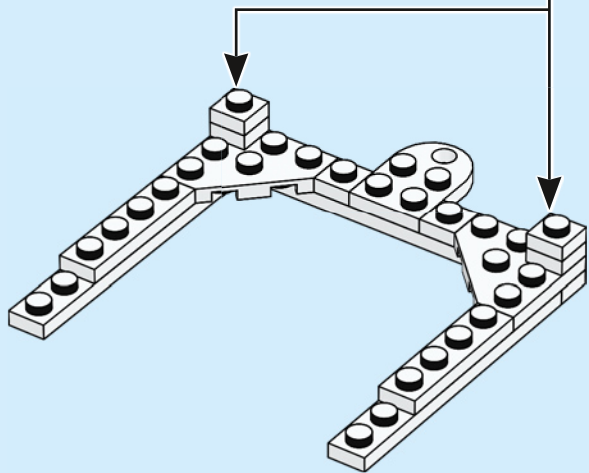
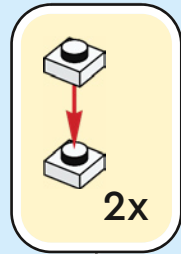

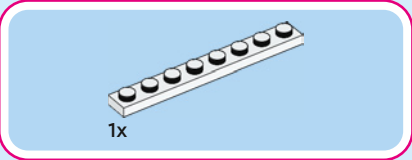
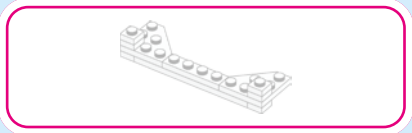

9

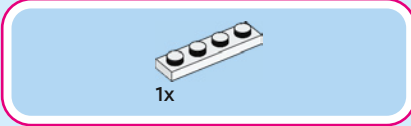
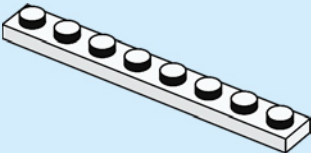

10

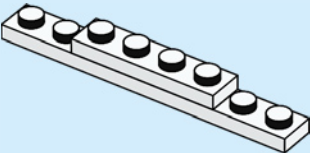



2x

11

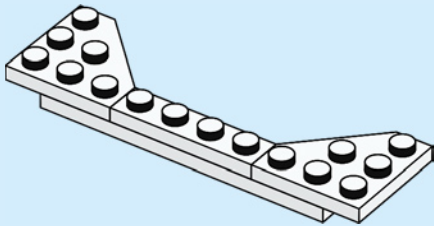

2x

12

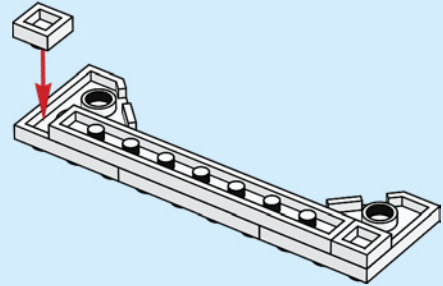
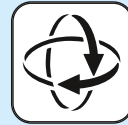

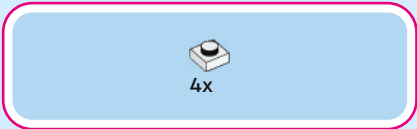

13

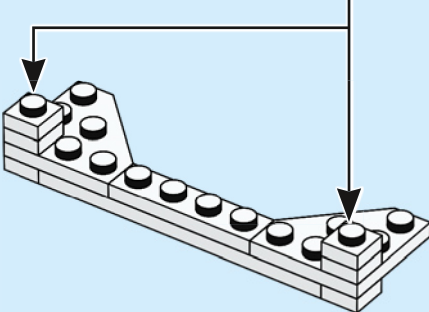
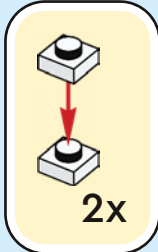

14

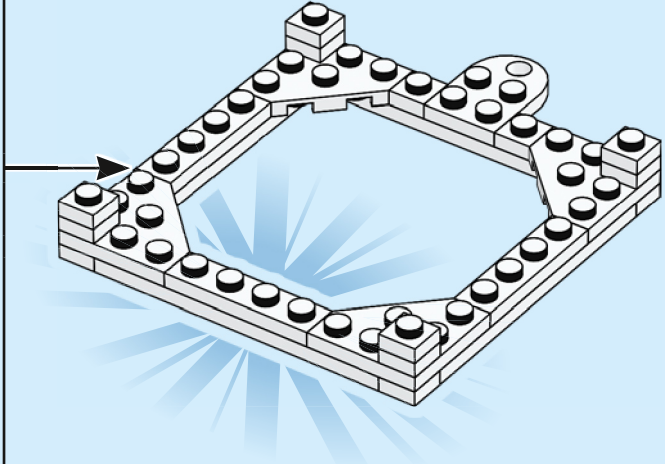

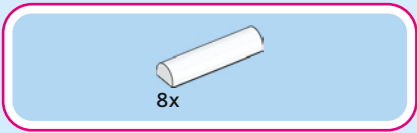

15

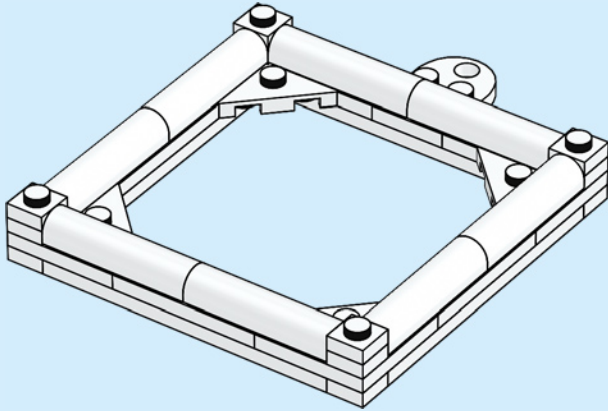

16

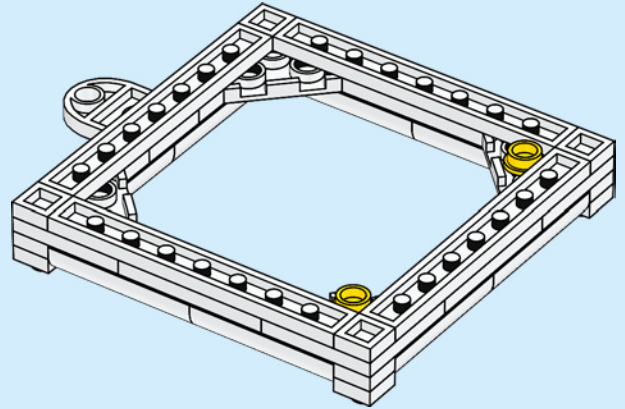
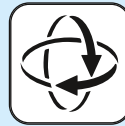

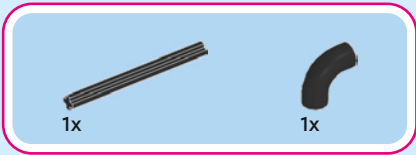
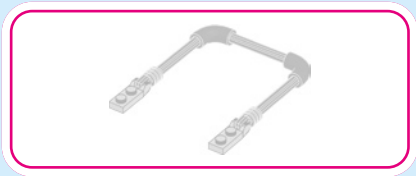

17

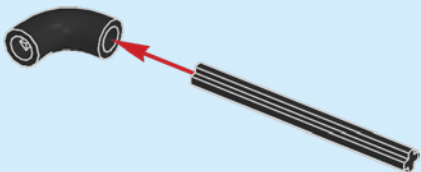

18



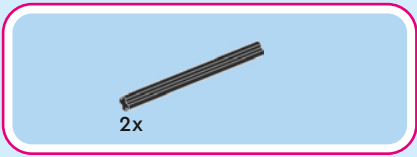

19

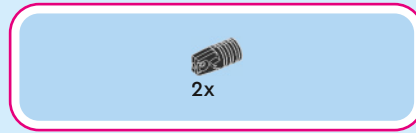
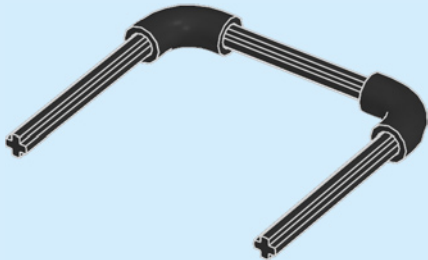

20

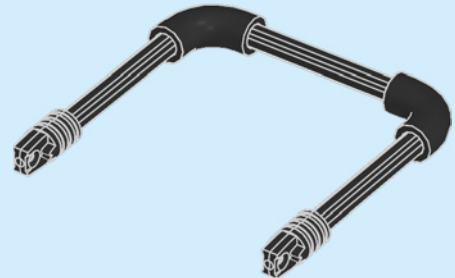



2x

21

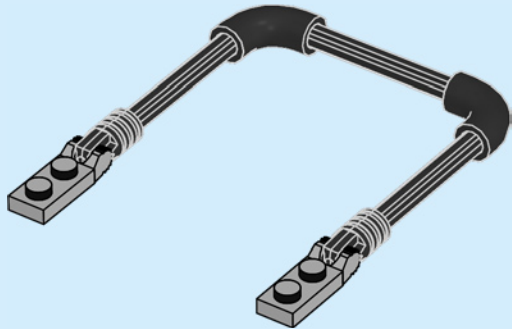

22

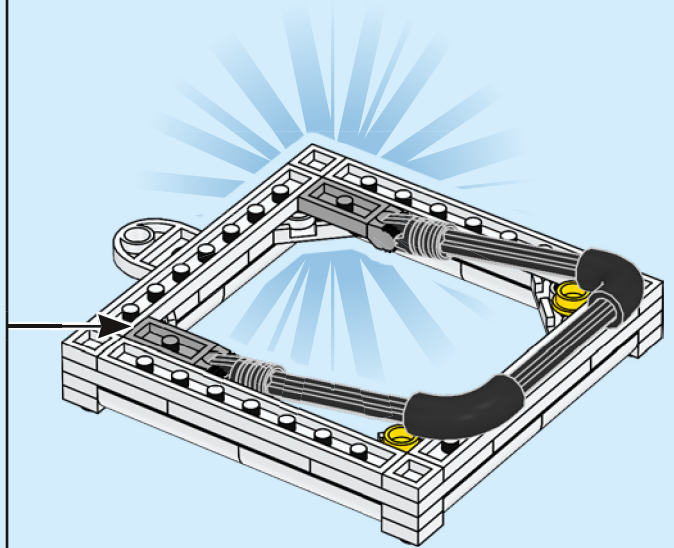



4x

23

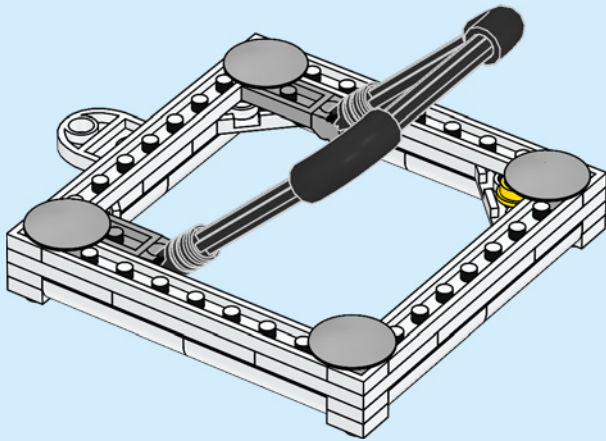

1x

24

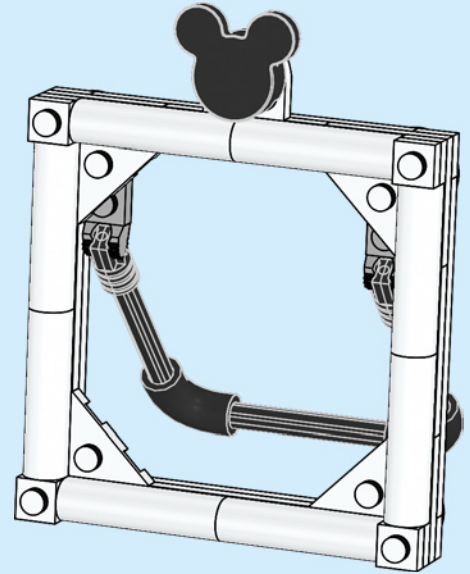

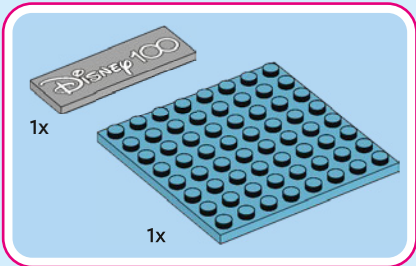
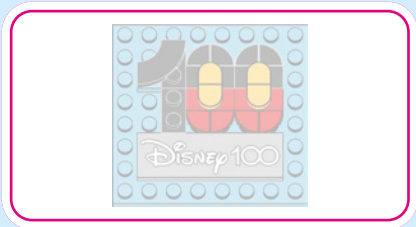

25

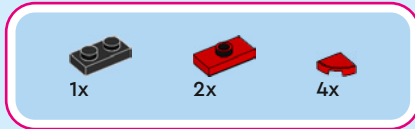
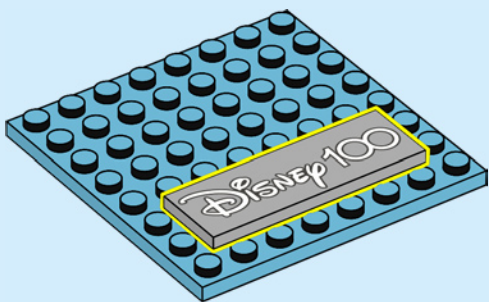

26

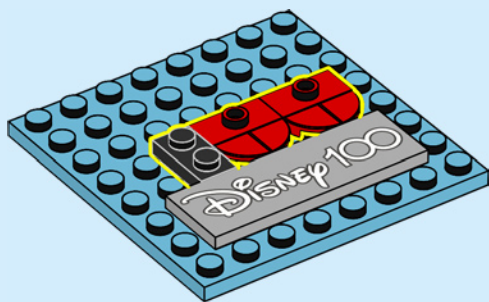

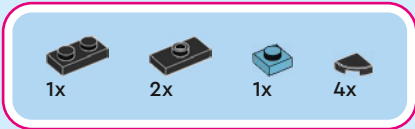

27

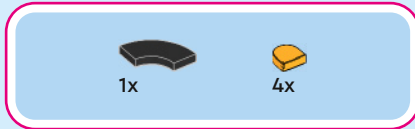
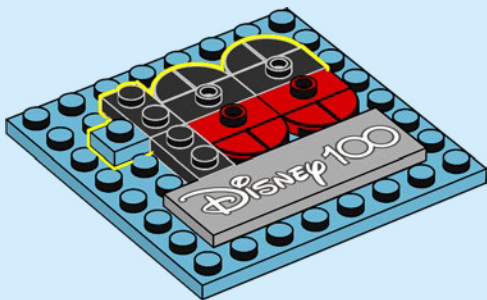

28

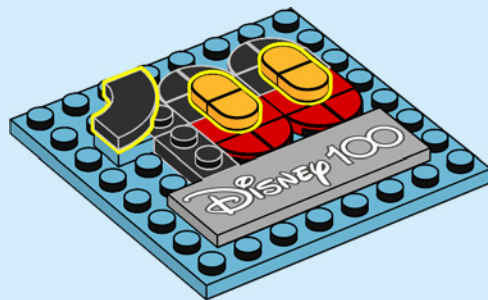

29

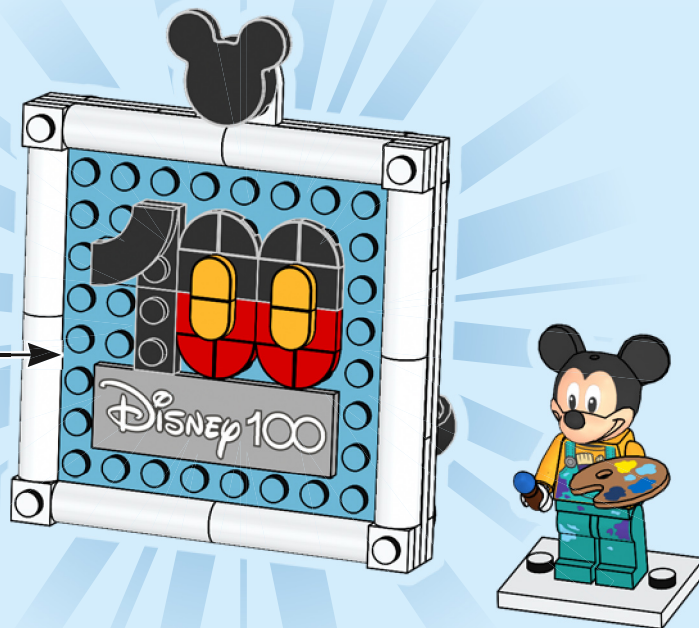



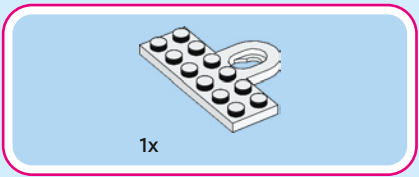
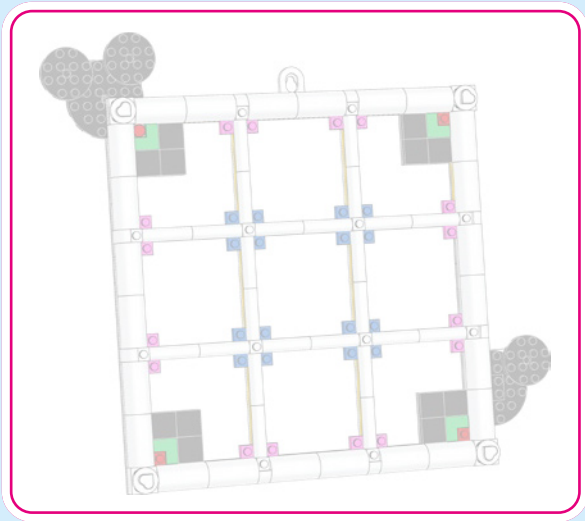

1

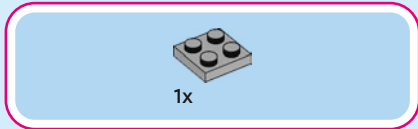
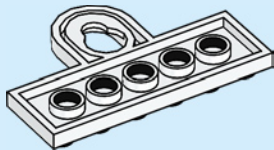

2

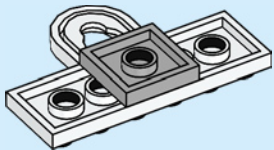

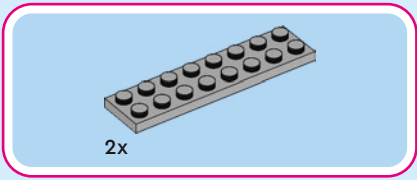

3

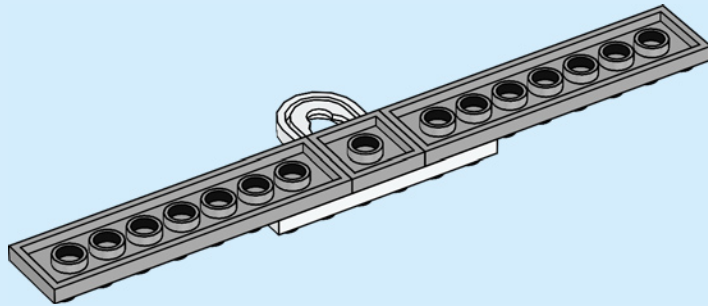



2x

4

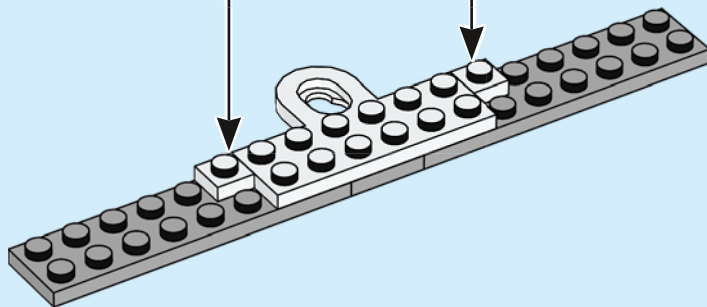
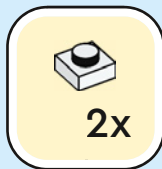

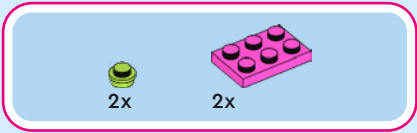

5

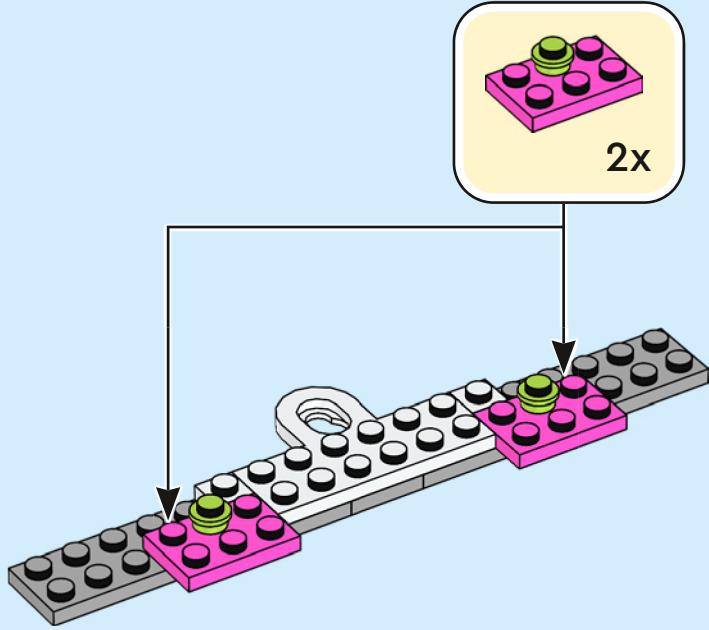

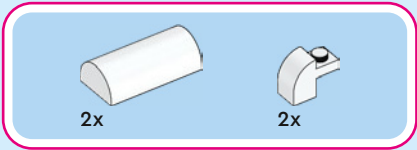

6

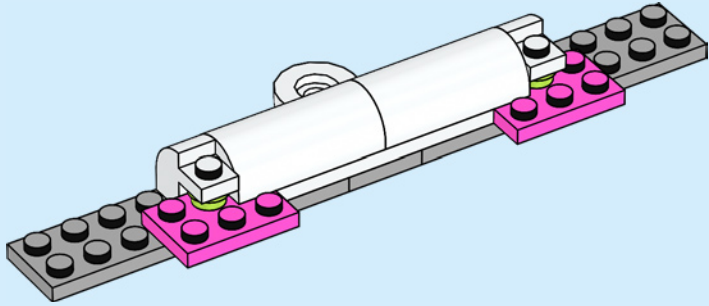

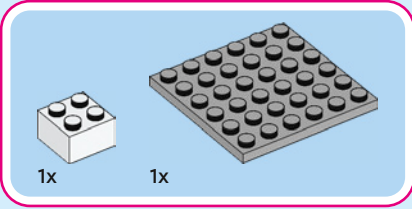
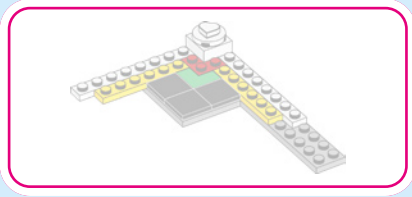

7

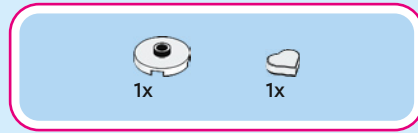
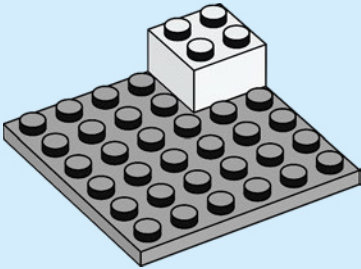

8

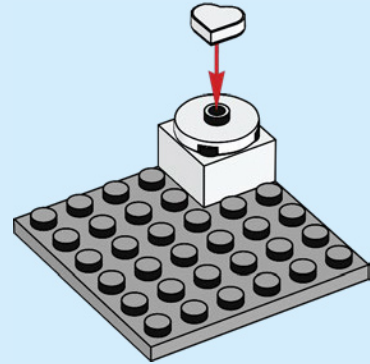

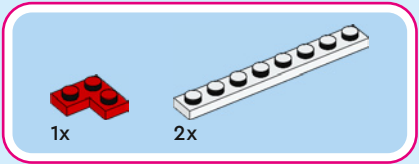

9

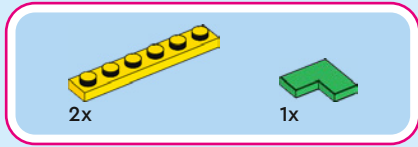
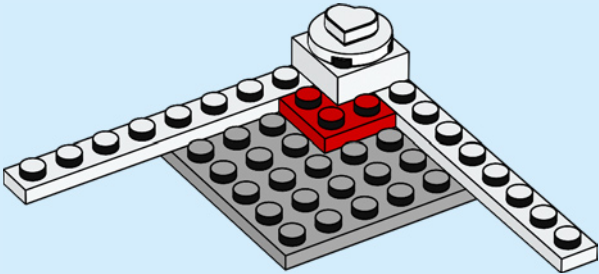

10

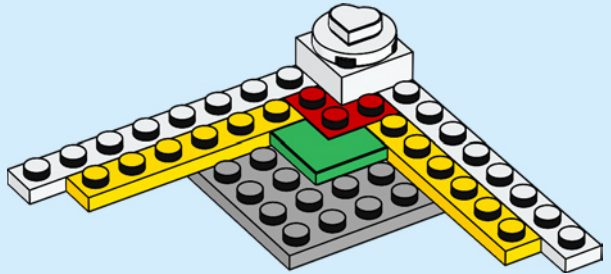

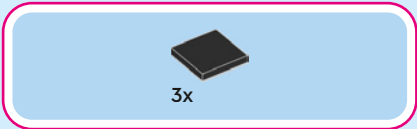

11

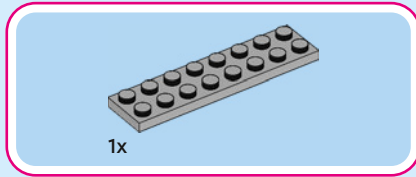
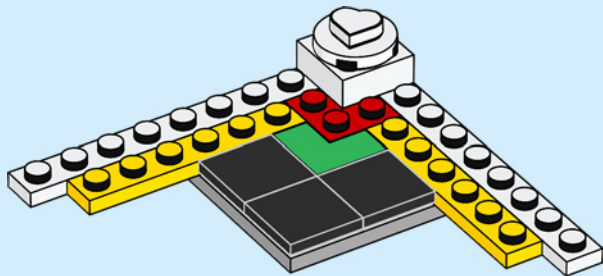

12

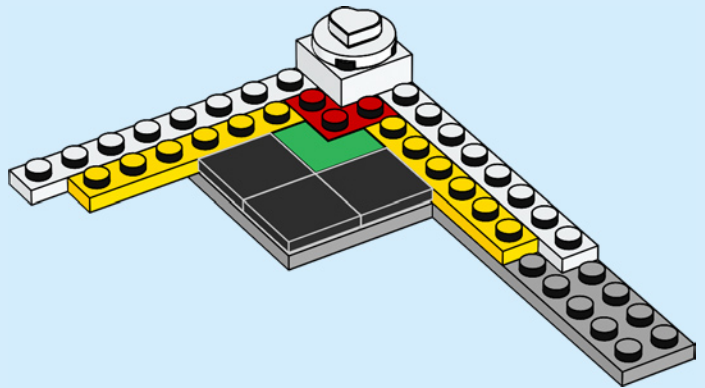

13

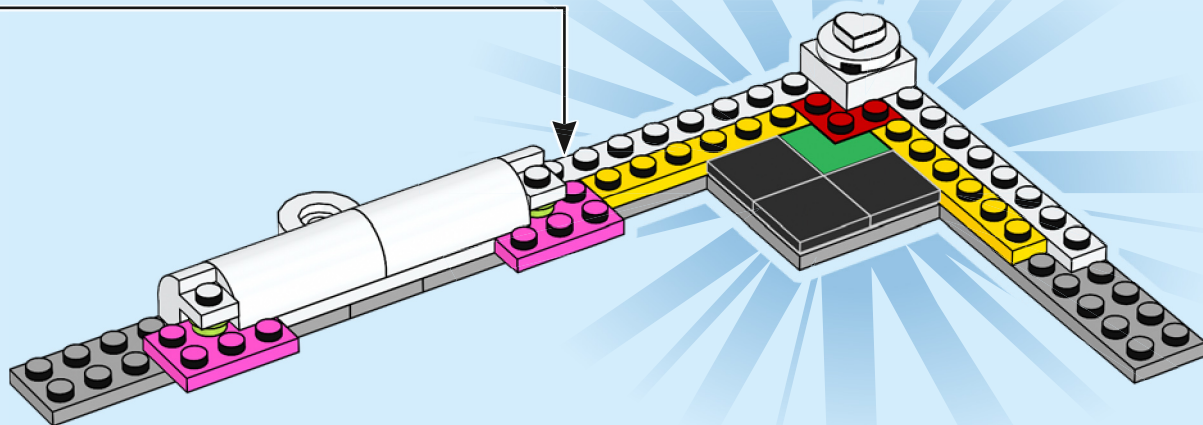

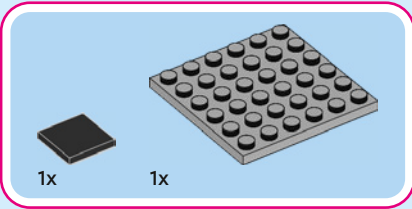
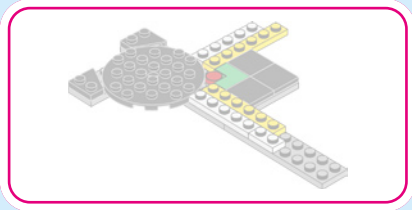

14

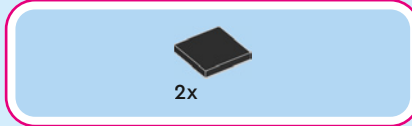
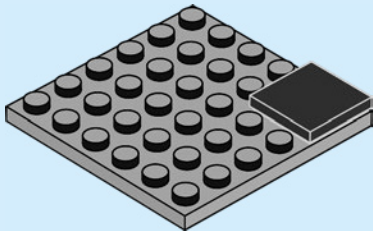

15

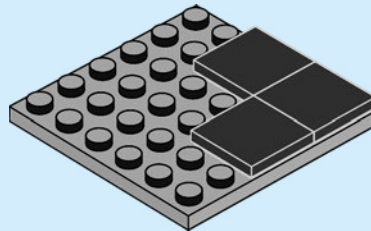

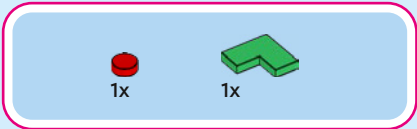

16

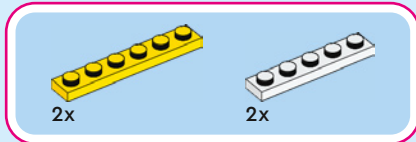
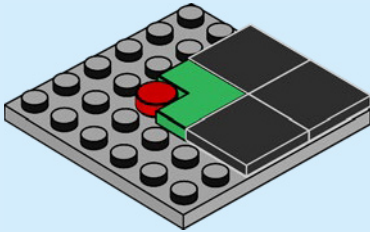

17

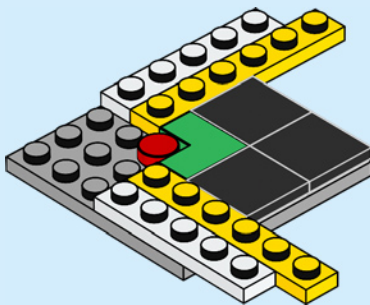

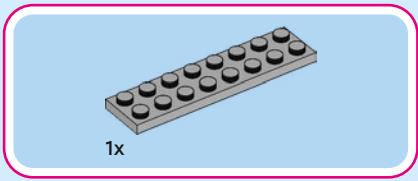

18

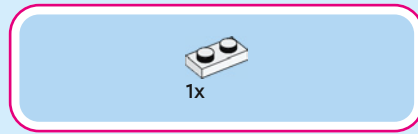
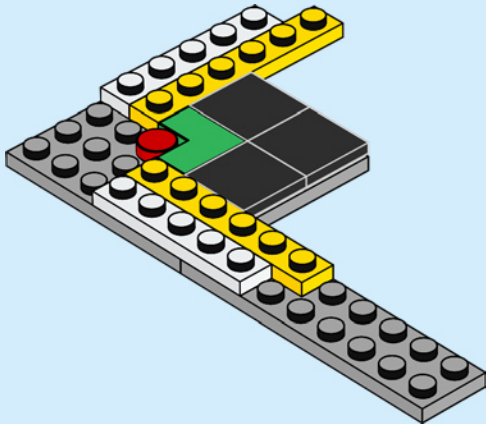

19

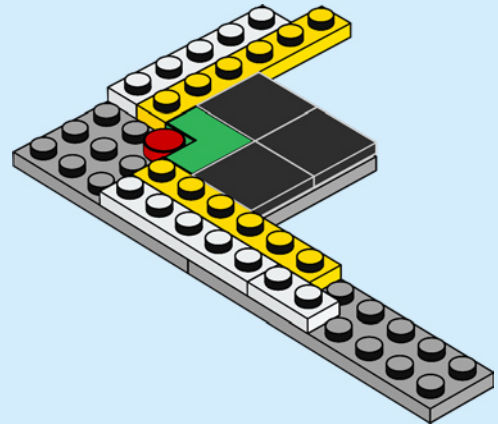

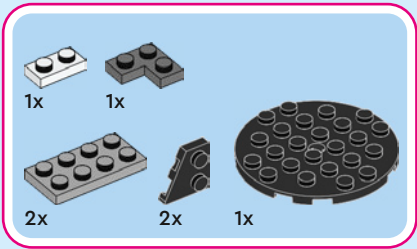

20

1

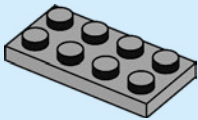

2

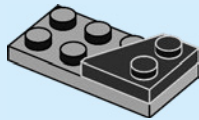

3

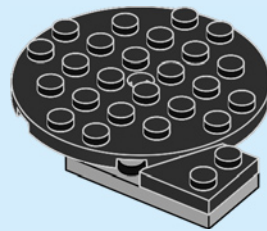

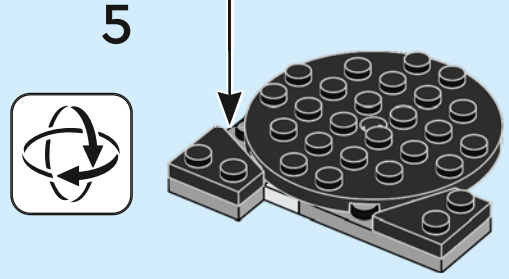
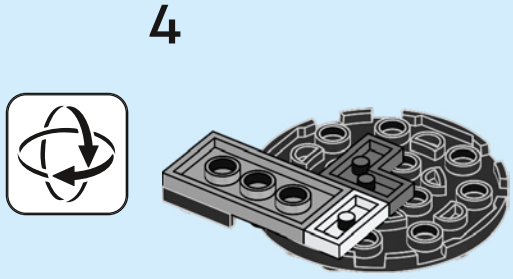
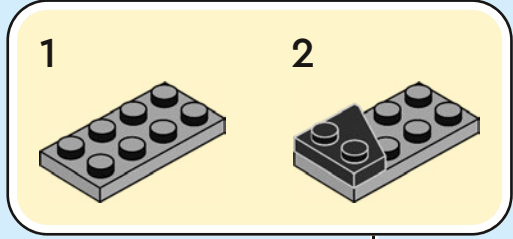

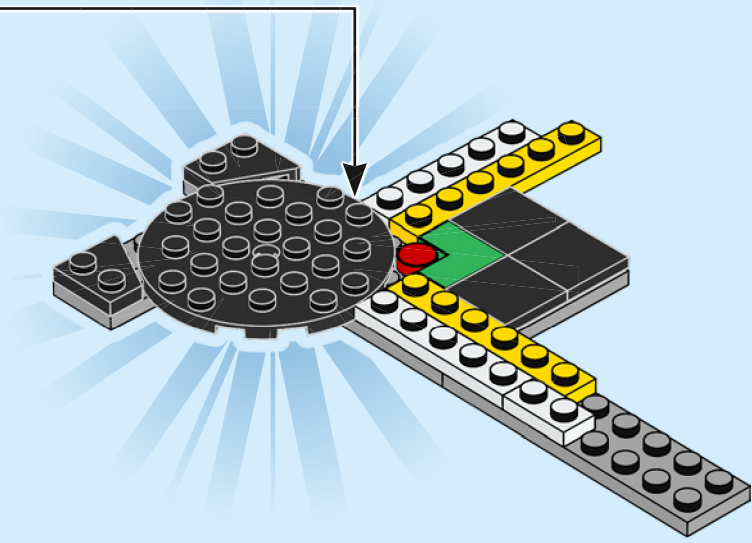

21

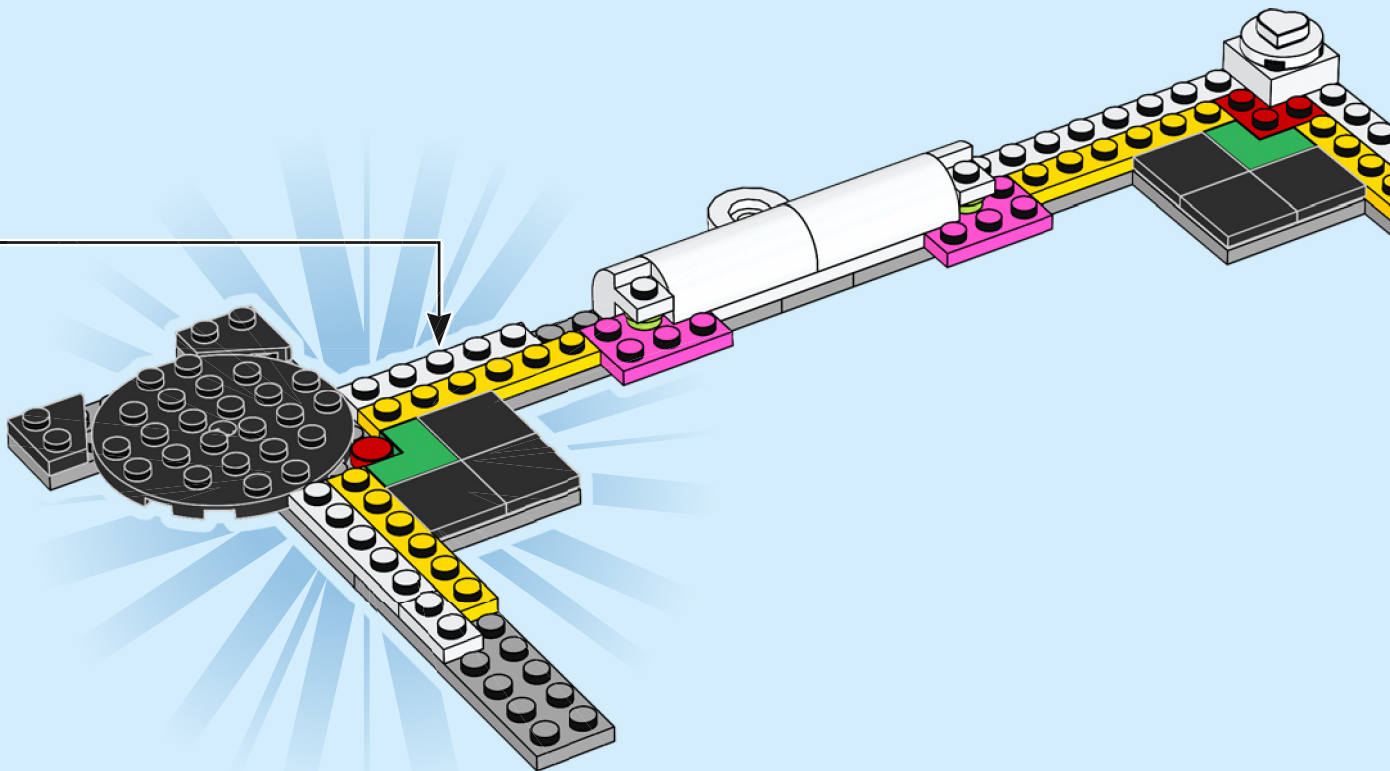



1x

22

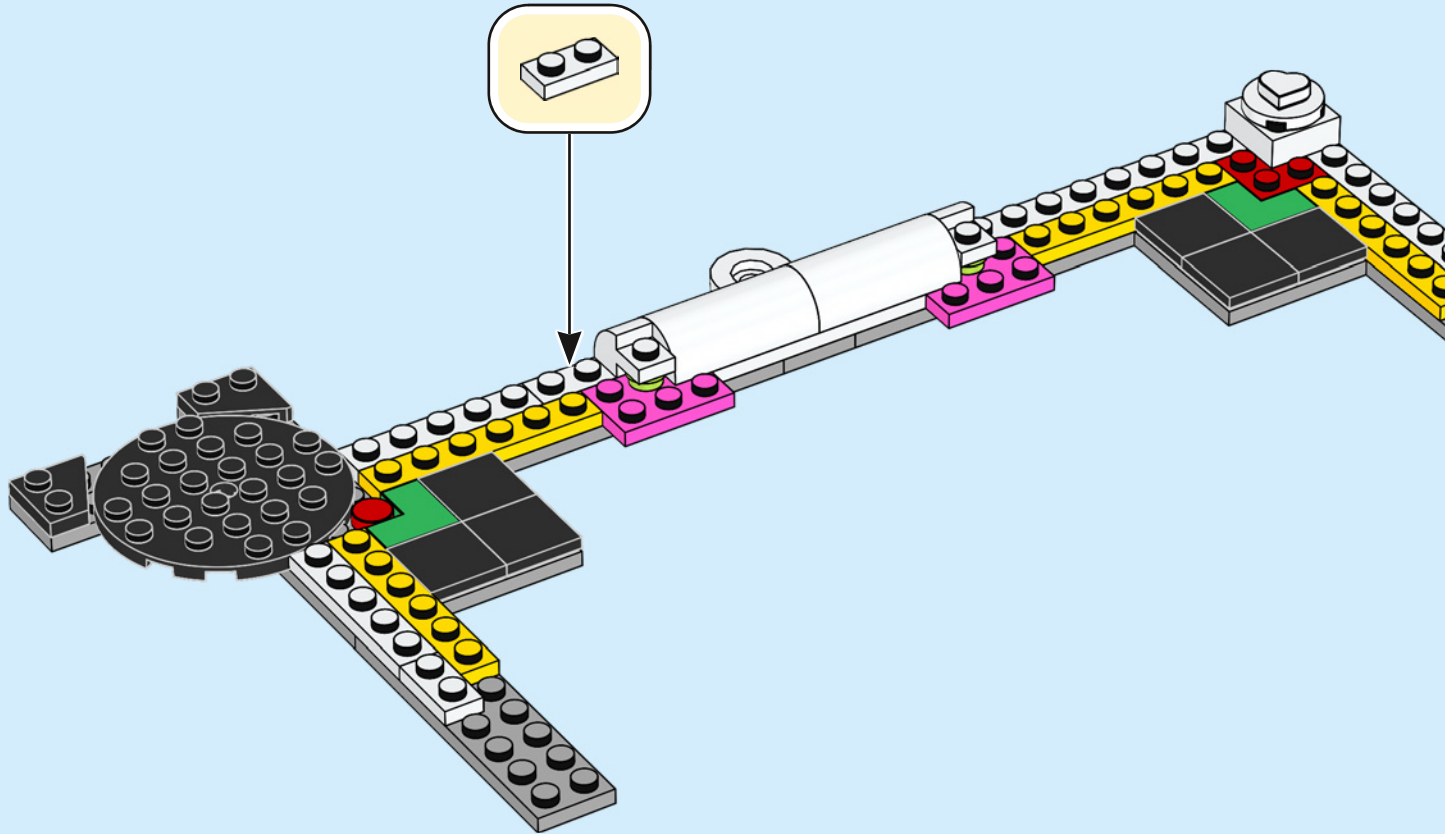

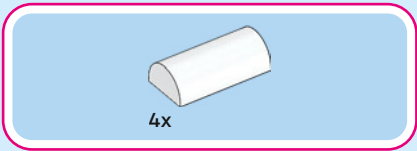

23

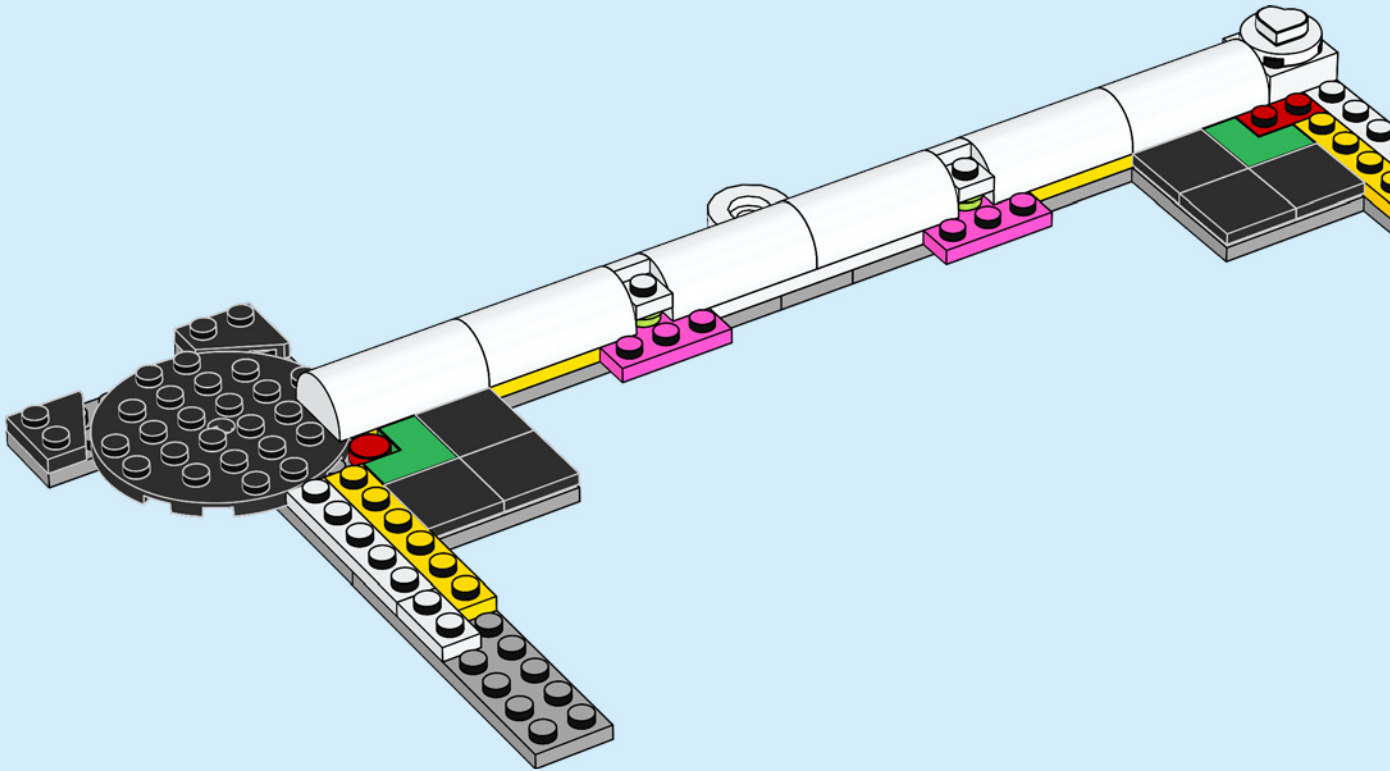

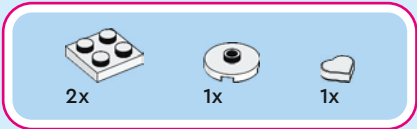

24

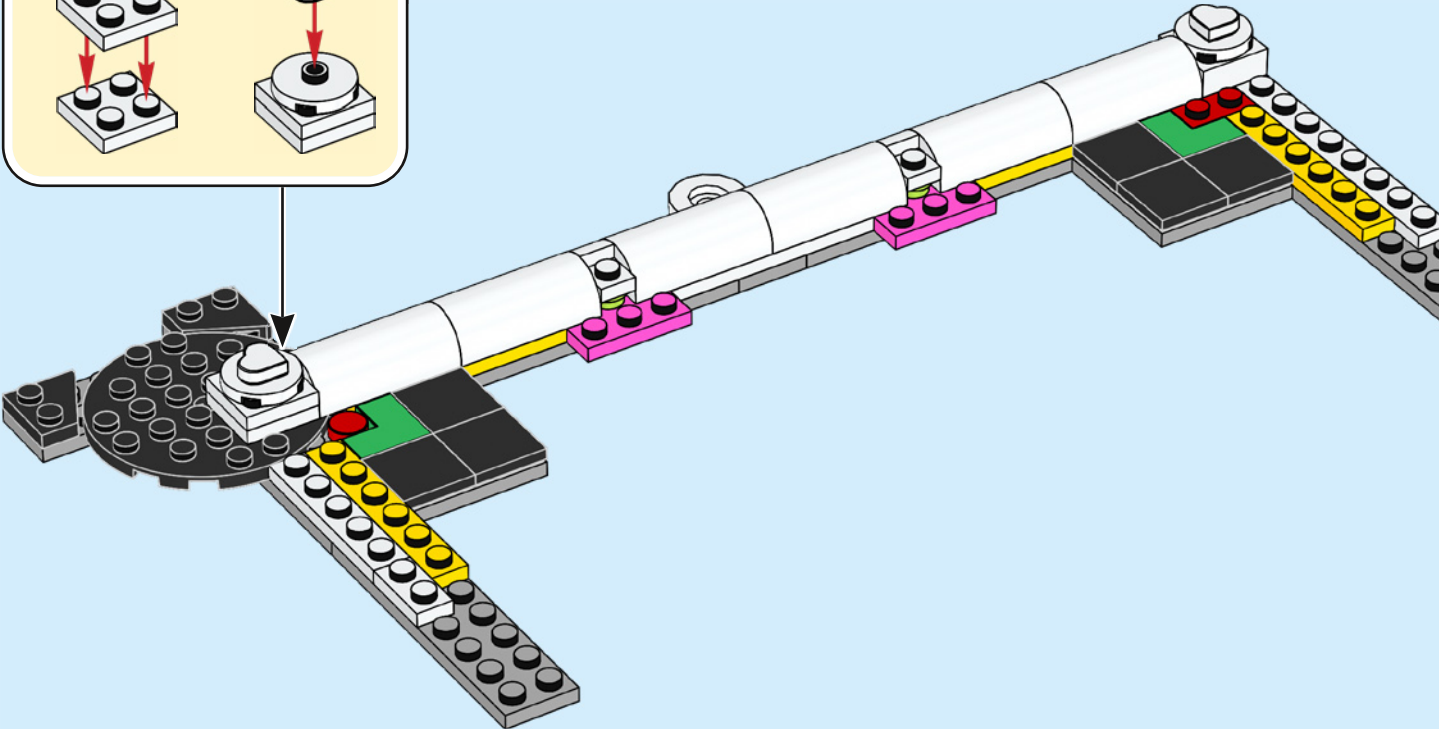
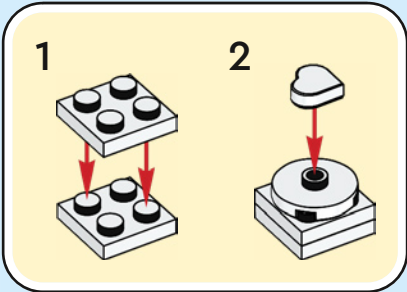

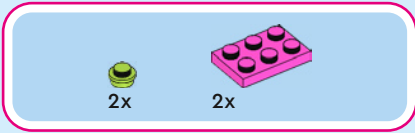

25

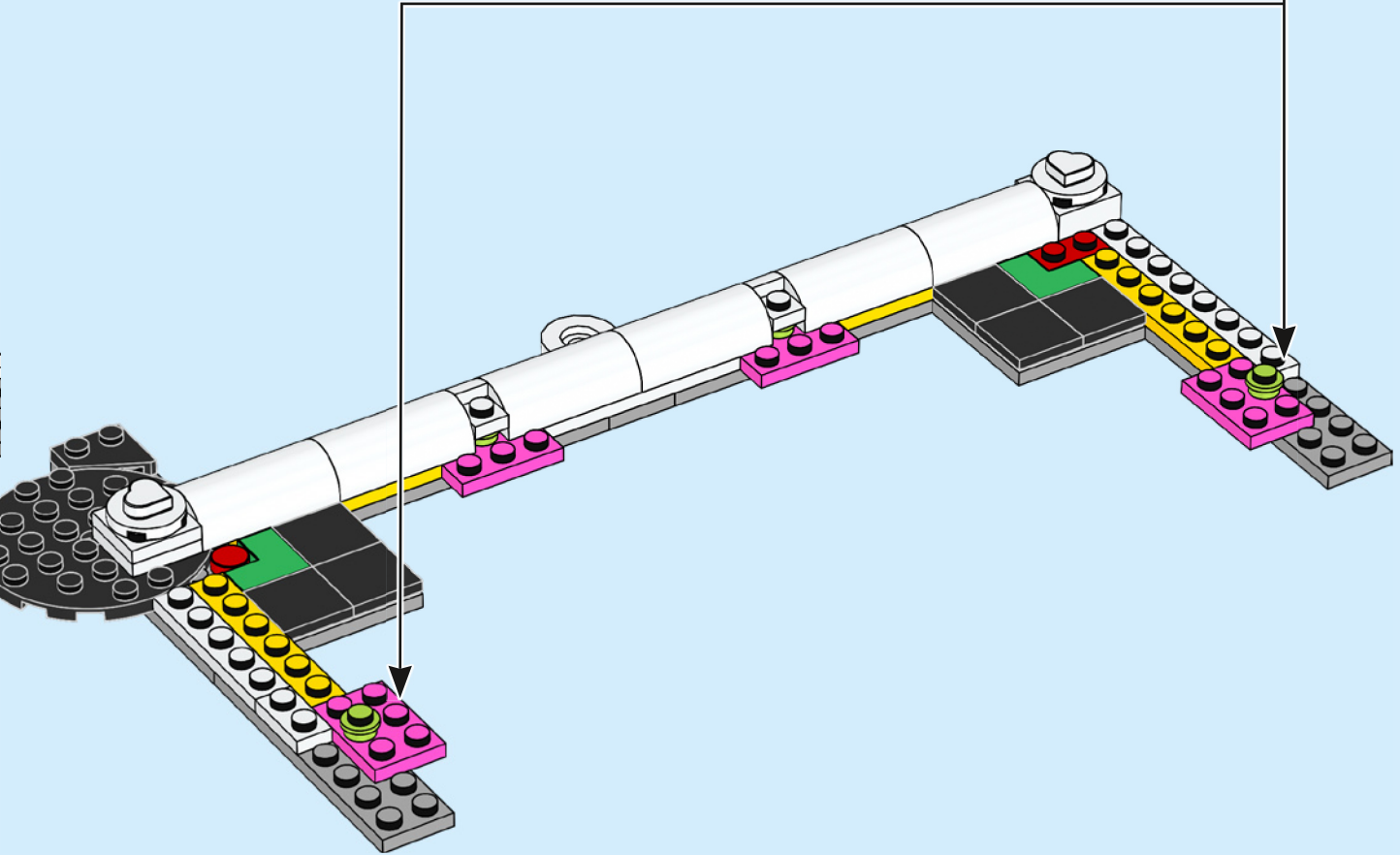
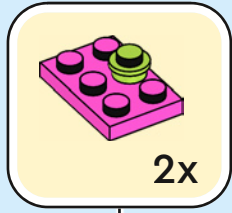

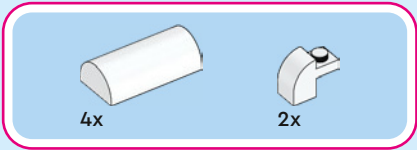

26

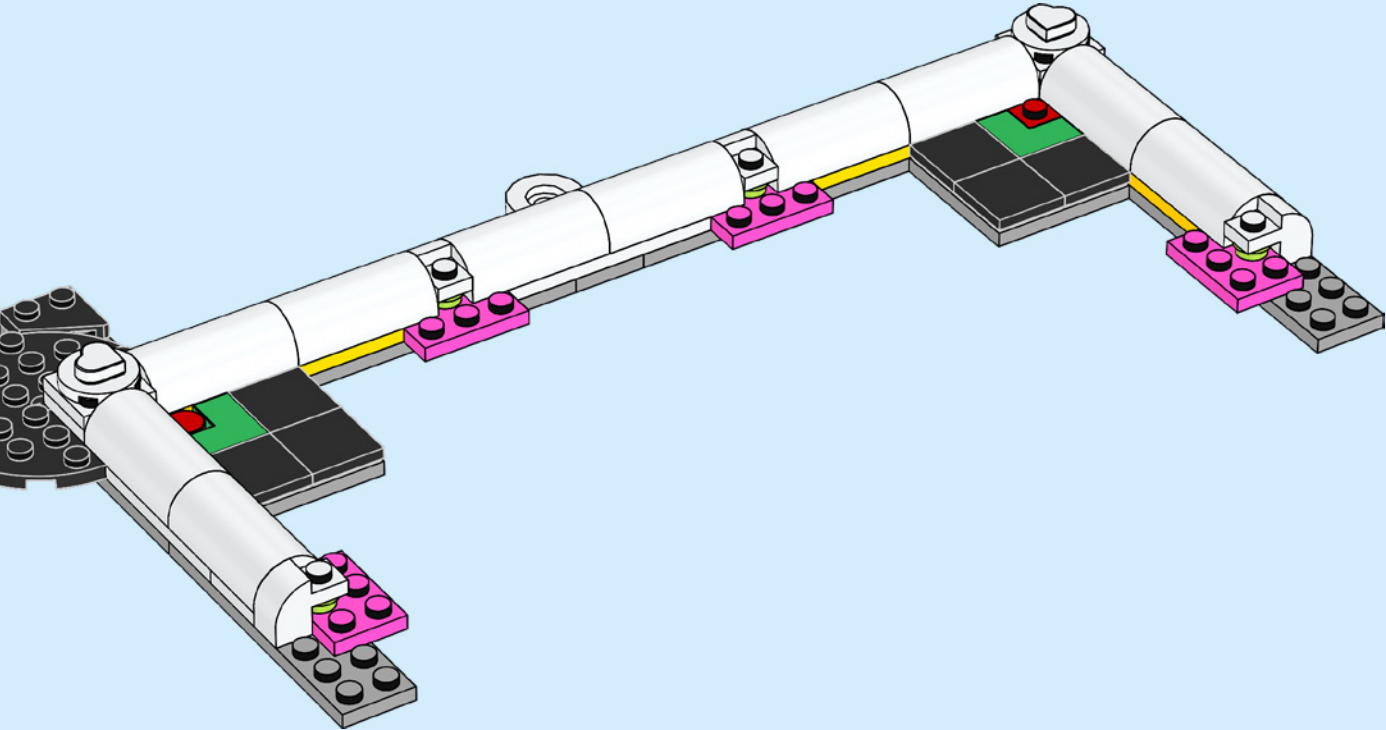



27



2x

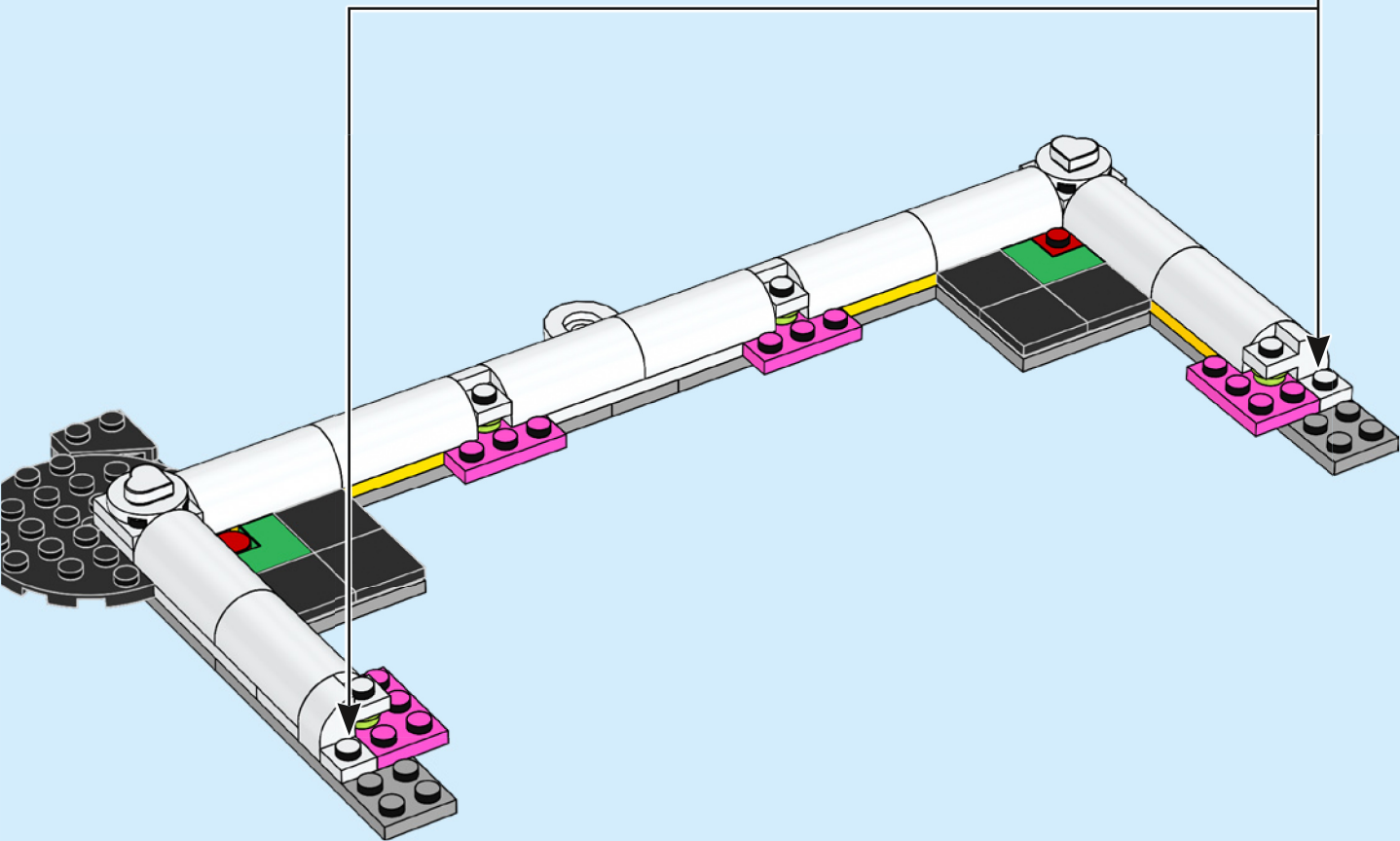

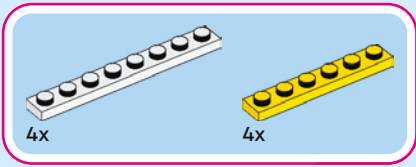

28

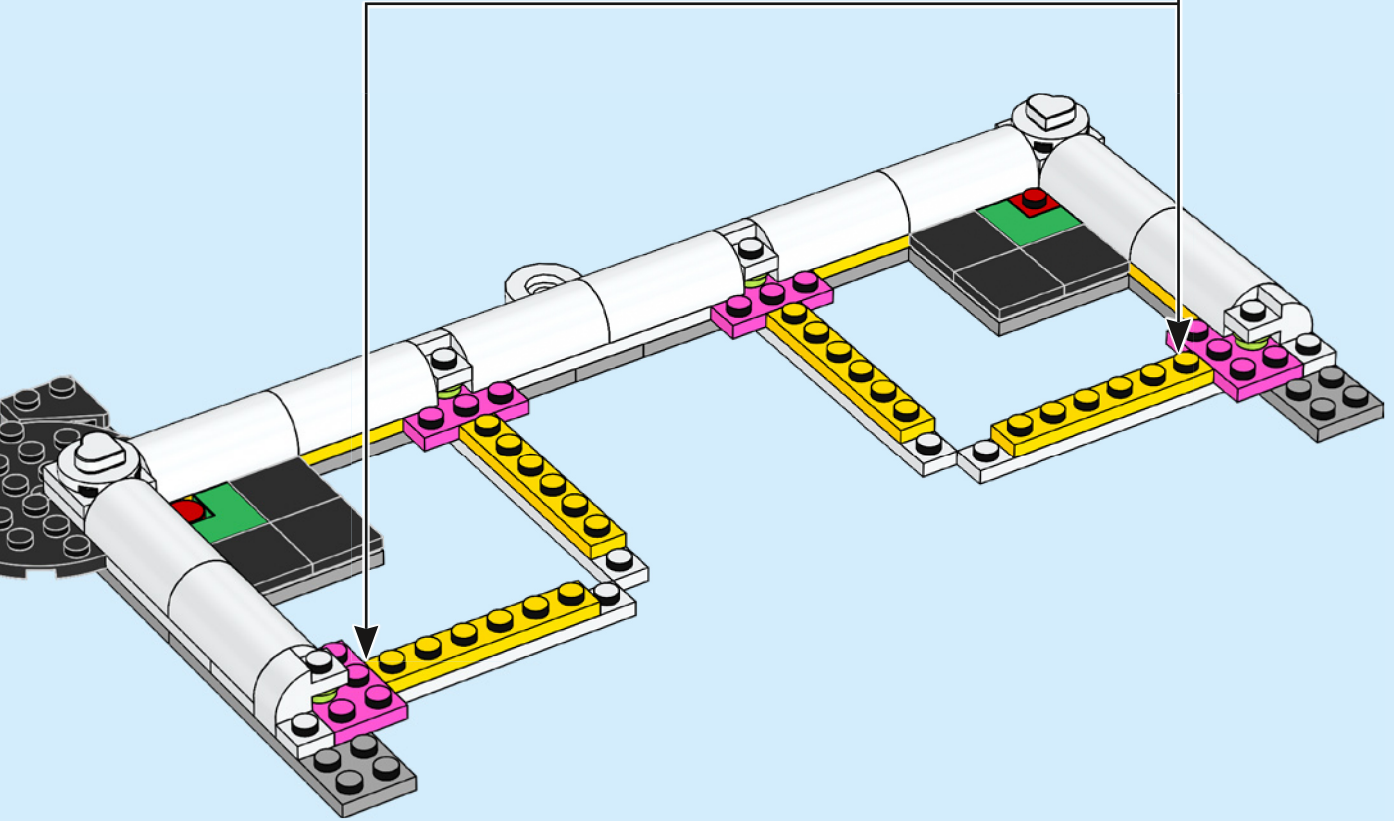
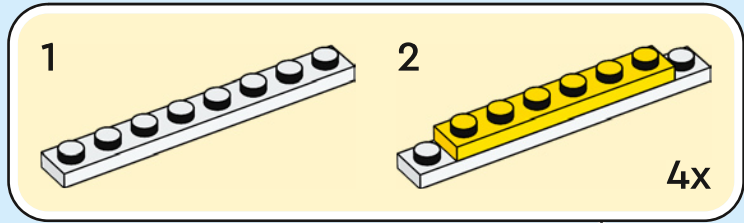

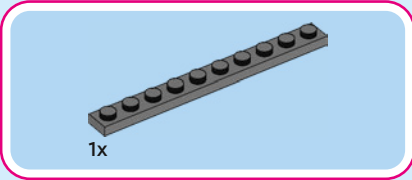
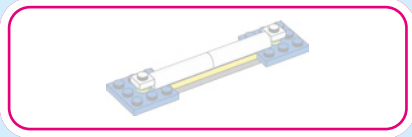

1x

29

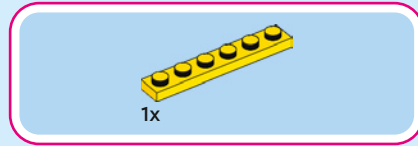
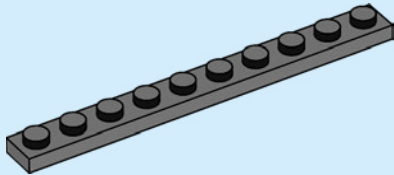

1x

30

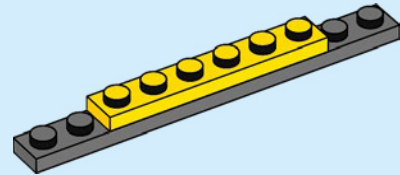

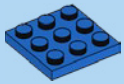

2x

31

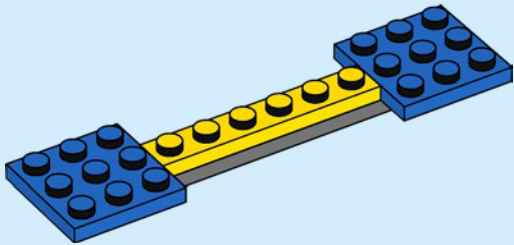

2x

32

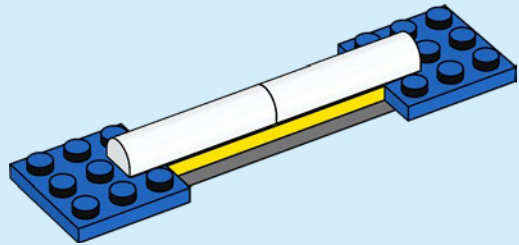



2x

33

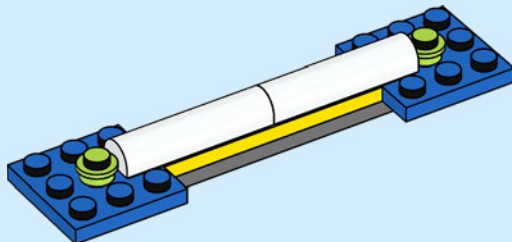

2x

34

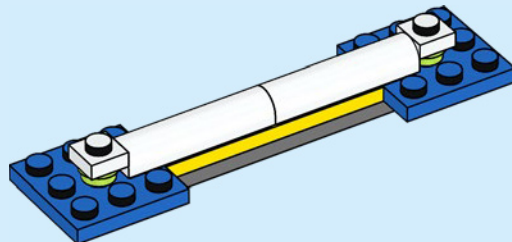

35

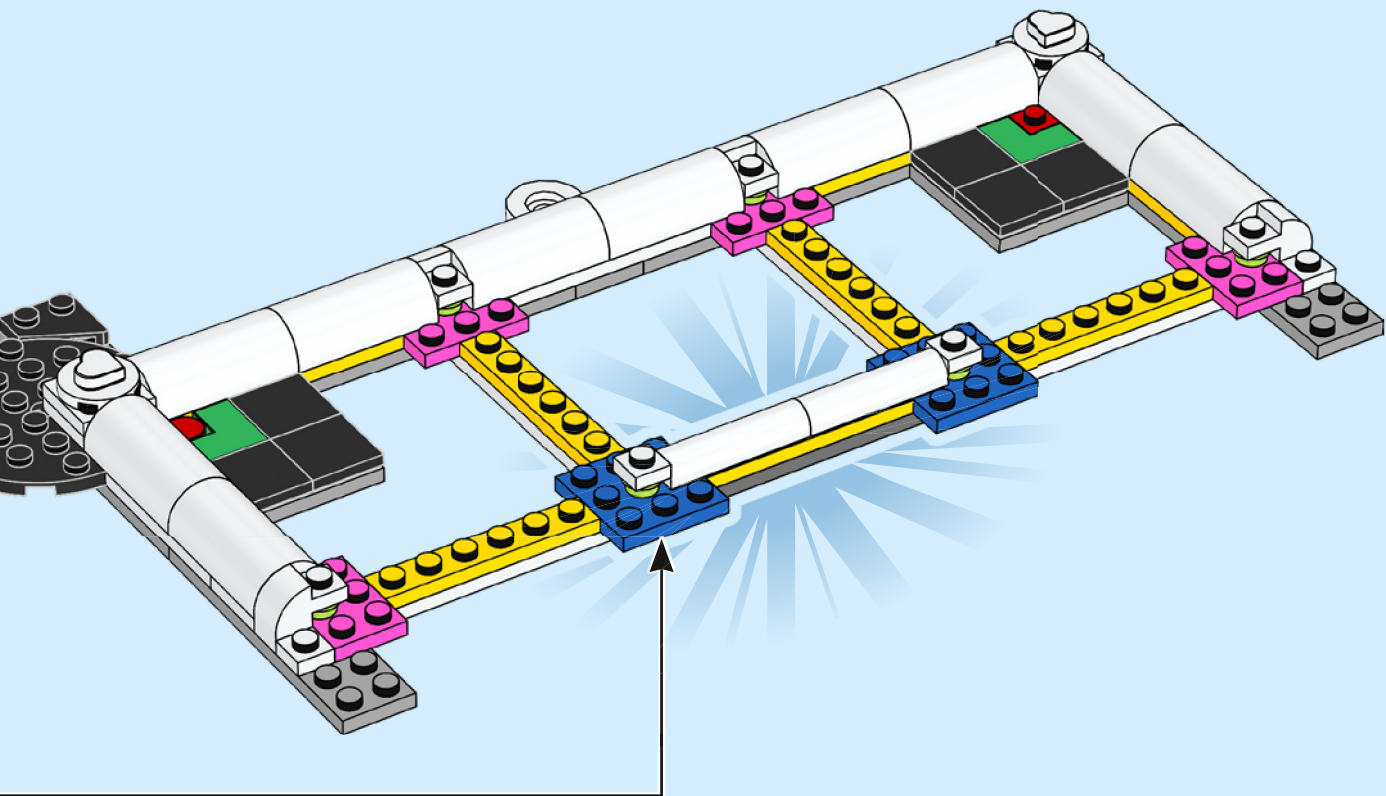

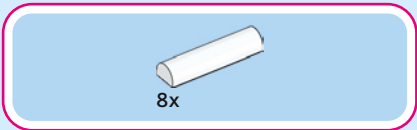

36

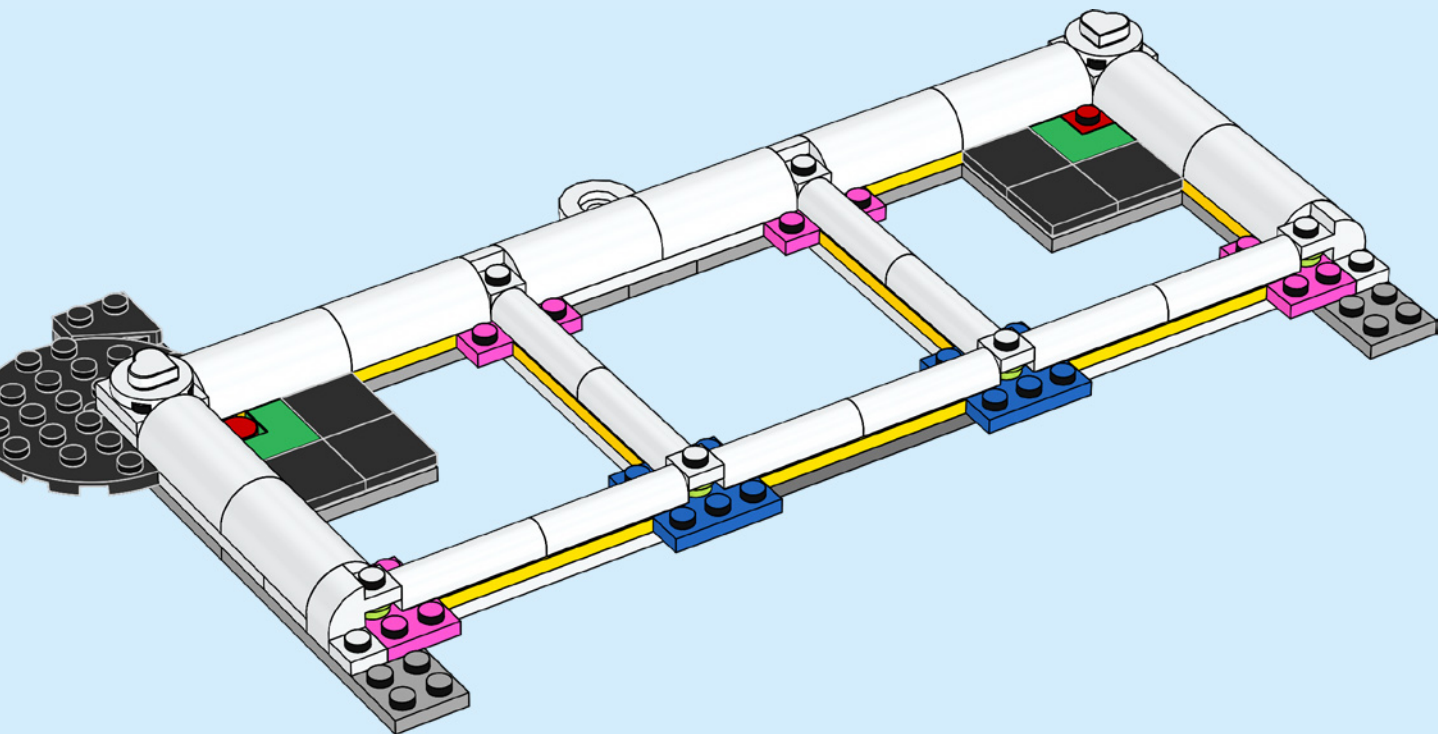

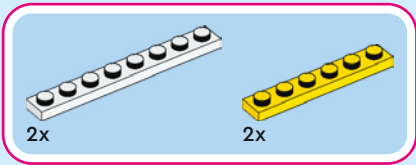

37

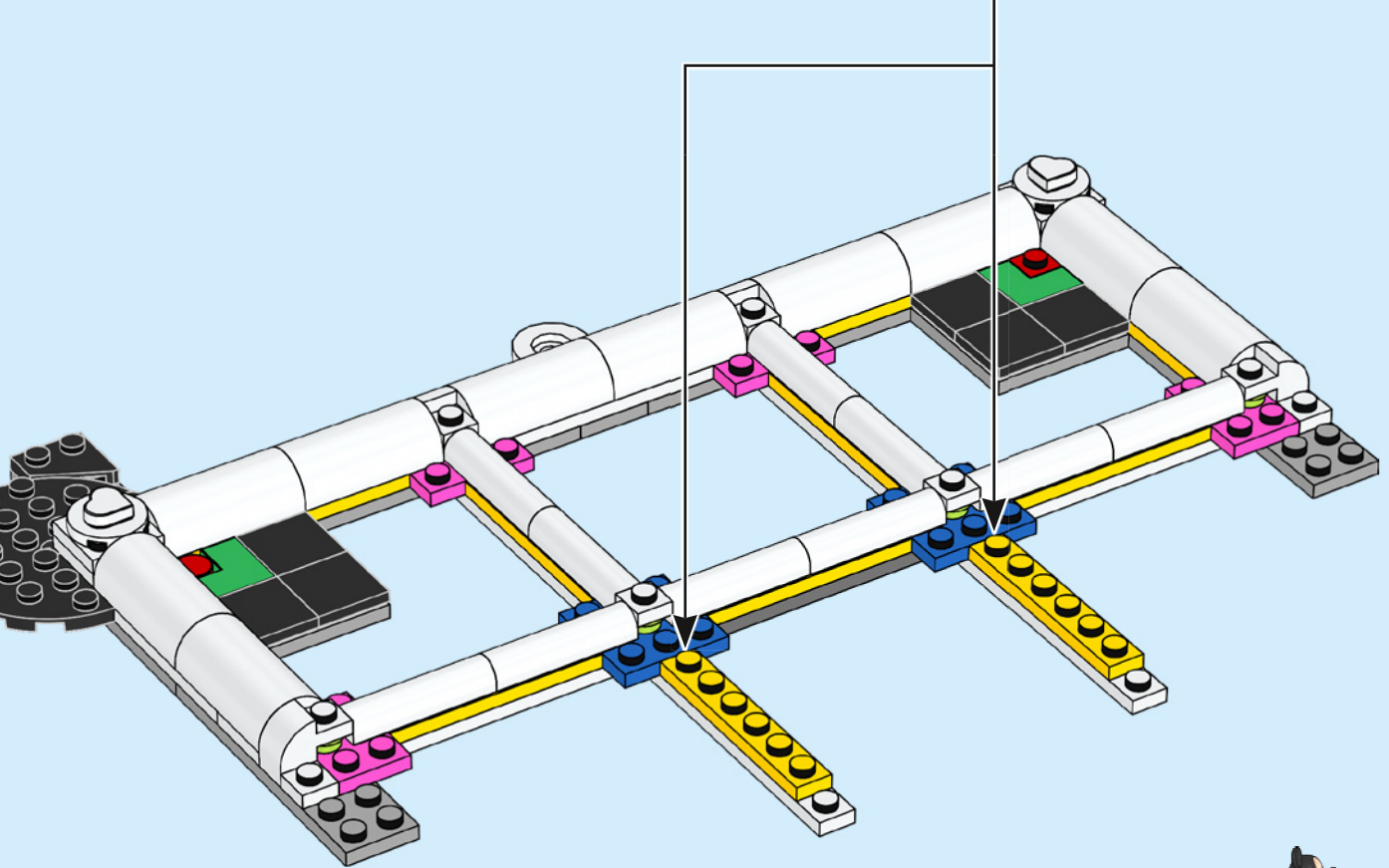
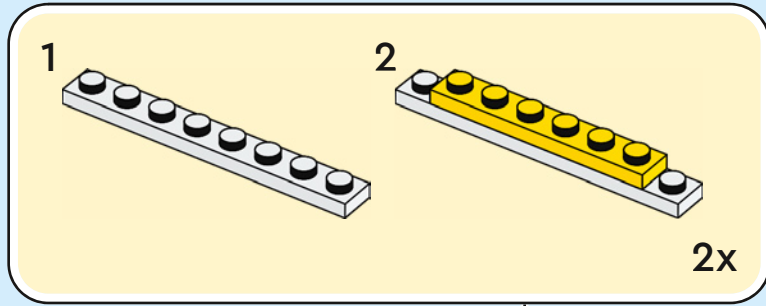

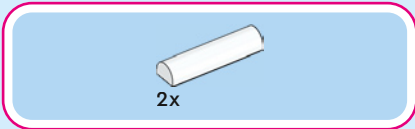

38

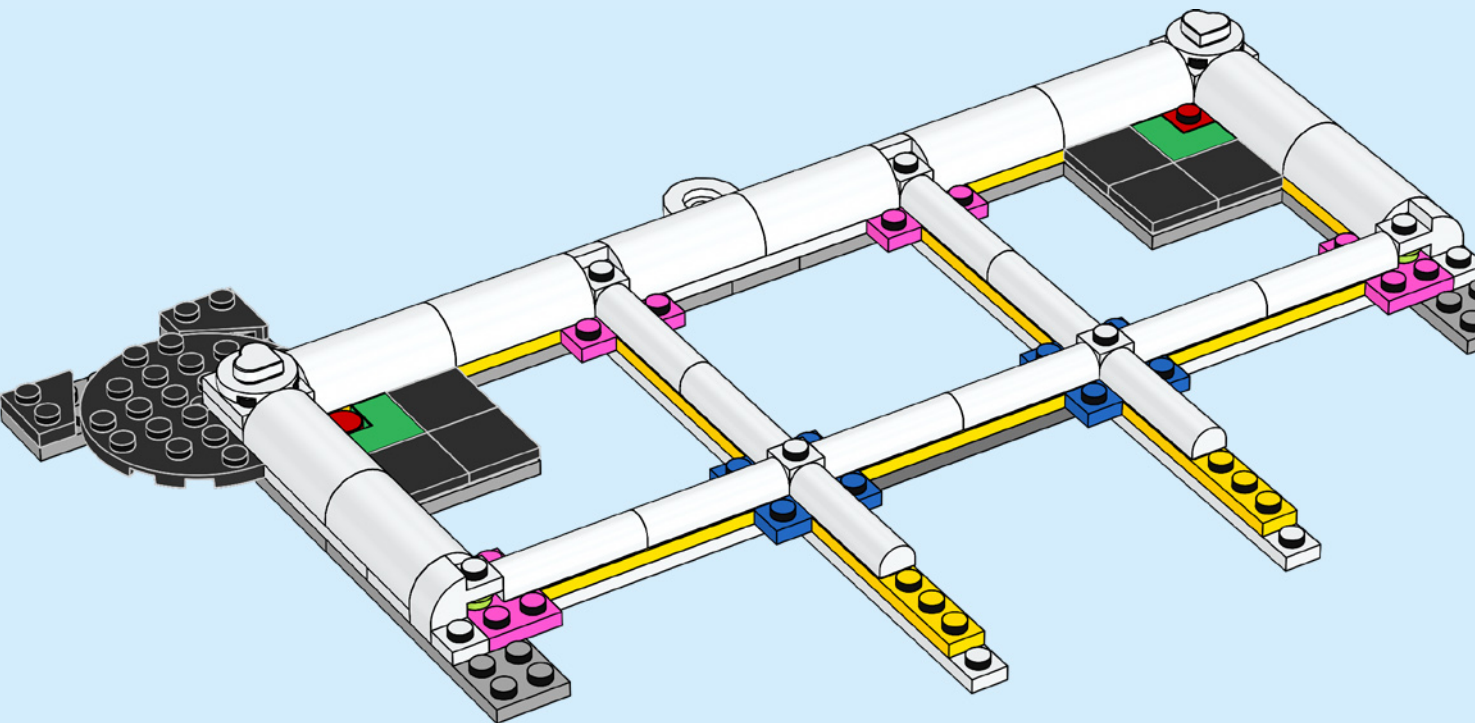

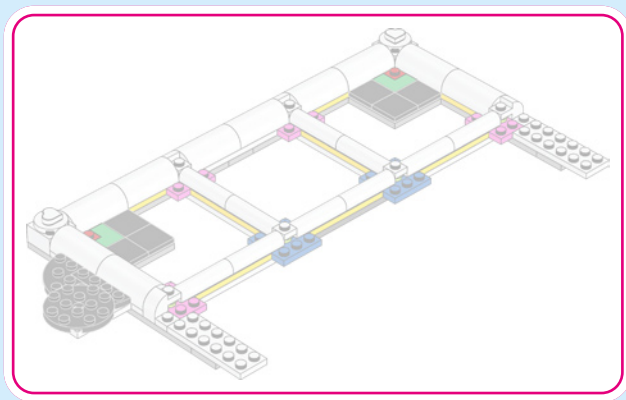

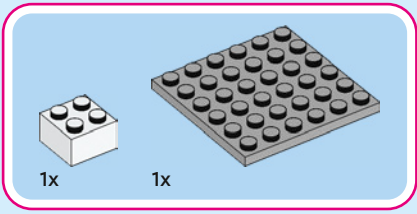

39

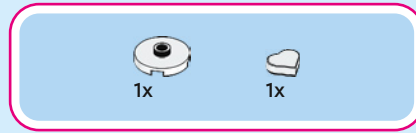
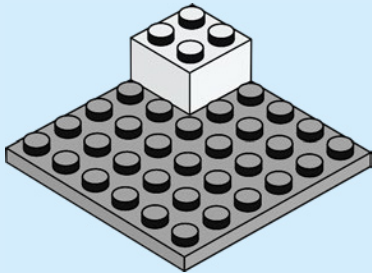

40

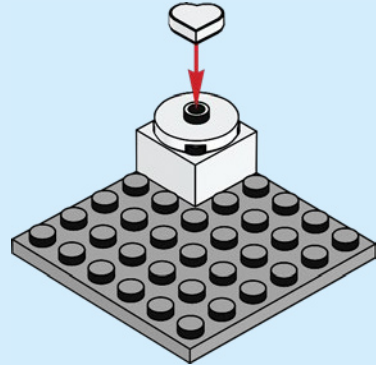

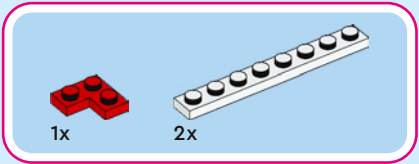

41

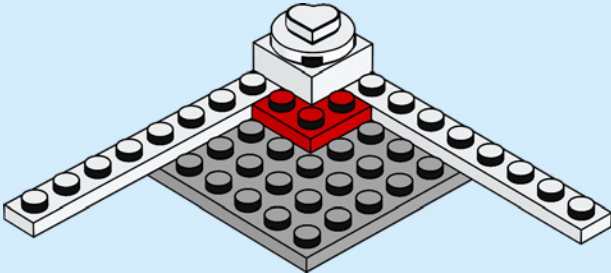

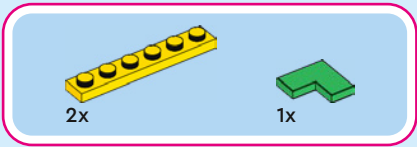

42

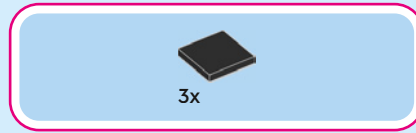
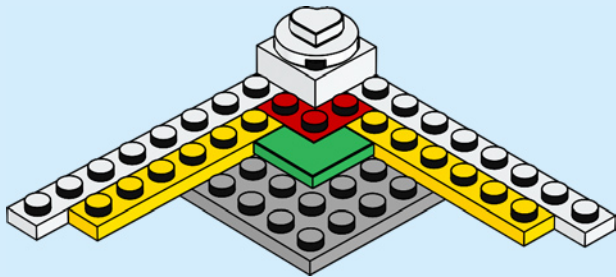

43

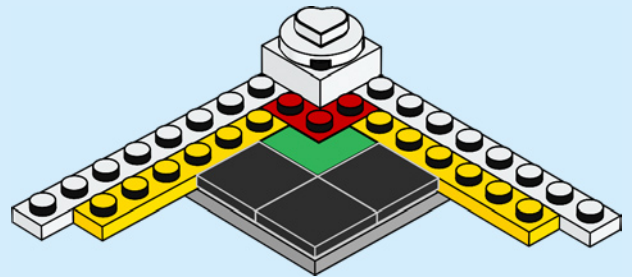

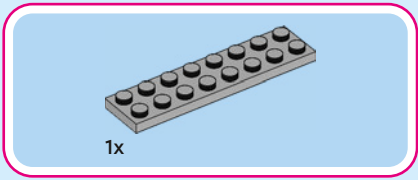

44

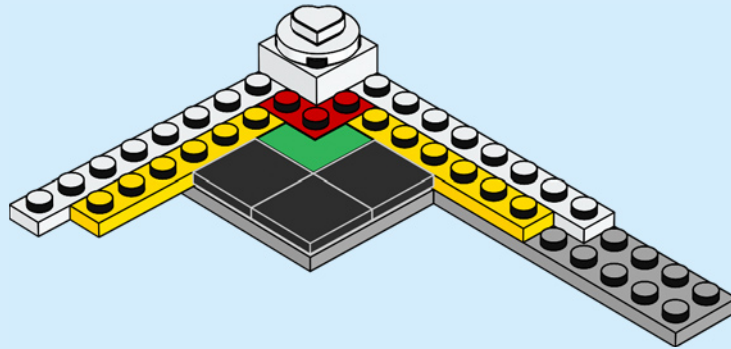

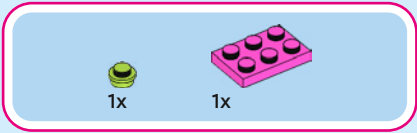

45

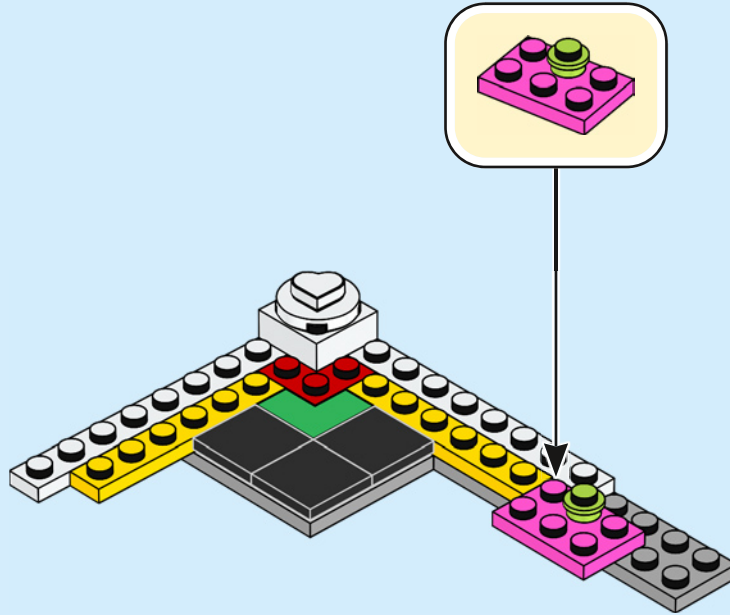

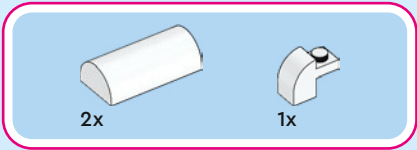

46

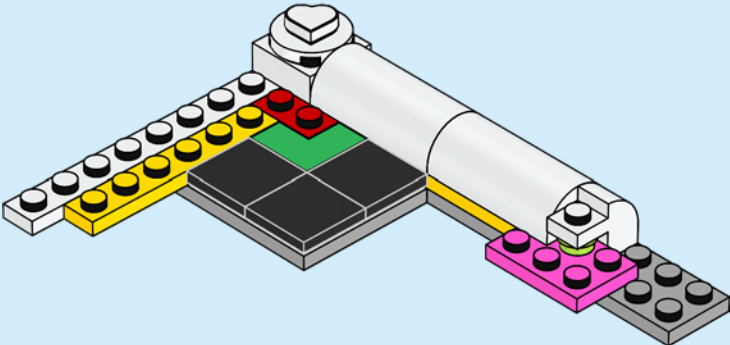

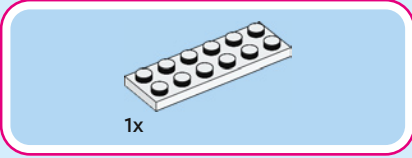
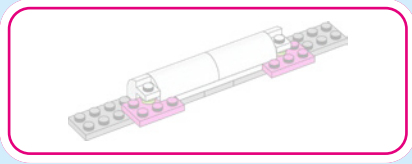

1x

47

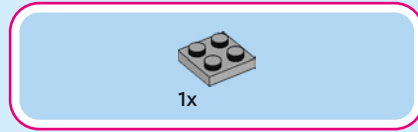
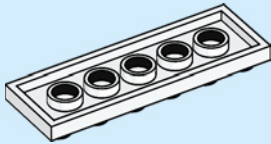

1x

48

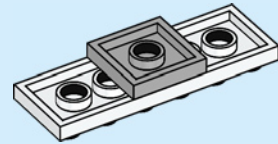

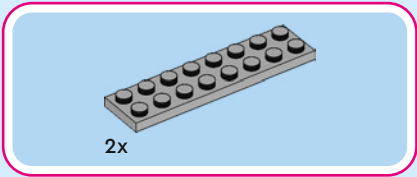

49

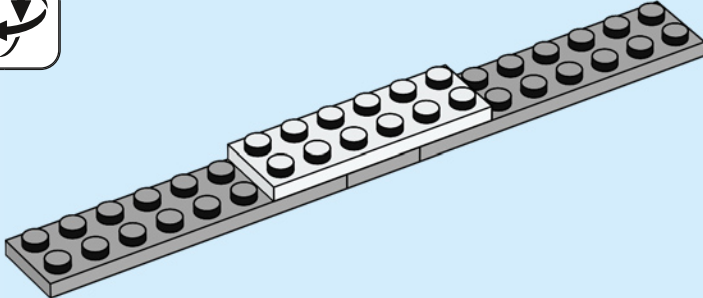



2x

50

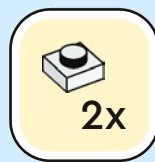

2x

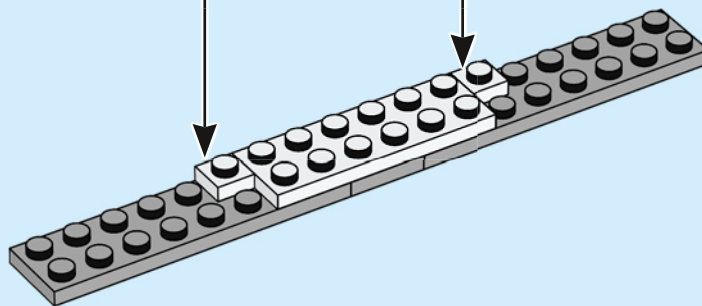

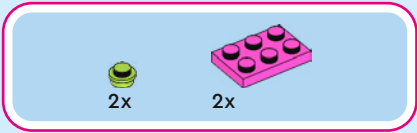

51

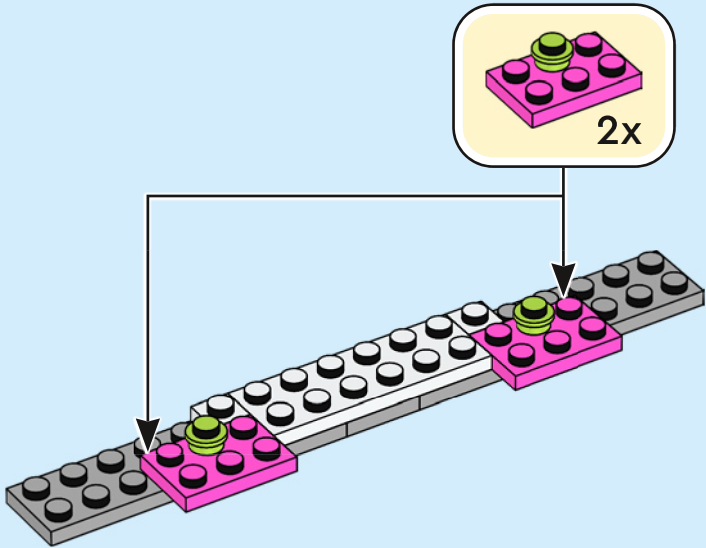

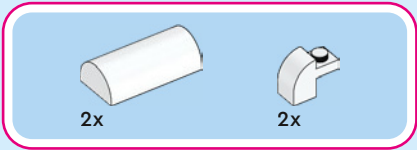

52

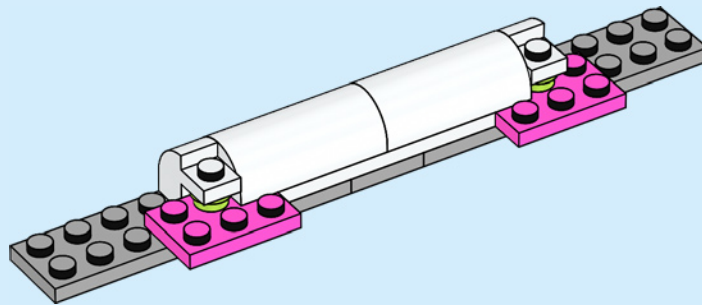

53

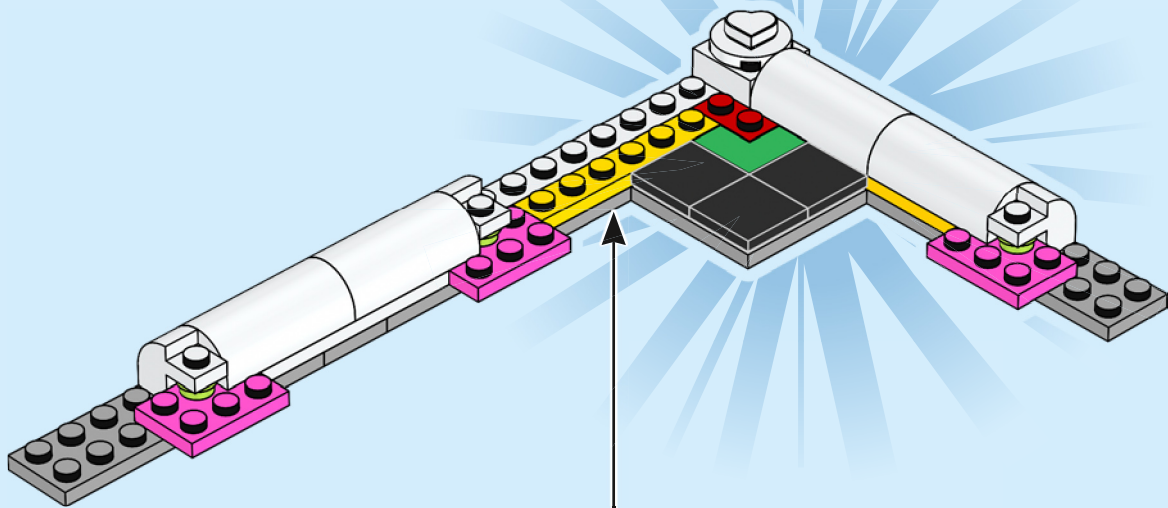

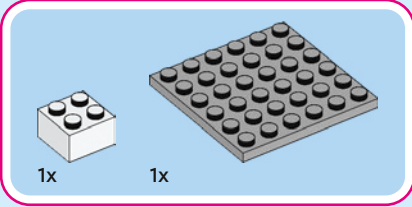
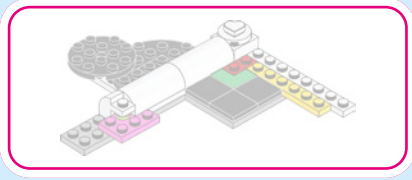

54

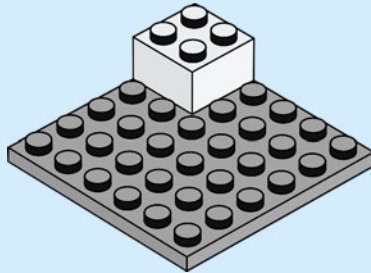

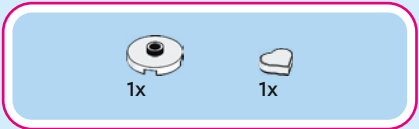

55

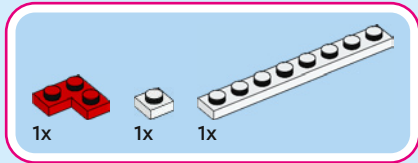
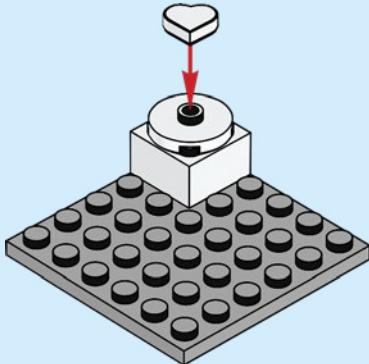

56

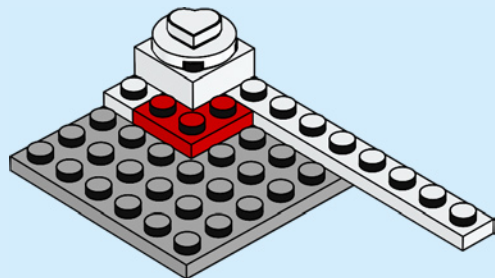

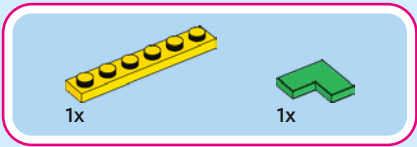

57

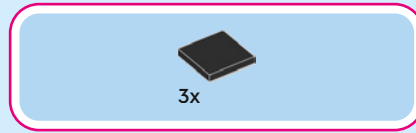
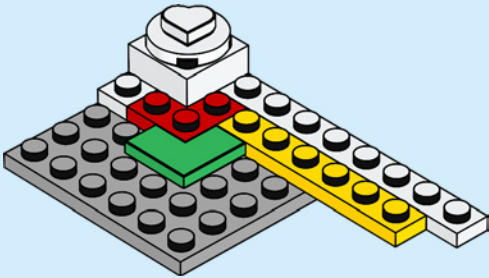

58

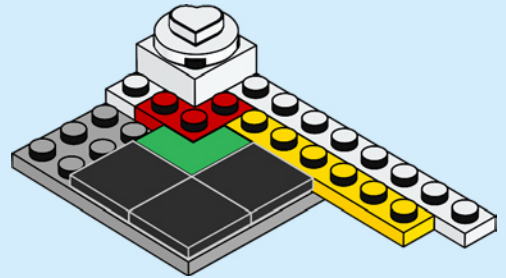



1x

59

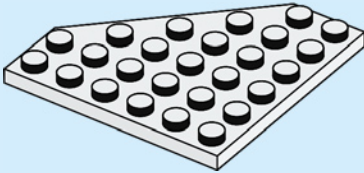

1x

60

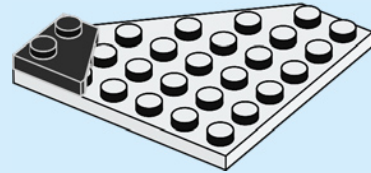

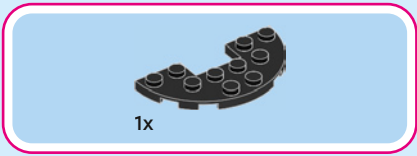

61

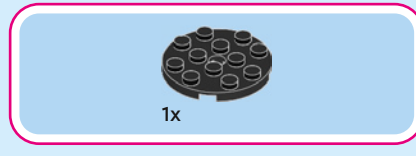
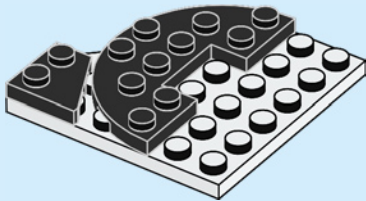

62

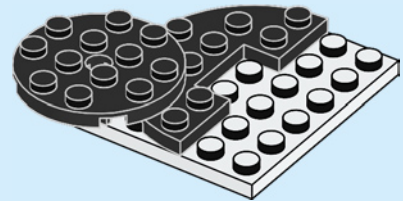



1x

63

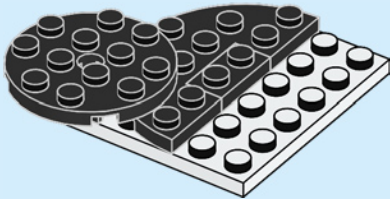

64

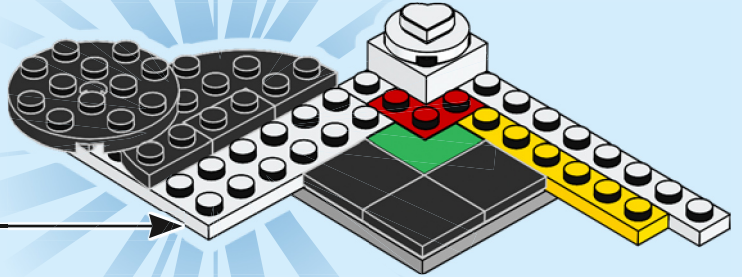



1x

66

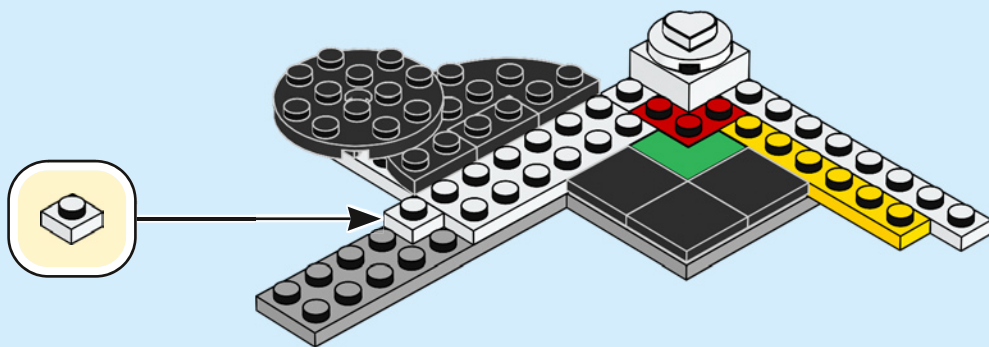

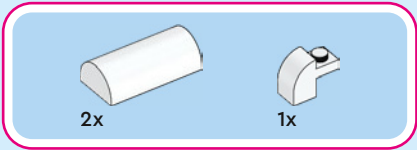

68

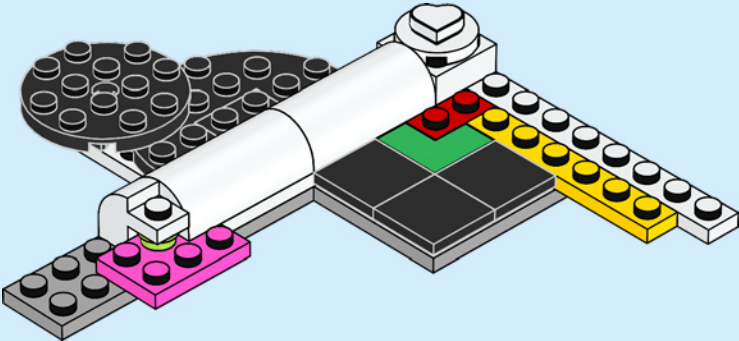

69

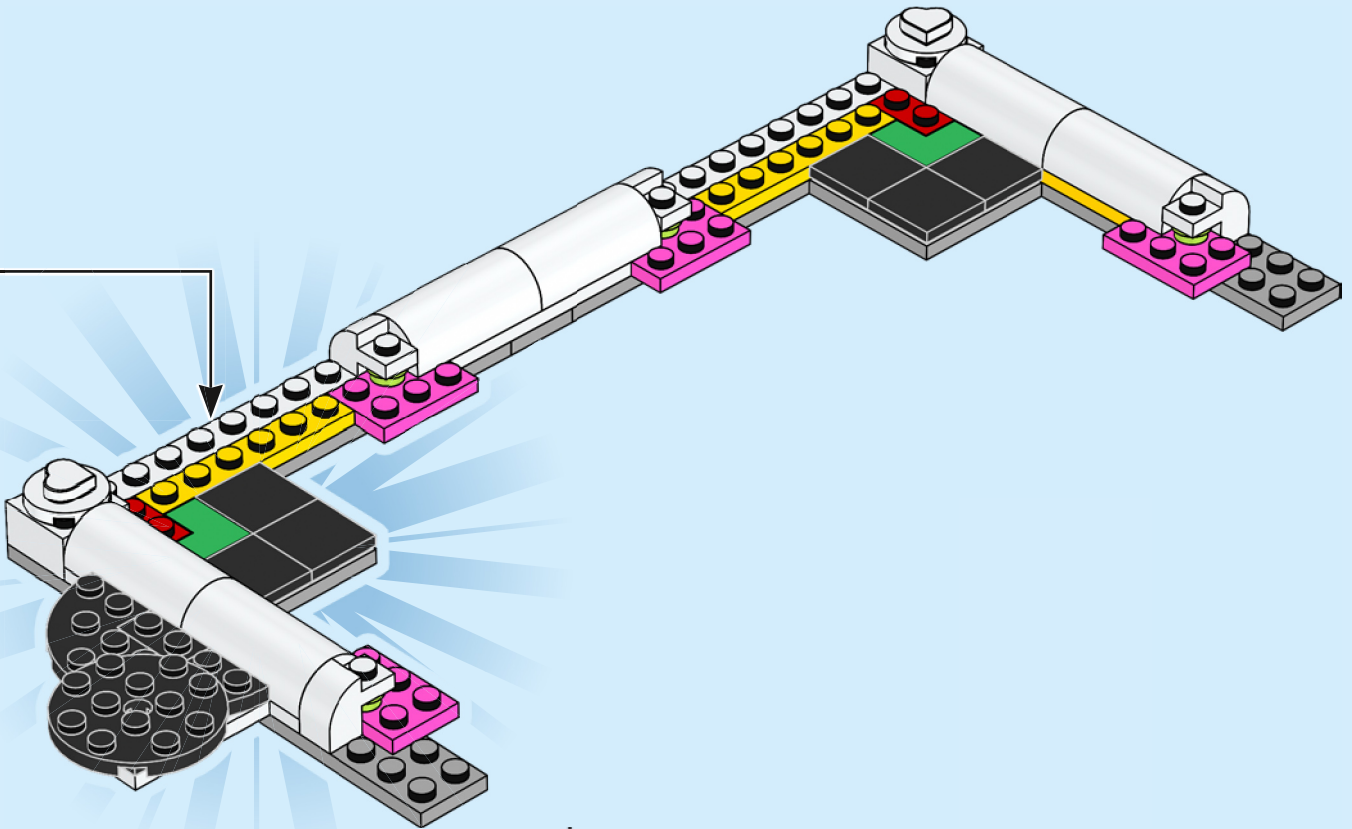

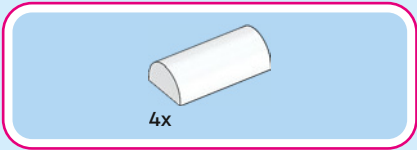

70

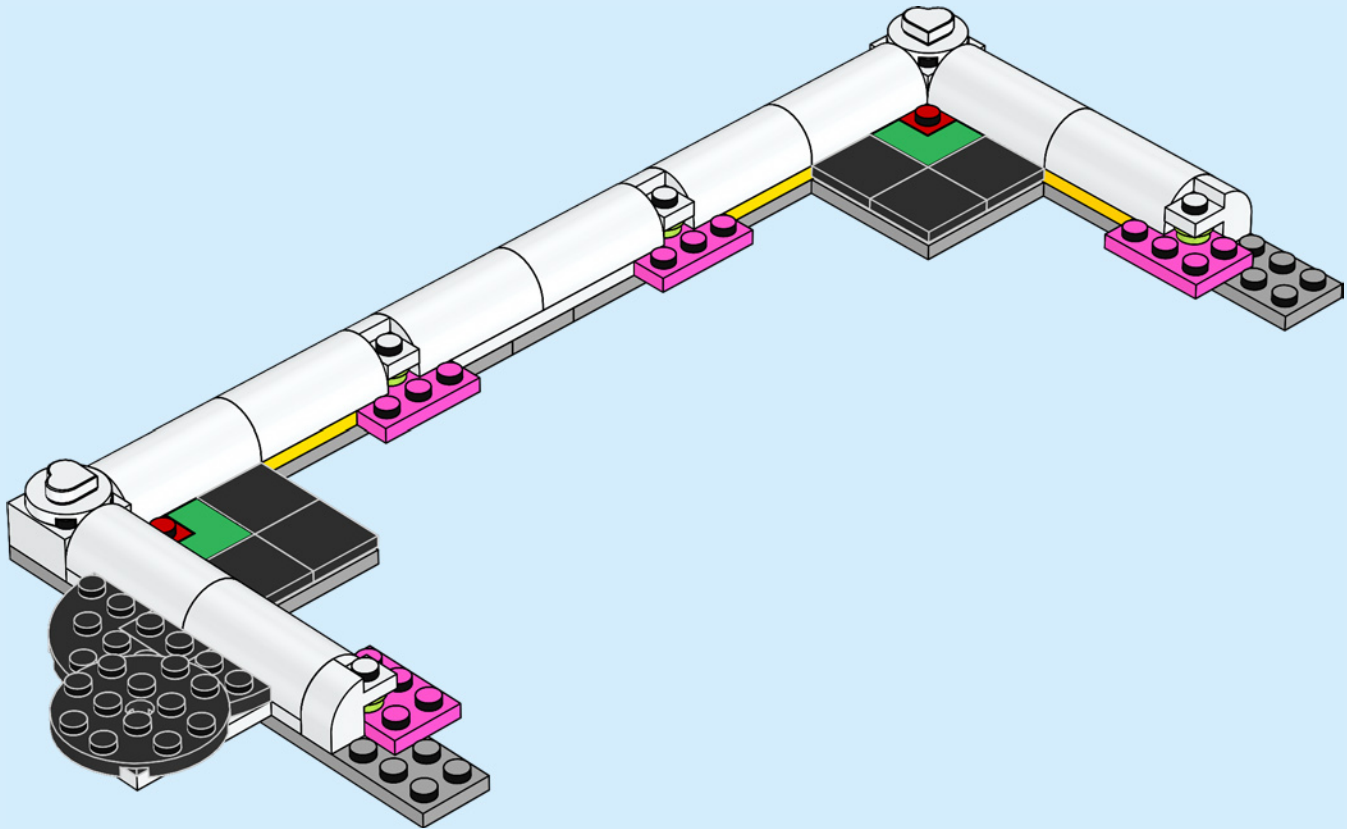



2x



2x

71

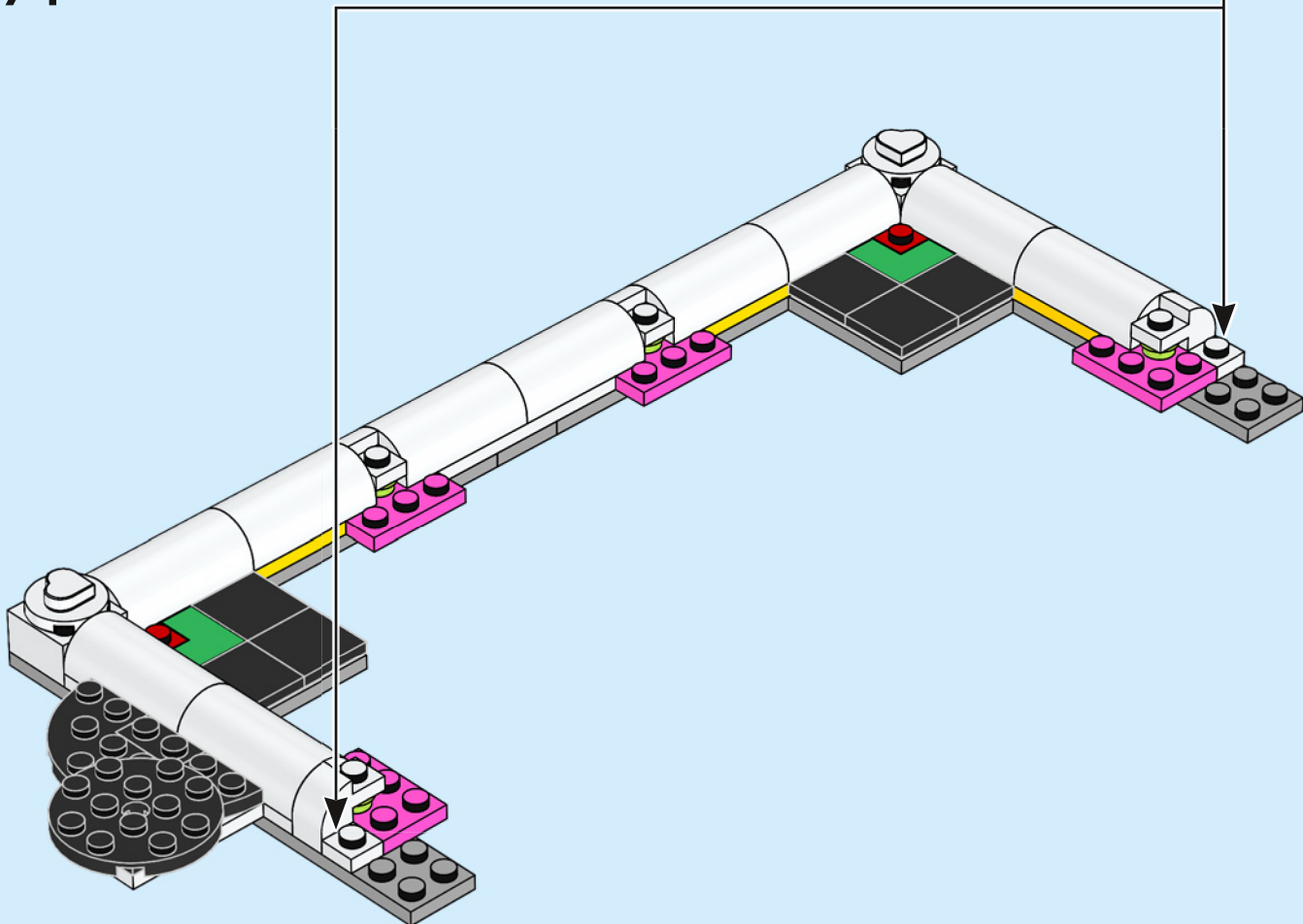

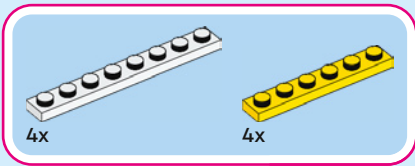

73

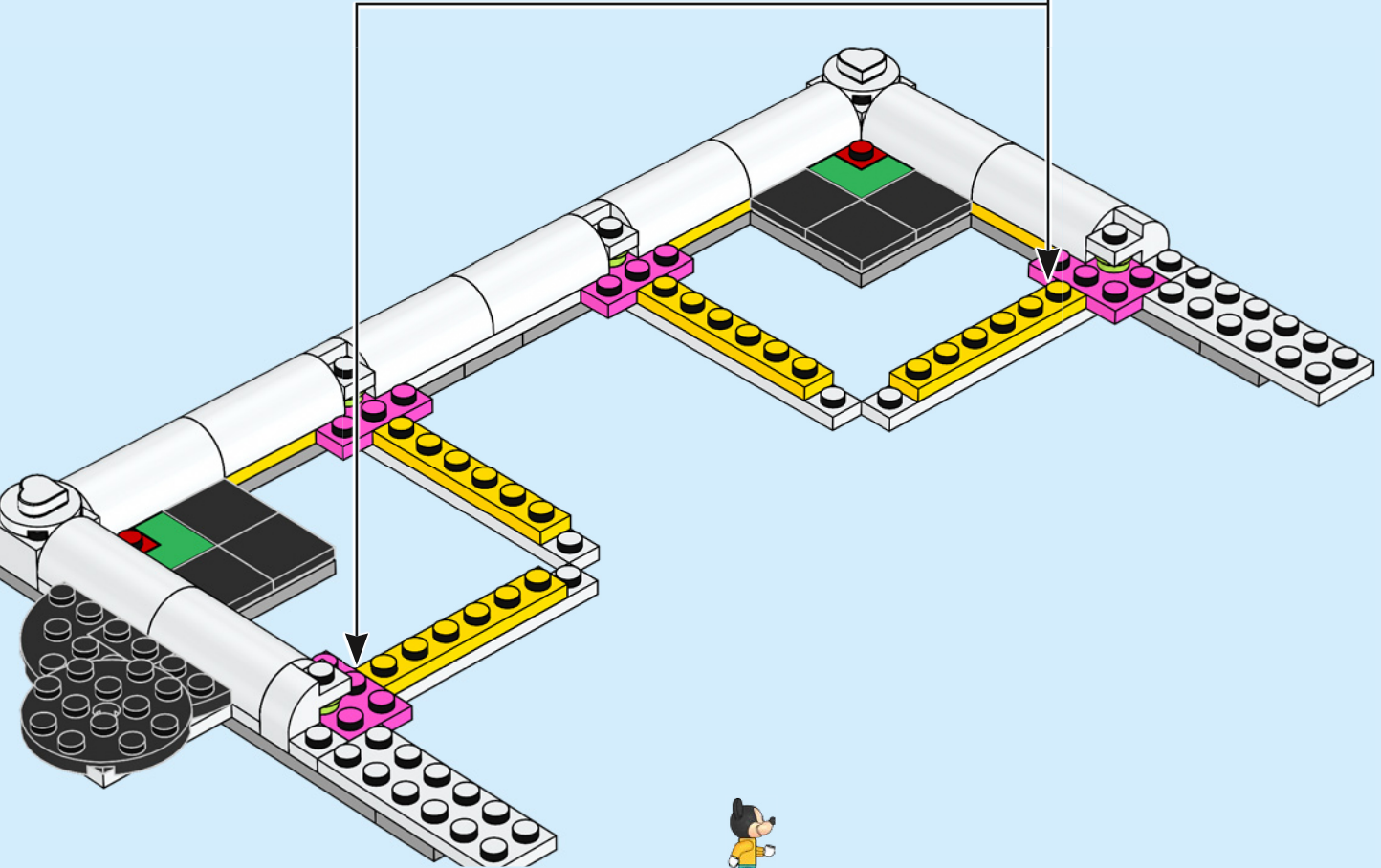
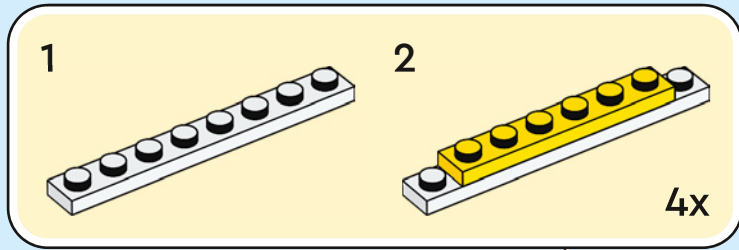

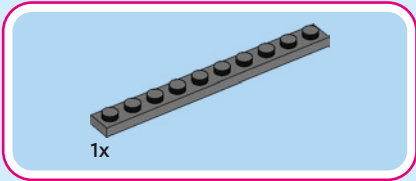
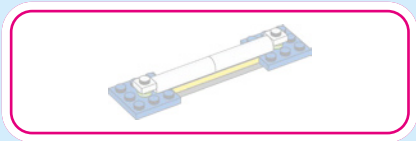

74

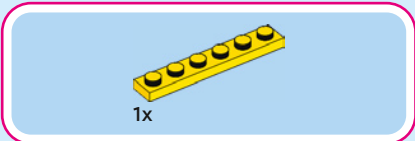
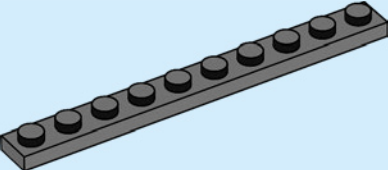

75

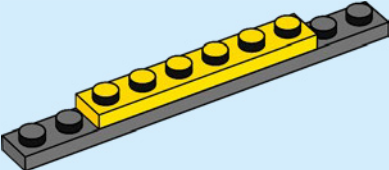

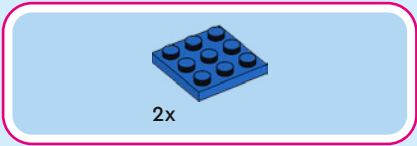

76

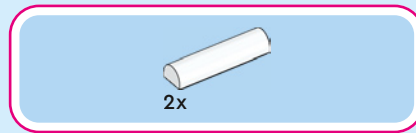
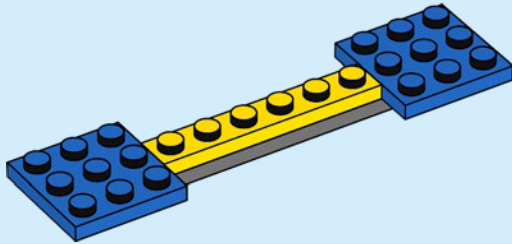

77

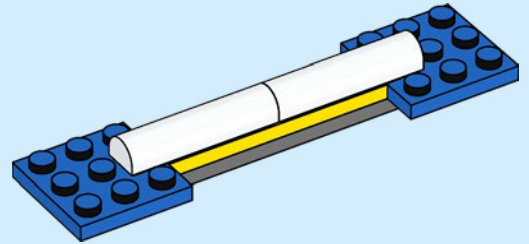



2x

78

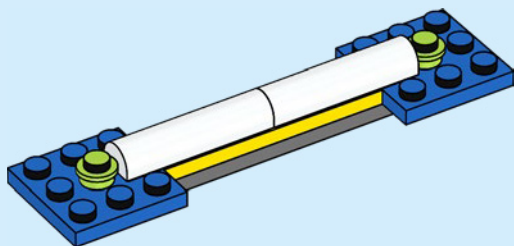

2x

79

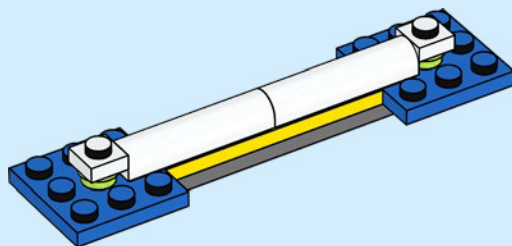

80

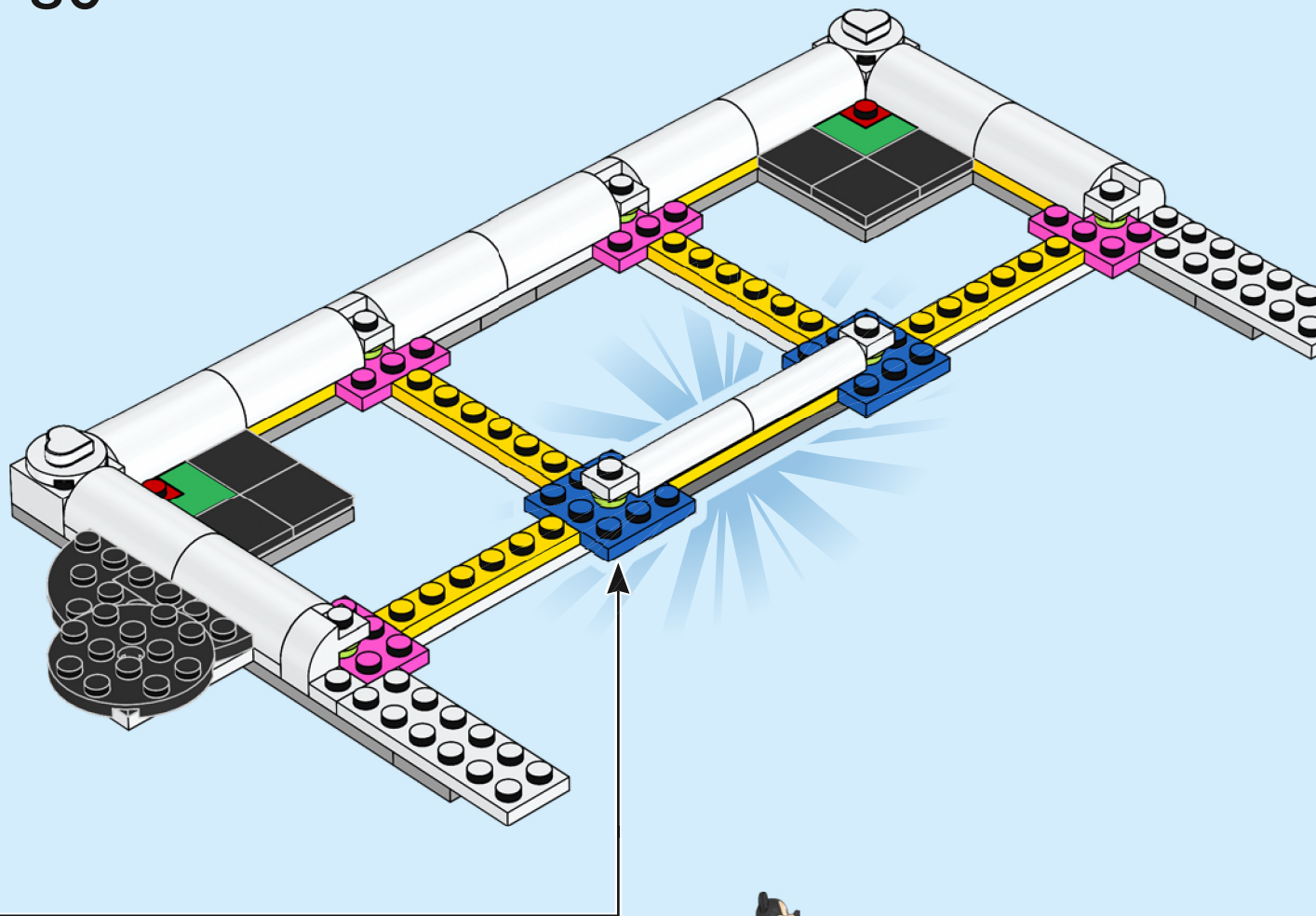



8x

81

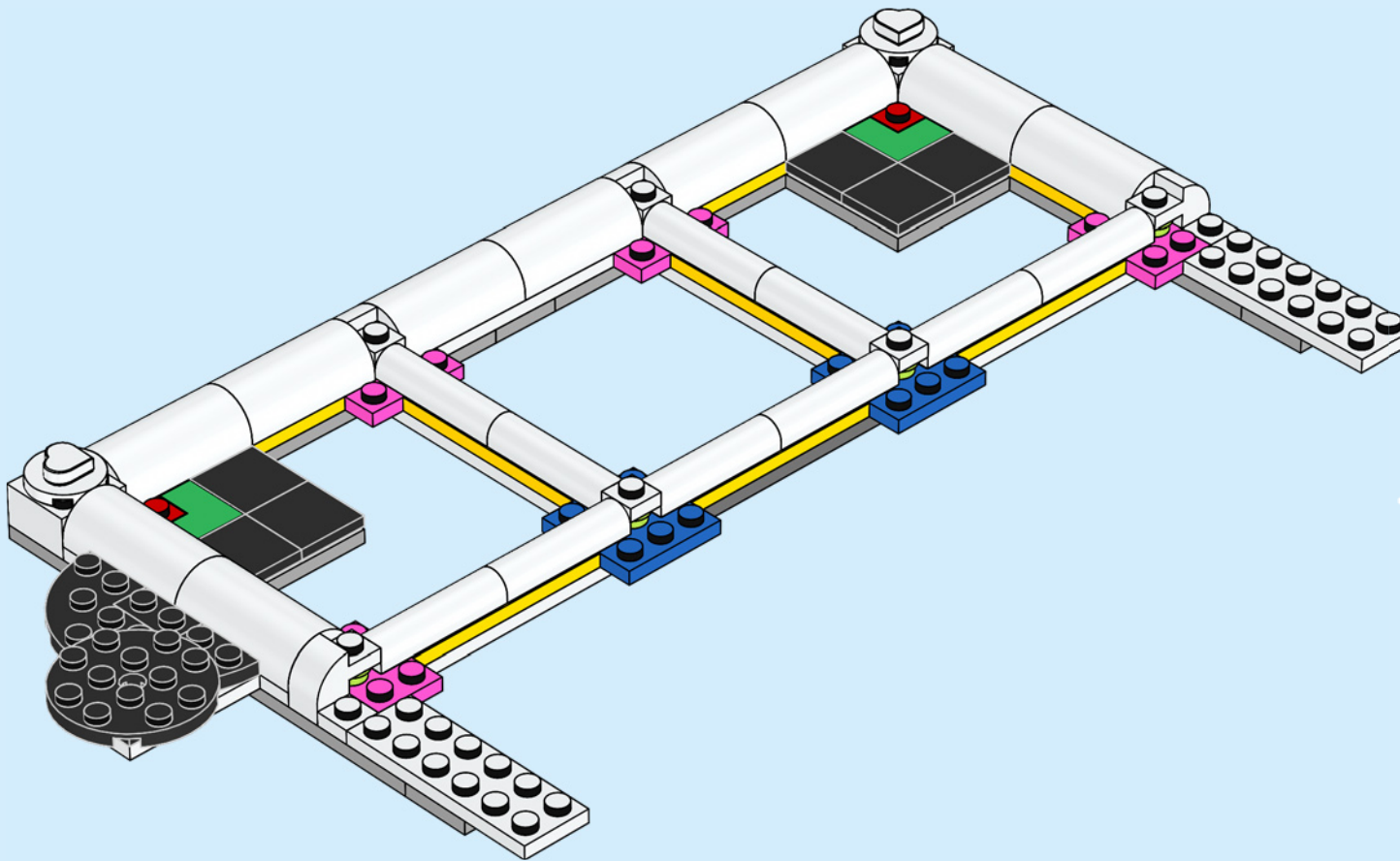

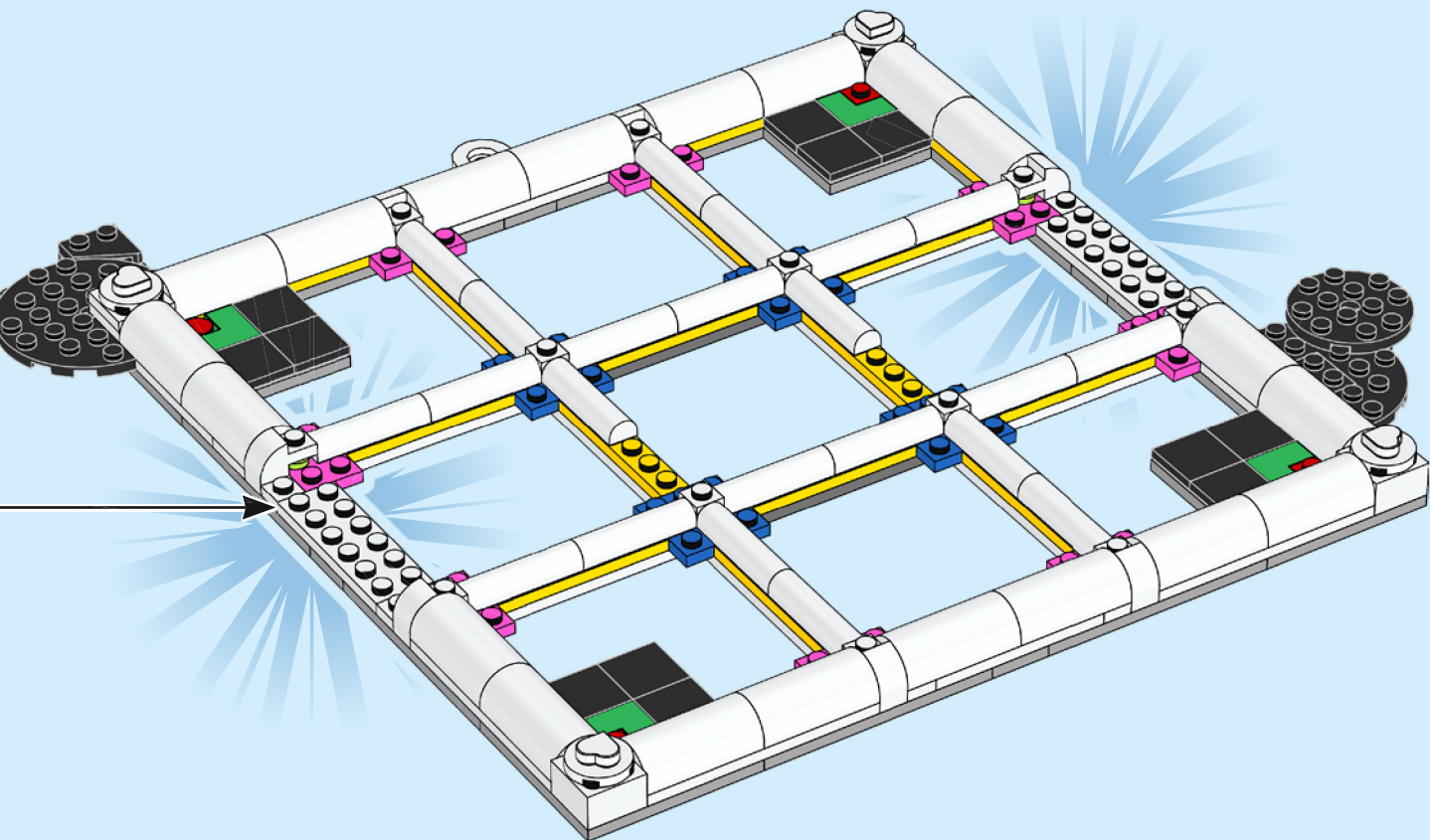



4x

83

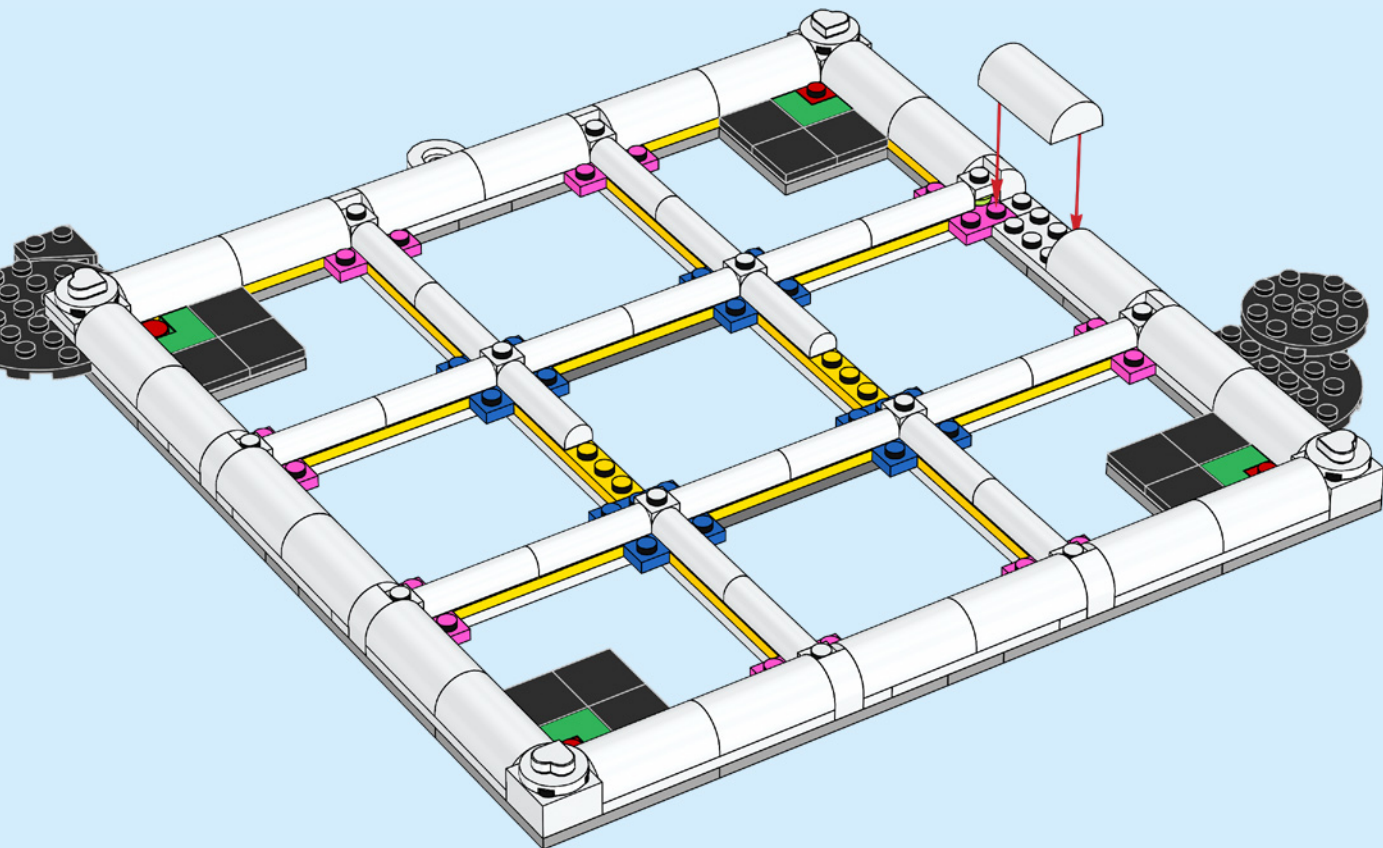

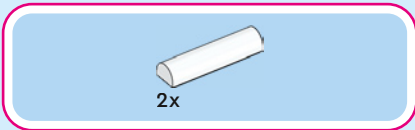

84

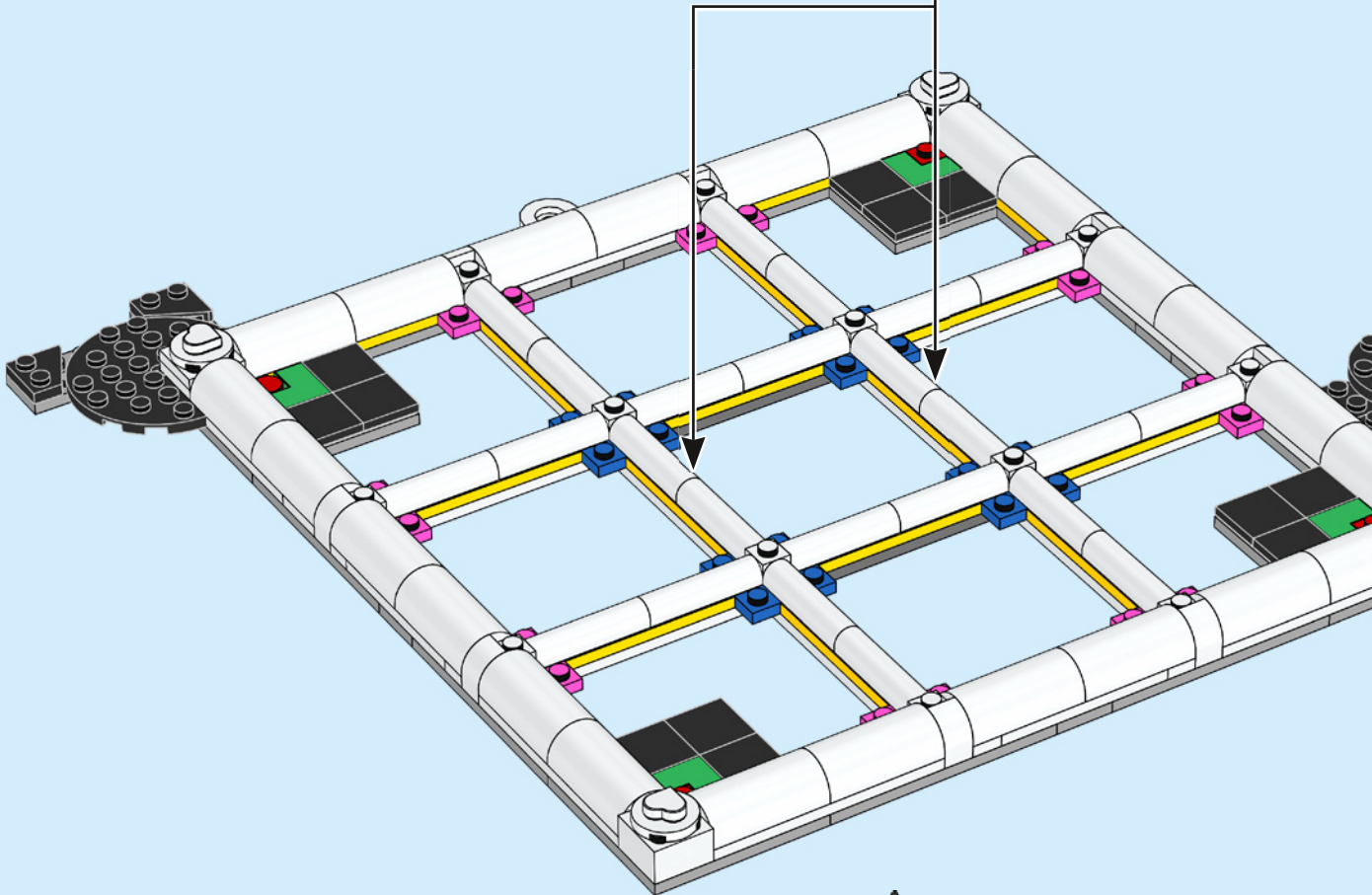
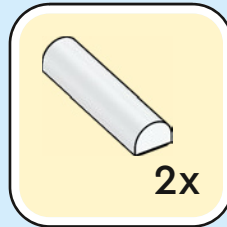

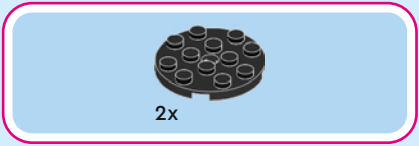

85

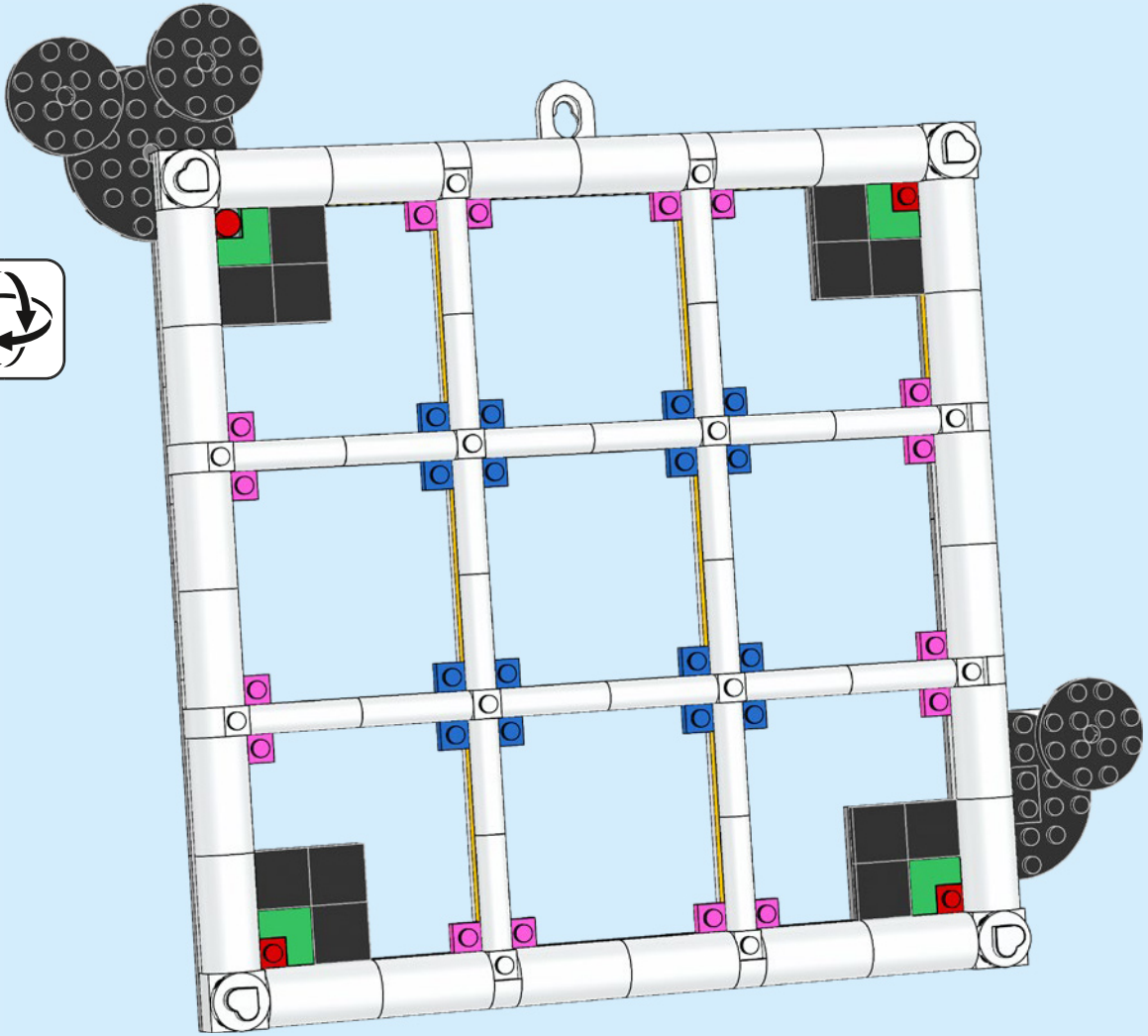

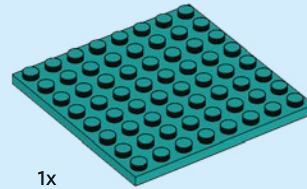
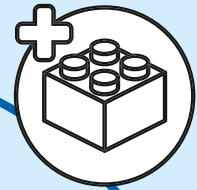

1x

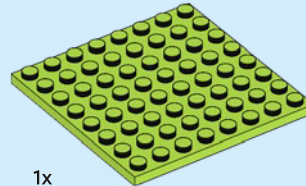

1x

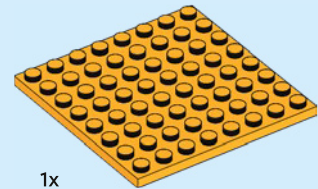

1x

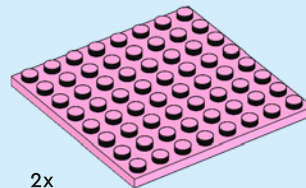

2x

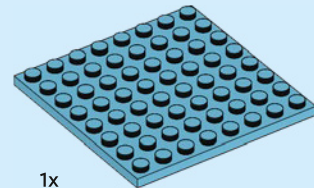

1x



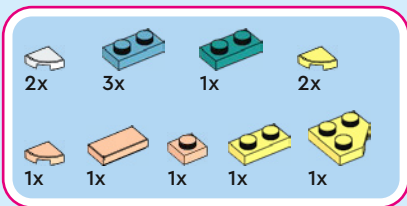

1

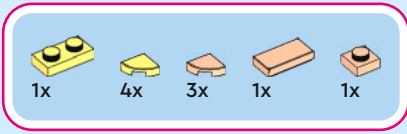
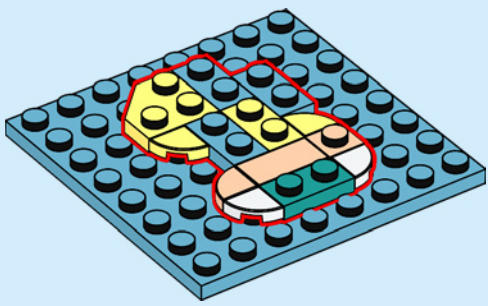

2

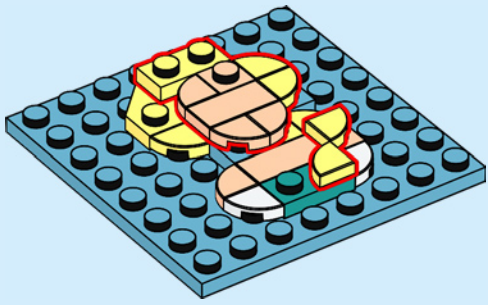

3

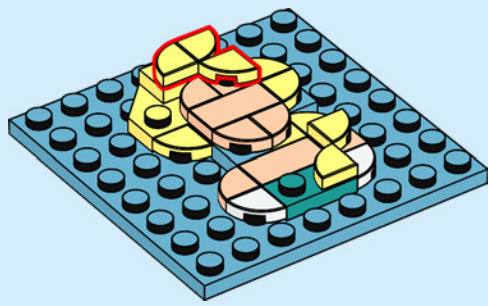

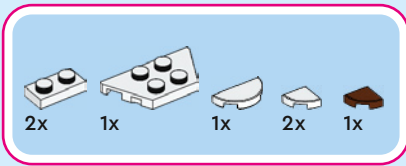

1

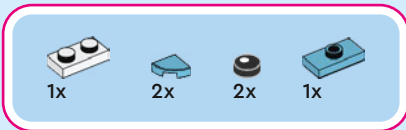
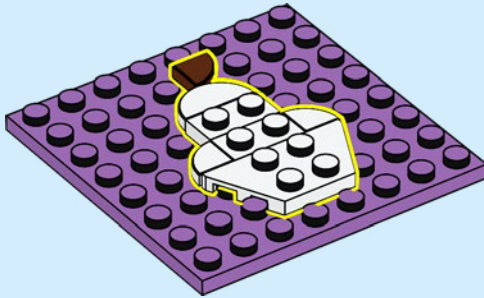

2

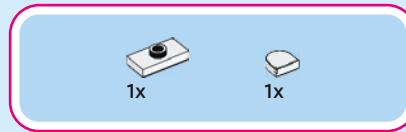
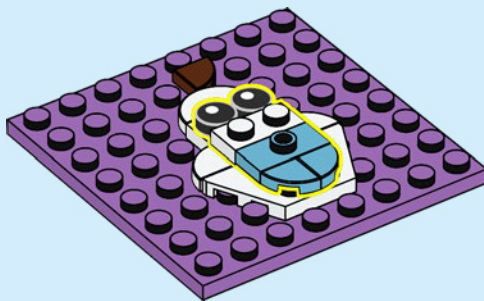

3

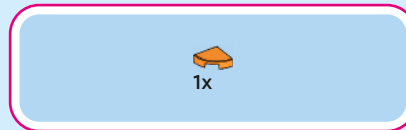
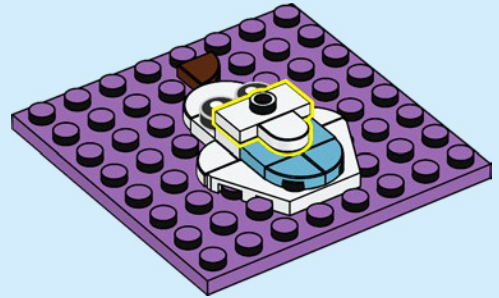

4

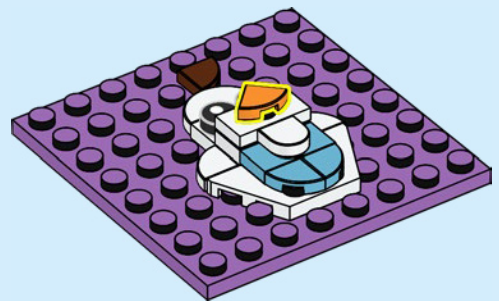

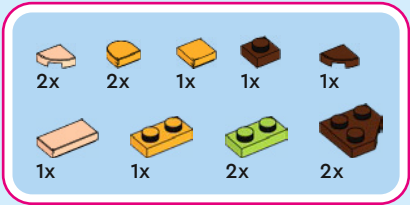

1

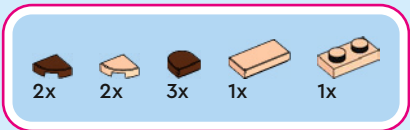
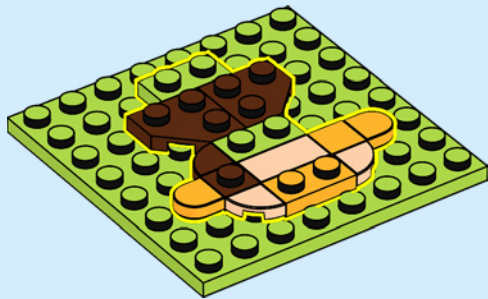

2

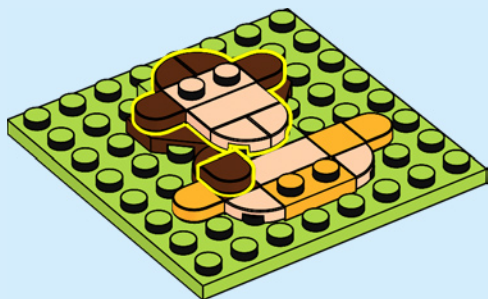

3

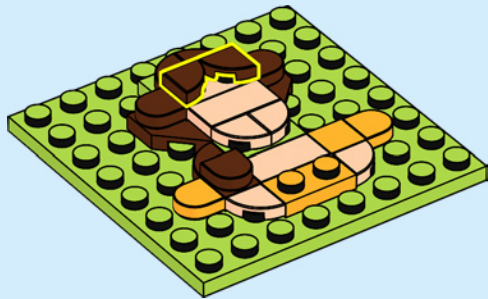

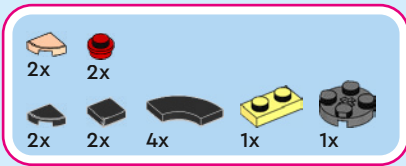

1

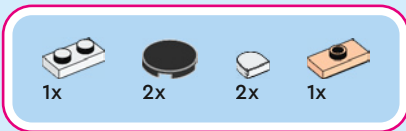
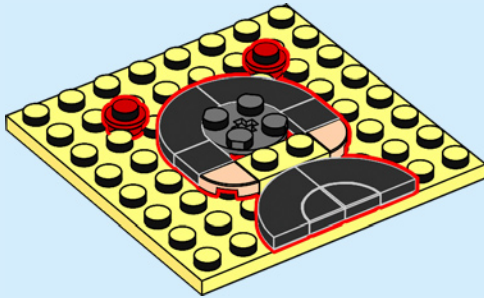

2

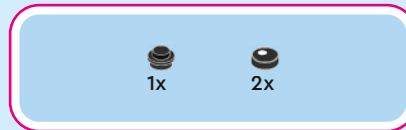
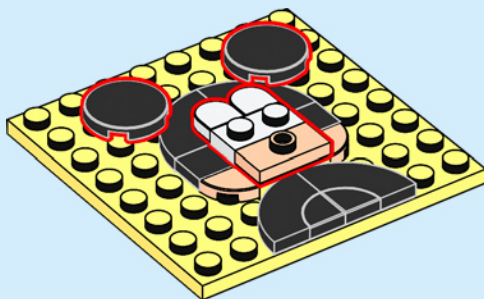

3

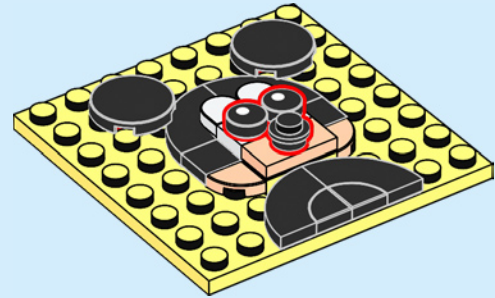

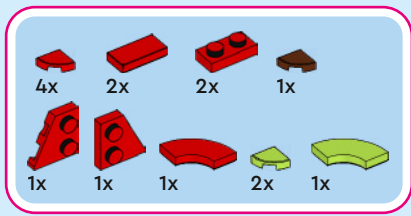

1

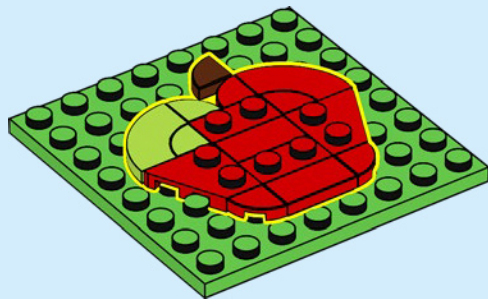

2

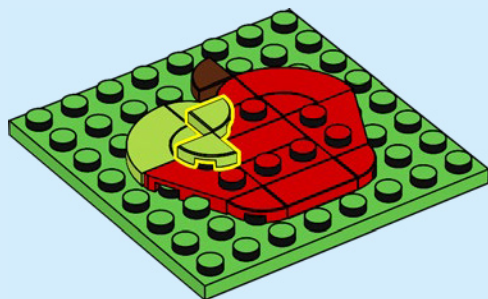

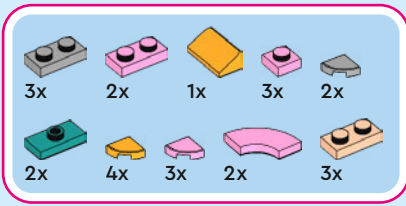

1

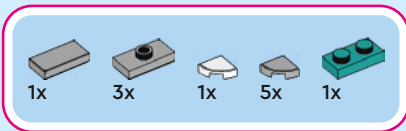
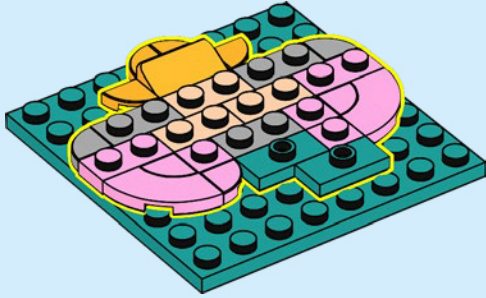

2

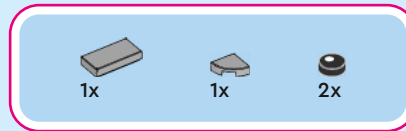
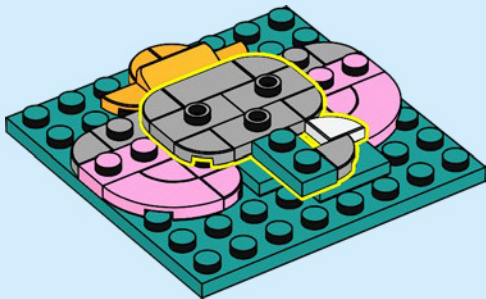

3

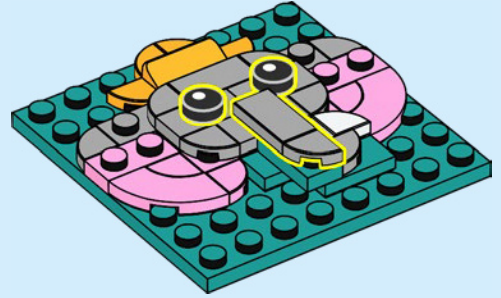

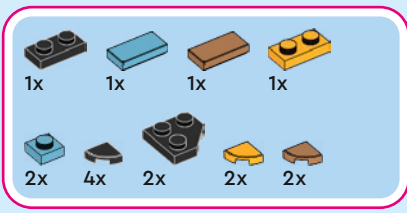

1

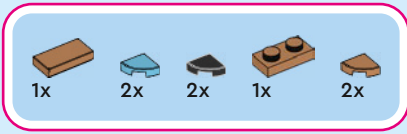
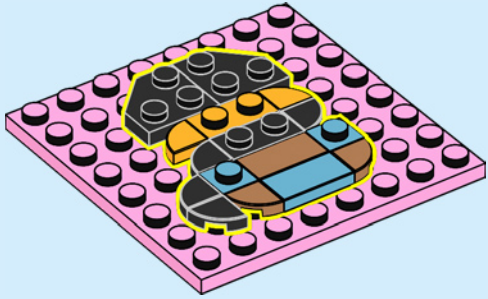

2

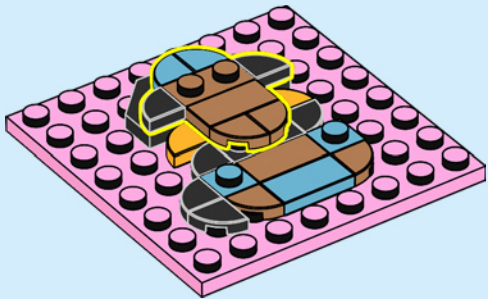

3

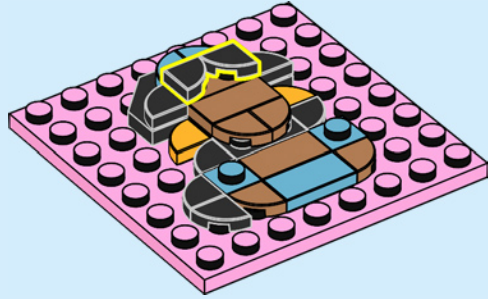

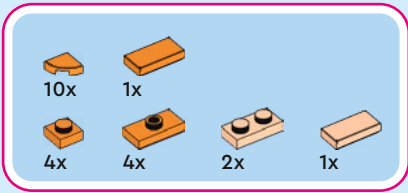

1

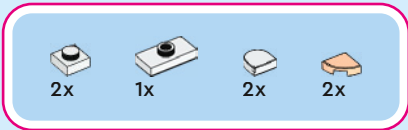
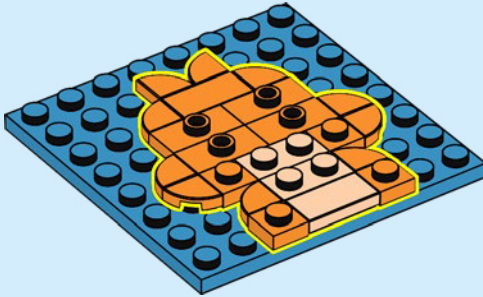

2

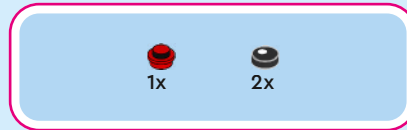
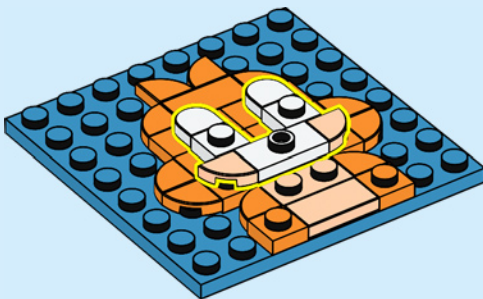

3

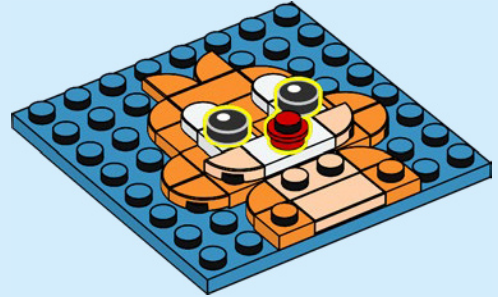

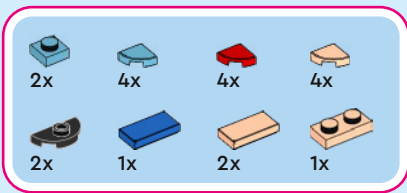

1

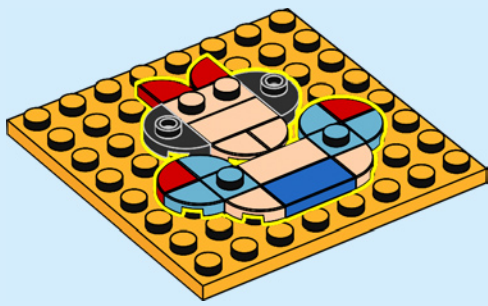

2

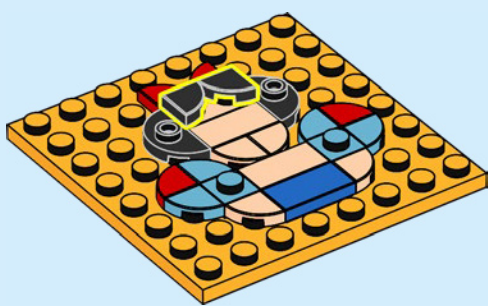

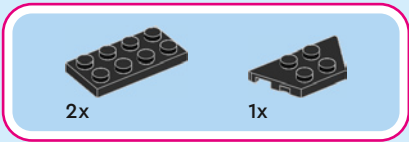

1

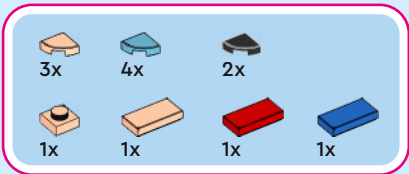
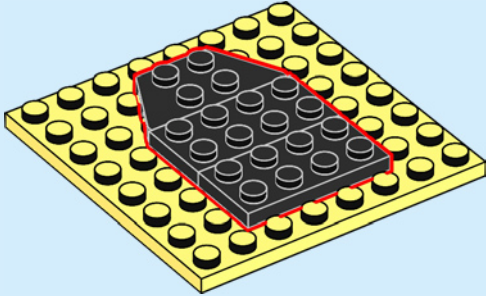

2

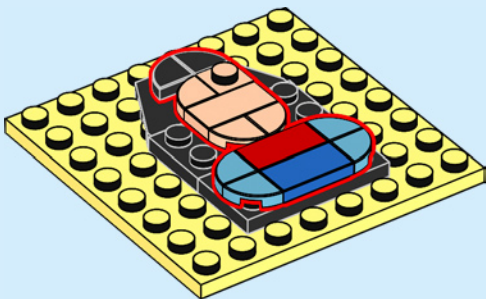

3

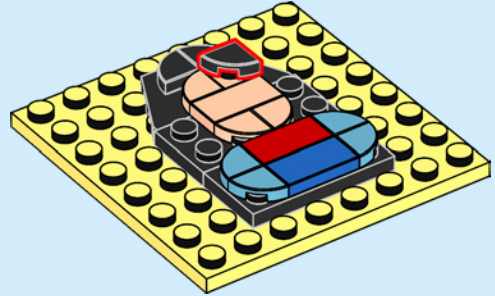

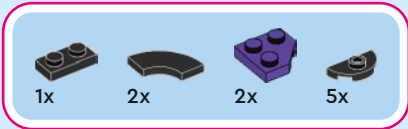

1

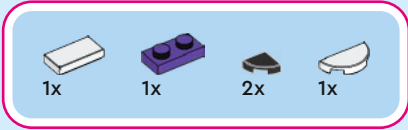
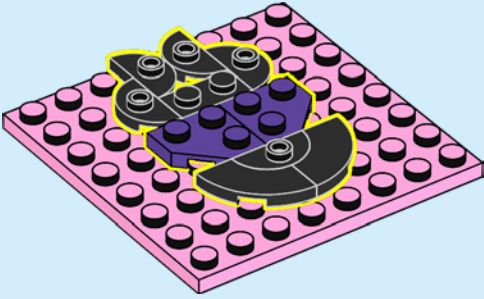

2

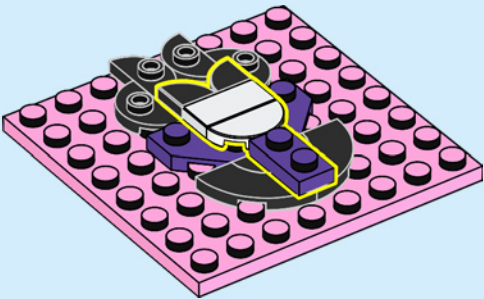





All 12 models can be built simultaneously. 3D building instructions can be found on the LEGO® Builder app. LEGO.com/apps

 LEGO.com/apps

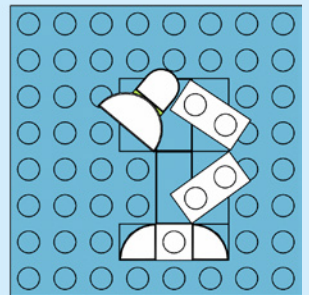
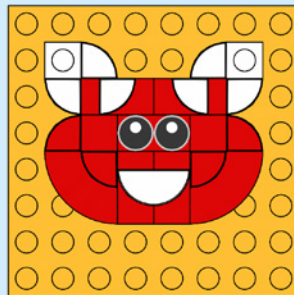
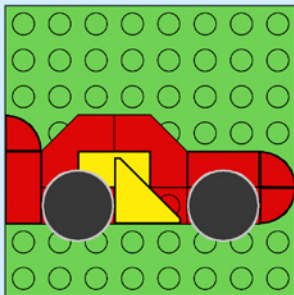
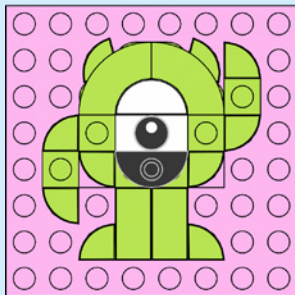
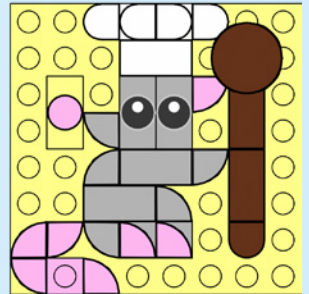
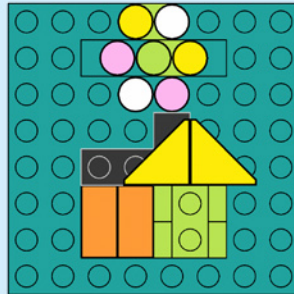
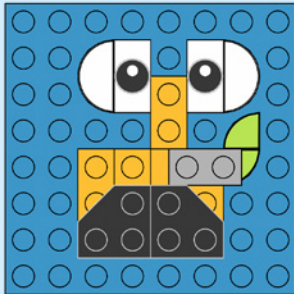
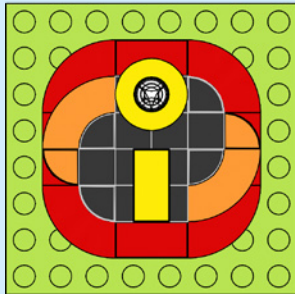
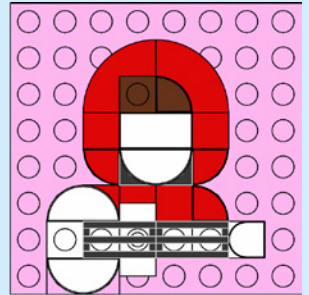
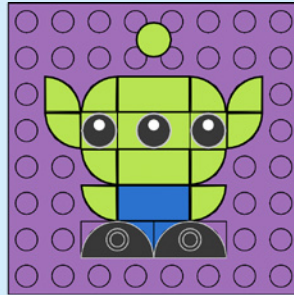
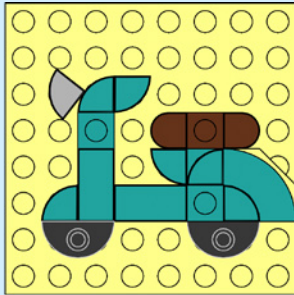
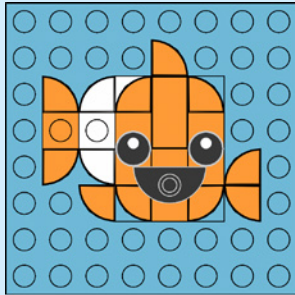



All 12 models can be built simultaneously. 3D building instructions can be found on the LEGO® Builder app. LEGO.com/apps

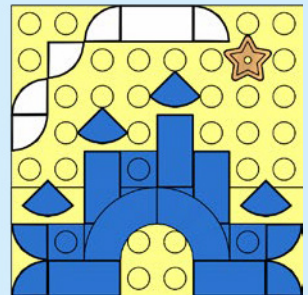
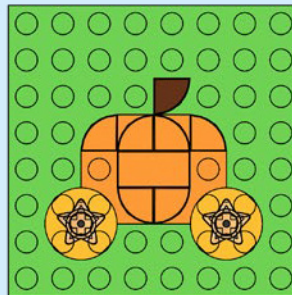
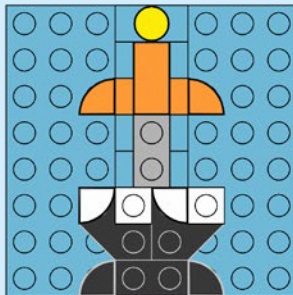
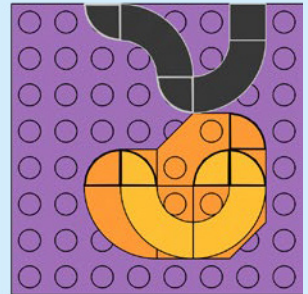
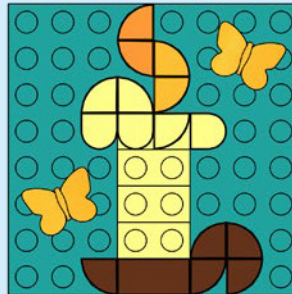
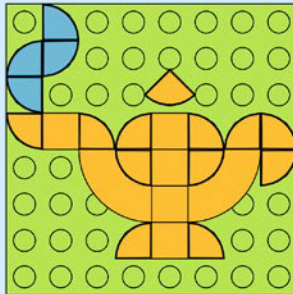
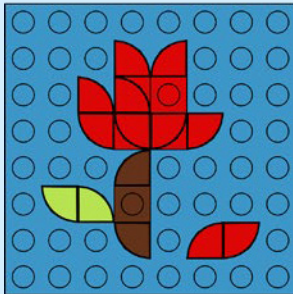
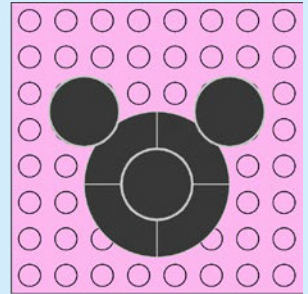
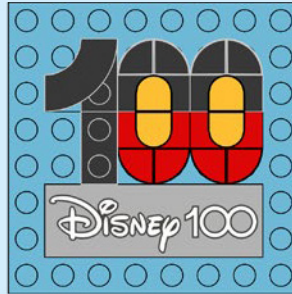
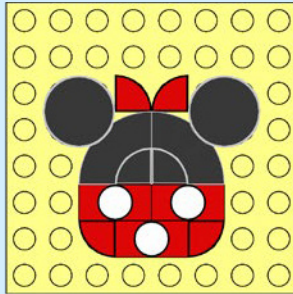
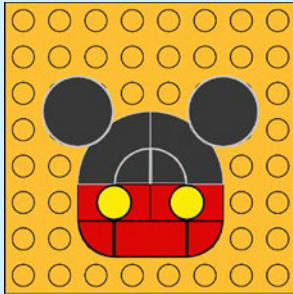



All 12 models can be built simultaneously. 3D building instructions can be found on the LEGO® Builder app. LEGO.com/apps

 LEGO.com/apps

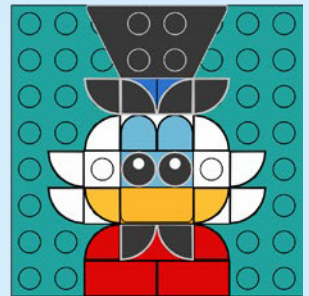
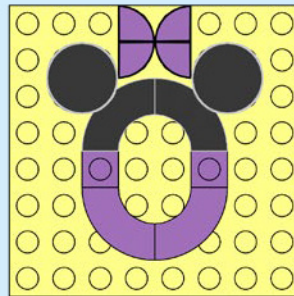
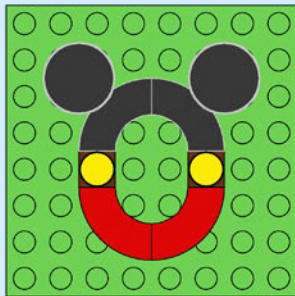
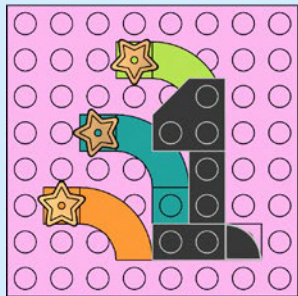
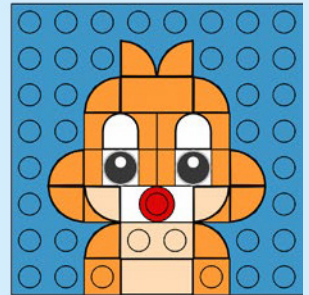
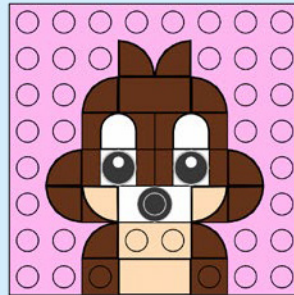
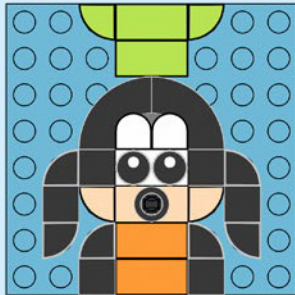
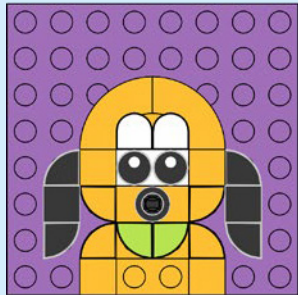
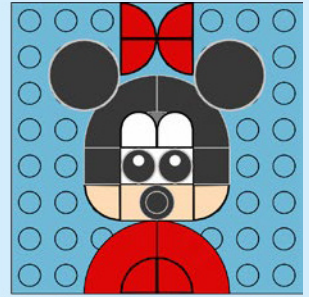
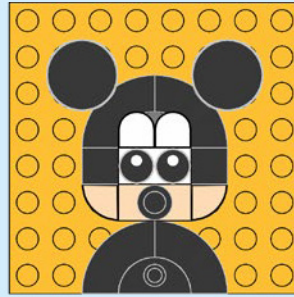
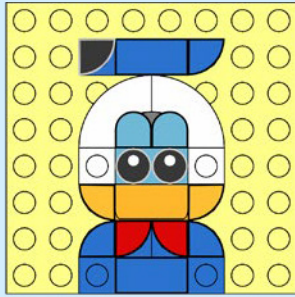
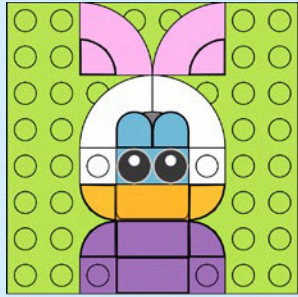



All 12 models can be built simultaneously. 3D building instructions can be found on the LEGO® Builder app. LEGO.com/apps

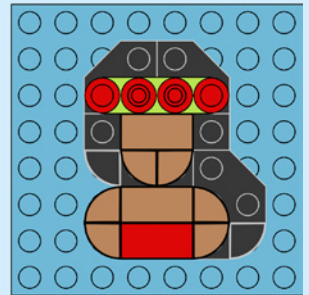
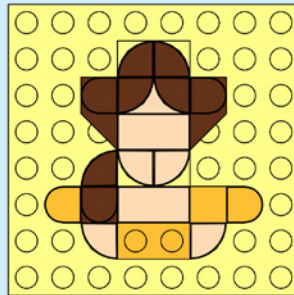
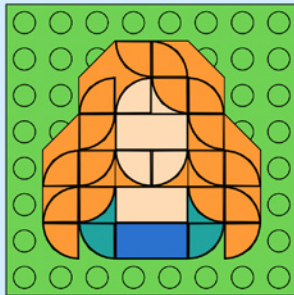
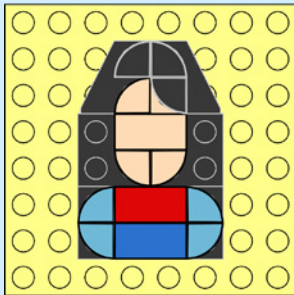
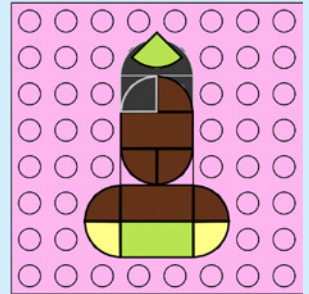
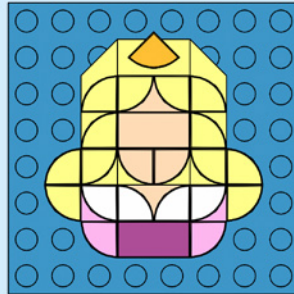
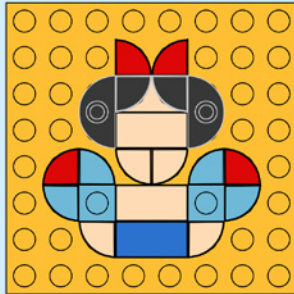
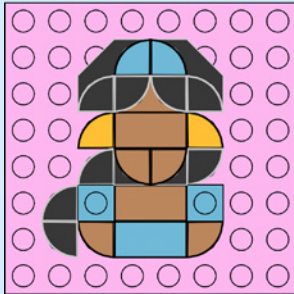
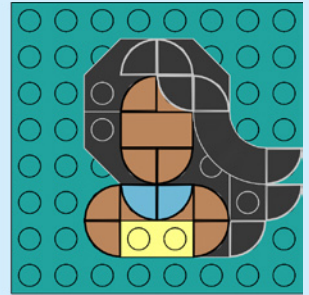
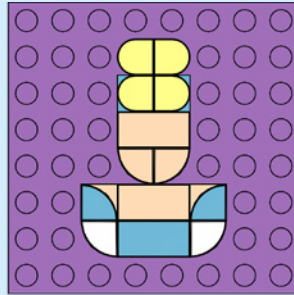
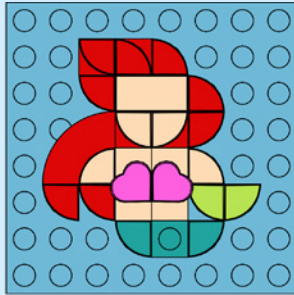
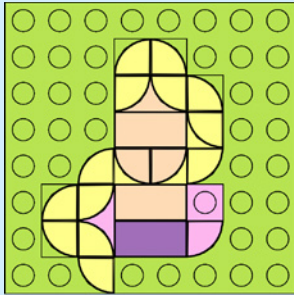



All 12 models can be built simultaneously. 3D building instructions can be found on the LEGO® Builder app. LEGO.com/apps

 LEGO.com/apps

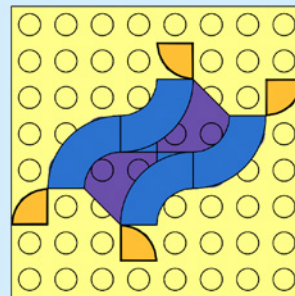
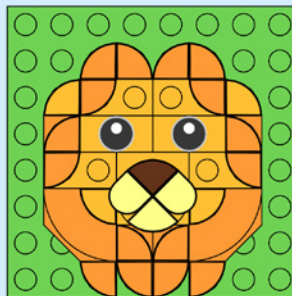
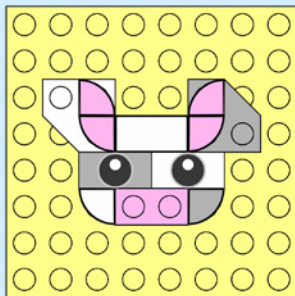
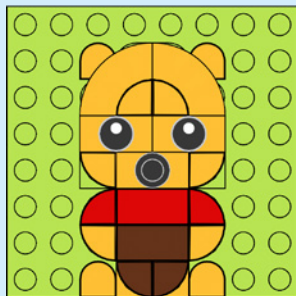
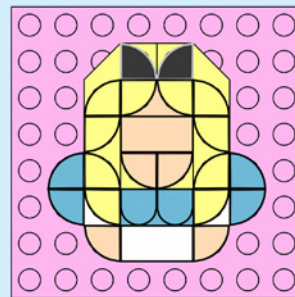
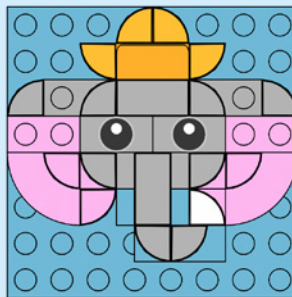
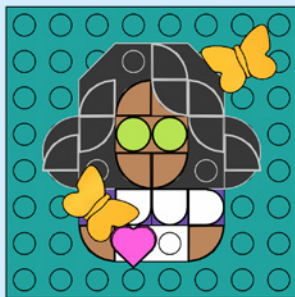
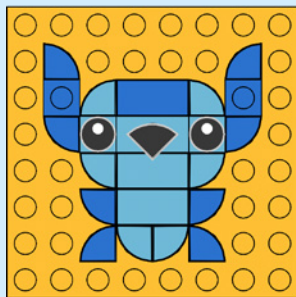
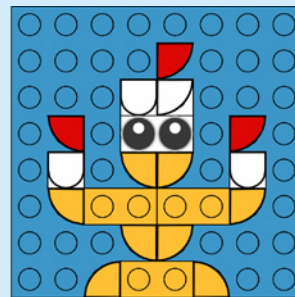
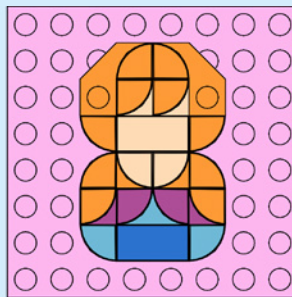
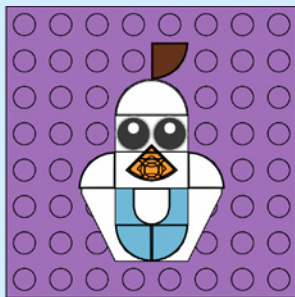
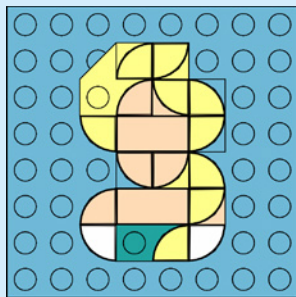



All 12 models can be built simultaneously. 3D building instructions can be found on the LEGO® Builder app. LEGO.com/apps

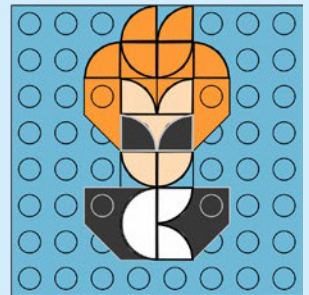
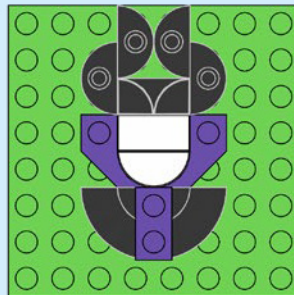
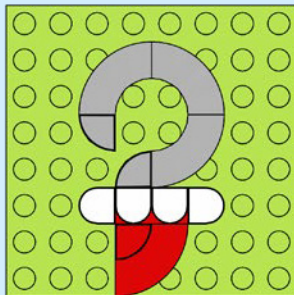
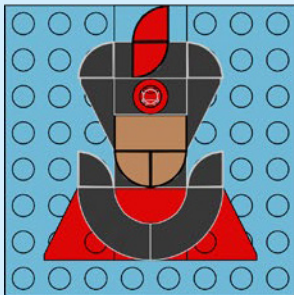
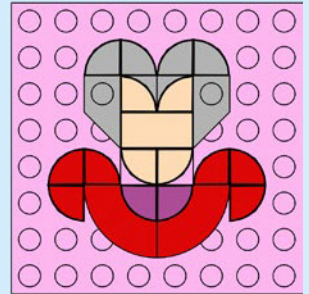
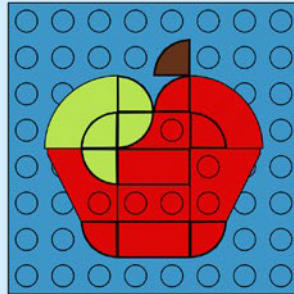
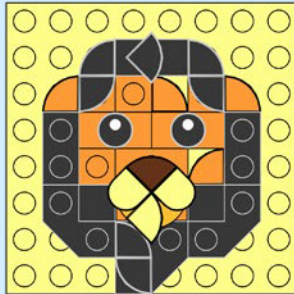
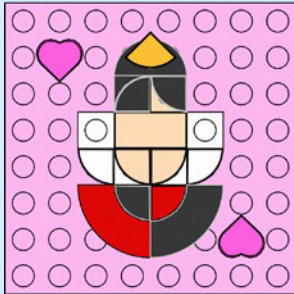
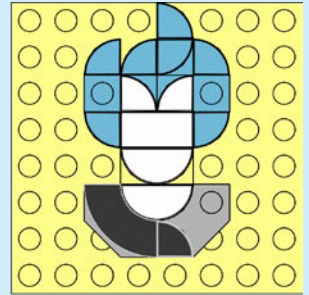
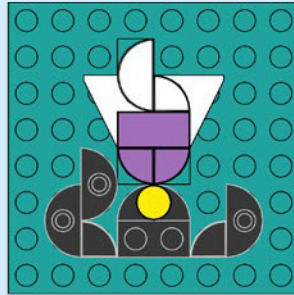
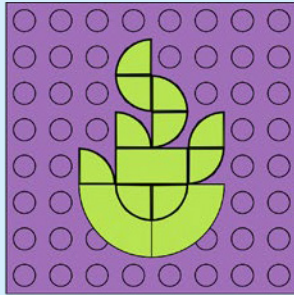
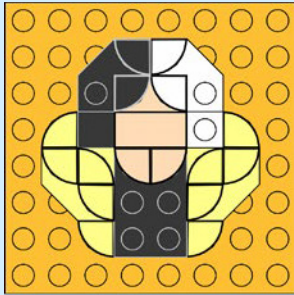

All 12 models can be built simultaneously. 3D building instructions can be found on the LEGO® Builder app.
LEGO.com/apps

Les 12 modèles peuvent être construits simultanément. Trouvez les instructions de montage en 3D dans l'application
LEGO® Builder. LEGO.com/apps

Los 12 modelos se pueden construir simultáneamente. Instrucciones de construcción 3D disponibles en la app
LEGO® Builder. LEGO.com/apps

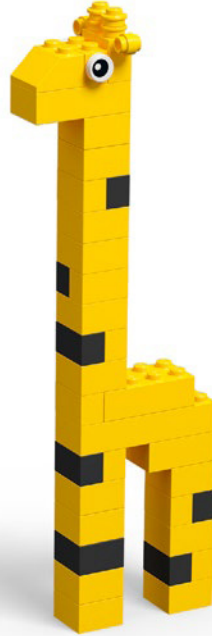
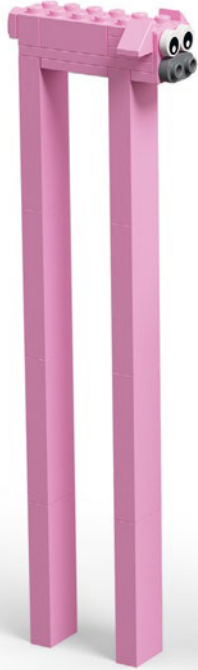

Rebuild
the
world™



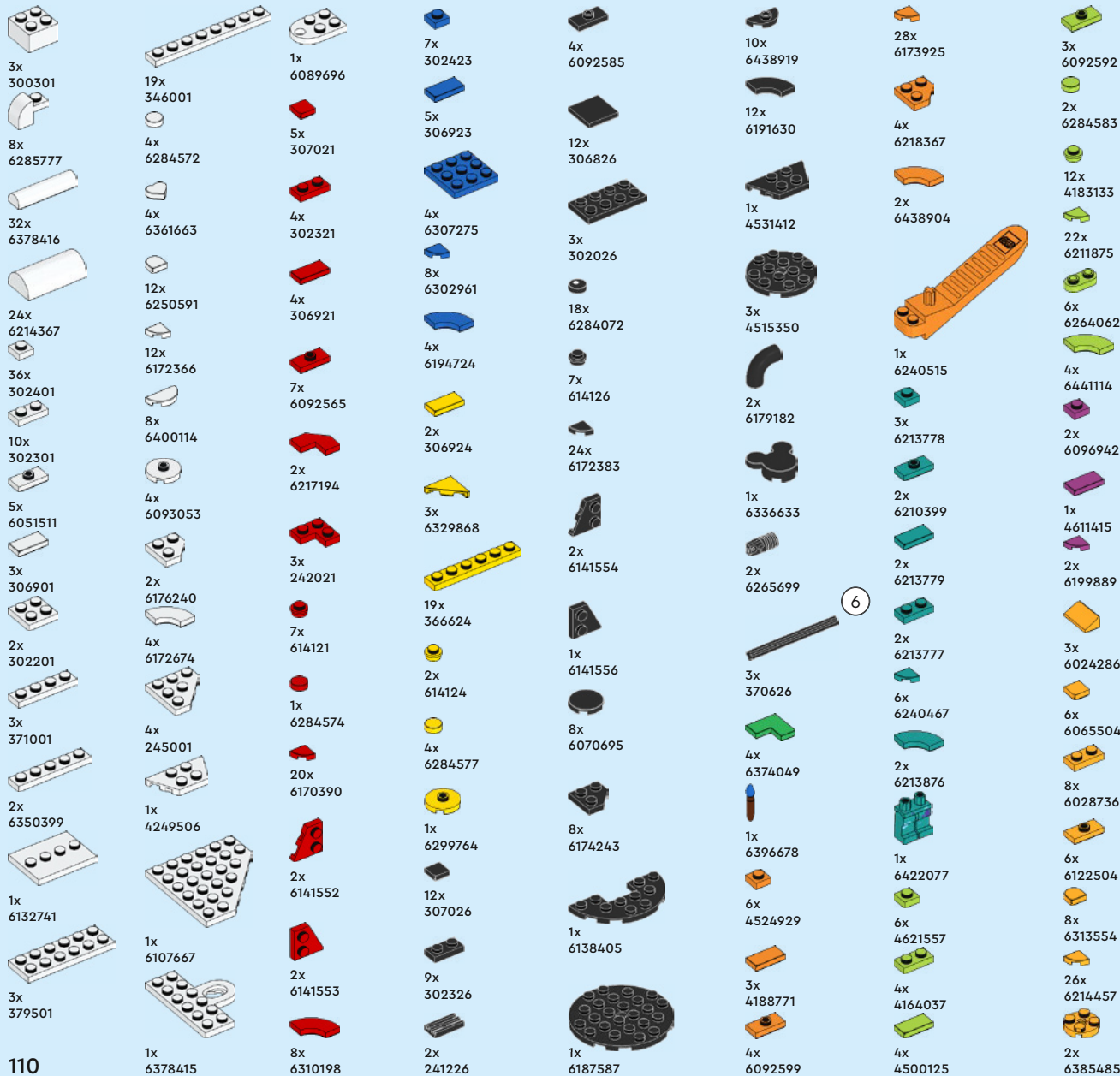



4x
6334203



1x
6445403



2x
6370534



6x
4221744



2x
4211151



4x
6092590



4x
6328180



14x
6149677



1x
6075213



2x
6218366



4x
6066097



2x
4211414



4x
4211398



4x
4211397



2x
4211395



1x
6440895



8x
4211406

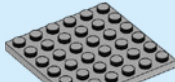

4x
4211474



2x
6267048



12x
6176433



4x
4278273



4x
6186657



3x
6163990



1x
4210635



2x
4257526



6x
4211042



8x
6060801



2x
6256130



5x
6031883



4x
4654128



3x
6284587



7x
6240463



2x
6331809



12x
6201647



2x
6195266



4x
6250598



28x
6228969



4x
6298528



4x
4655695



2x
6382583



4x
6357797



4x
6329282



14x
6330199



8x
6369188



28x
6275872



4x
6184647



1x
6172316



2x
6215606



6x
6021997



2x
6218360



18x
6248536



1x
6384433



5x
6097493



6x
6097419



2x
4649741



4x
6331949



6x
6375606



14x
6150307



4x
4619521



2x
6152645



6x
6199893



2x
6199900

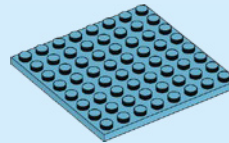

2x
6205088



1x
6344002

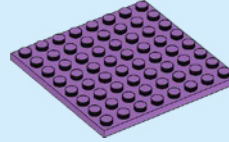

1x
6440843

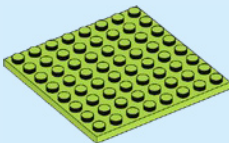

1x
6440842

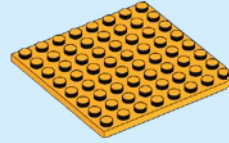

1x
6429042

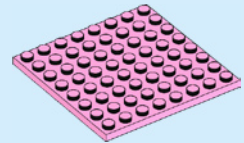

2x
6440846

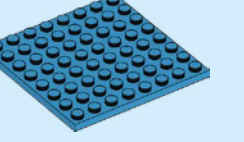

1x
6383008

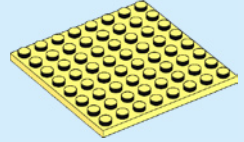

2x
6395810

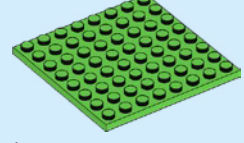

1x
6396549



[LEGO.com/service](https://www.LEGO.com/service)

YOU COULD **WIN**



Scan this QR code or go to **LEGO.COM/PRODUCTFEEDBACK** and give us your short feedback about this LEGO® set for a chance to win a cool LEGO prize.

Terms and Conditions apply*

EN: YOU COULD WIN. Terms and Conditions apply* **DE: Du könntest GEWINNEN.** Es gelten die Teilnahmebedingungen* **FR: Tu pourrais GAGNER.** Des conditions s'appliquent* **IT: Potresti VINCERE tu.** Termini e condizioni sono applicabili* **ES: Puedes GANAR.** Aplican términos y condiciones* **PT: Poderá GANHAR.** Aplicam-se termos e condições* **ZH: 轻松获奖. 条款和条件适用*** **PL: Szansa na WYGRANĄ.** Obowiązują warunki korzystania* **CS: Máte šanci VYHRÁT.** Platí všeobecné smluvní podmínky* **SK: Máte šancu VYHRAŤ.** Platia všeobecné zmluvné podmienky* **HU: TE IS NYERHETSZ.** Felhasználási feltételek érvényesek* **RO: Ai putea CÂȘTIGA.** Se aplică termeni și condiții* **BG: Можете да СПЕЧЕЛИТЕ.** Има определени правила и условия* **LV: Tu vari LAIMĒT.** Ir spēkā noteikumi un nosacījumi.* **ET: Sul on võimalus VÕITA.** Kehtivad tingimused* **LT: Jūs galite LAIMĖTI.** Taikomos sąlygos*

*[LEGO.com/productfeedback-terms](https://www.lego.com/productfeedback-terms)

LEGO and the LEGO logo are trademarks of the/son des marques de commerce du/son marcas registradas de LEGO Group. ©2023 The LEGO Group. ©Disney