



CREATOR

7-12

4894 - 1



Ideas



Instructions





Quick Build
 Schnellbaumodelle
 Construction rapide
 Costruzione rapida
 Snel bouwen
 Construcción rápida
 Byg hurtigt
 Nopeaan rakentamiseen
 Bygg snabbt
 Construção Rápida
 Γρήγορες Κατασκευές
 Klérlétezőknek



3



22

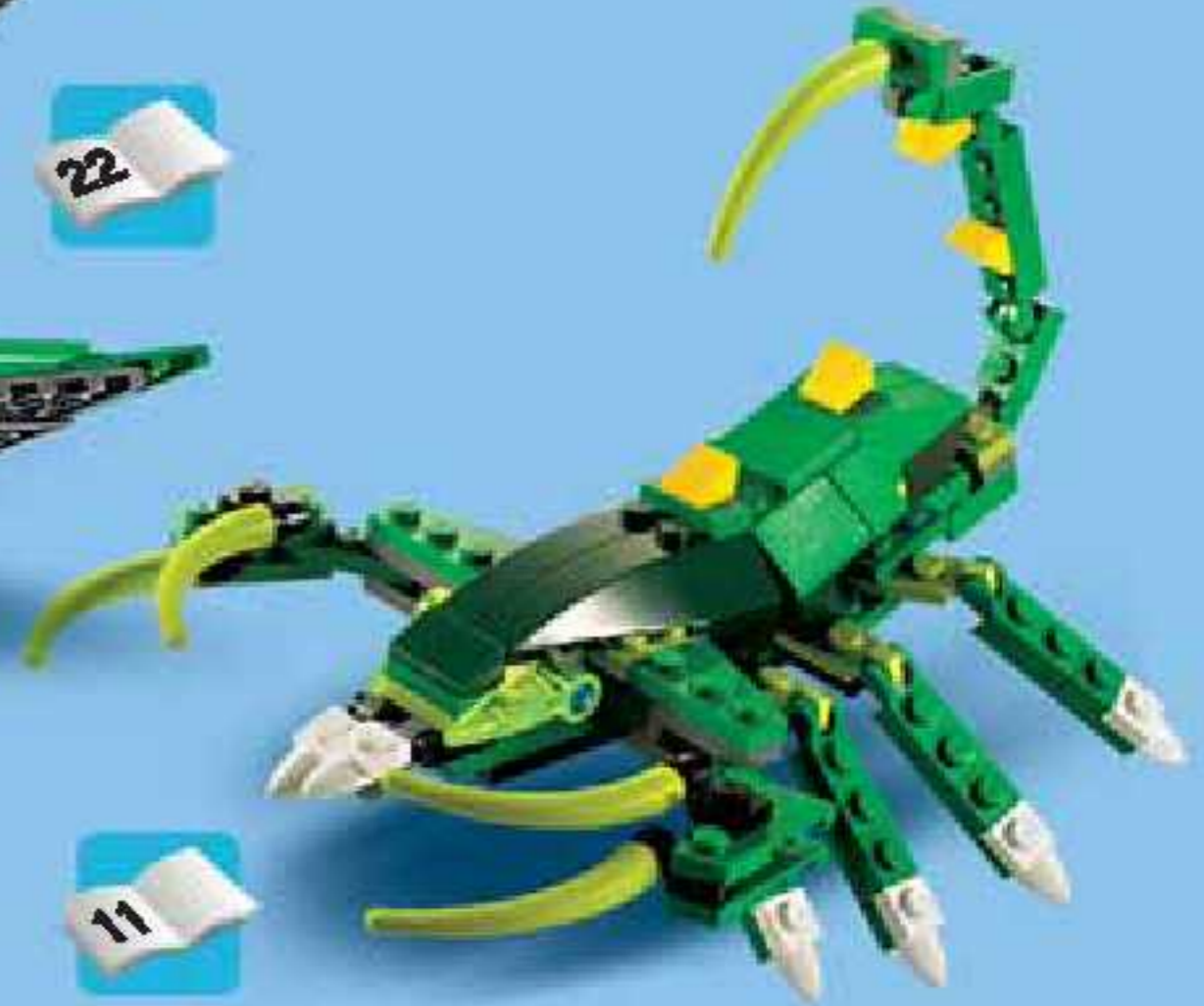

11



Experienced Build
 Könnnermodelle
 Construction normale
 Costruzione esperta
 Bouwen voor gevorderden
 Construcción experta
 Byg videre
 Kokonoeille rakentajalle
 Bygg mer
 Construção para Experimentados
 Επιδύσεις Κατασκευές
 Haladóknak



A2



28



69

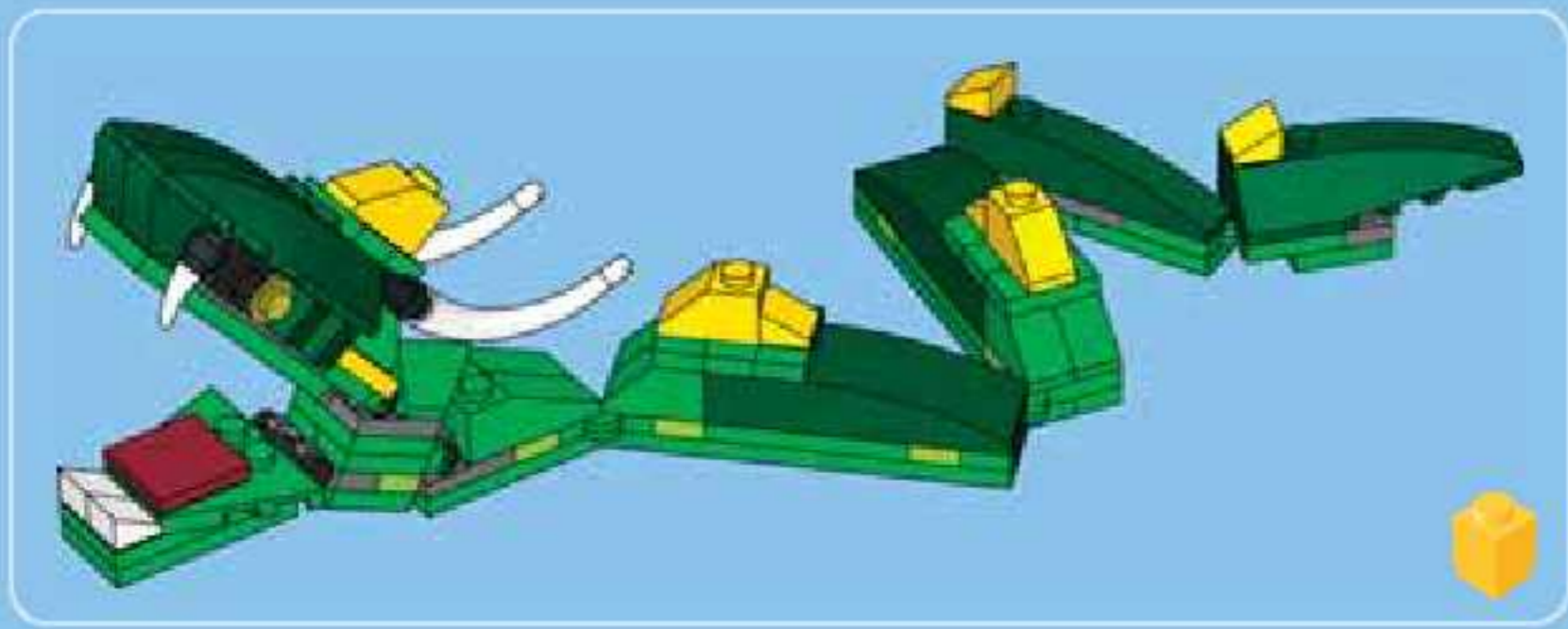

1

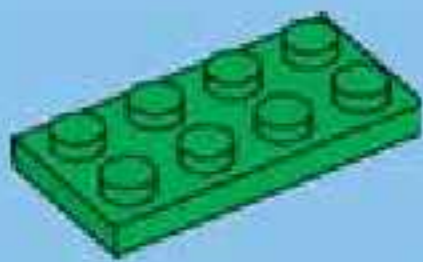

2

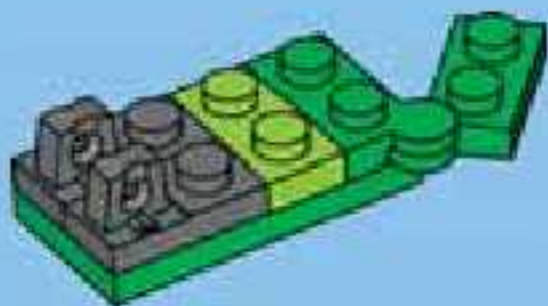

3

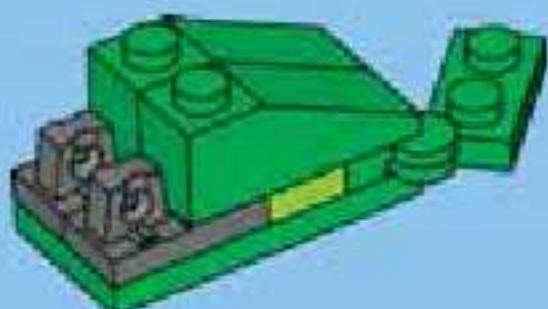

4

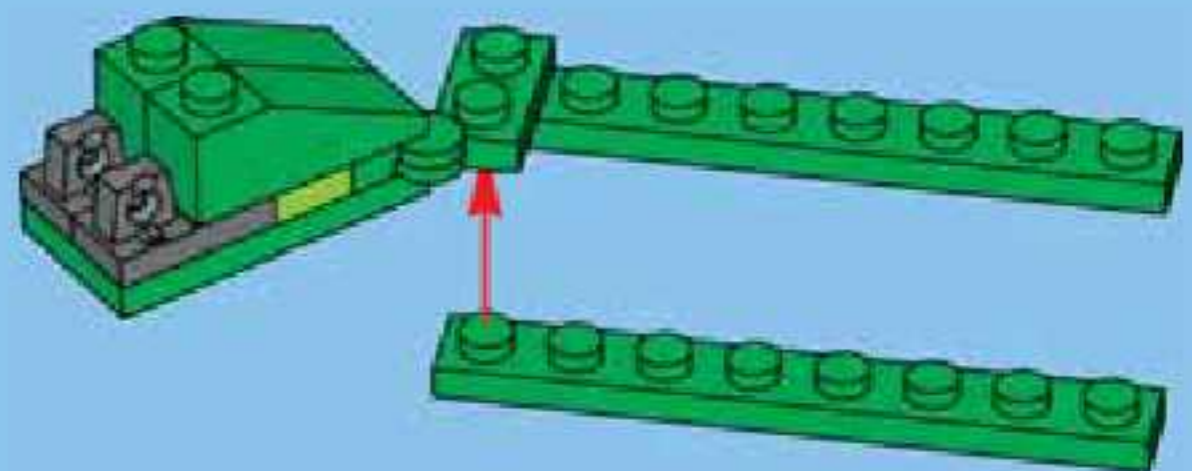

5

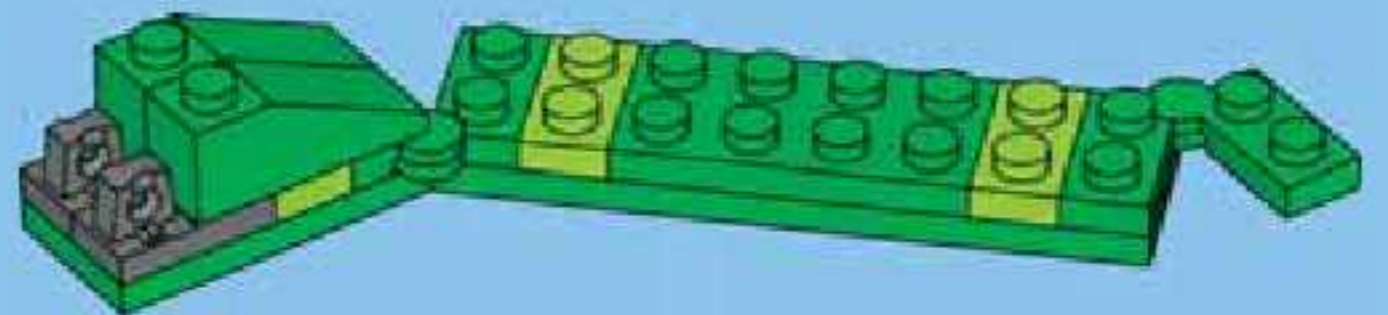

6

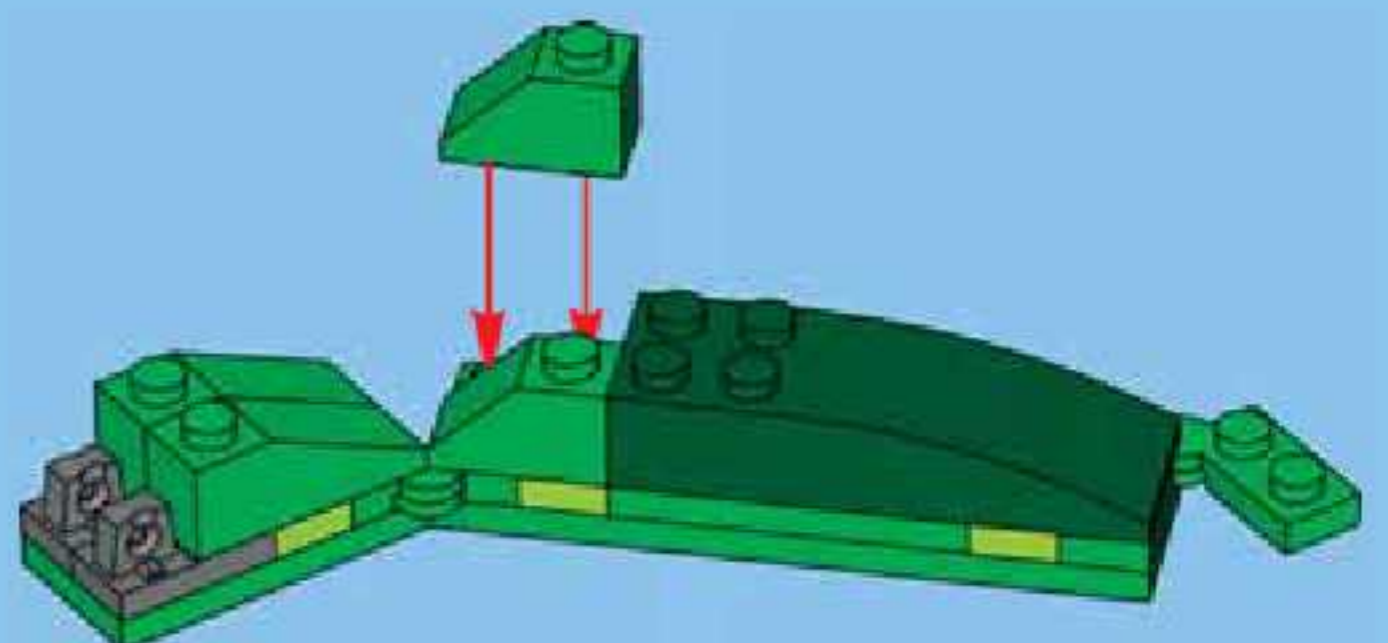

7

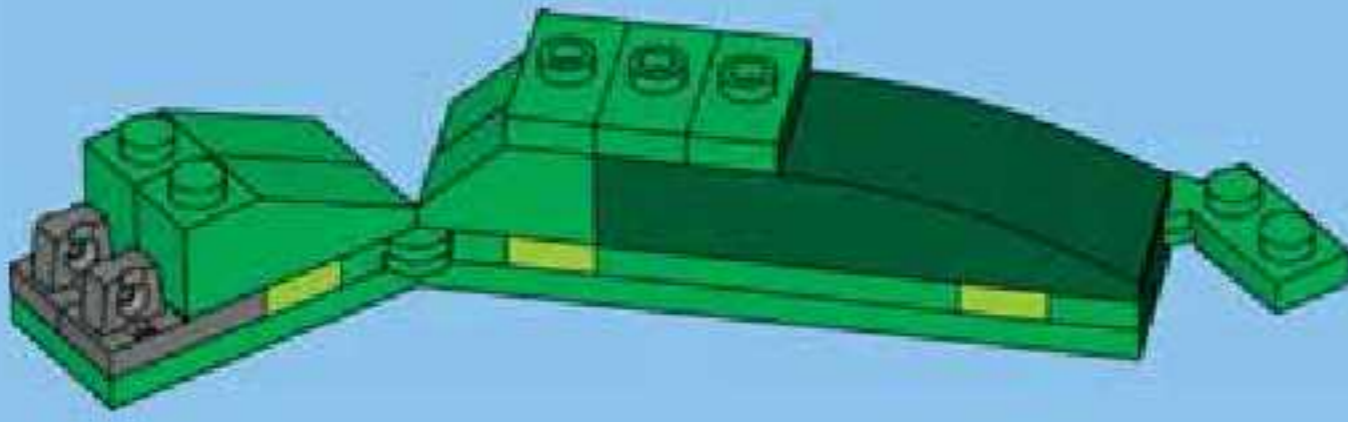

8

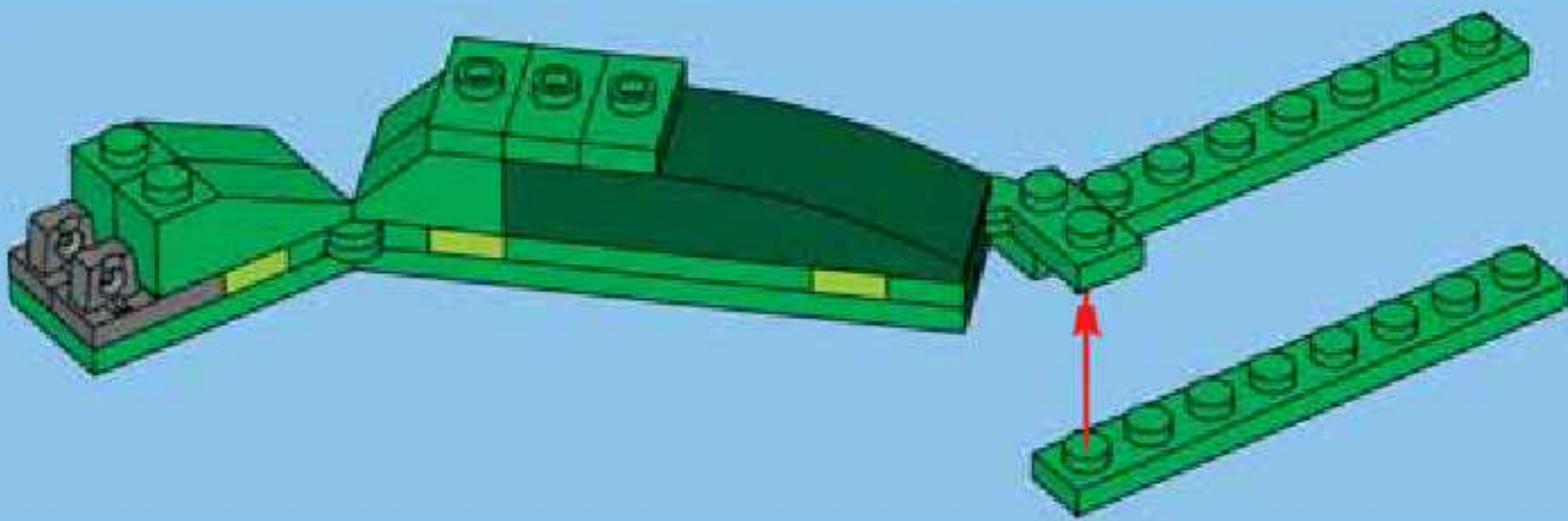

9

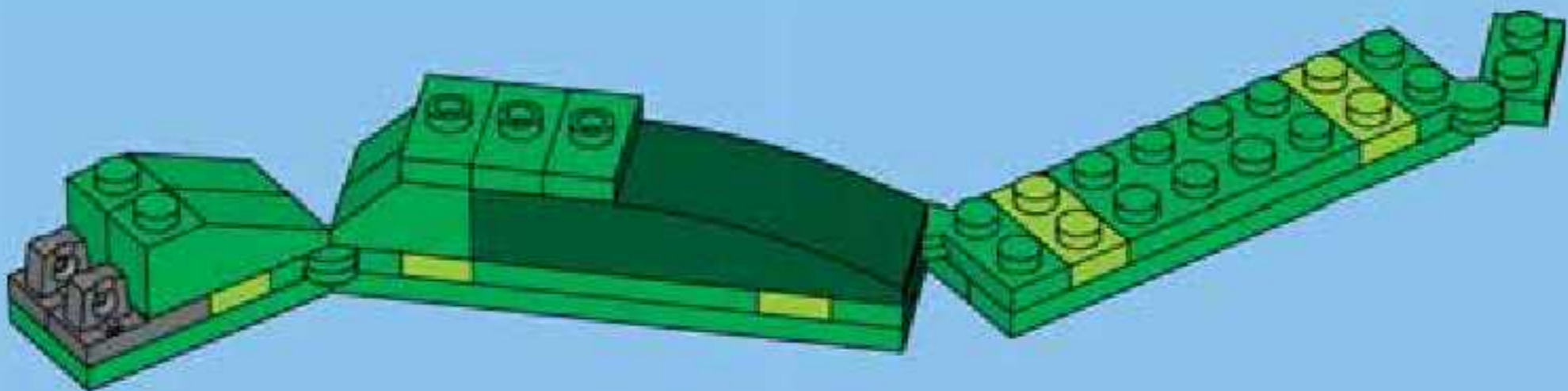

10

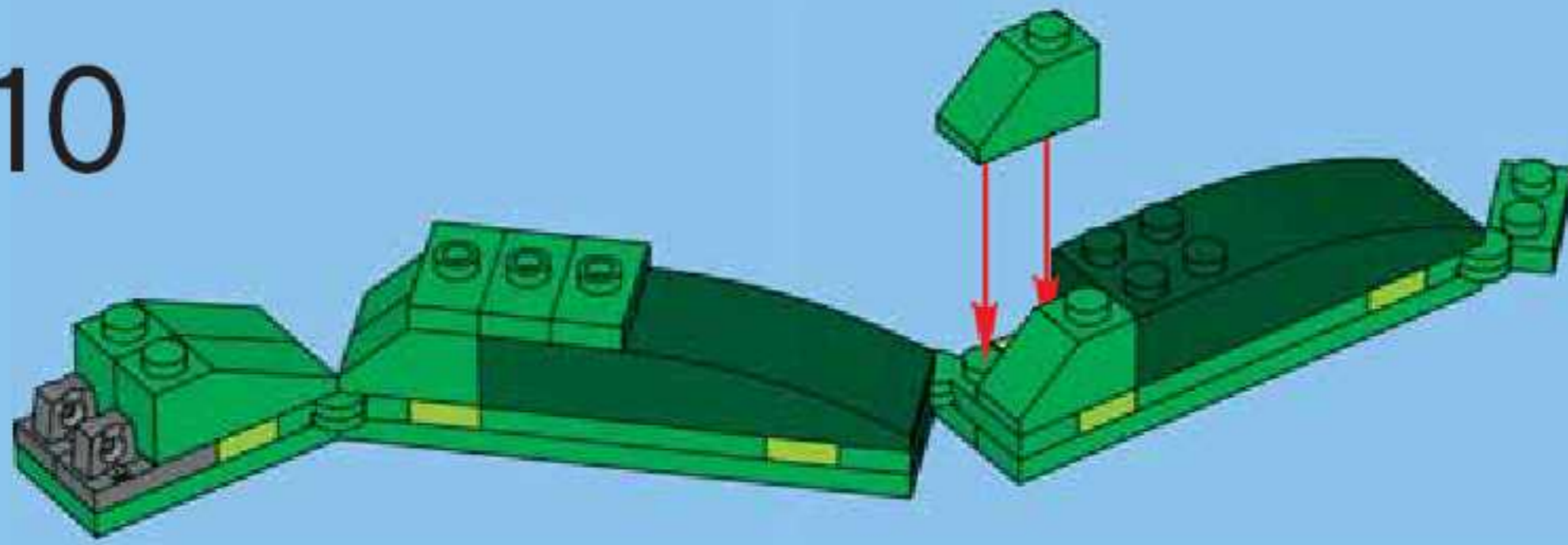

11

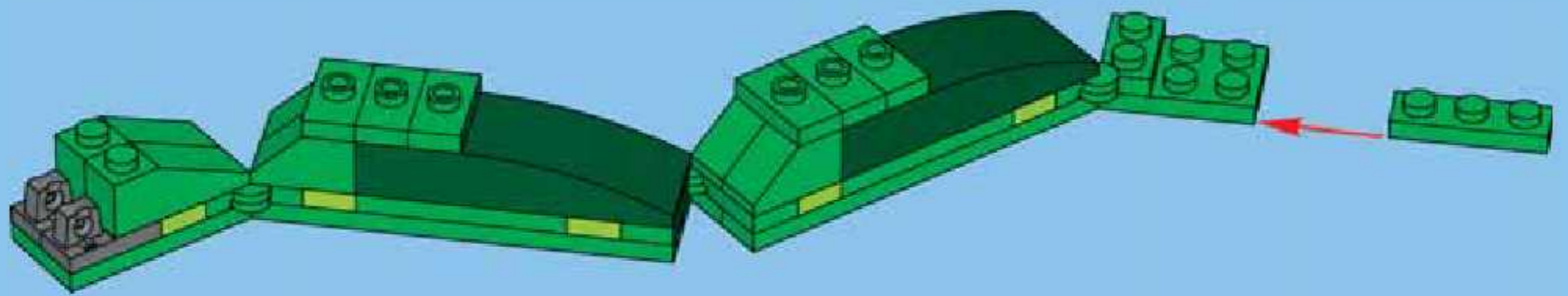

12

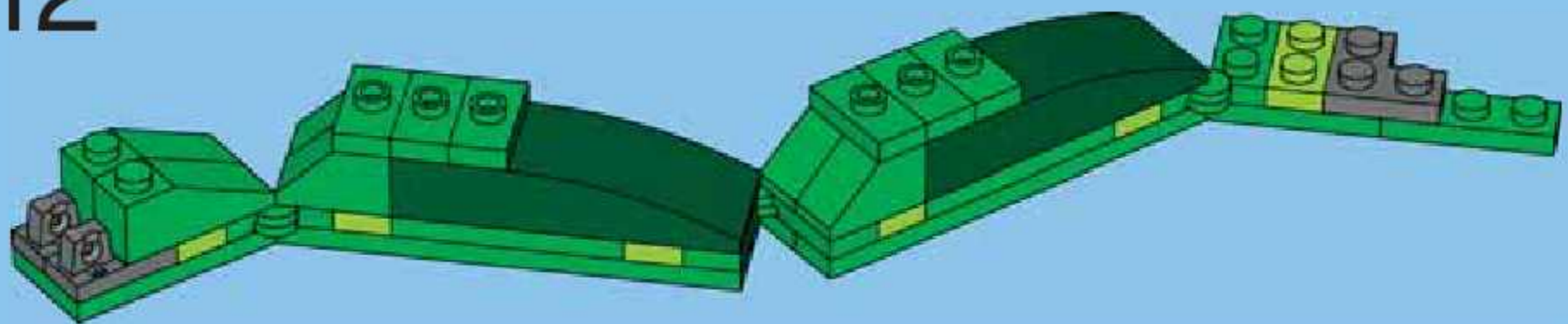

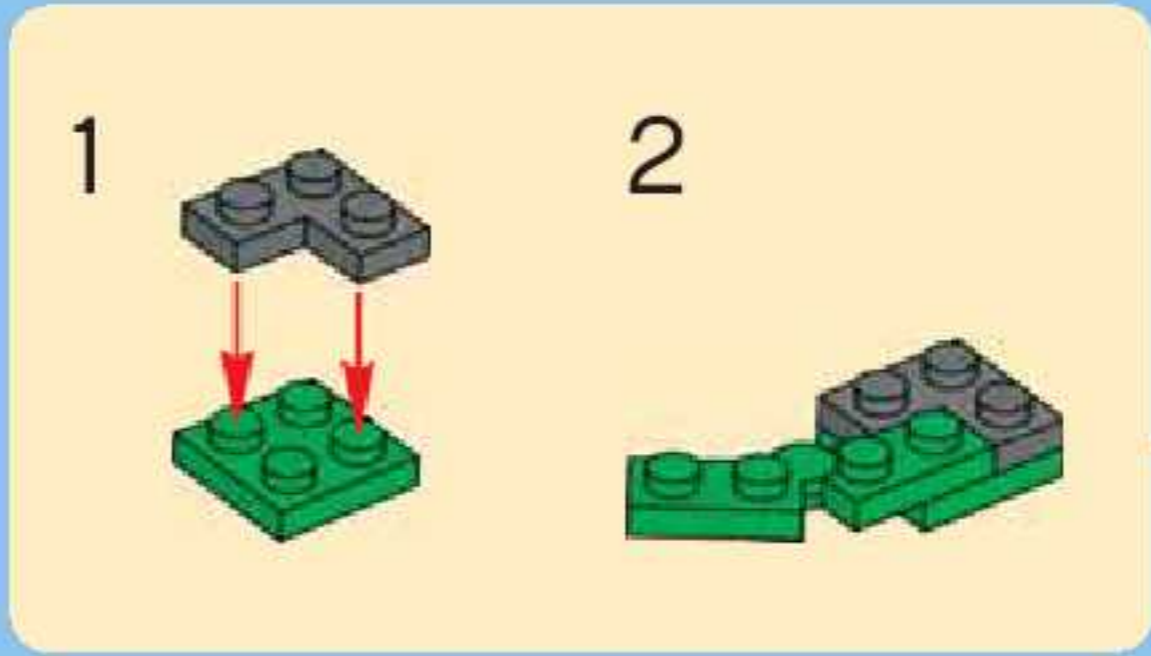

13

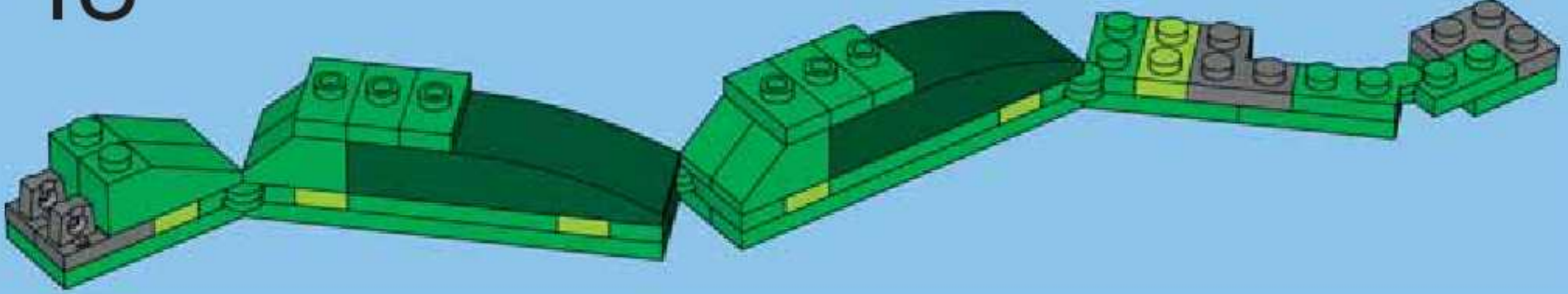

14

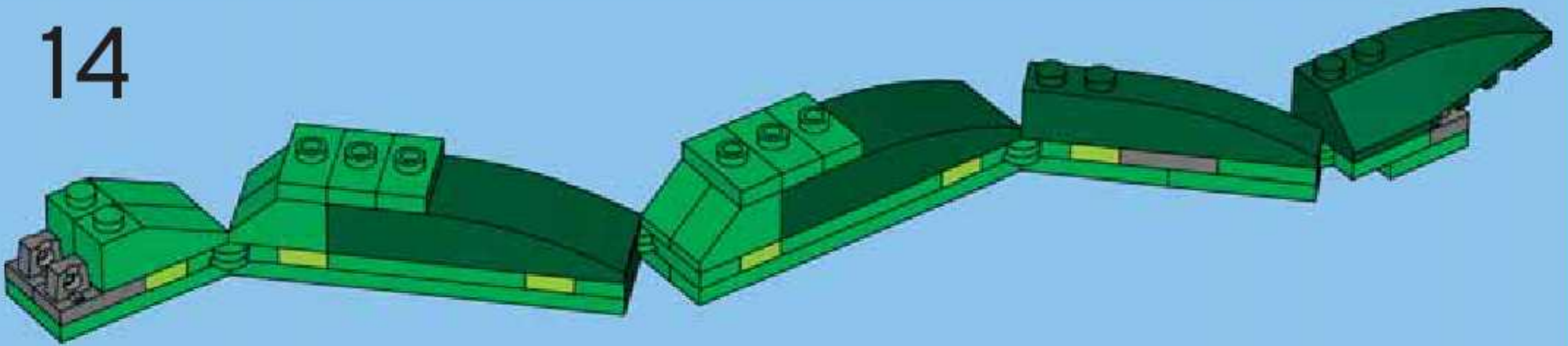

15

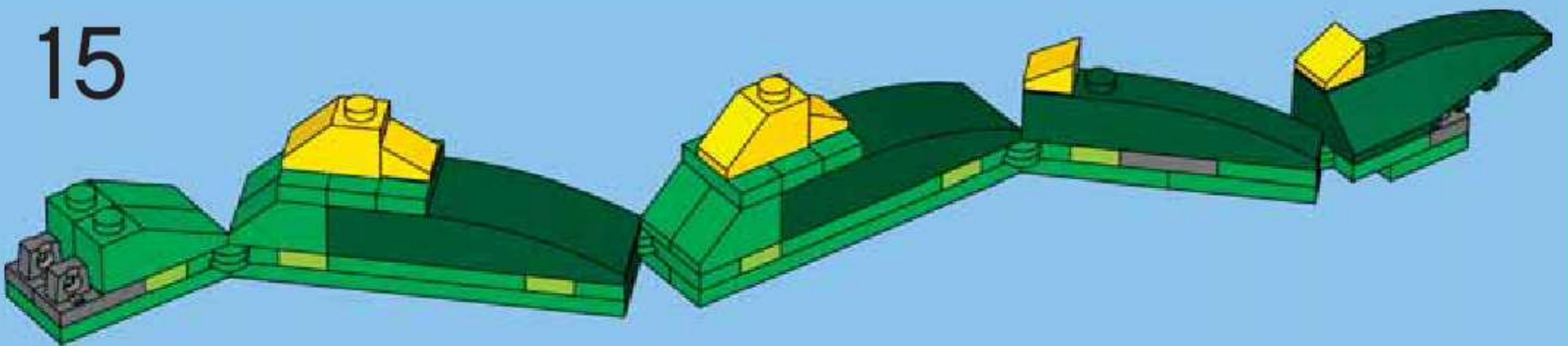

1



4



2



5



3

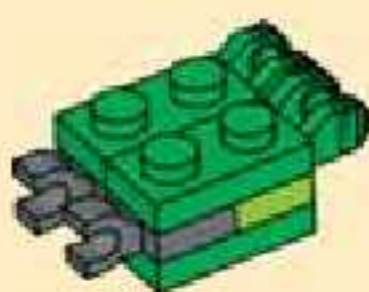

6

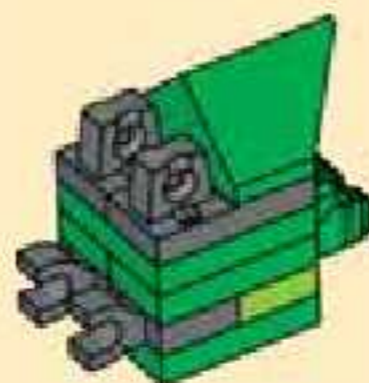

16

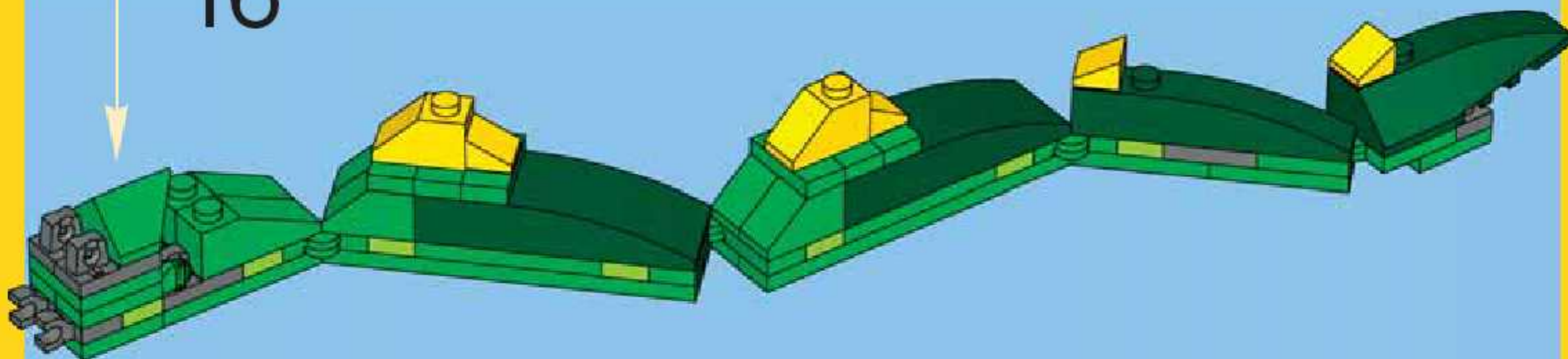

1

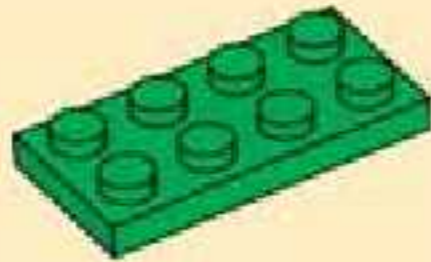

2

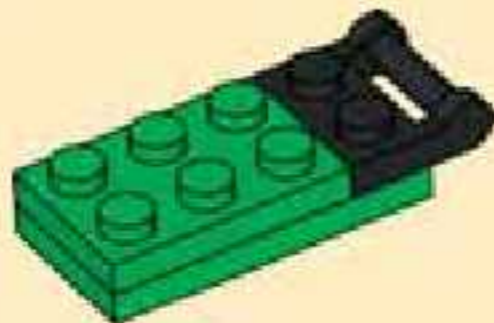

3

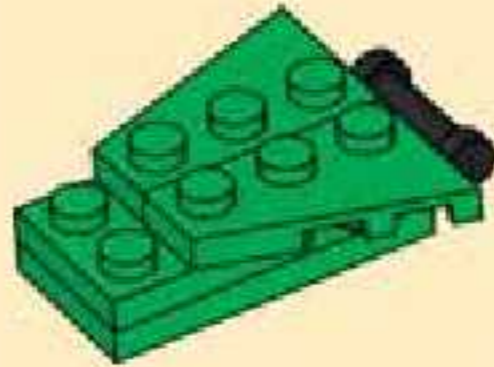

4

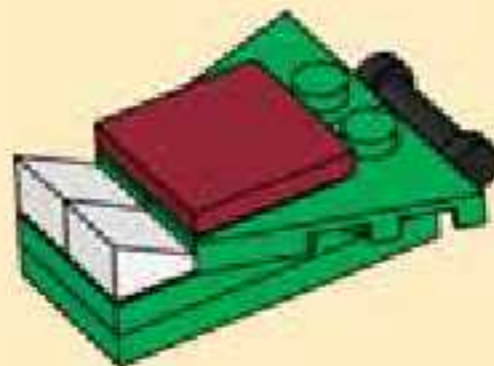

17

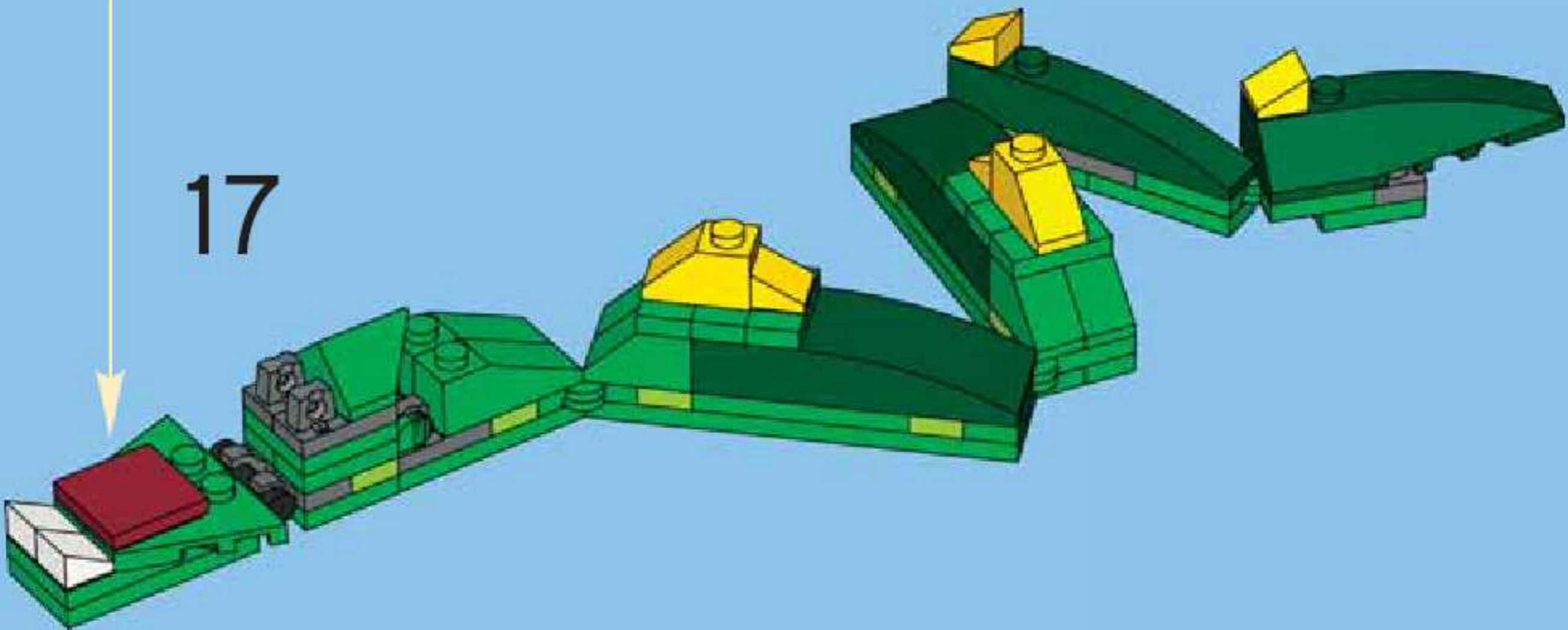

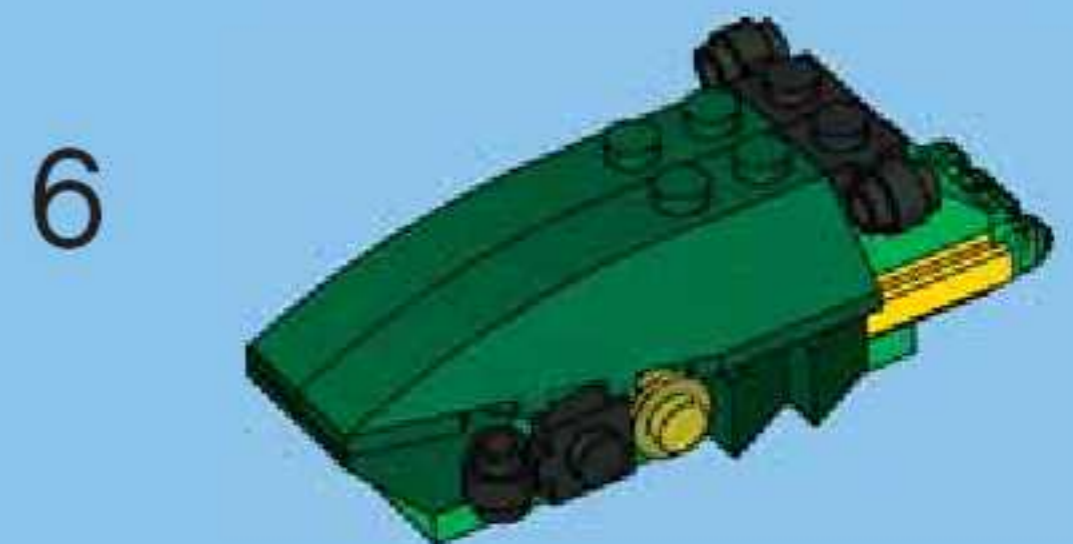
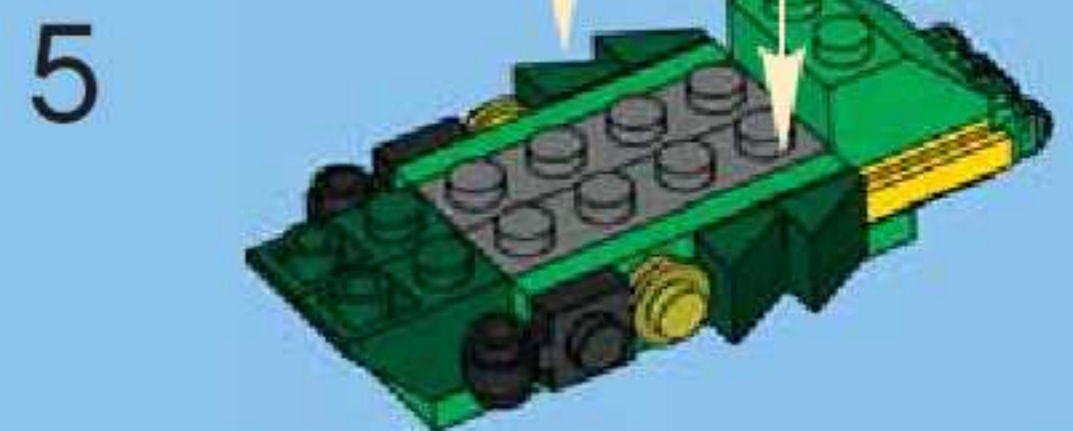
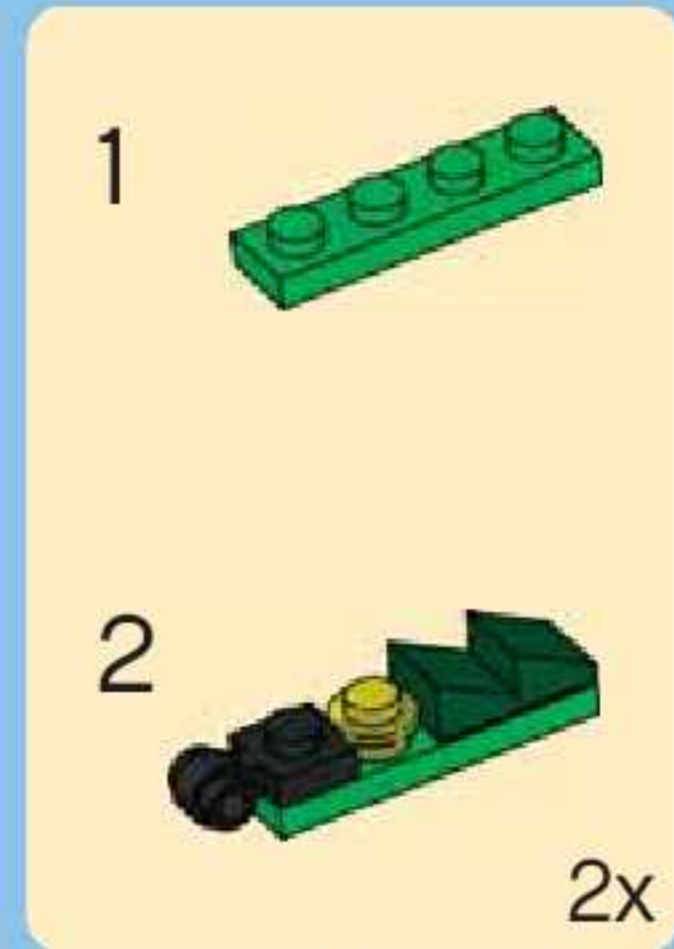
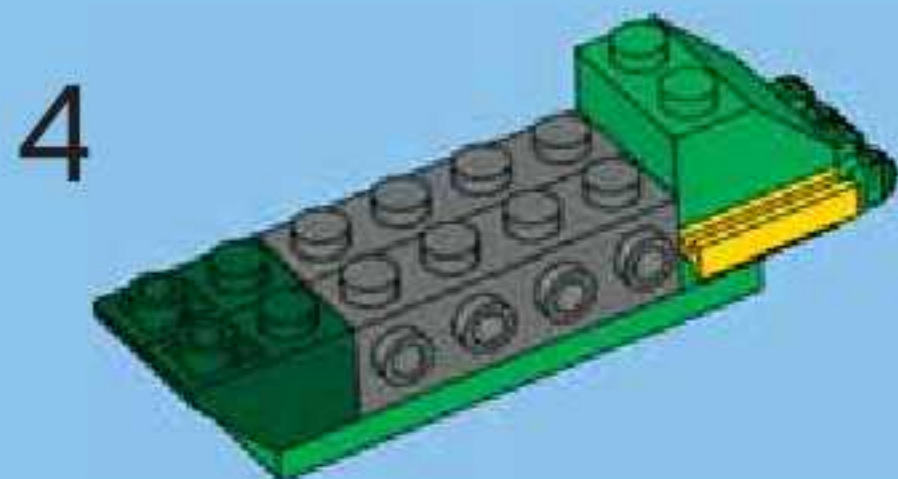
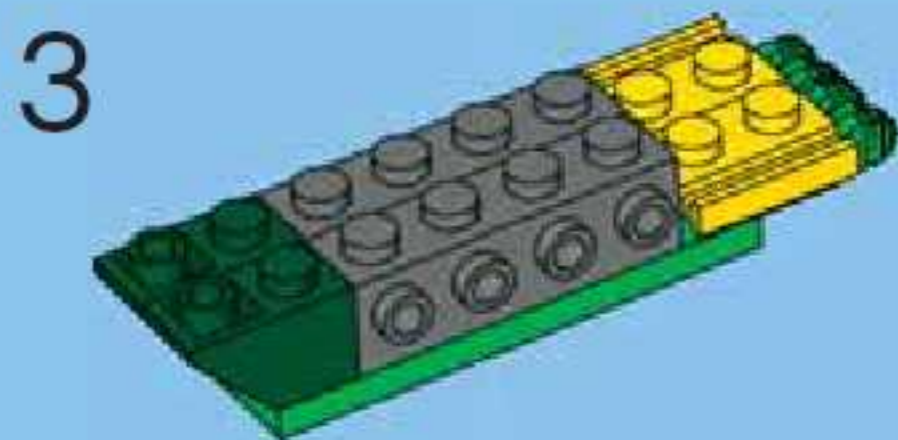
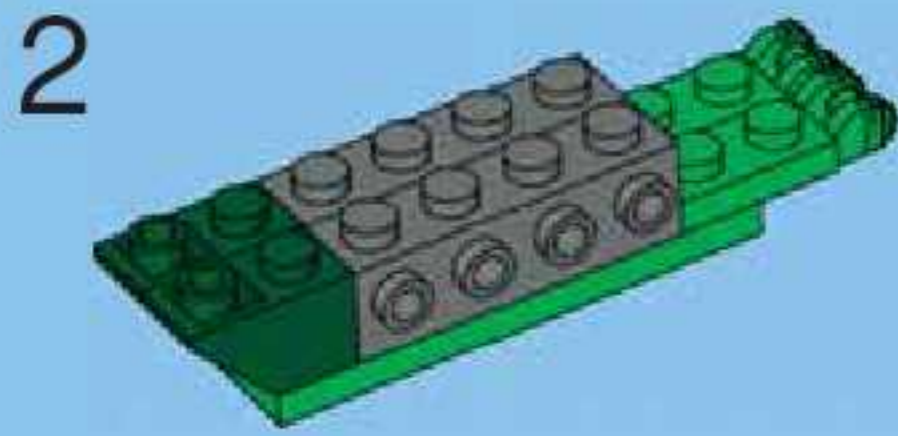
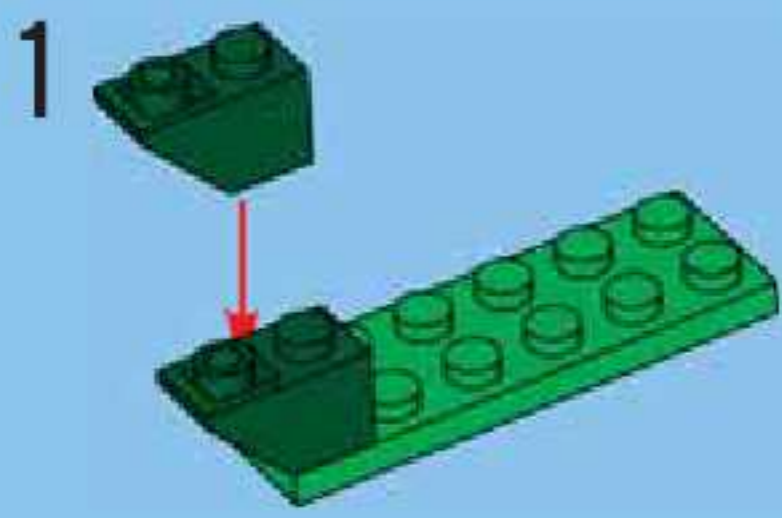

7

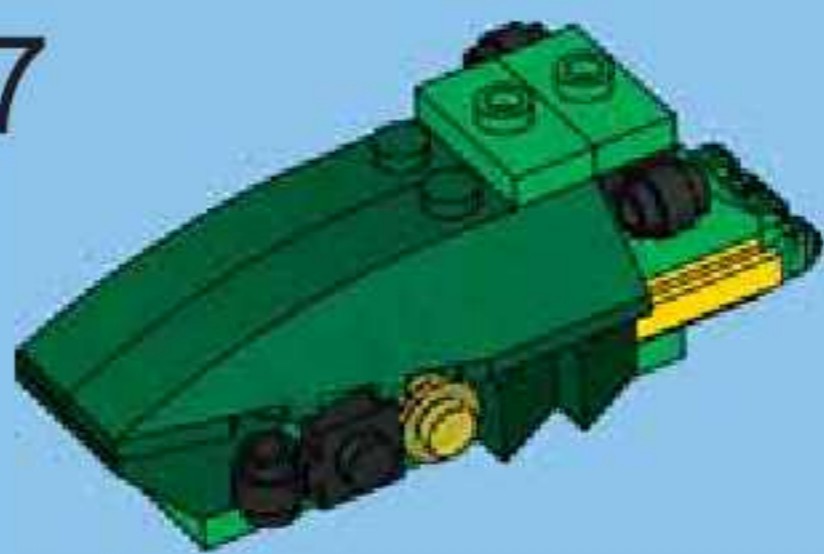

8

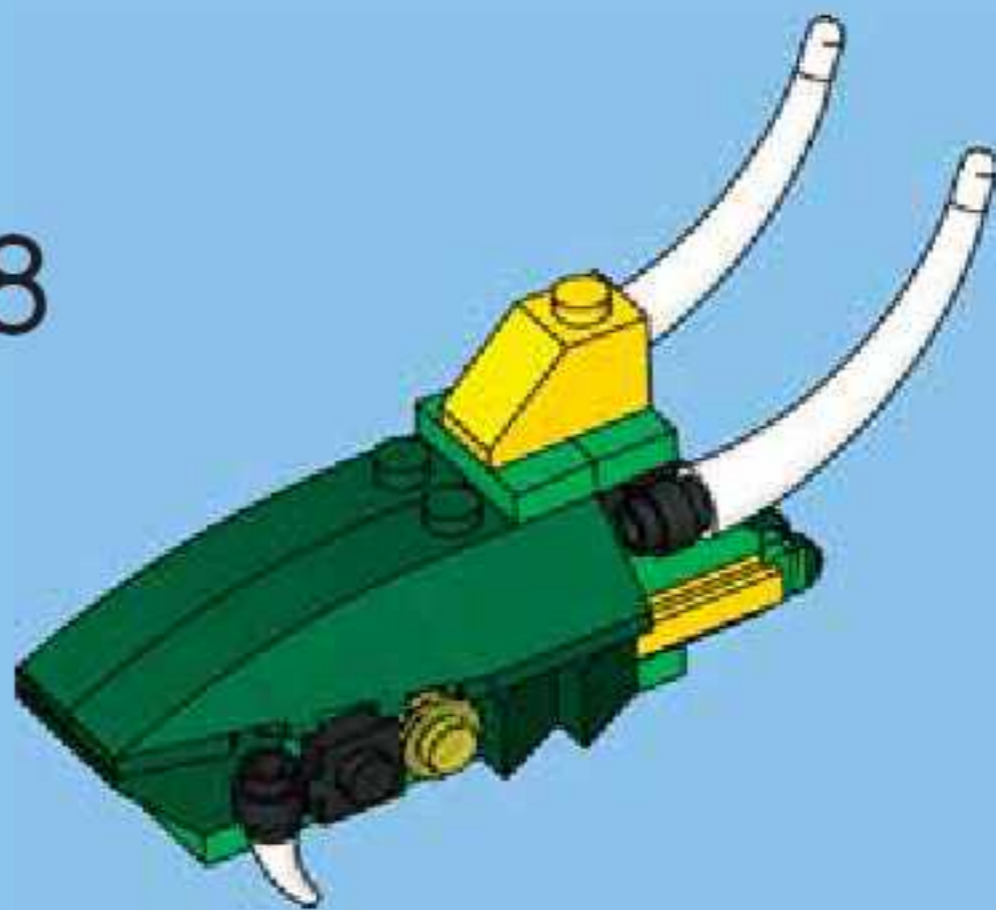

18

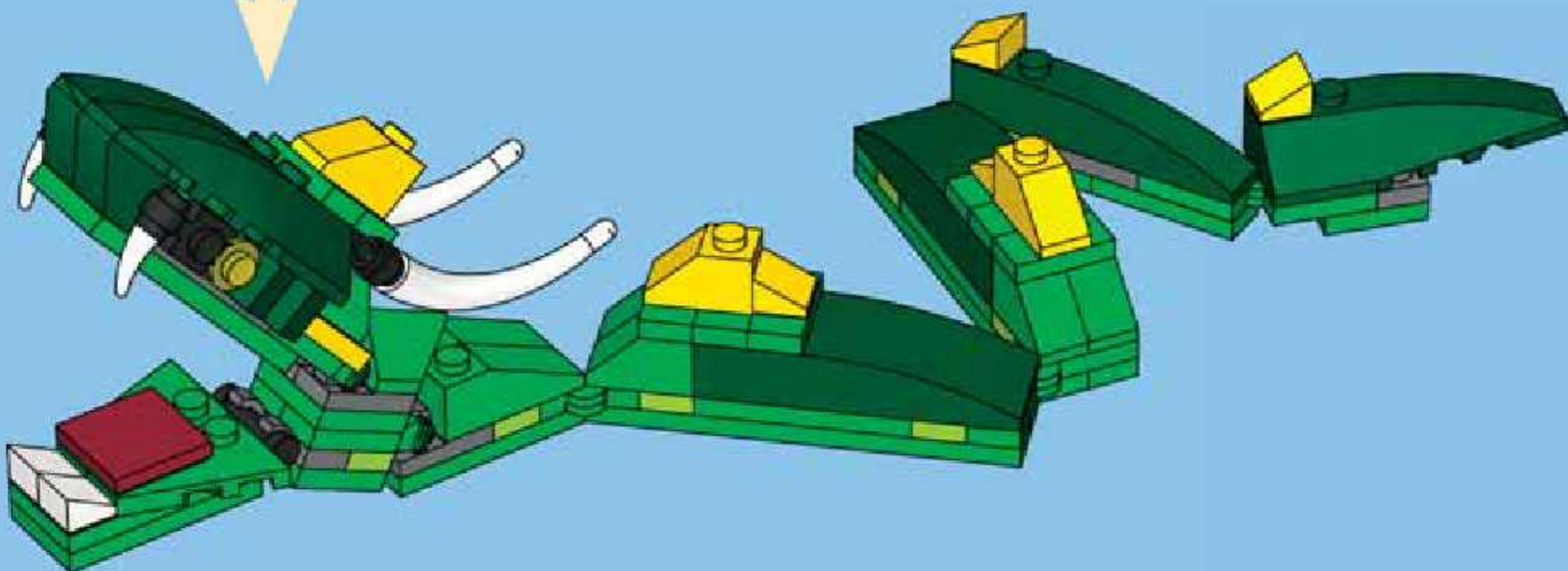



1



2



3

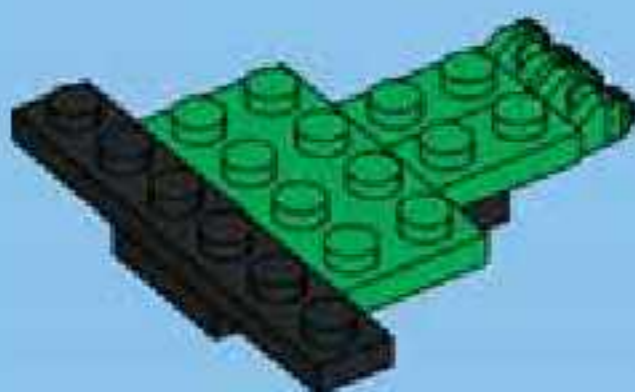

4



5

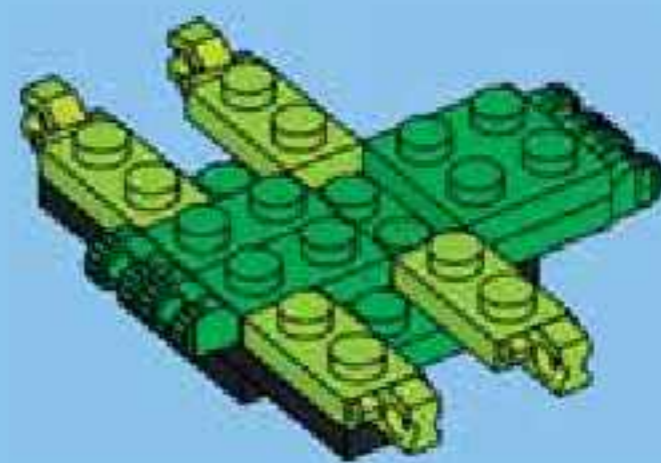

6

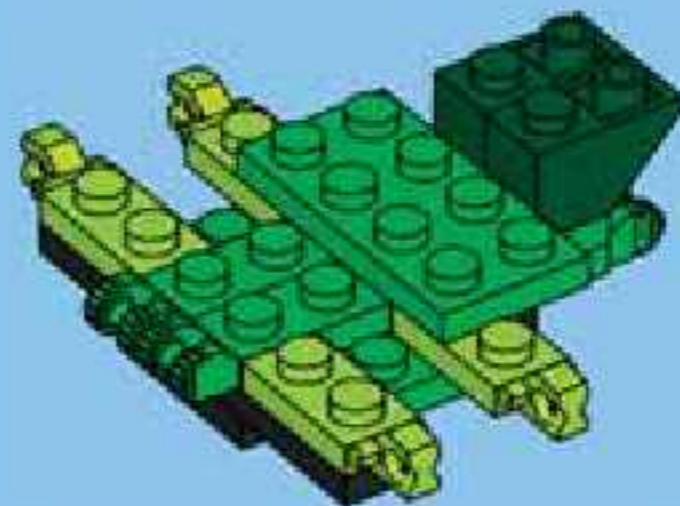

7

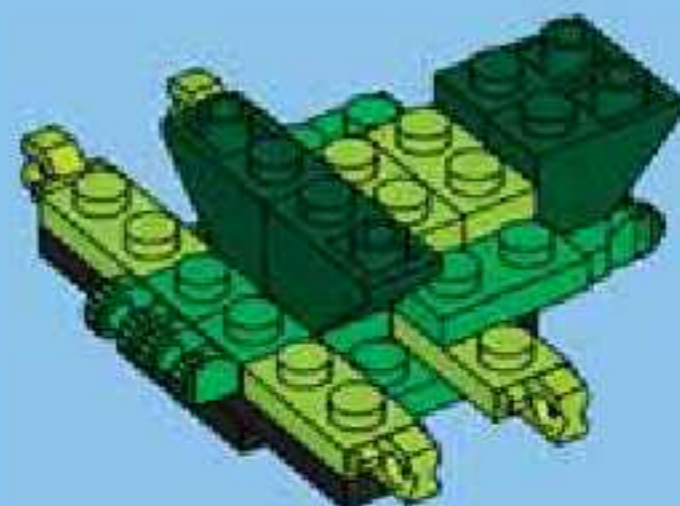

8

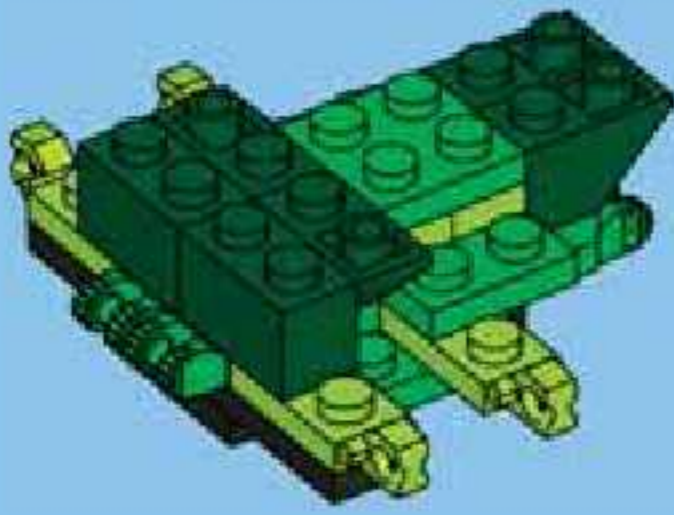

9

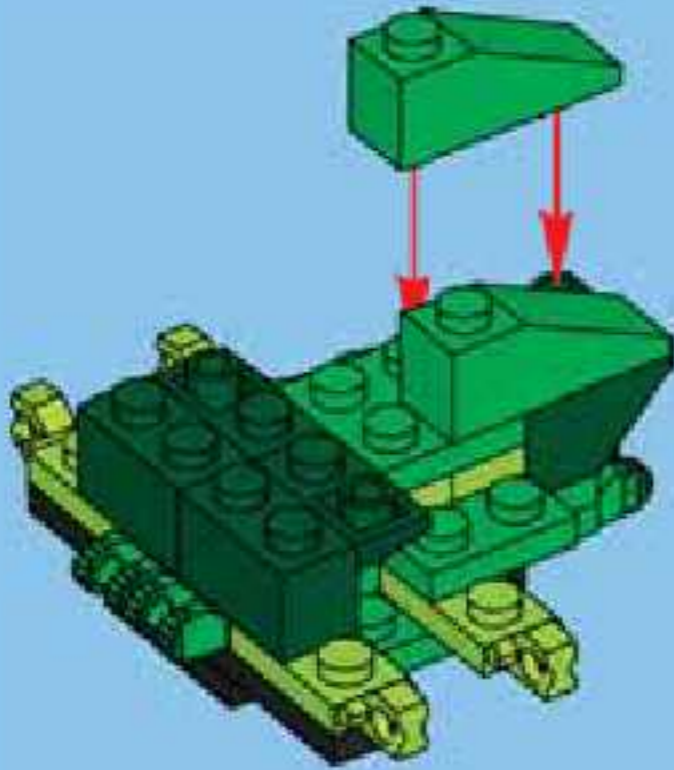

10

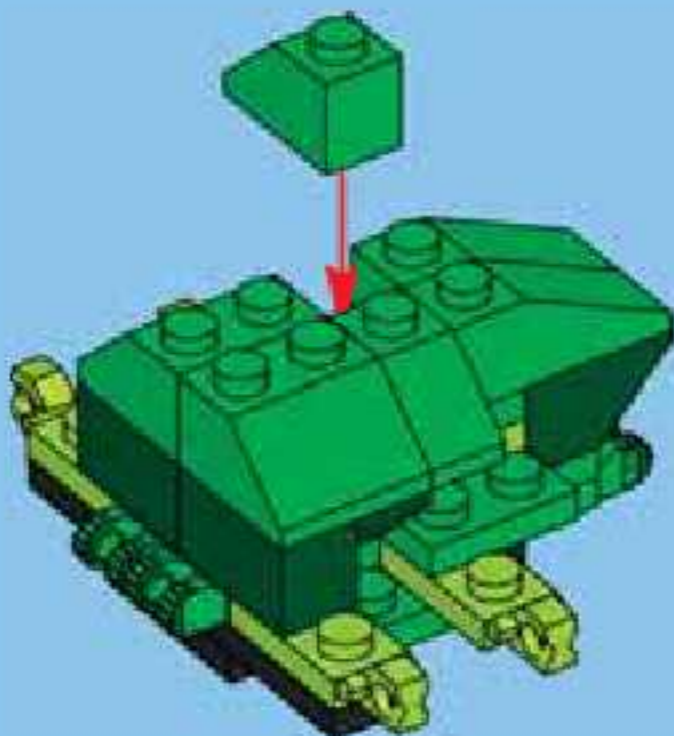

11

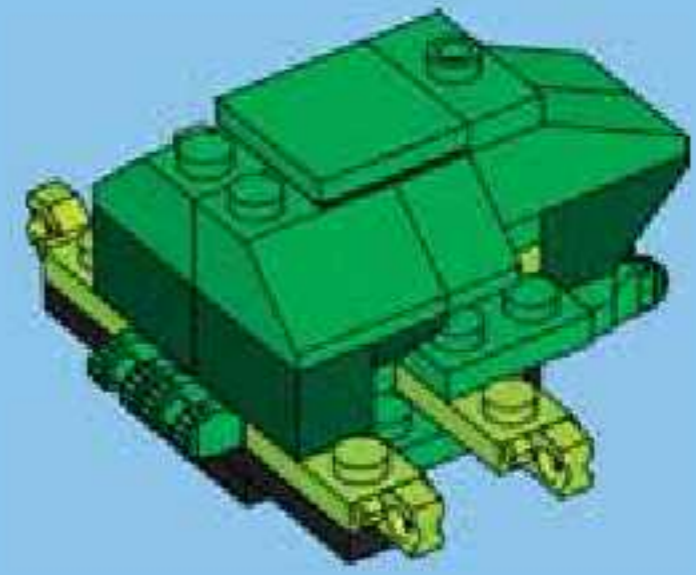

1



2

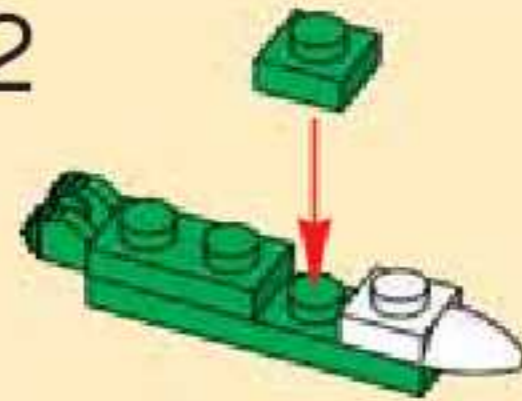

4x

12

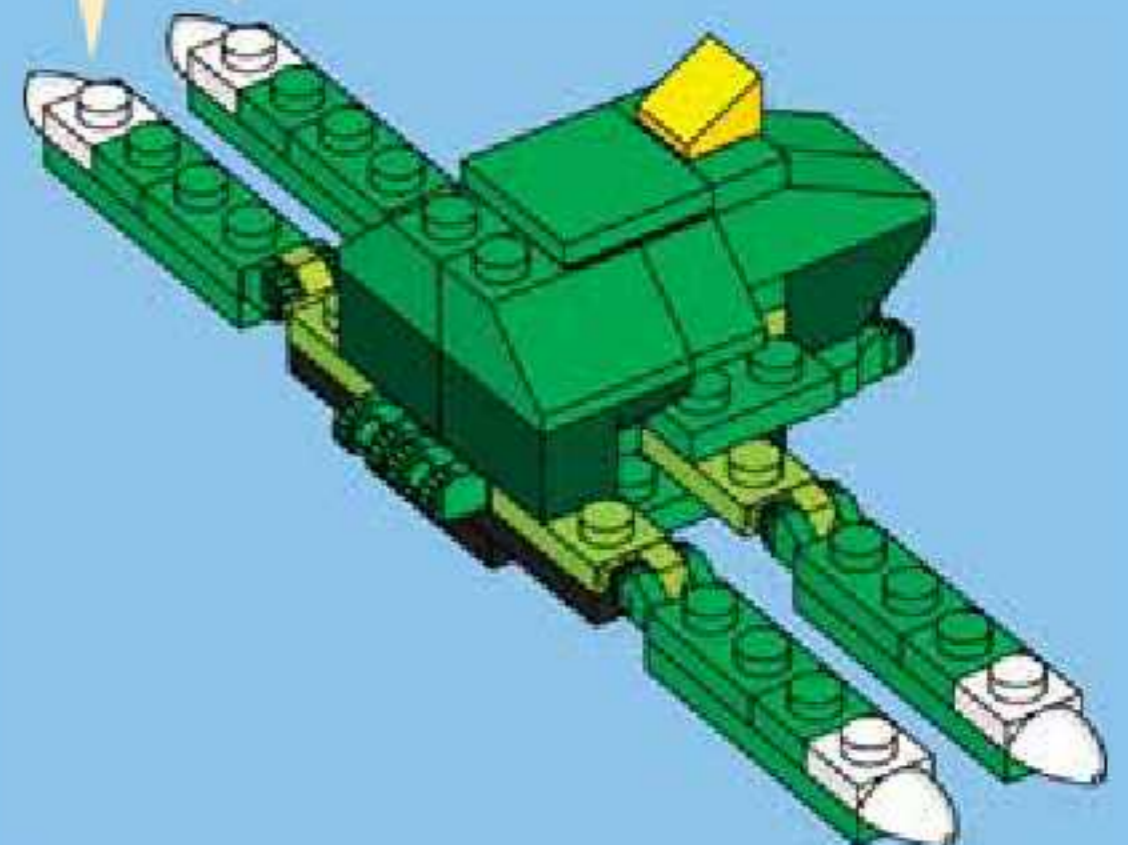

1



2



3

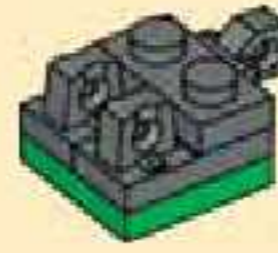

4



13

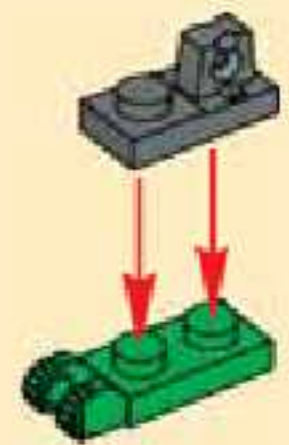
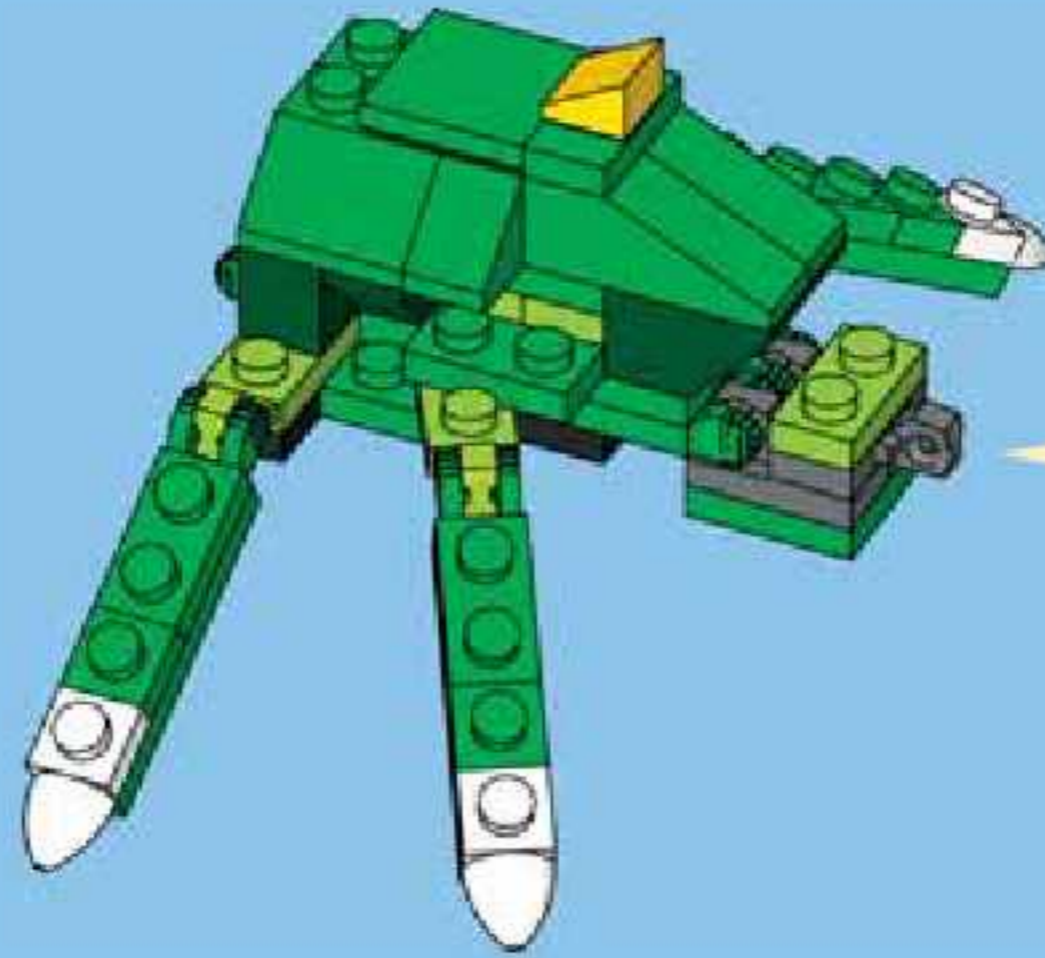

14

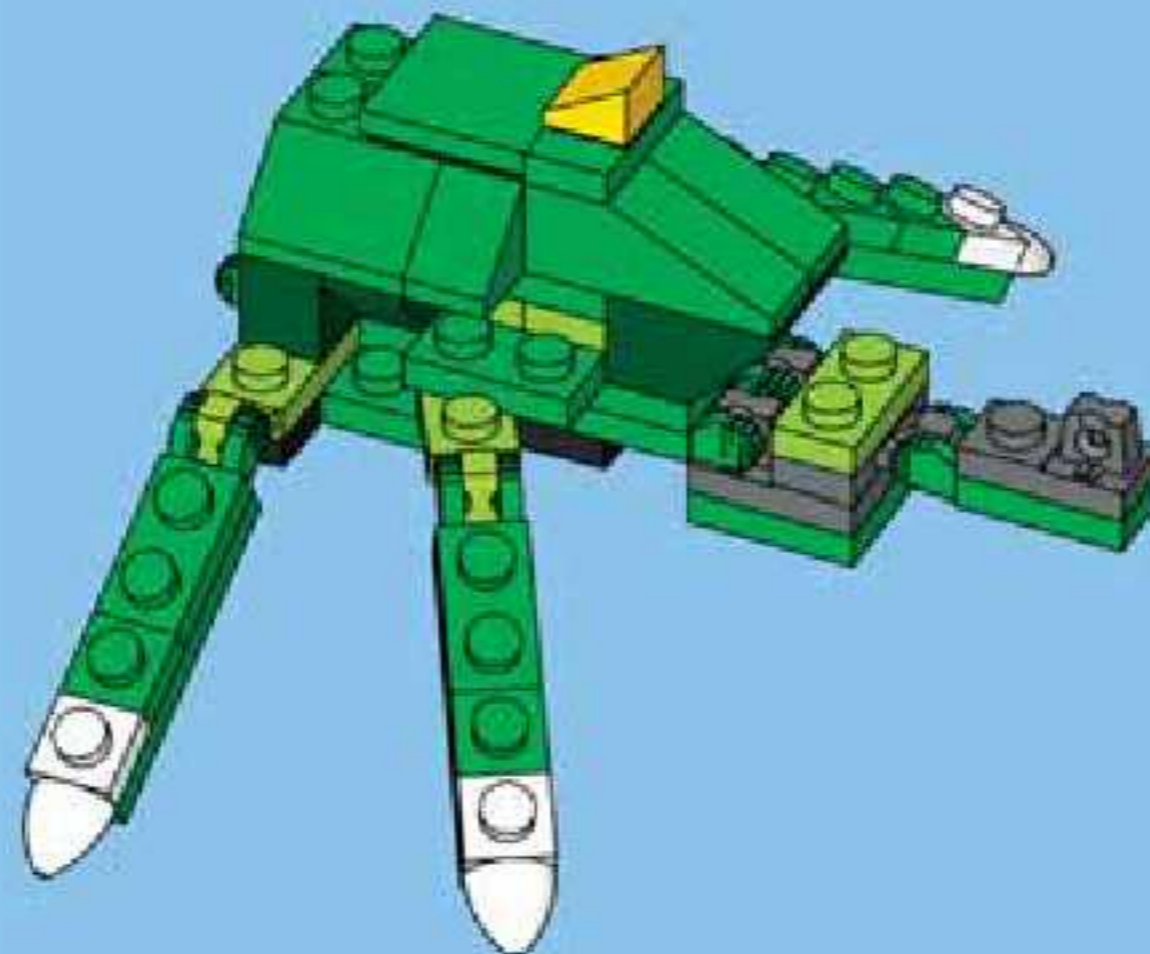

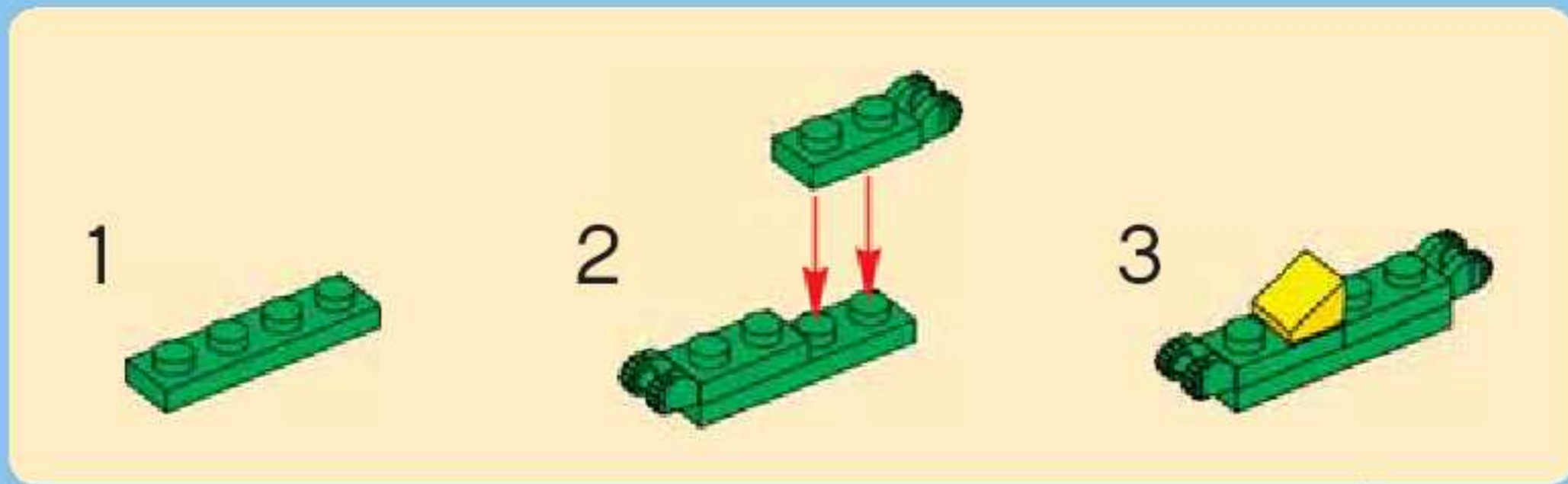

15

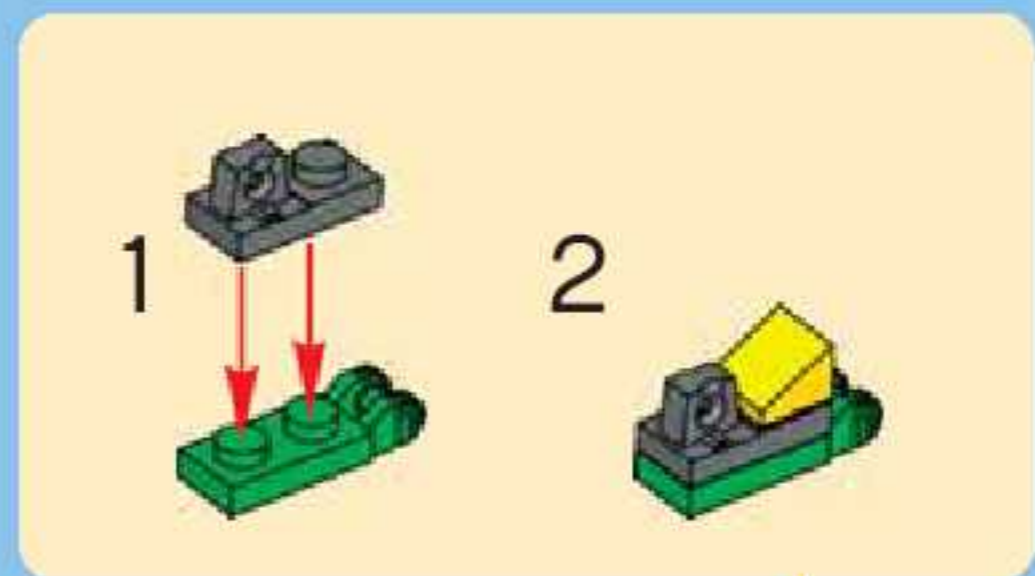
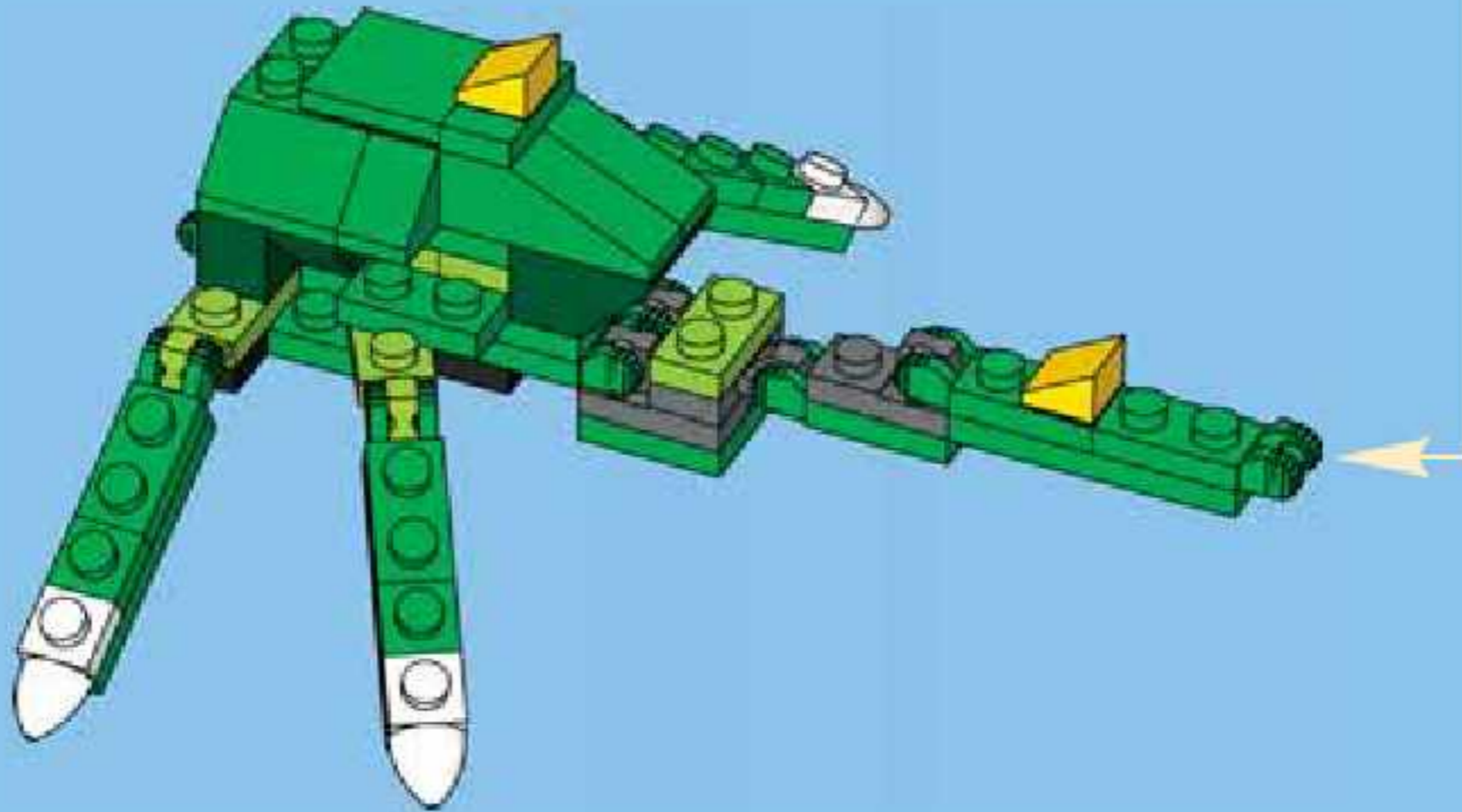

16

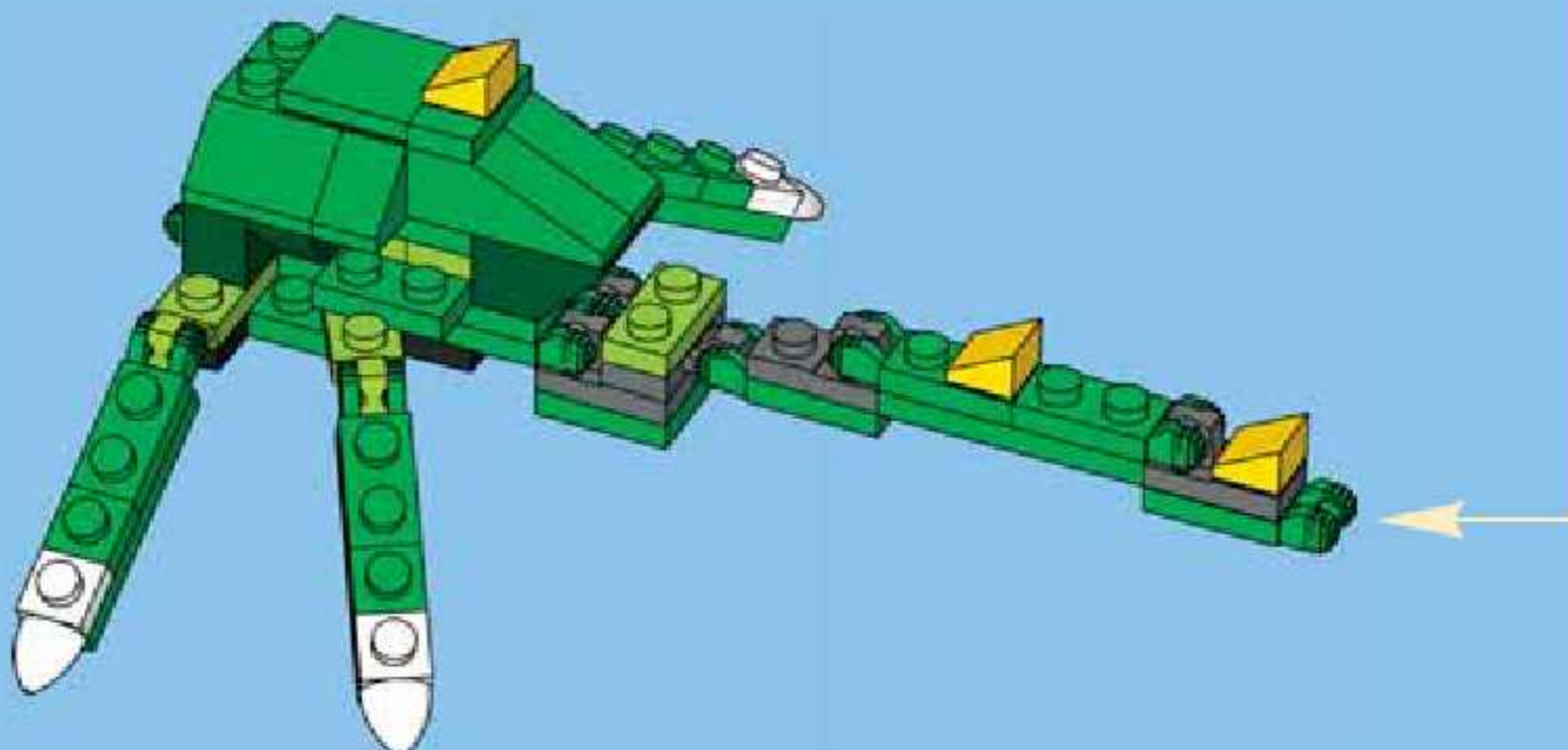

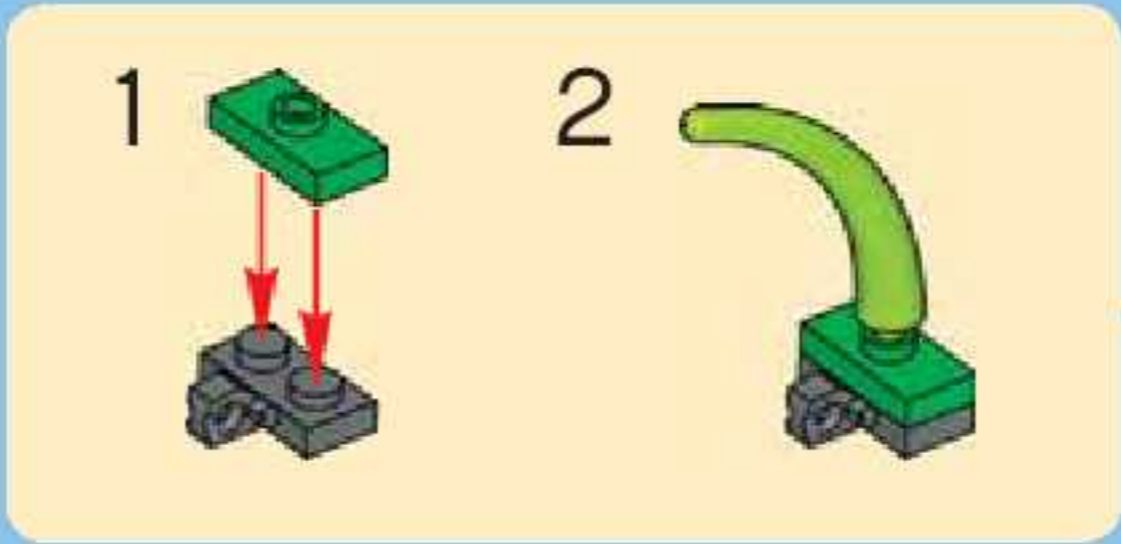

17

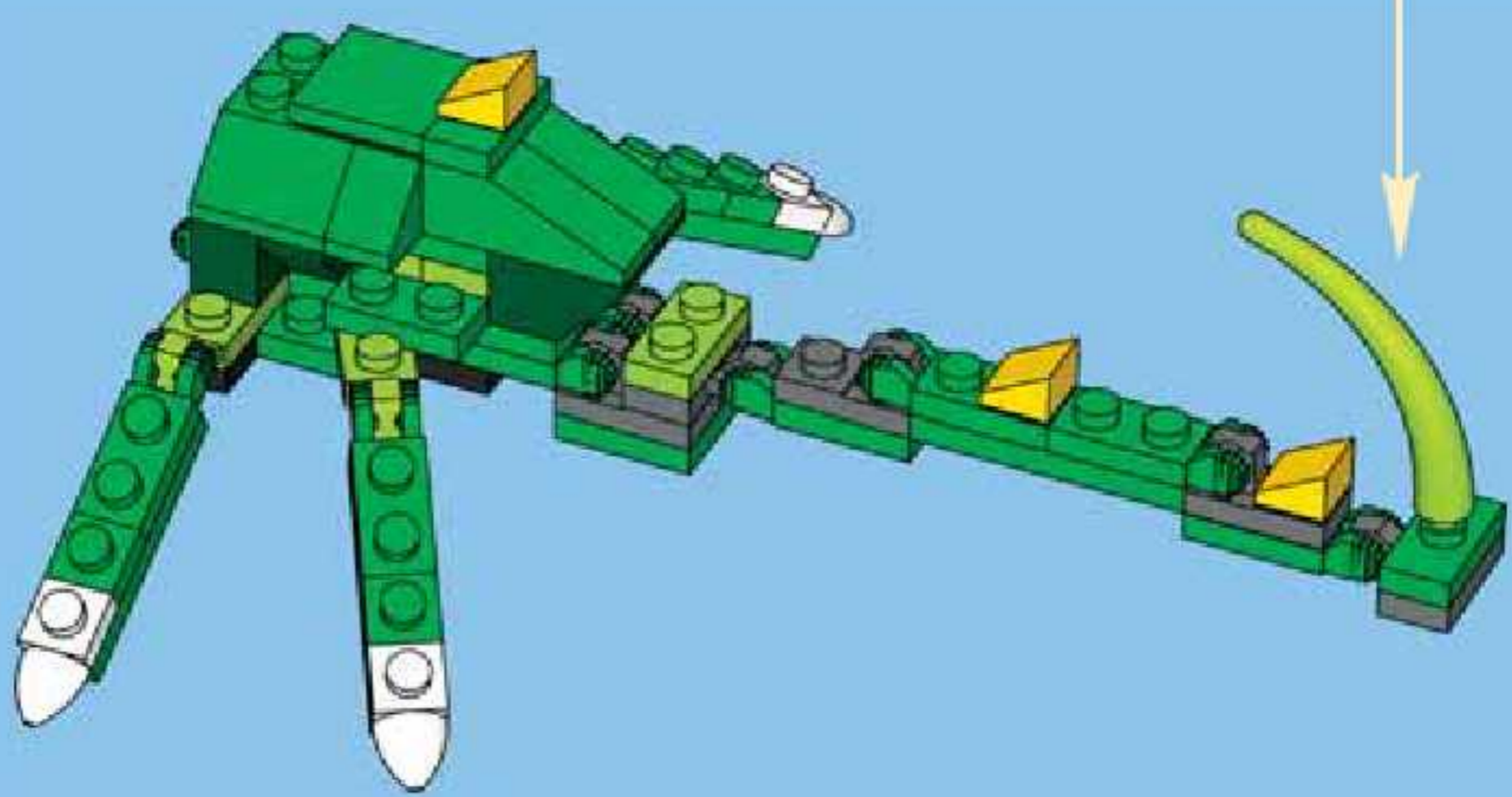

18

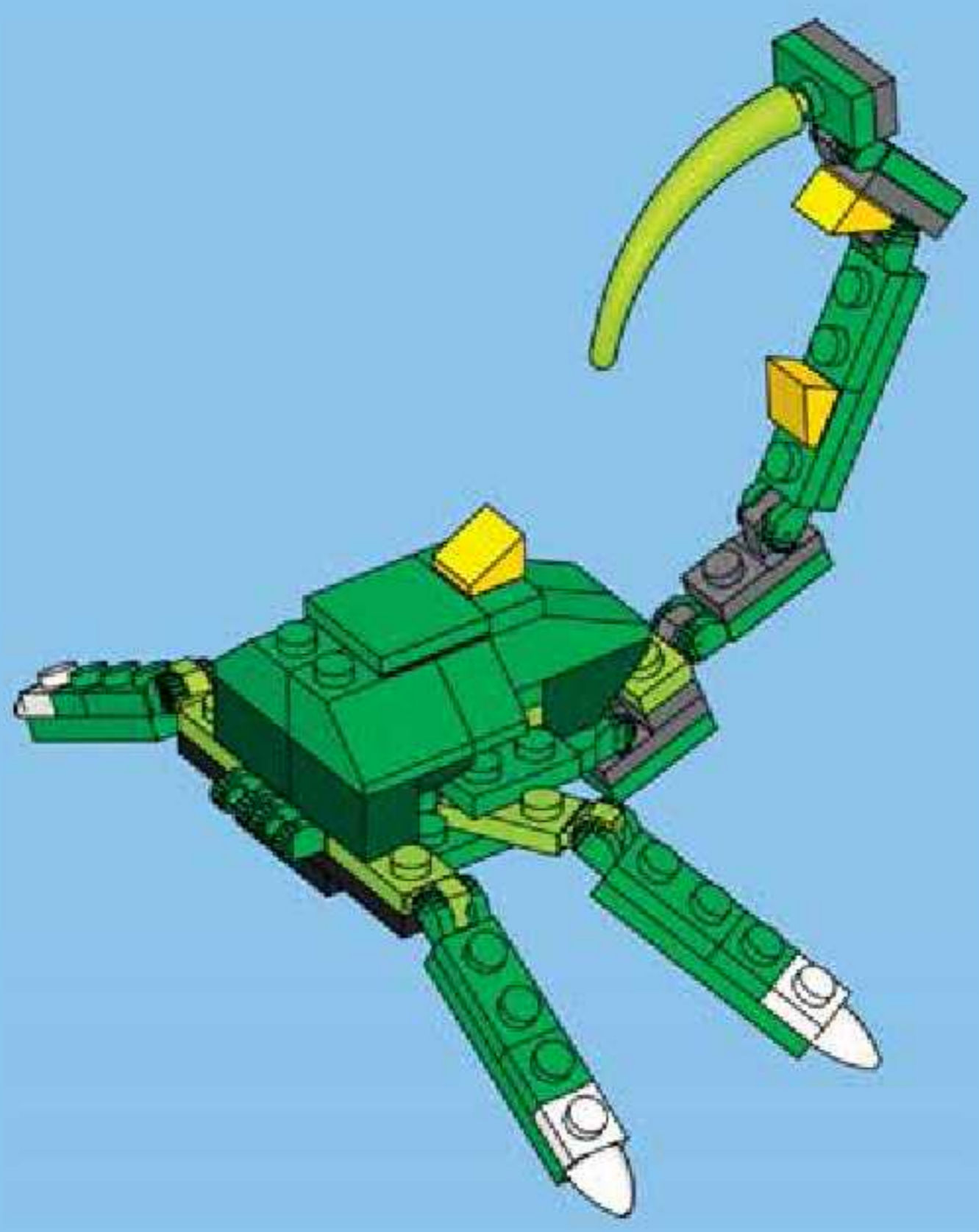

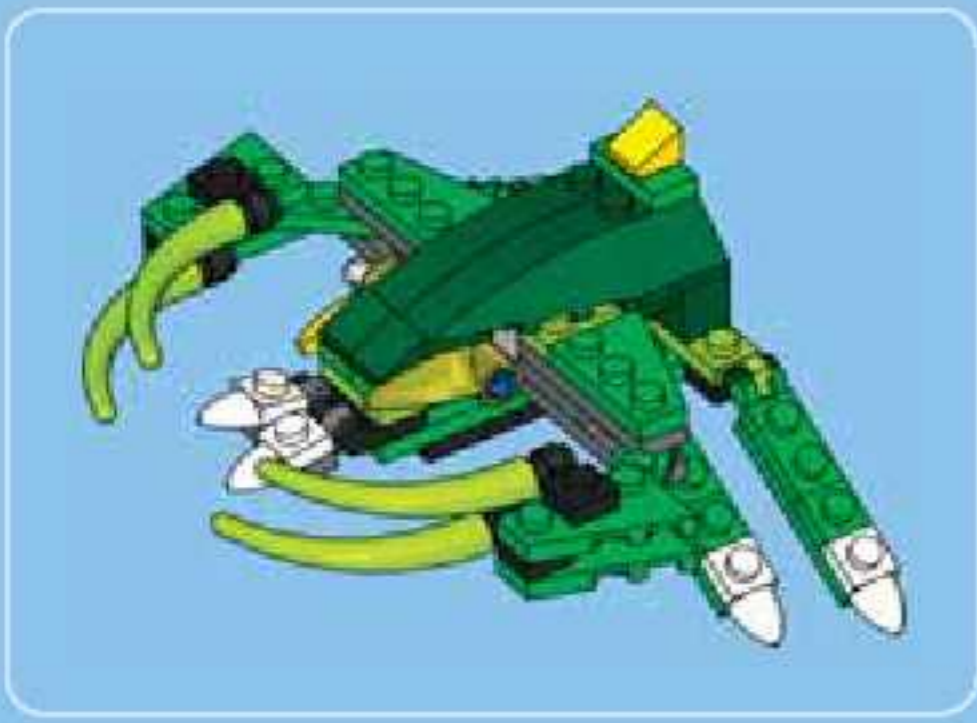

1



2



3

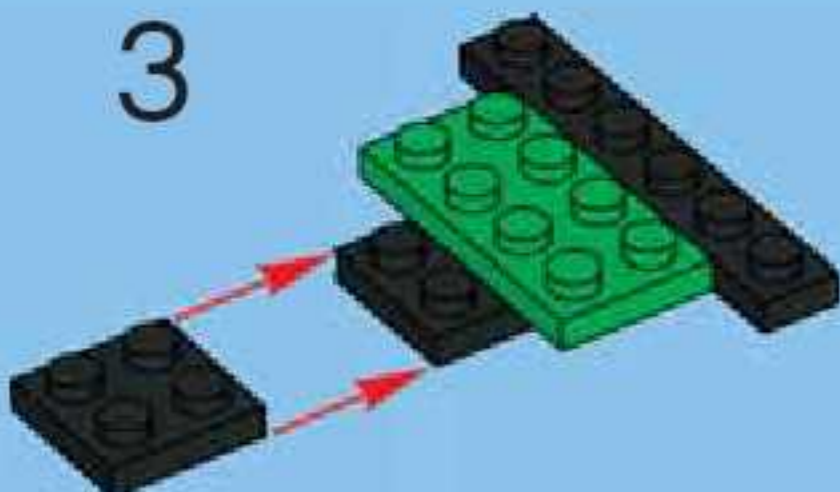

4

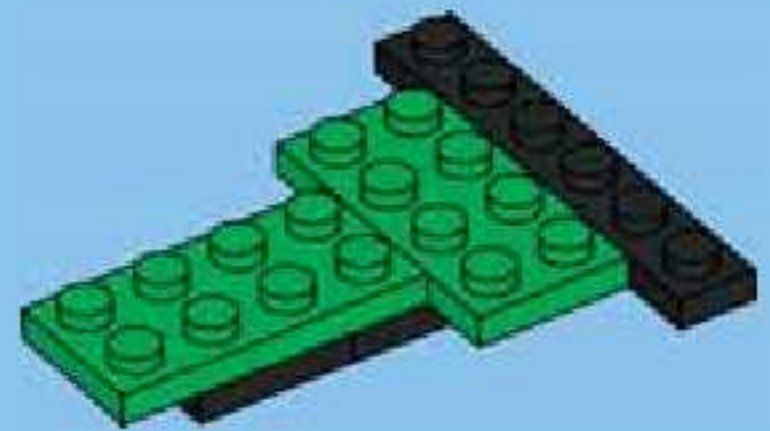

5

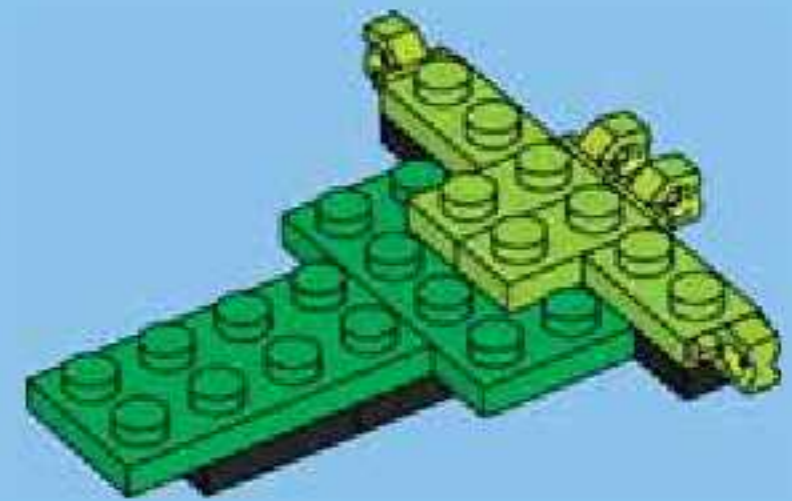

6

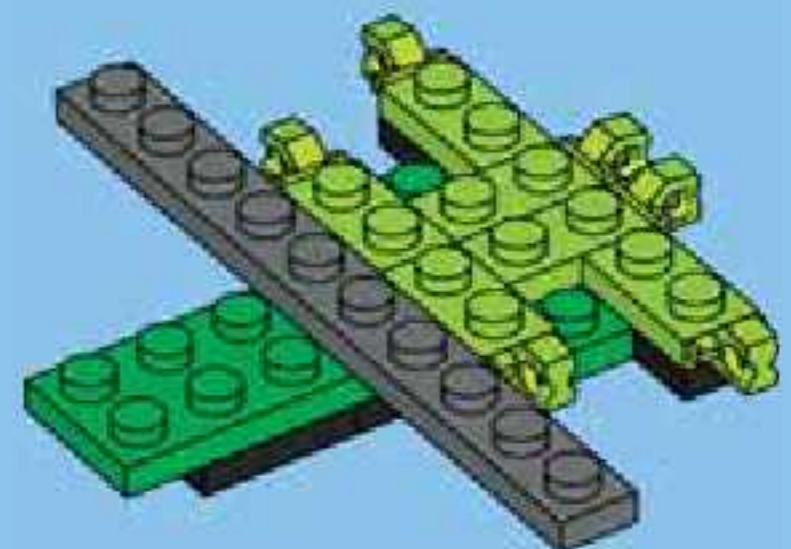

7

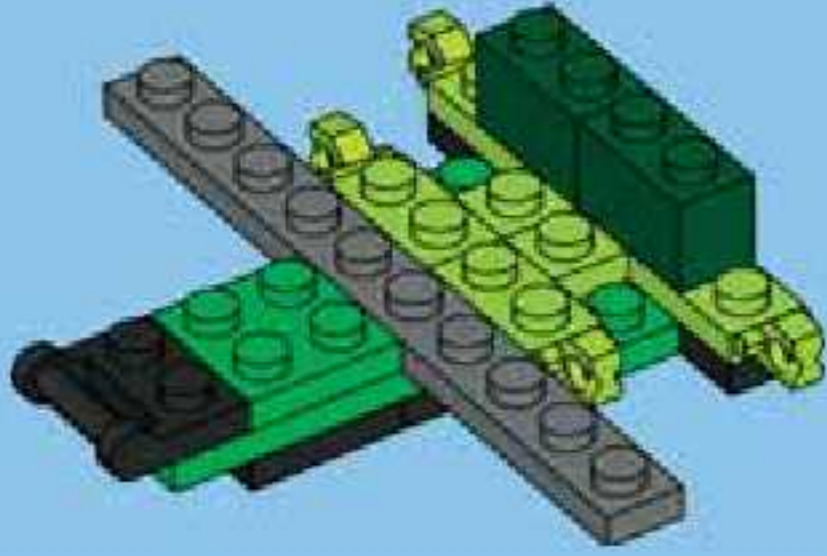

8

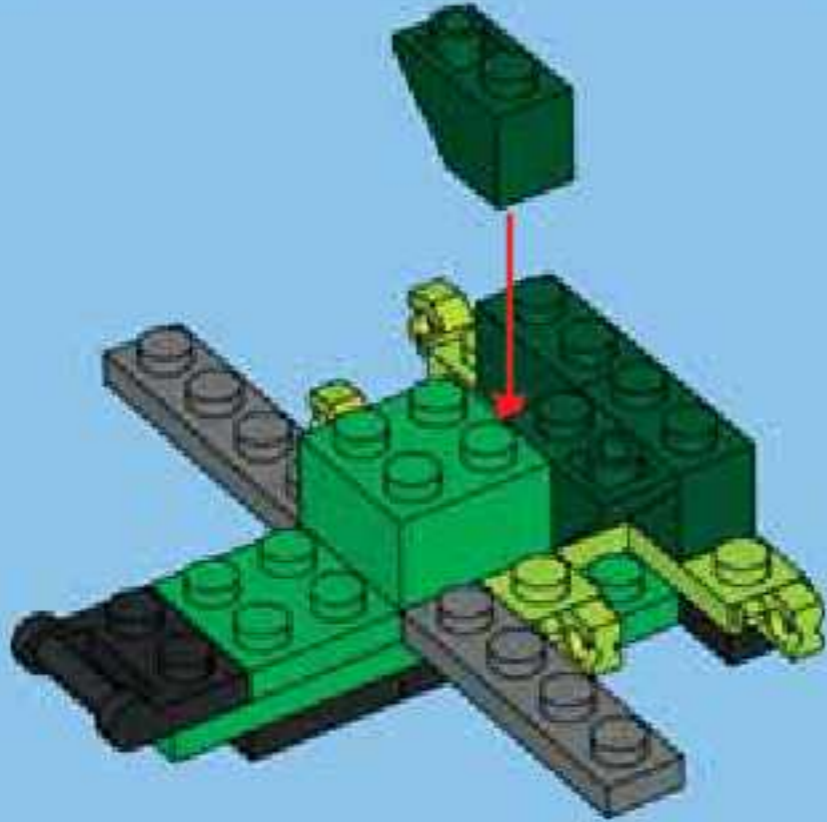

9

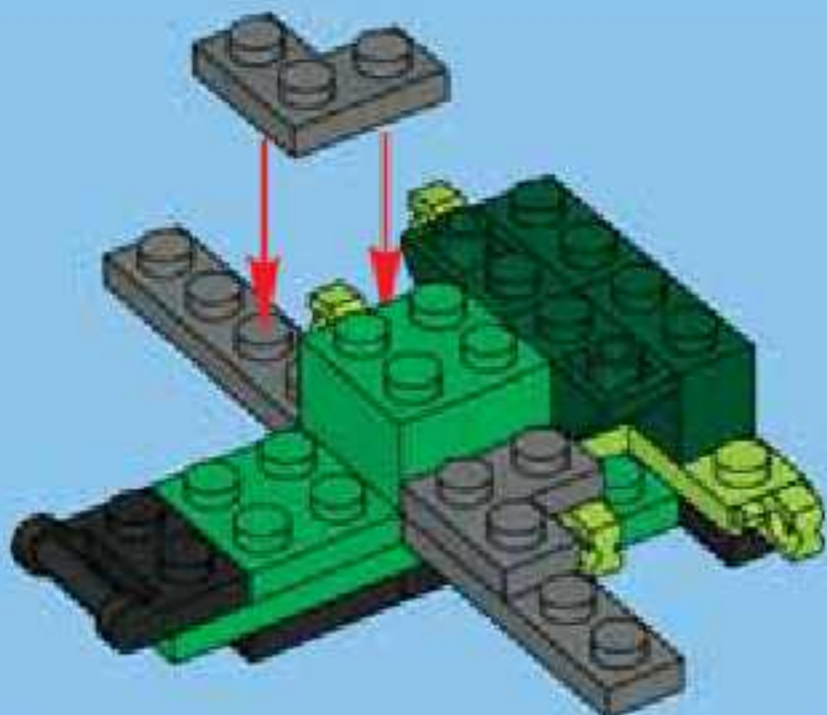

1

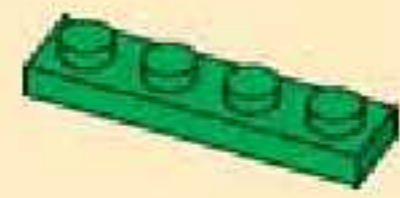

2

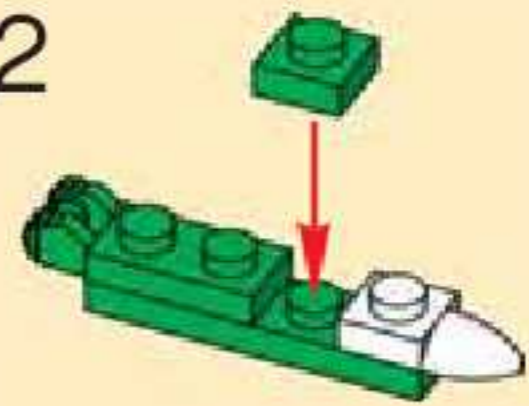

4x

10

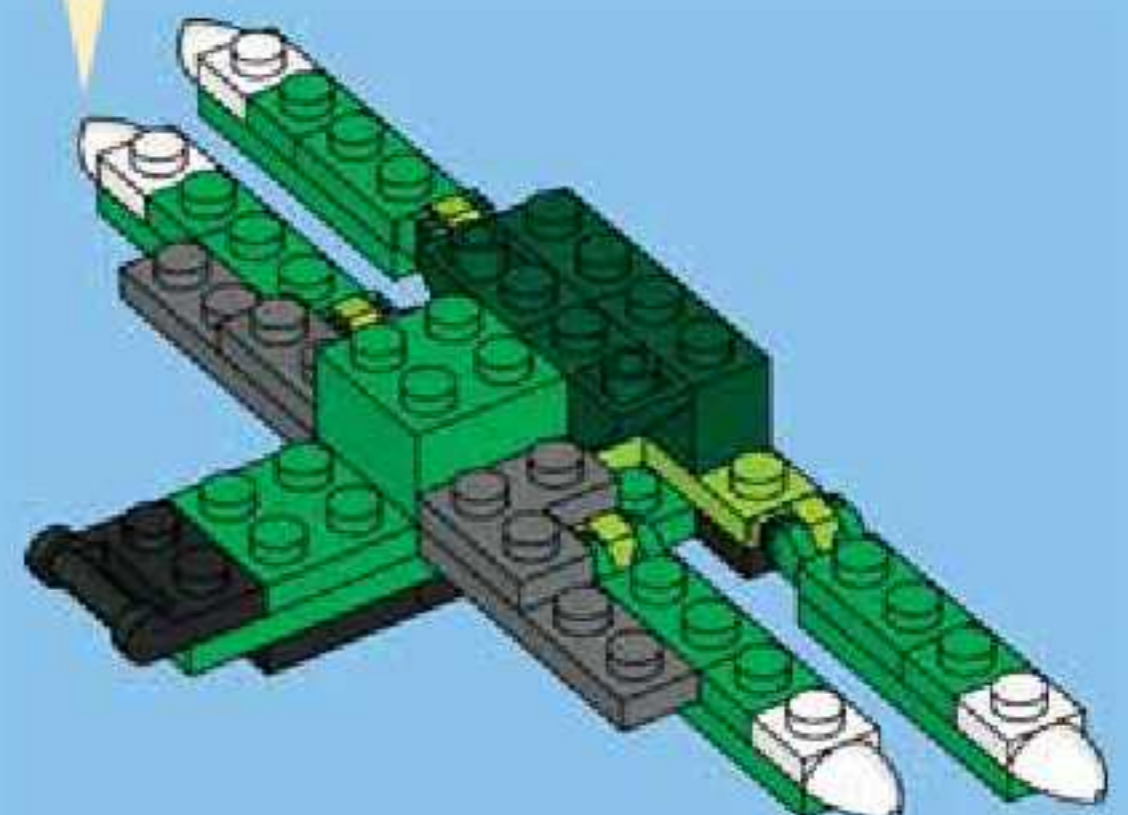

1



2



3



4



11

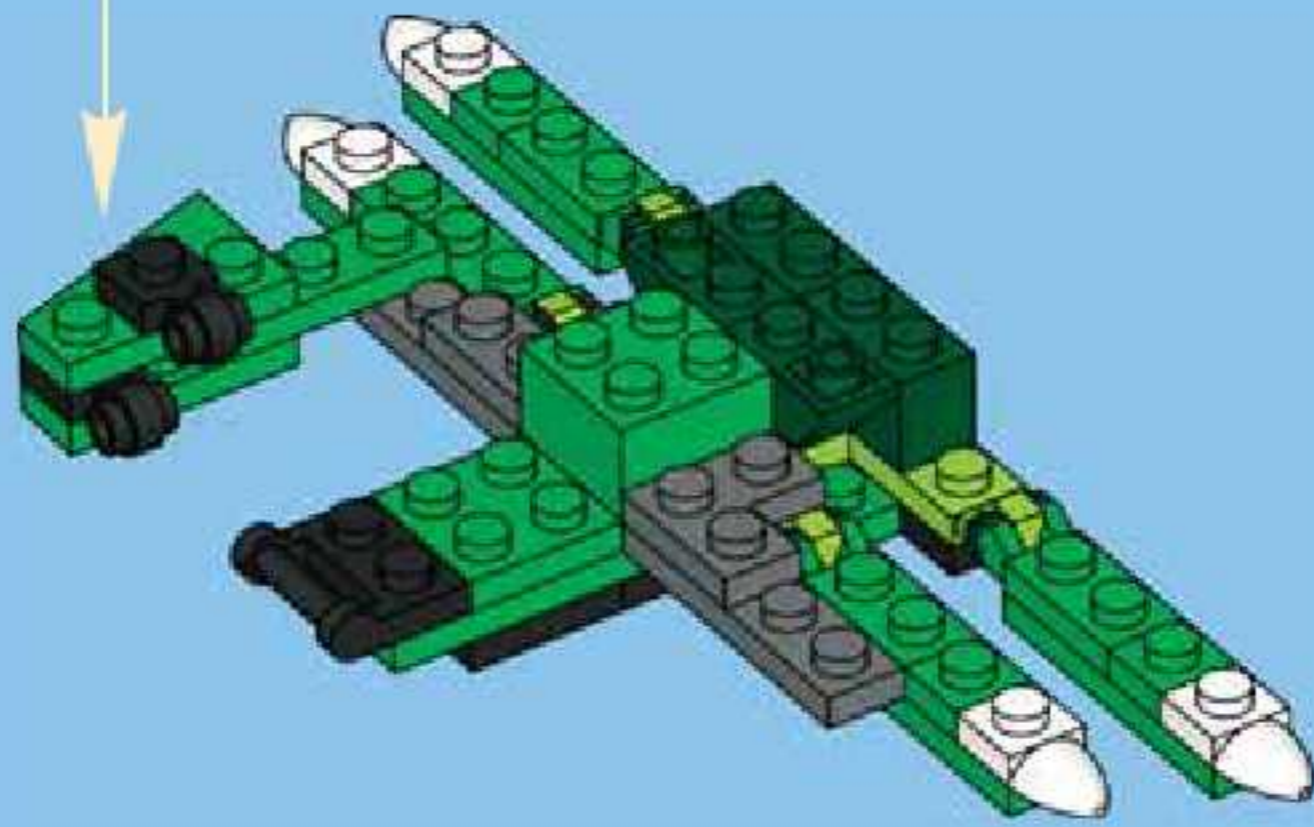

1

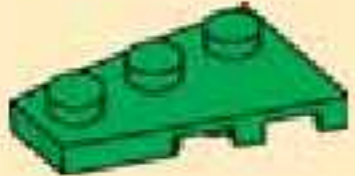

2



3

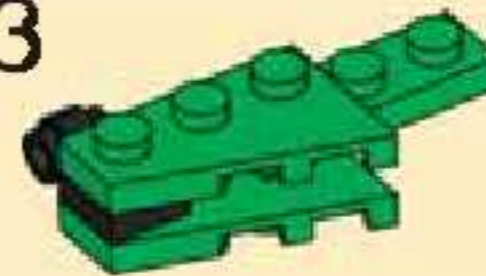

4



12

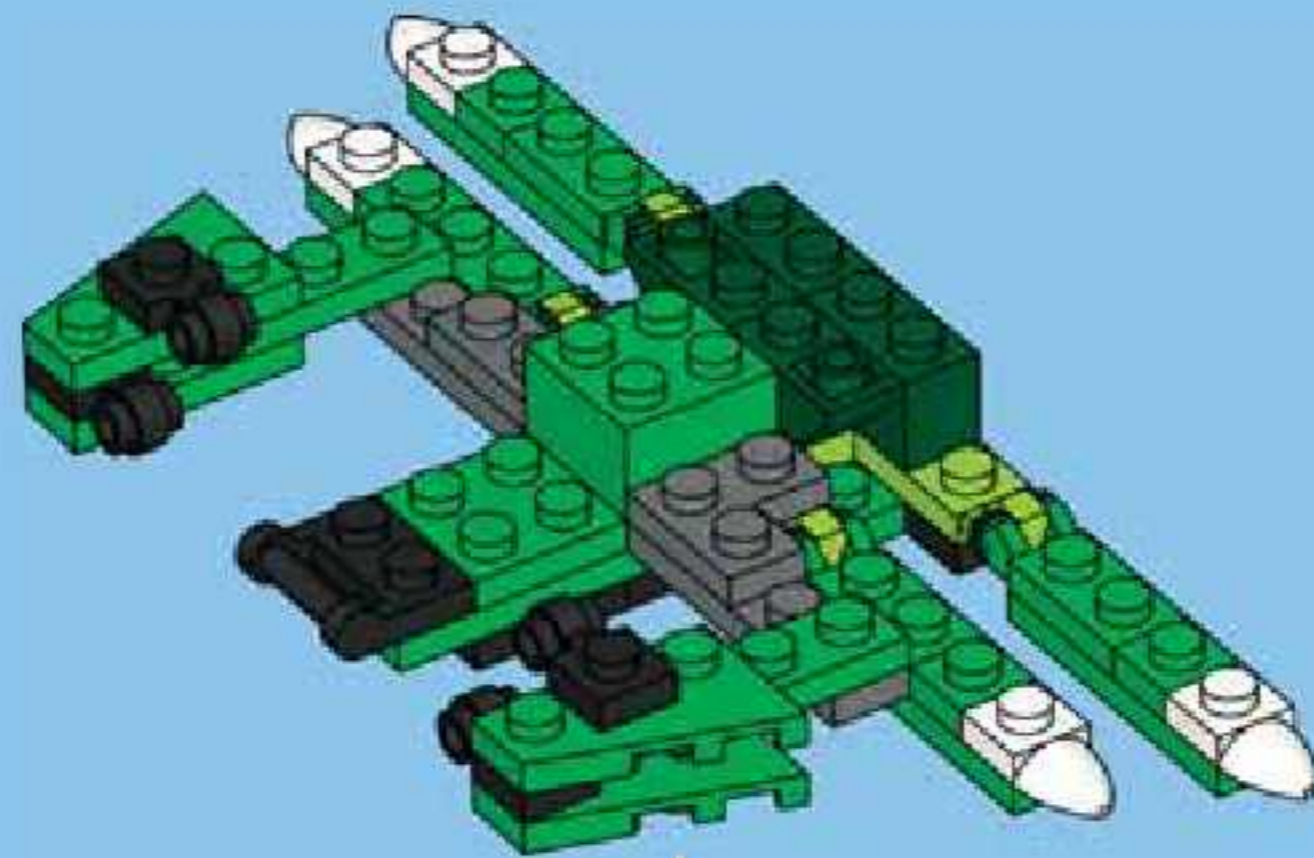

13

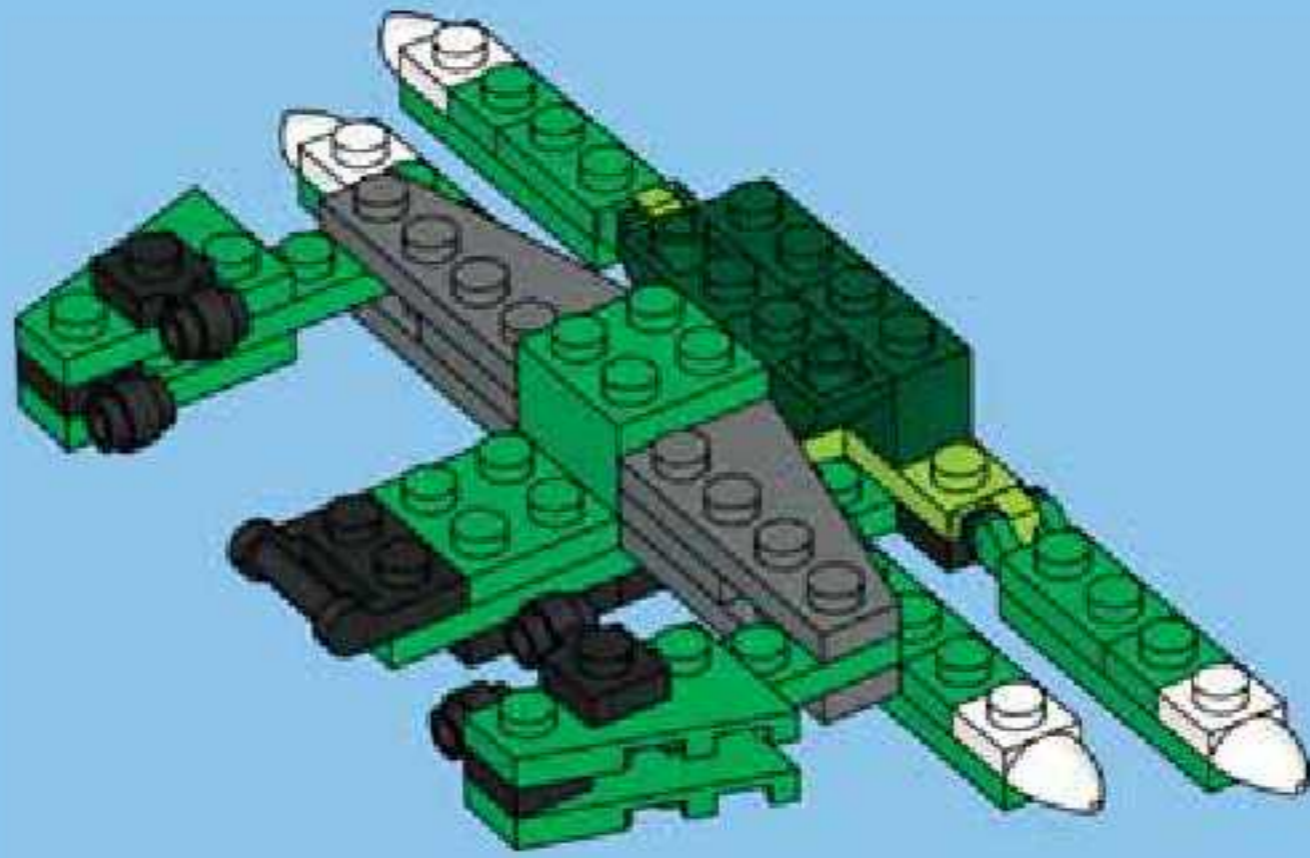

14

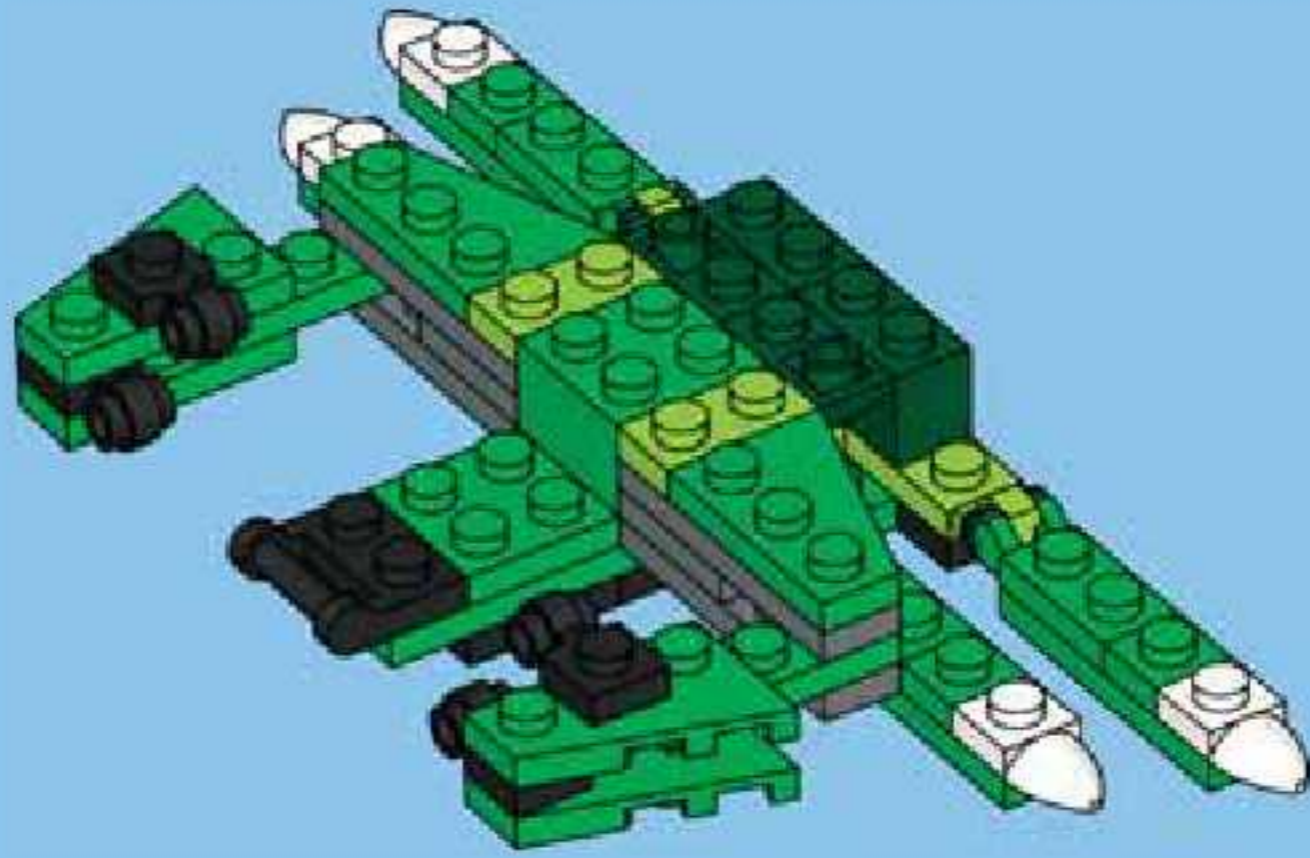

15

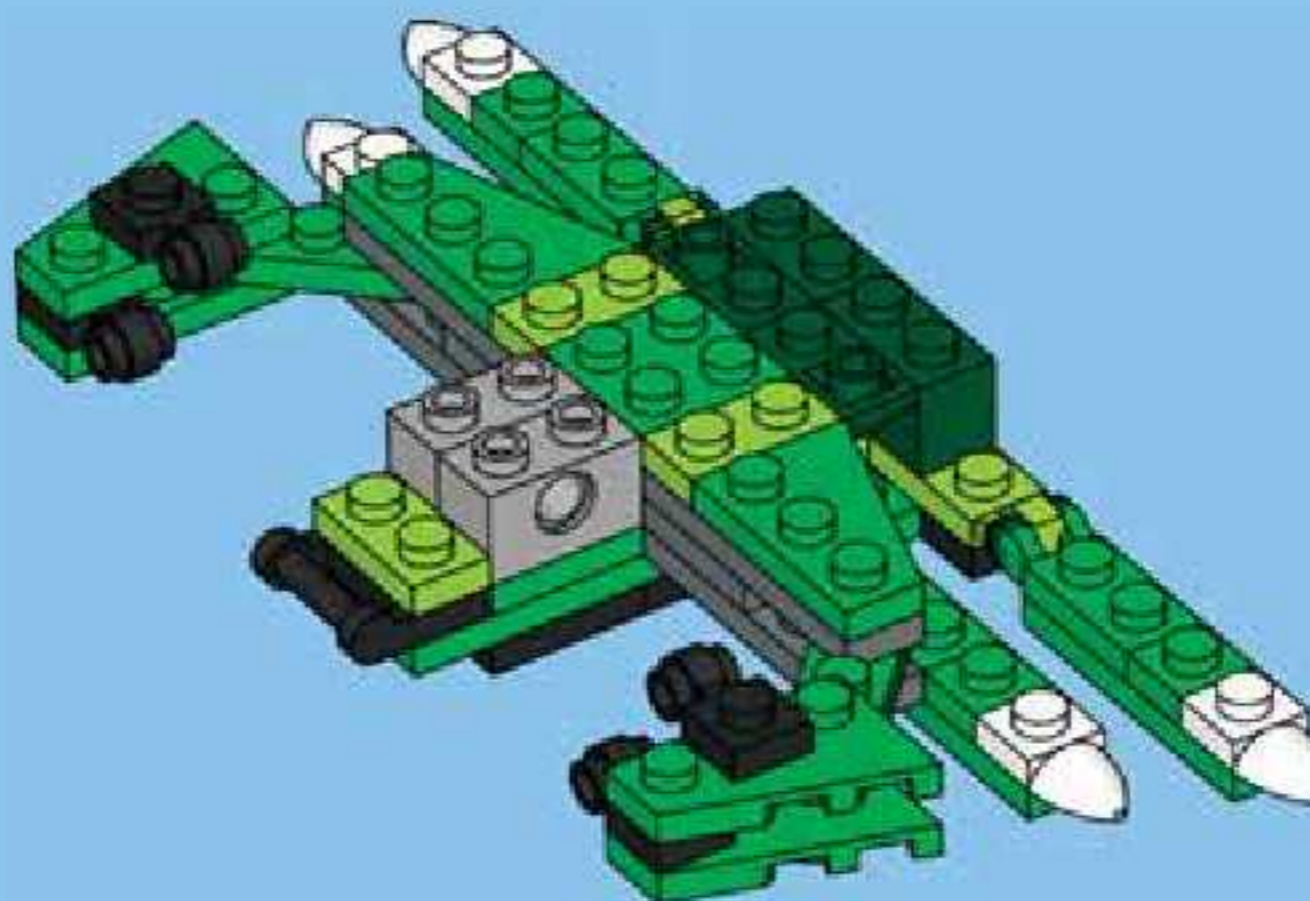

16

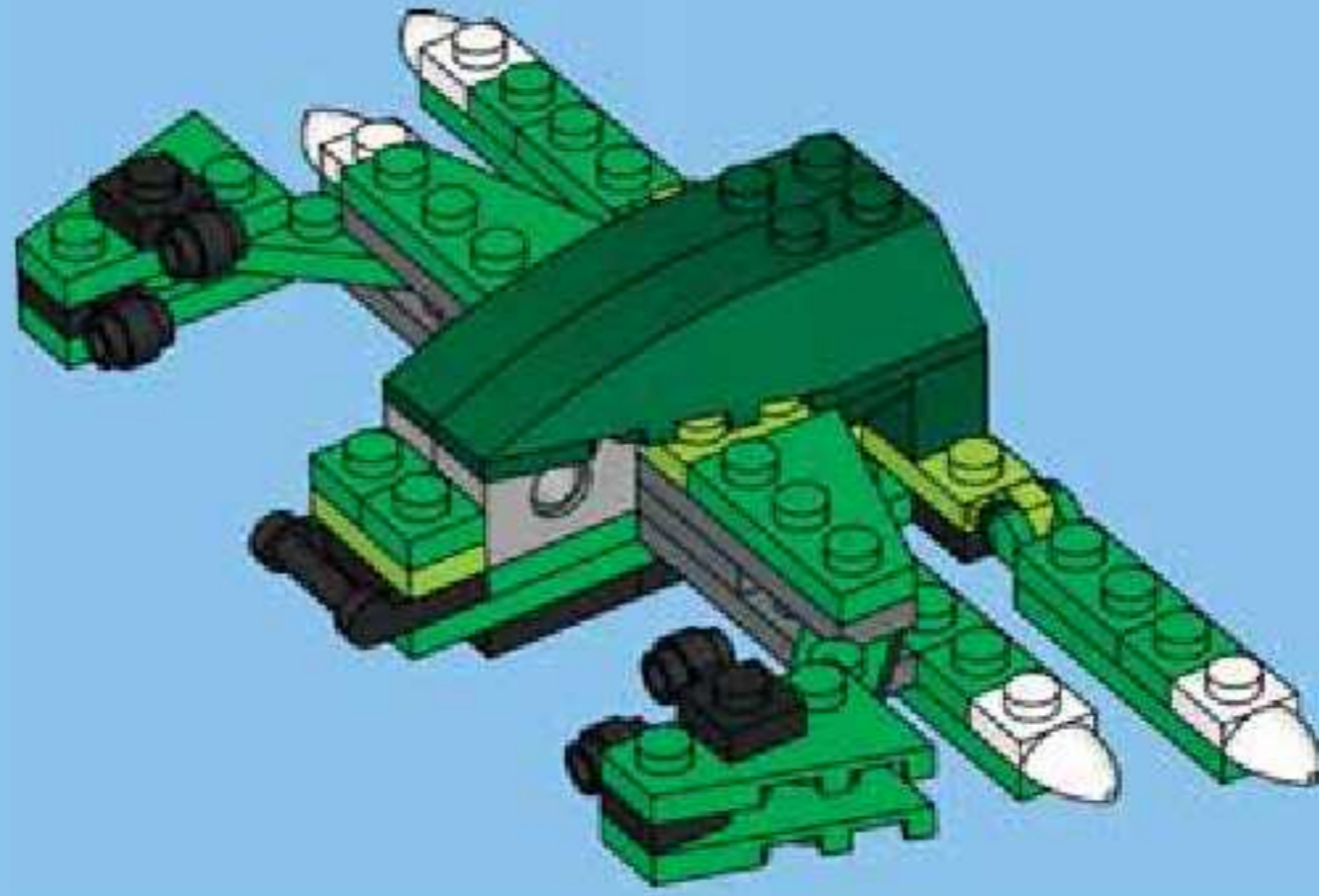

17

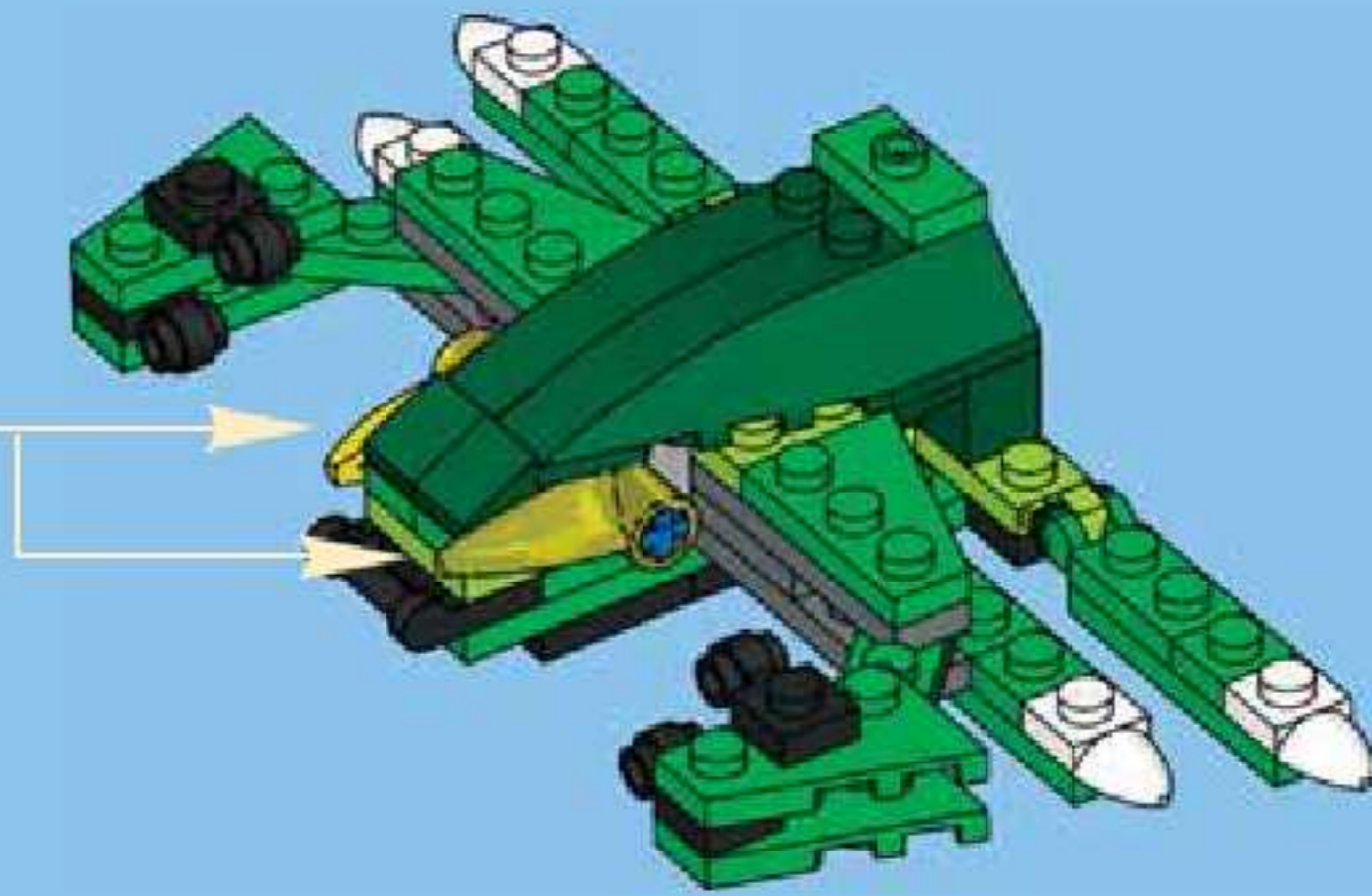
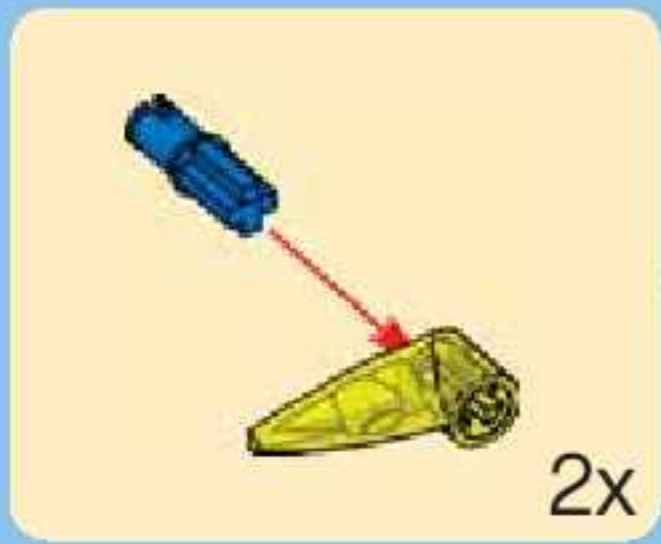

18

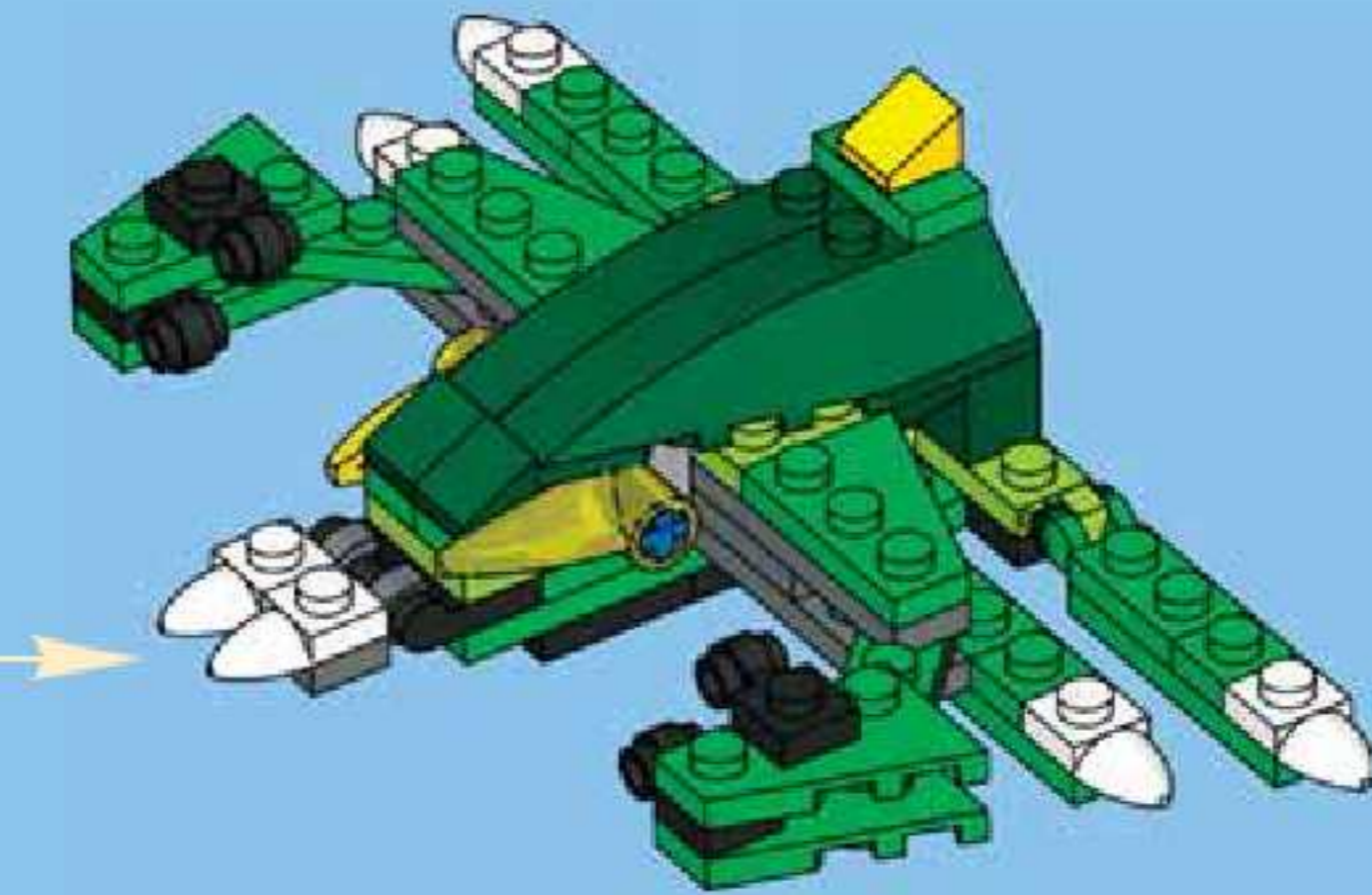
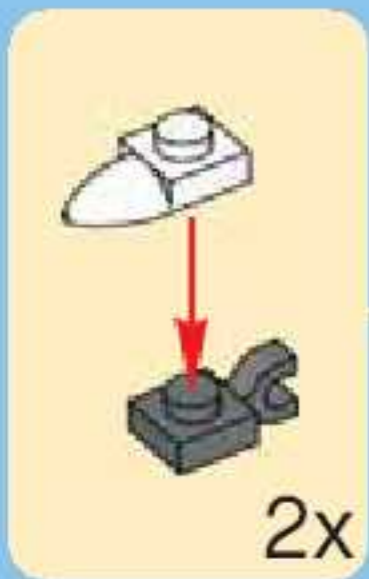

19

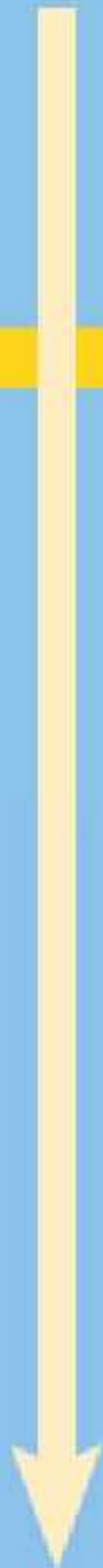
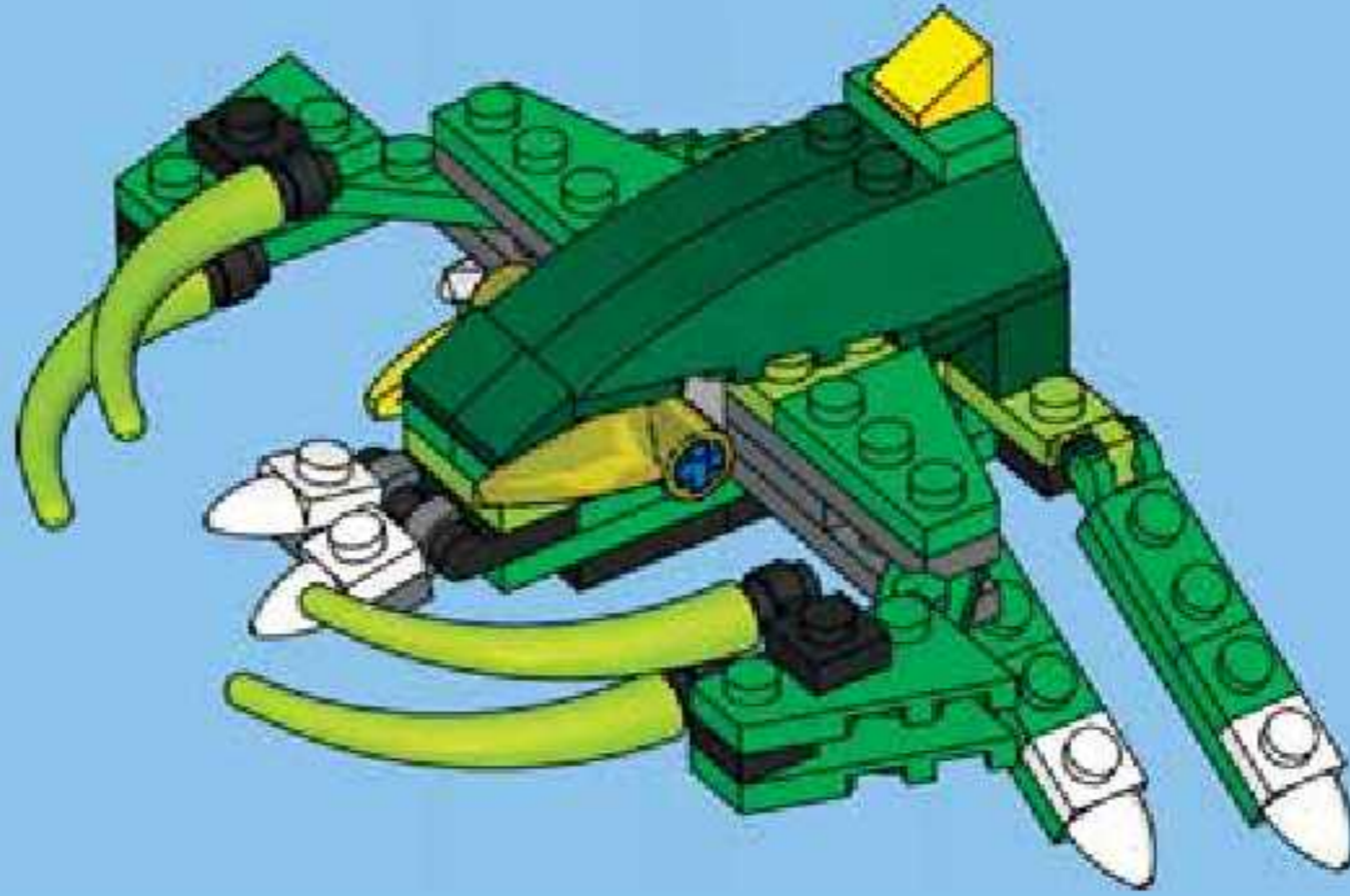

19

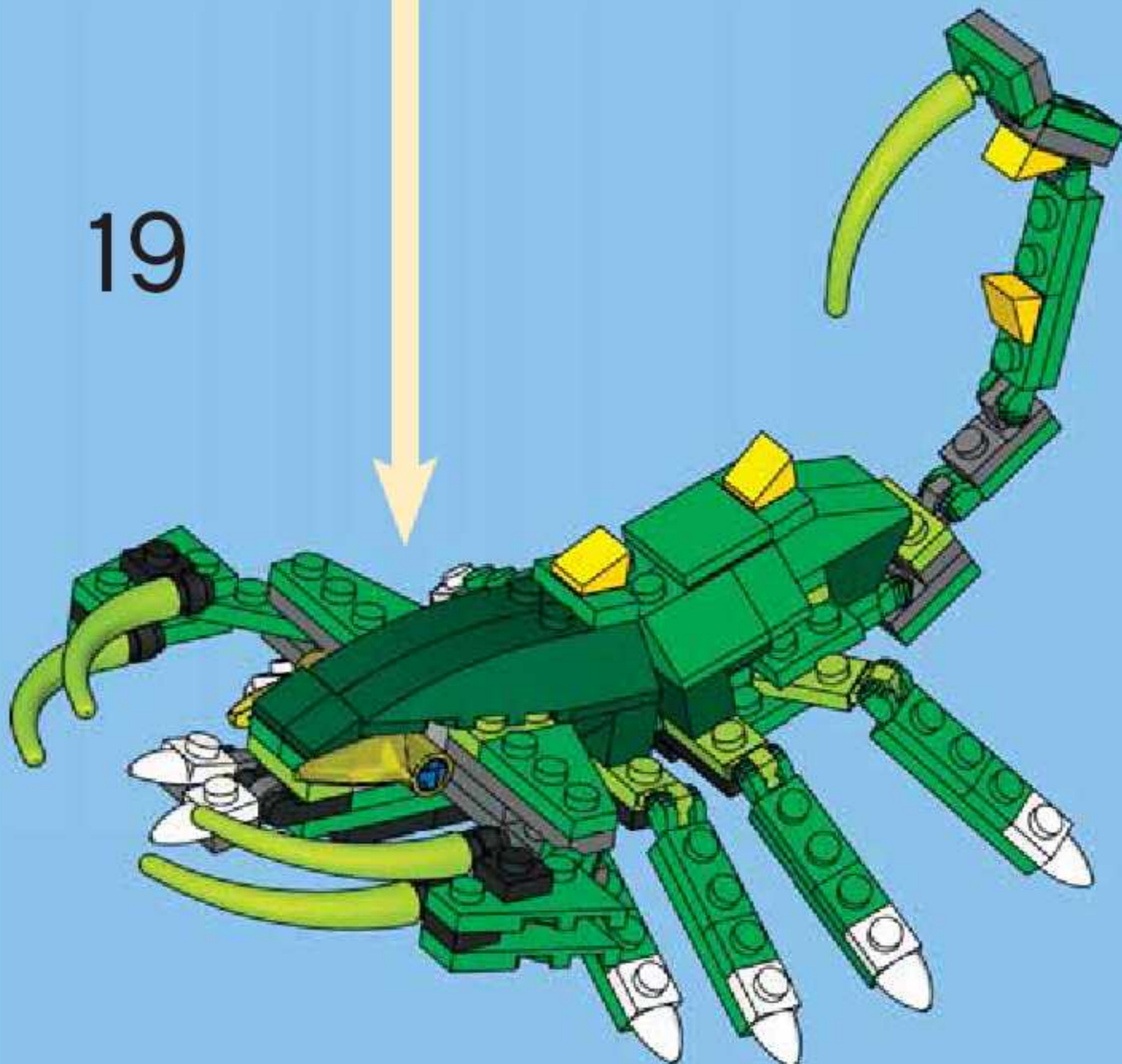



1

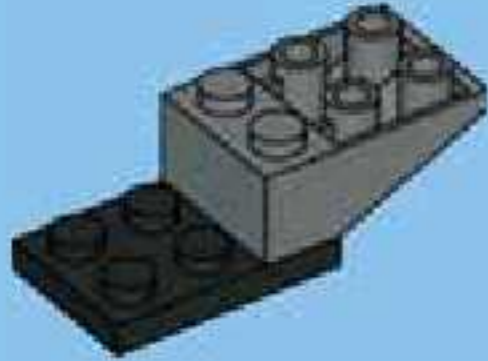

2



3



4

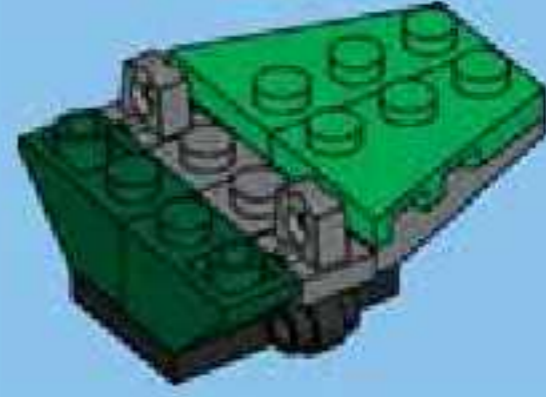

5

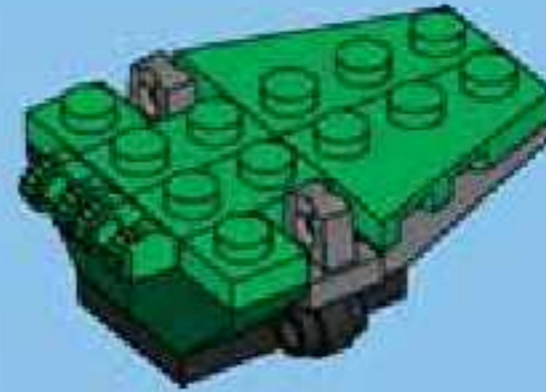

6

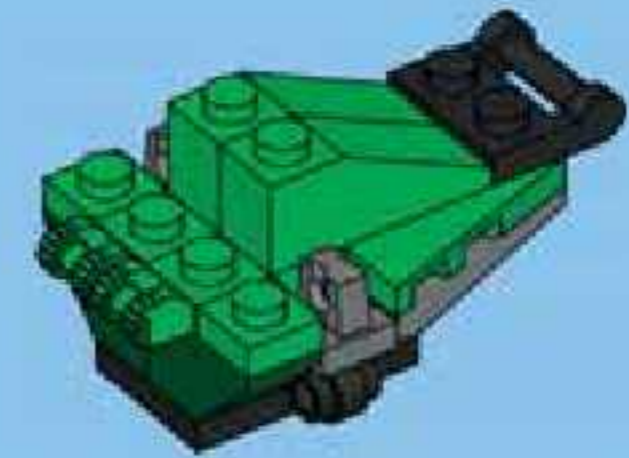

7



1



2



3

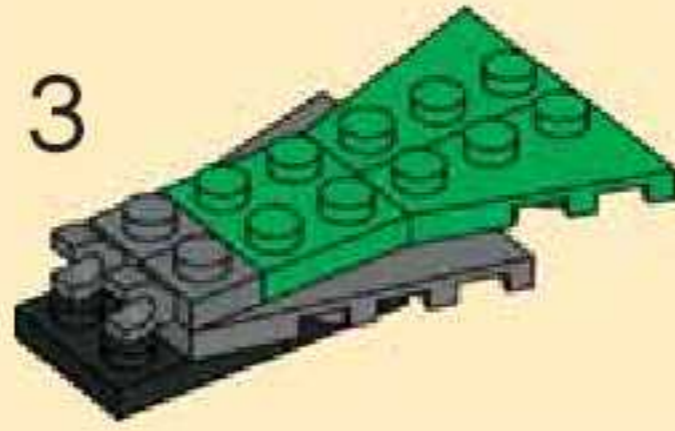

4

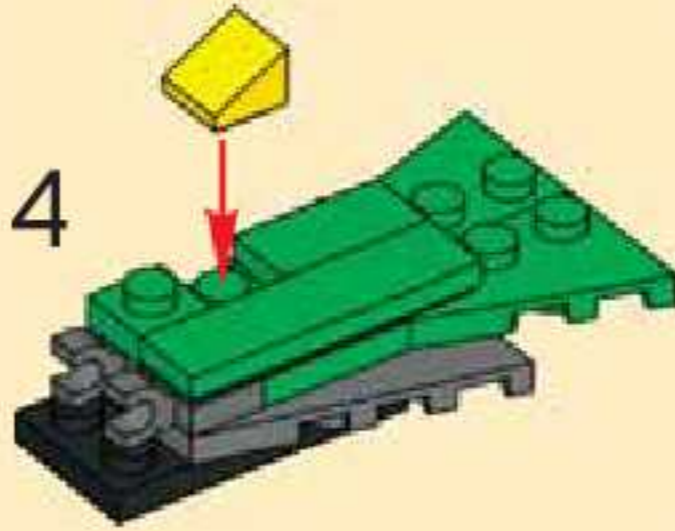

8

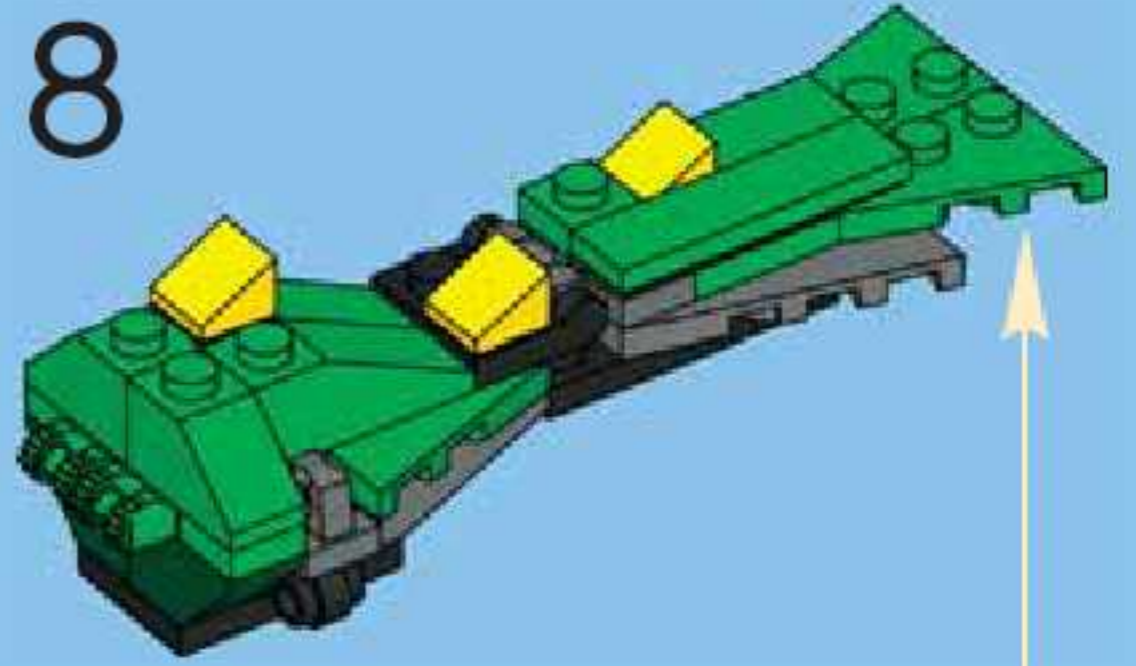

1

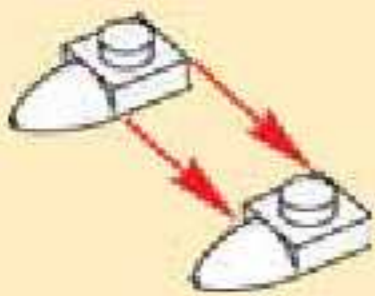

2



3



4

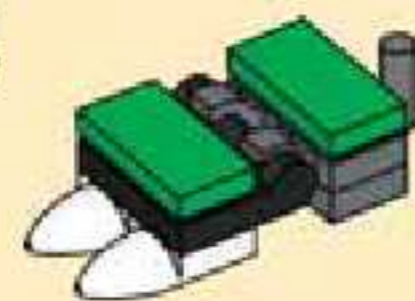

2x

9

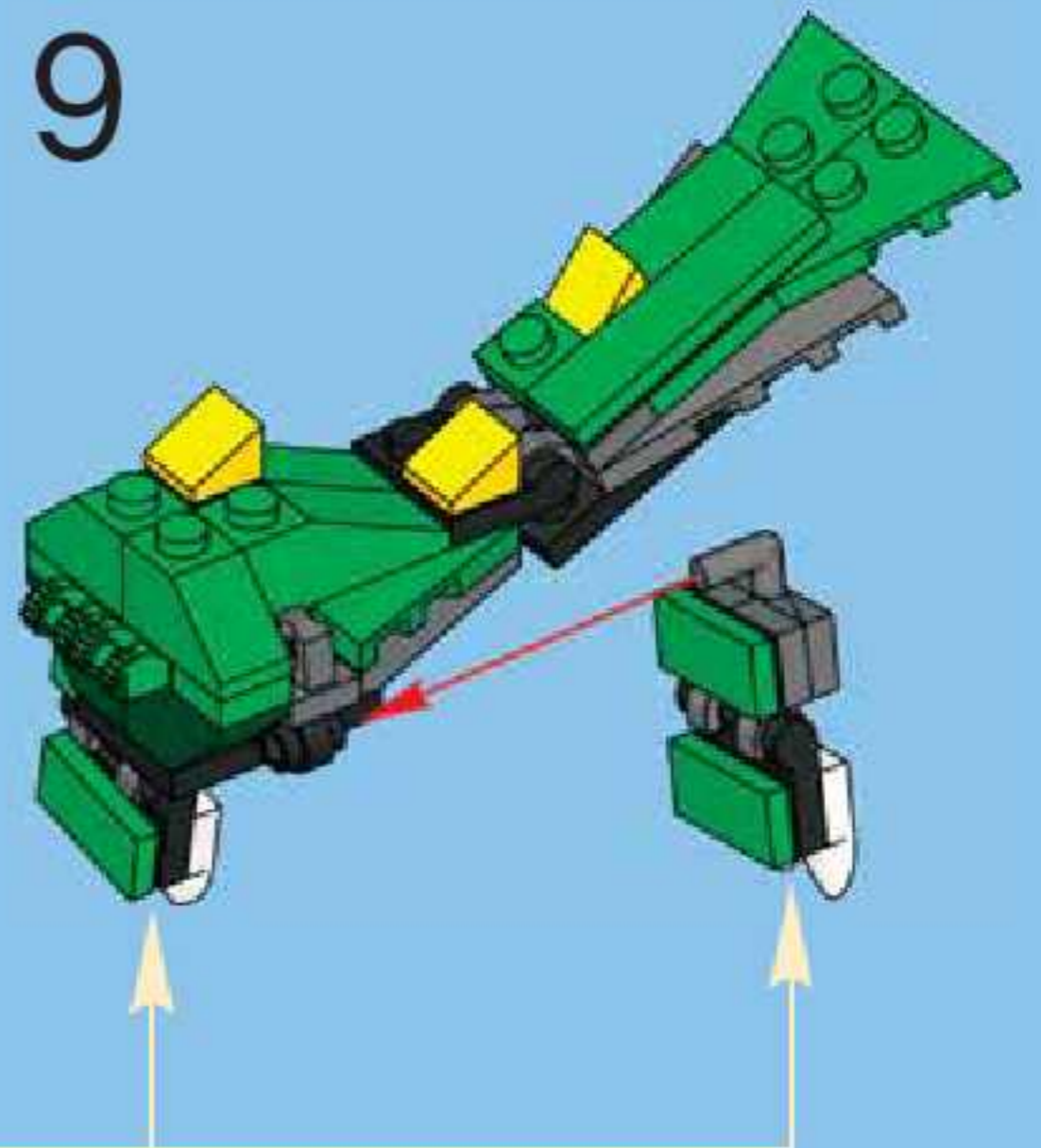

1



2

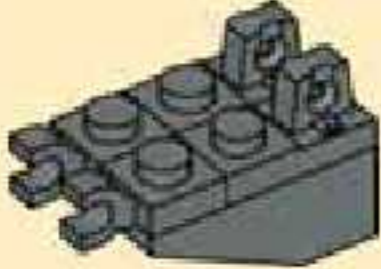

3

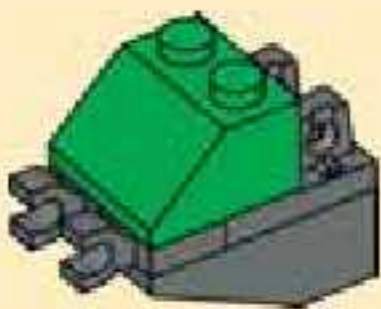

10

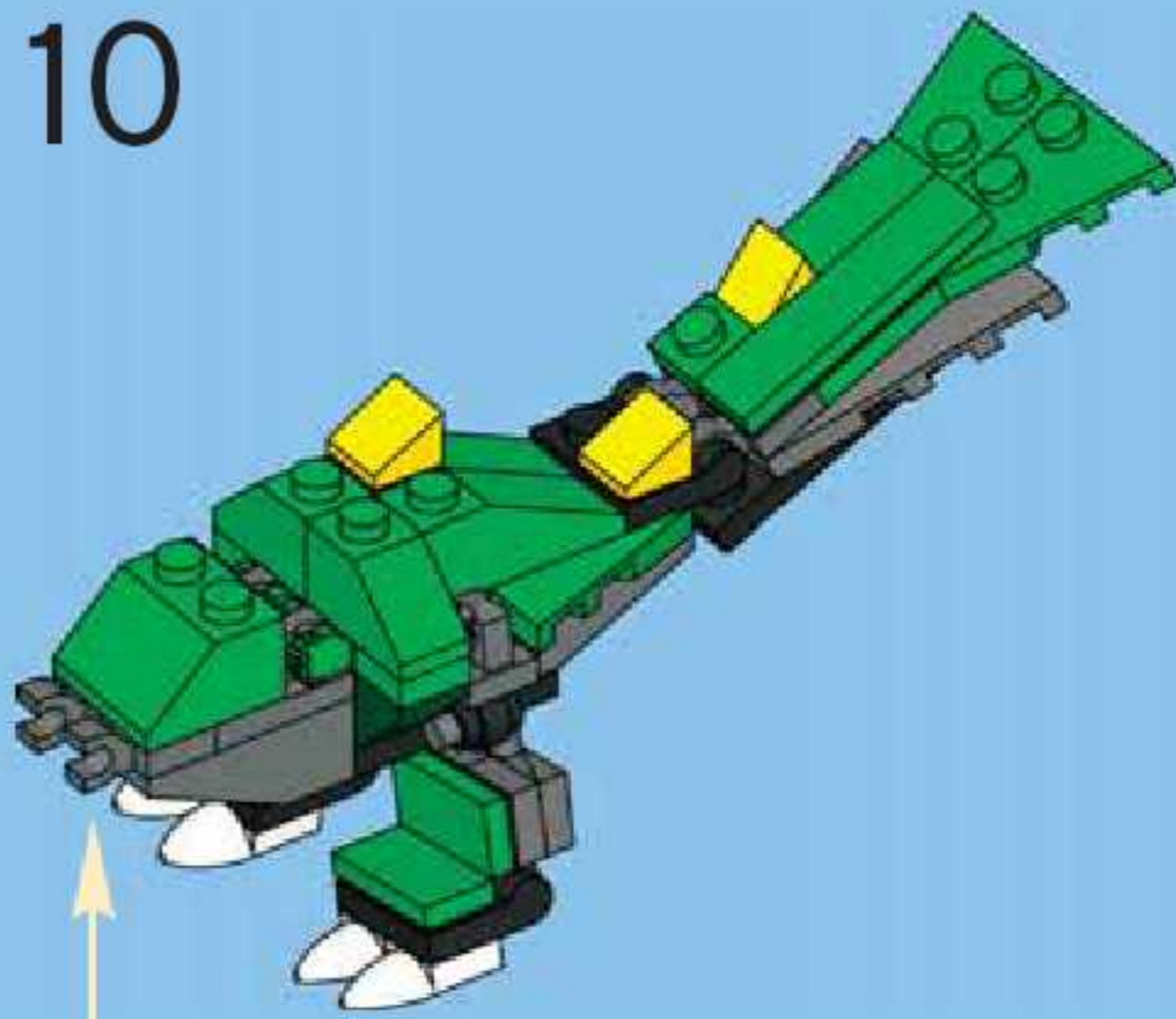

1

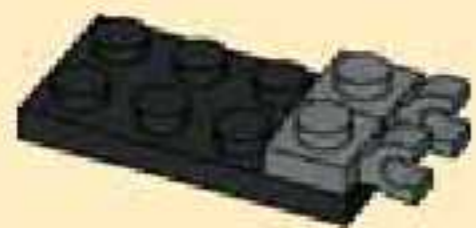

2

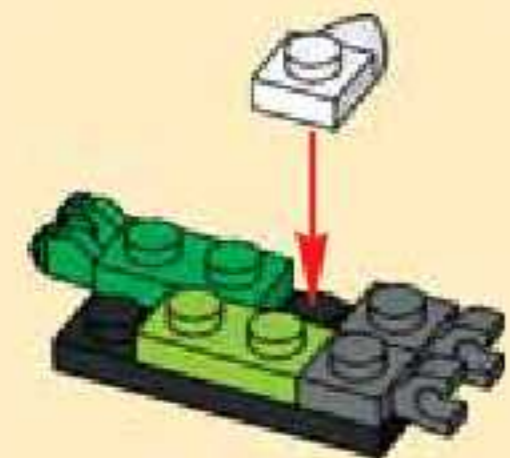

3

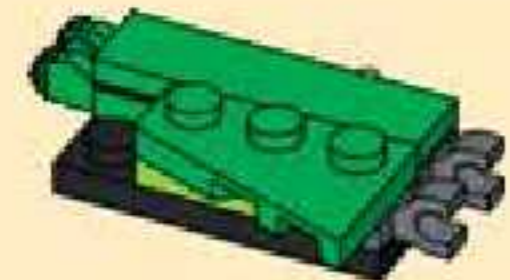

11

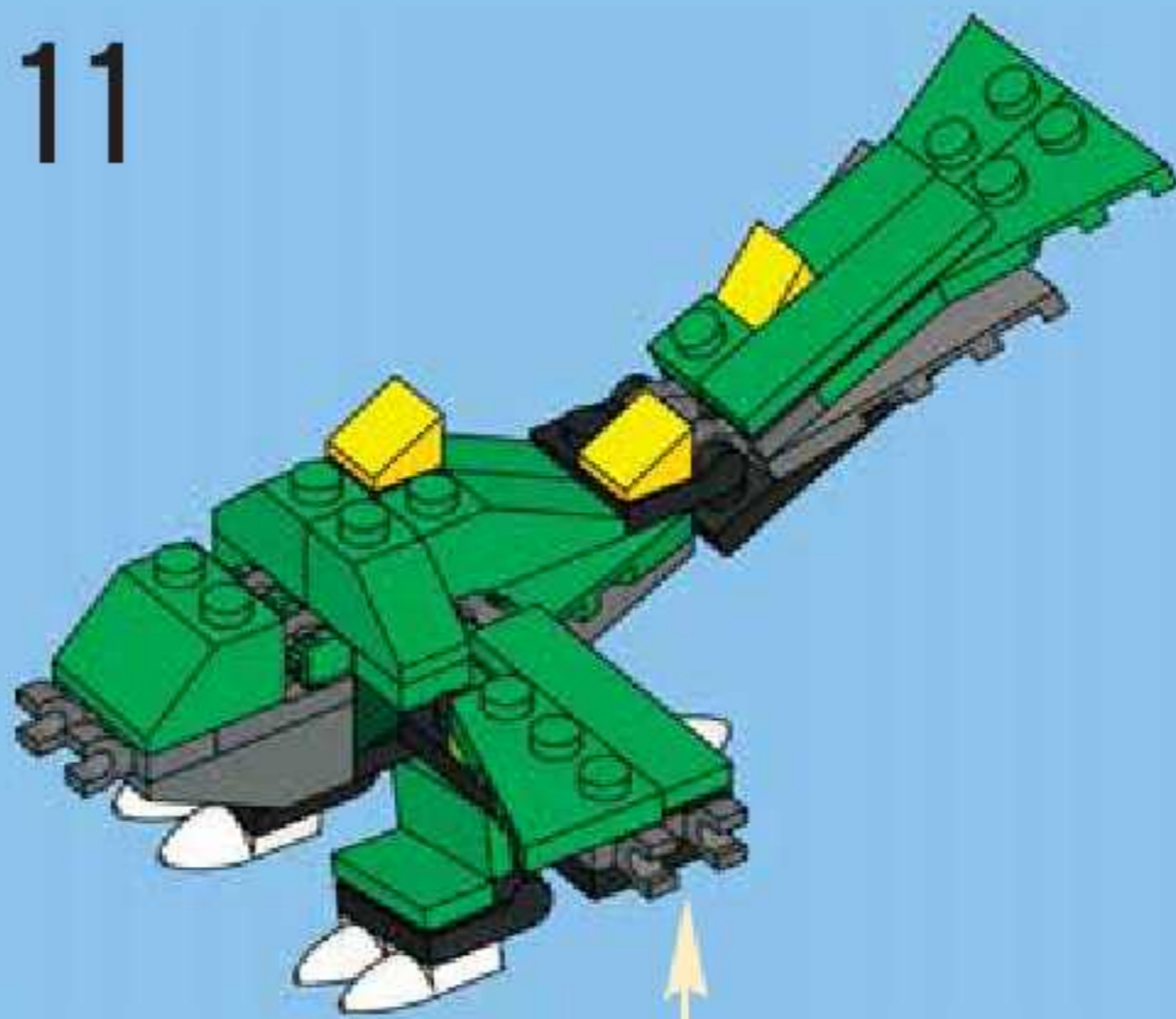

1

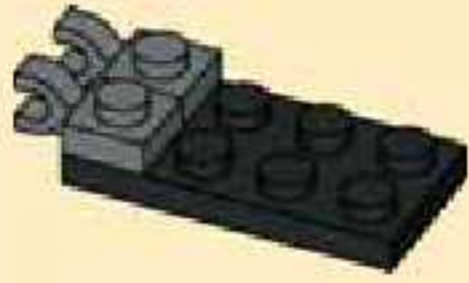

2

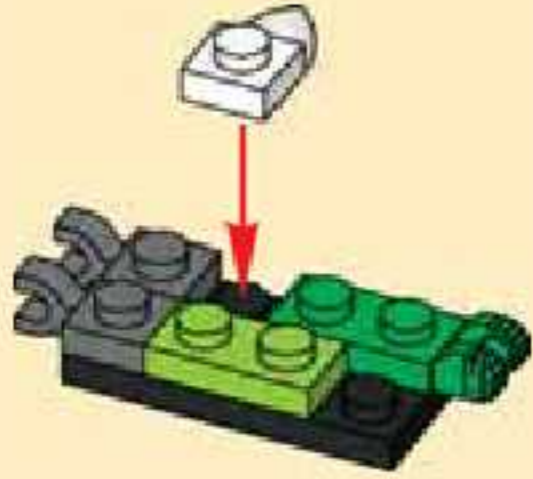

3

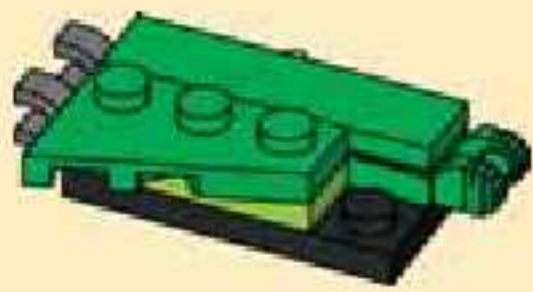

12

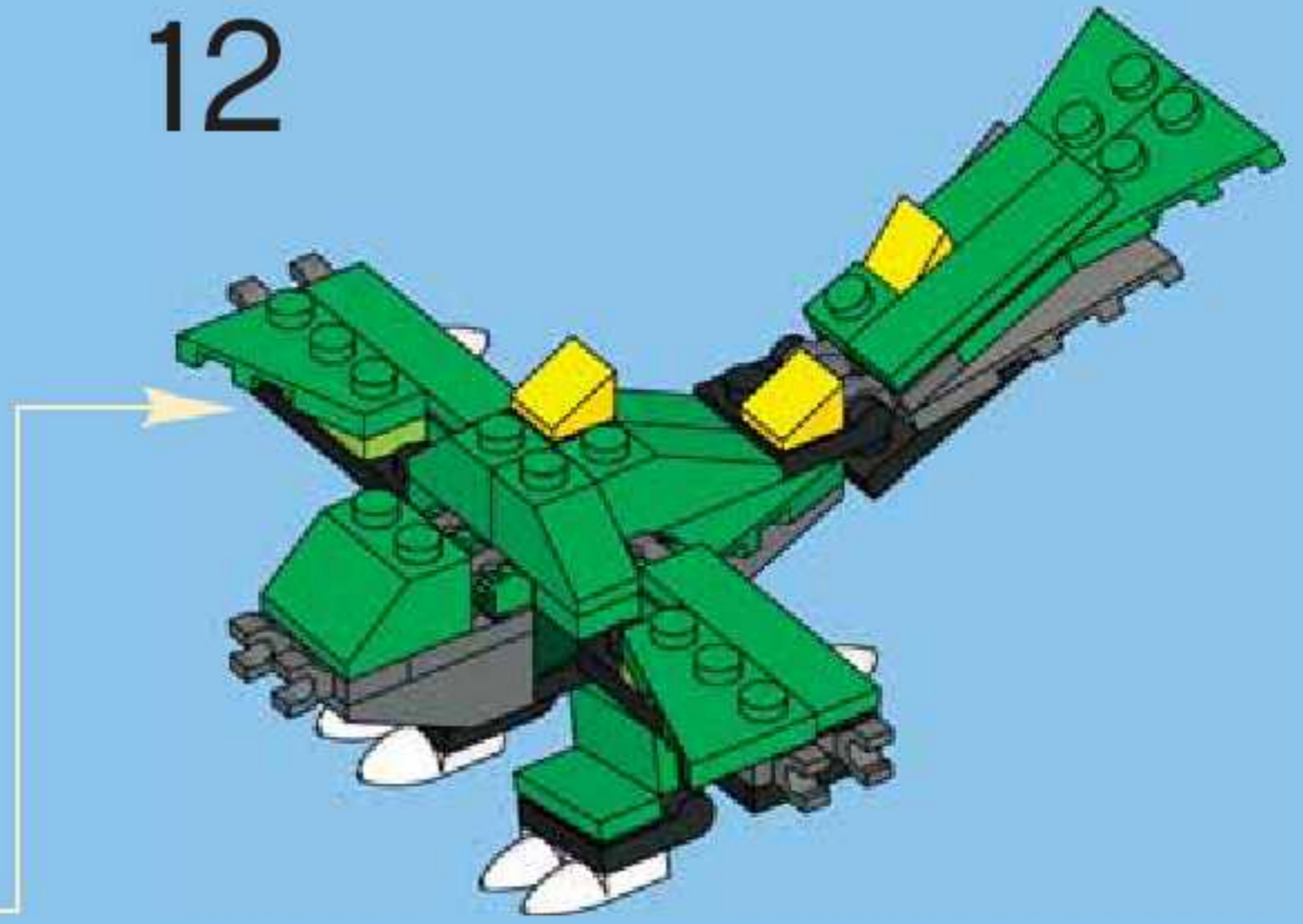

1

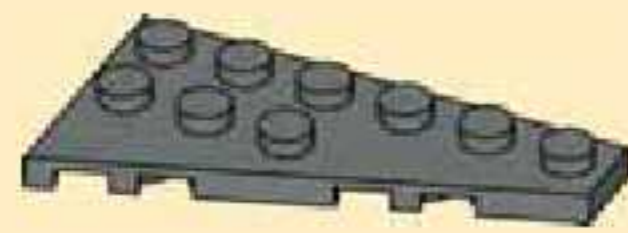

2

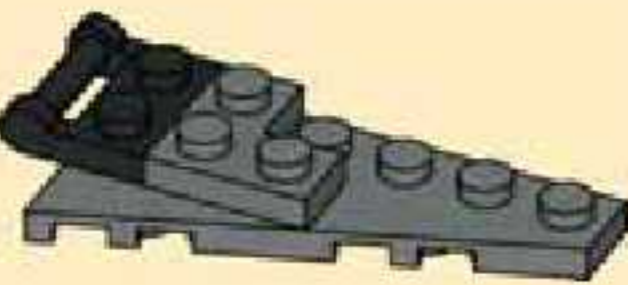

3

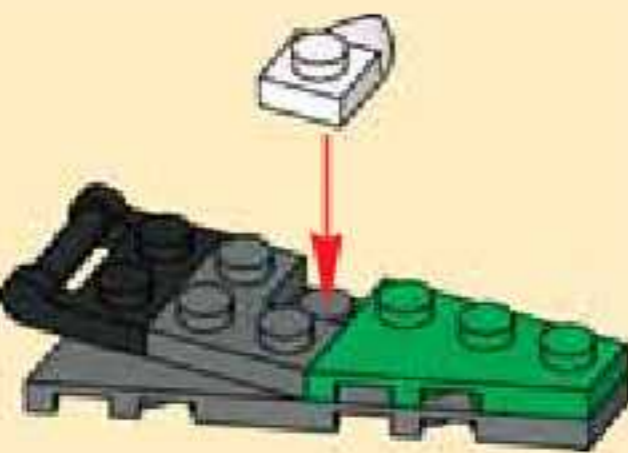

4

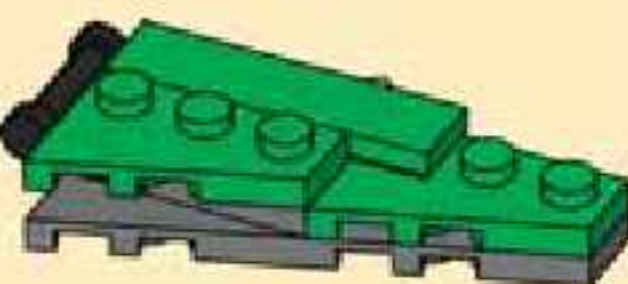

13

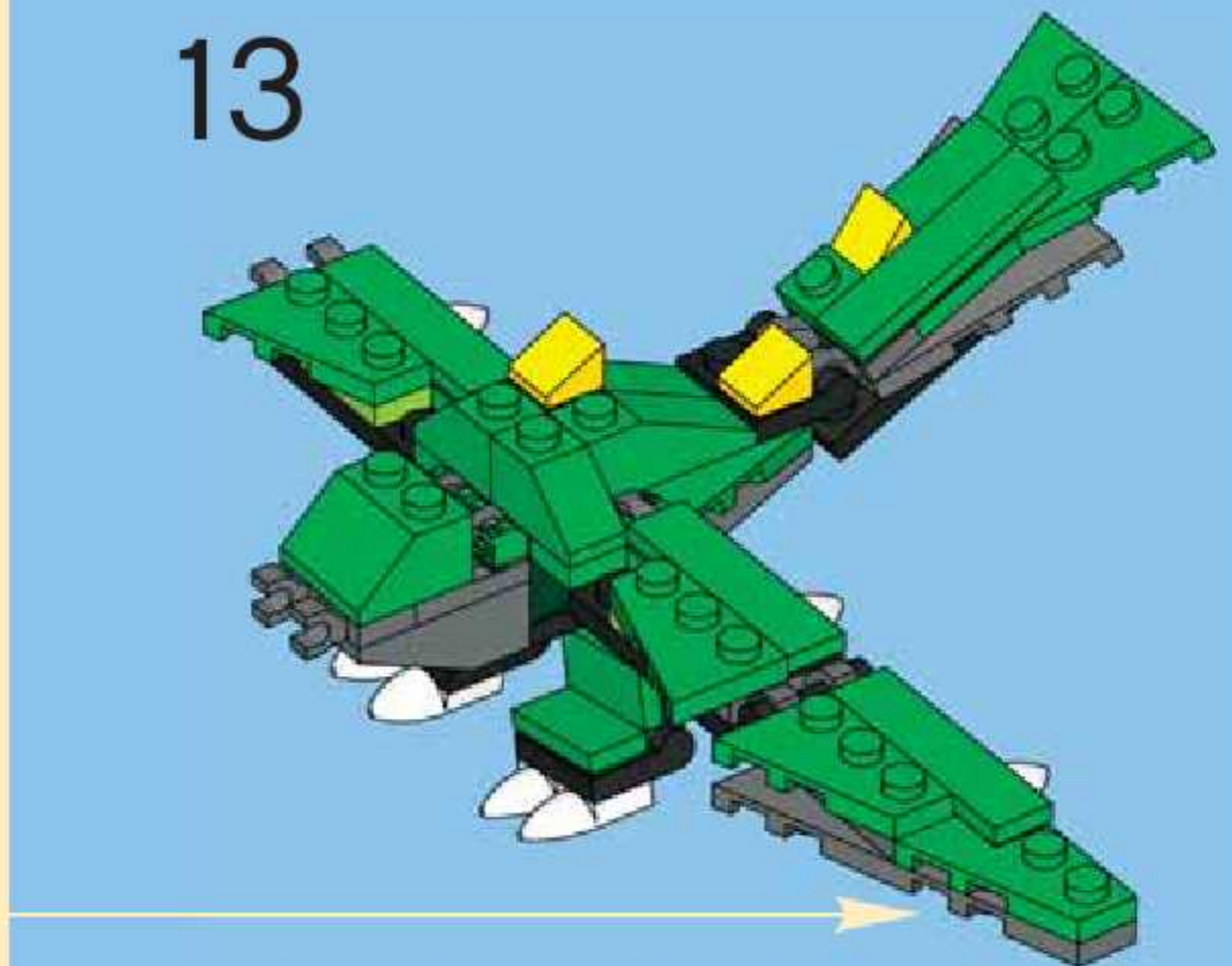

14

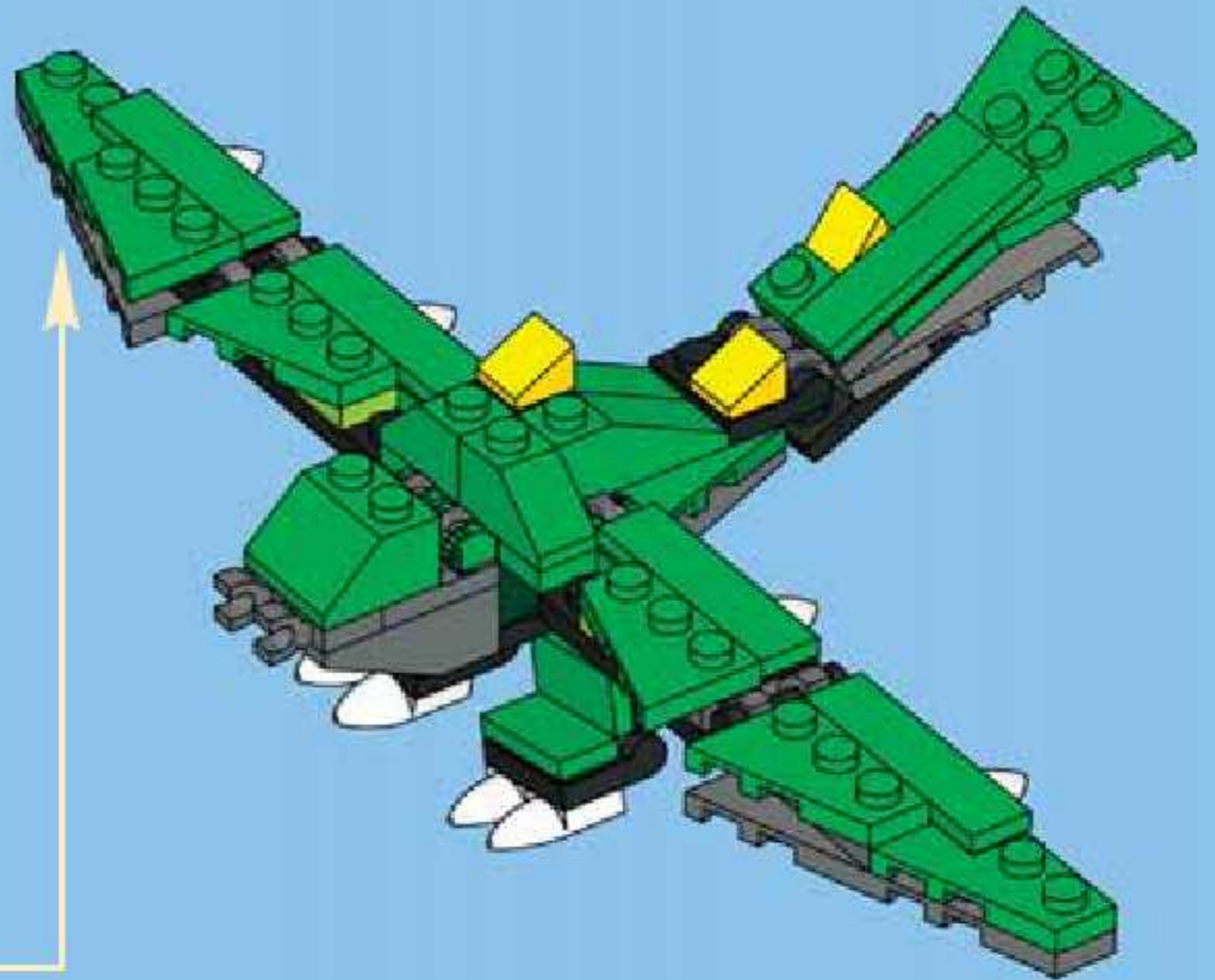
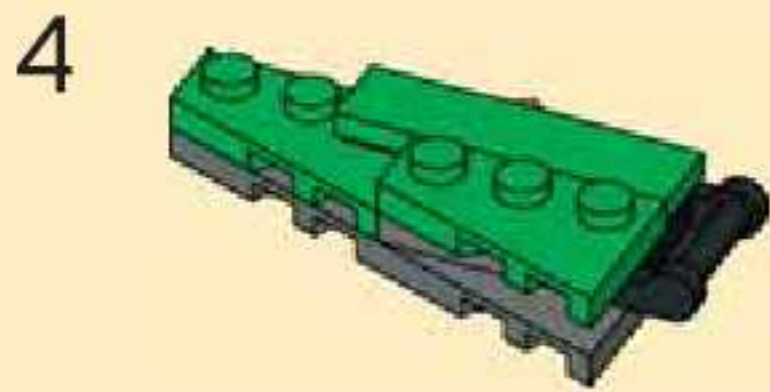
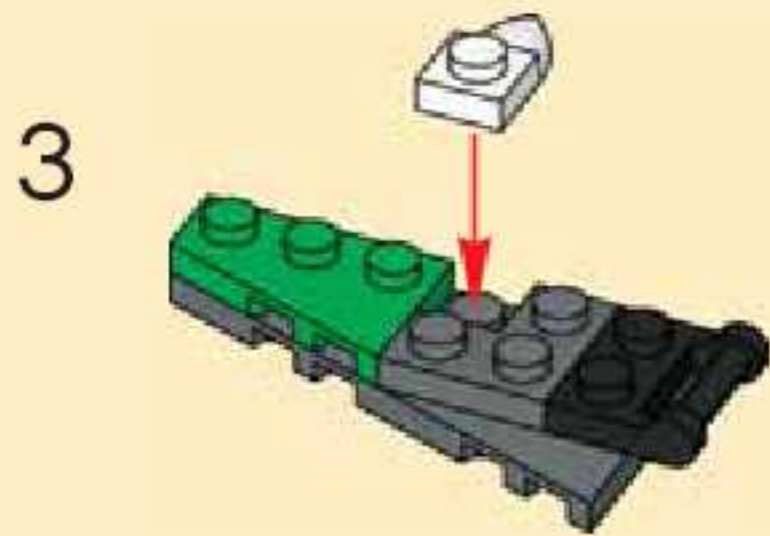
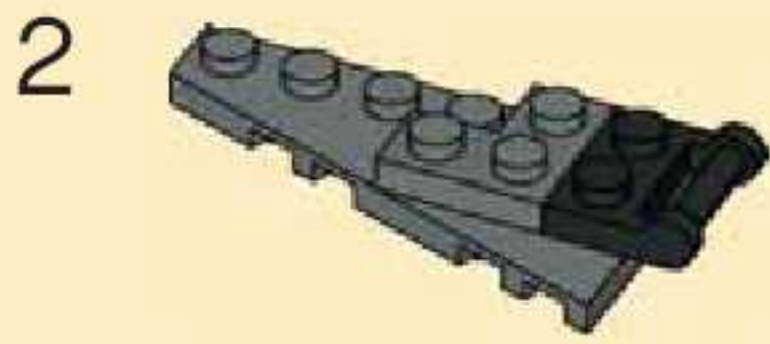
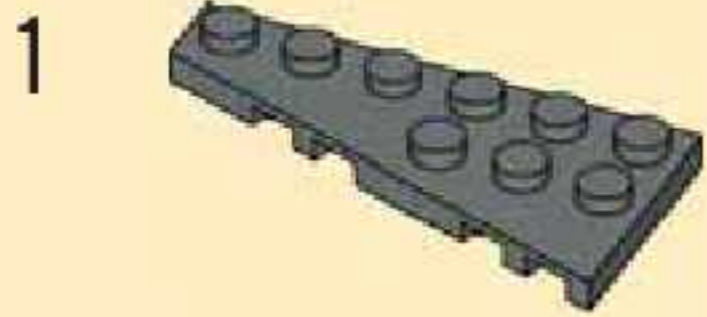

15

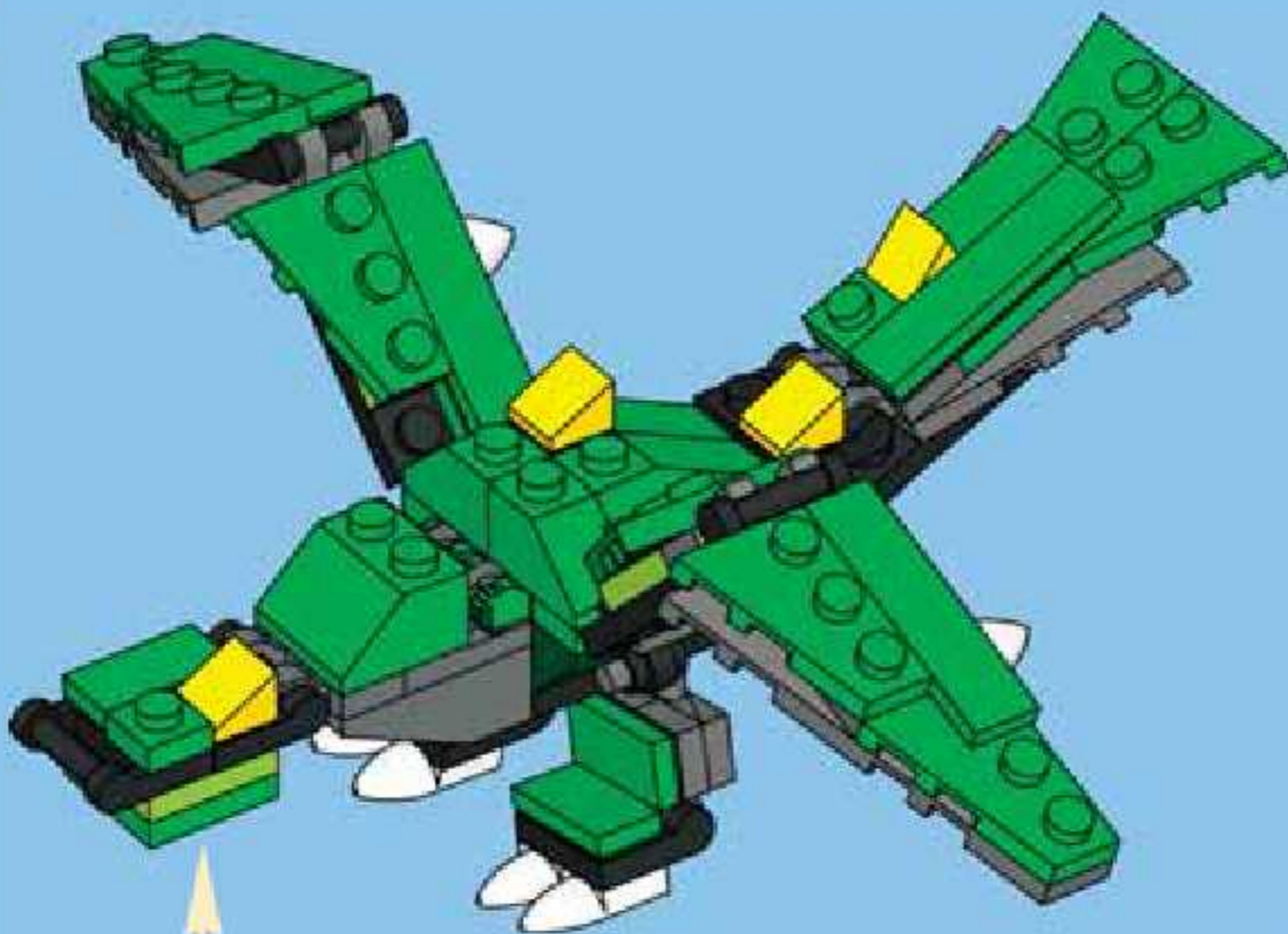

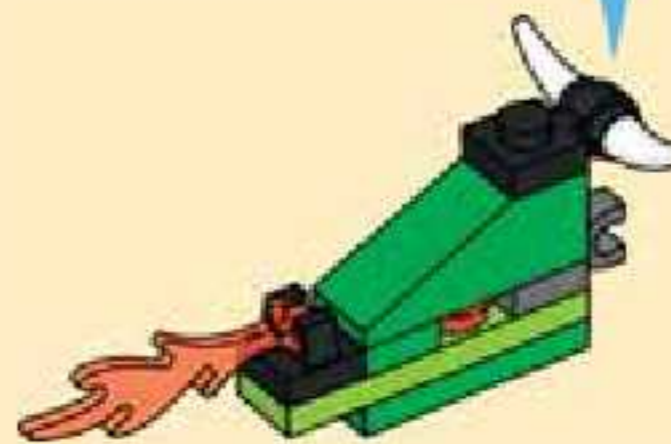
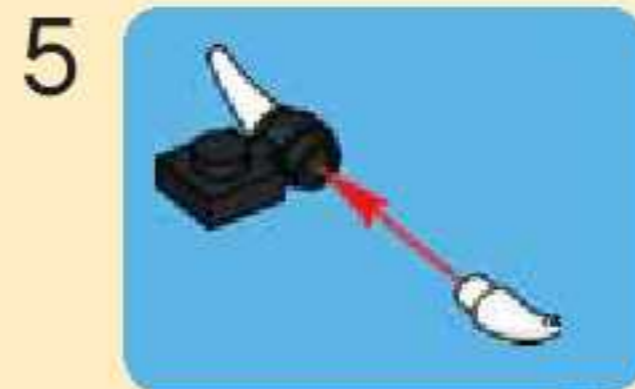
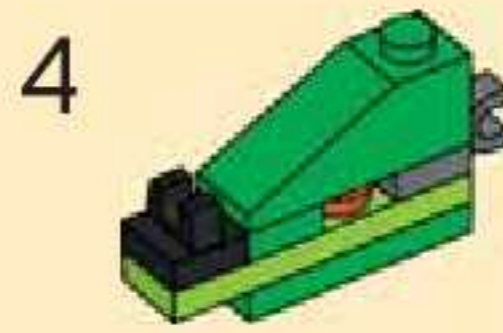
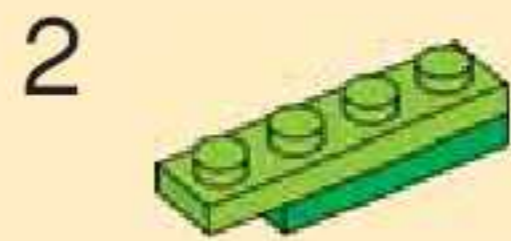

16





1

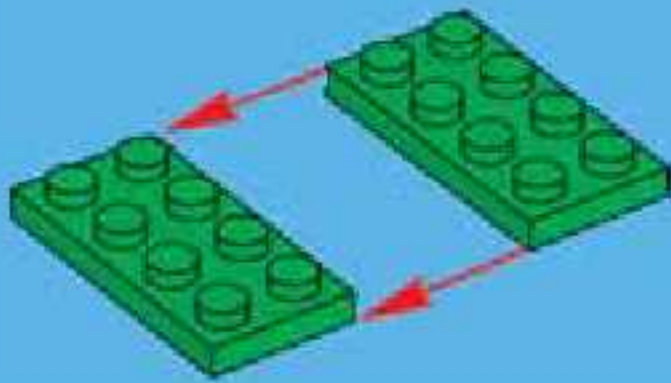

2

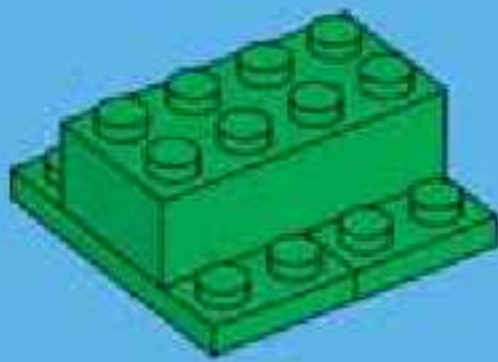

3

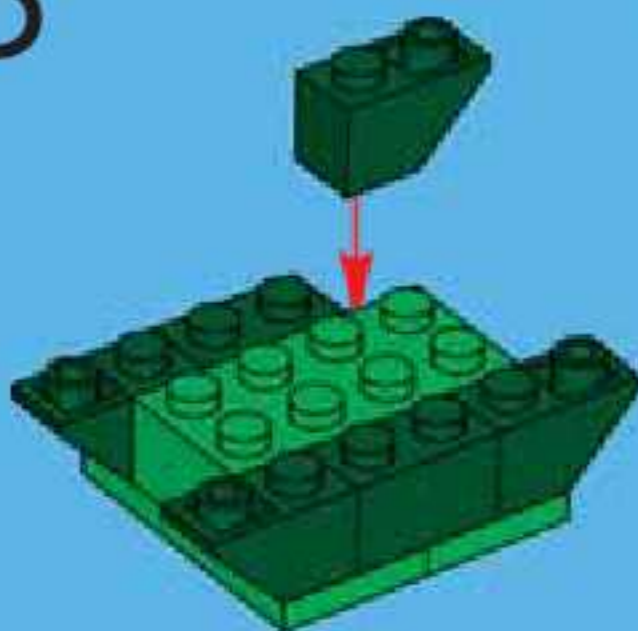

4

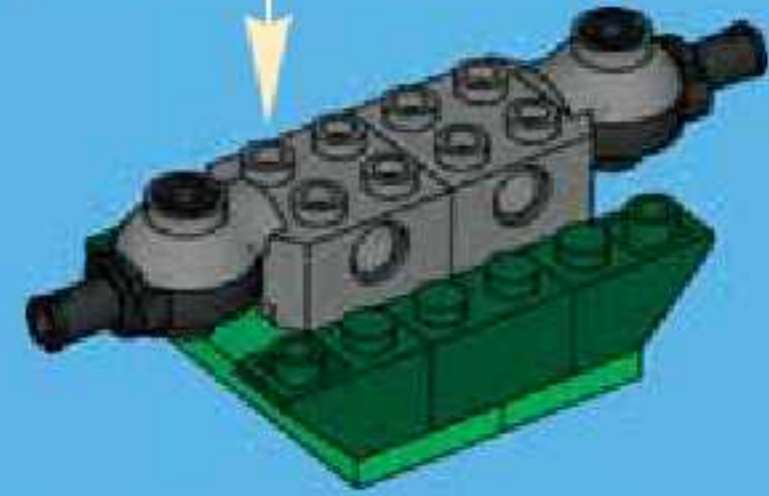

5

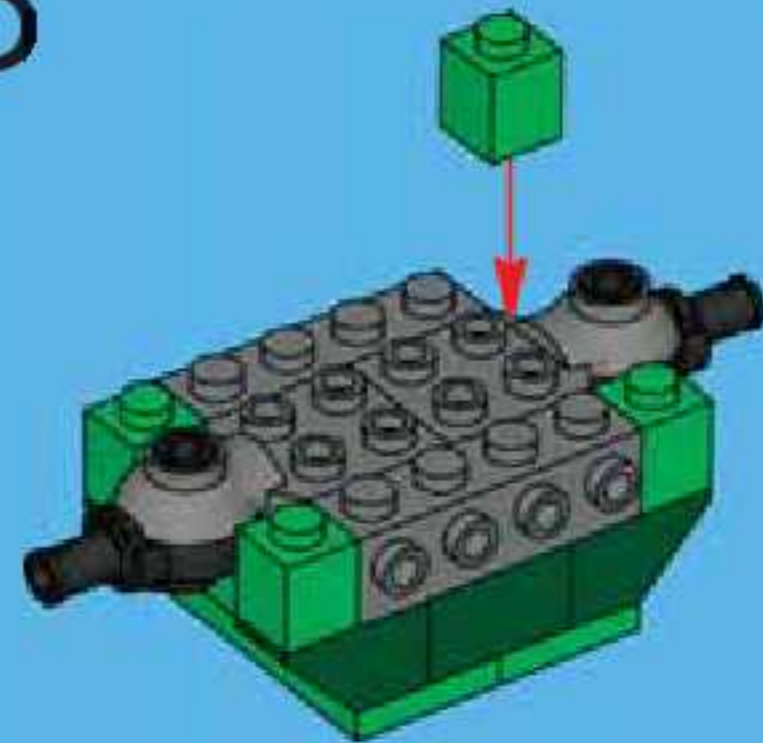

6

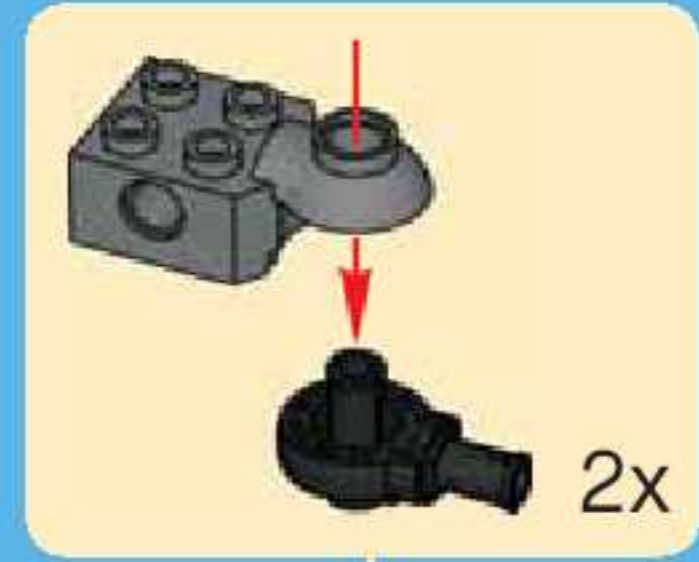
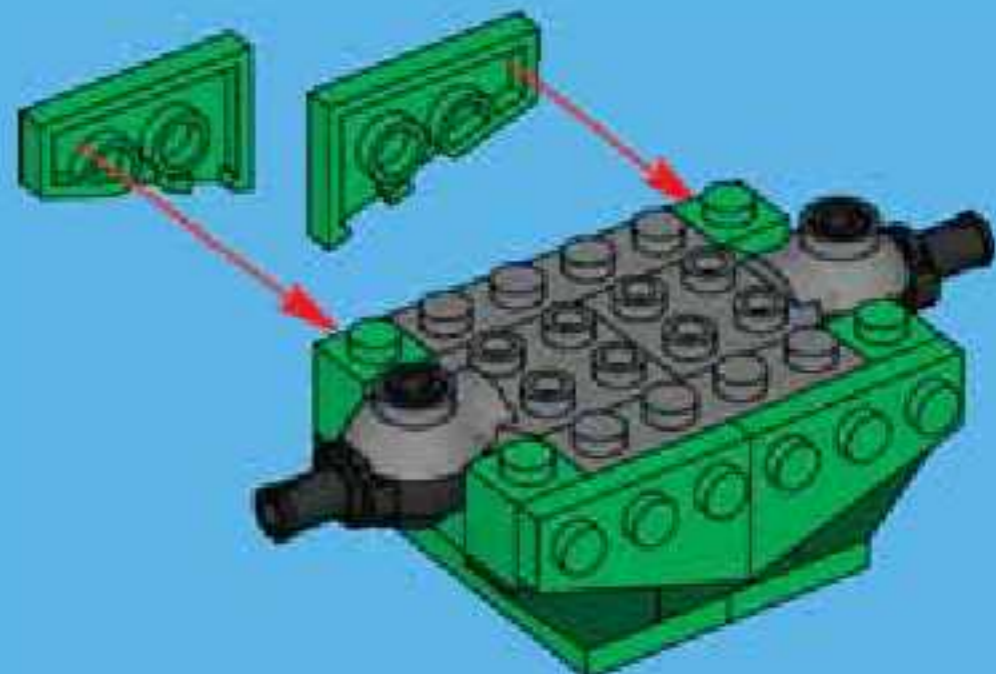

7

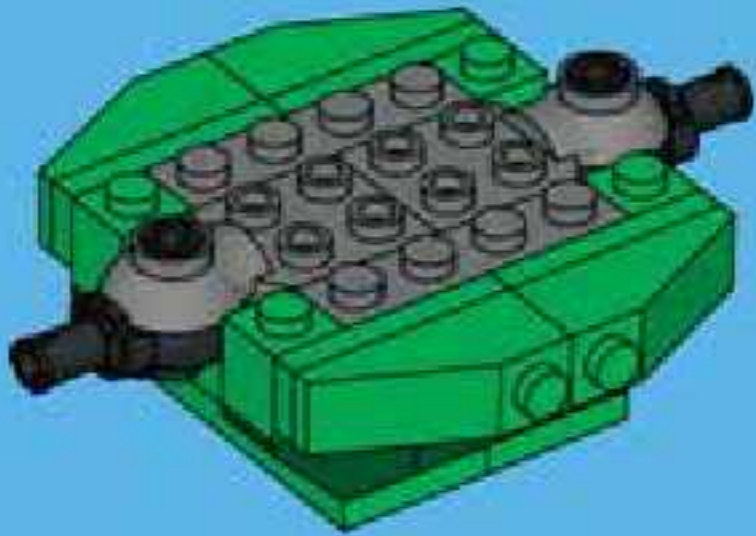

8

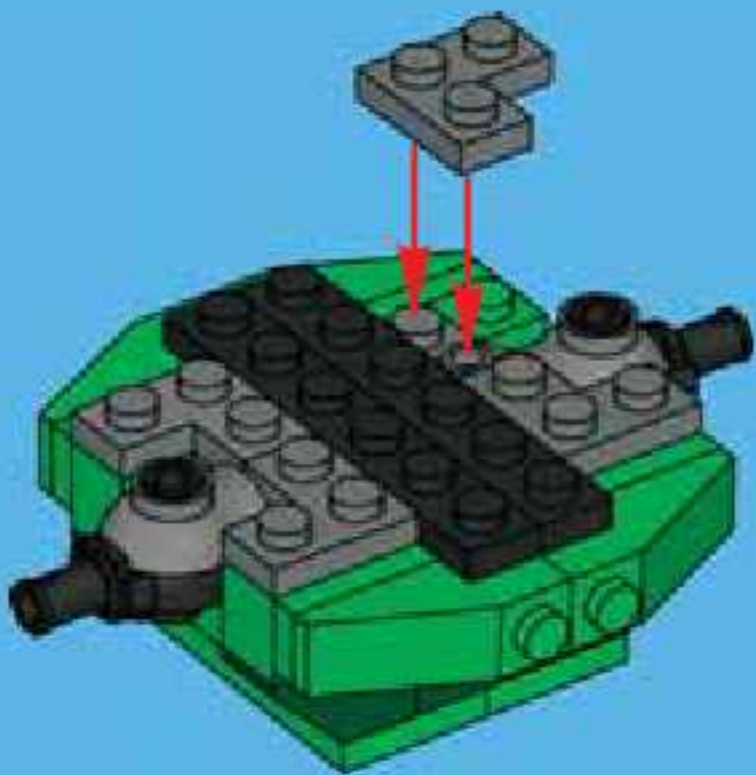

9

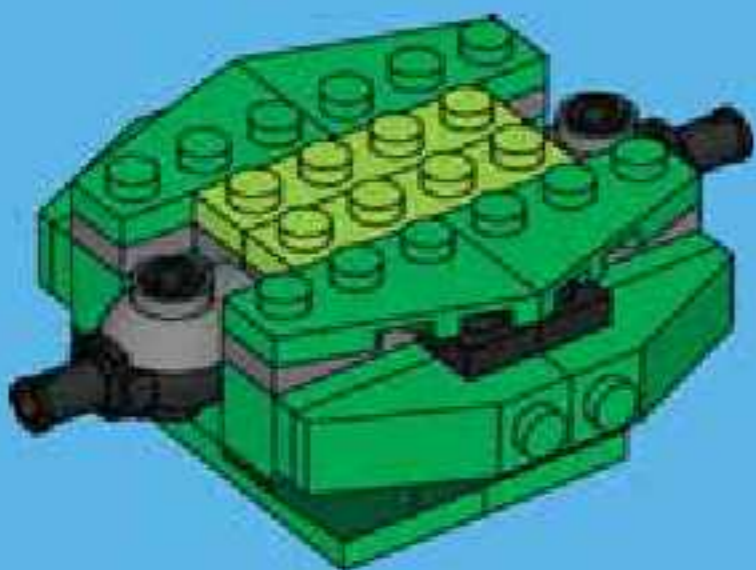

10

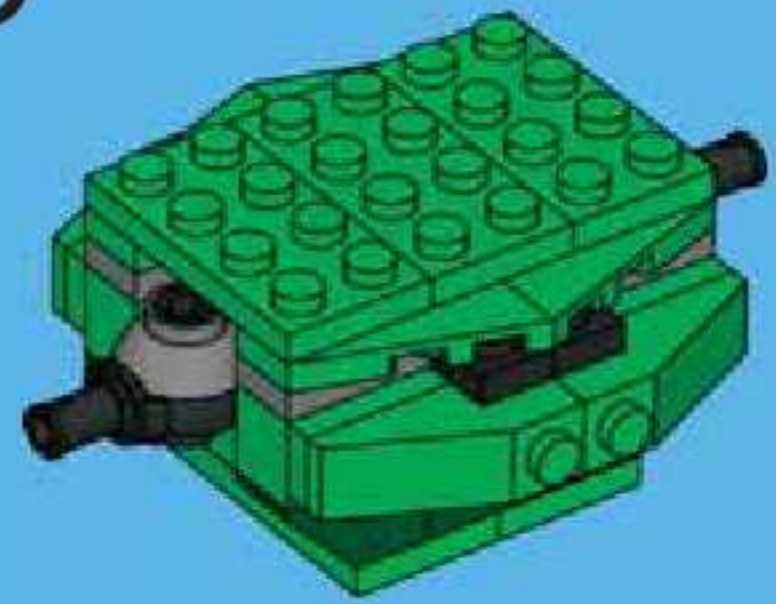

11

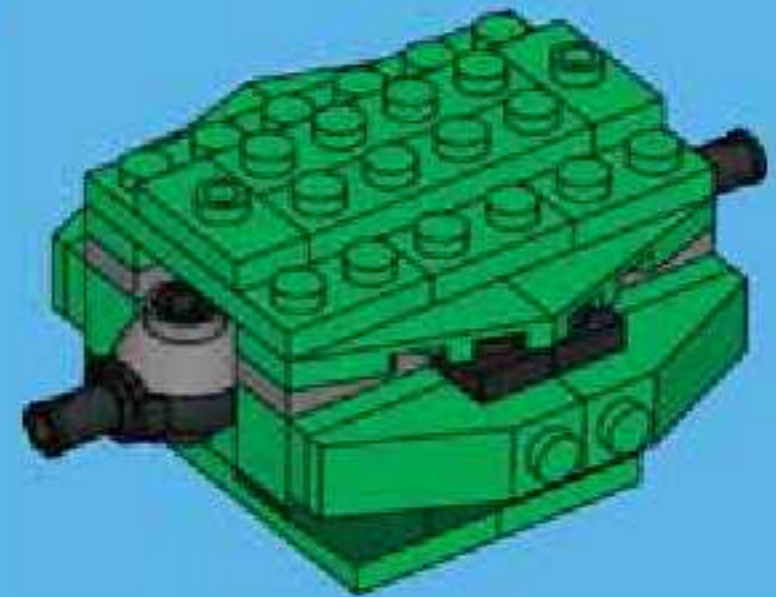

12

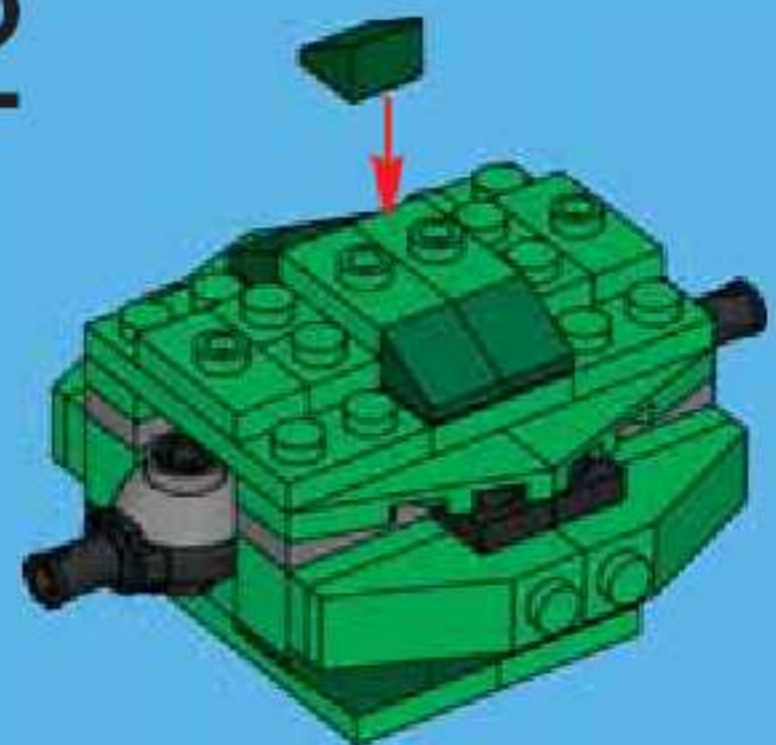

13

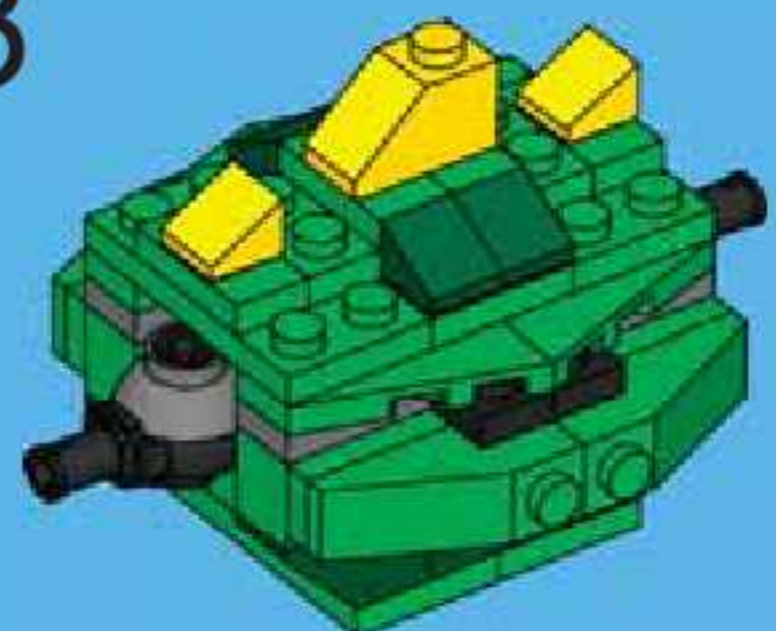

1



2

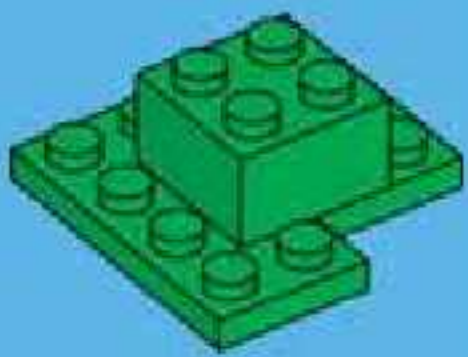

3

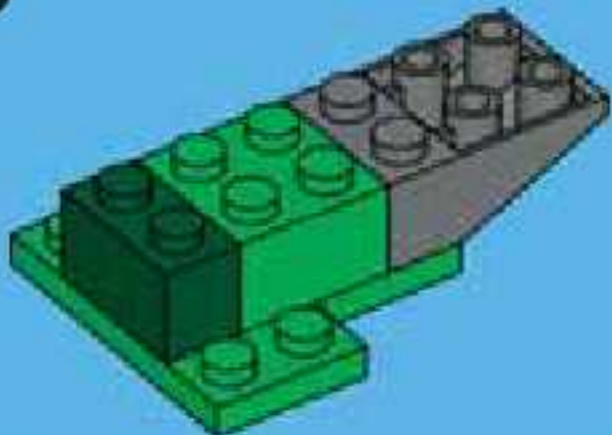

4

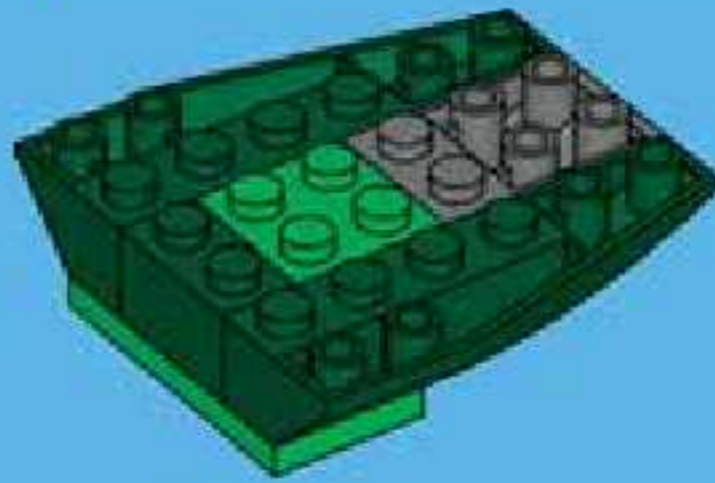

5

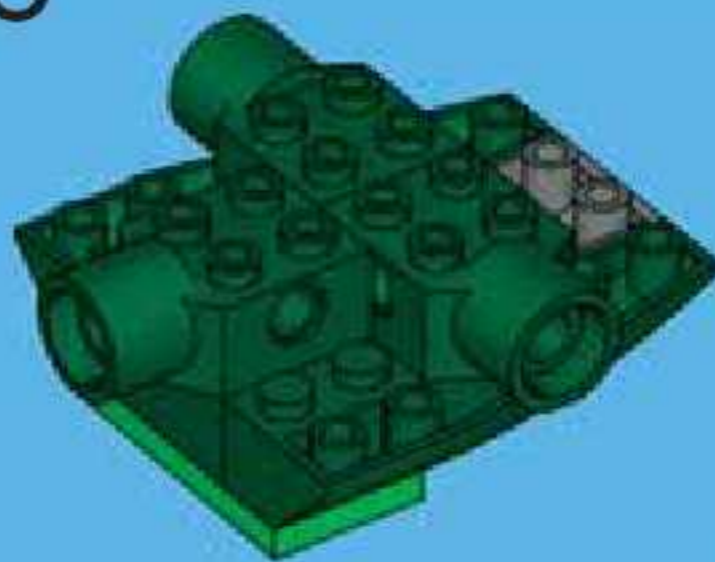

6

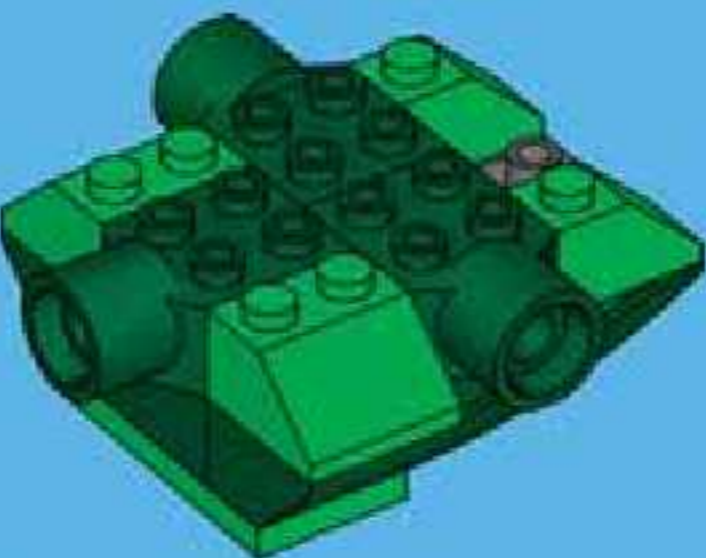

7

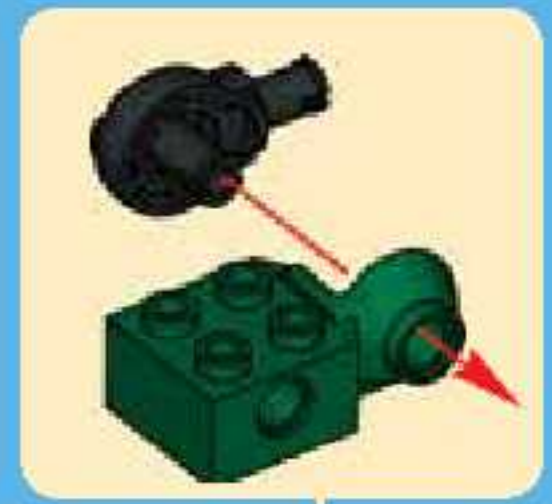
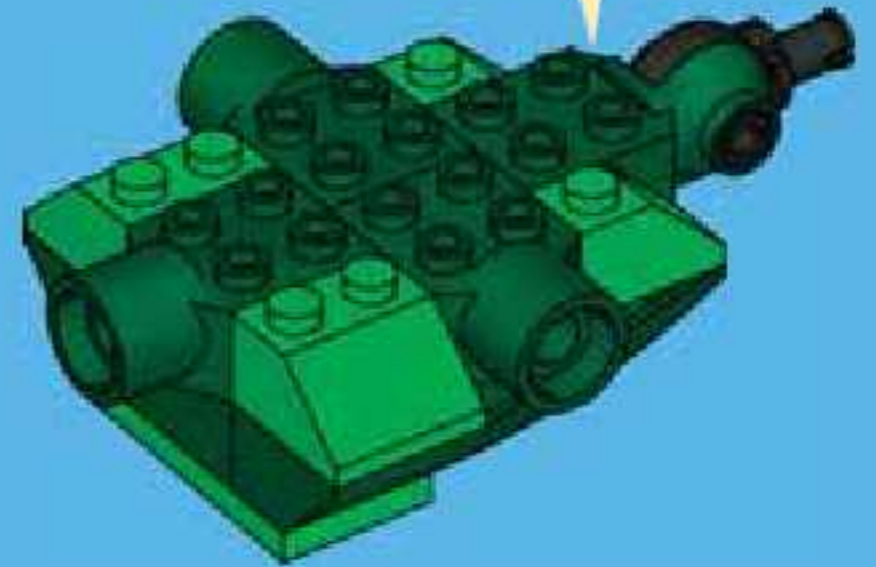

8

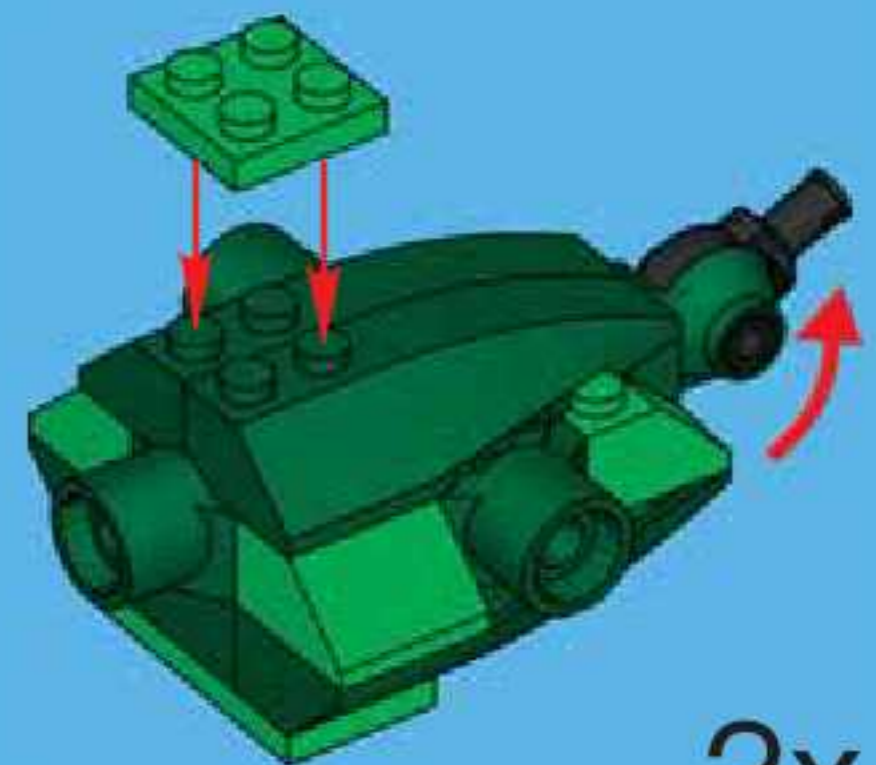

2x

14

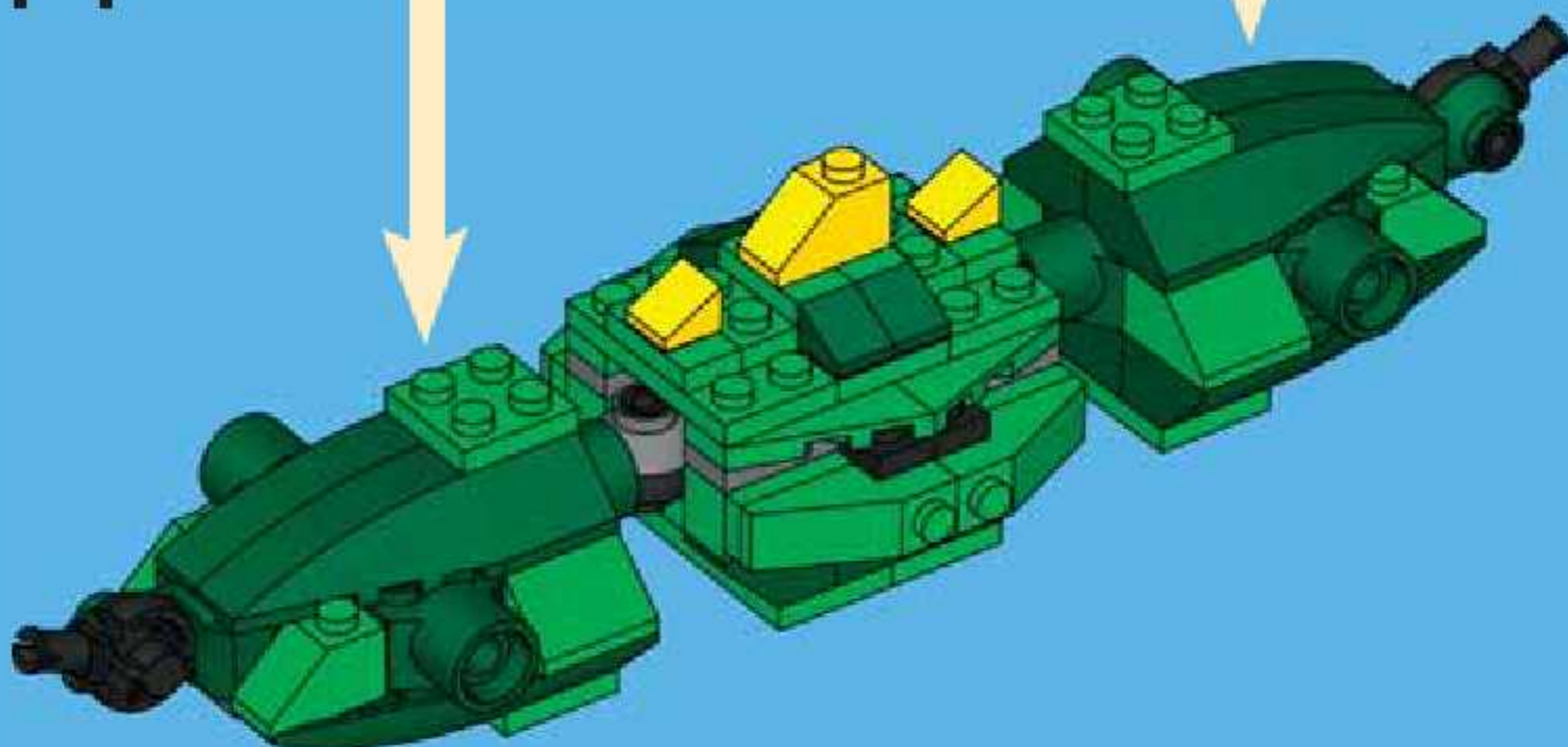

1

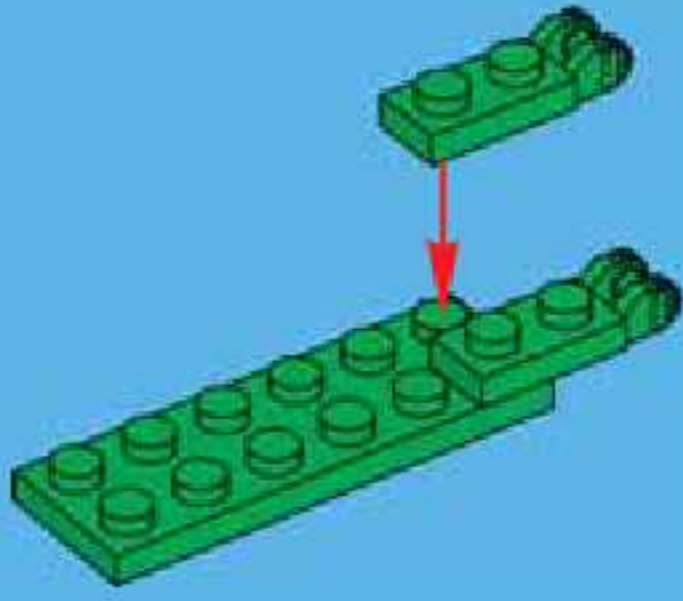

2

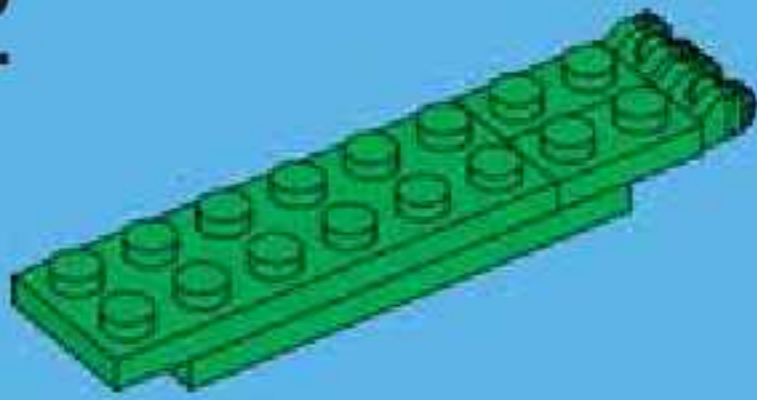

3

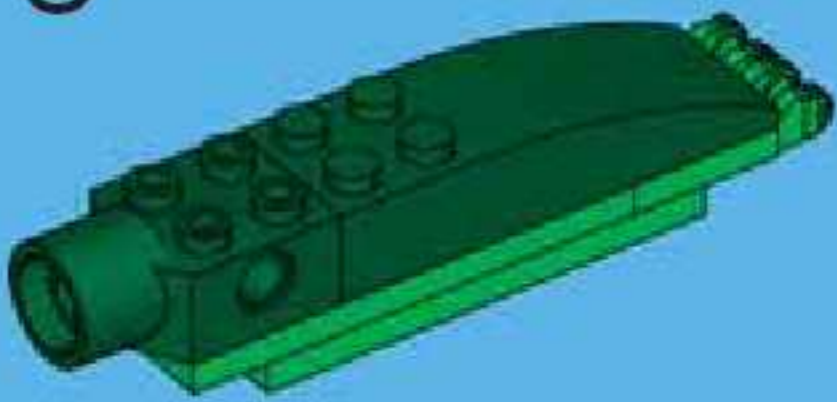

4

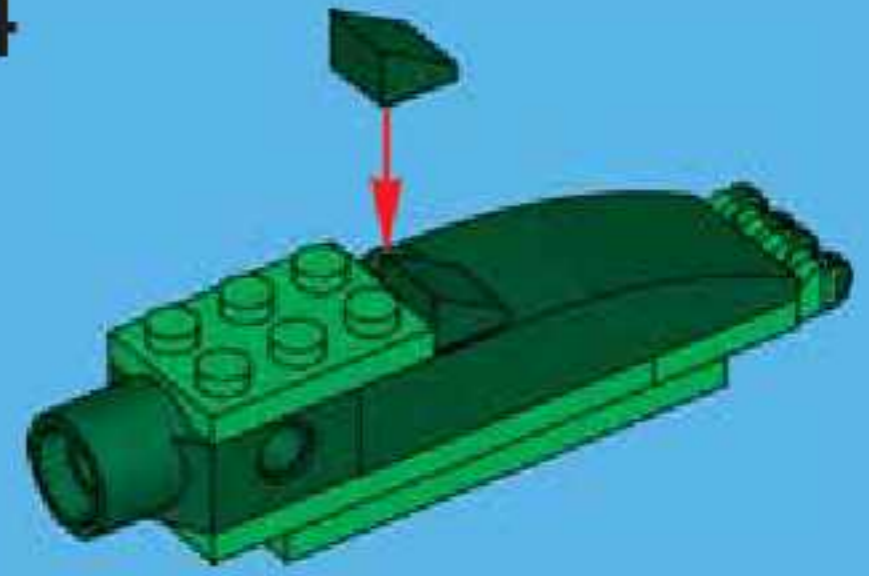

5

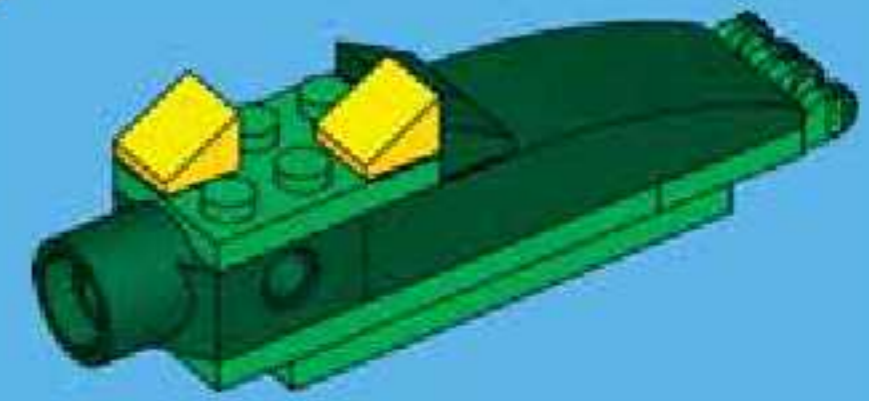

15

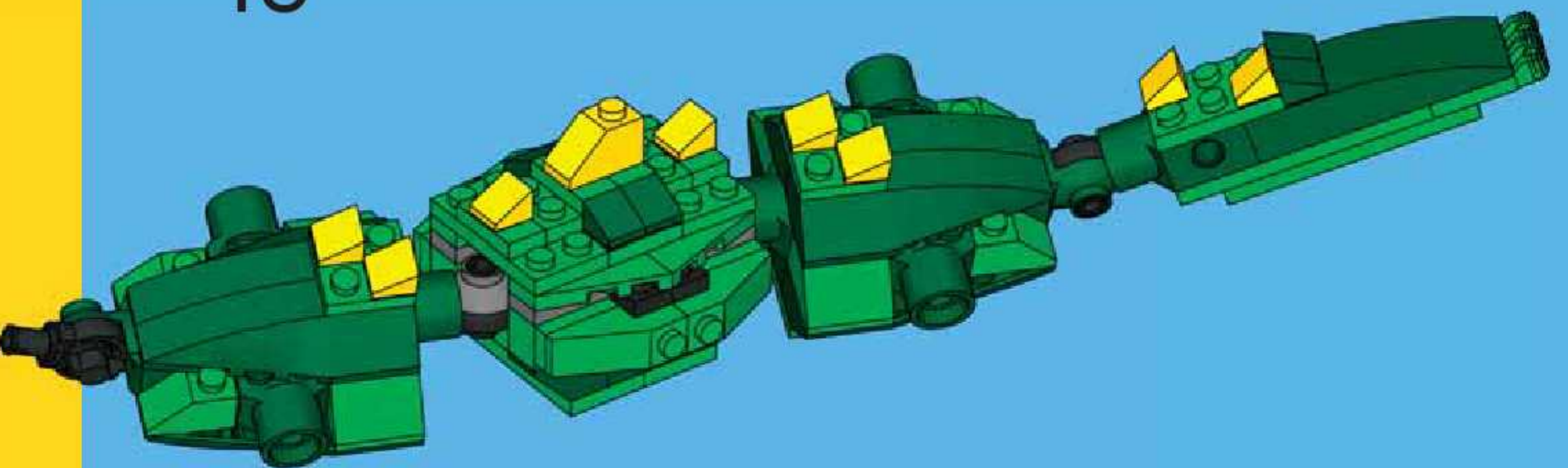

1

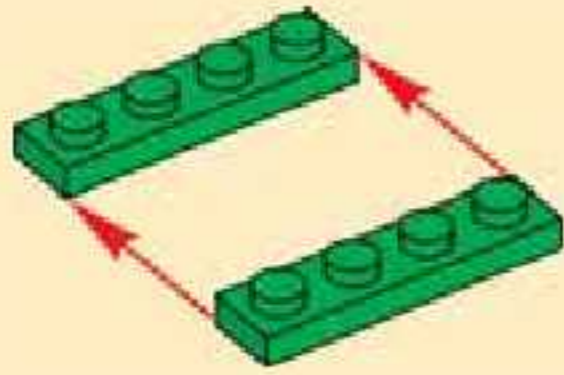

2

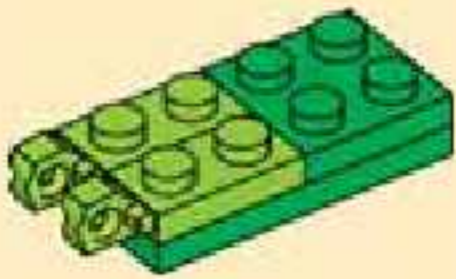

3

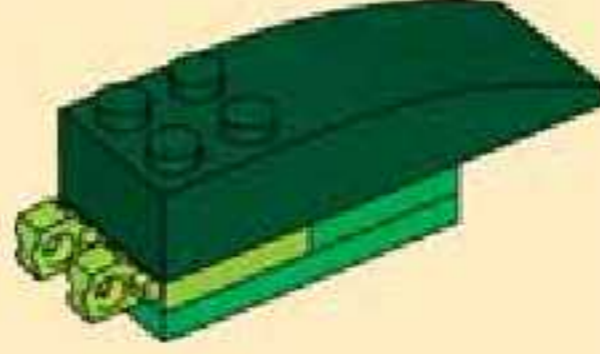

4

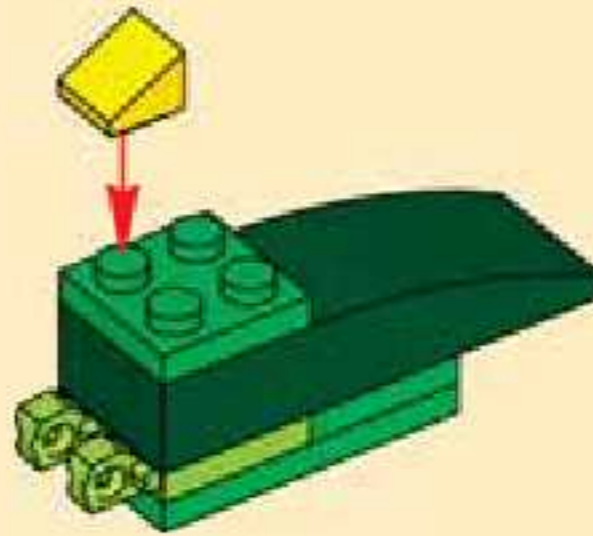

16

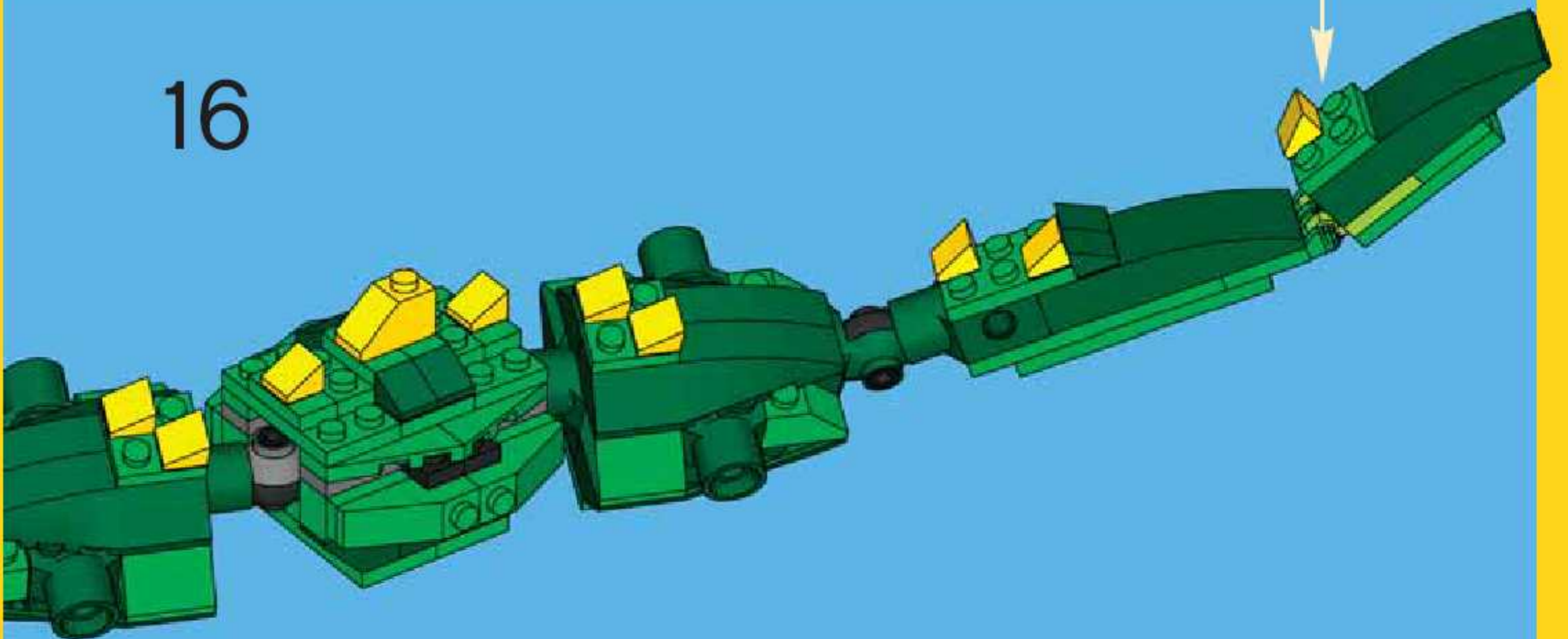

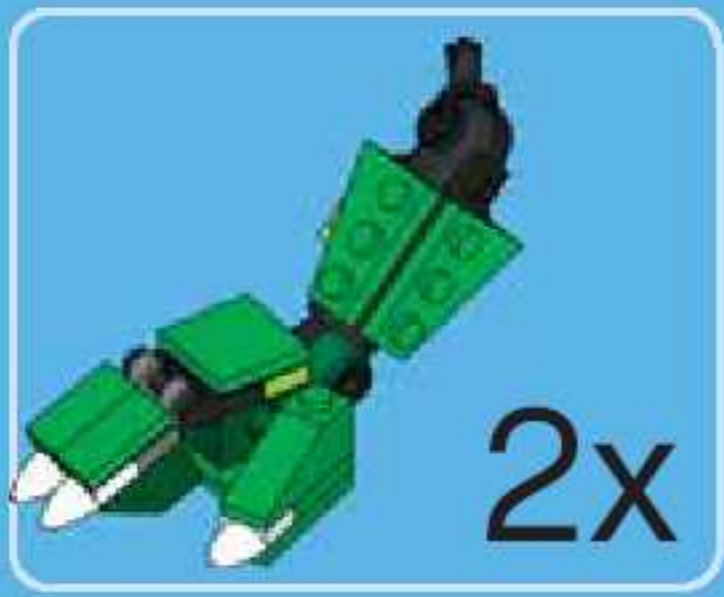

1

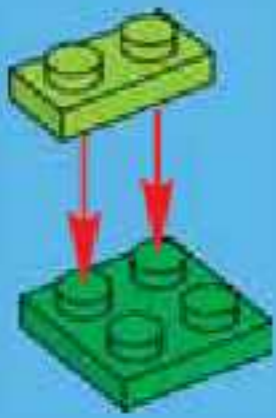

2



3

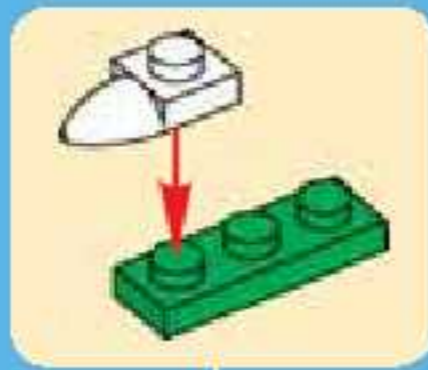

4

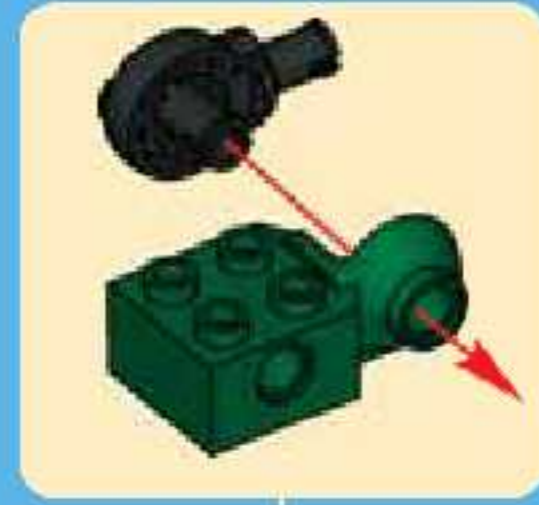

5



6

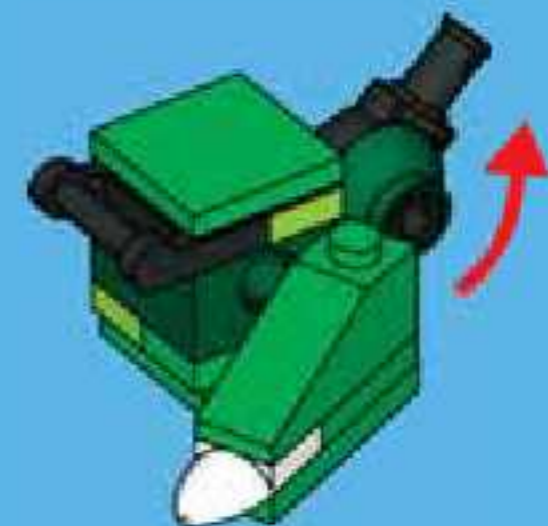

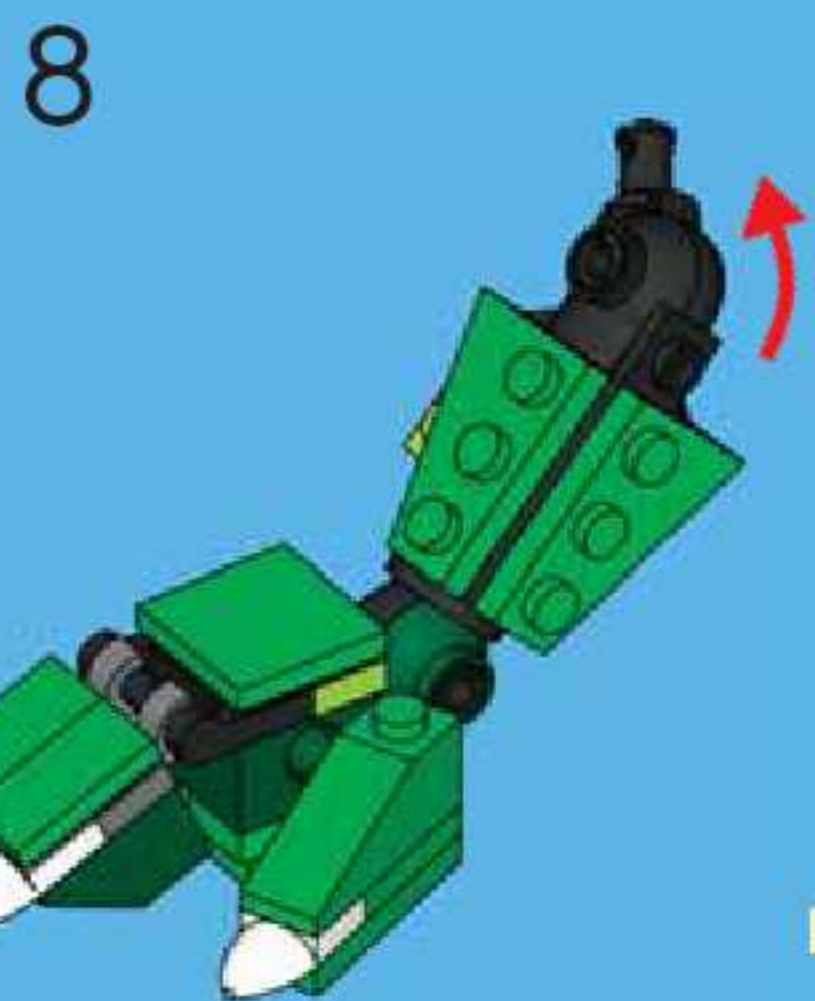
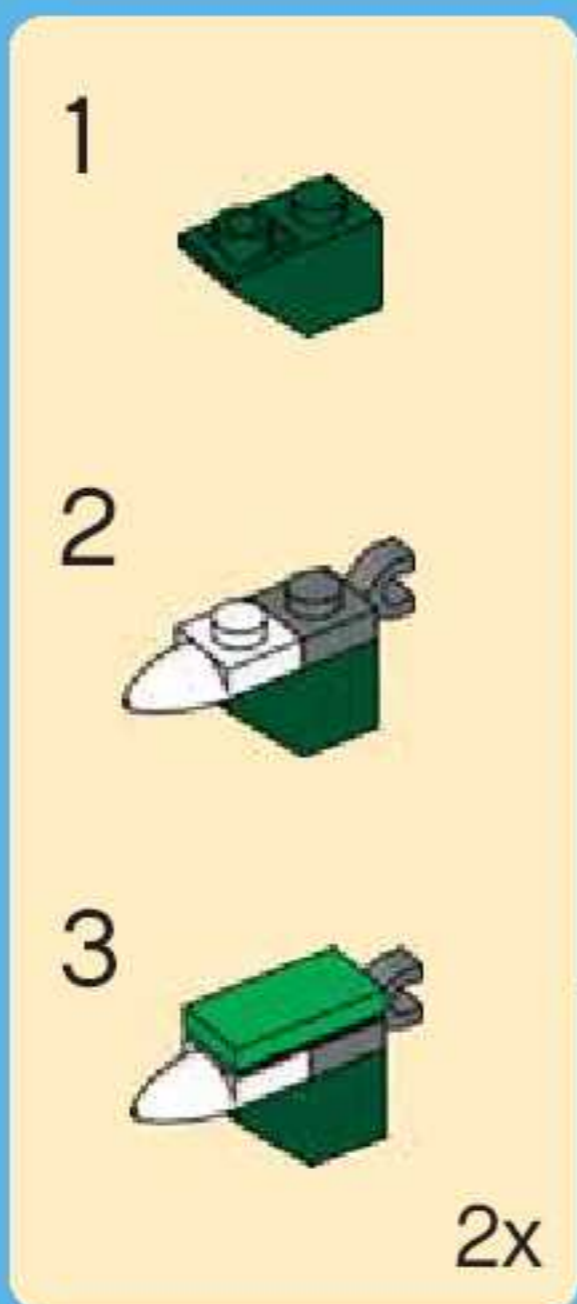
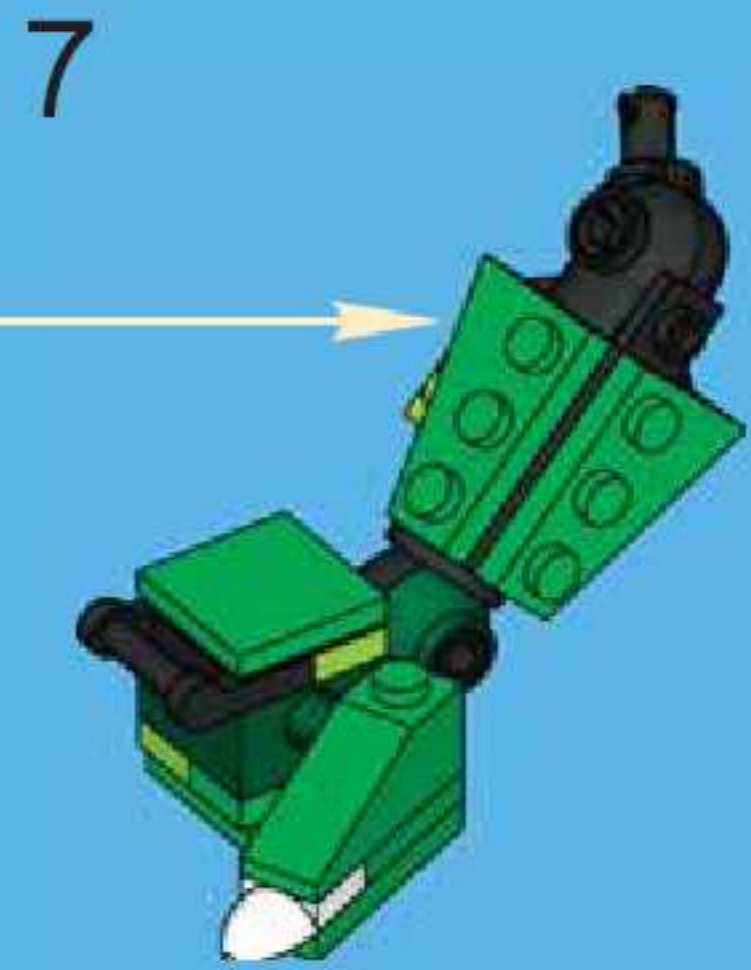
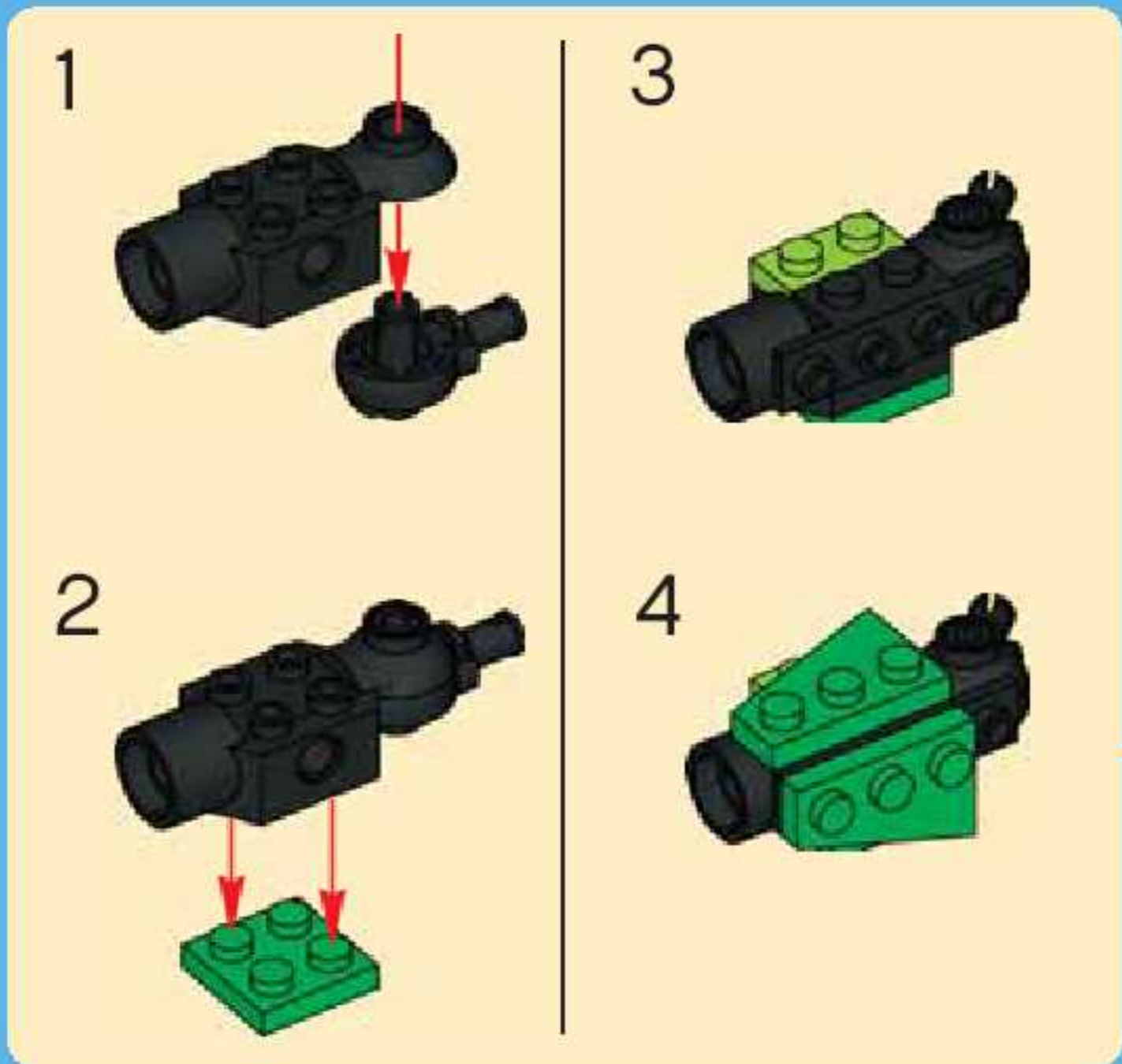

2x

17

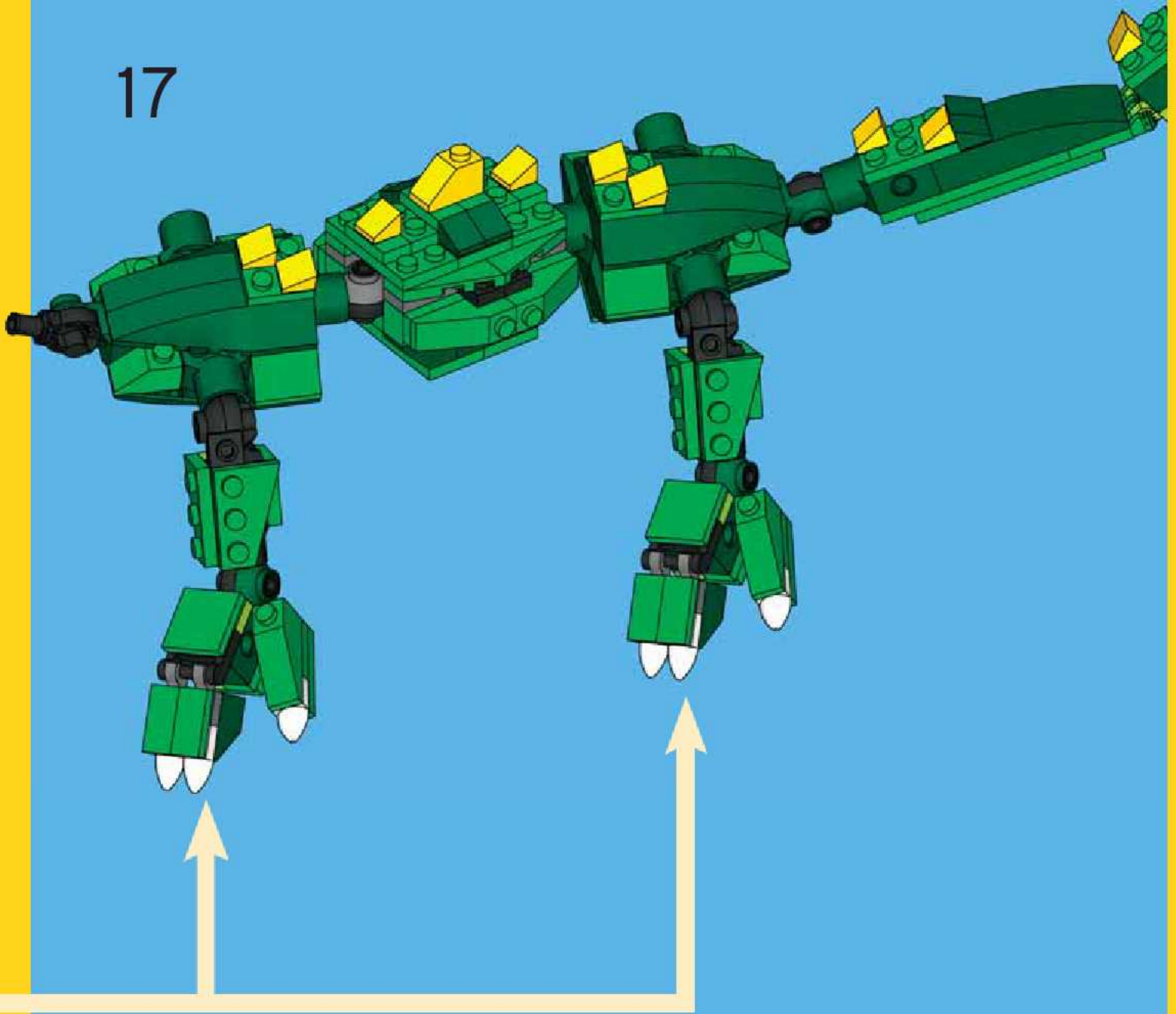

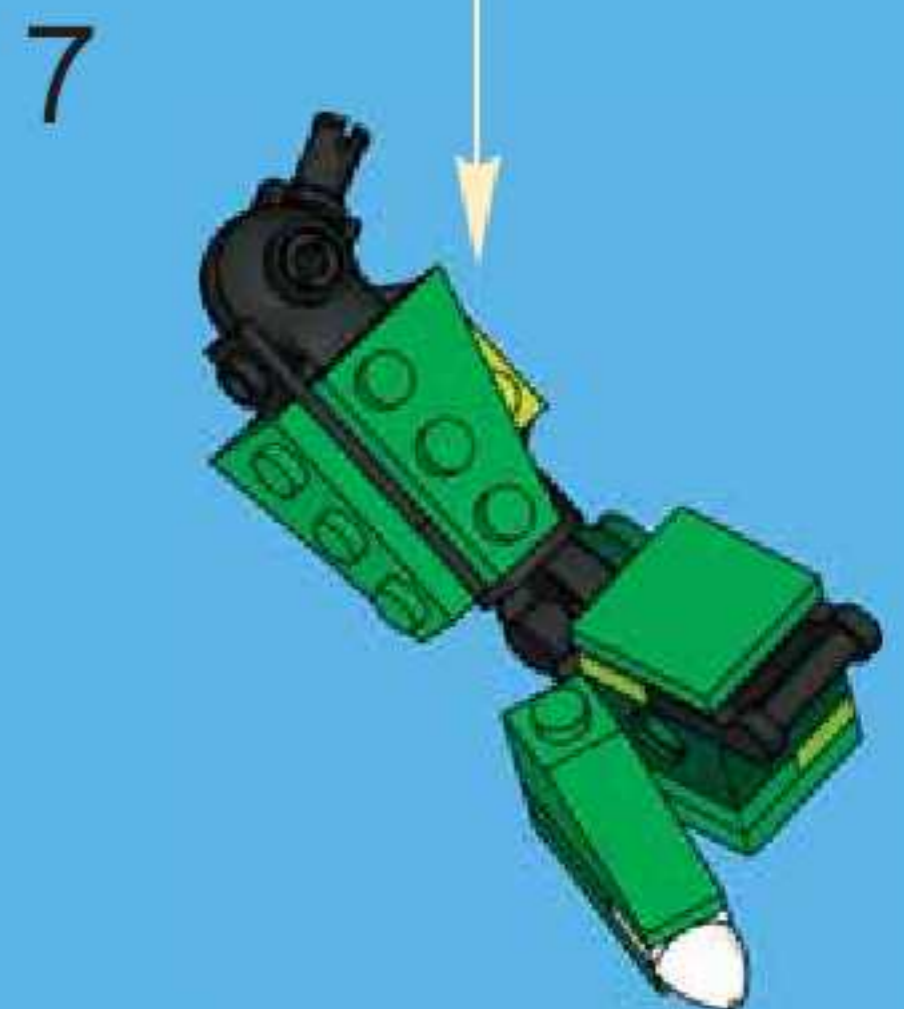
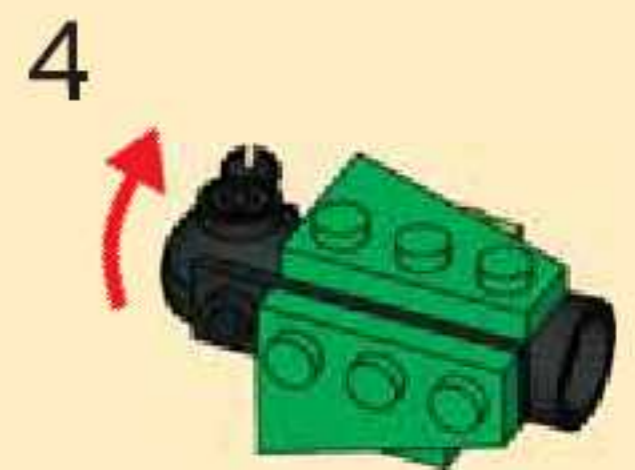
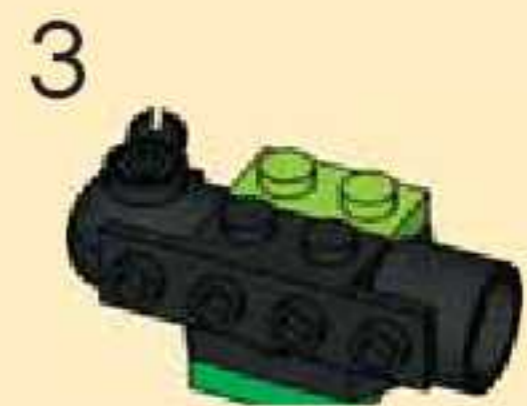
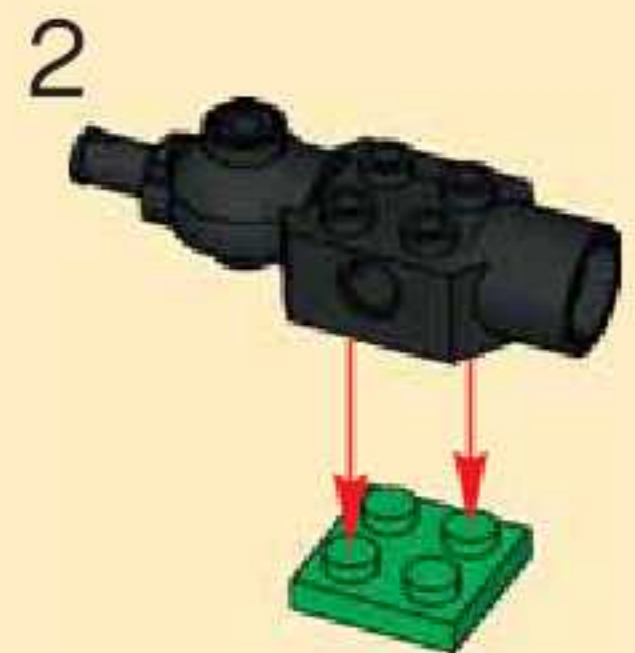
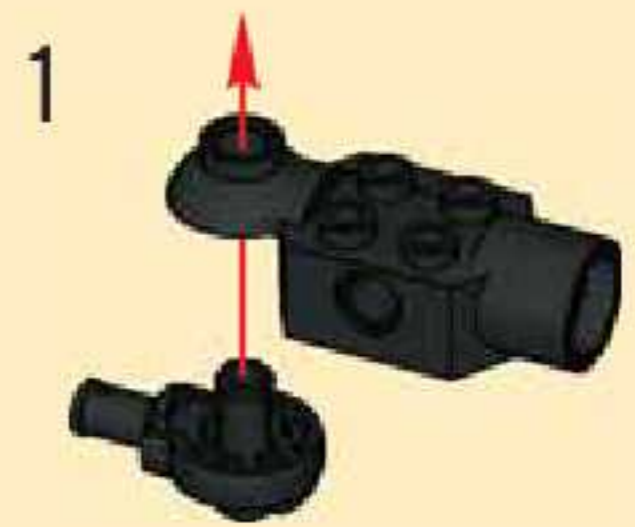
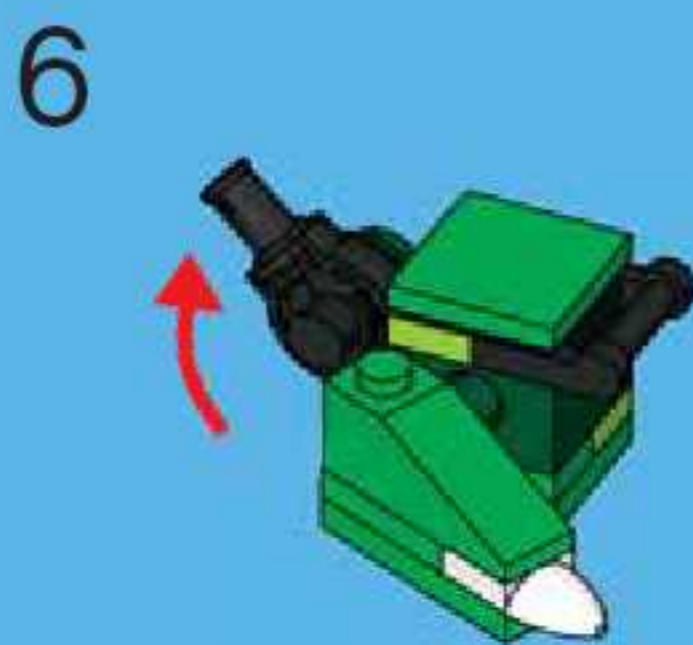
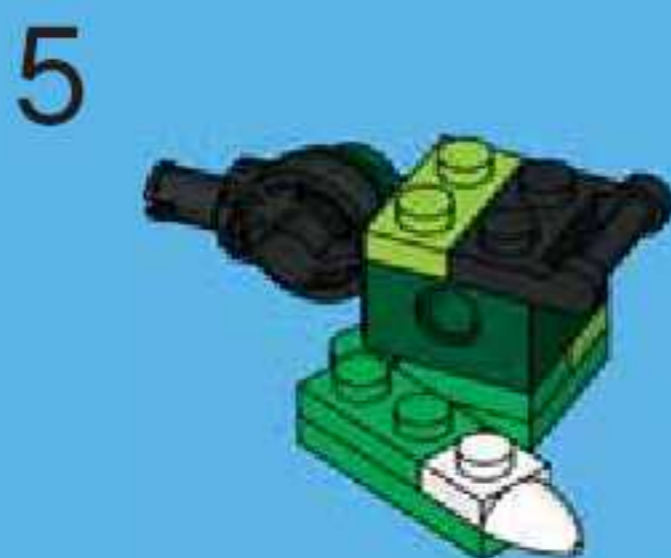
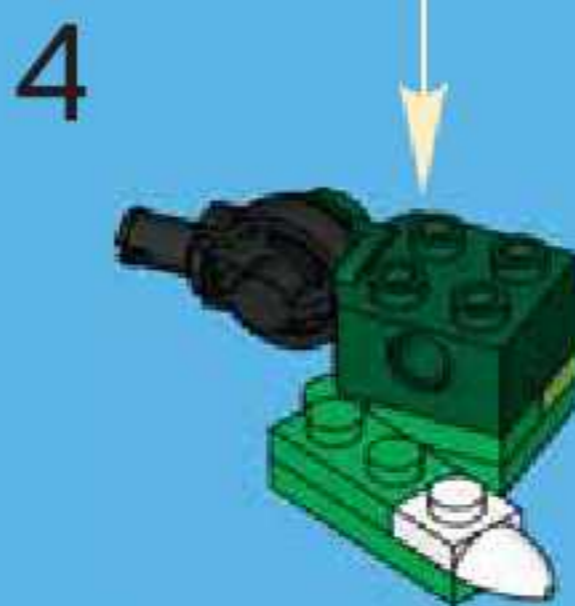
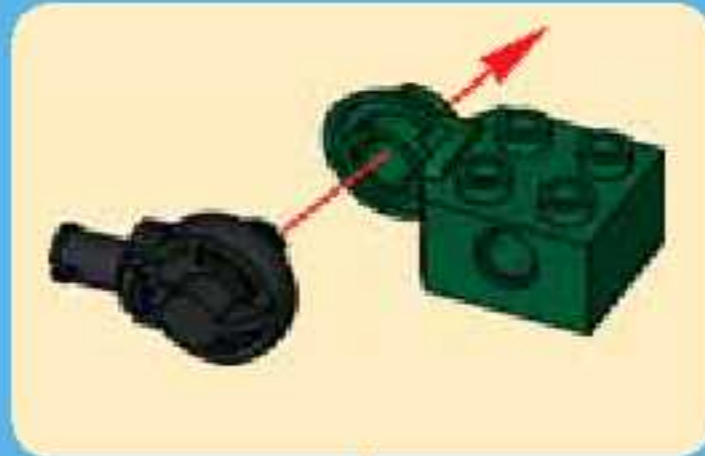
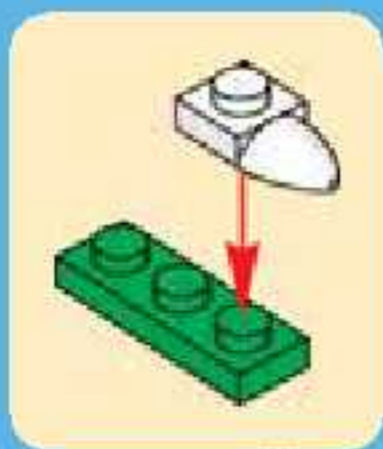
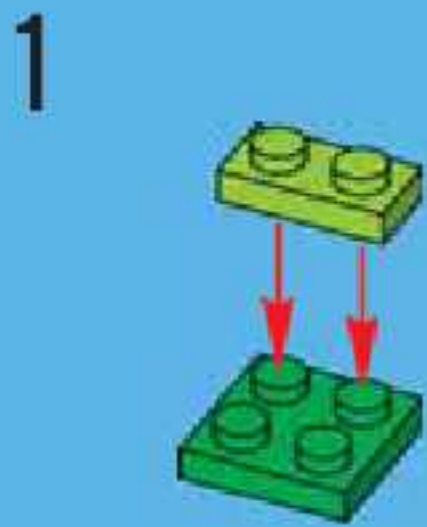
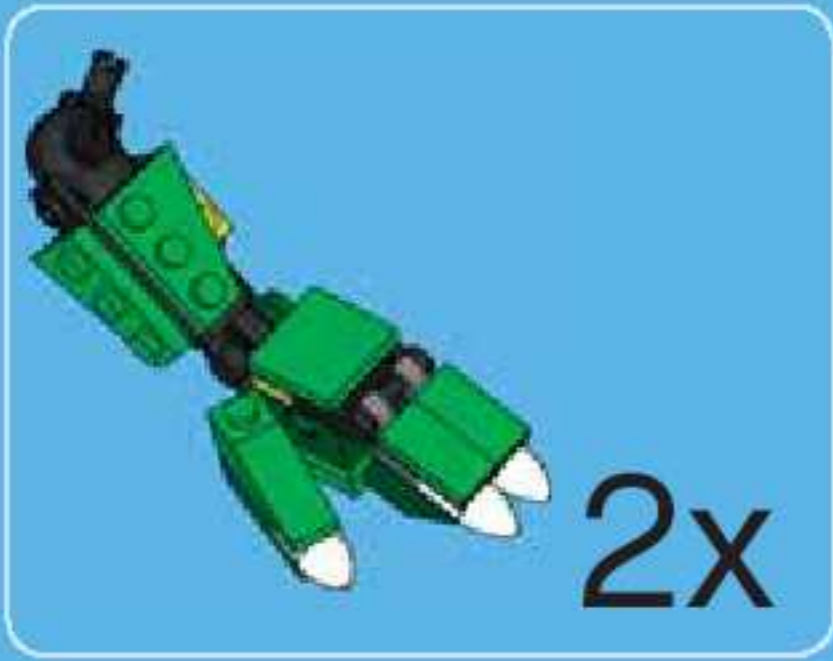

8

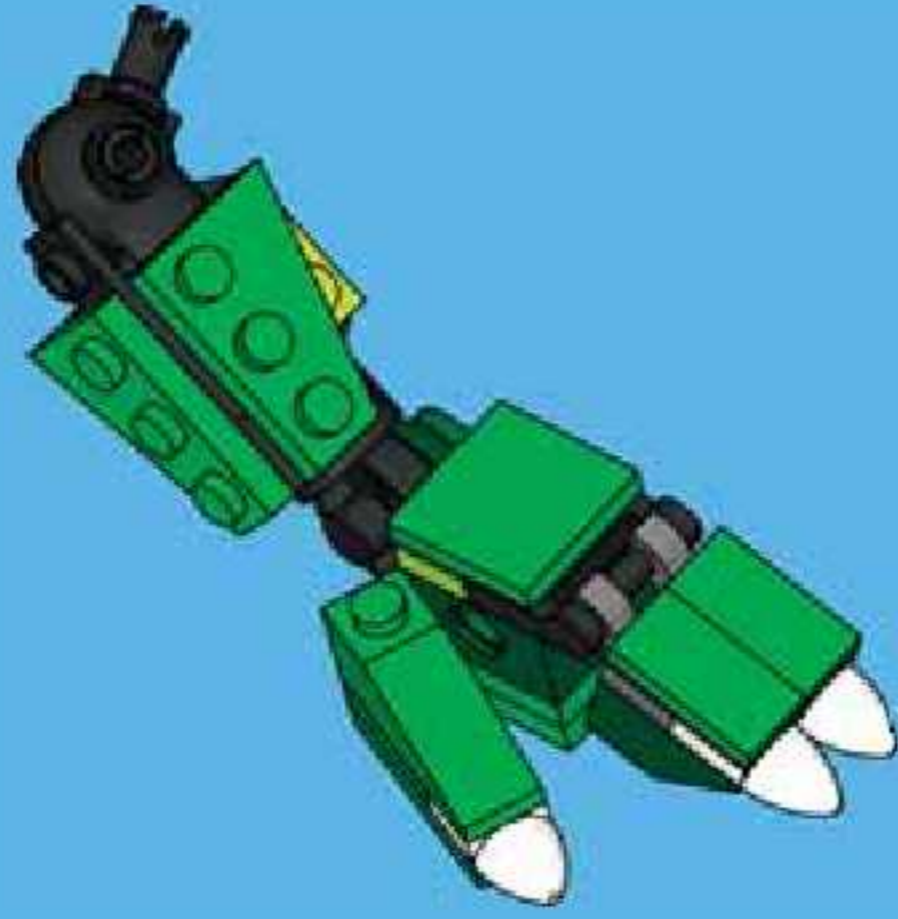

- 1
- 2
- 3 2x

2x

18

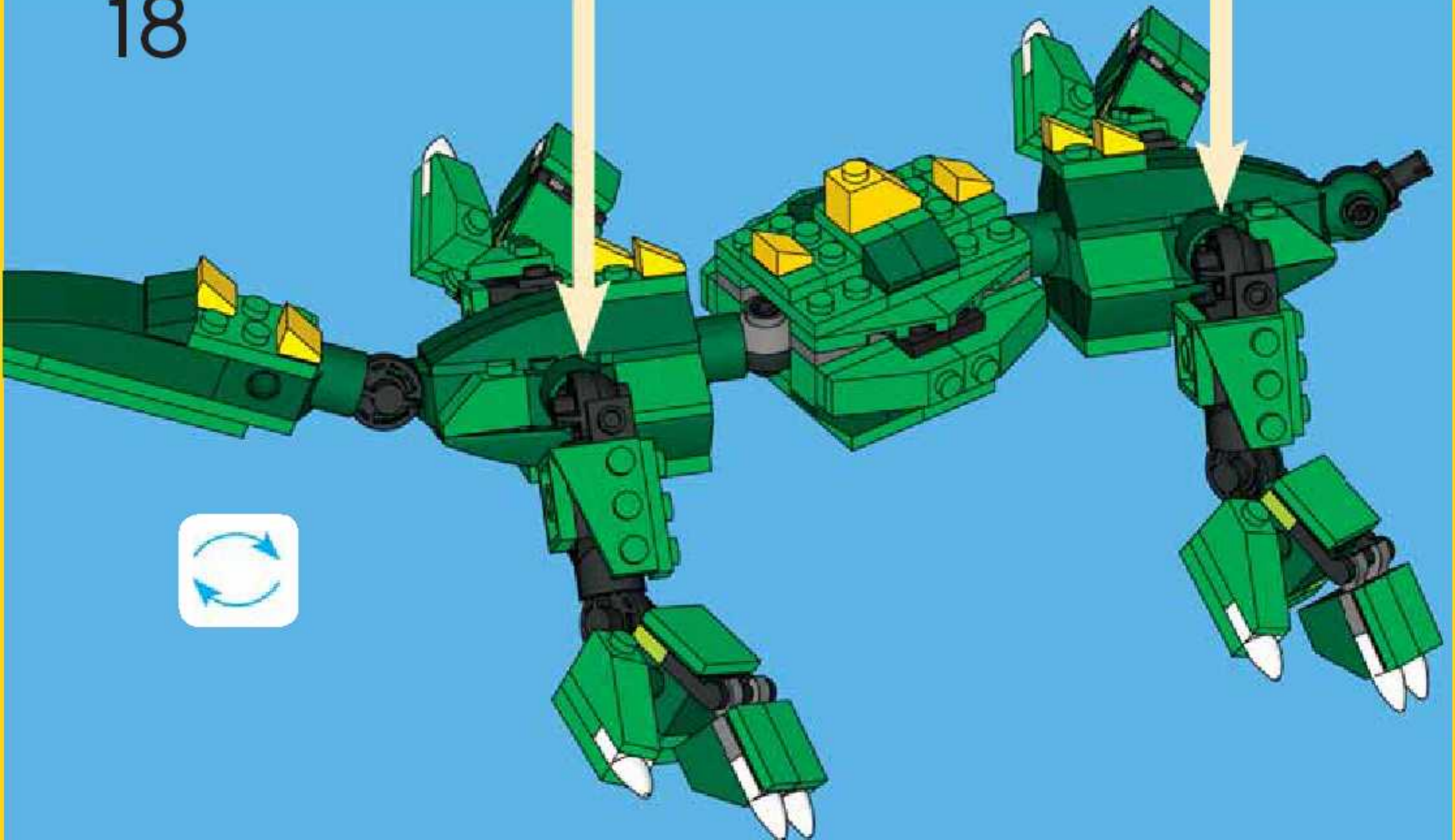

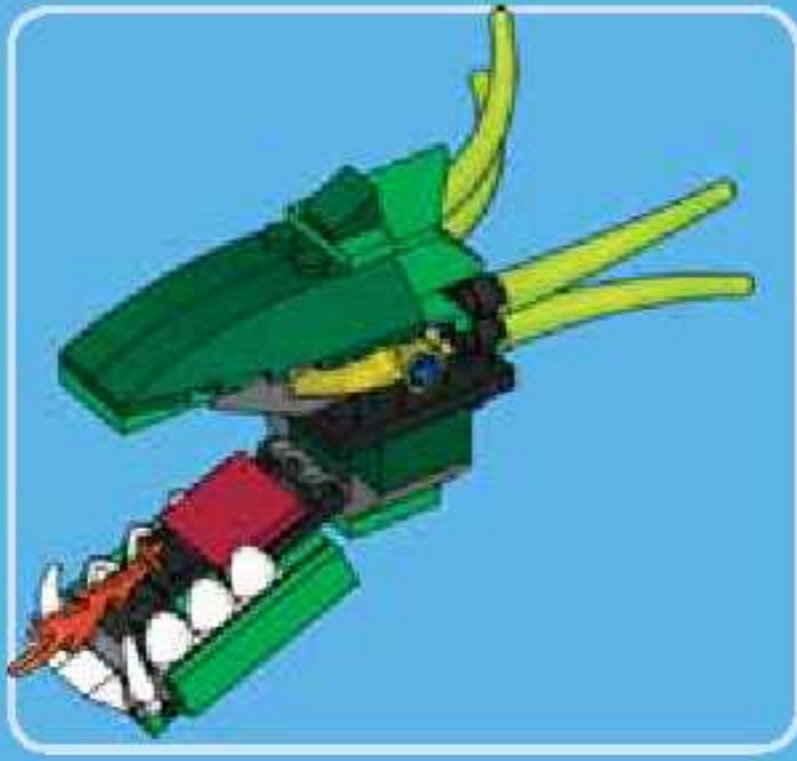

1

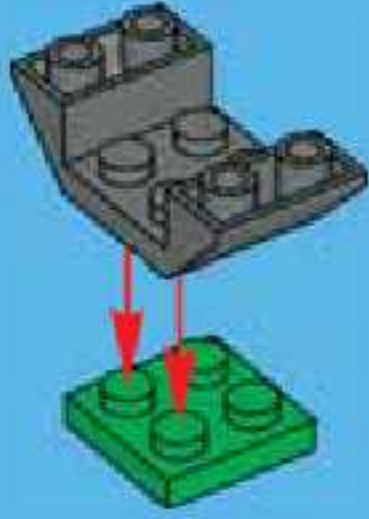

2



3



4

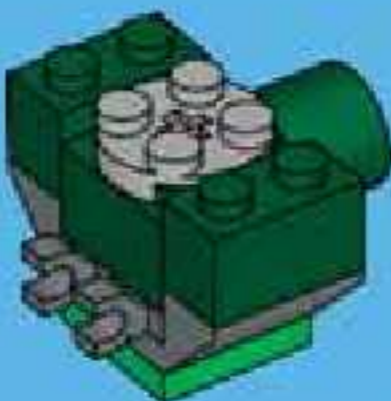

5



1



2



3



6



7

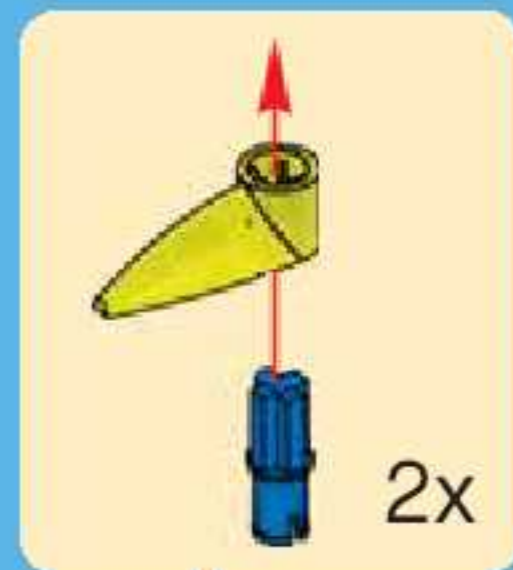

8

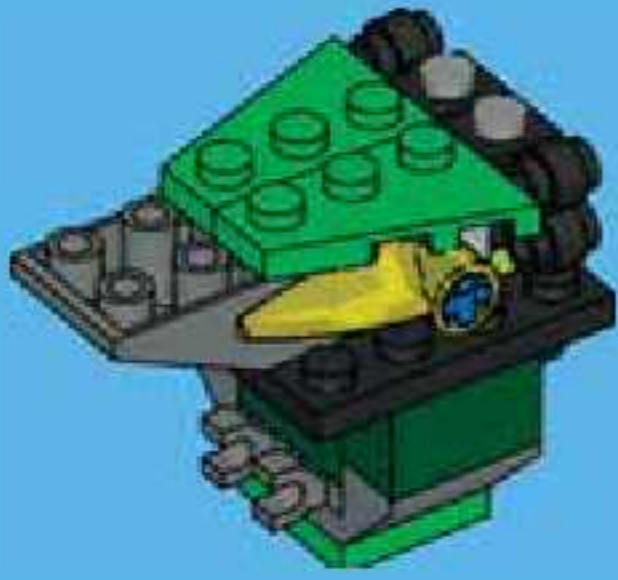

9

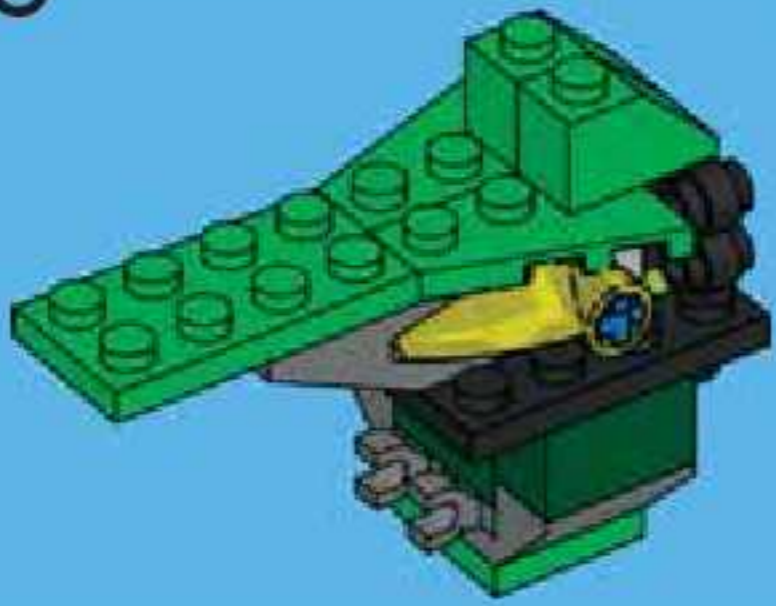

10

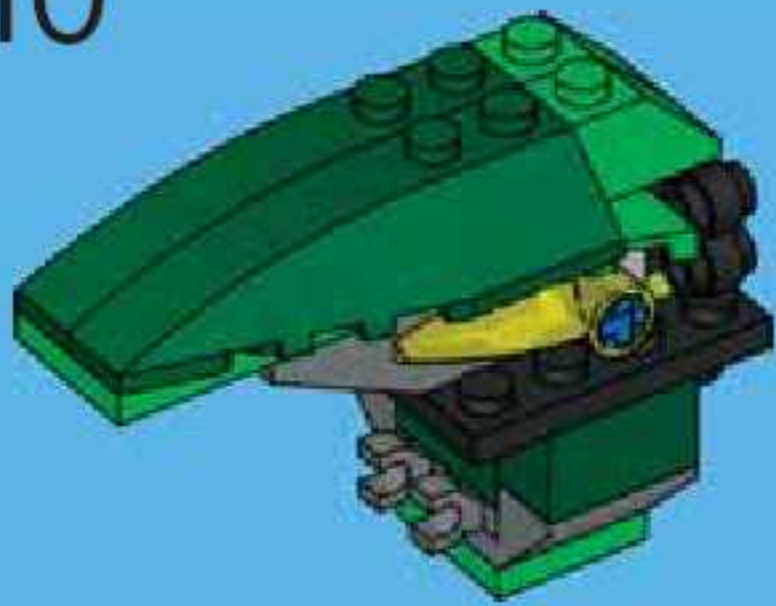

11

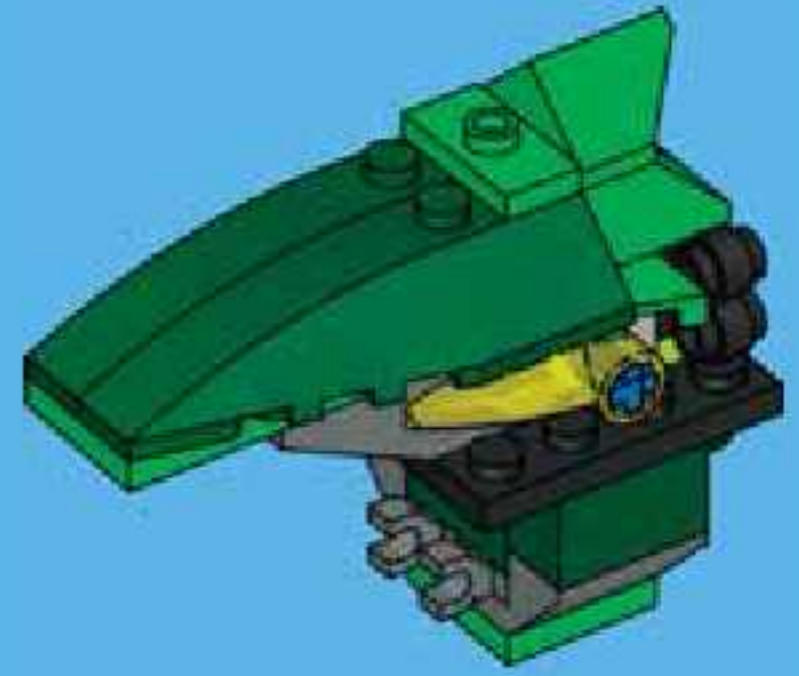

12

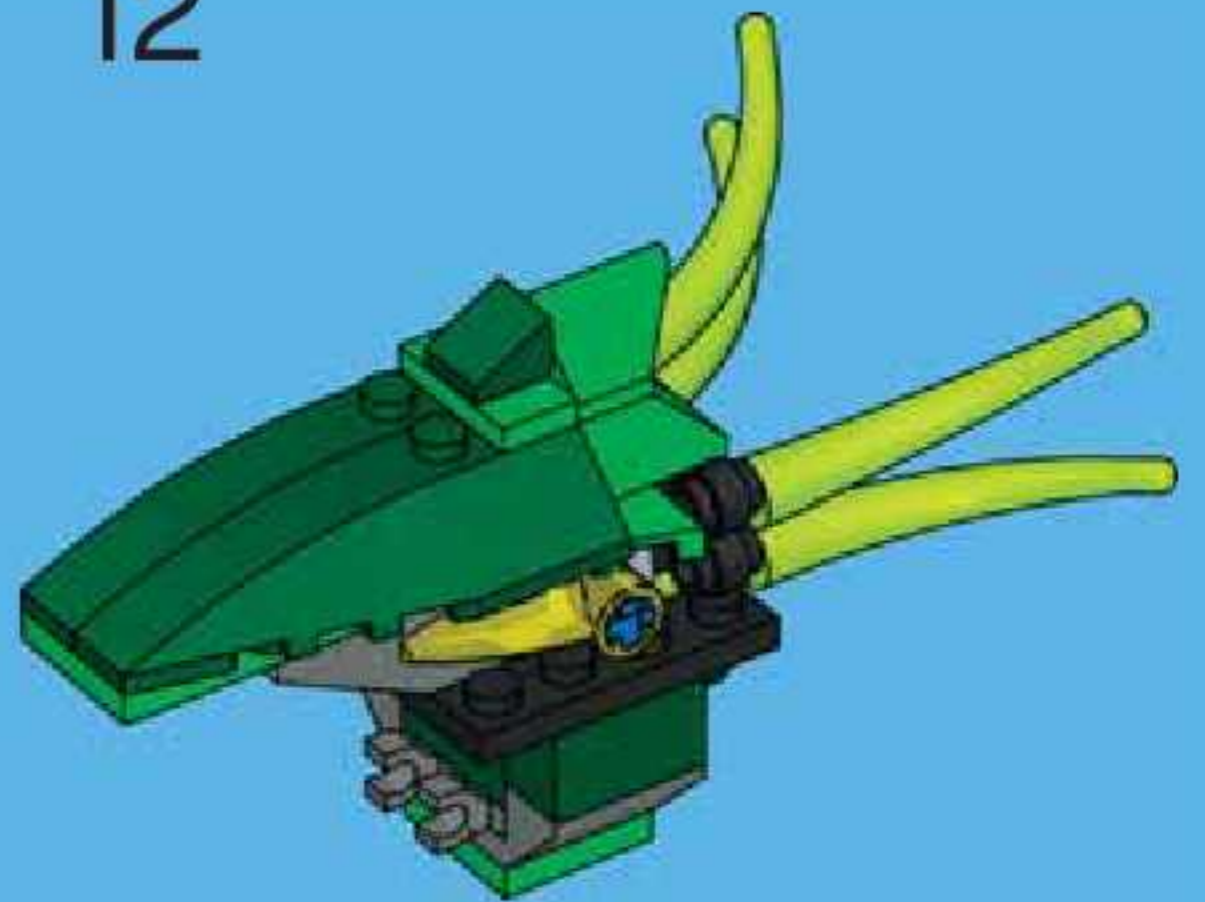

1



2

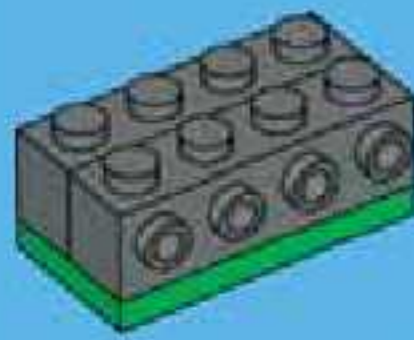

3



4

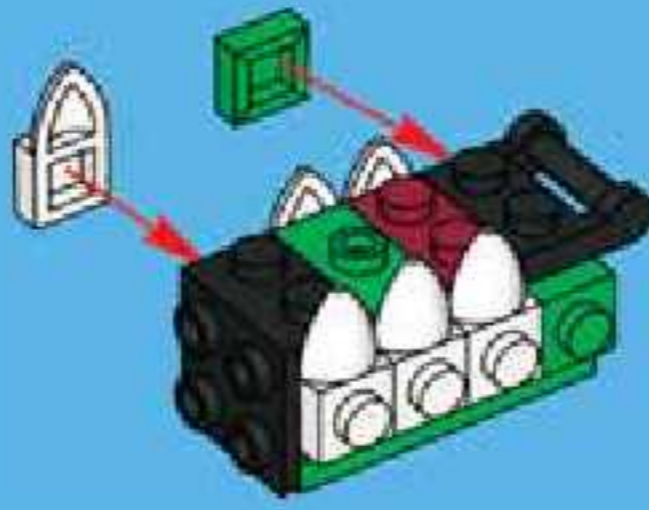

5

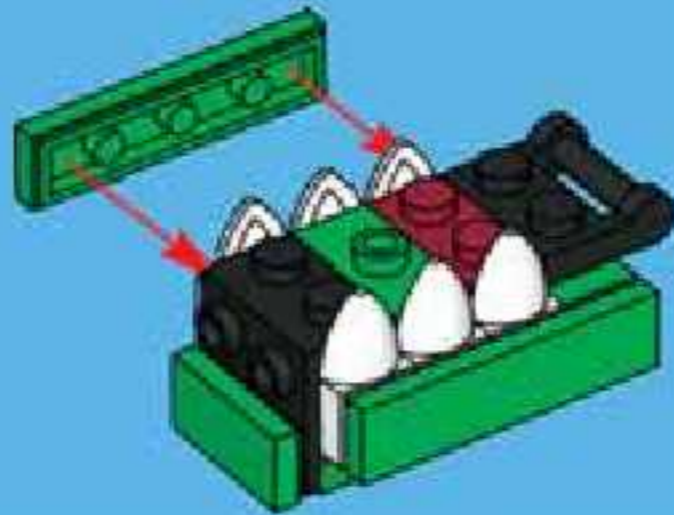

6

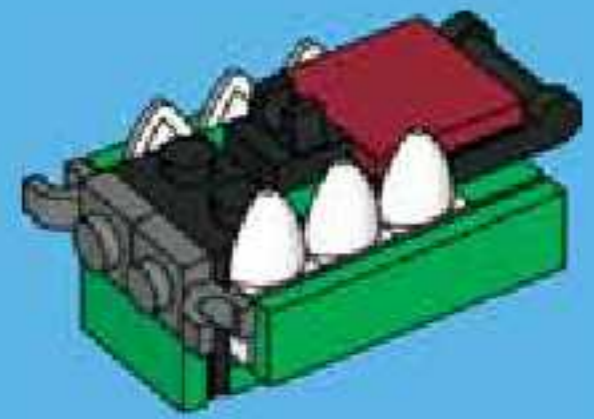

7



8



13

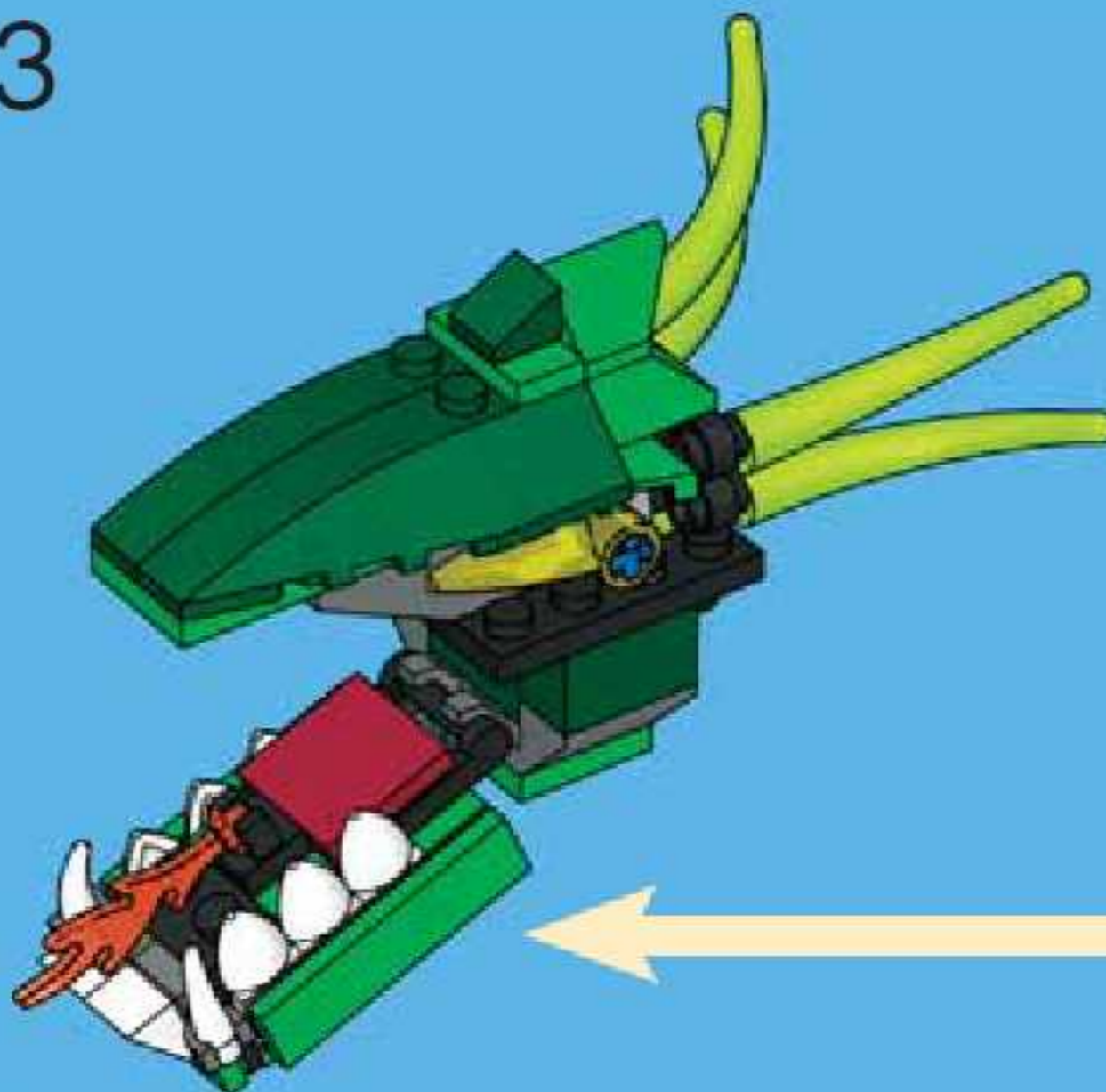

19

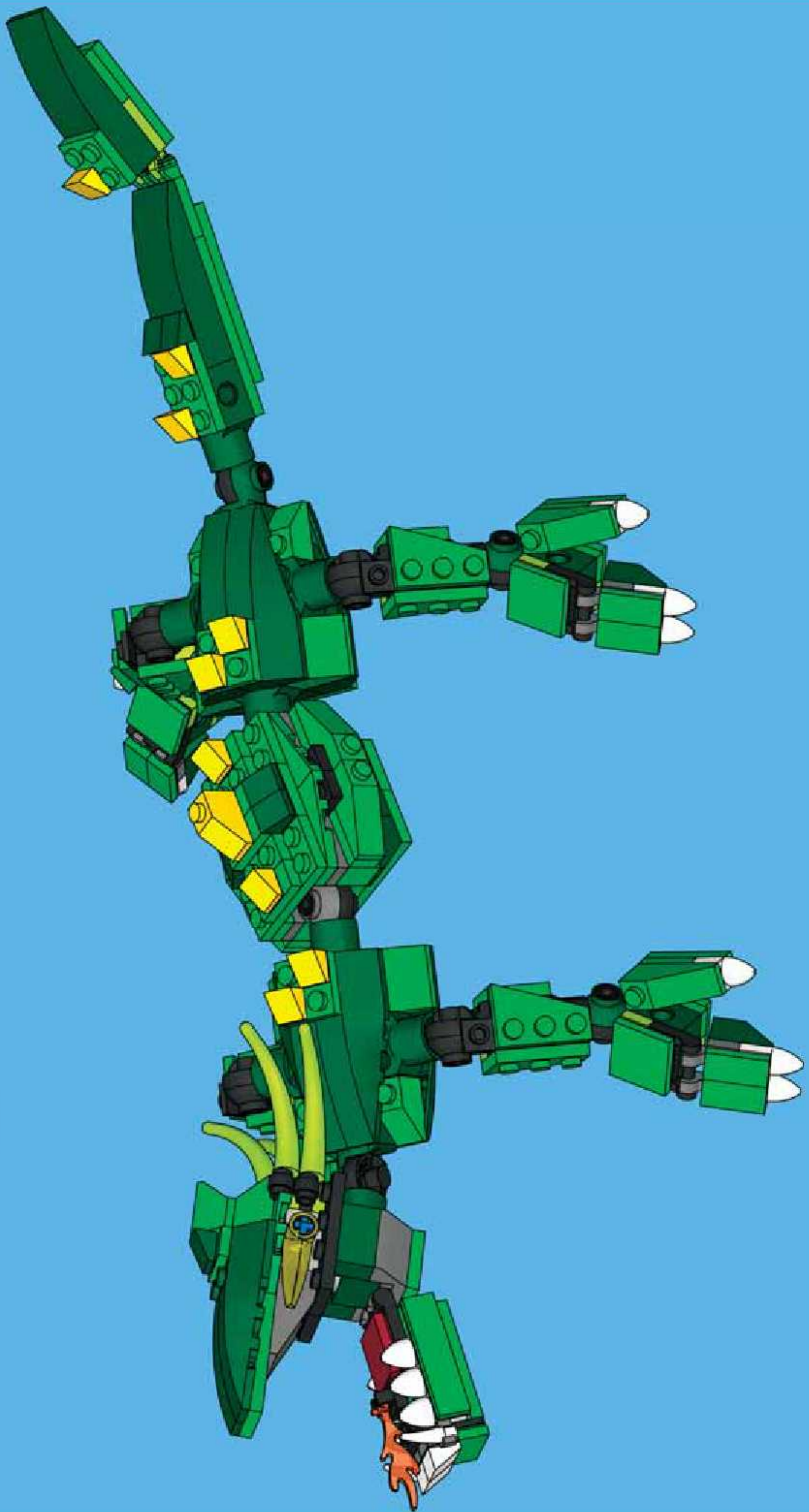

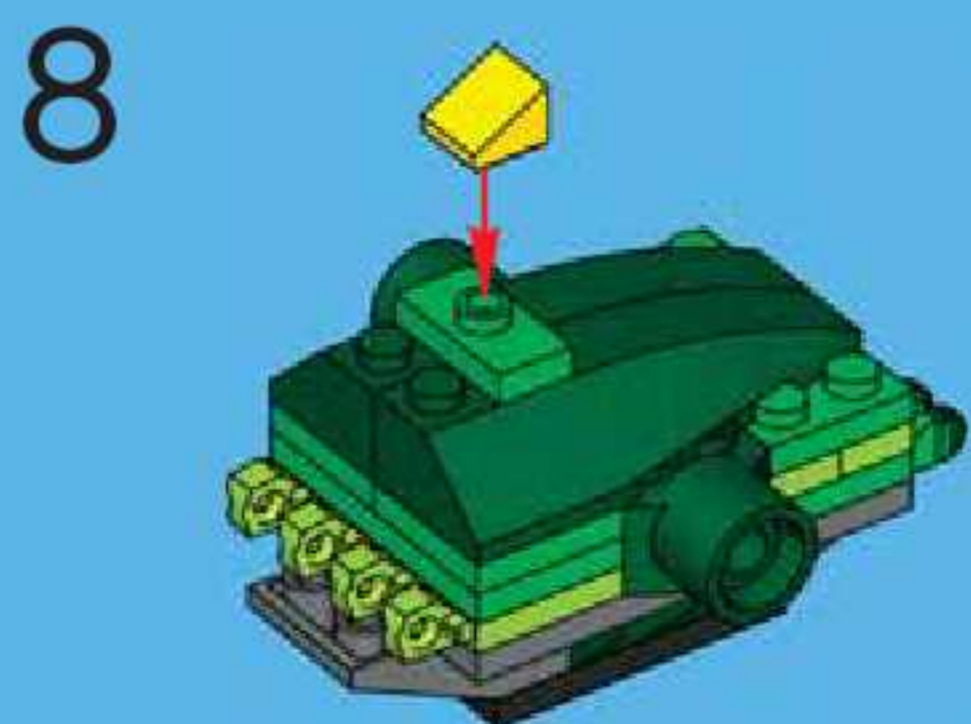
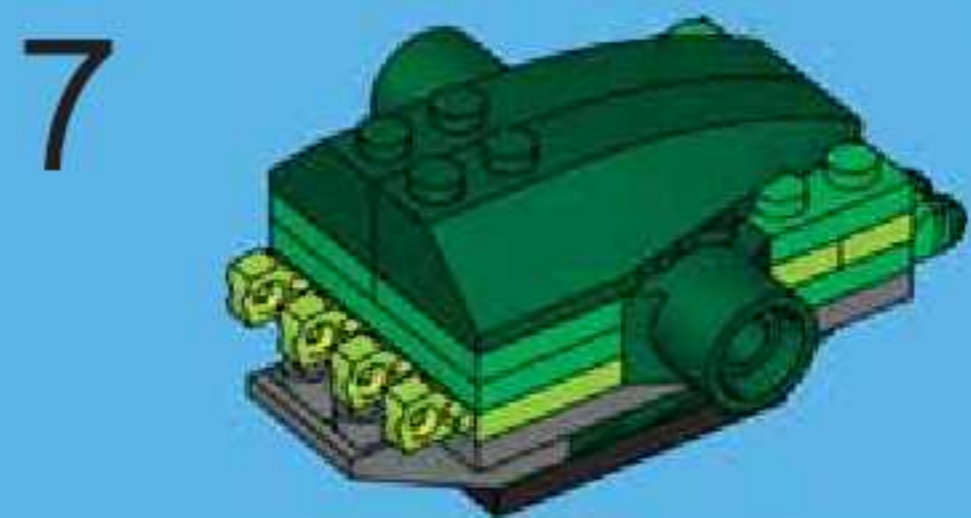
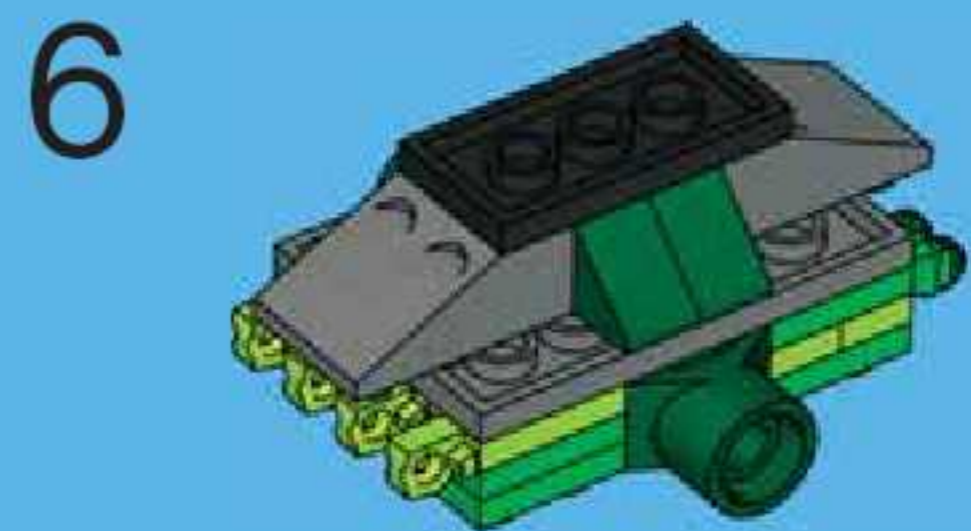
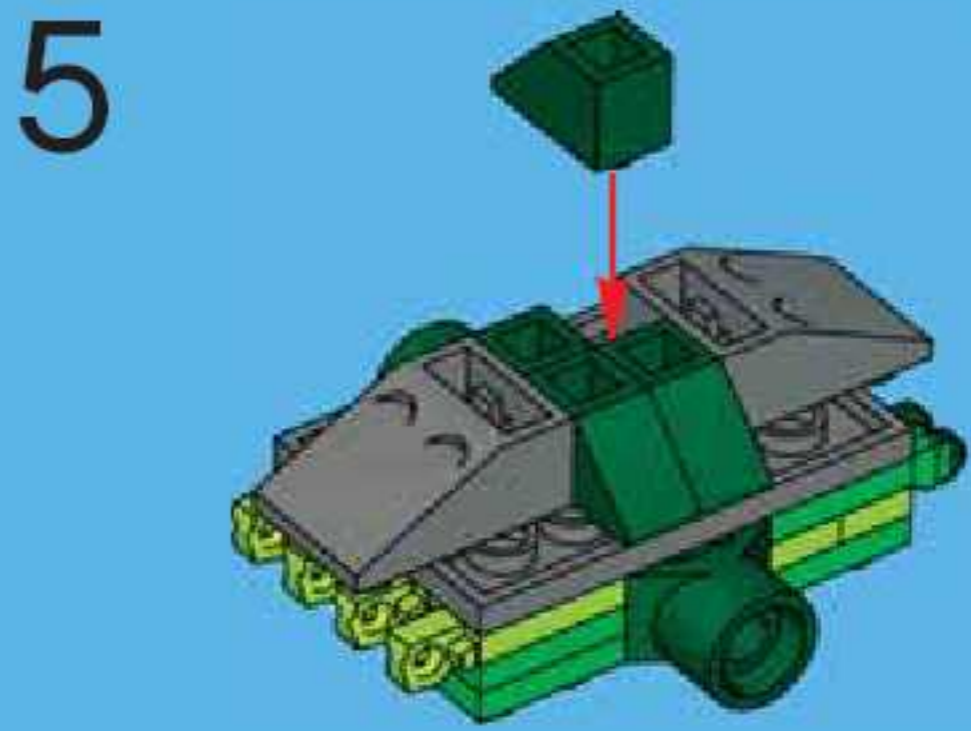
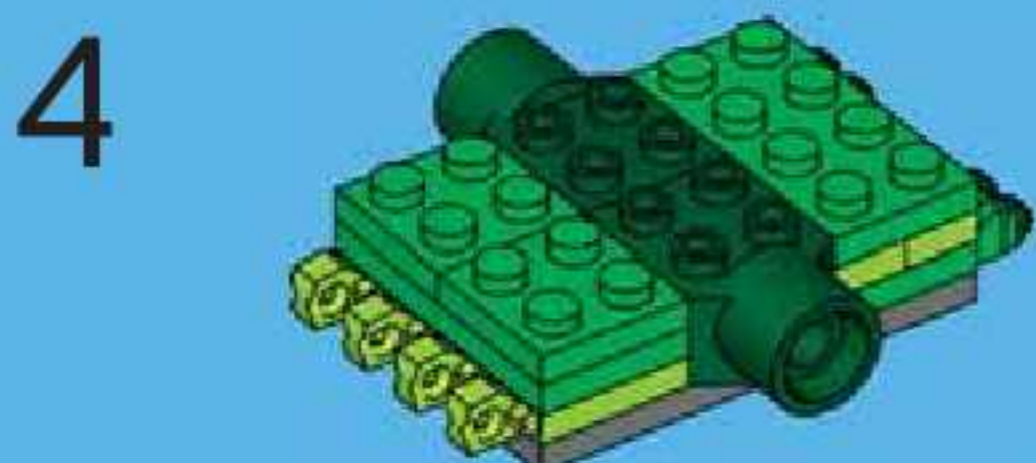
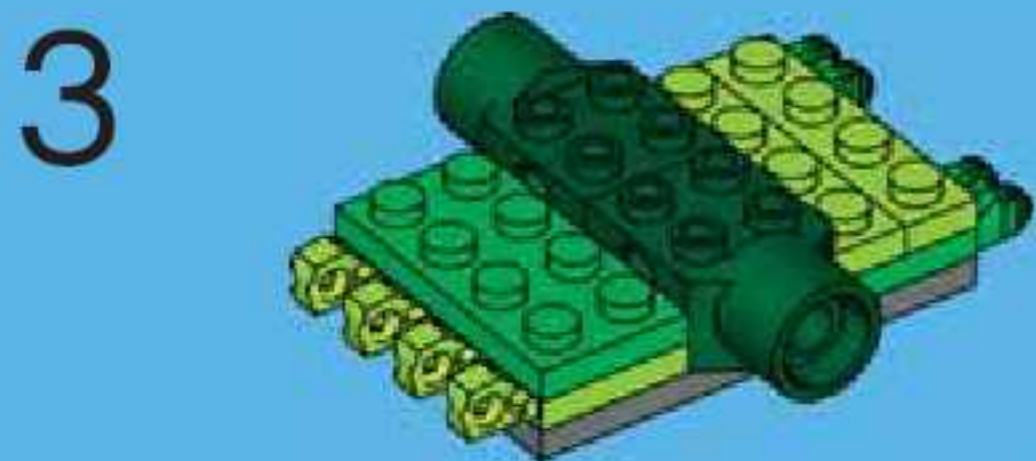
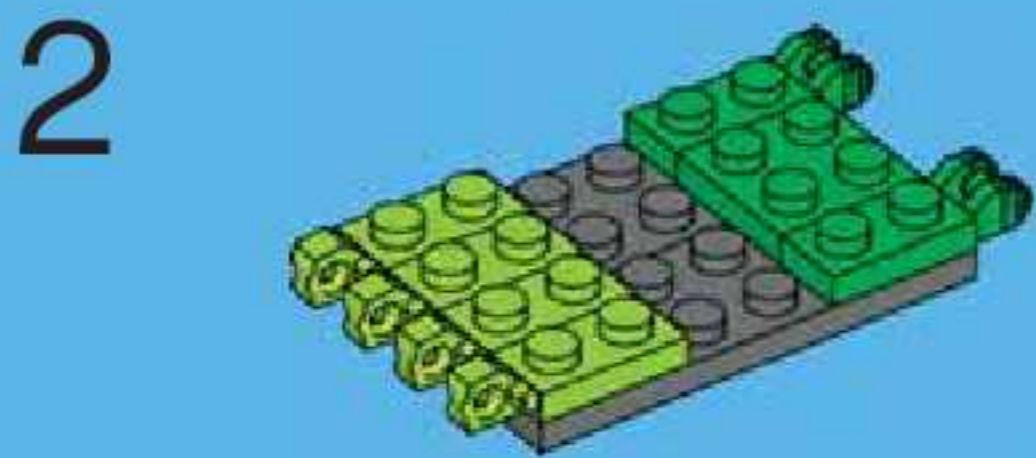
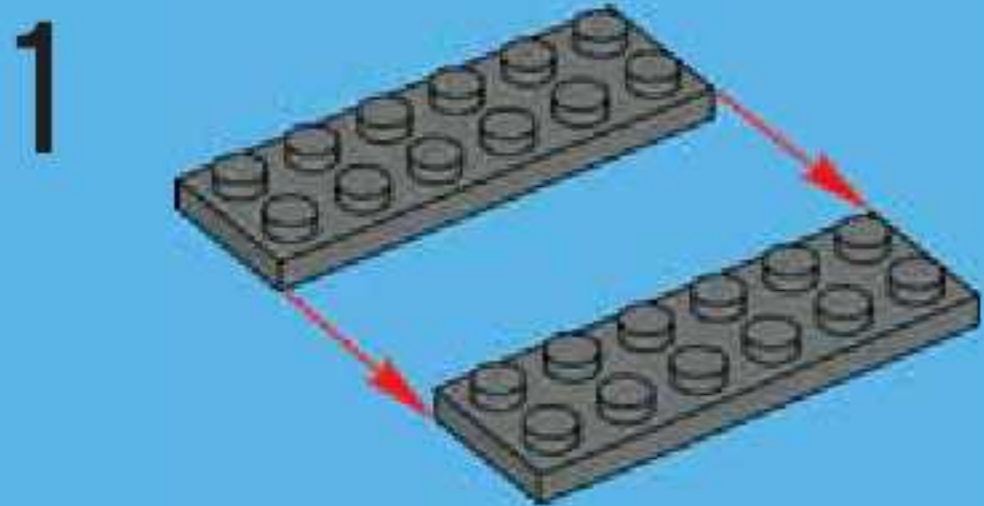

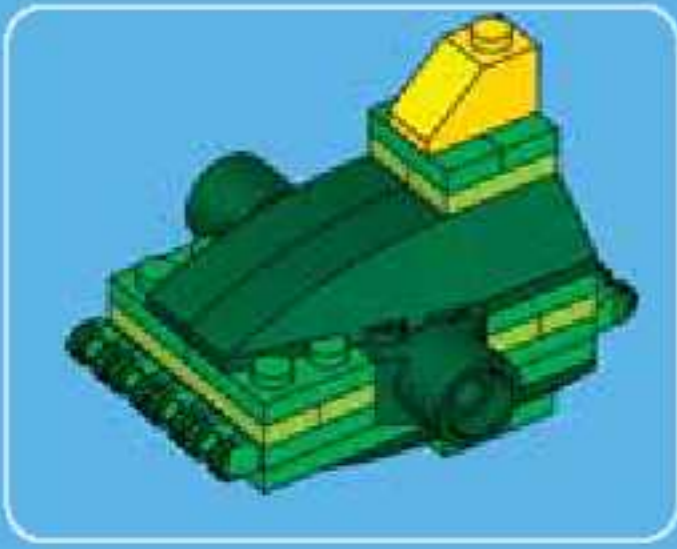

1

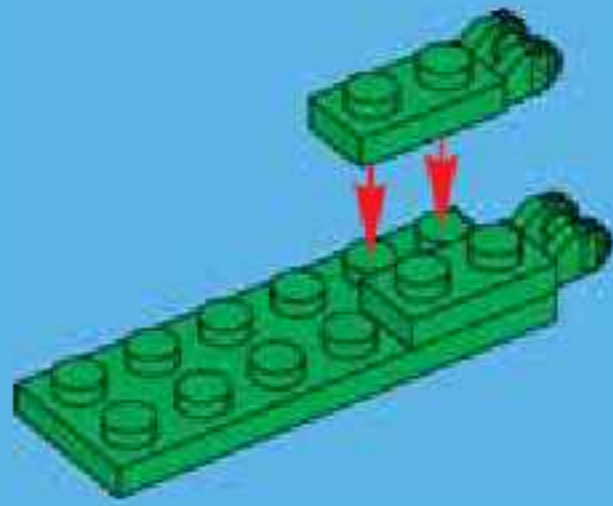

2

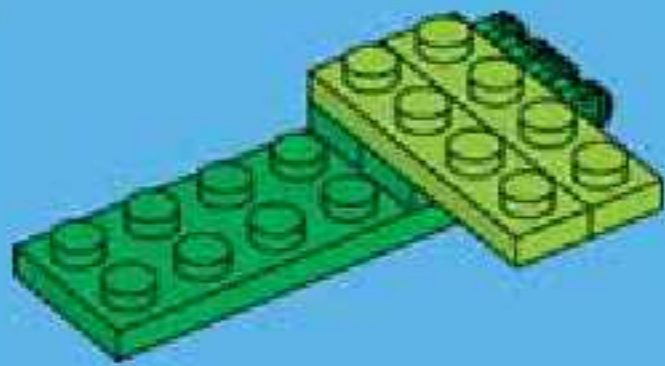

3

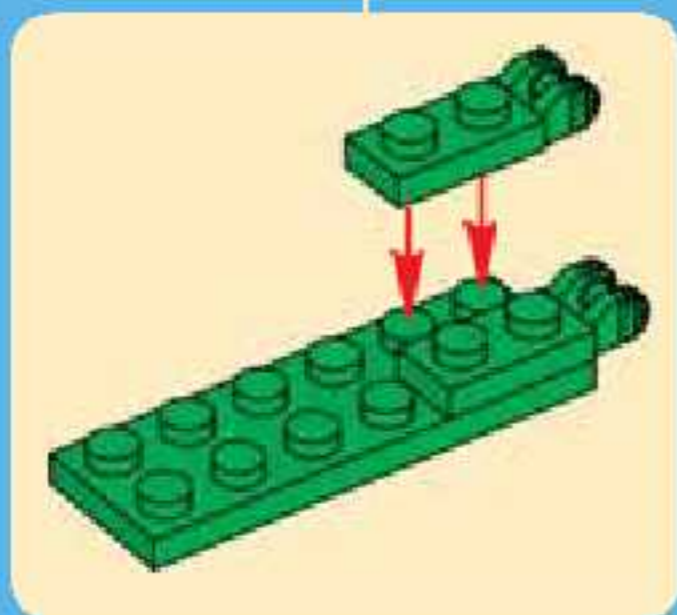
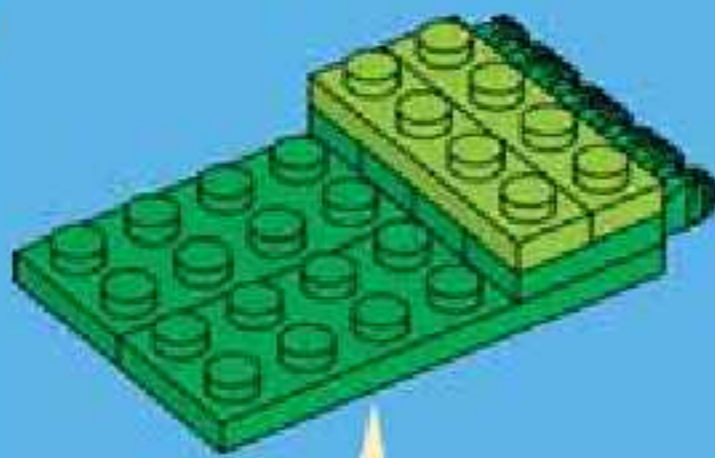

4

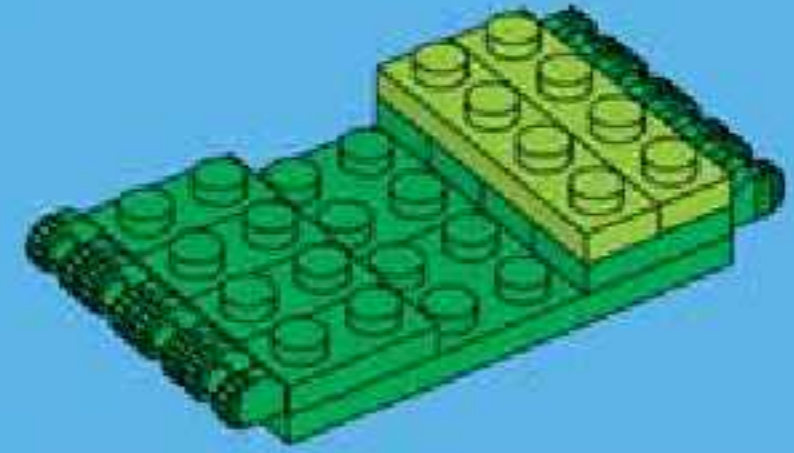

5

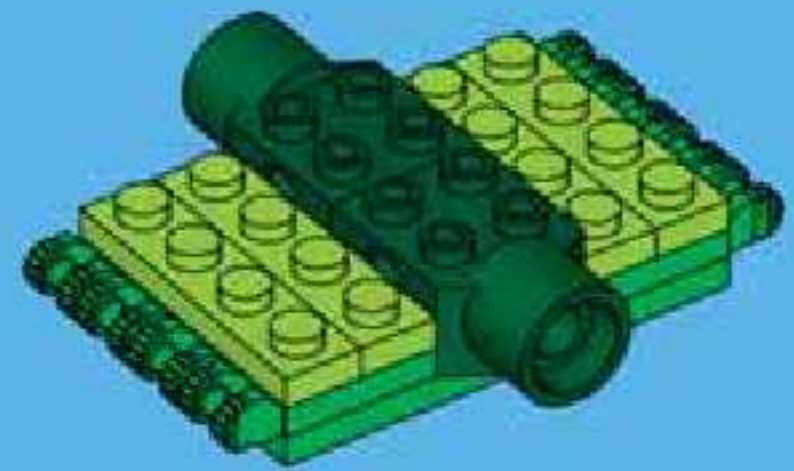

6

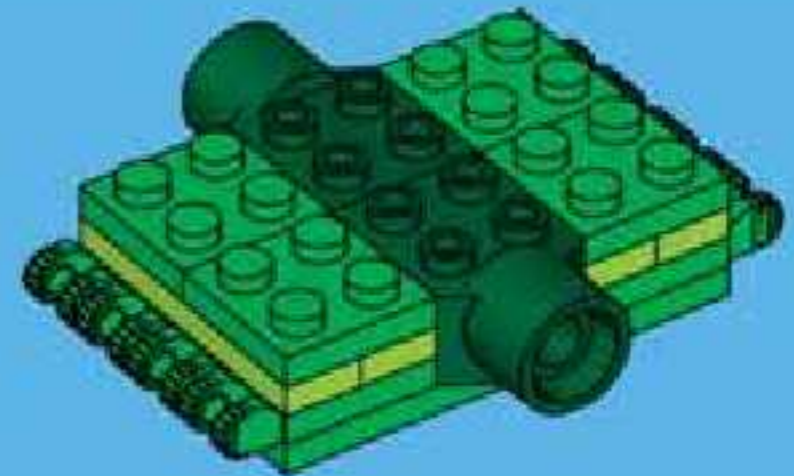

7

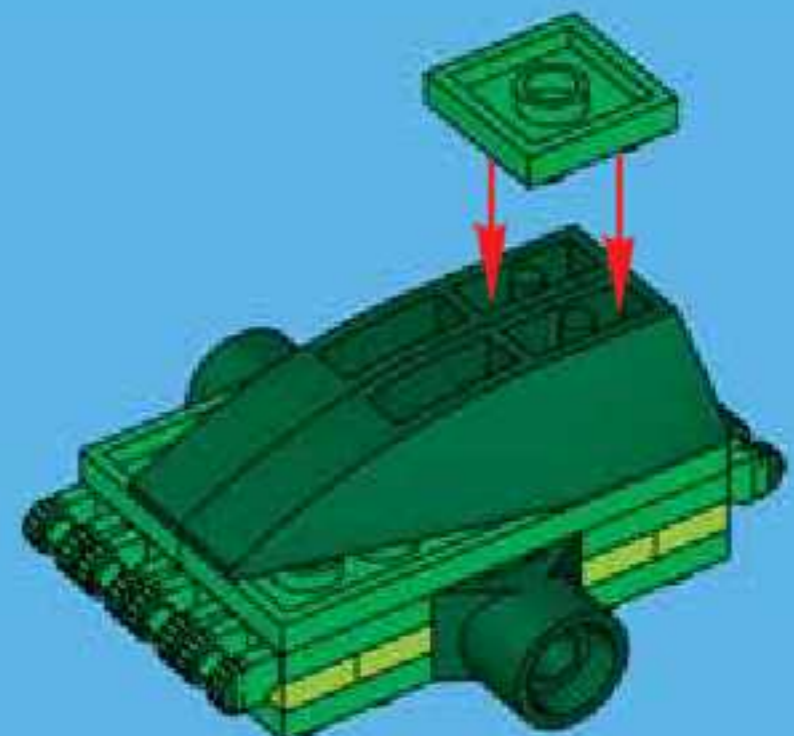

8

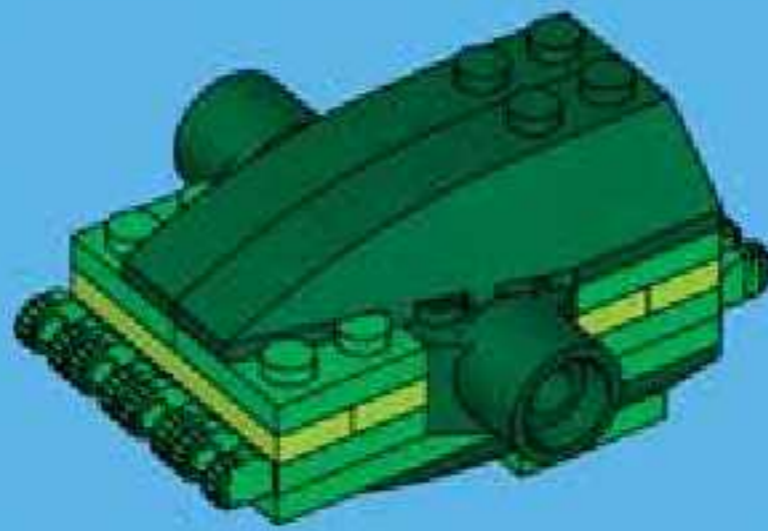

9

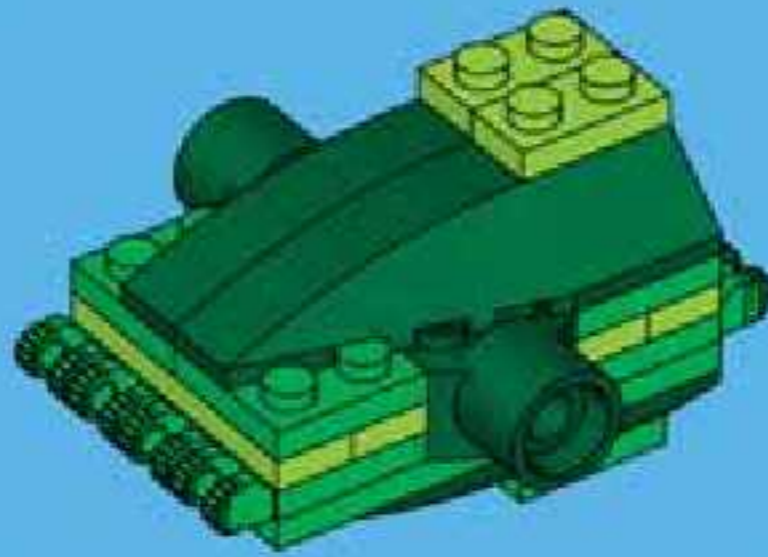

10

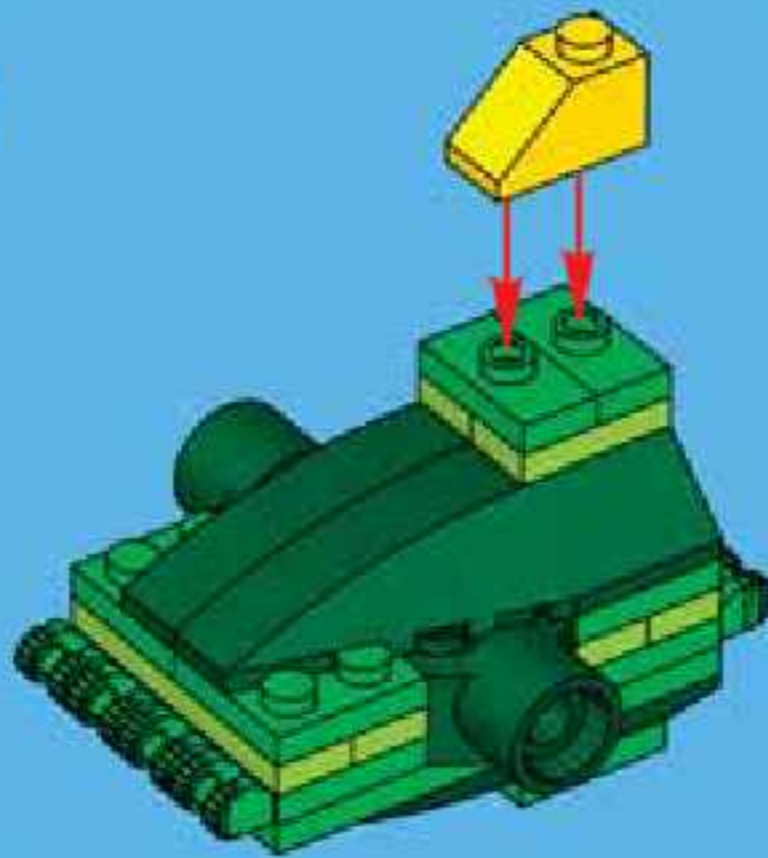

9

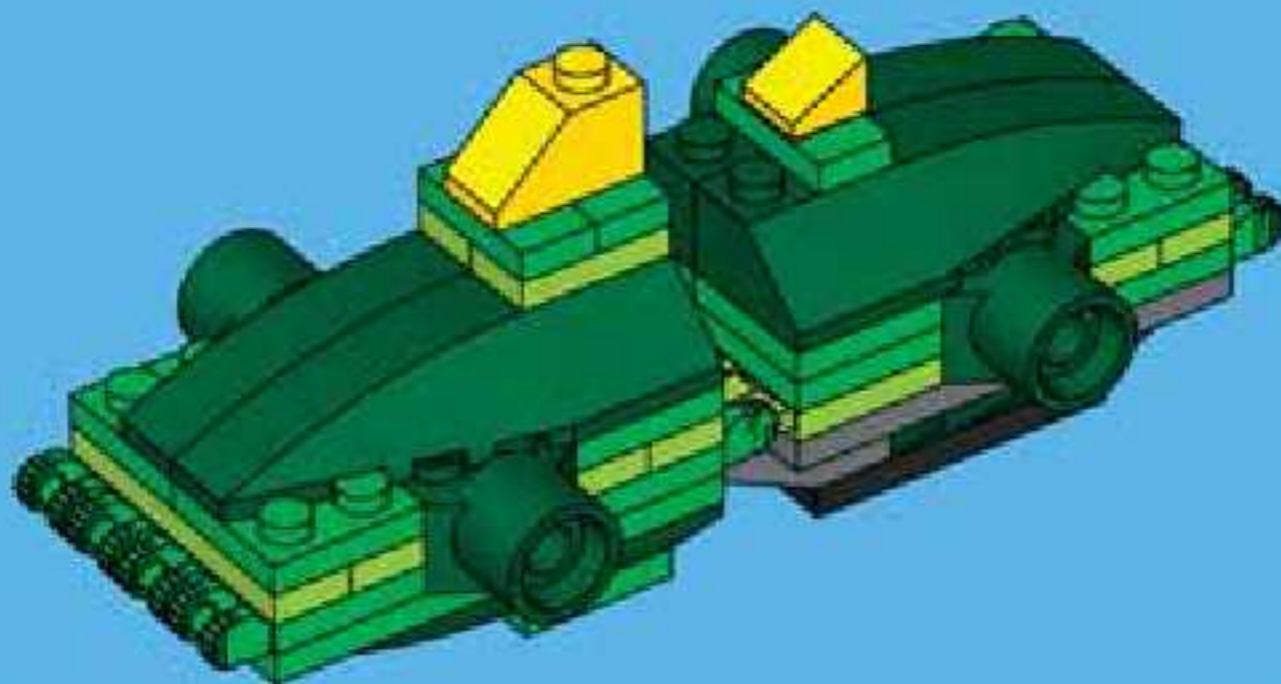



1



2

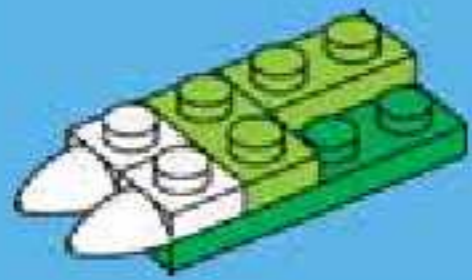

3

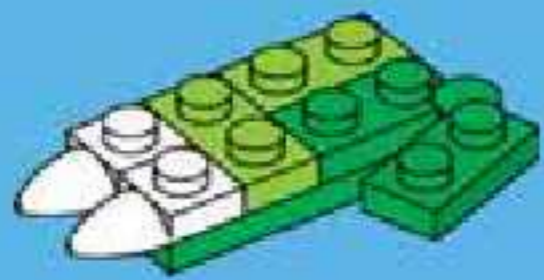

4

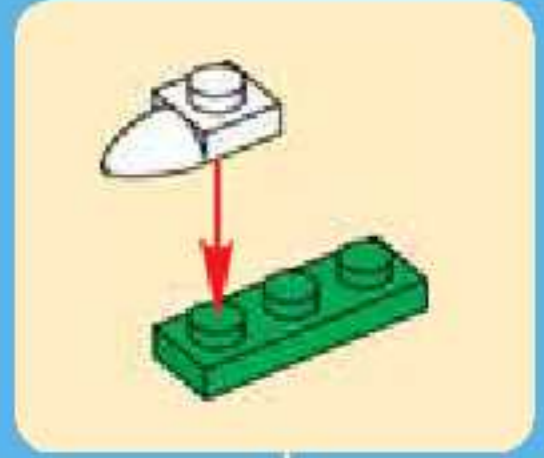
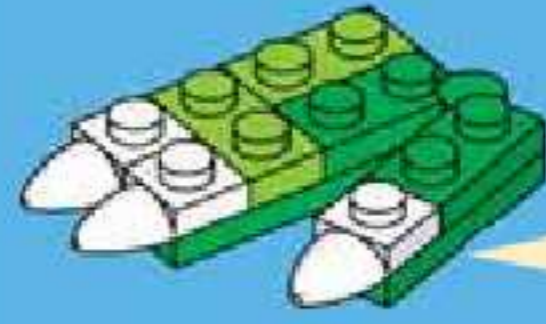

5

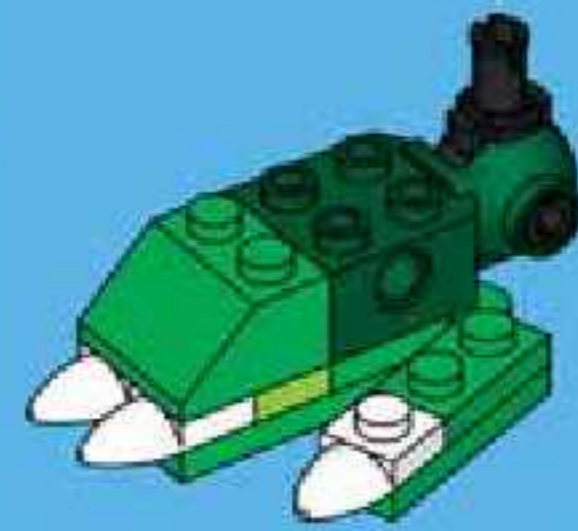

6

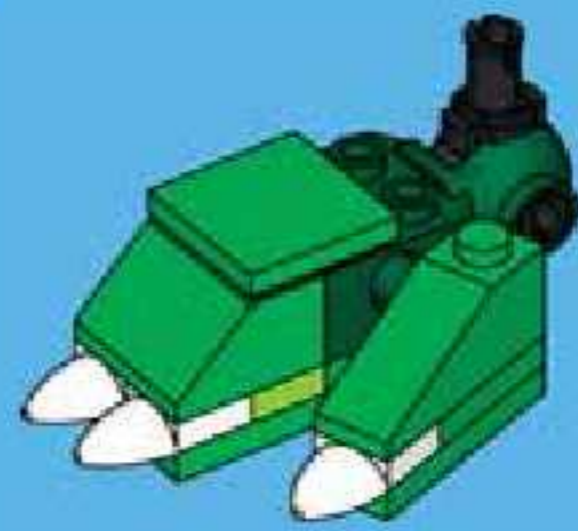

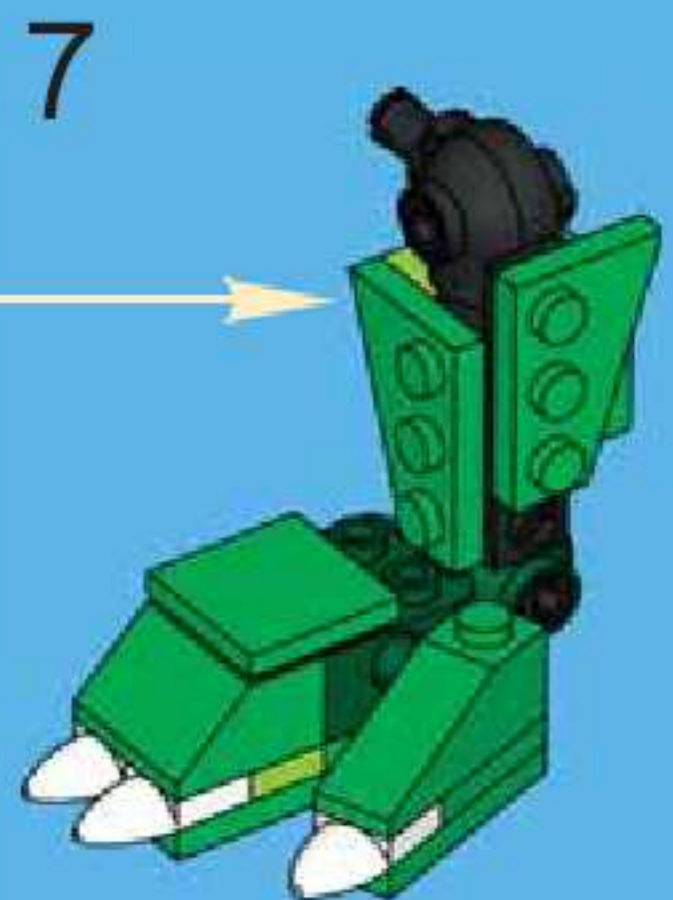
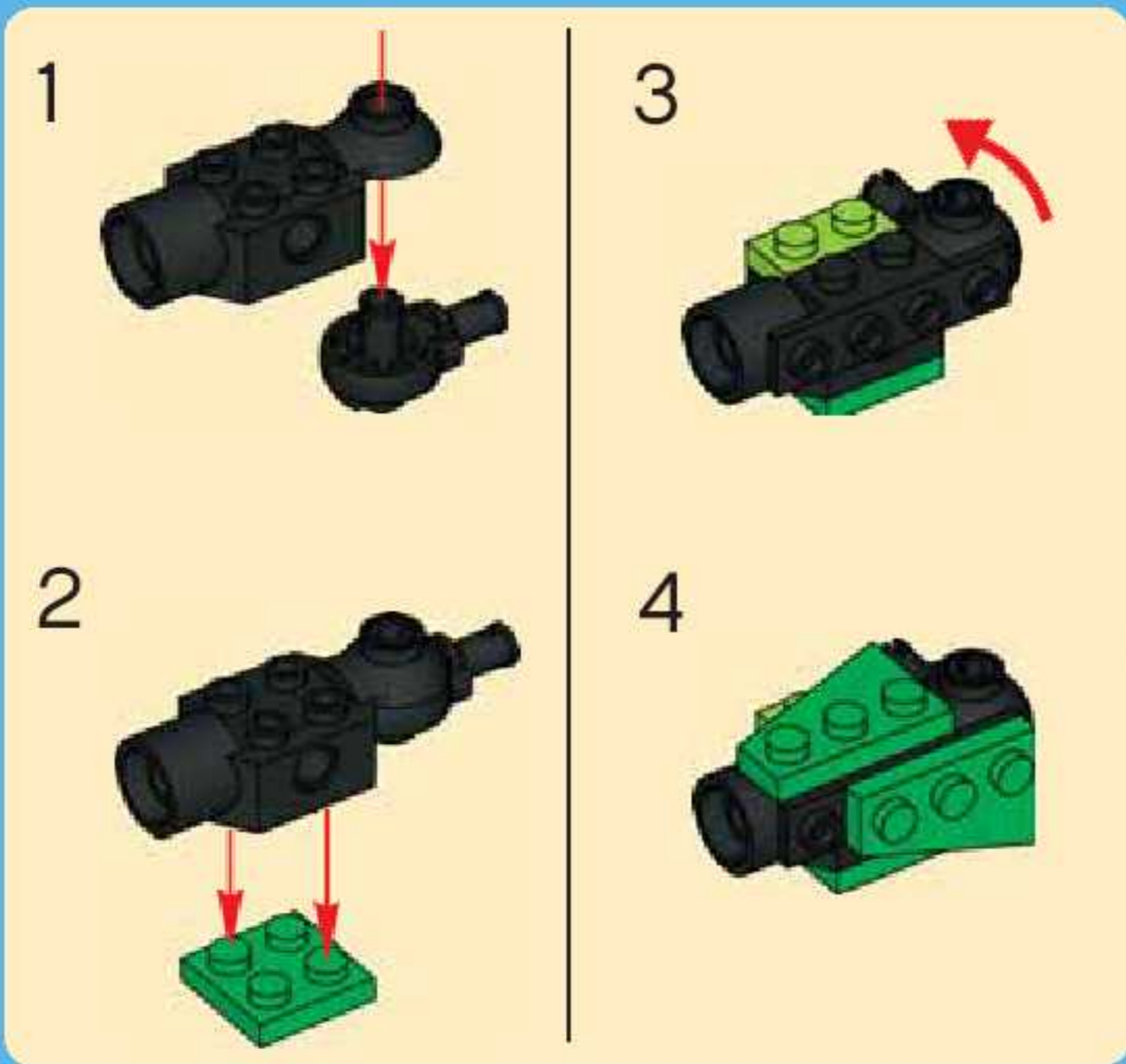

2x

10

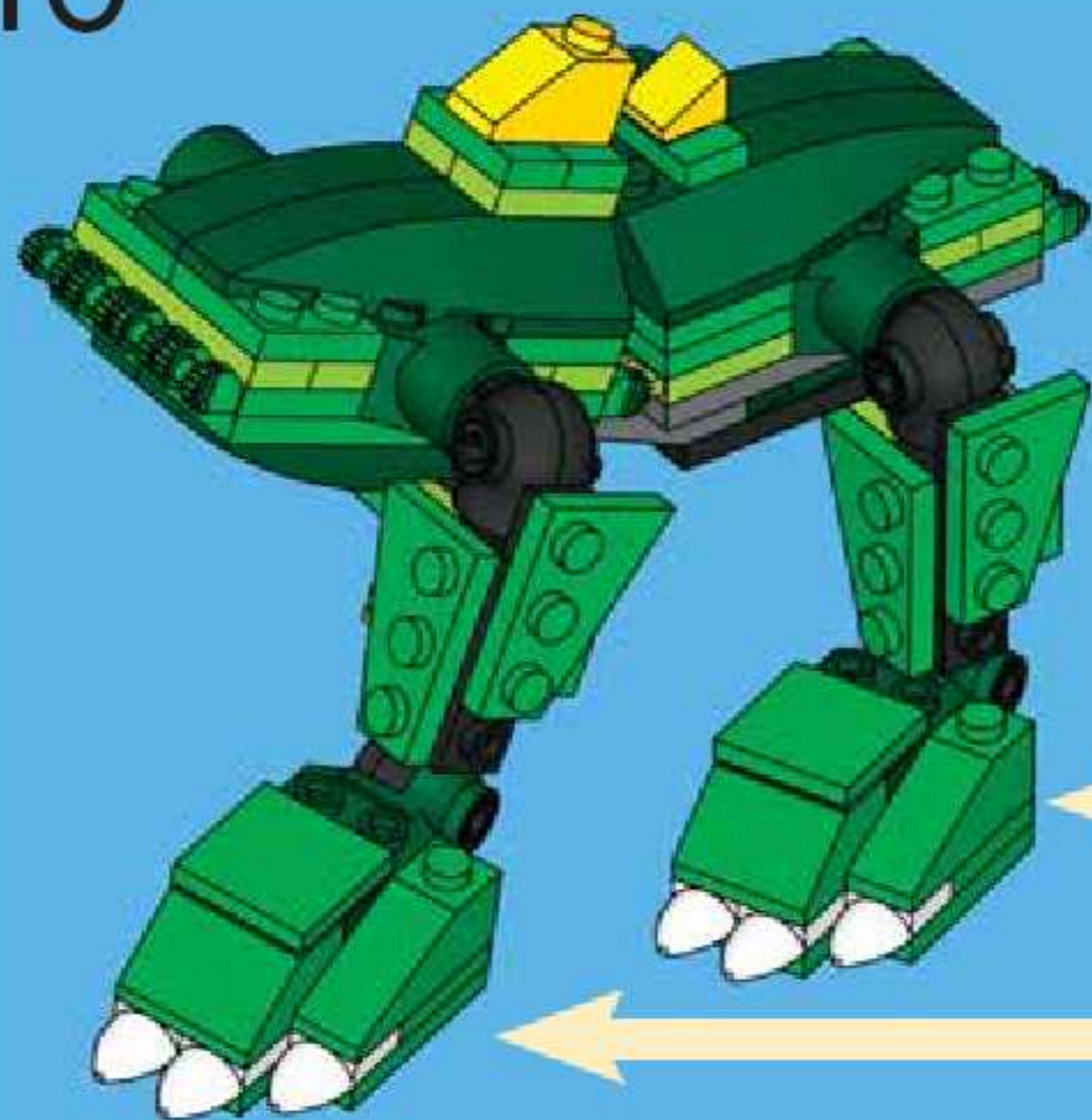

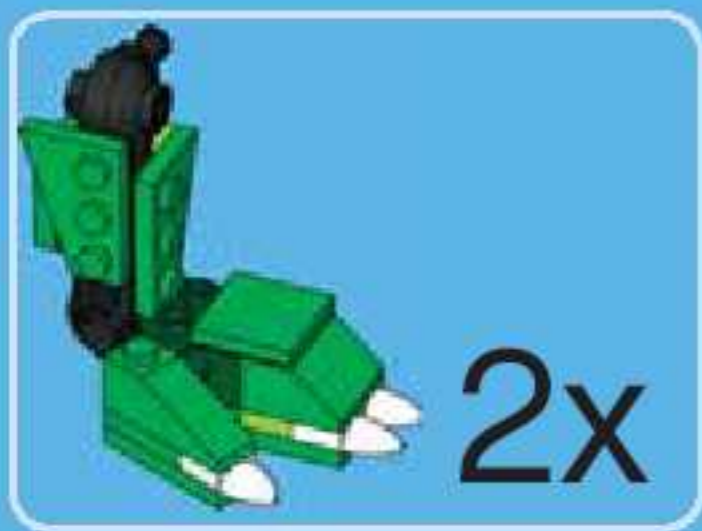

1



2

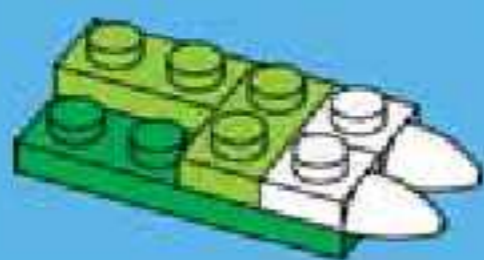

3

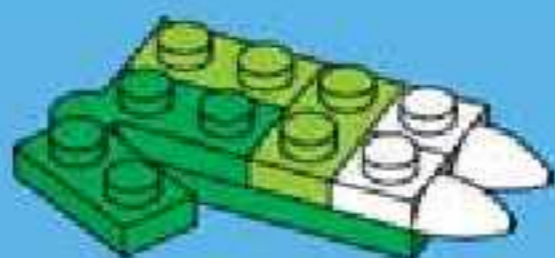

4

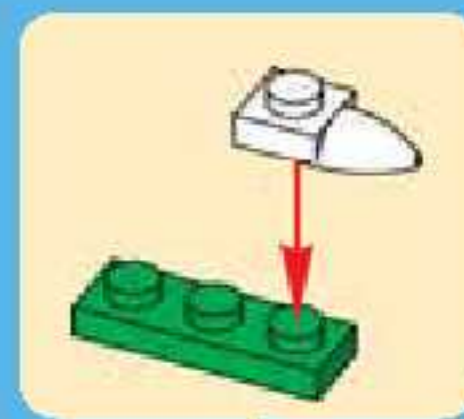

5



6



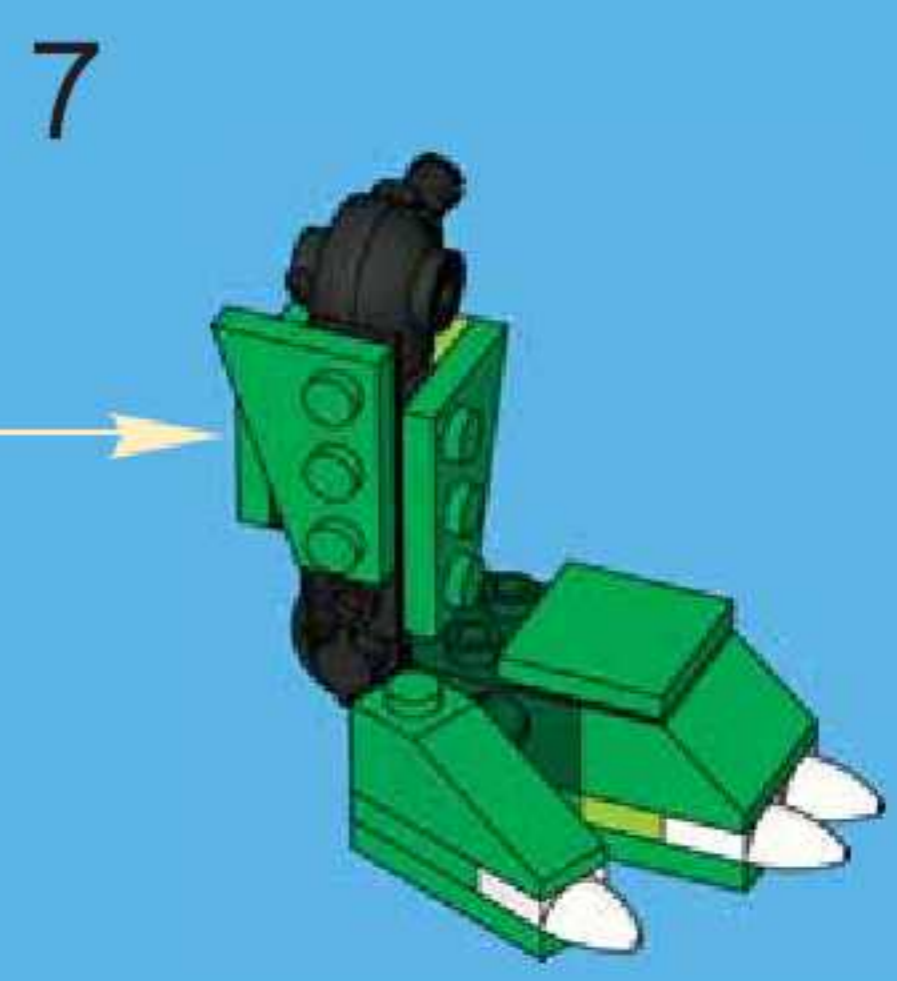
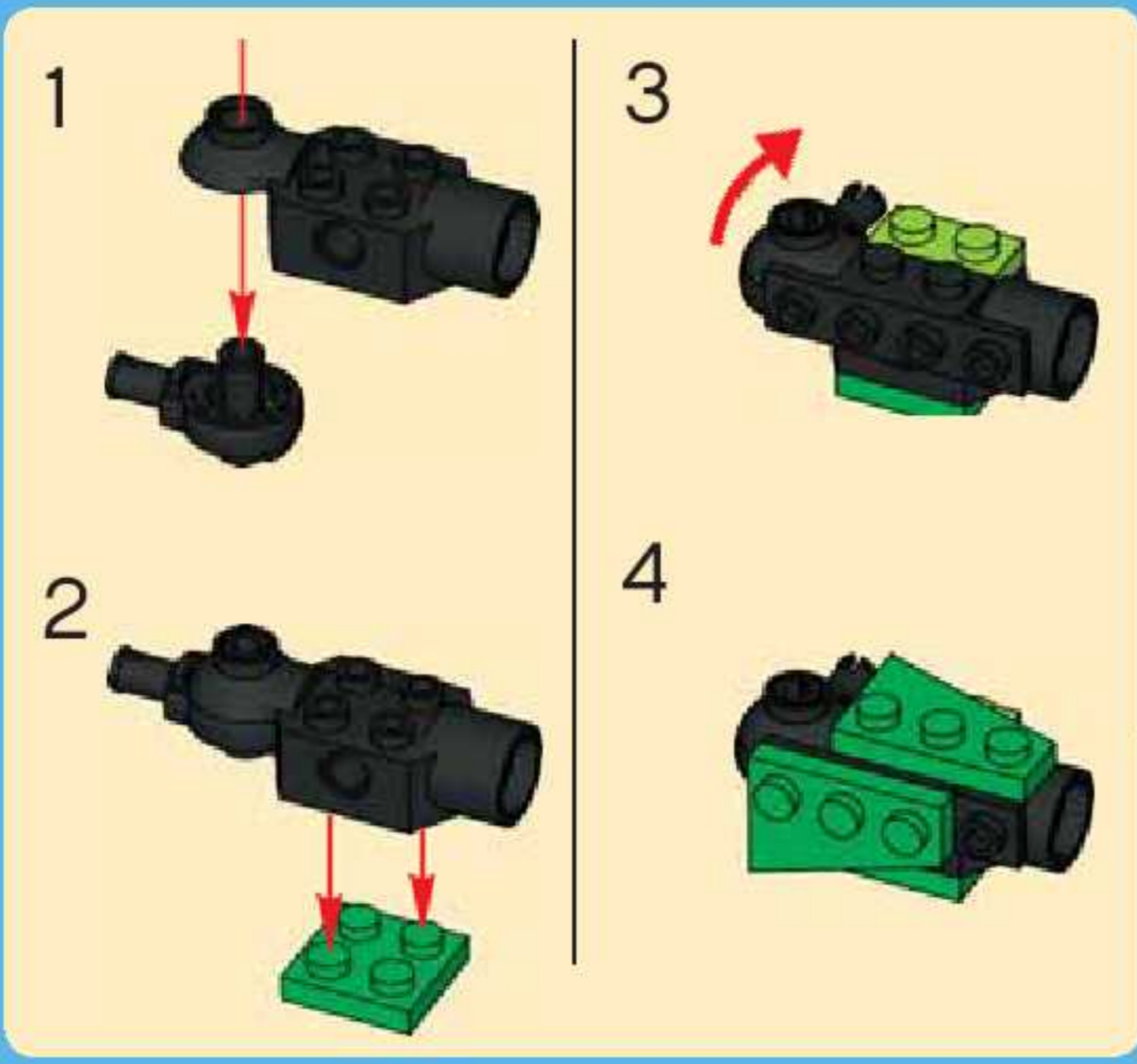

2x

11

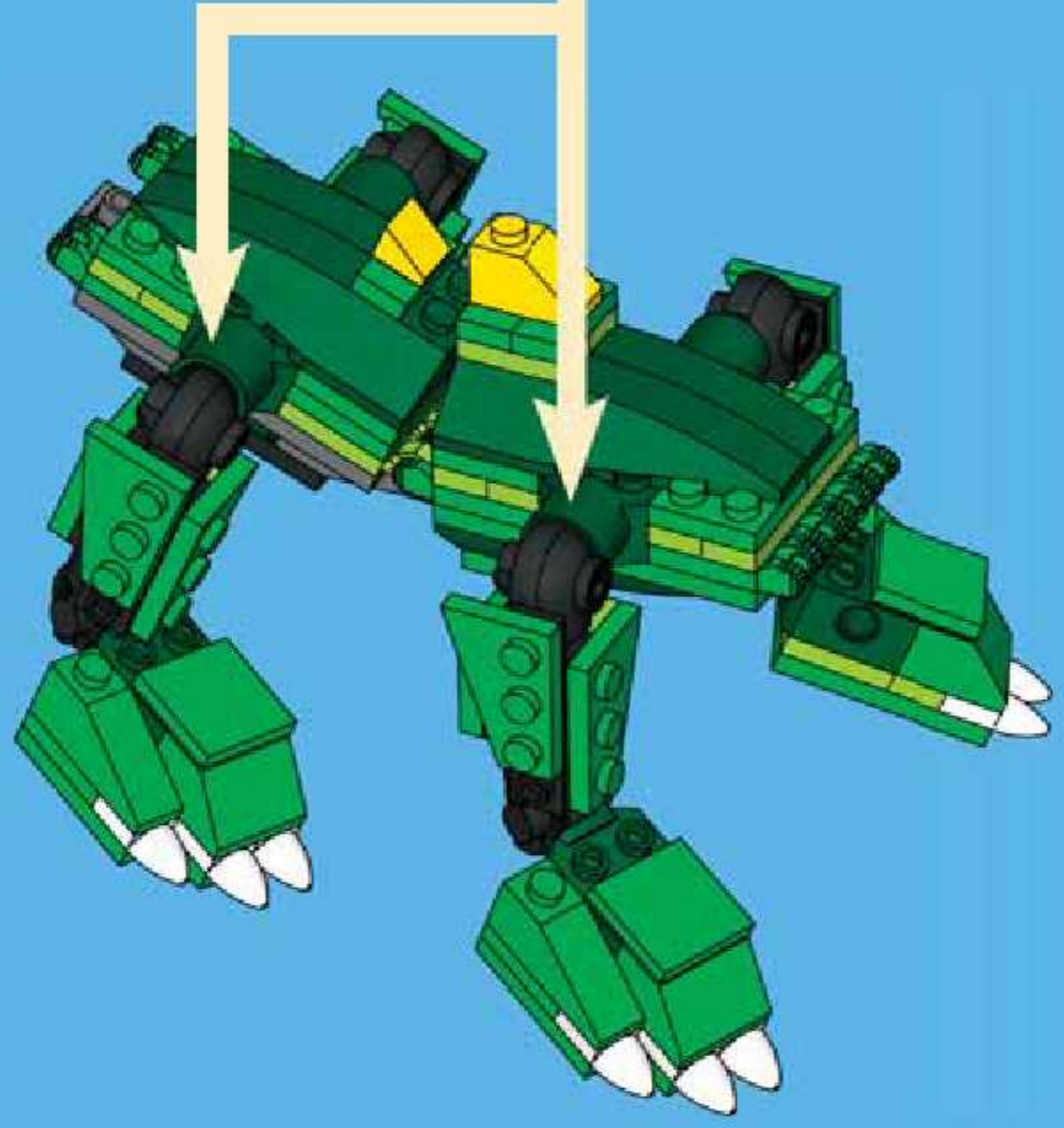



1

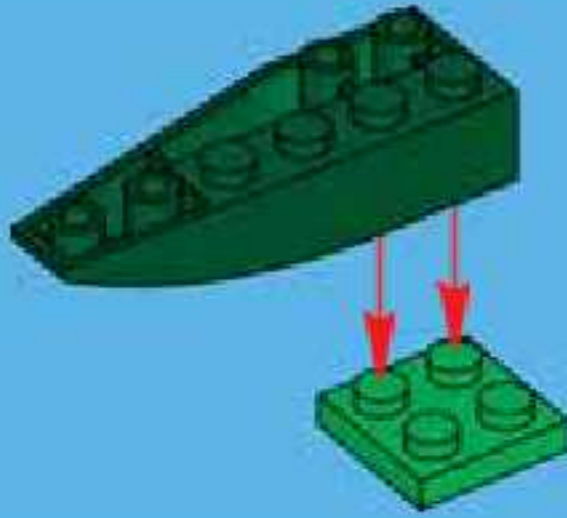

2

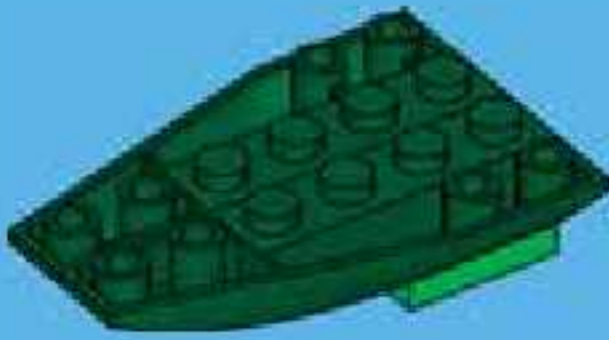

3



4

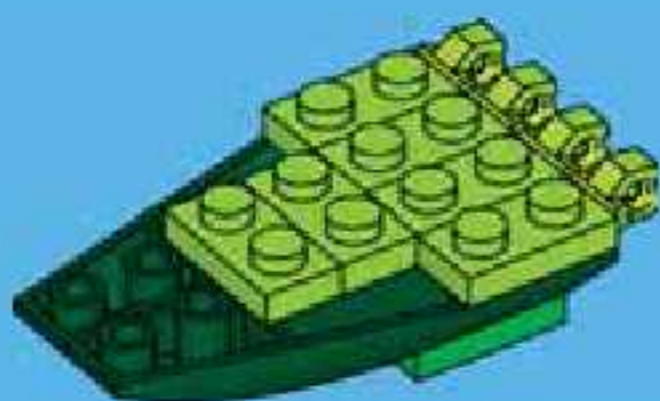

5

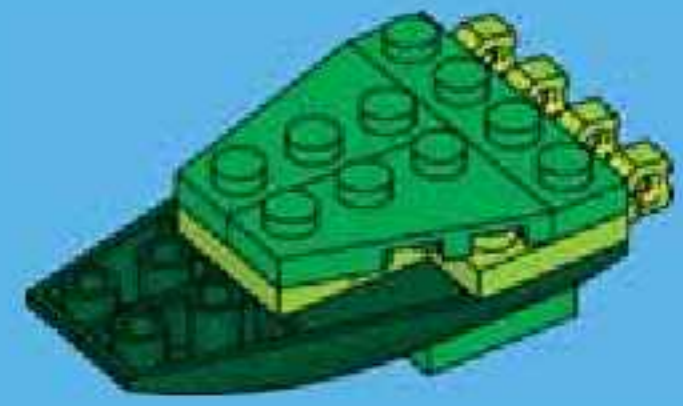

6

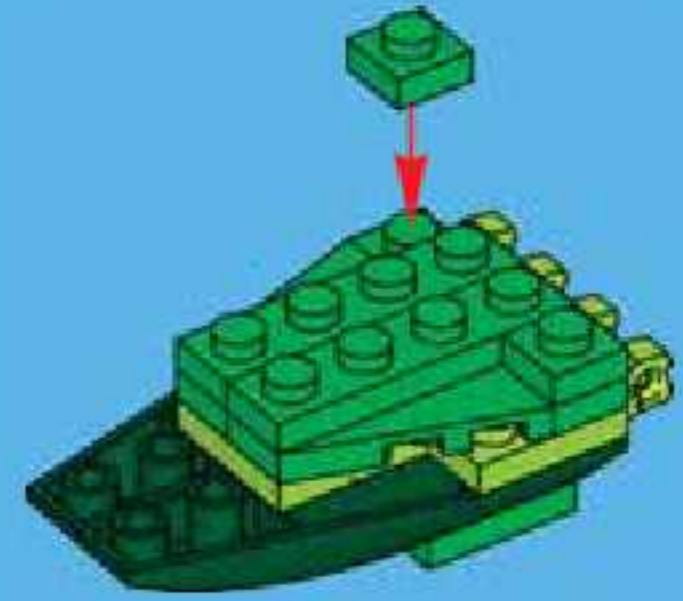

7

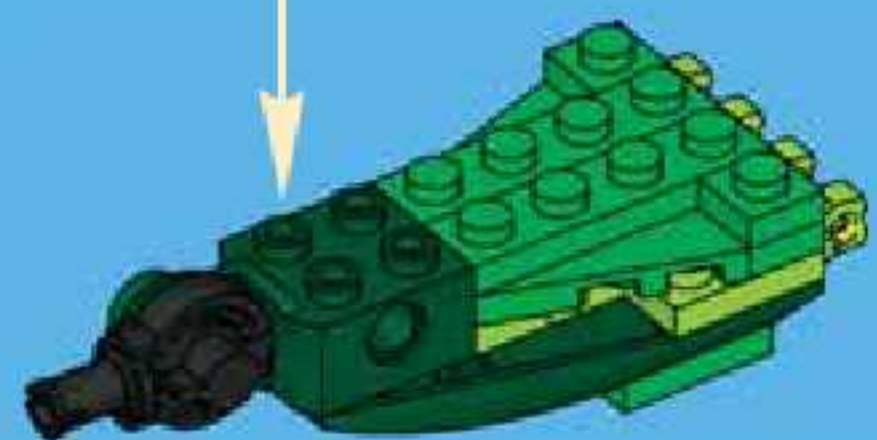

8

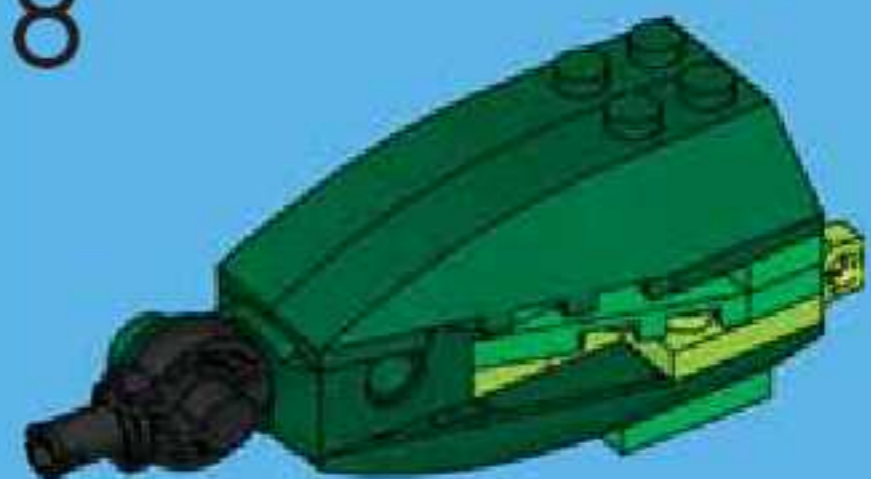

9

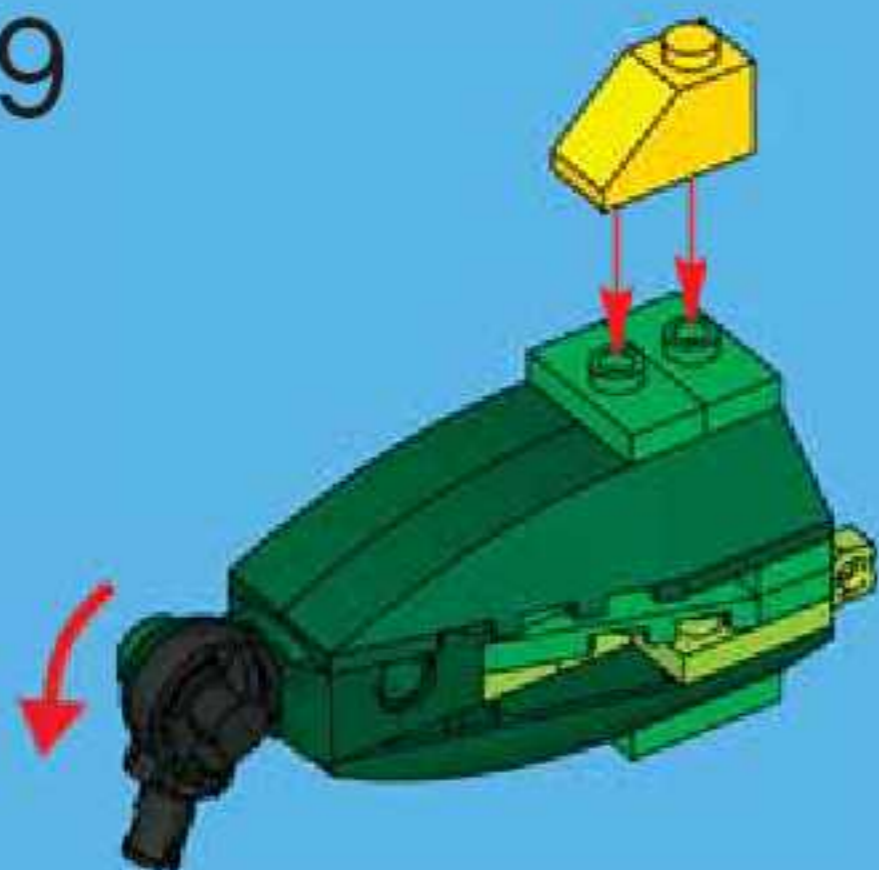

12

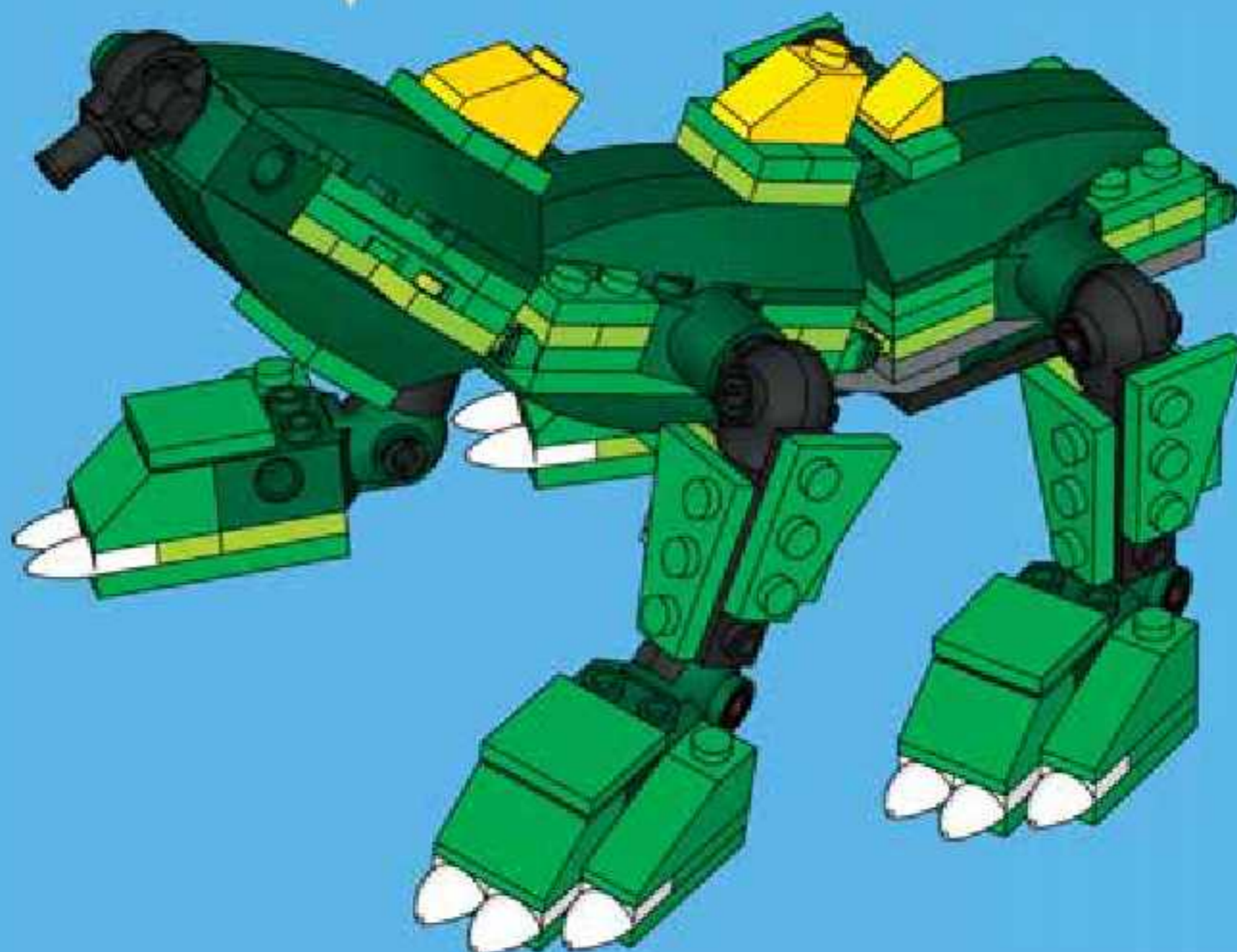

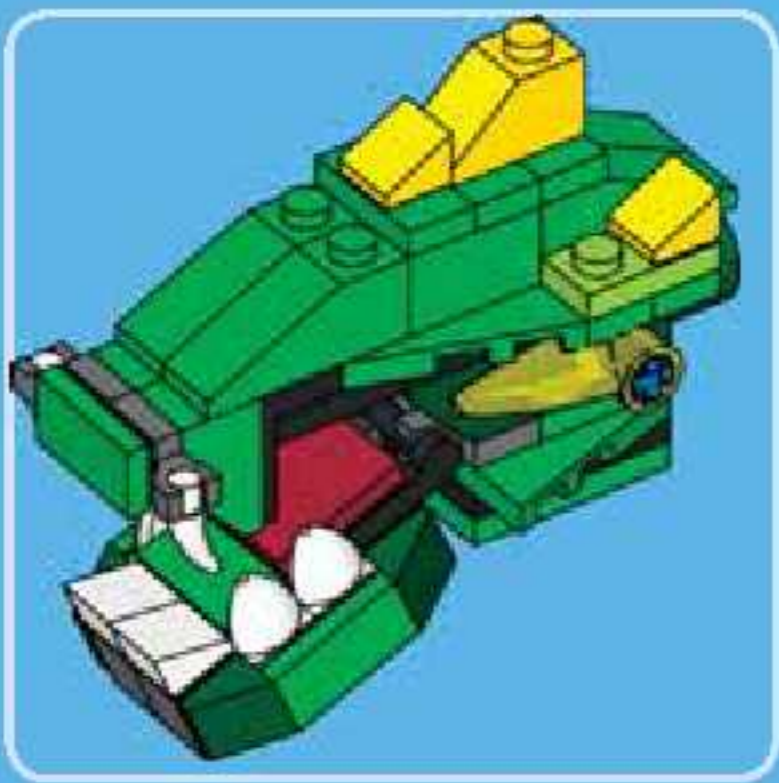

1

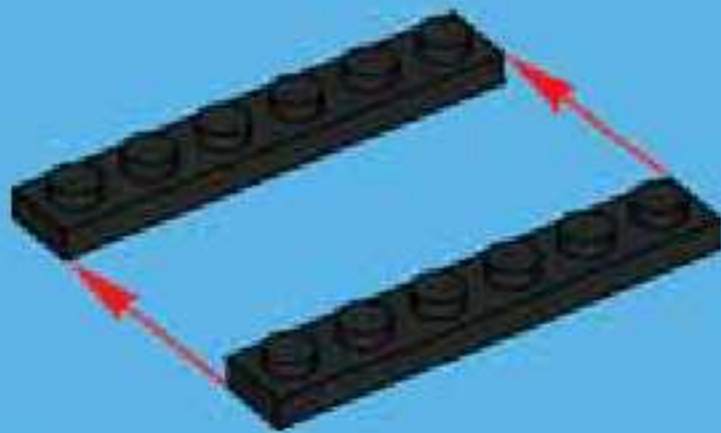

2



3

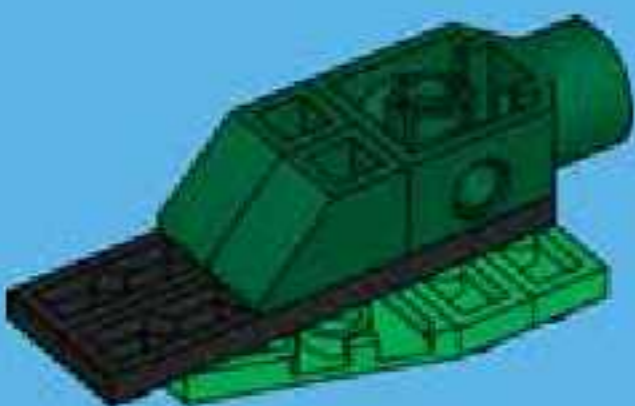

4

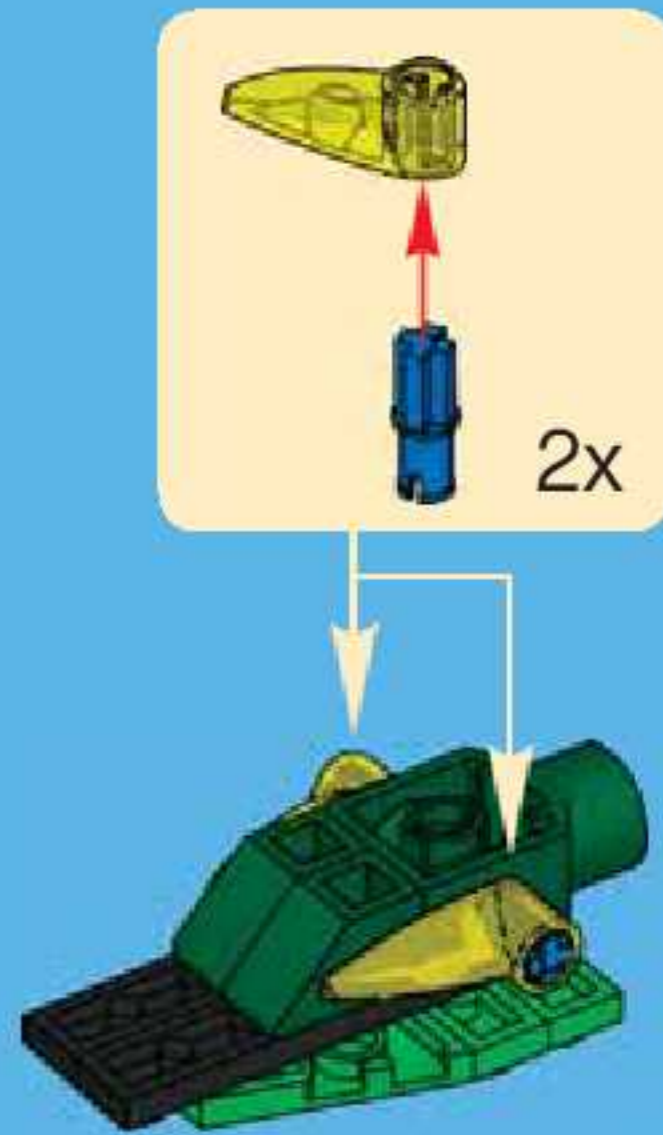

1

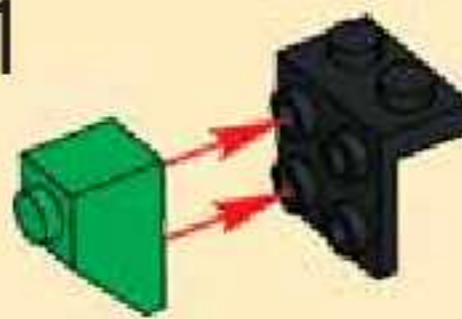

2



3

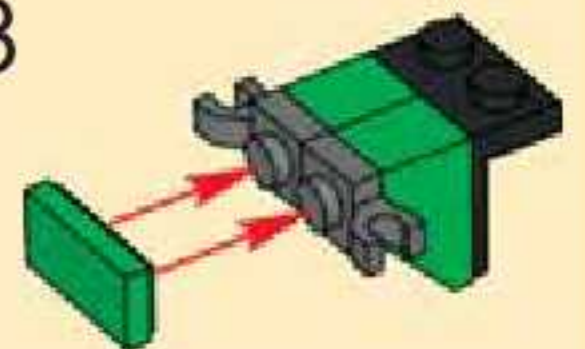

4

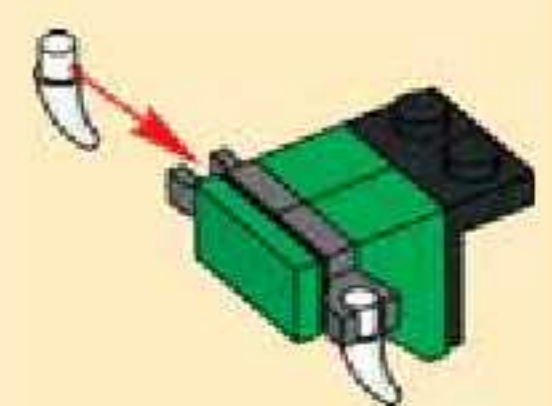

5

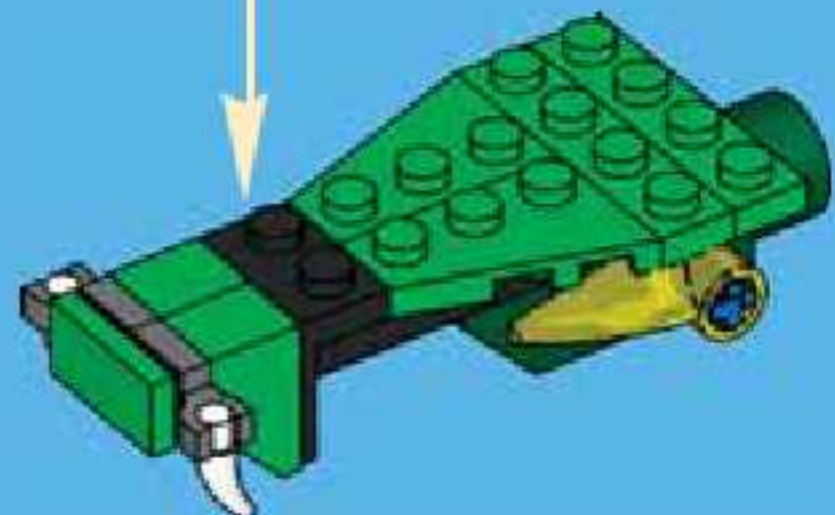

6

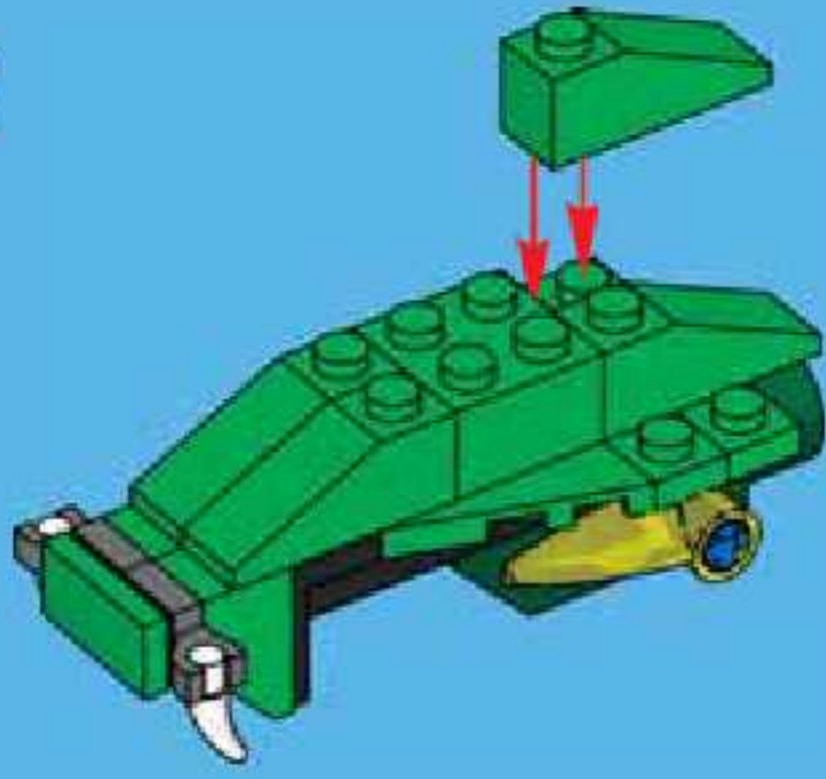

9

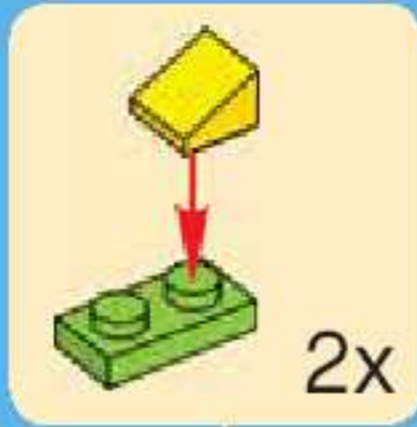
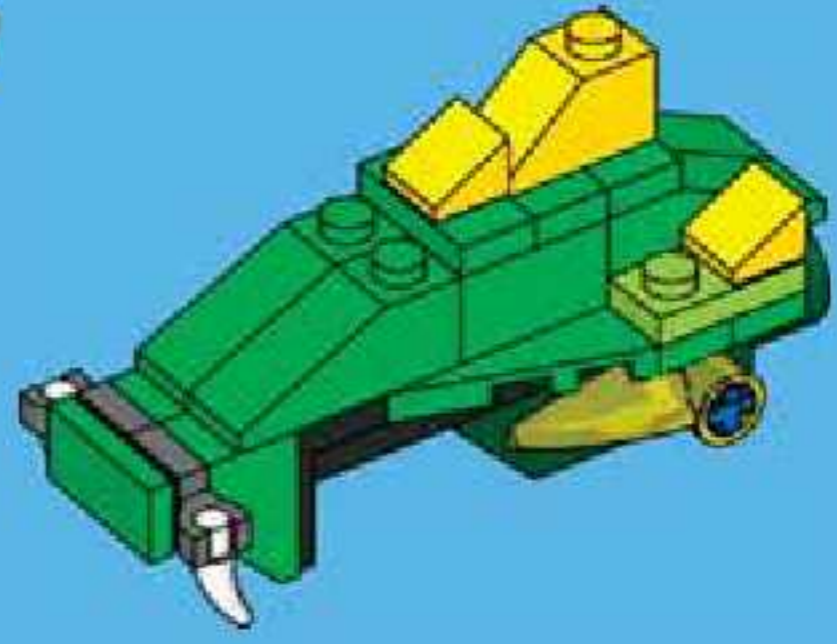

7

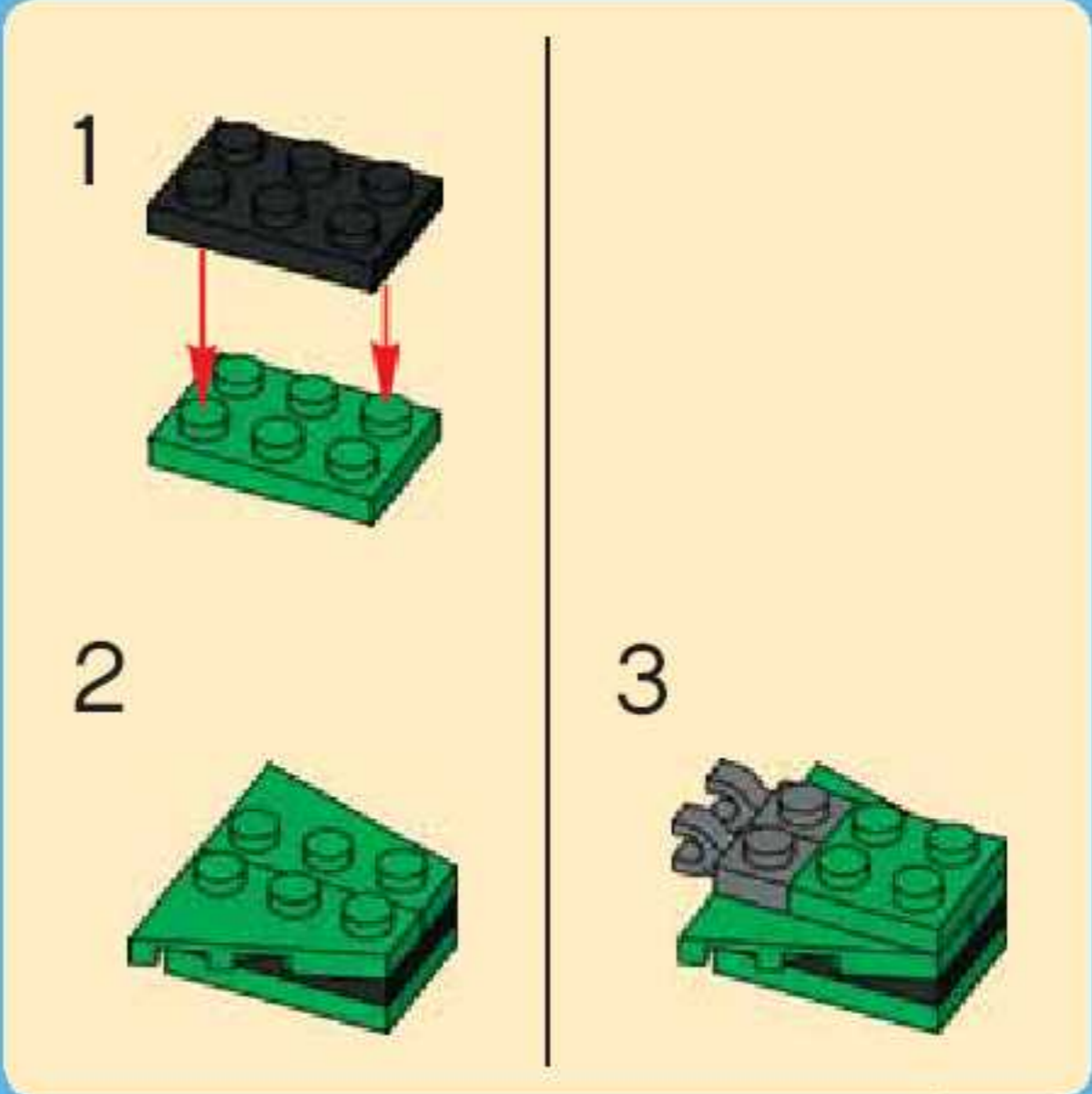
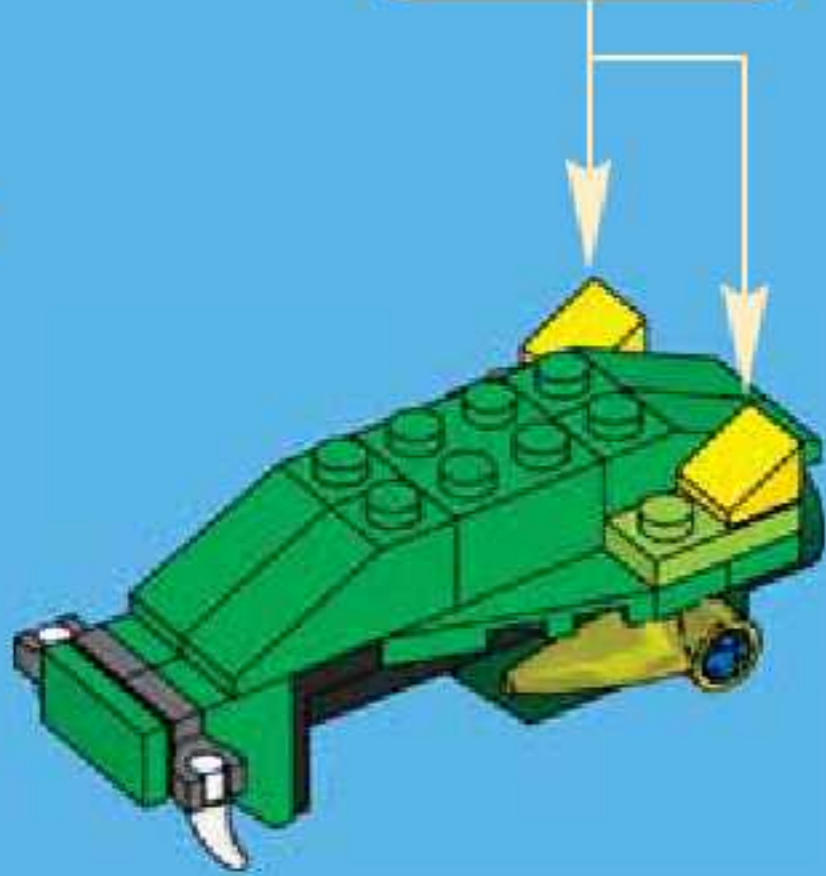

8

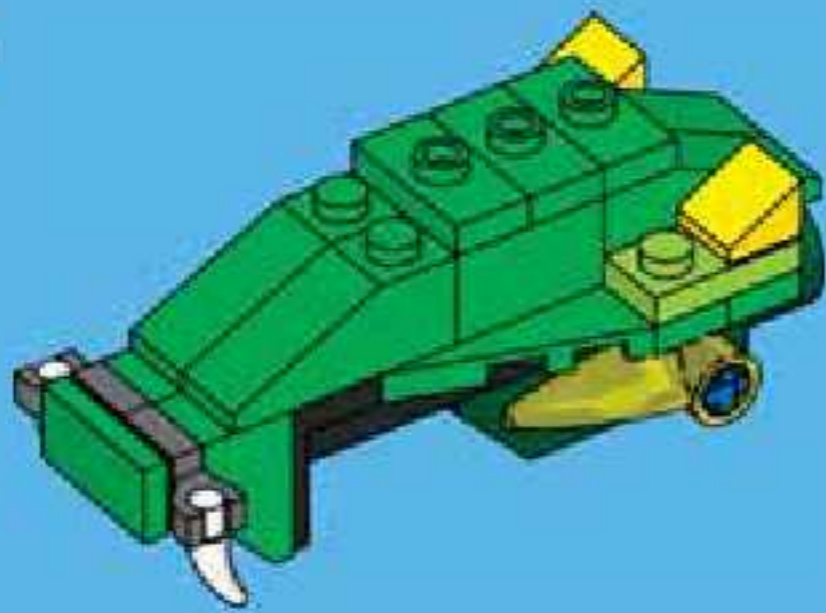

10

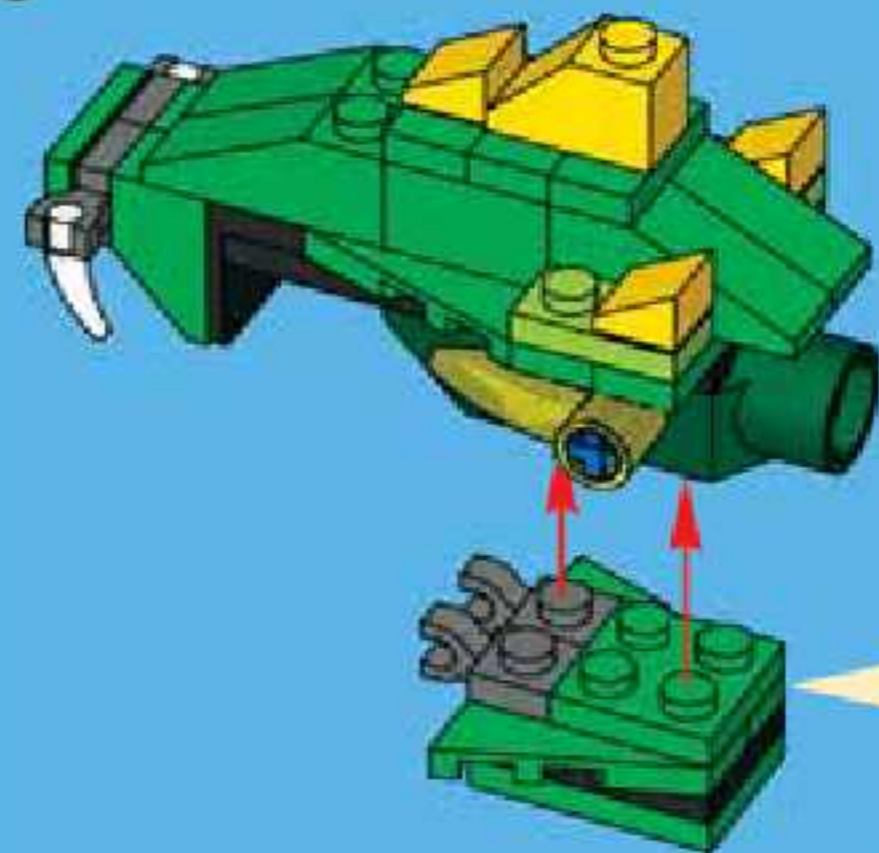

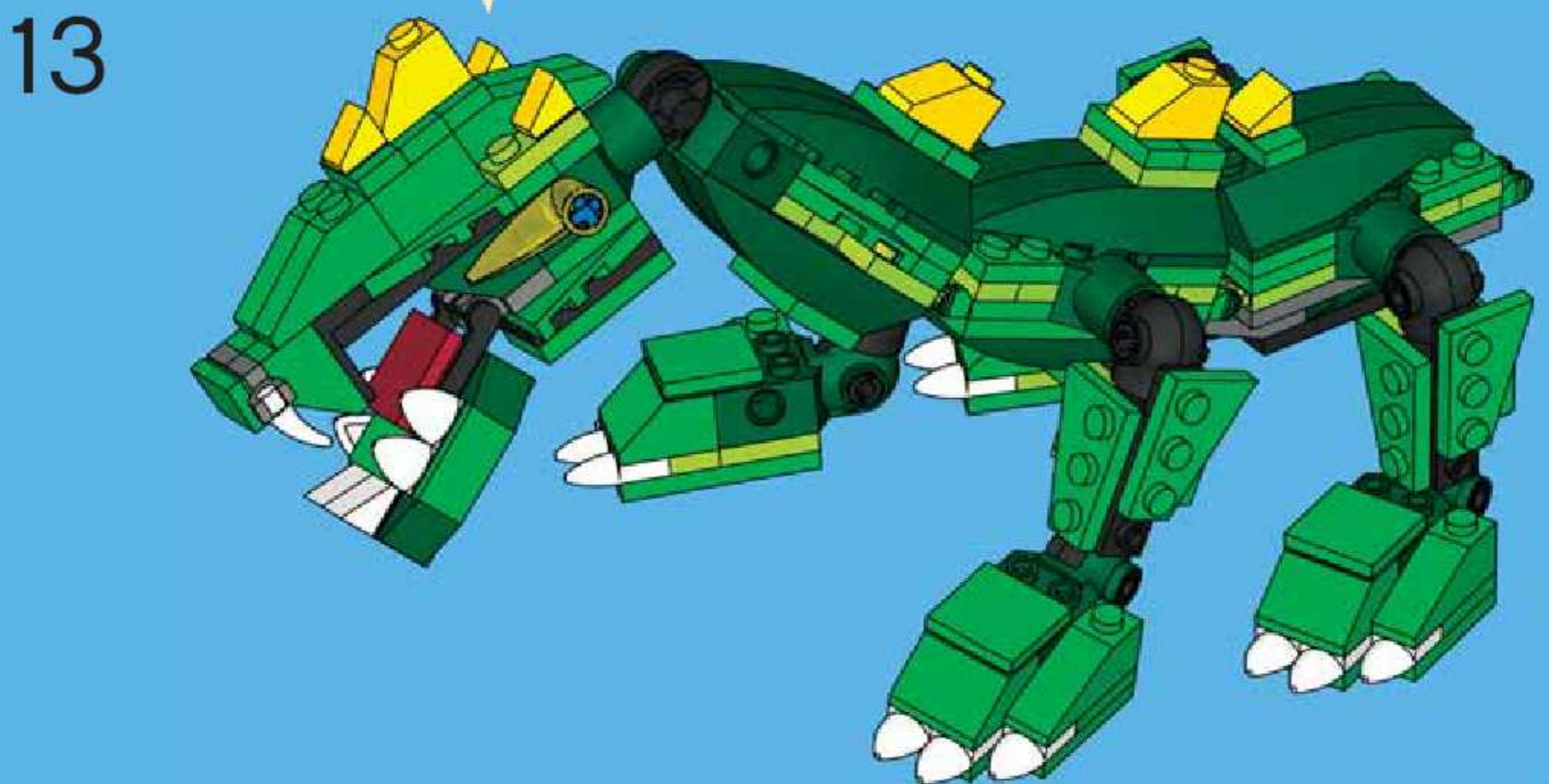
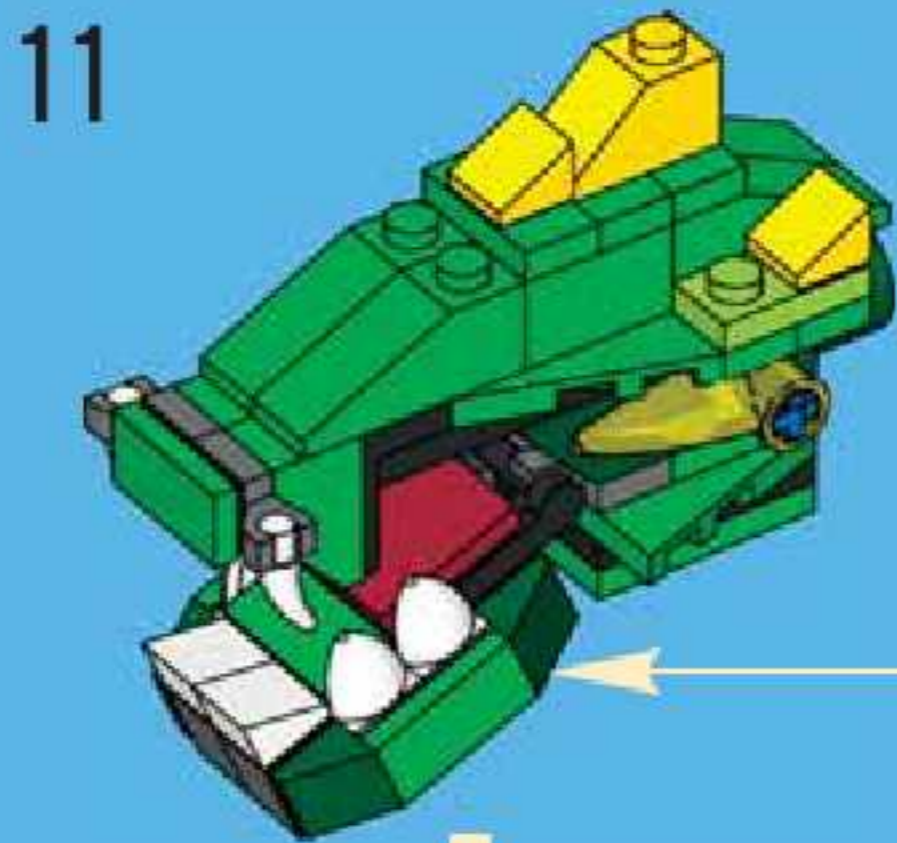
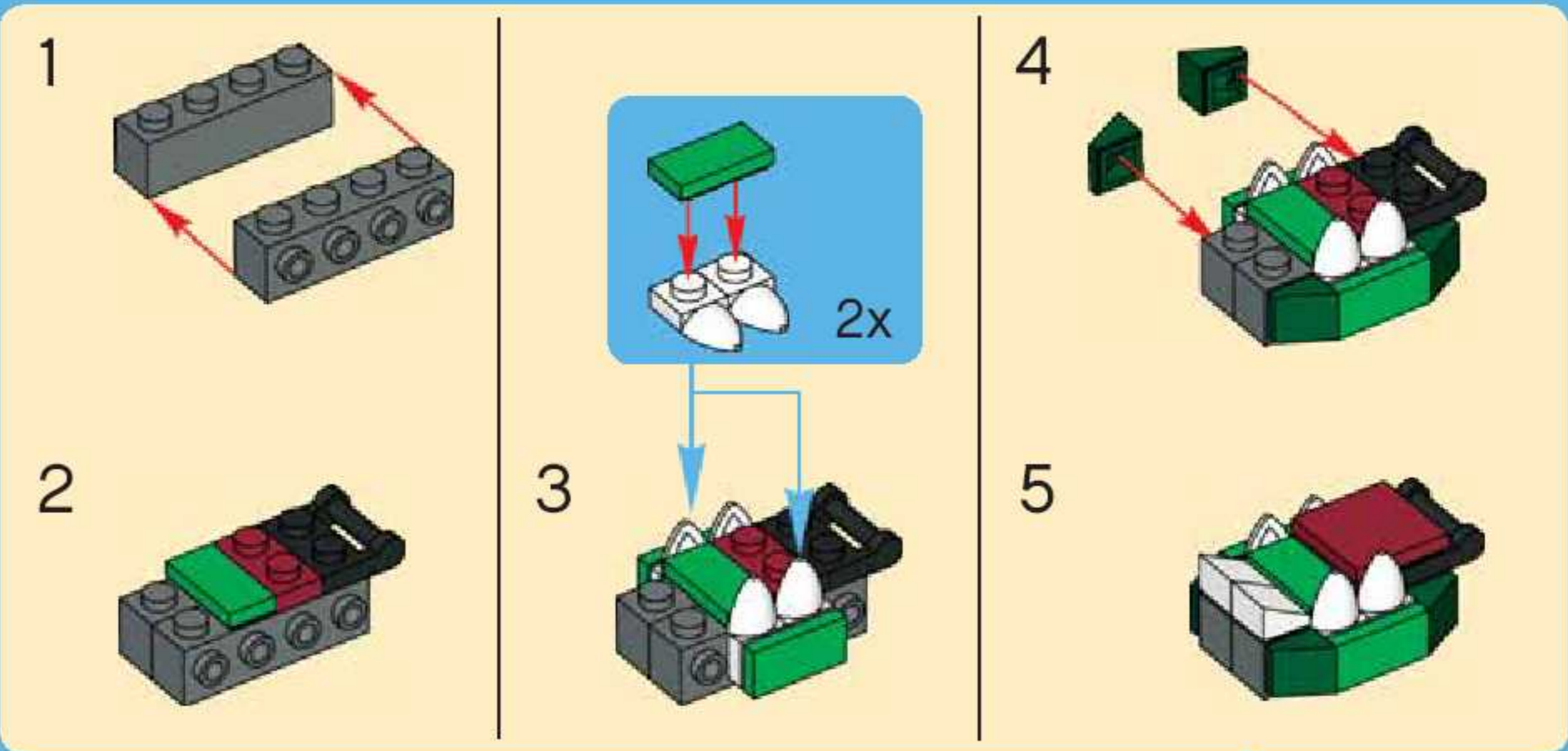

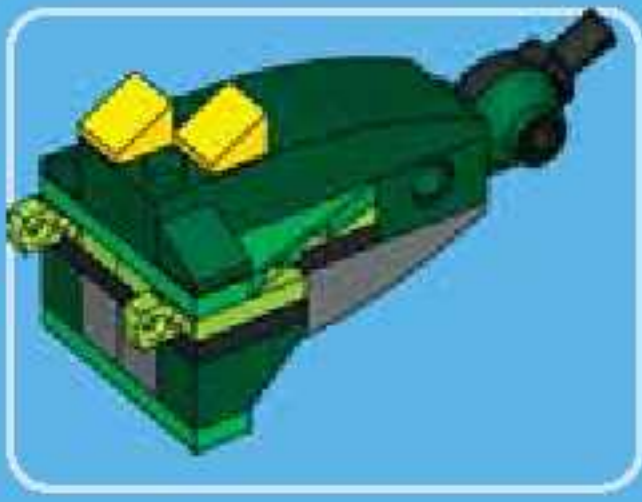

1

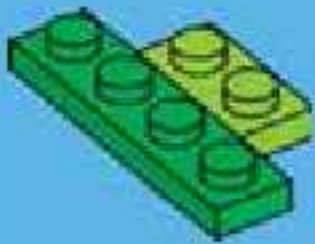

2

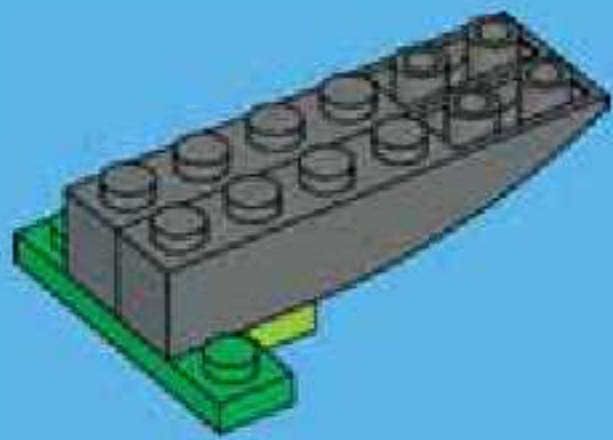

3

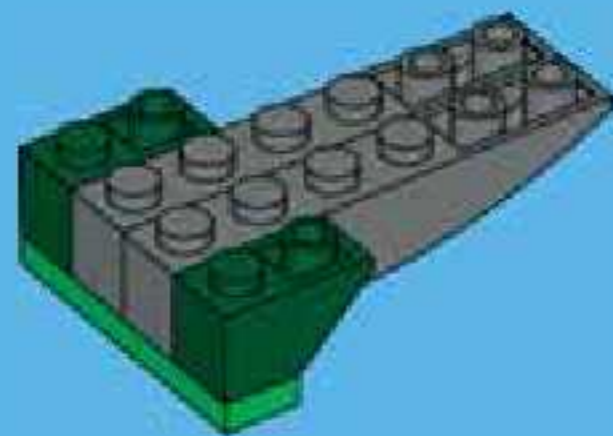

4

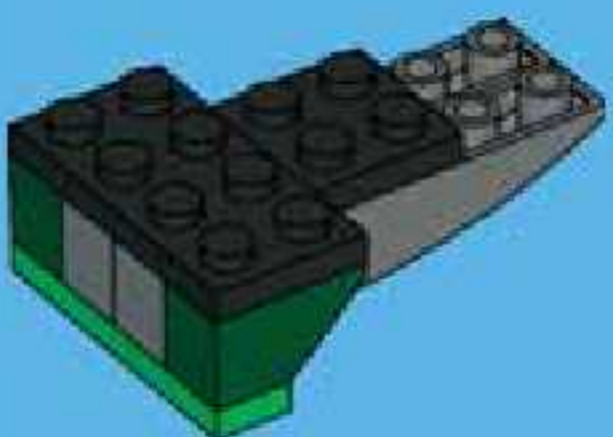

5

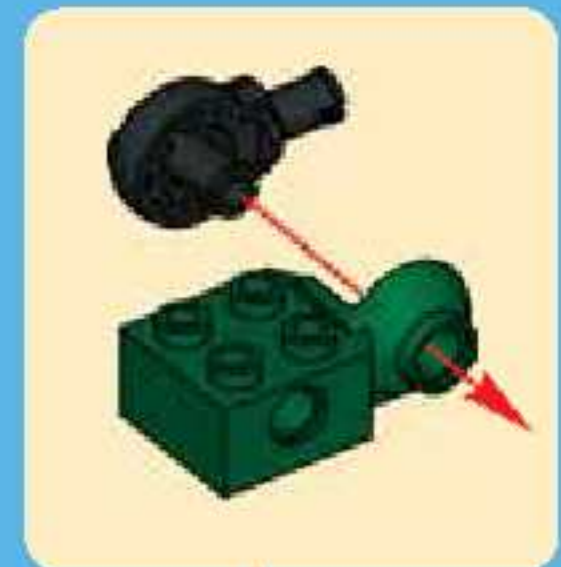
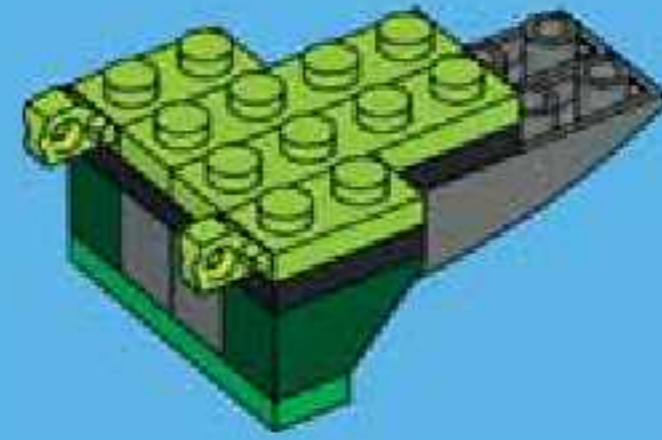

6

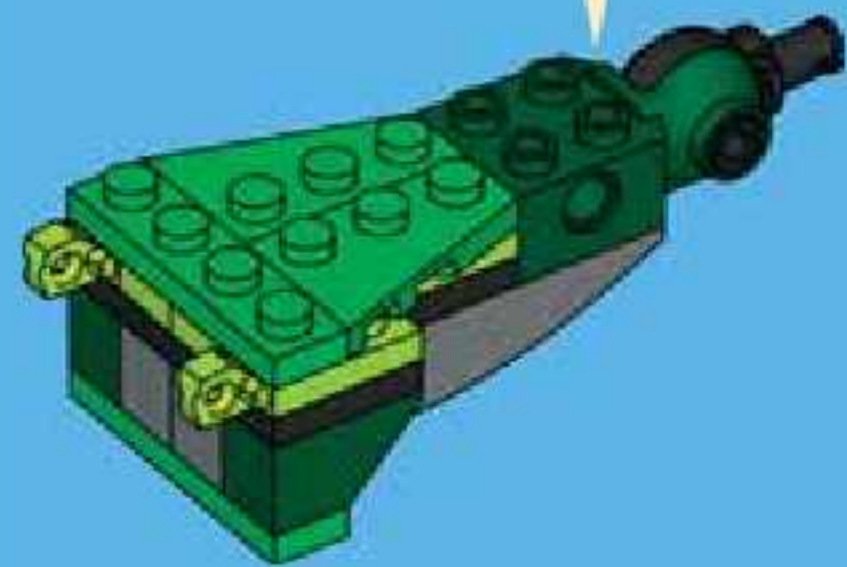

7

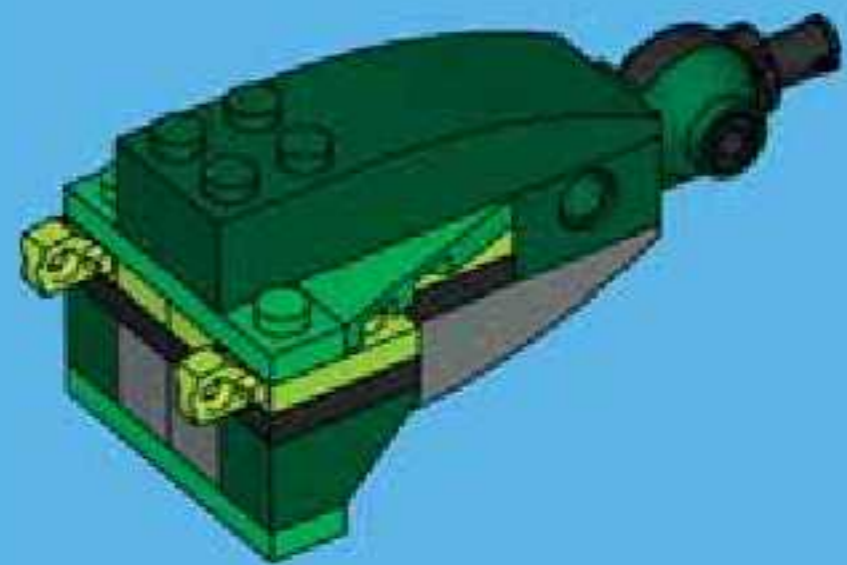

8

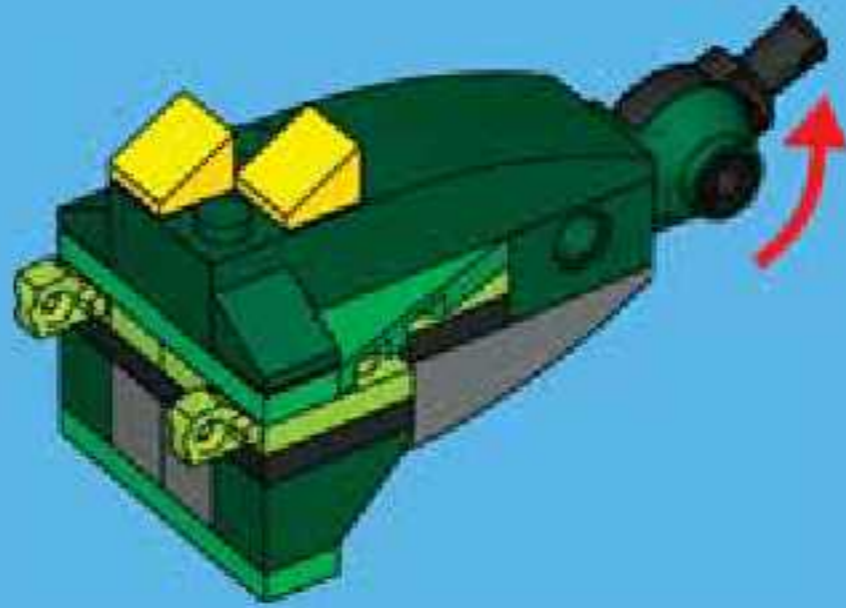

14



1

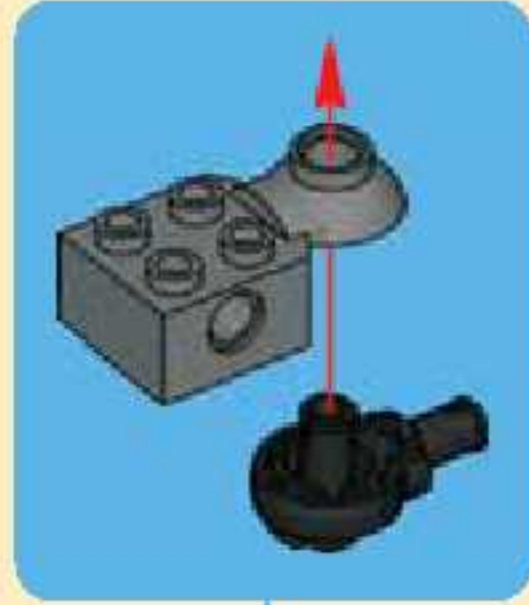
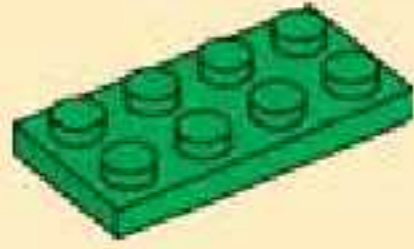

2

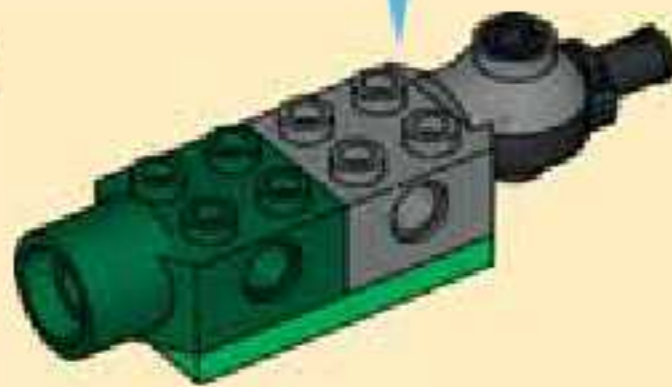

3

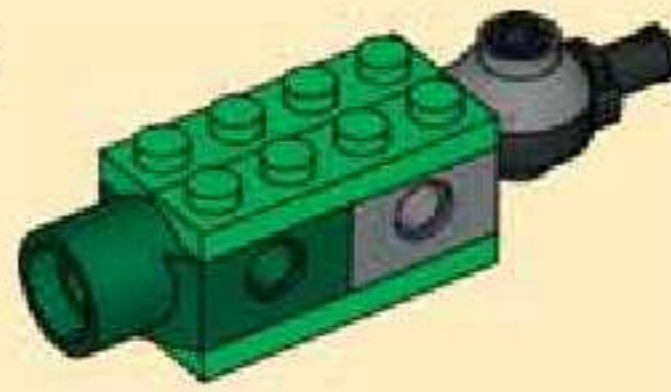

4

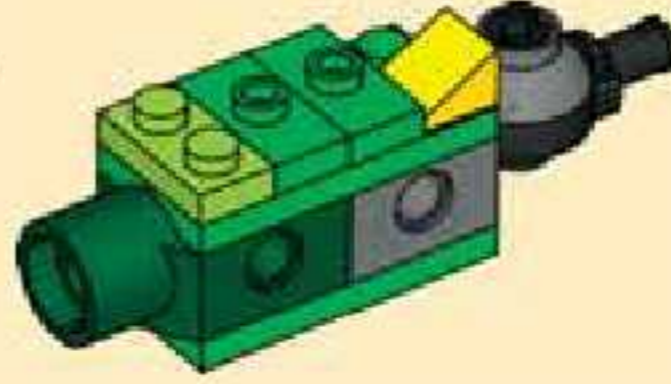

5

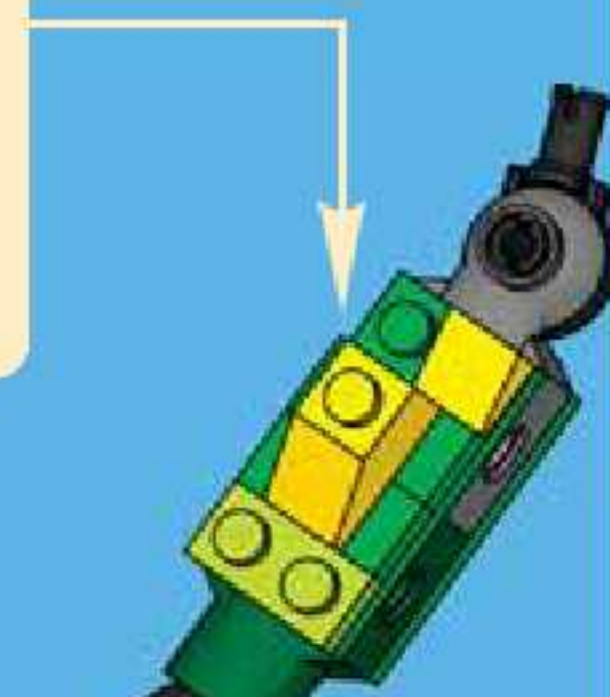
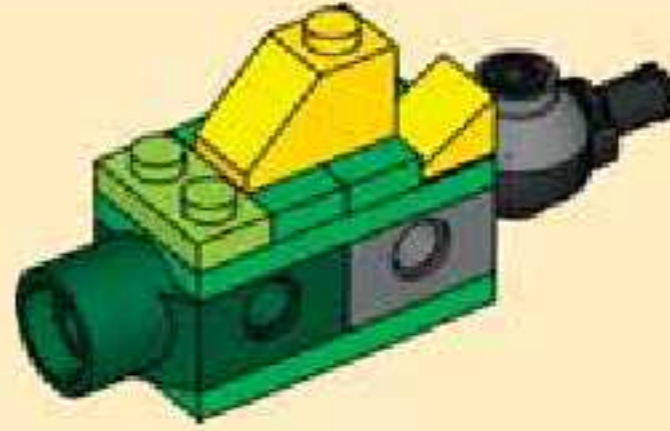

15

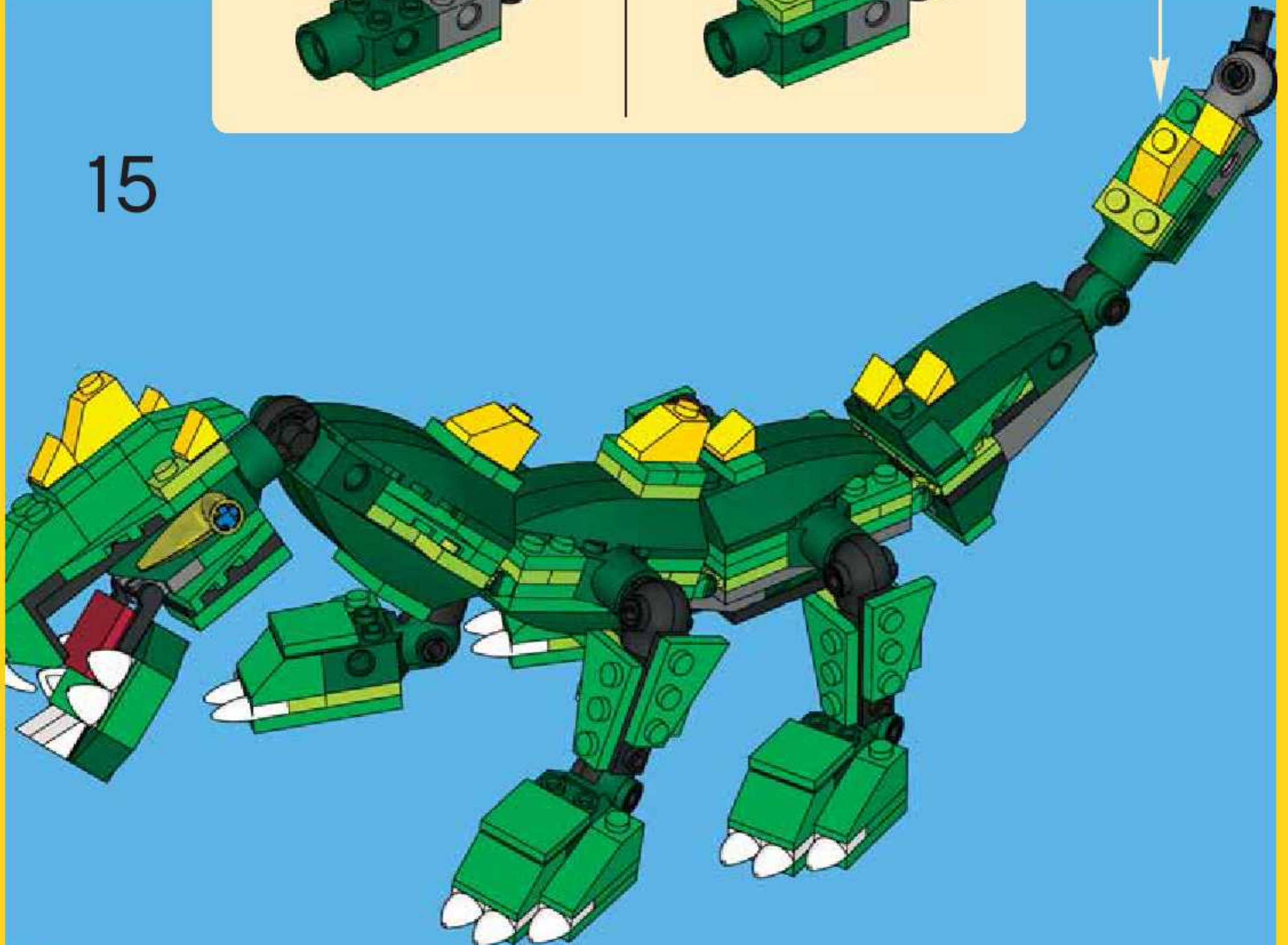

1

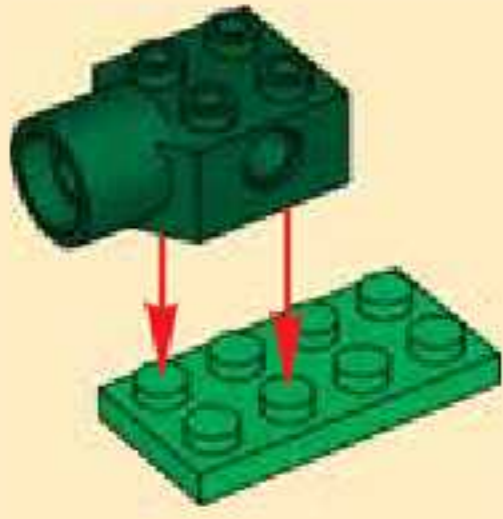

2

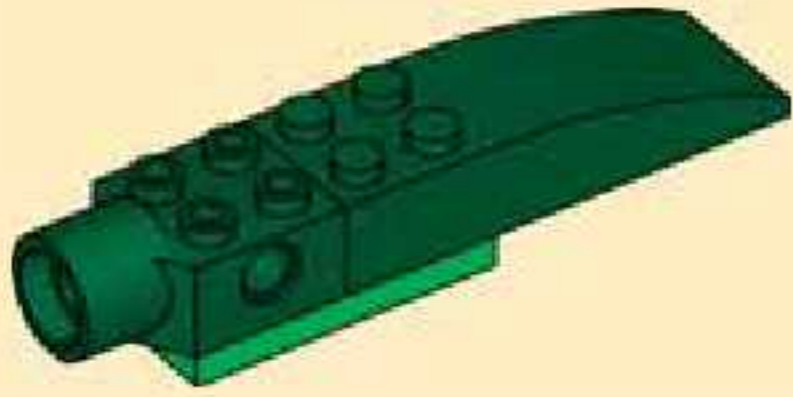

3

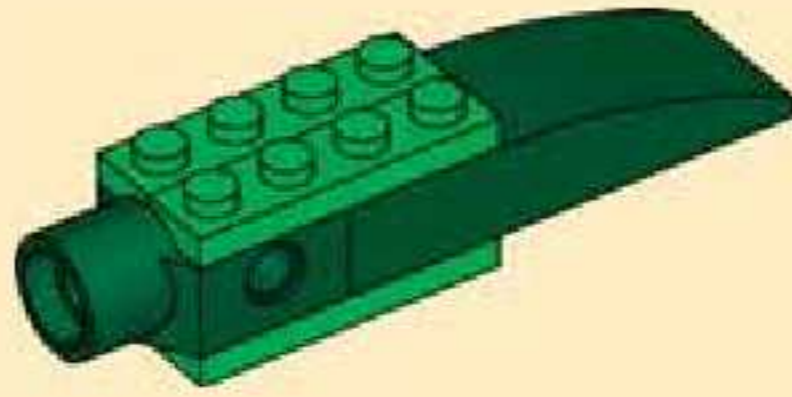

4

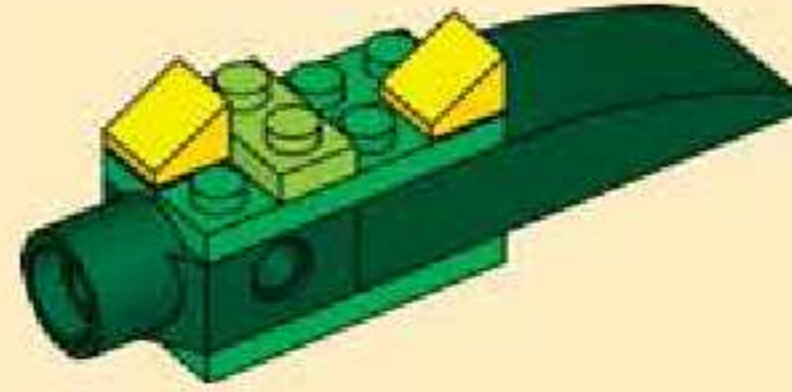

16

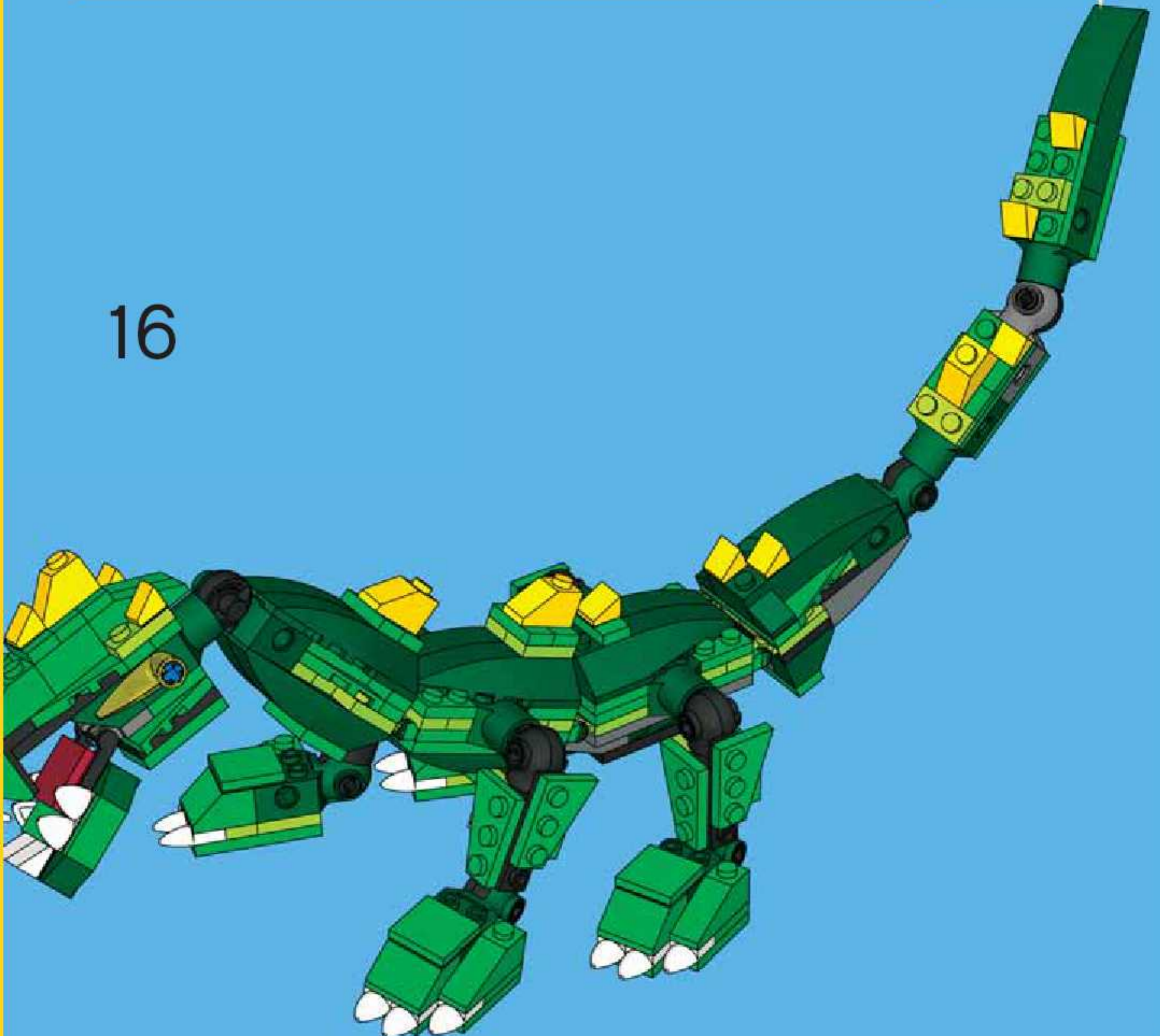

1

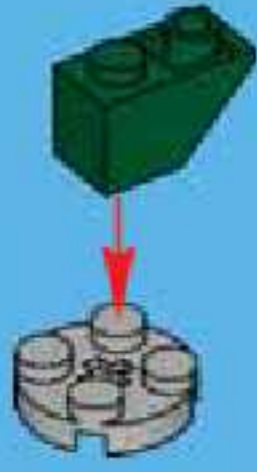

2



3



4



5

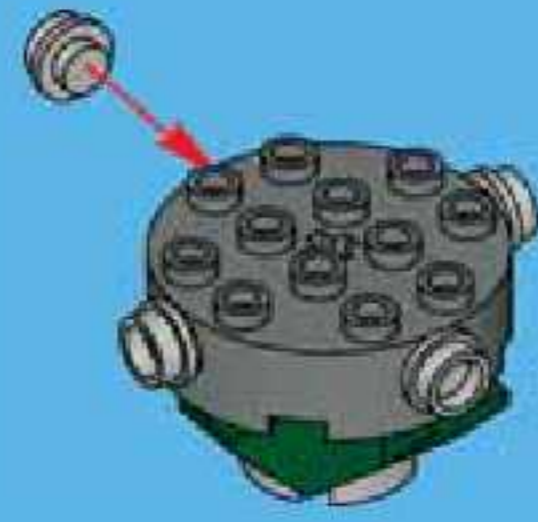

6

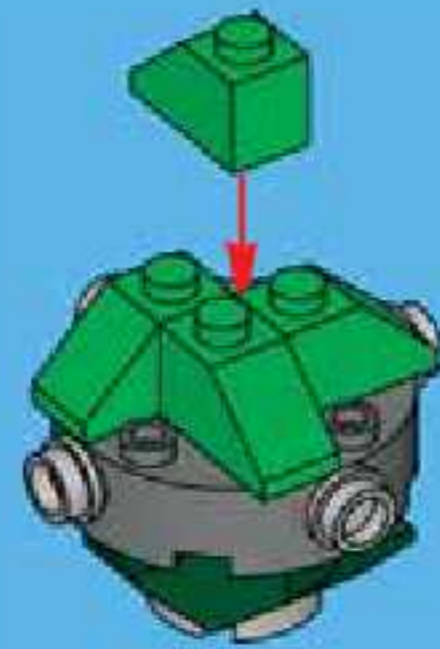

7

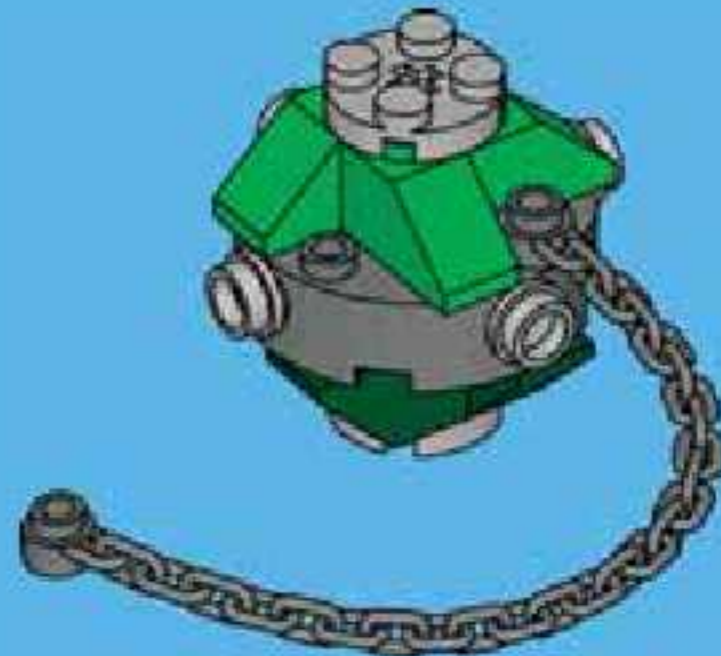

17

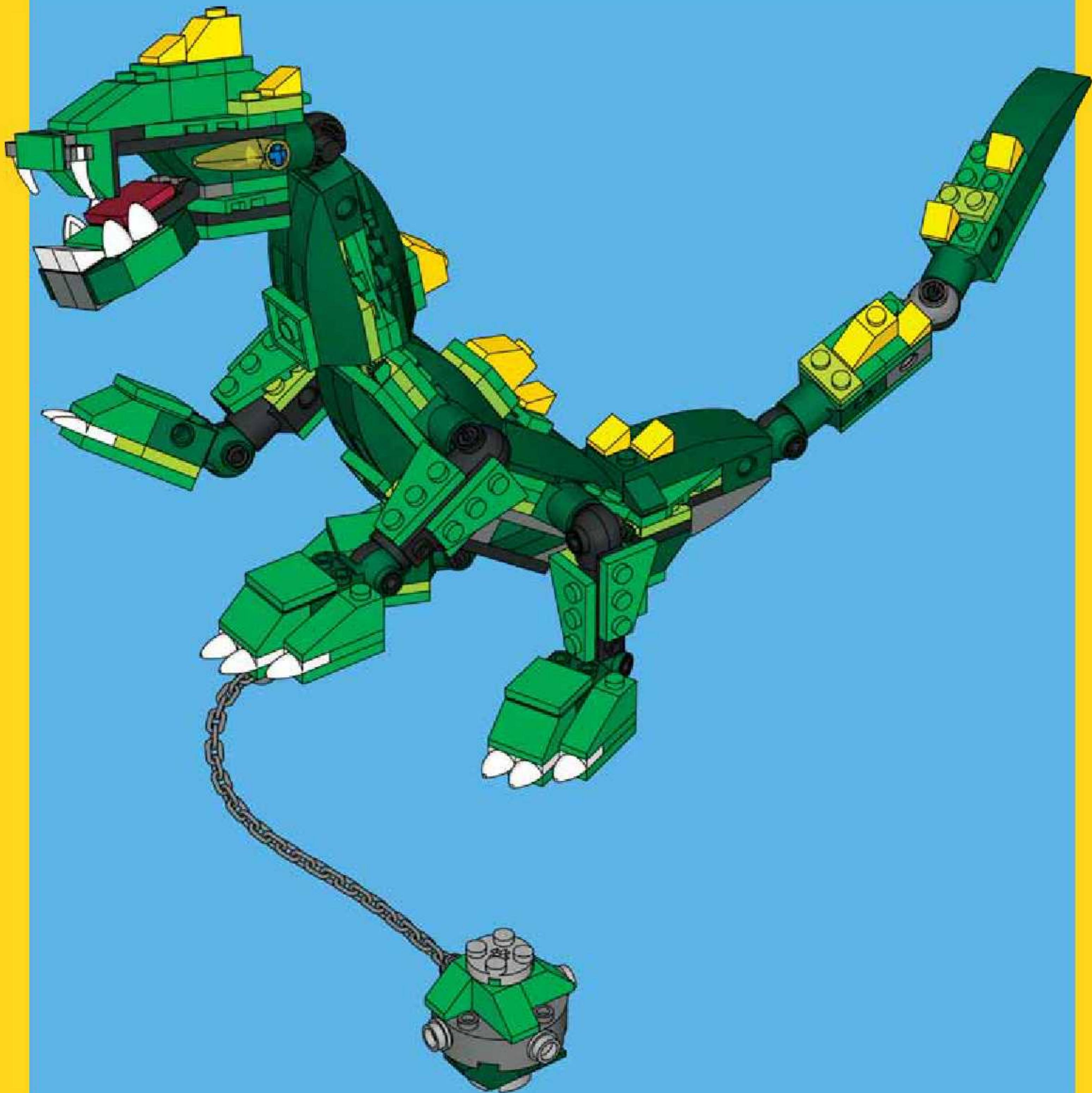

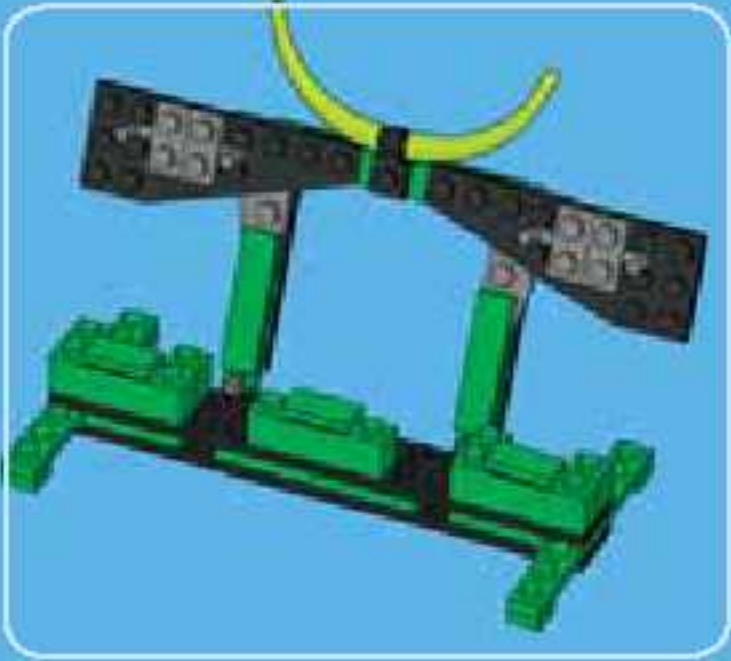
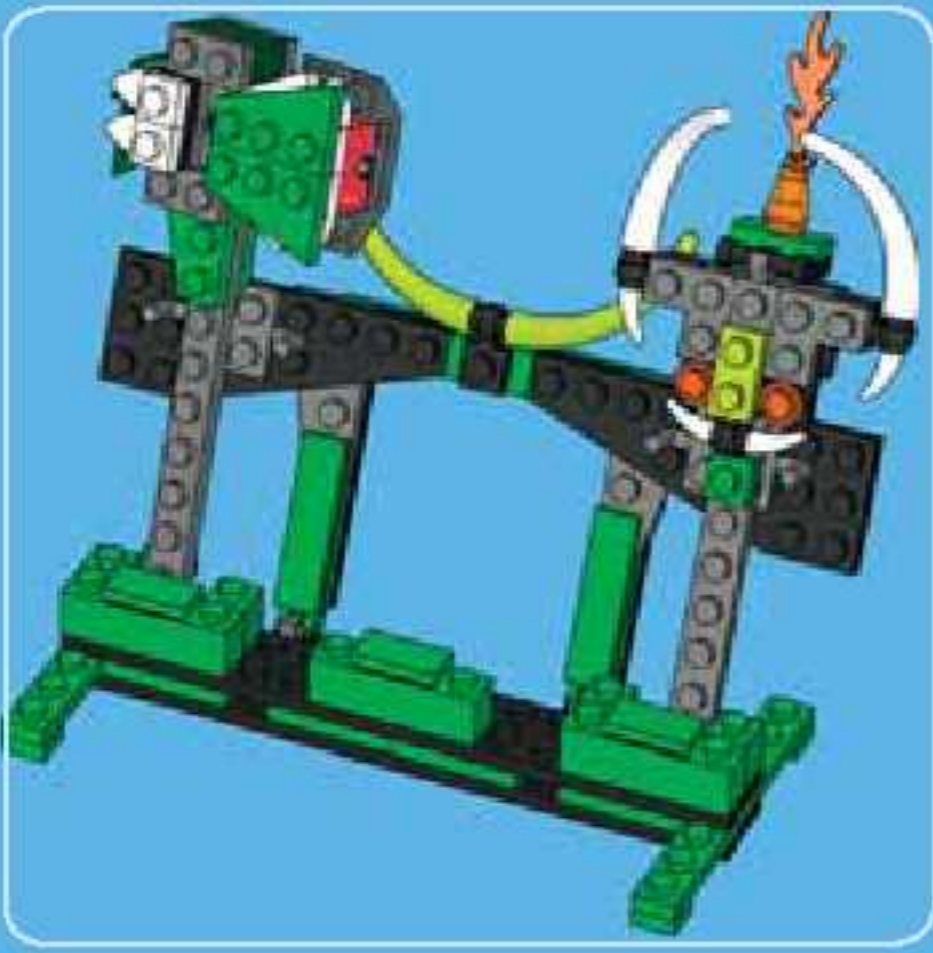

1



2

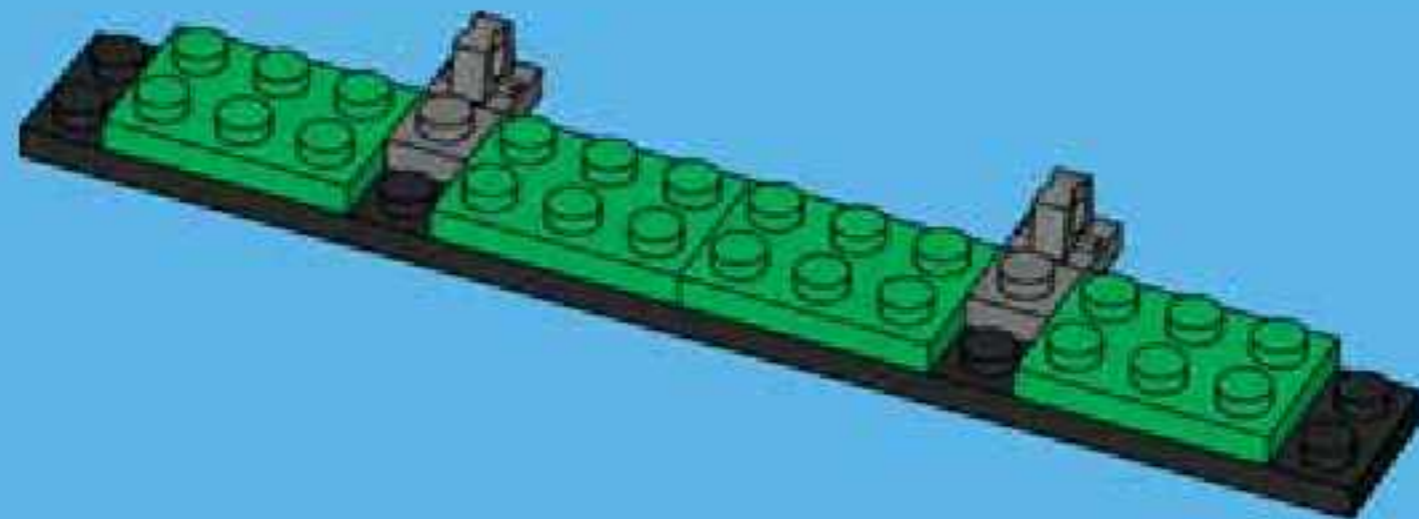

3

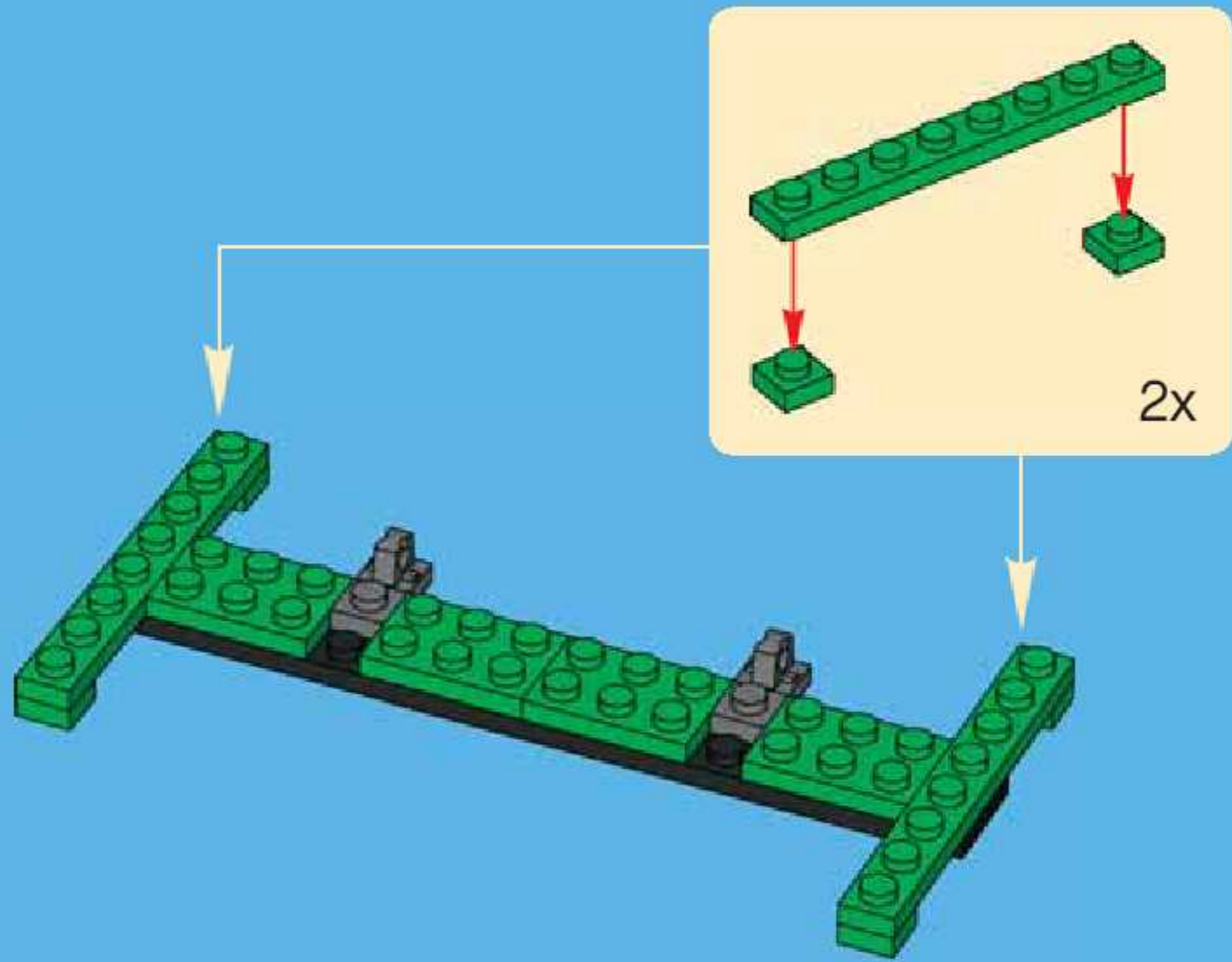

4

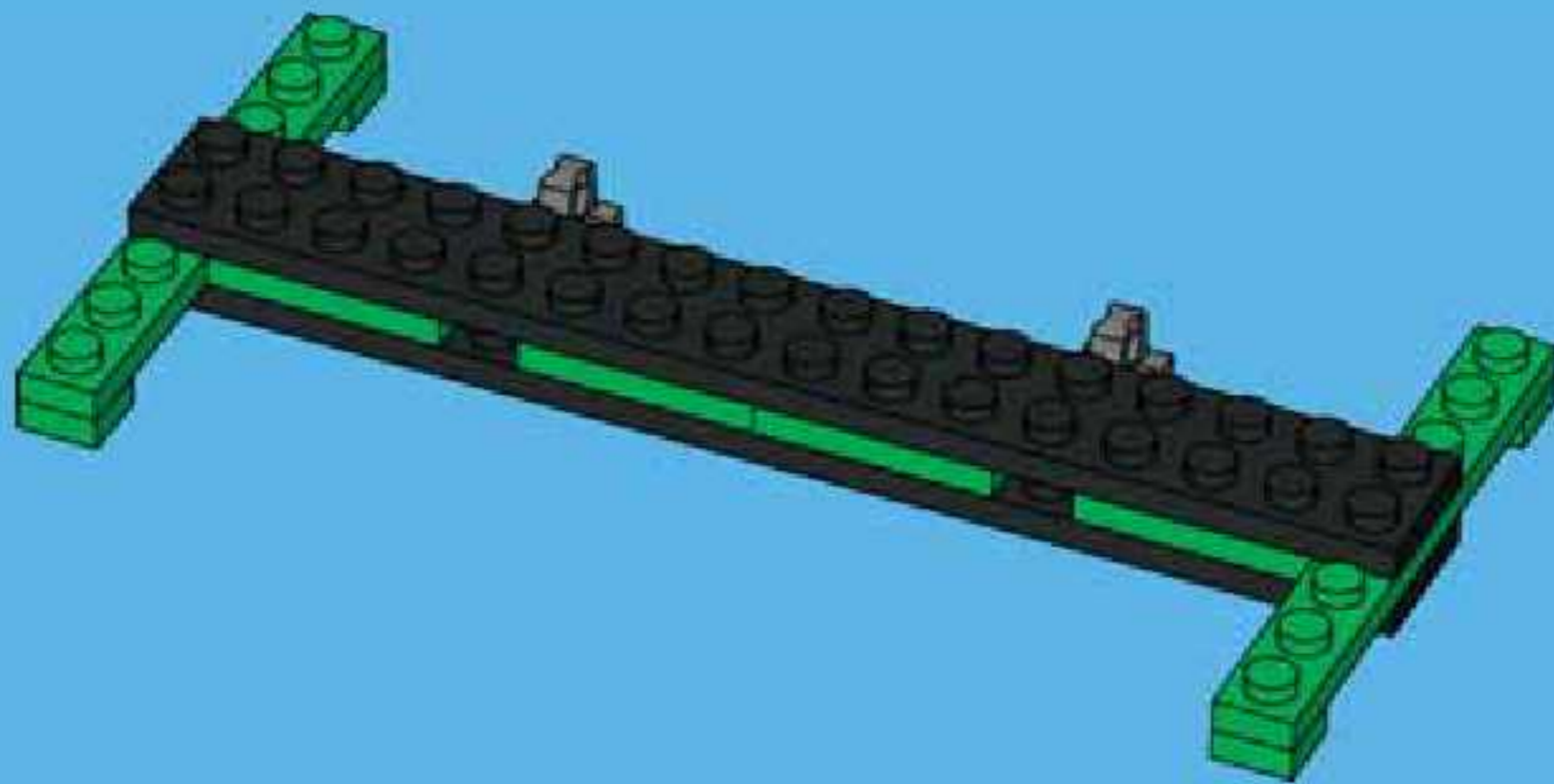

5

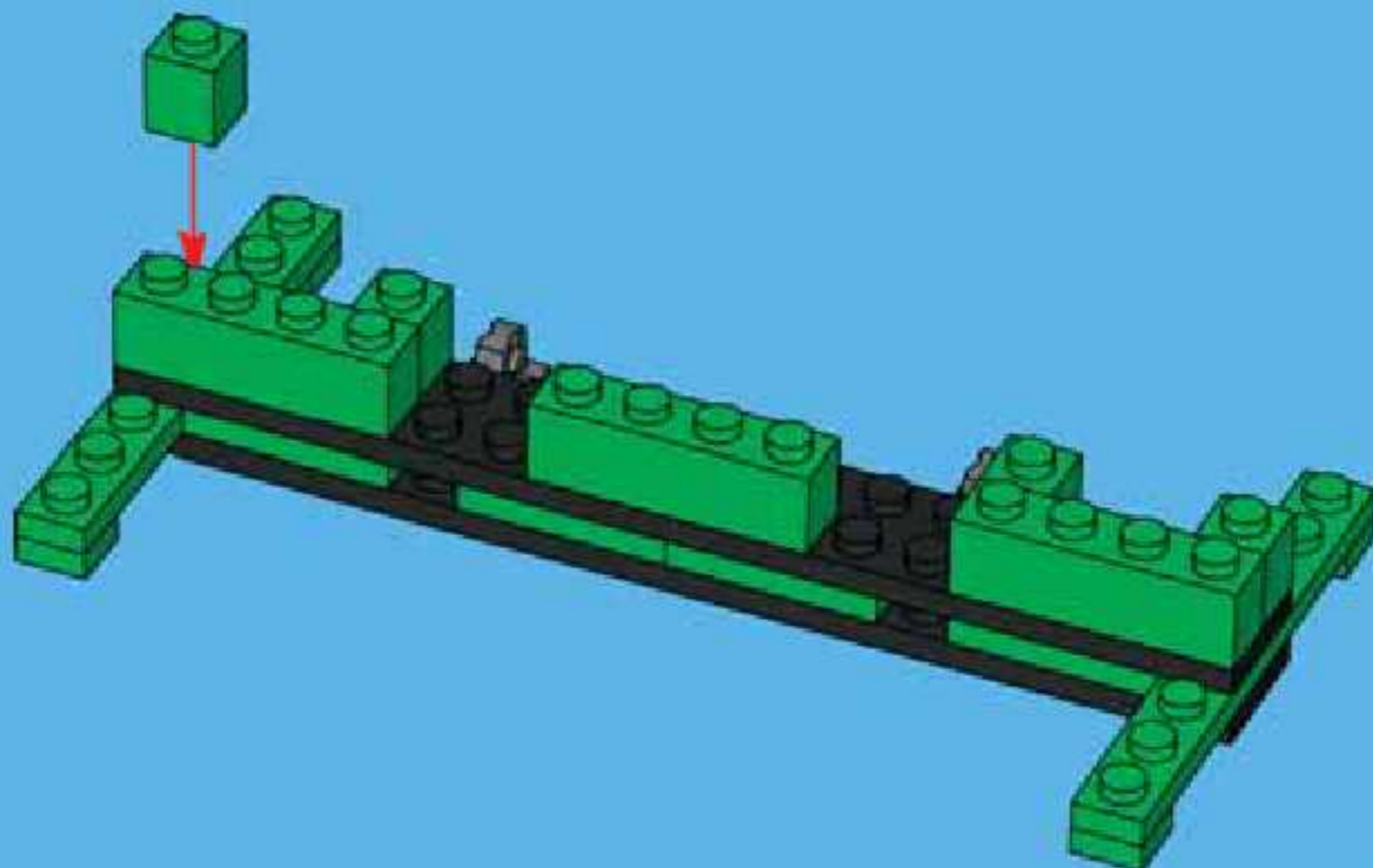

1

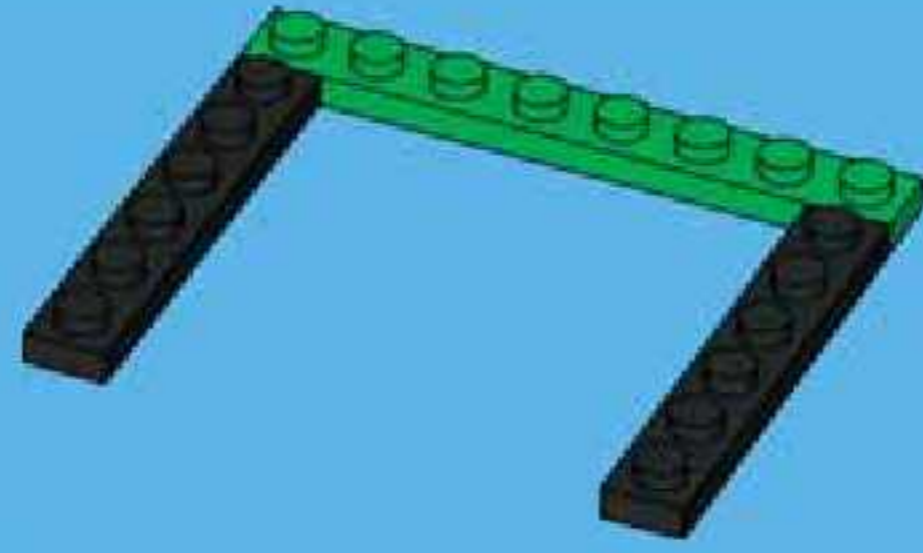

2

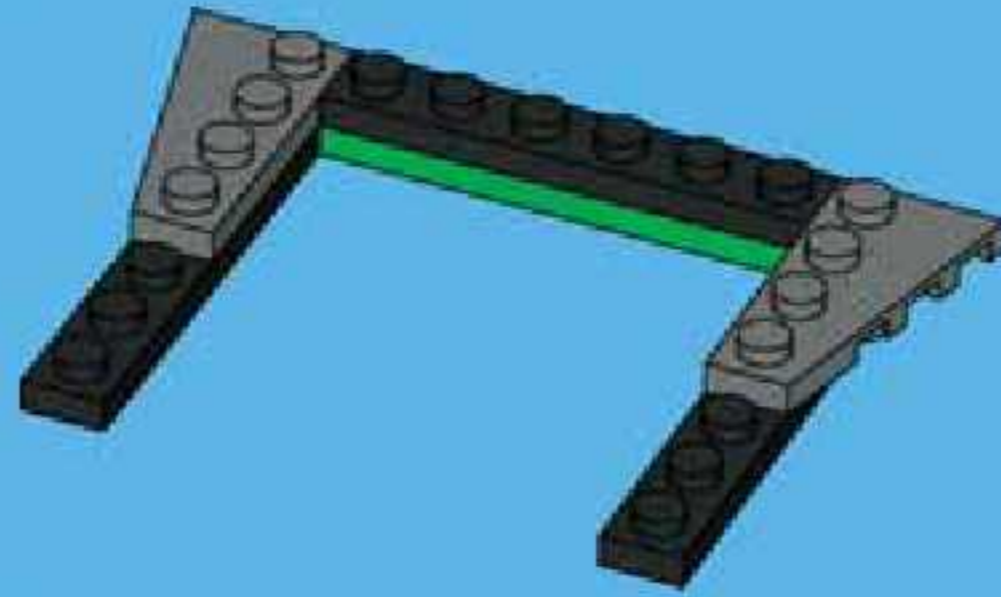

3

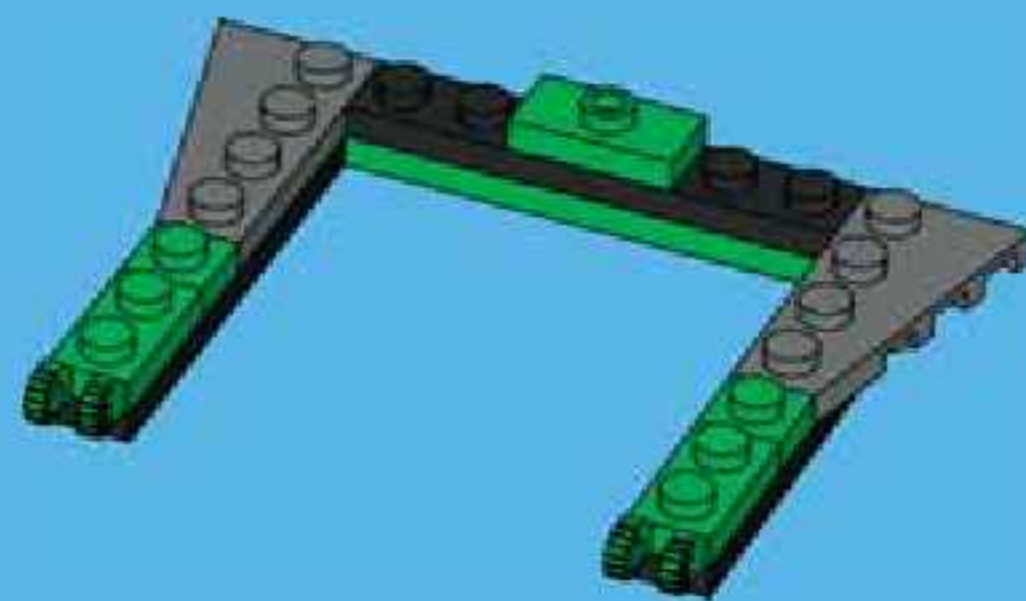

4



5



6

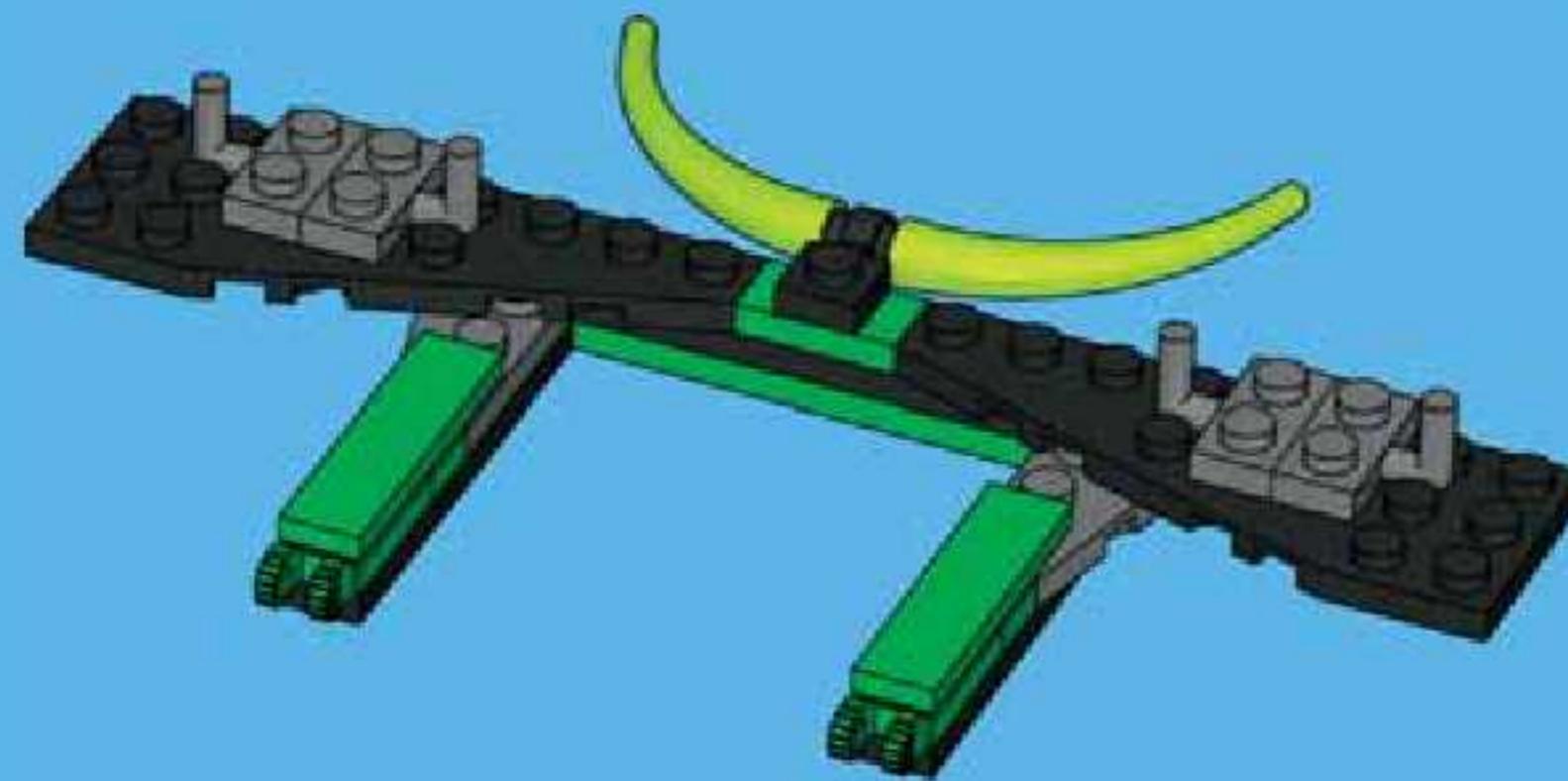

6

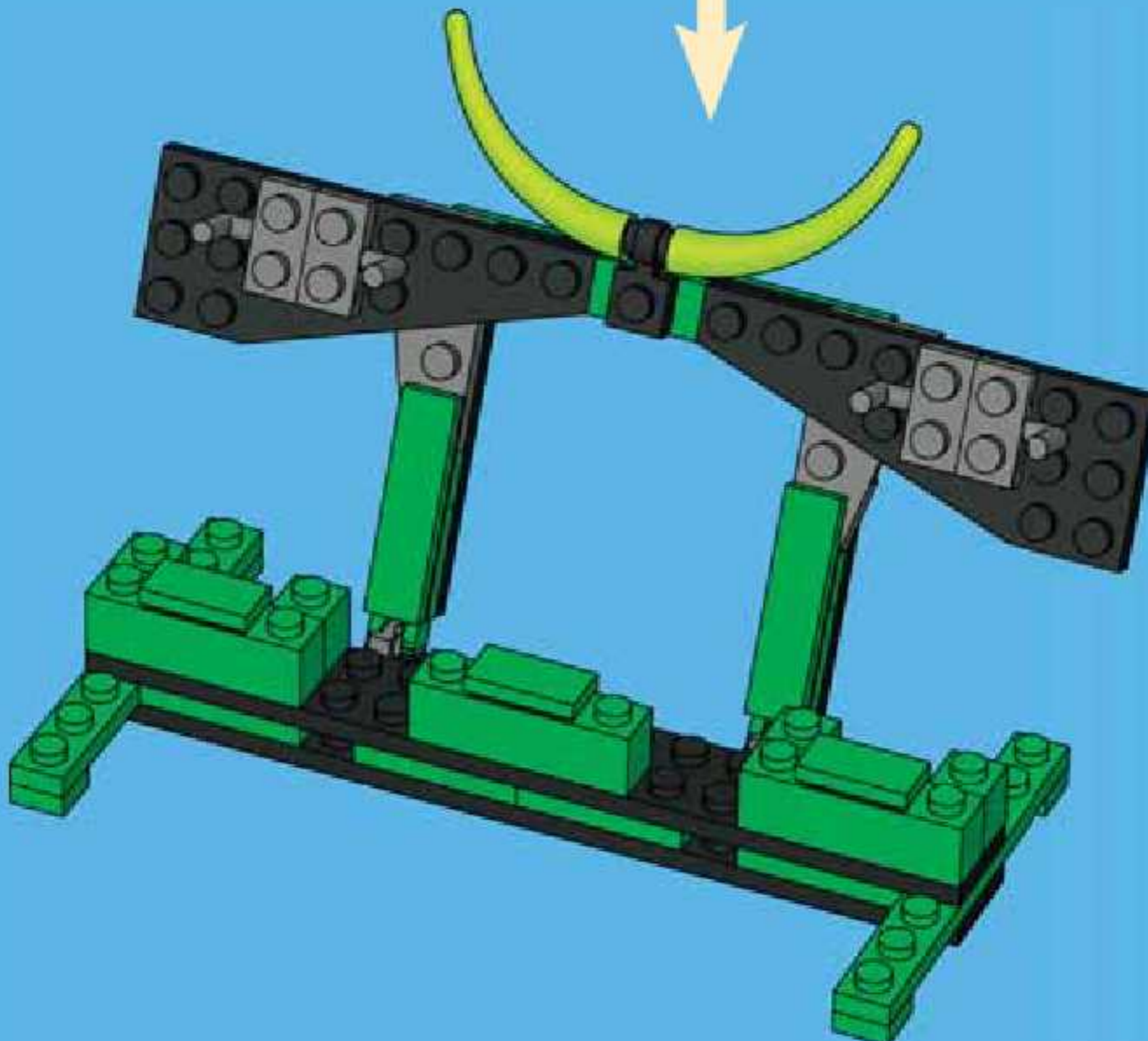

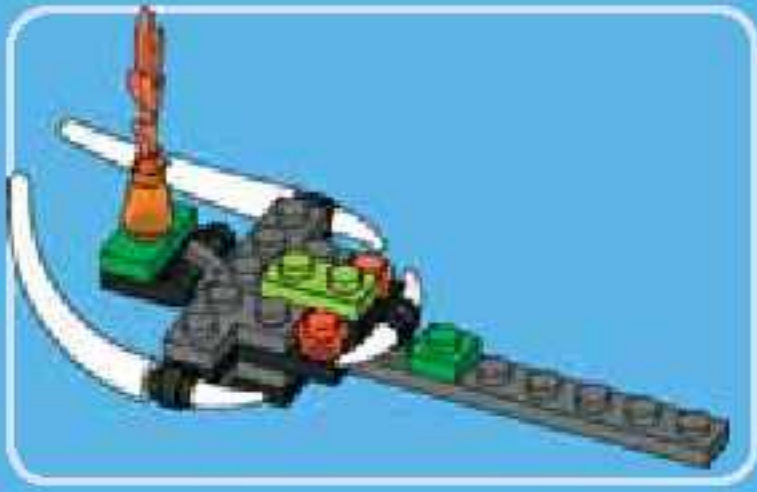

1

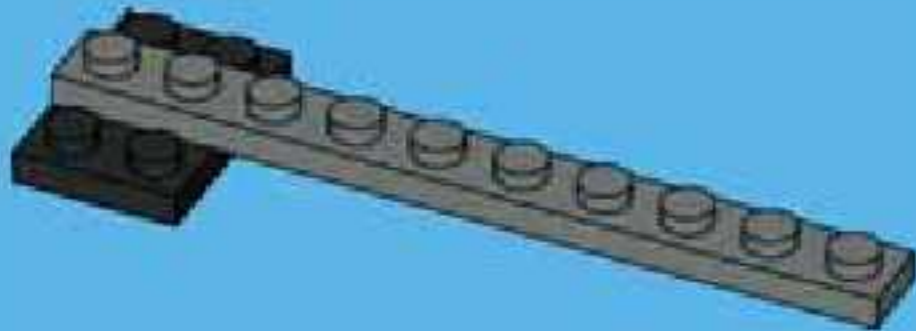

2

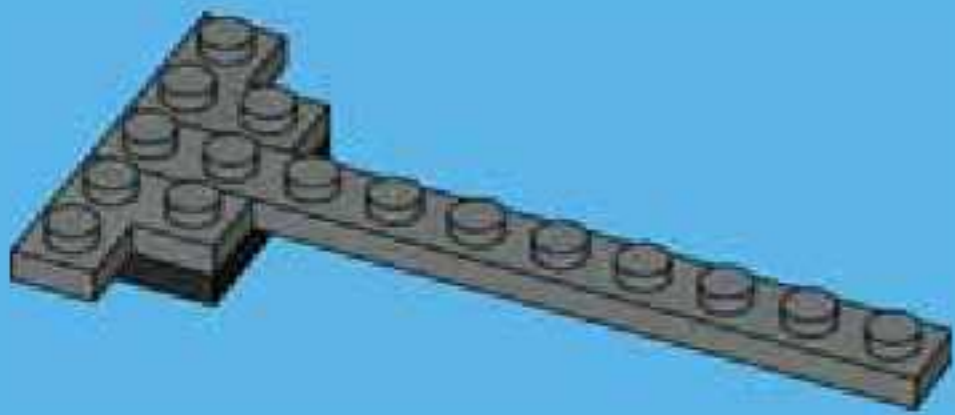

3

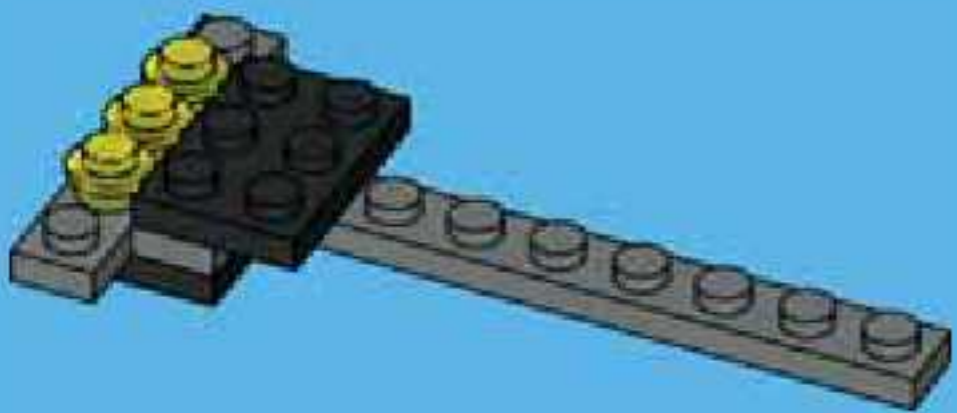

4

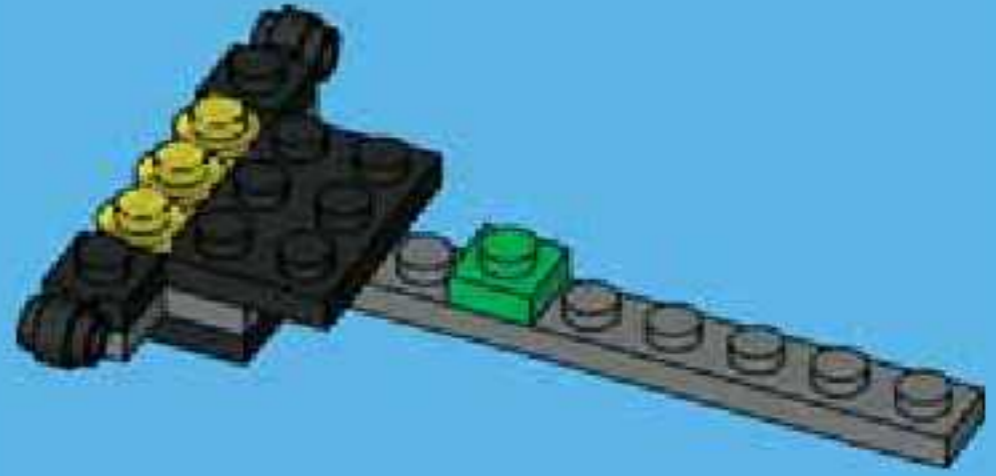

5

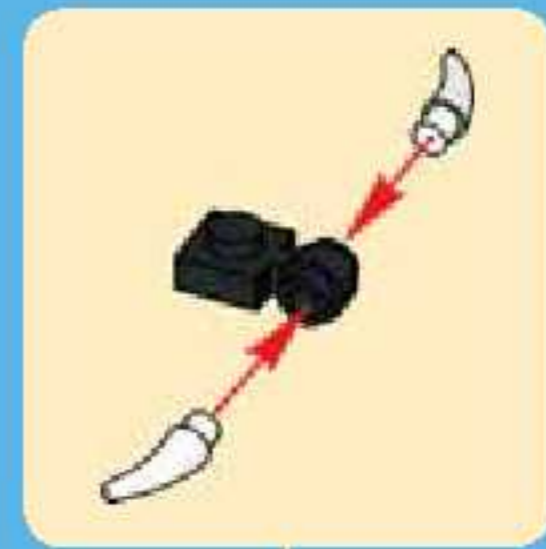
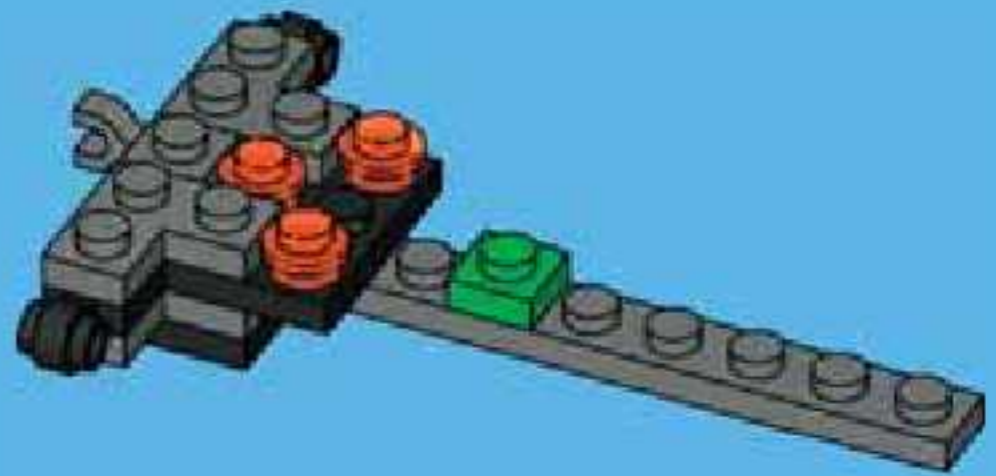

6

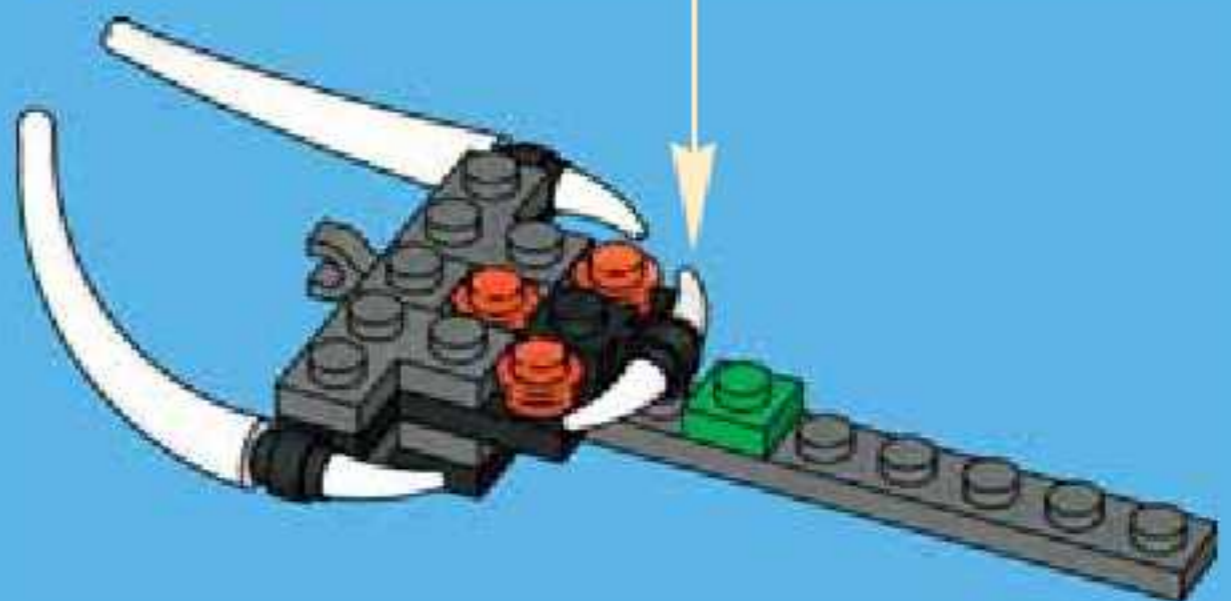

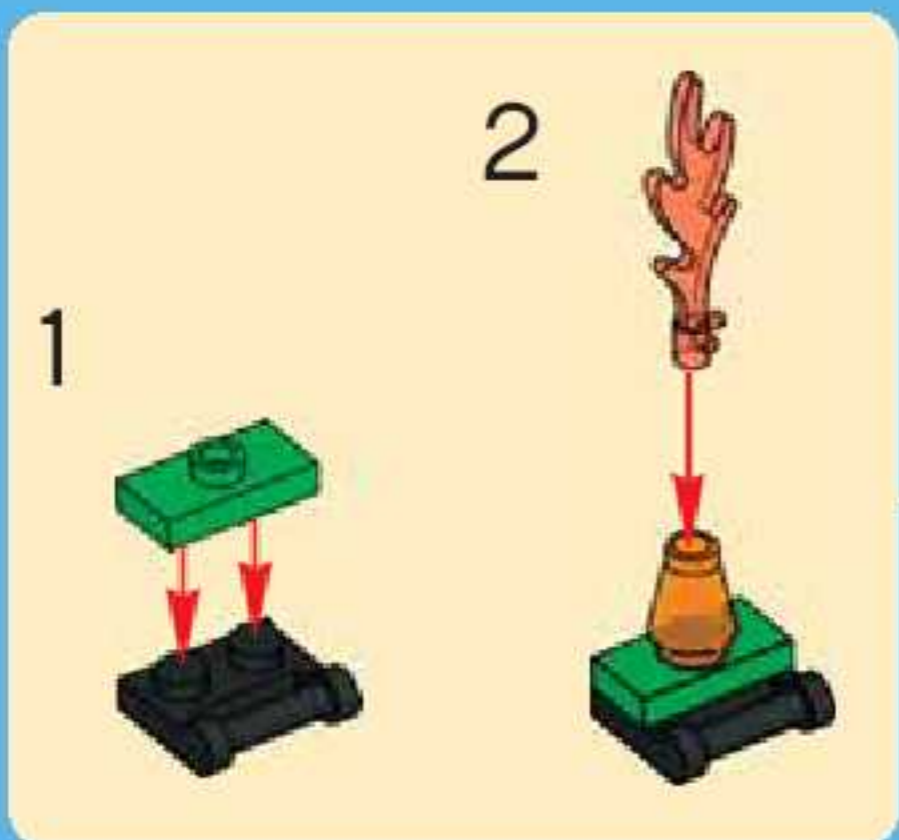

7

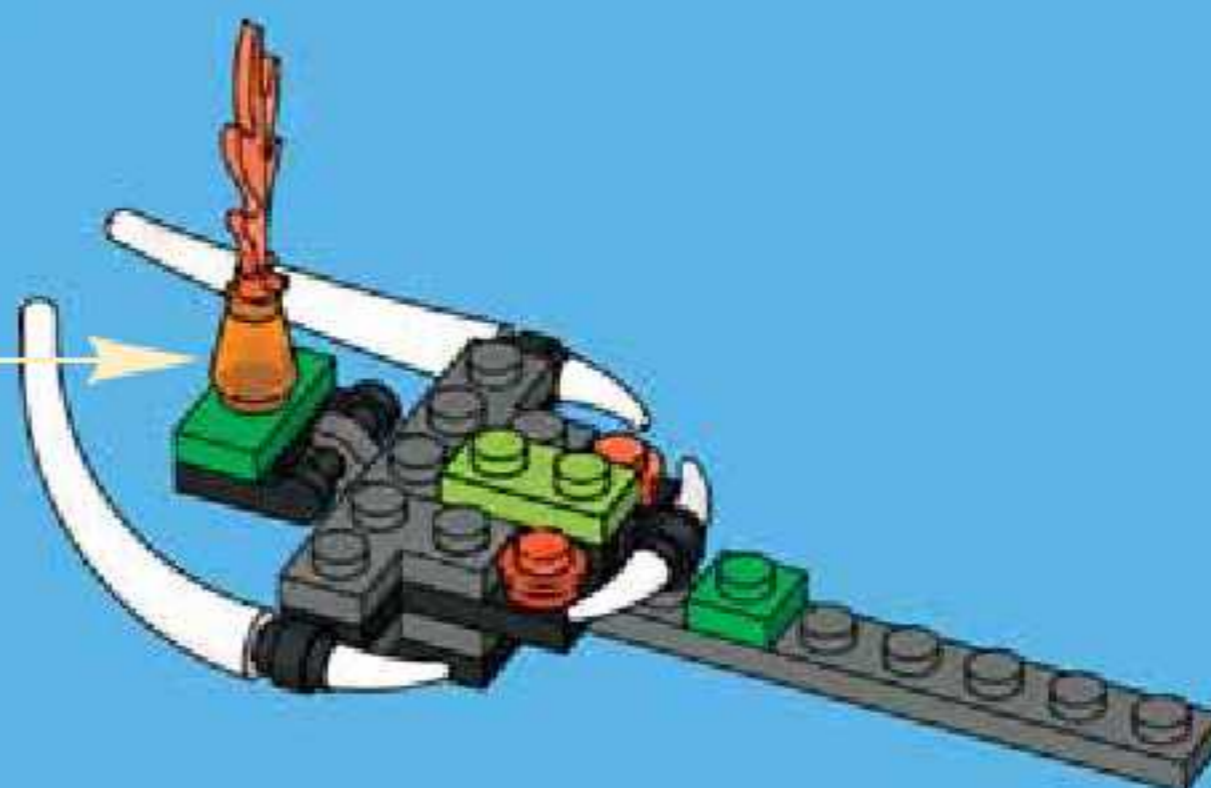

8

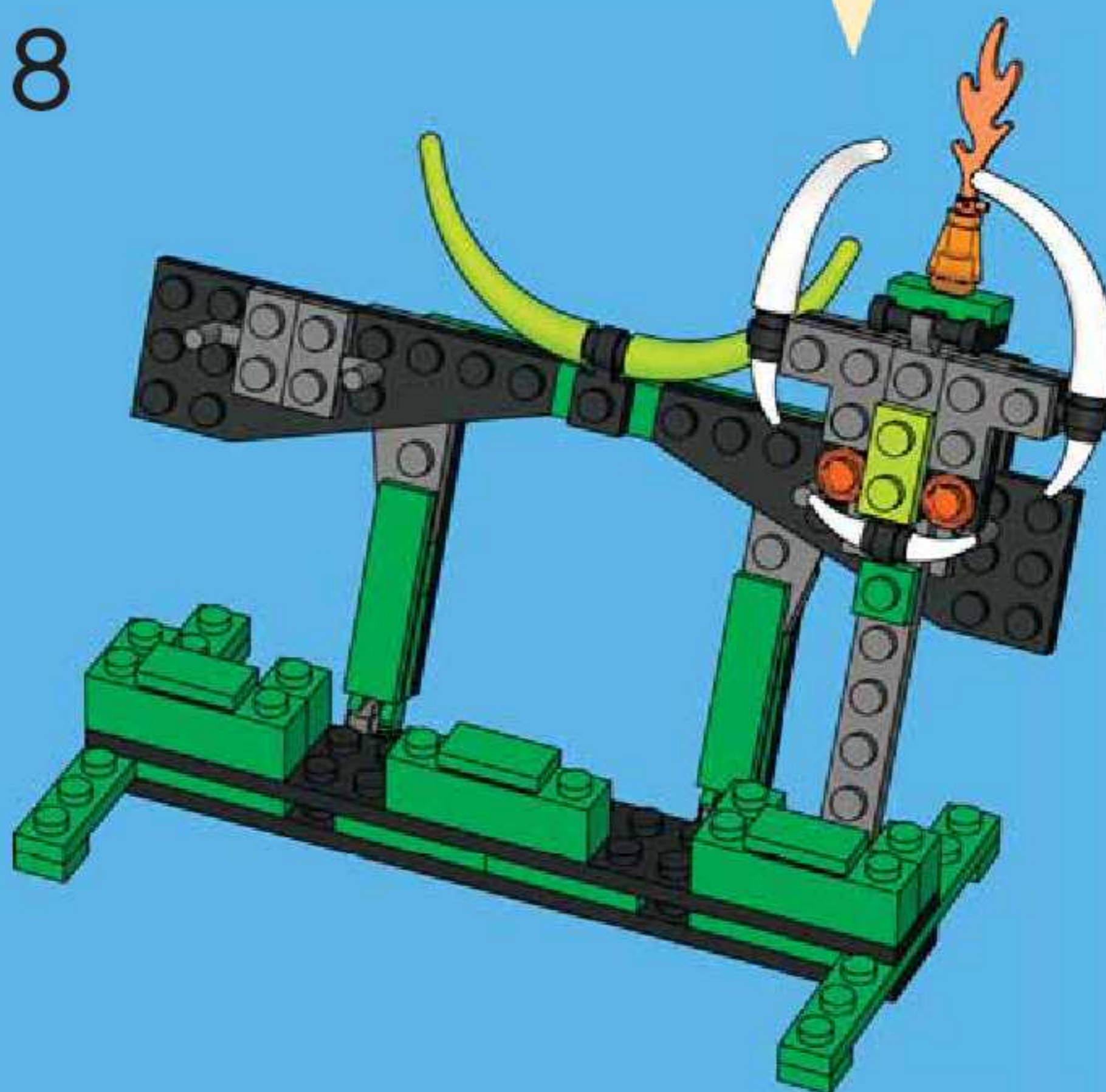



1

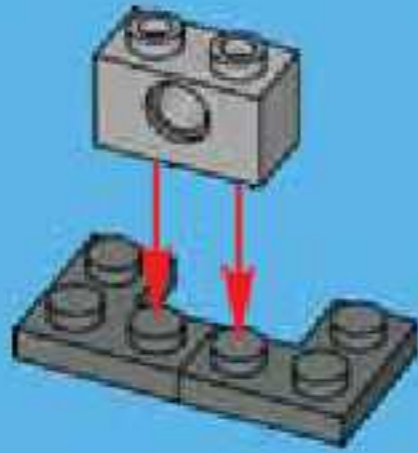

2

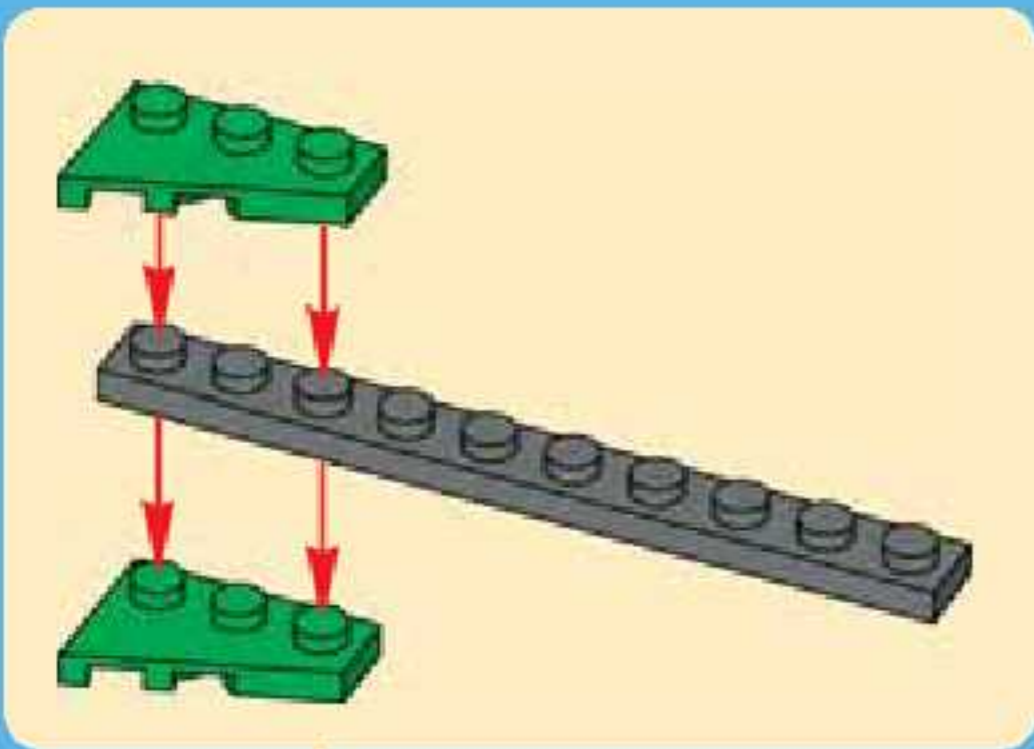
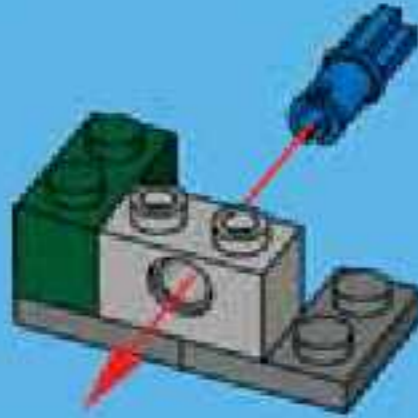

3

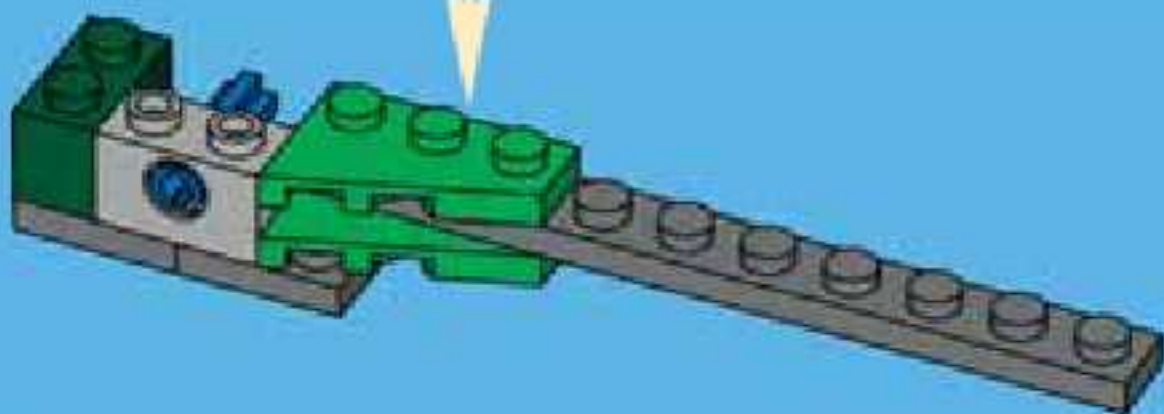

4

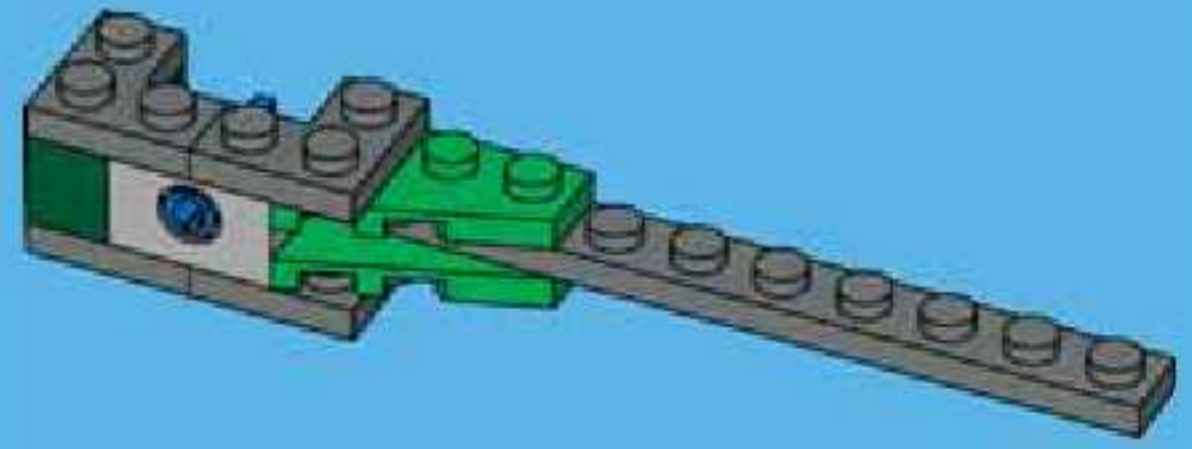

1

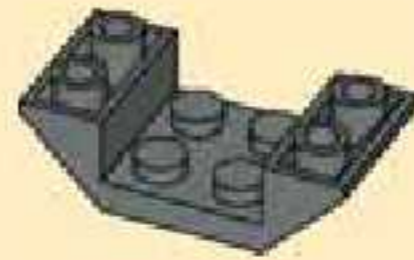

2

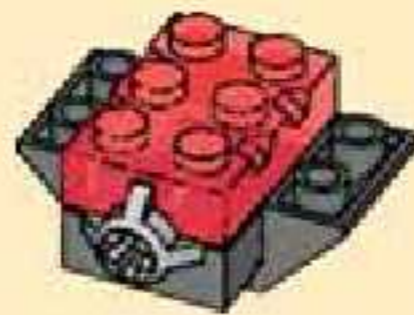

3

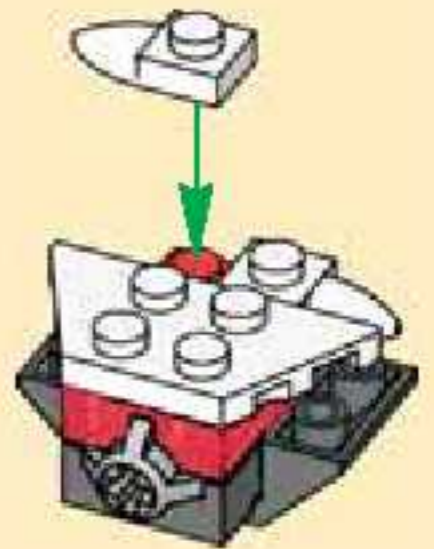

4

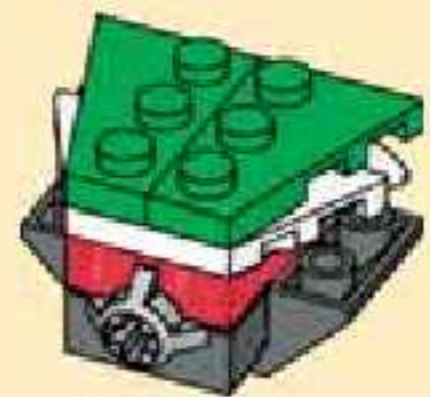

5

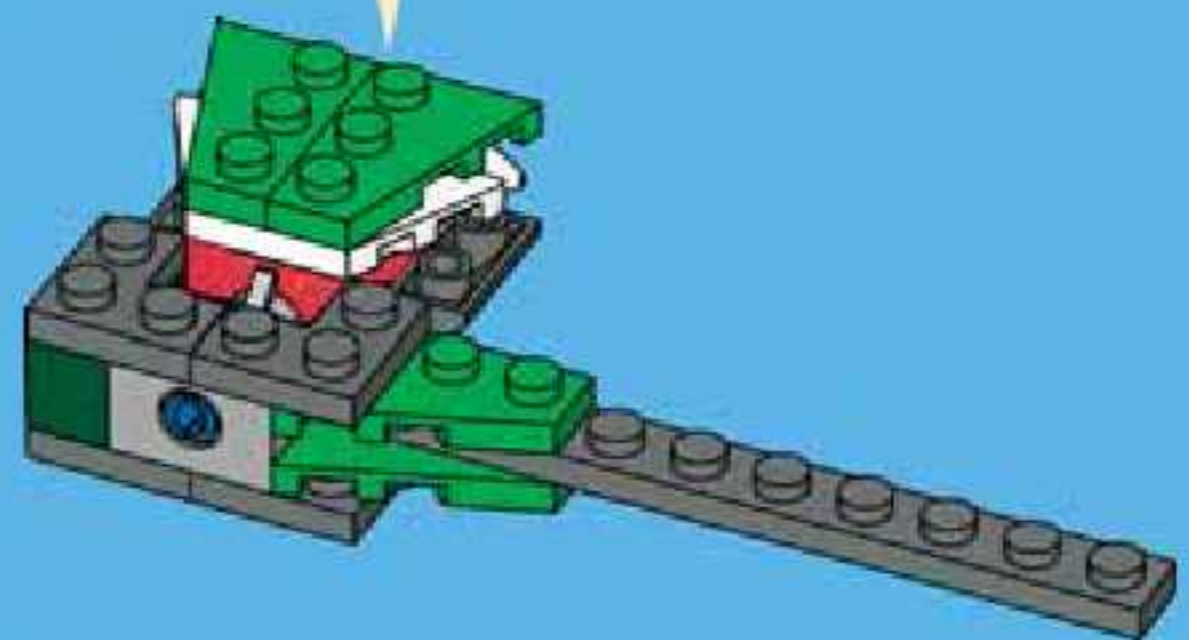

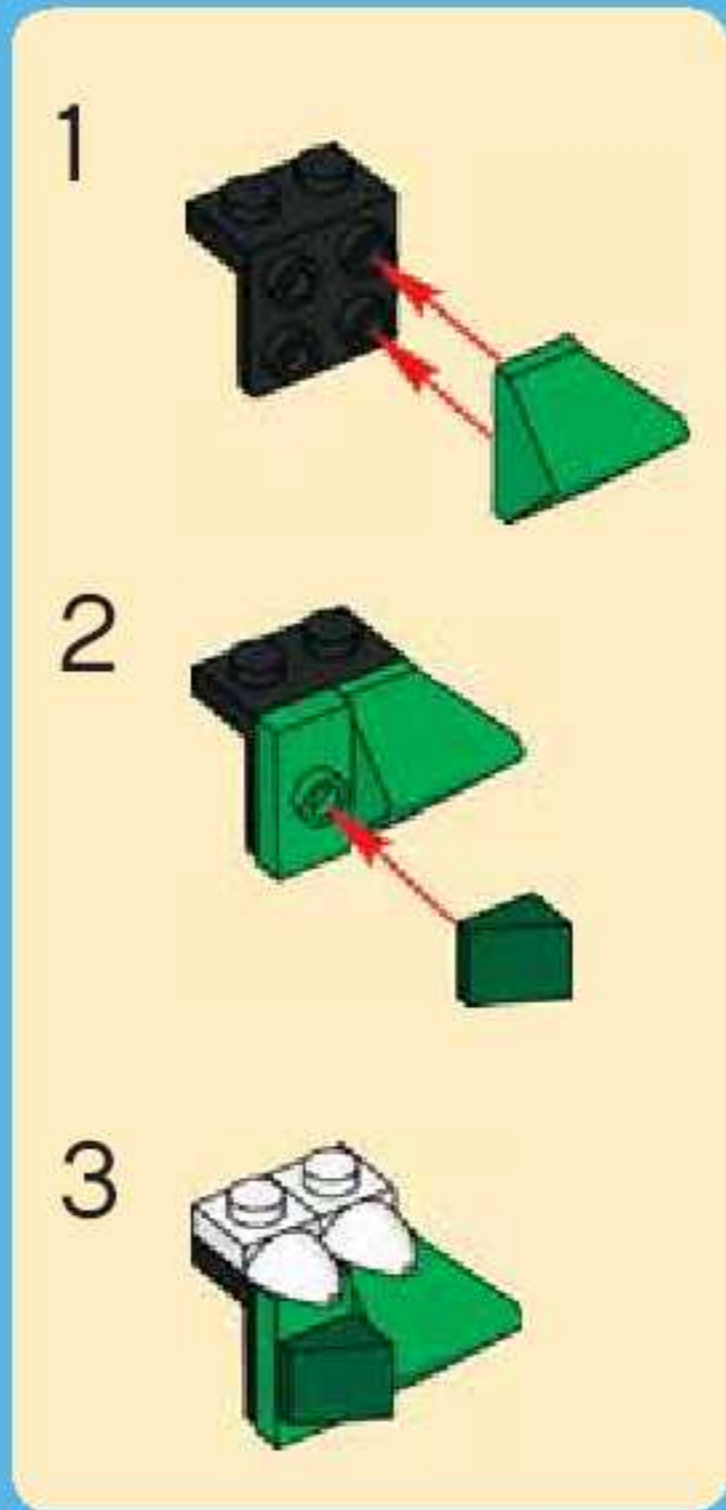

6



9

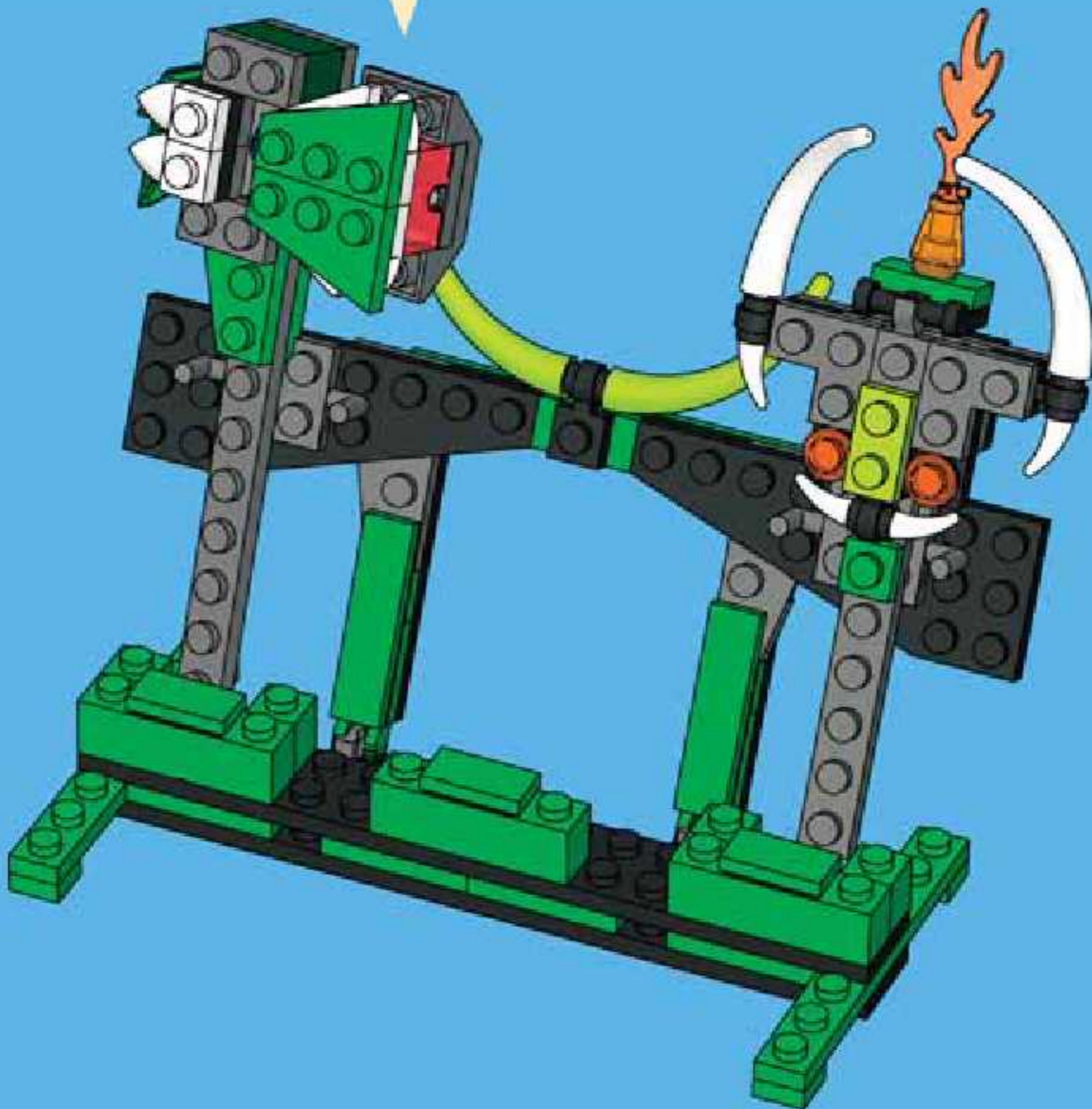

18





1

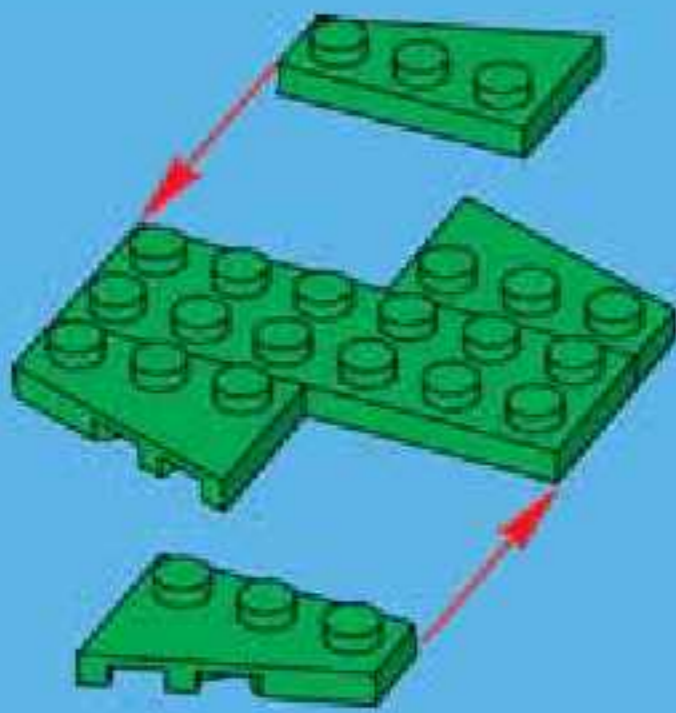

2



3



4

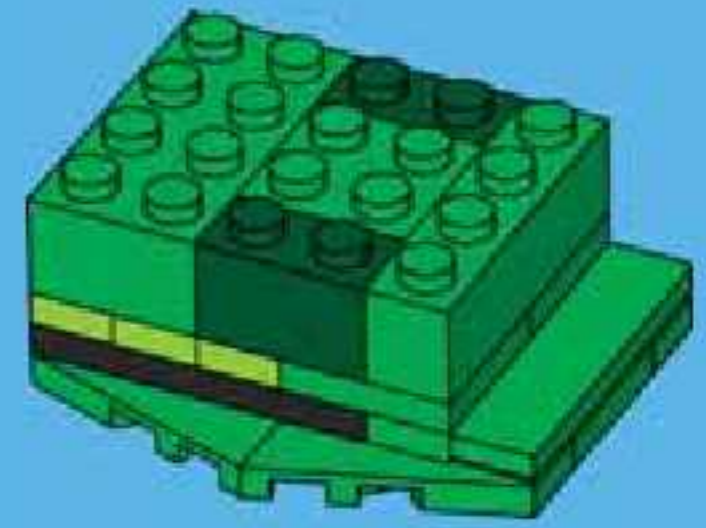

5

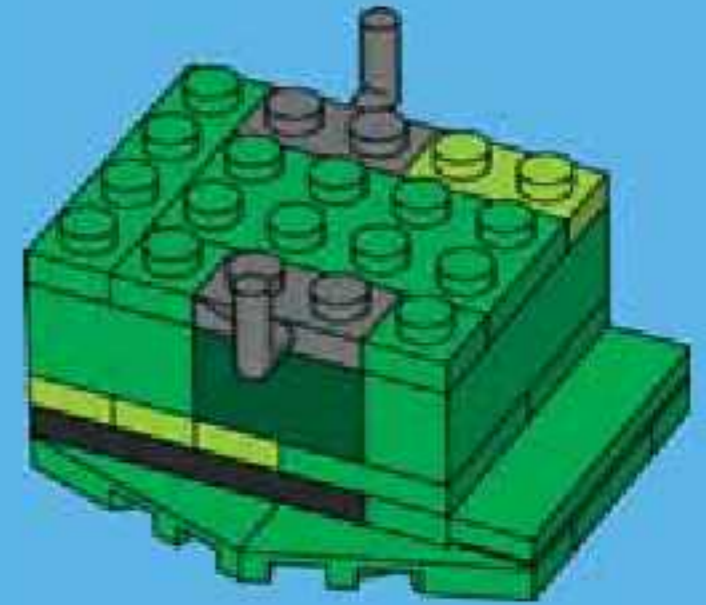

6

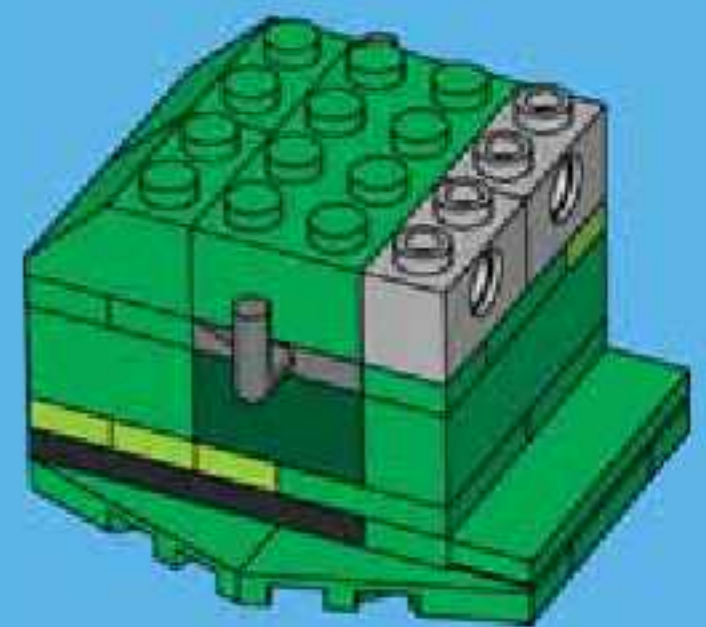

7

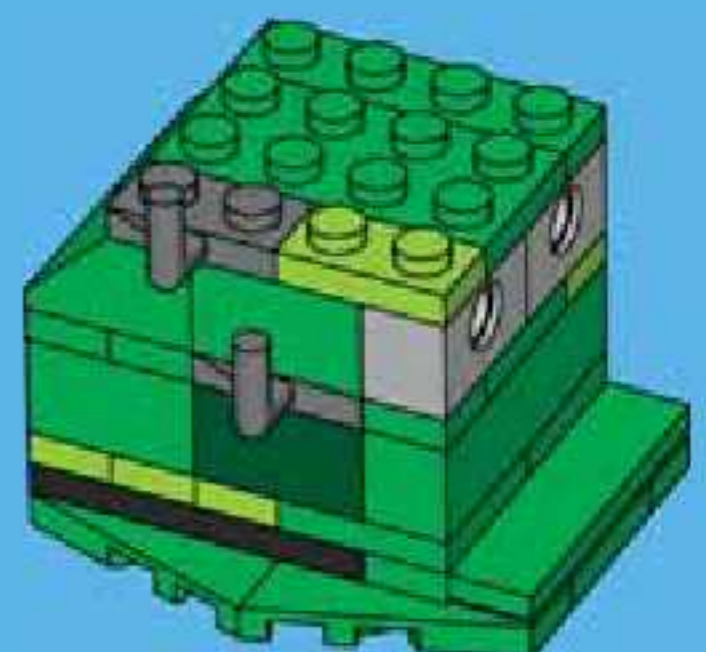

8

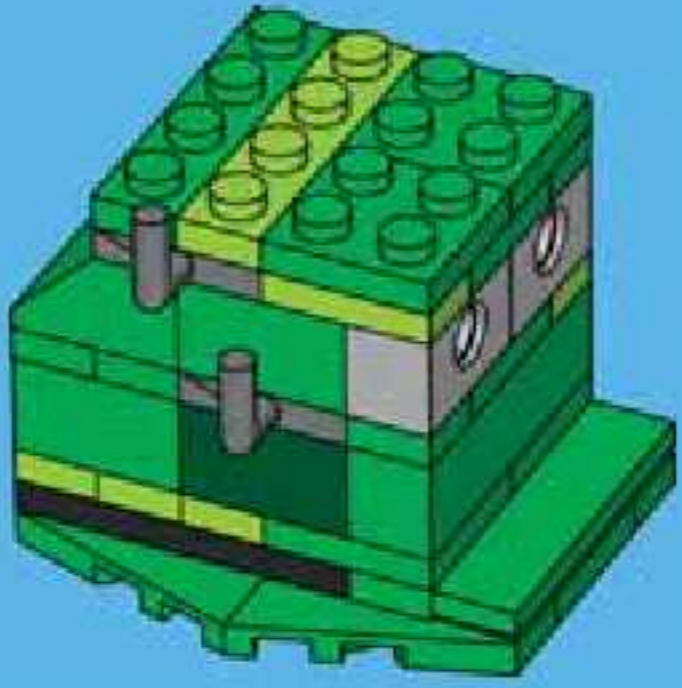

9

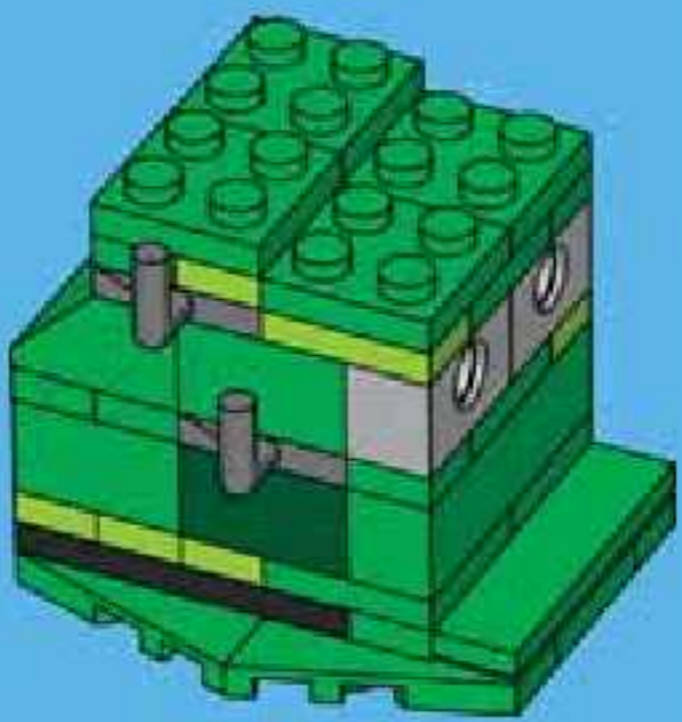

10

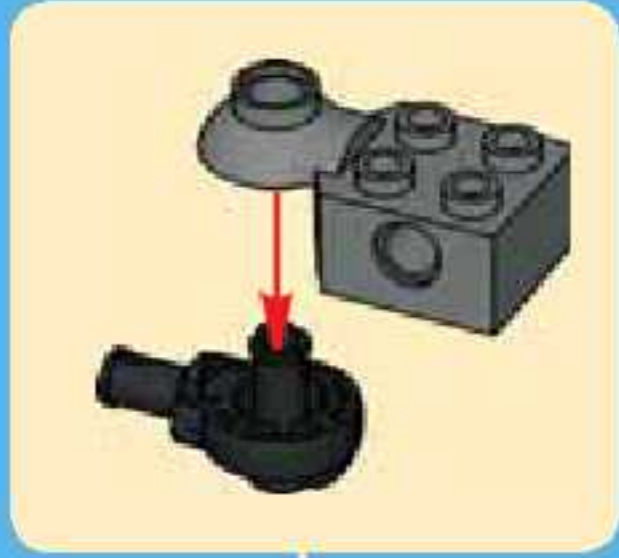
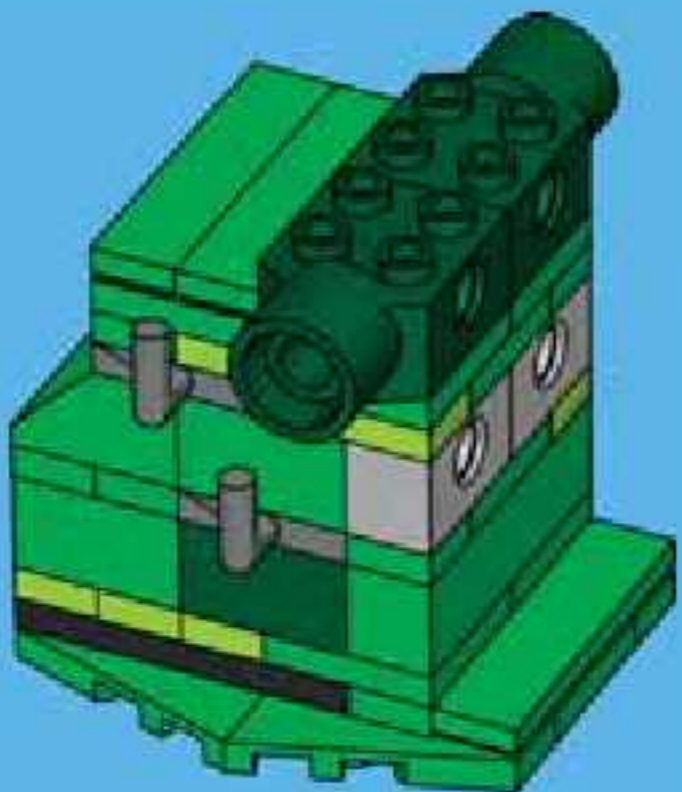

11

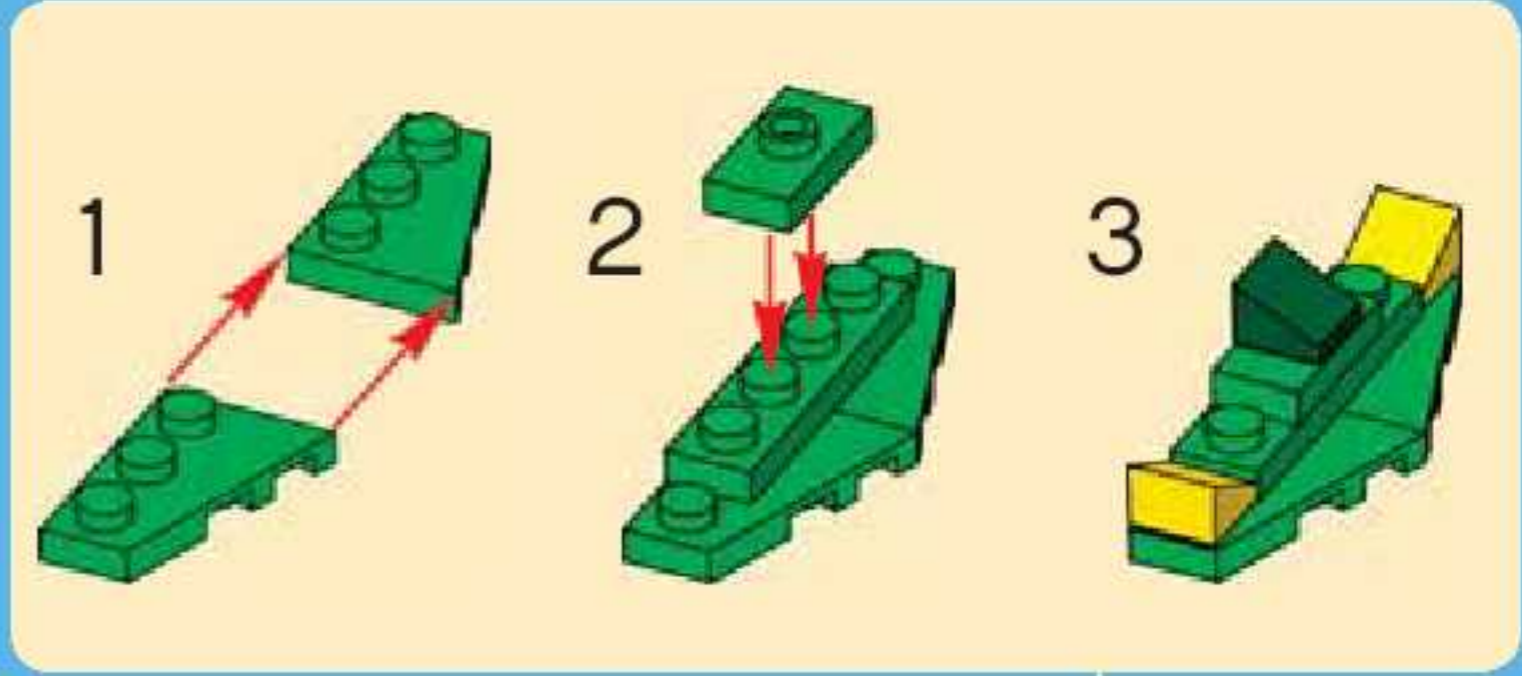
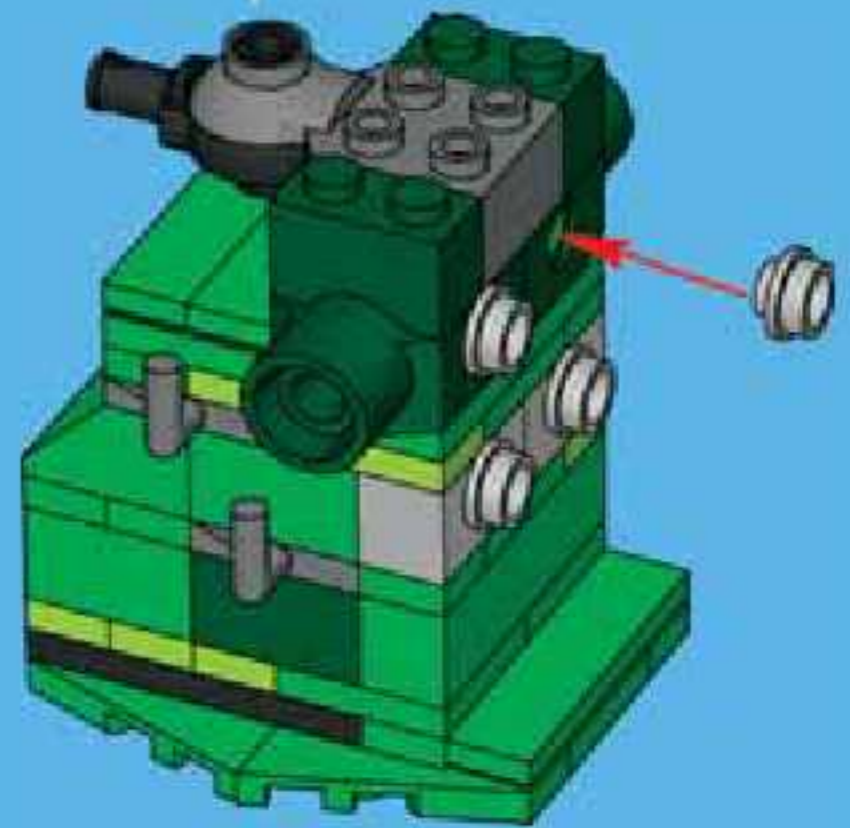

12

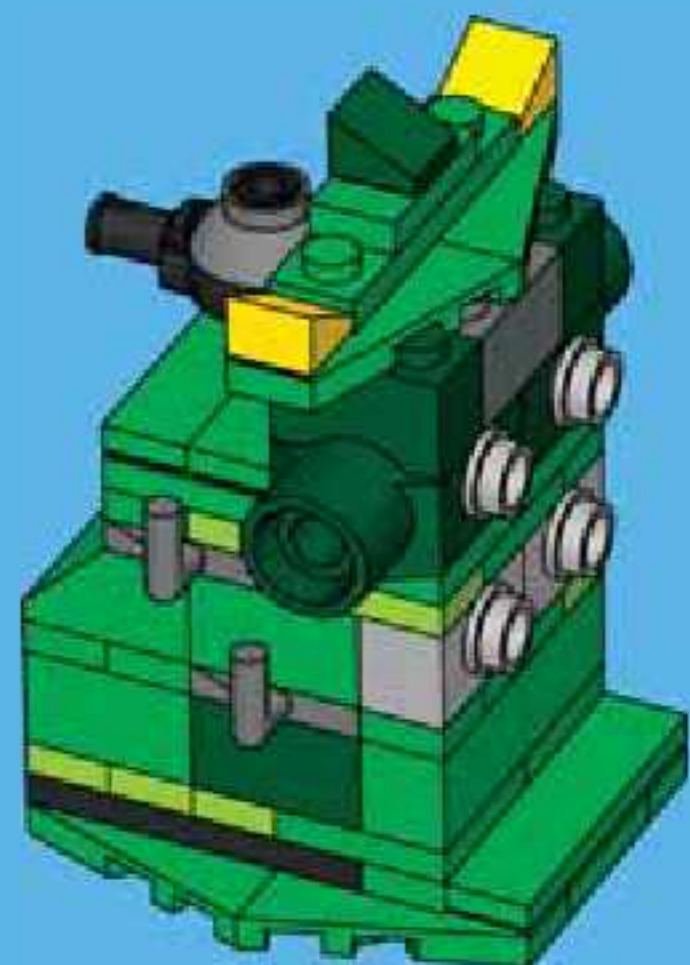

1



2

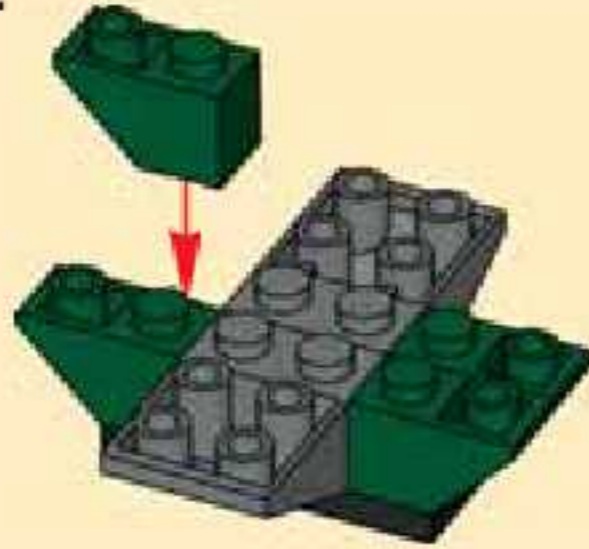

3

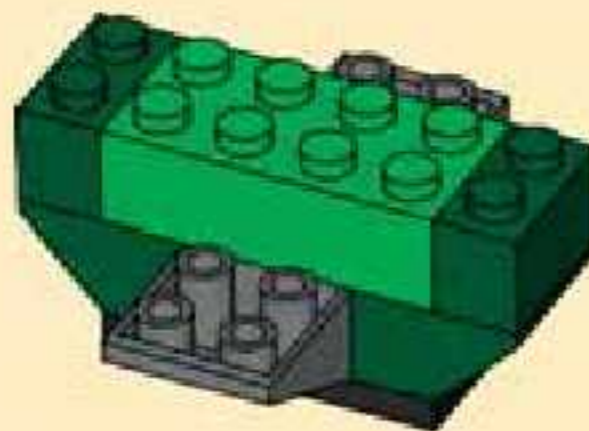

4



5



6



13

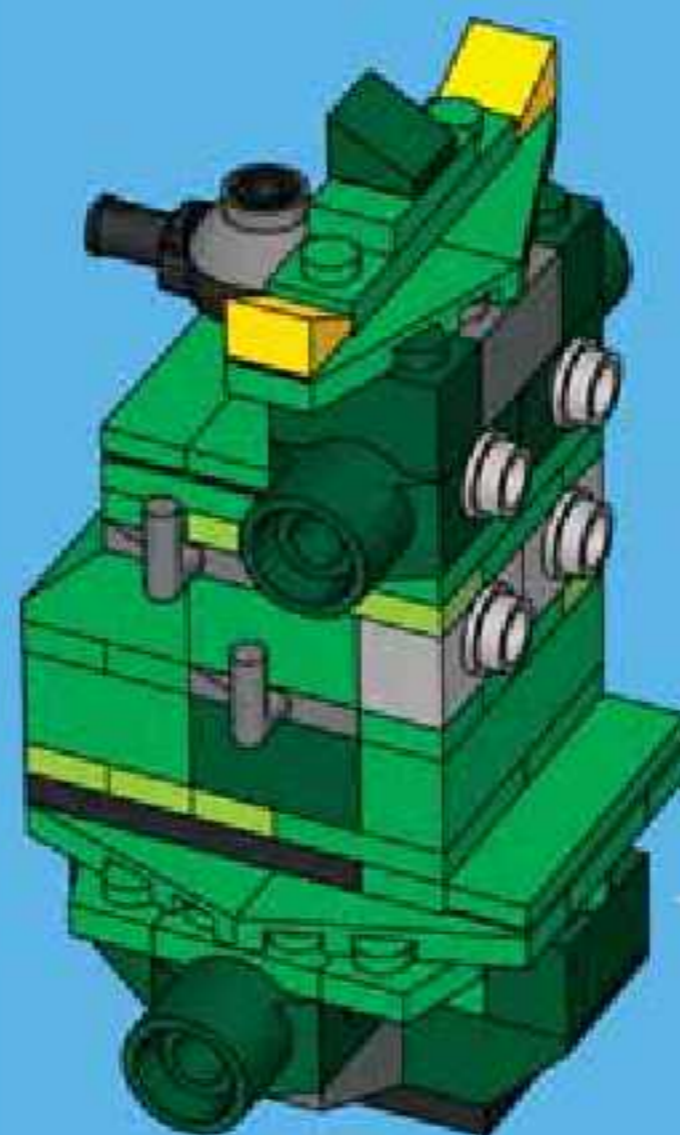

14

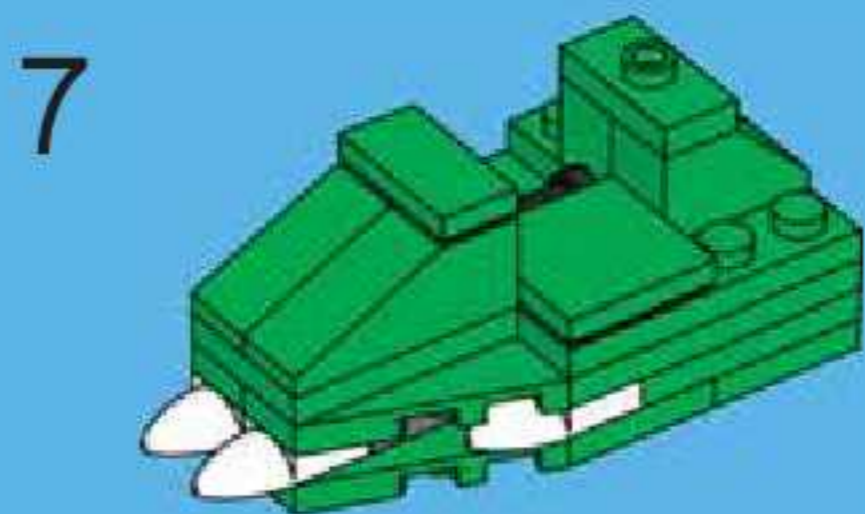
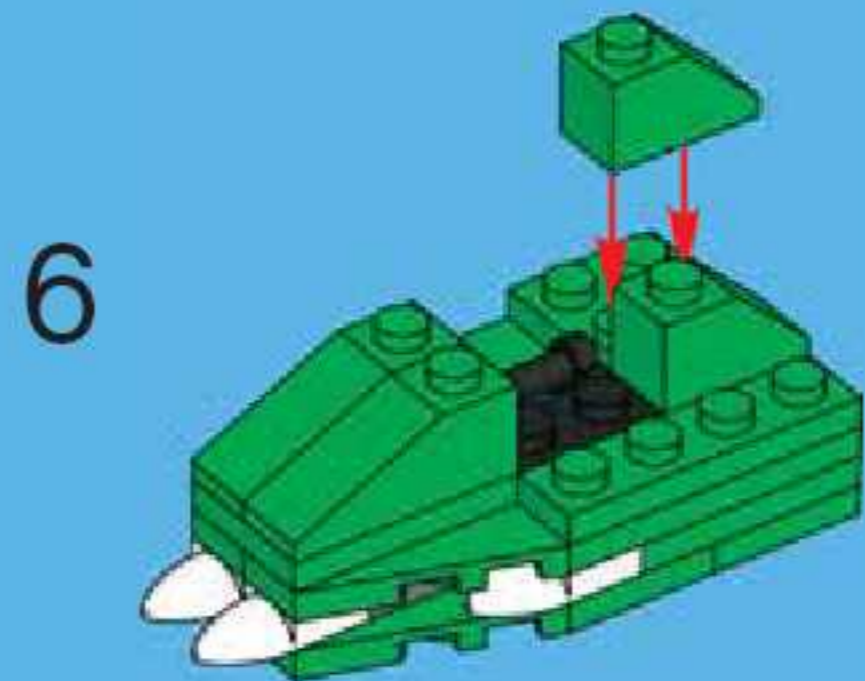
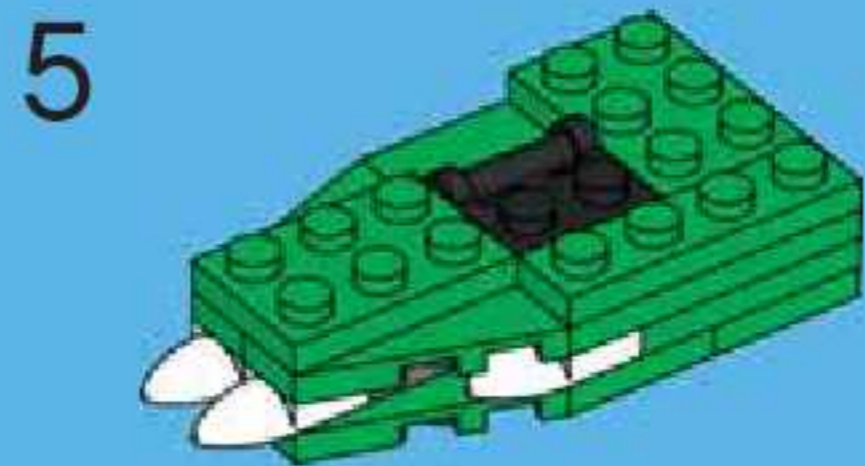
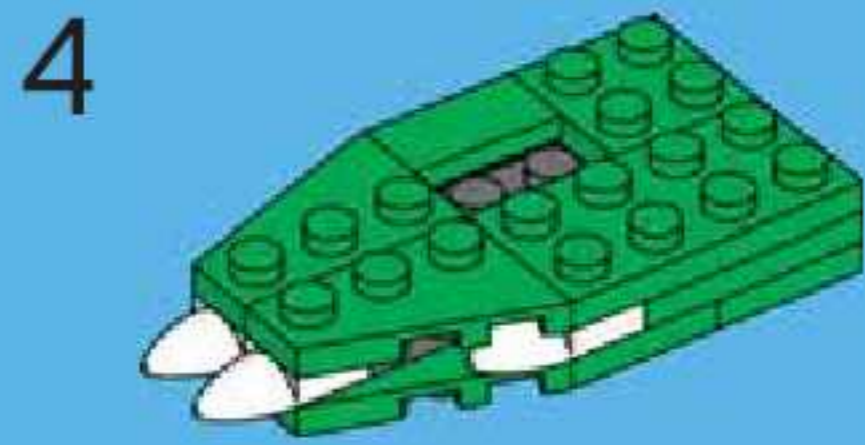
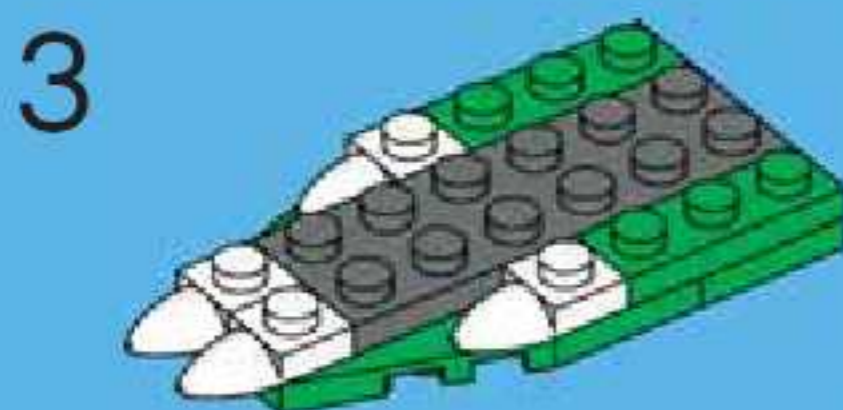
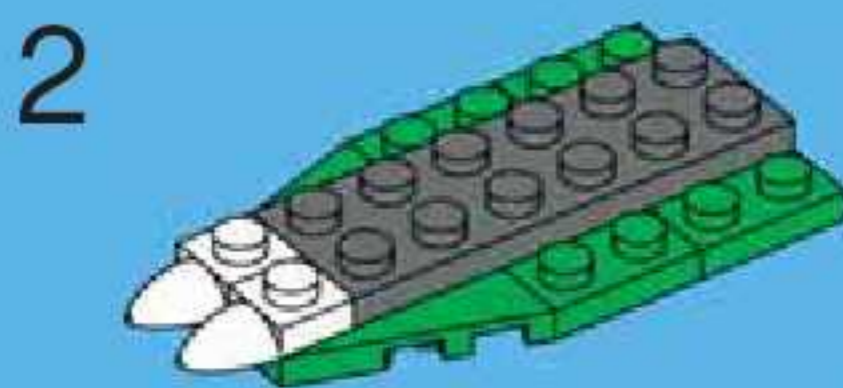
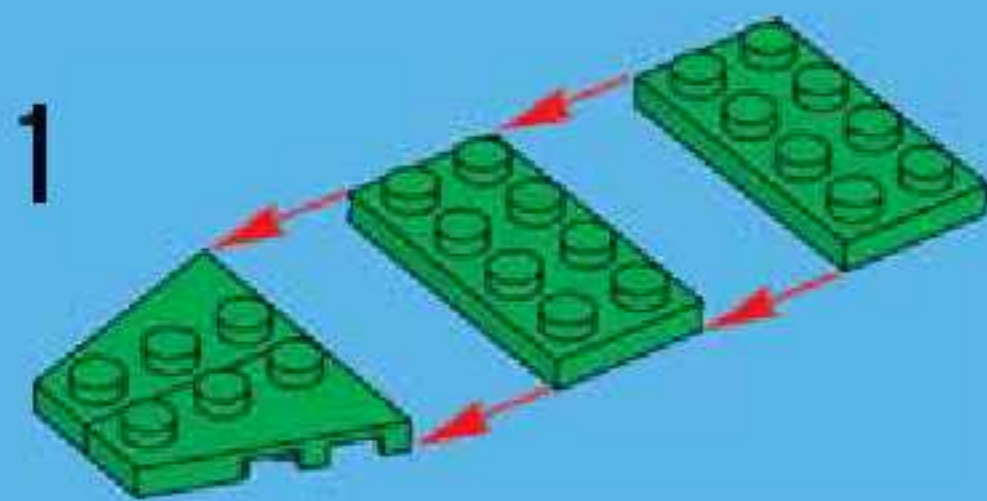
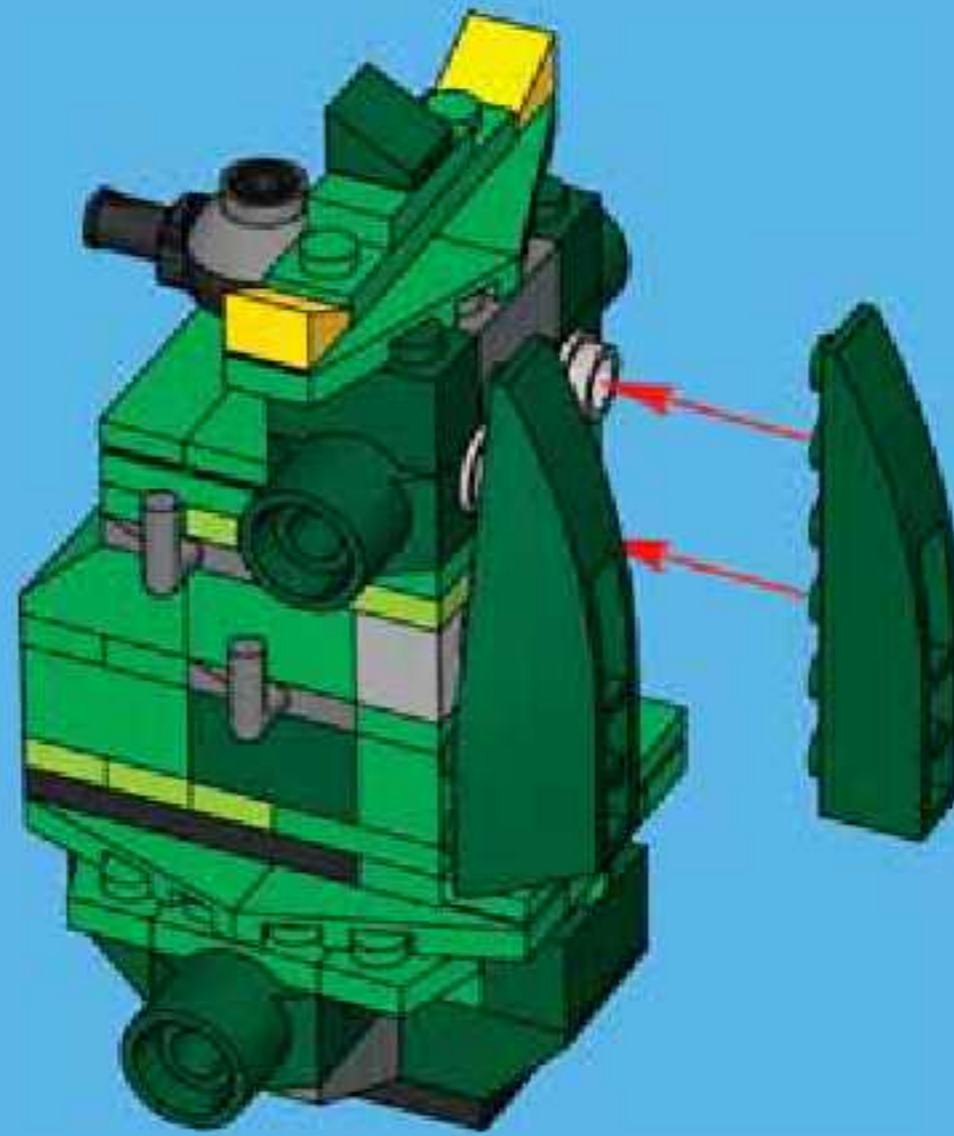

1



2

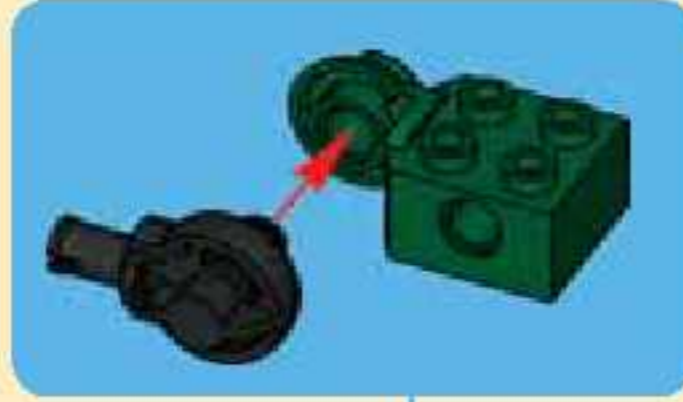

3

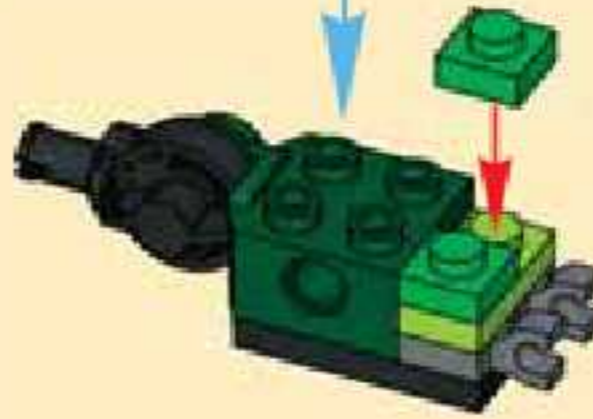

4

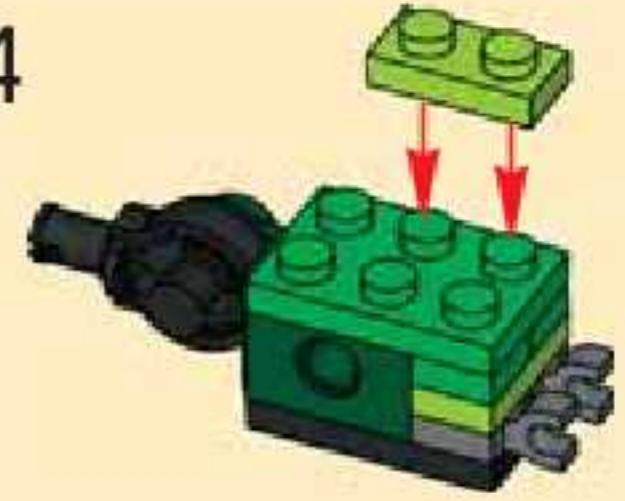

5



8

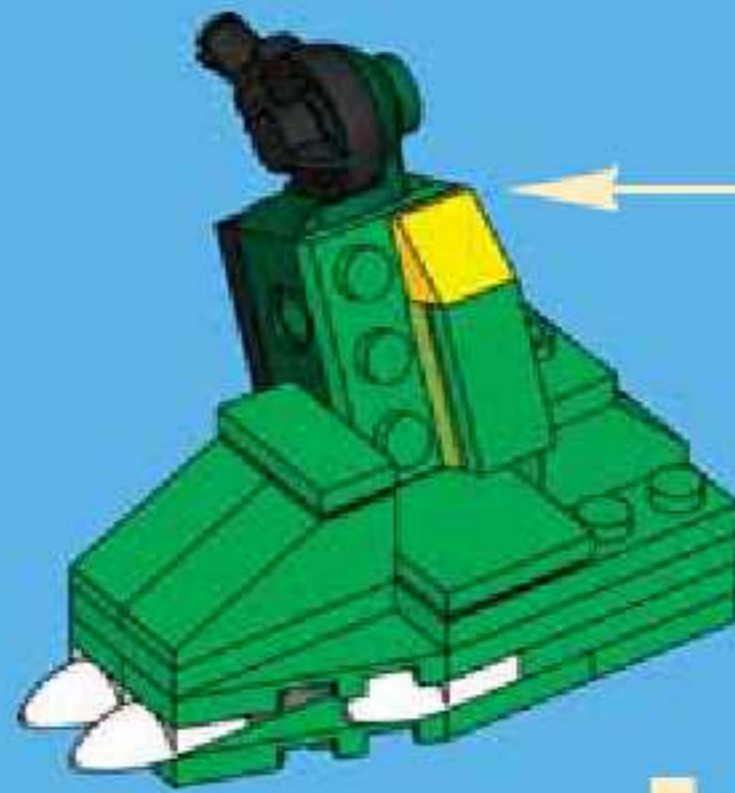

15

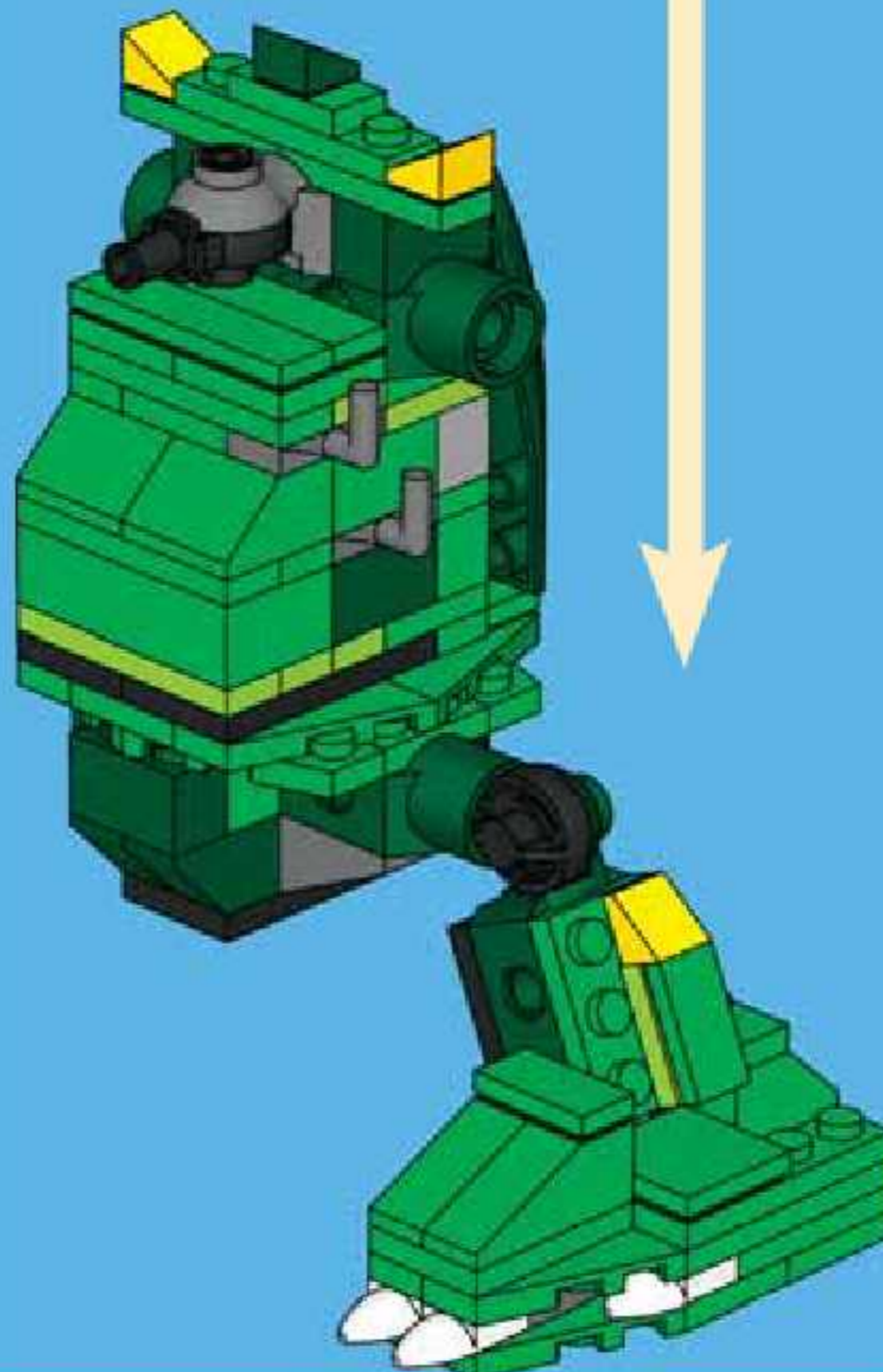



1

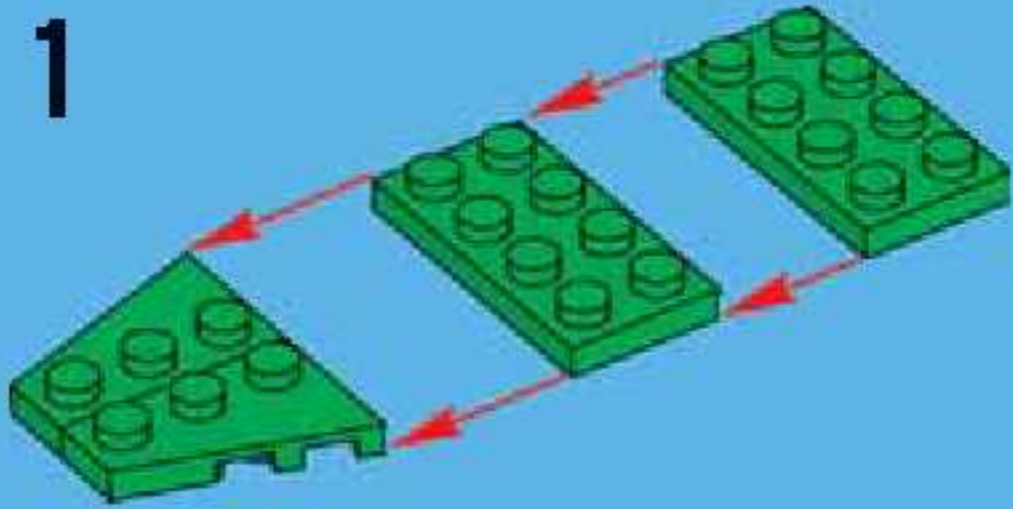

2

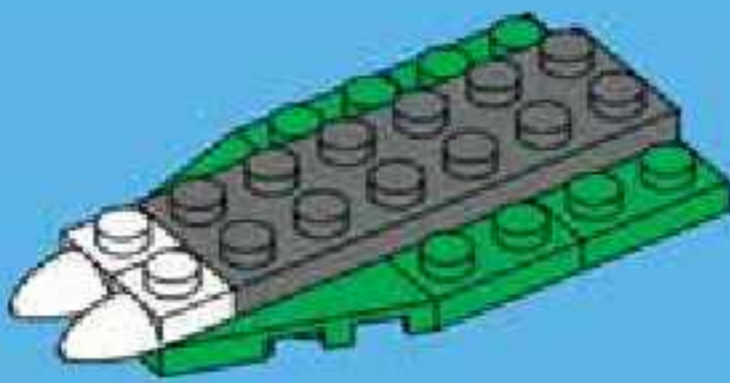

3

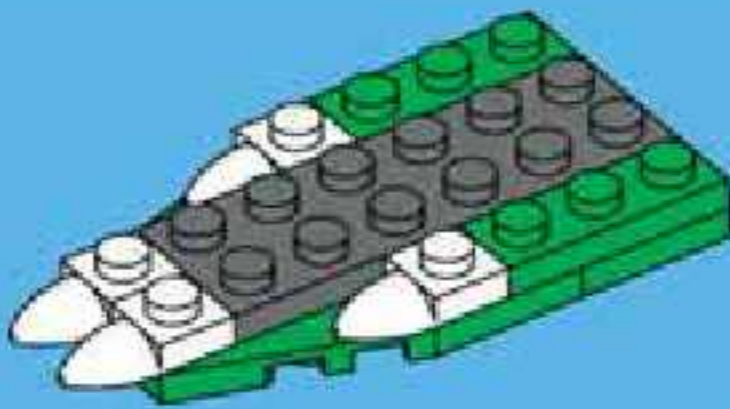

4

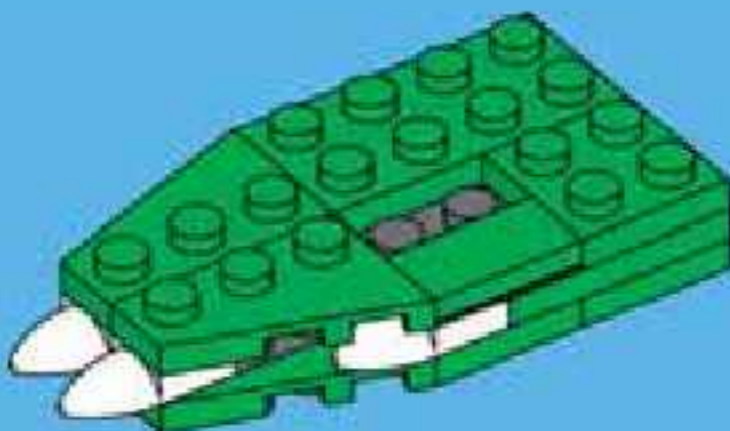

5

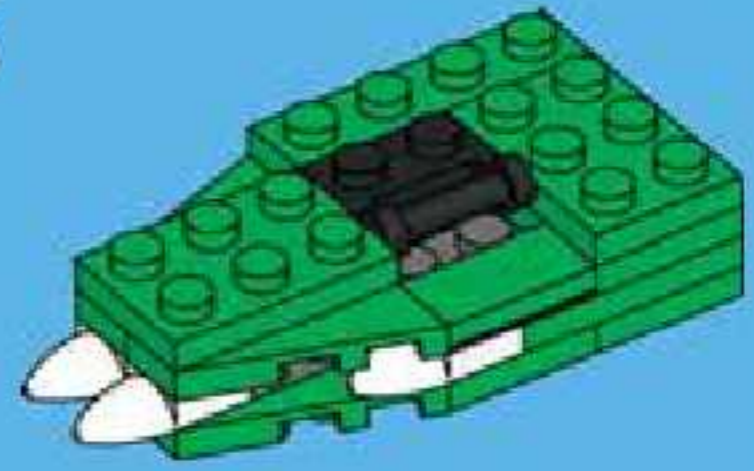

6

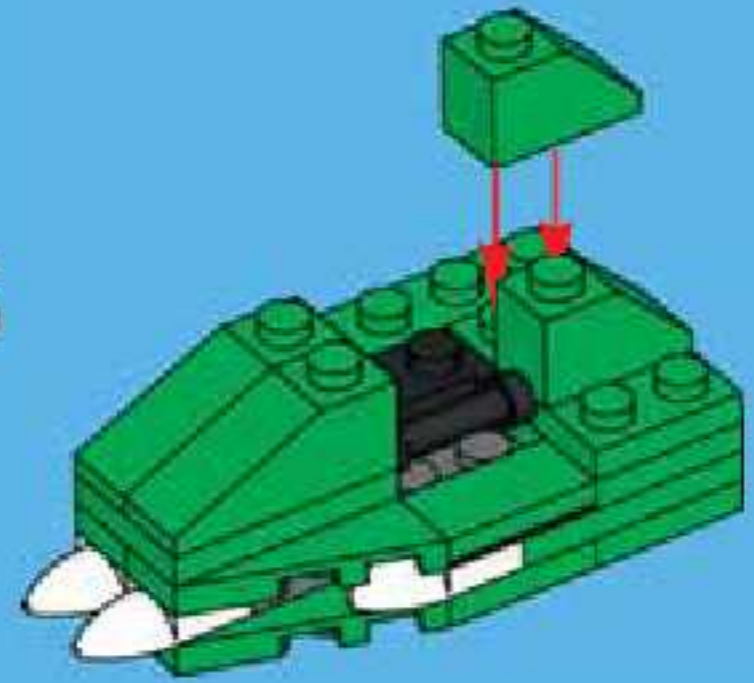

7

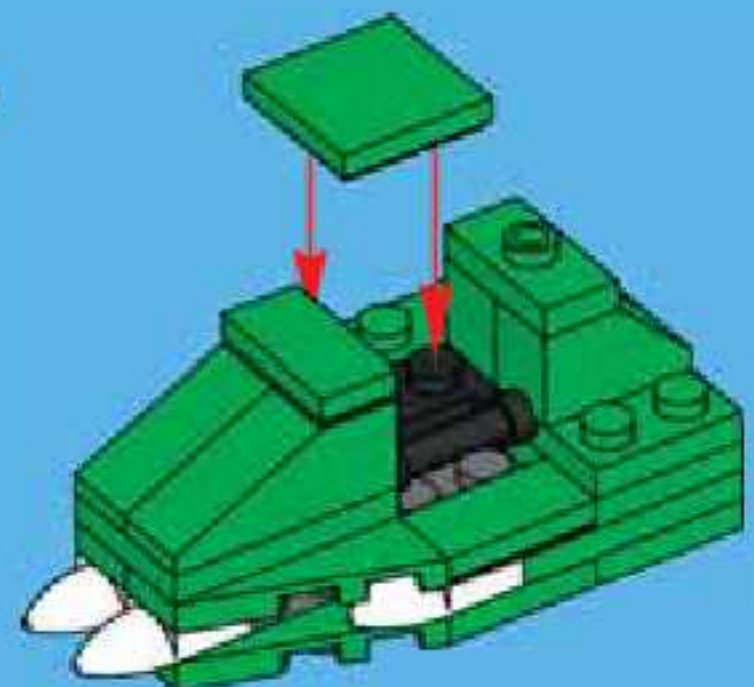

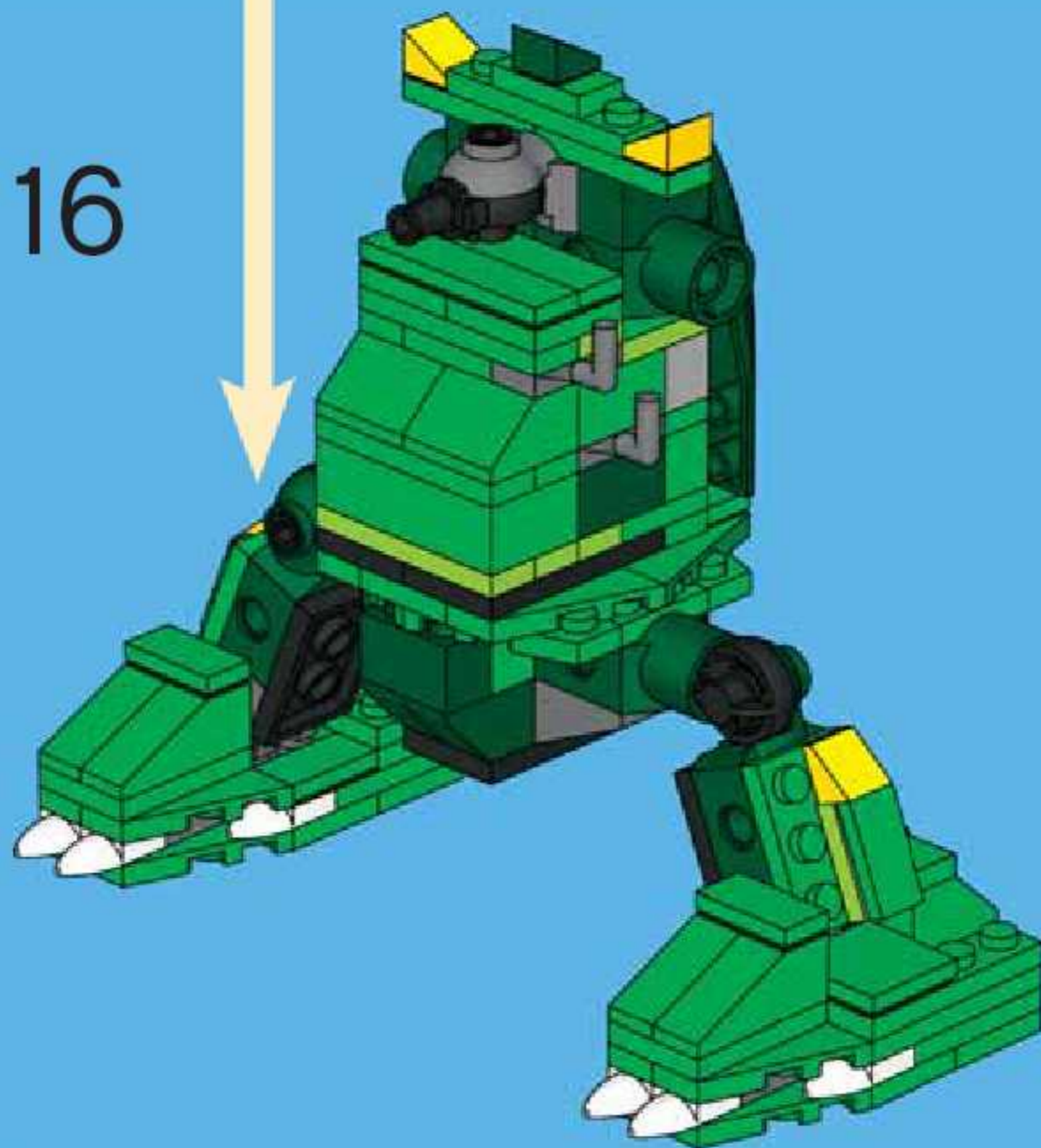
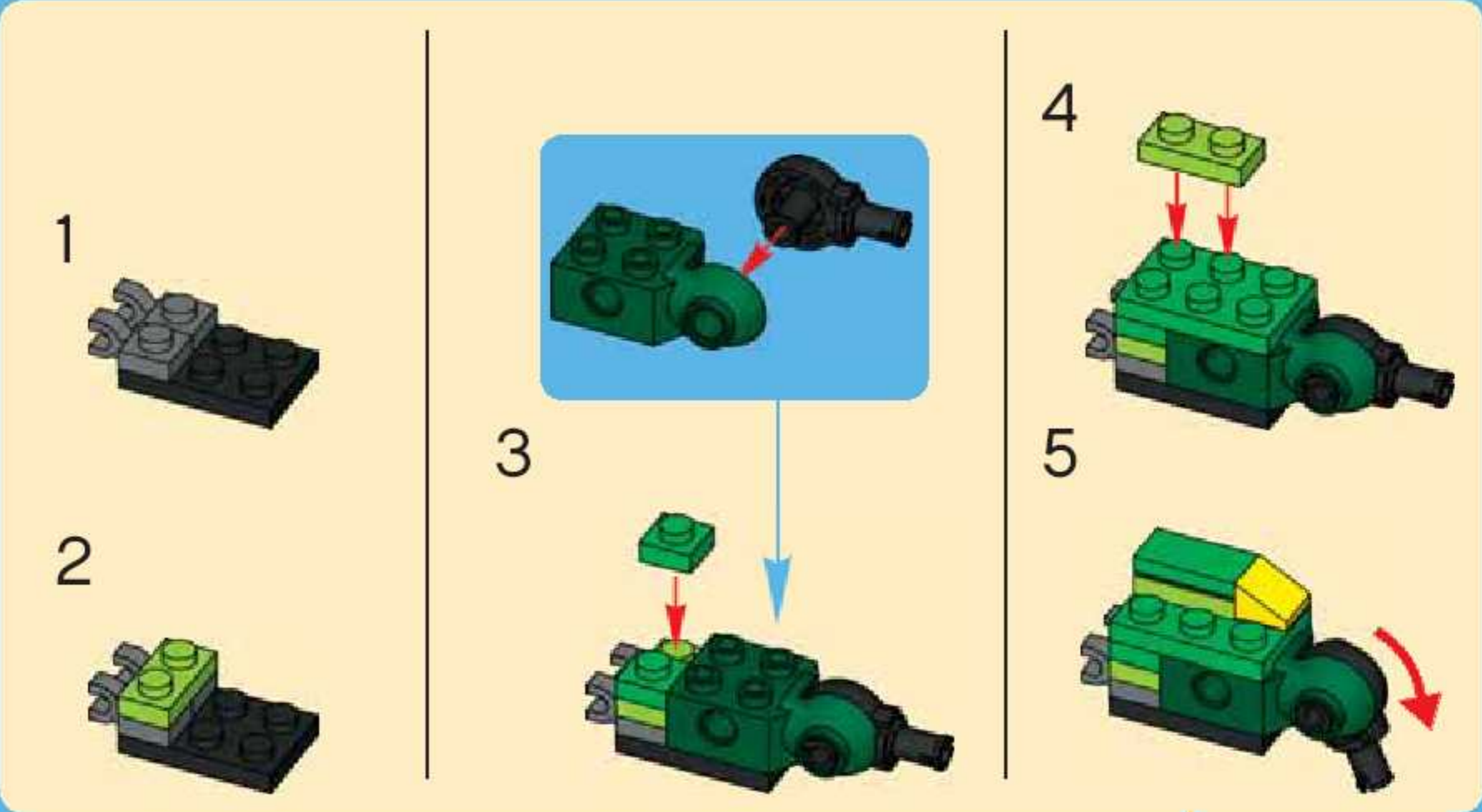

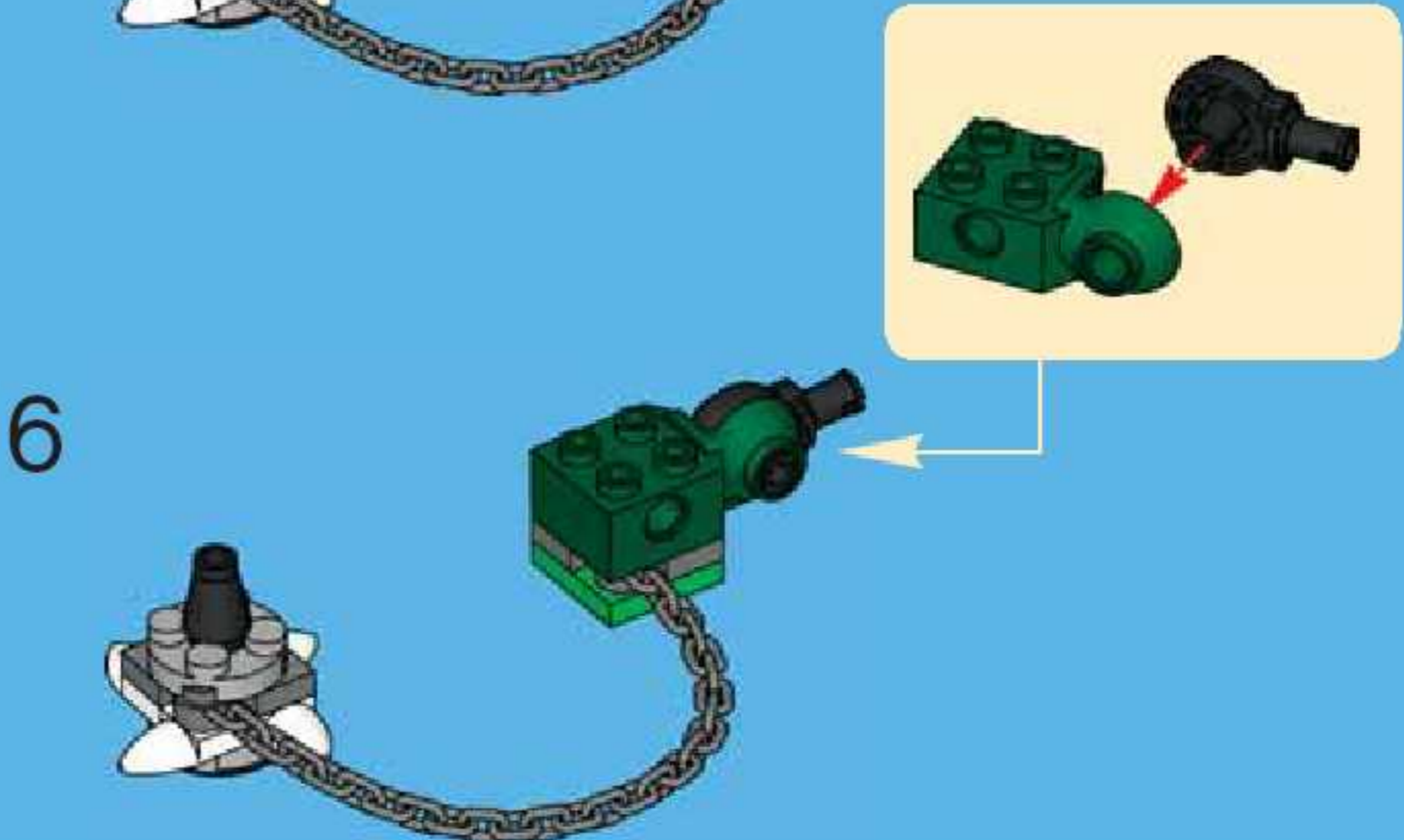
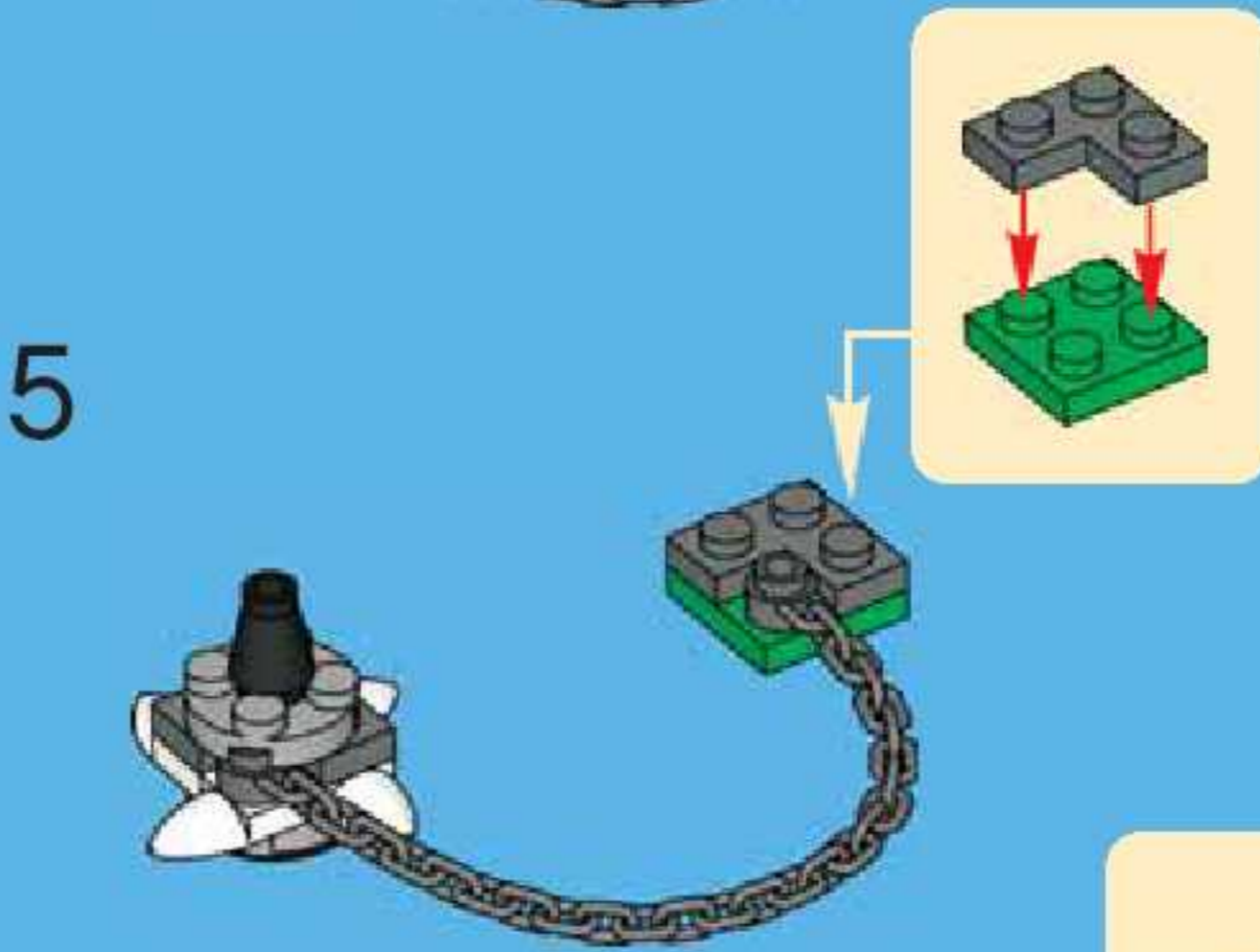
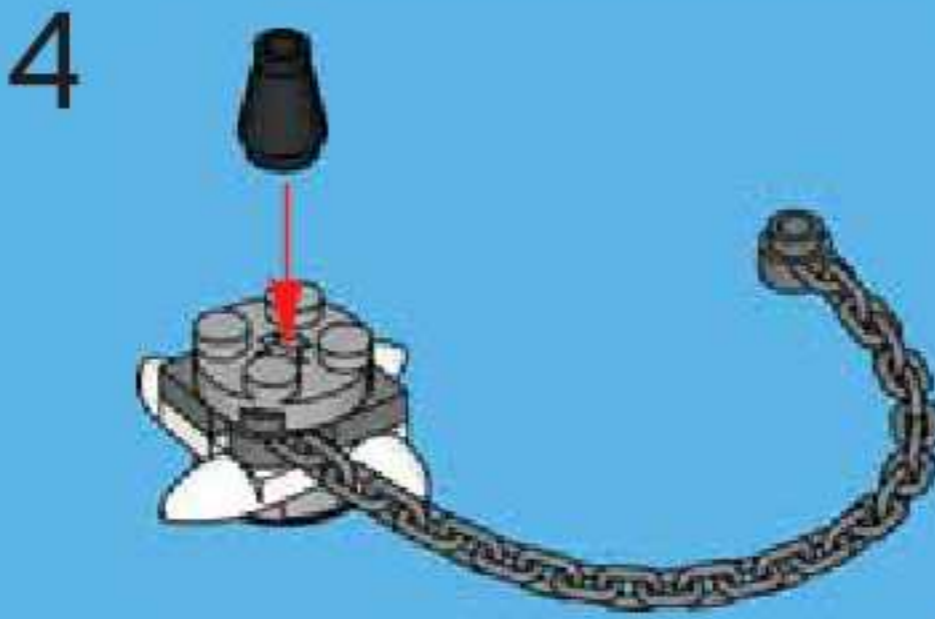
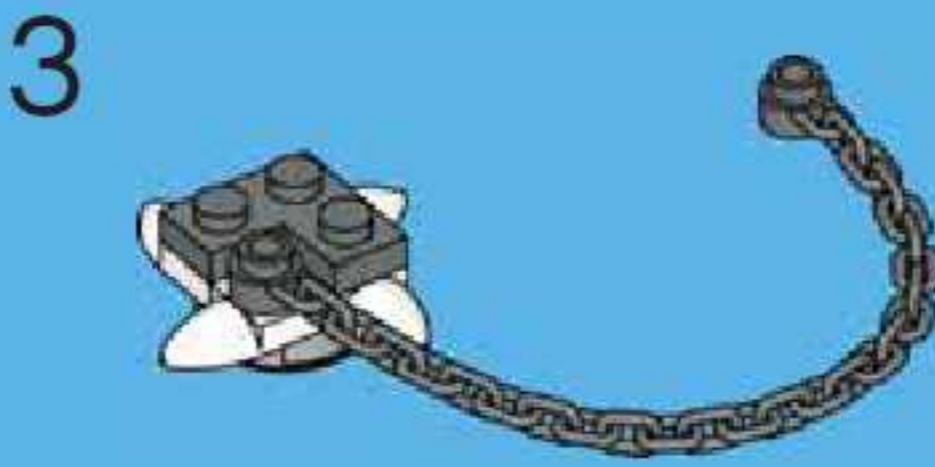
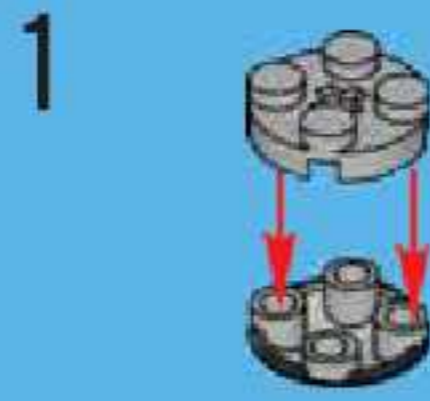

7

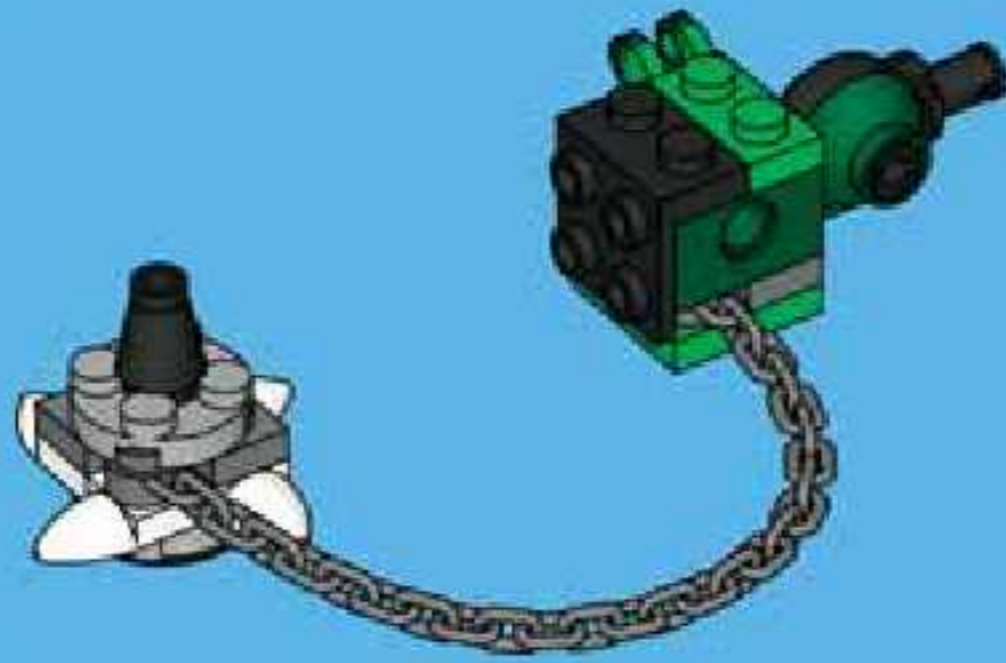

8

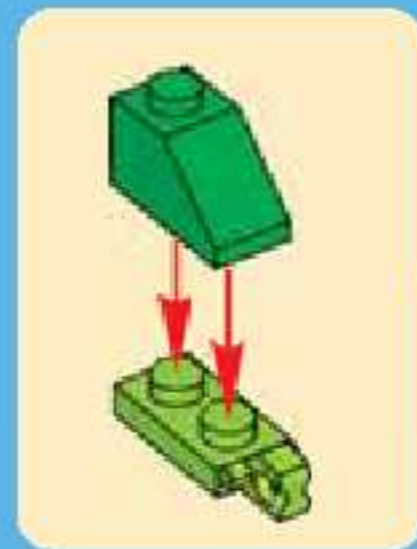
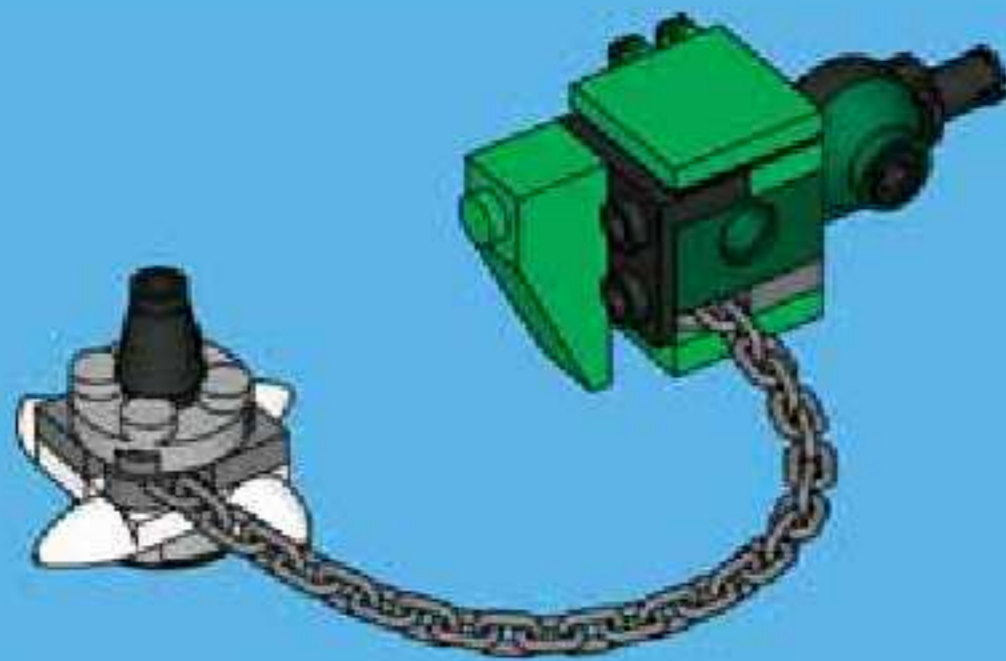

9

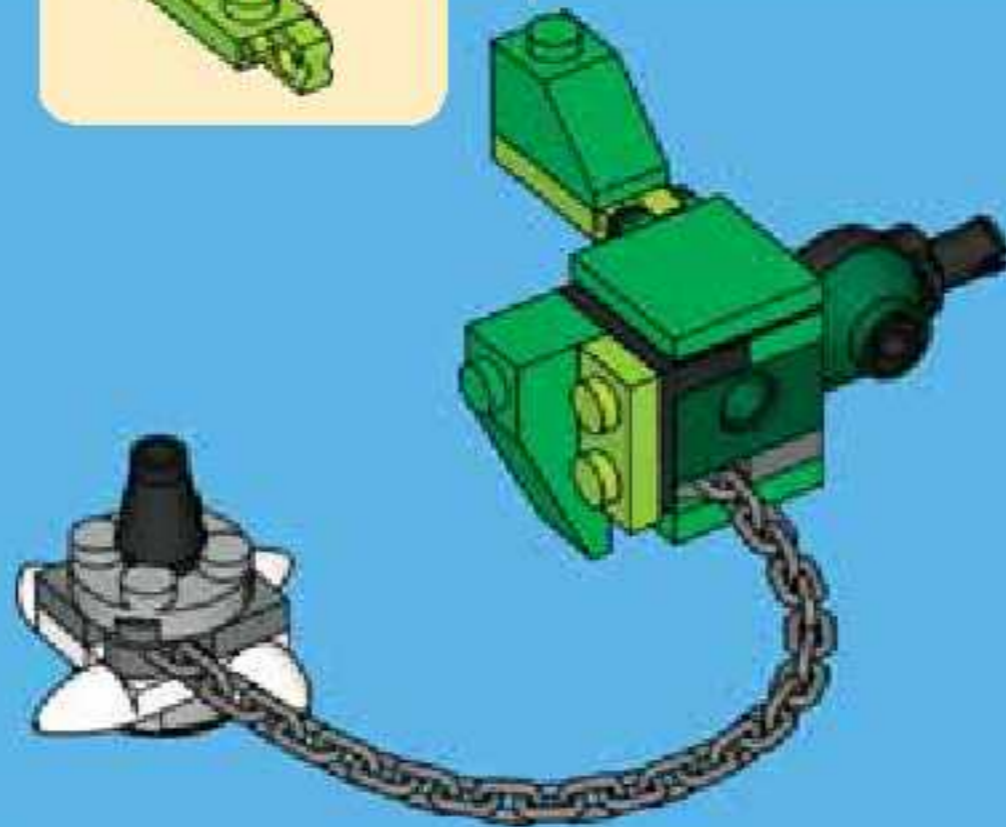

10

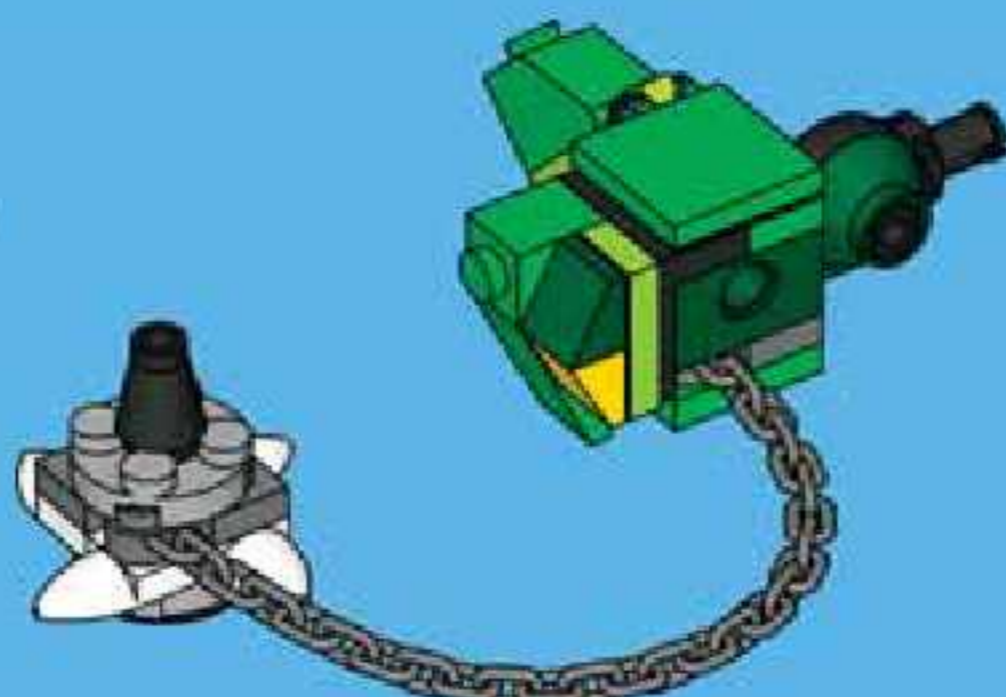

1



2

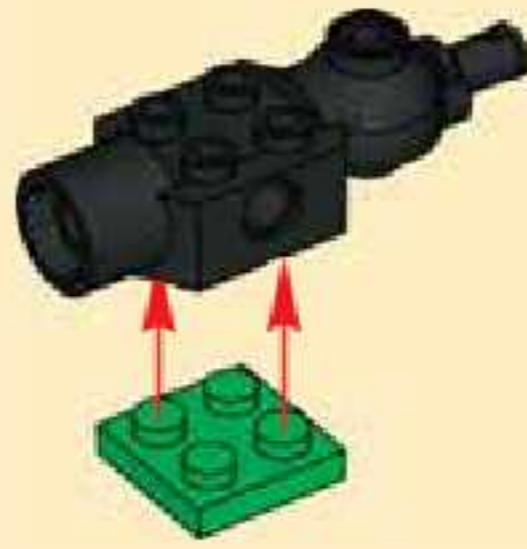

3



4

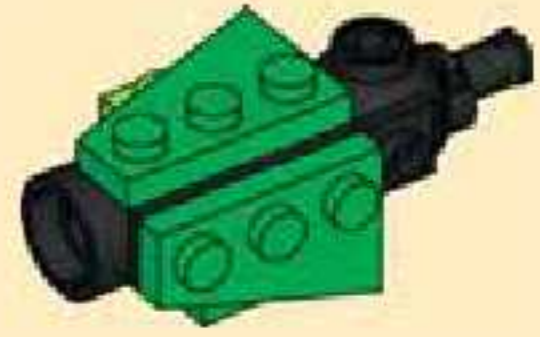

5

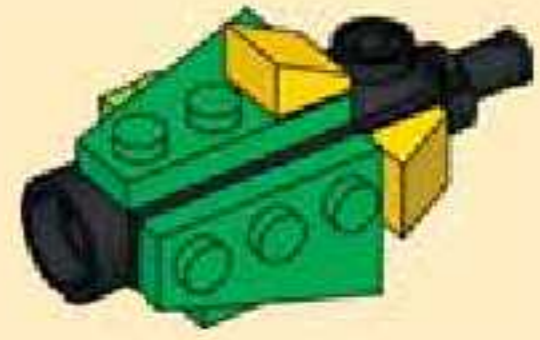

11

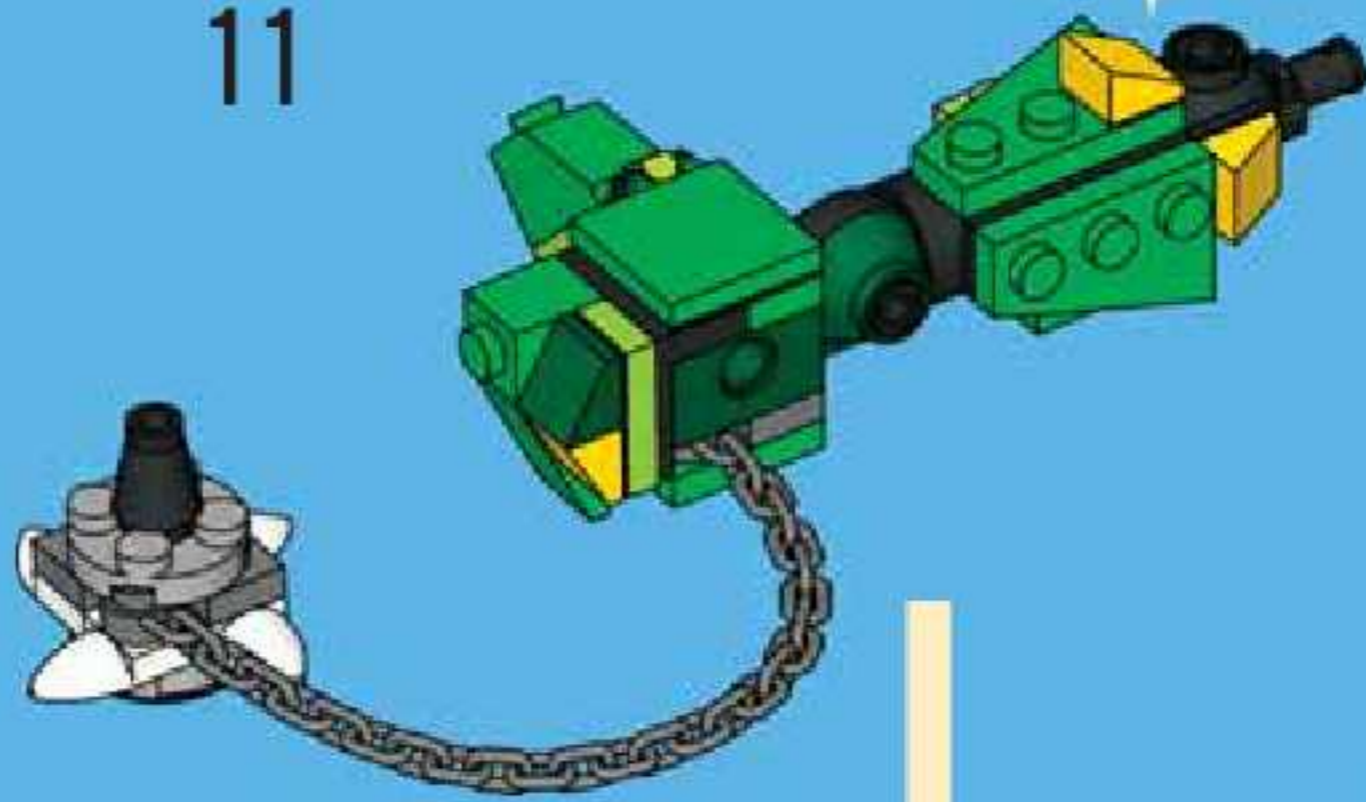

17

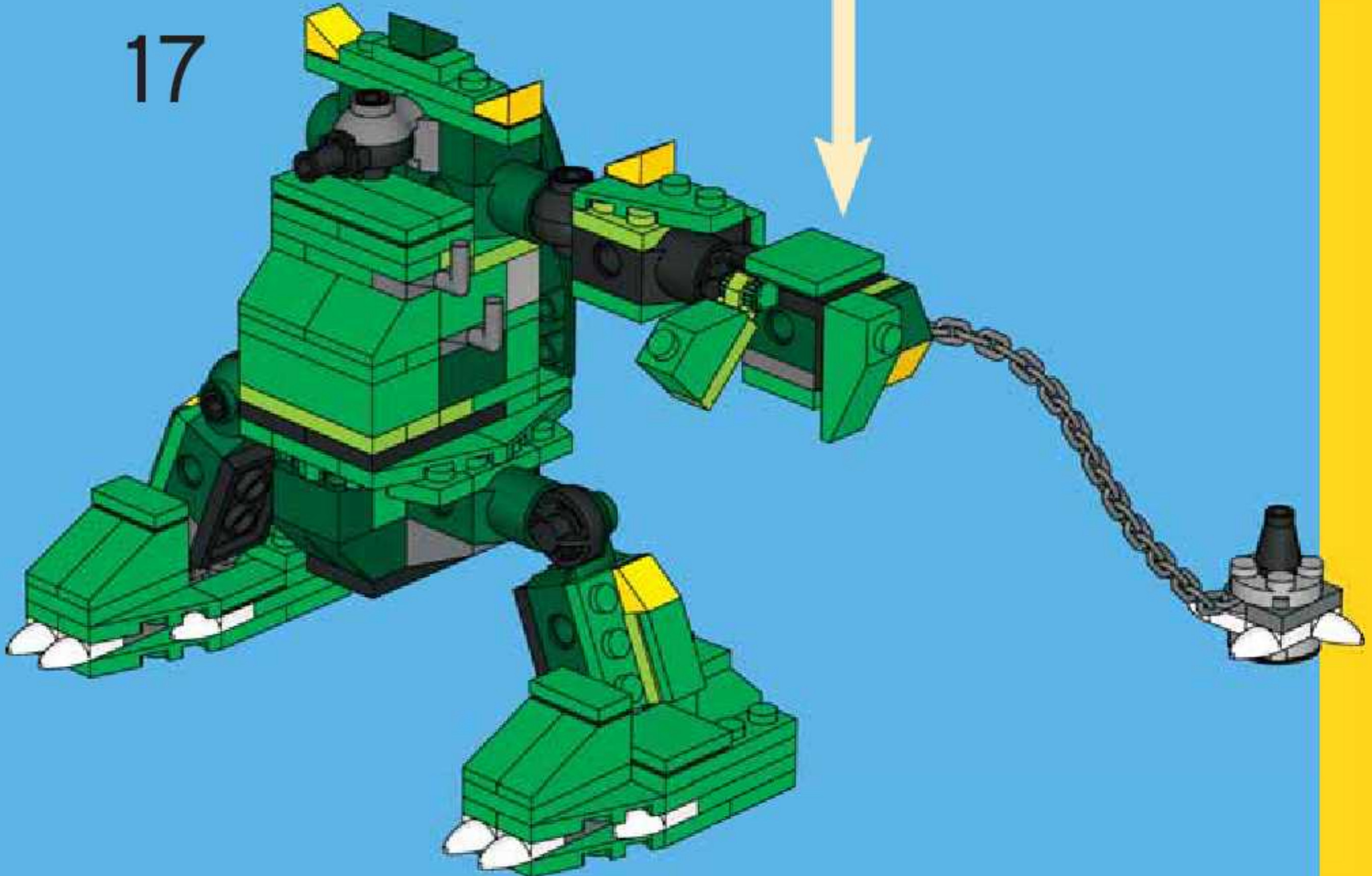



1



2

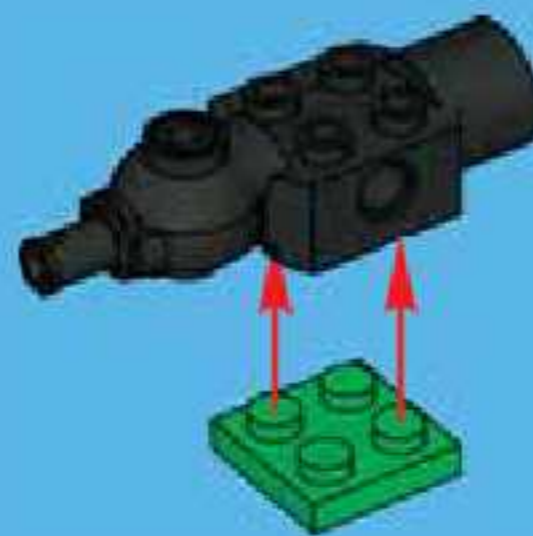

3



4

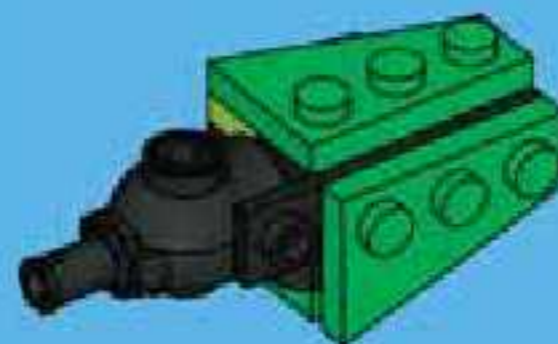

5

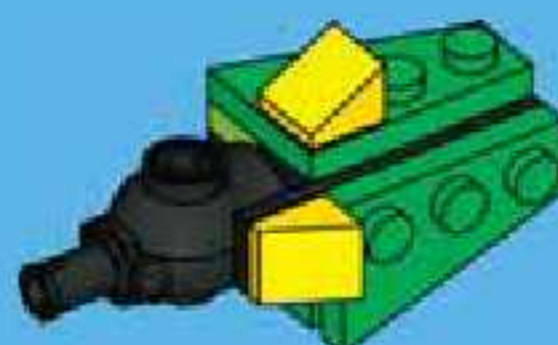

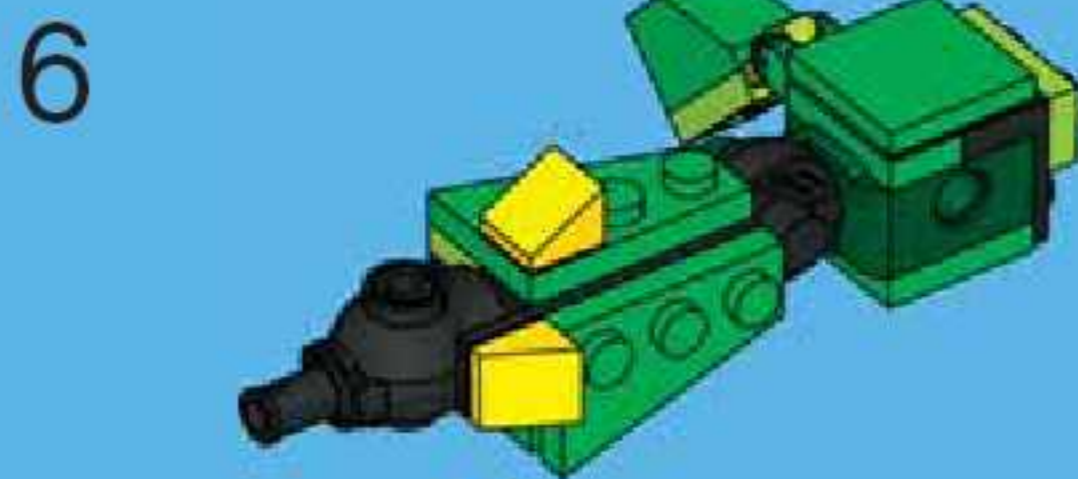
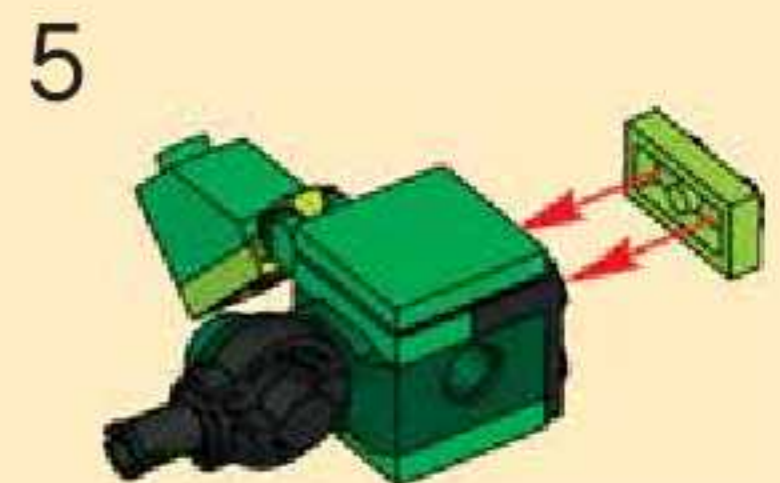
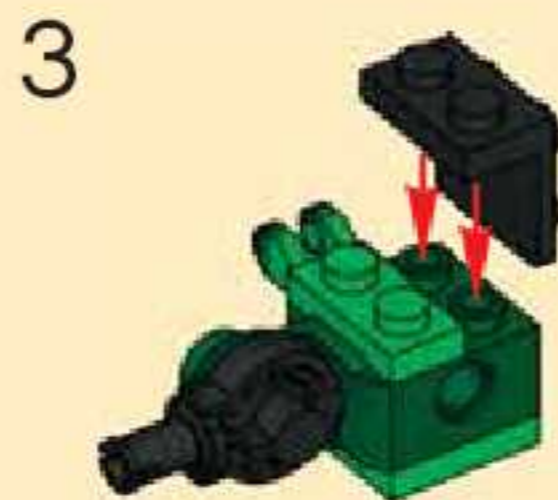
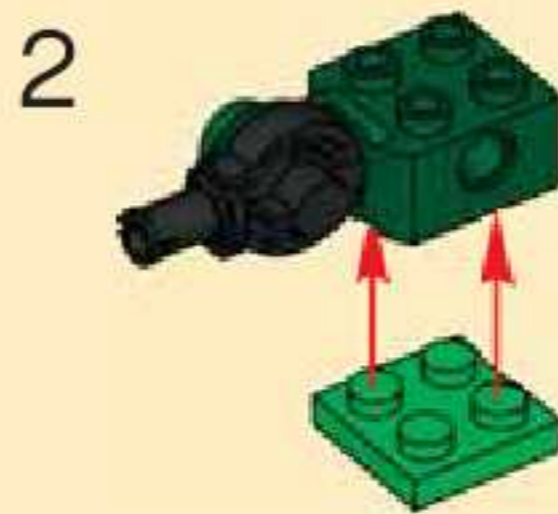
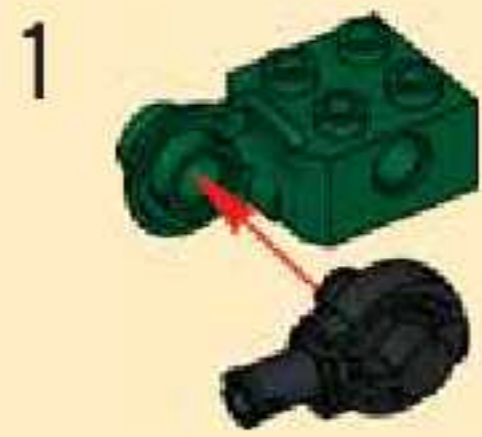

18

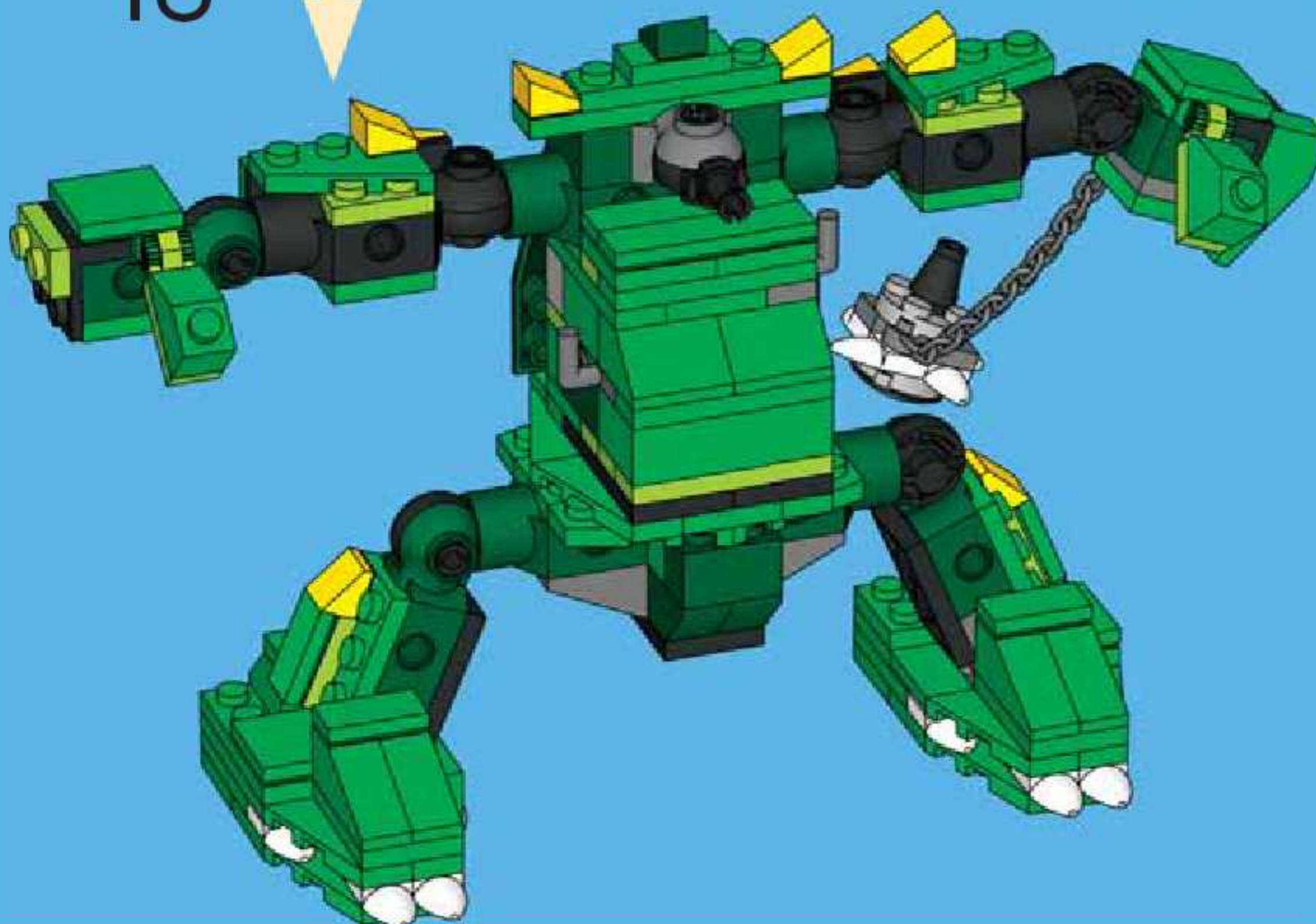

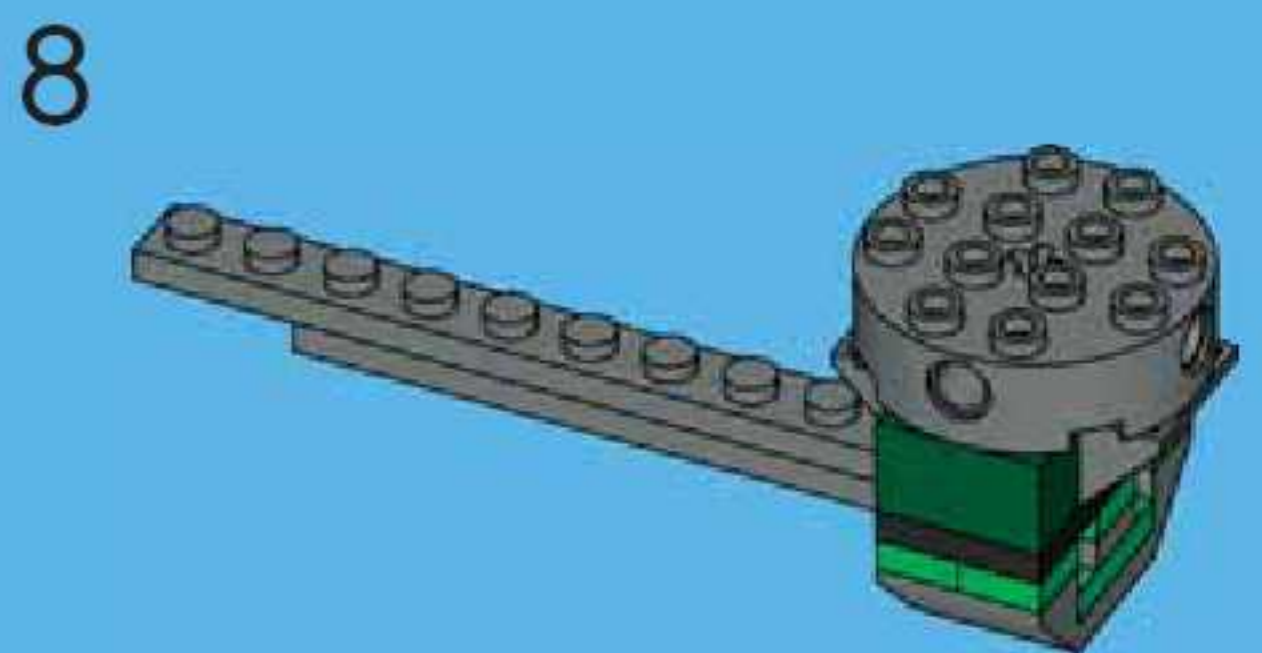
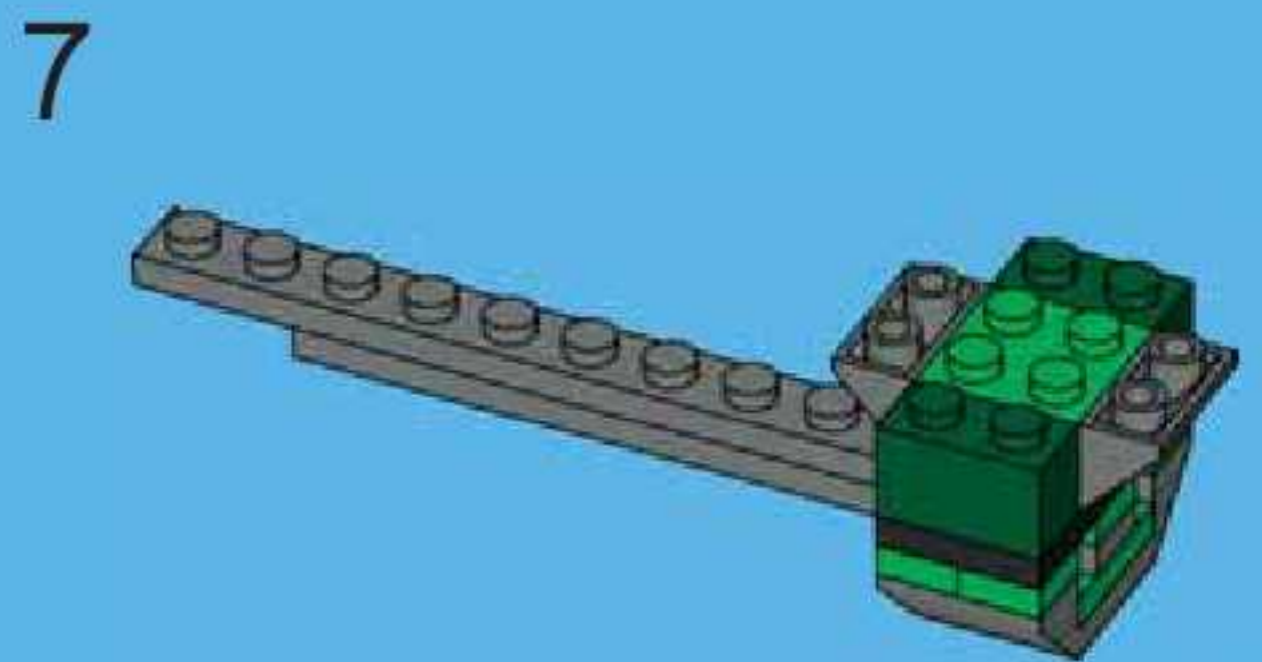
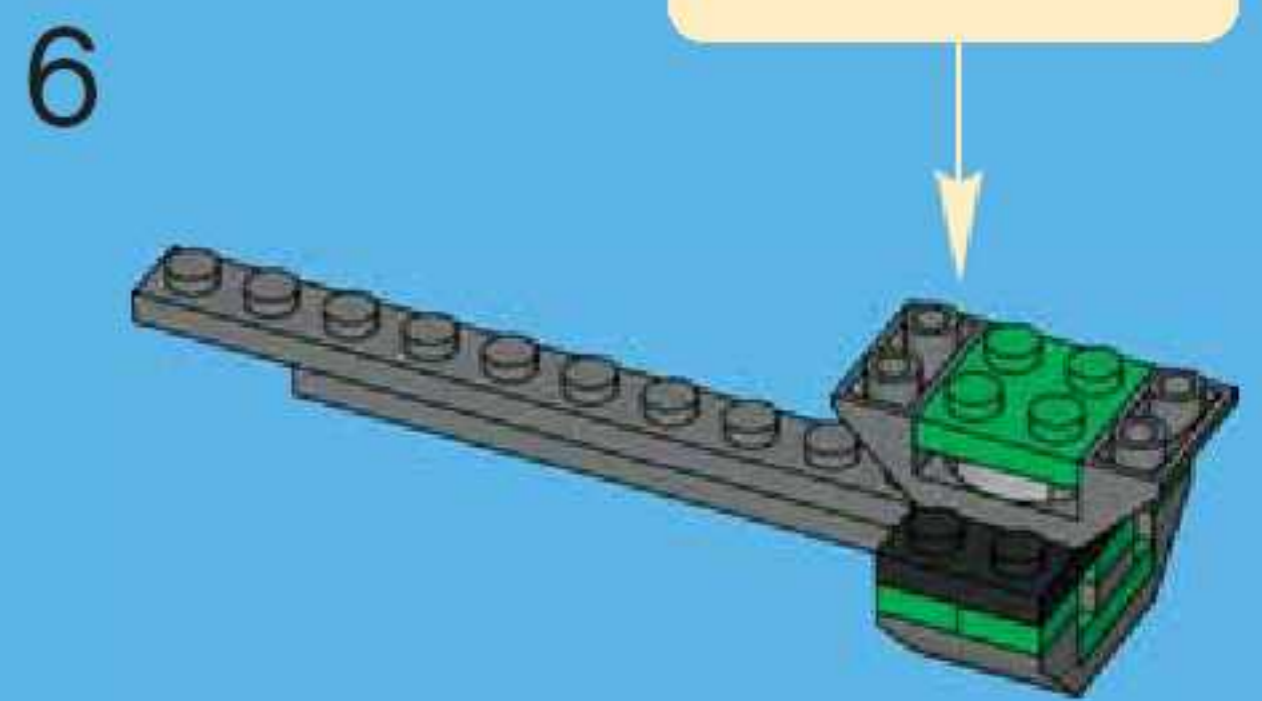
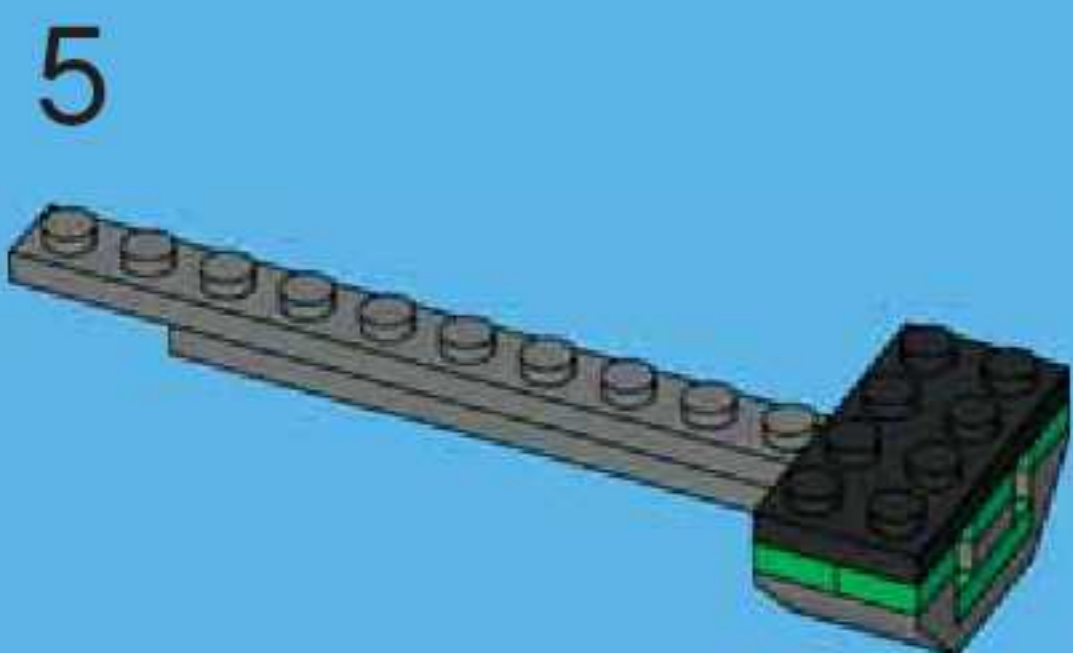
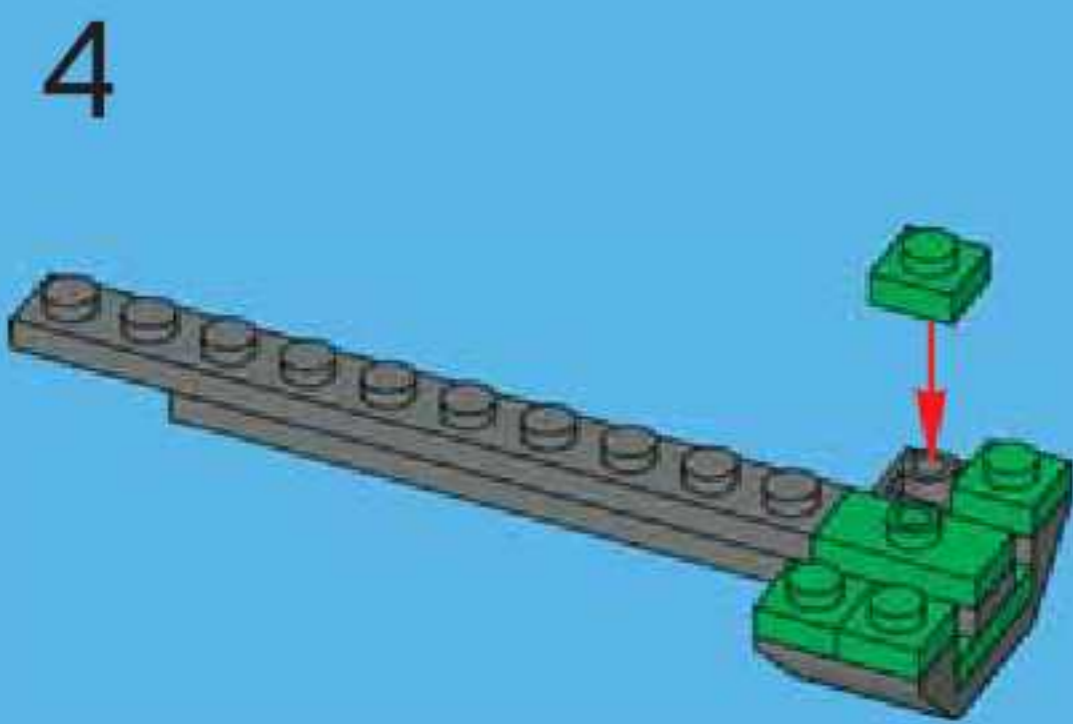
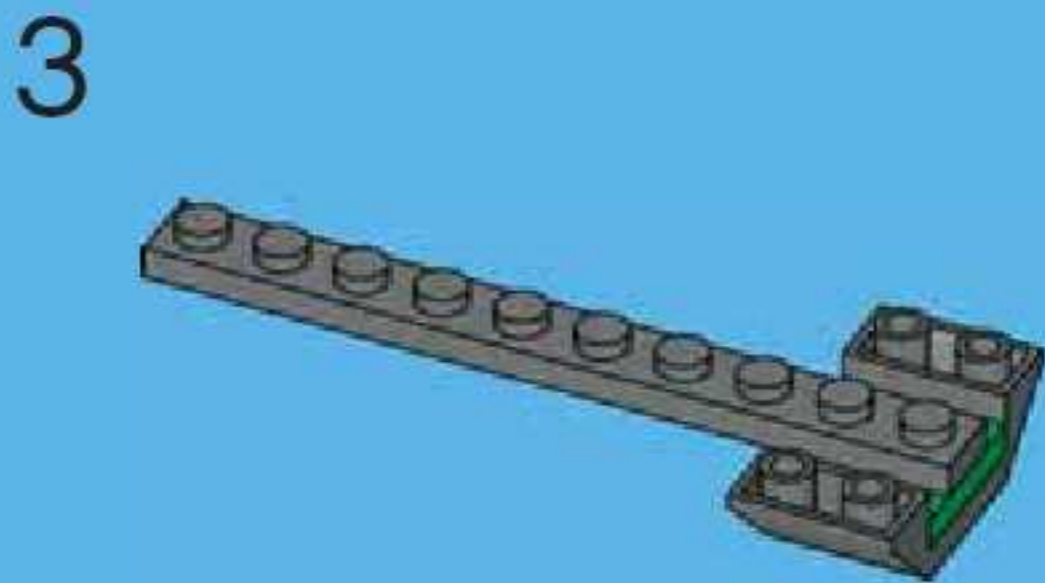
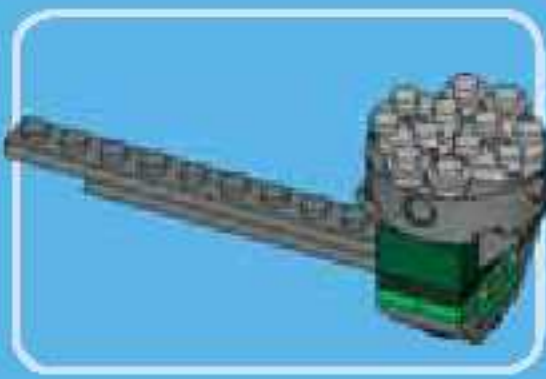

9

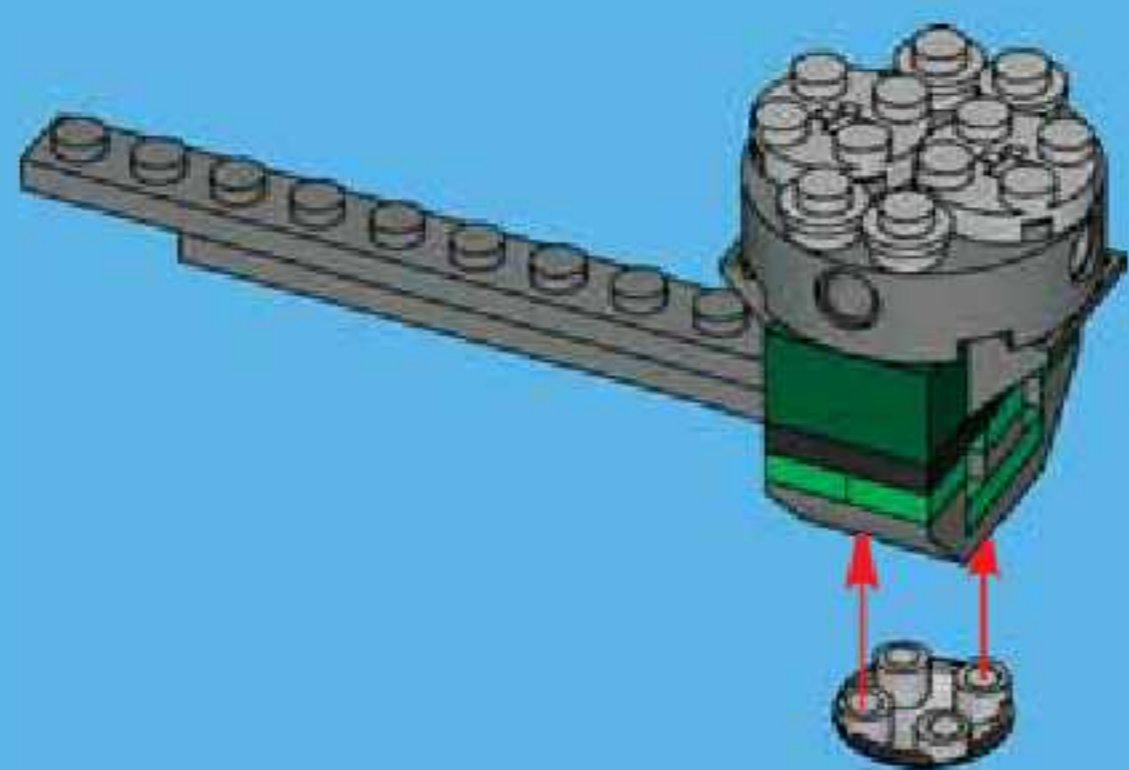

19

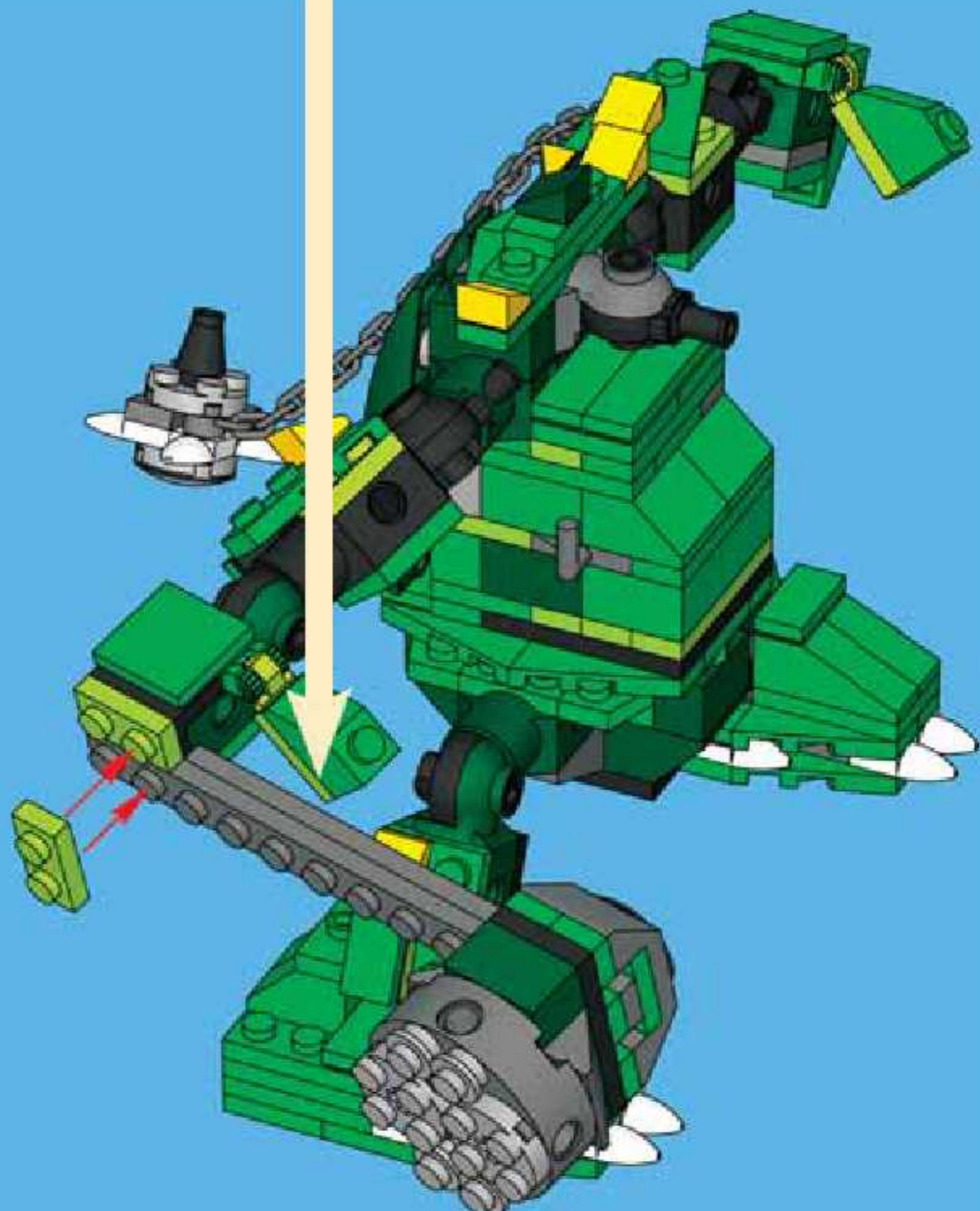

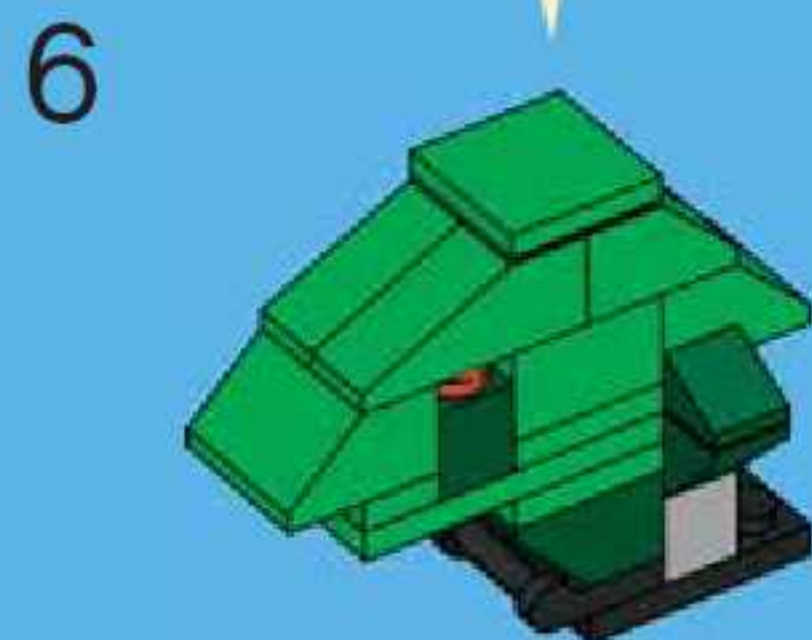
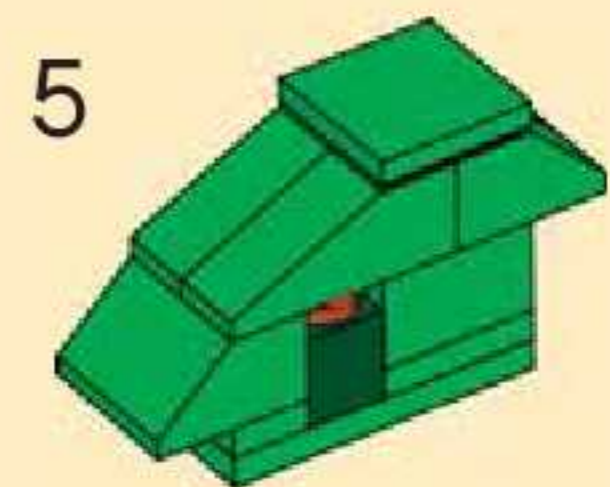
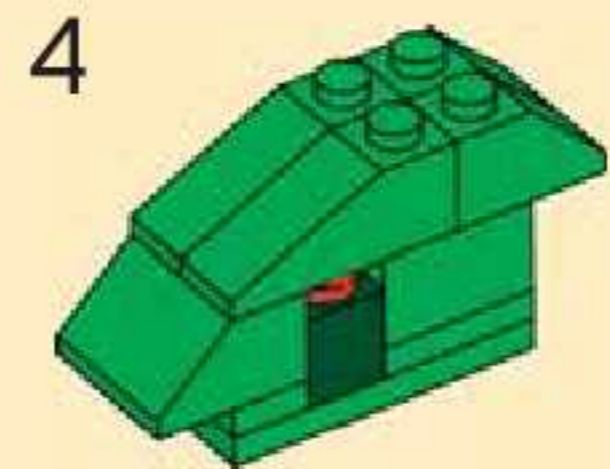
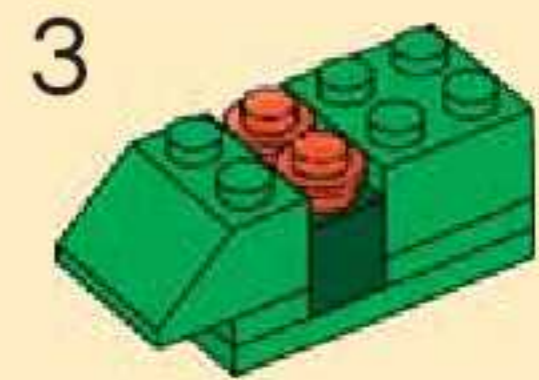
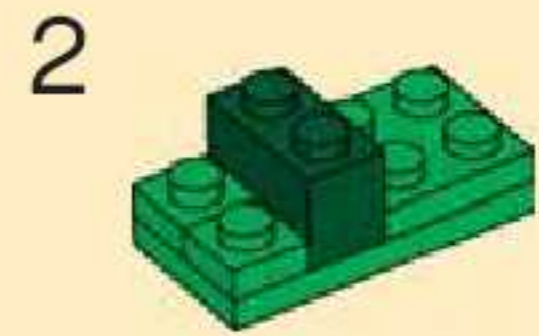
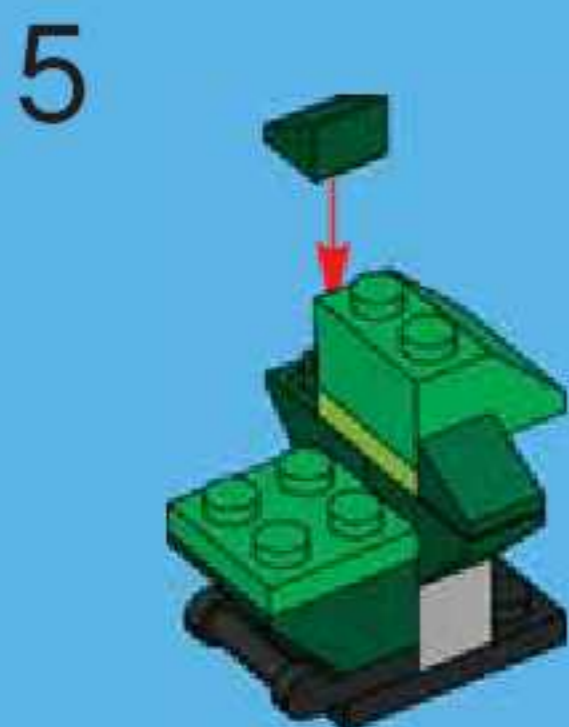
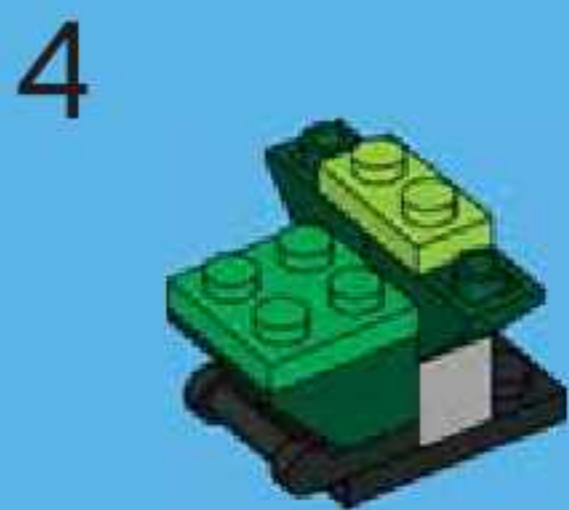
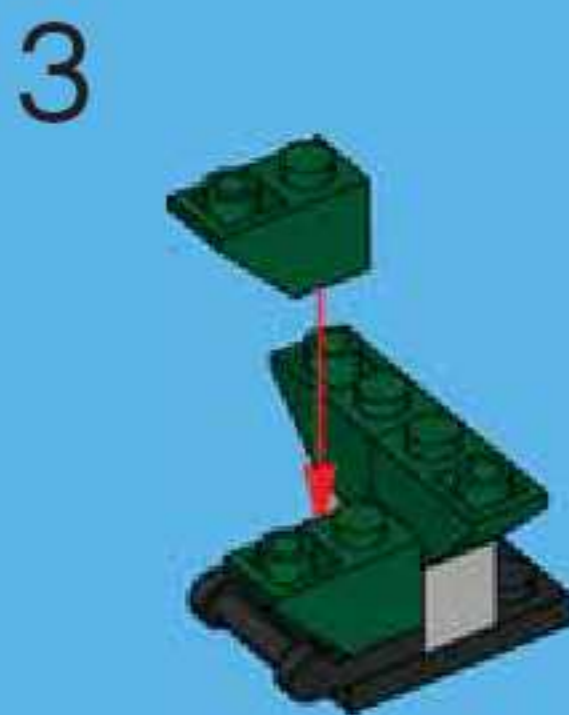
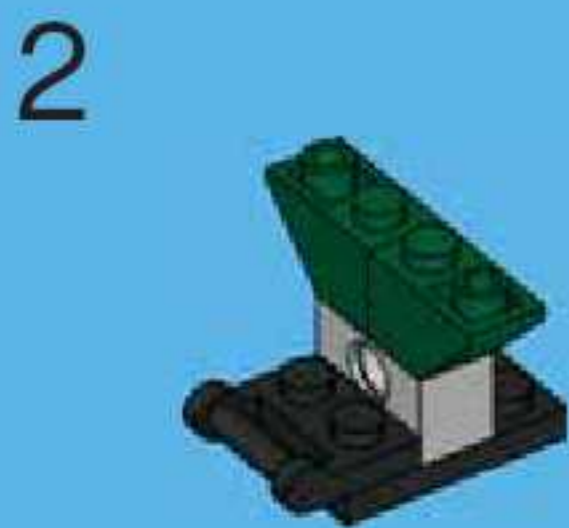
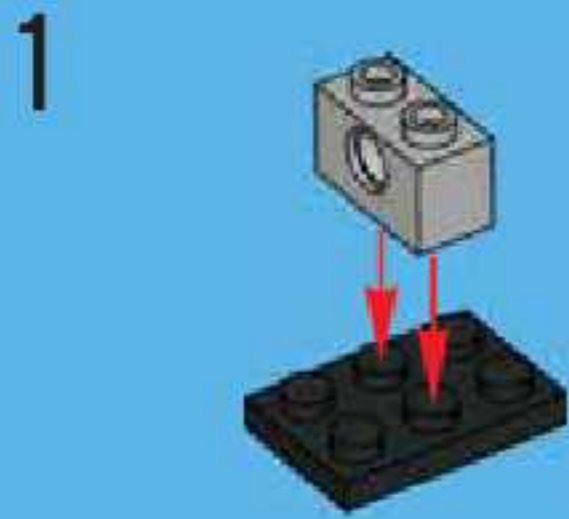

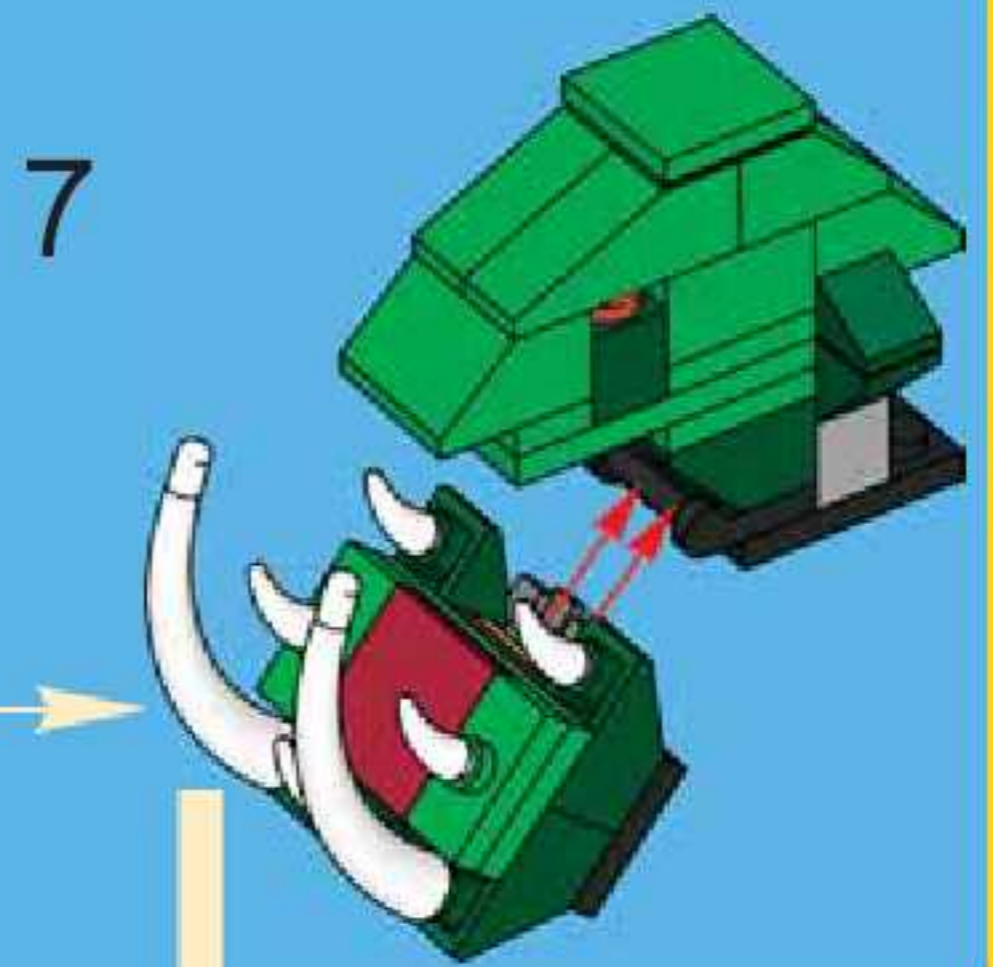
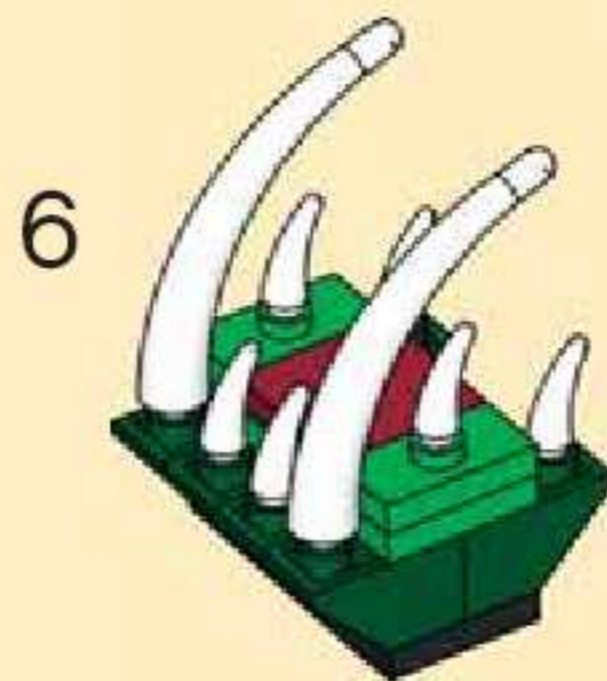
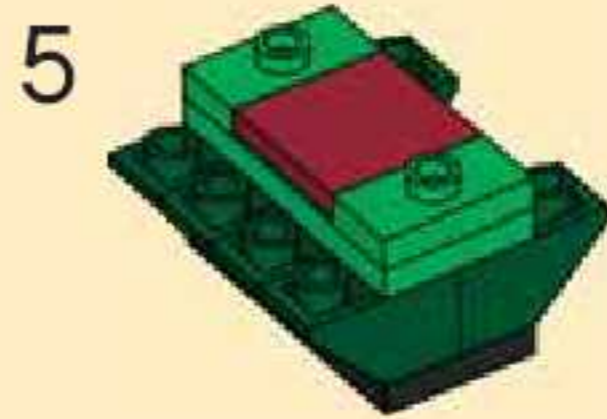
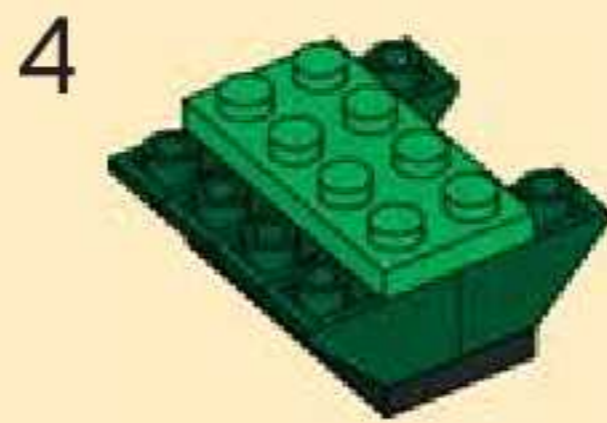
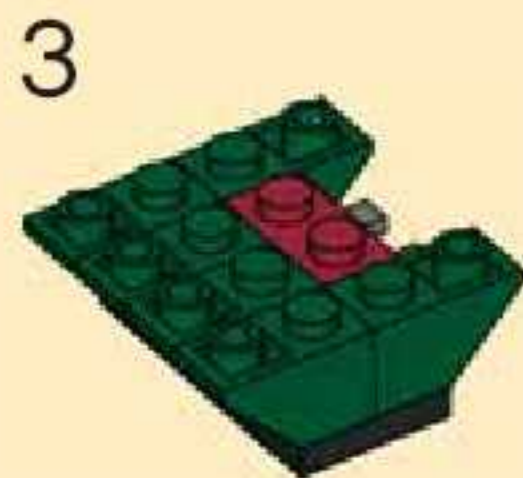
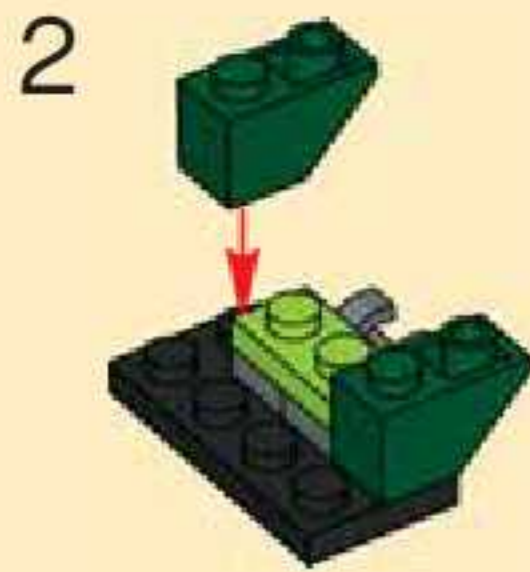
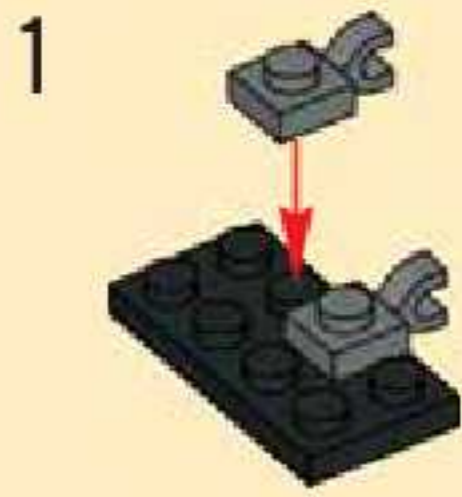

21

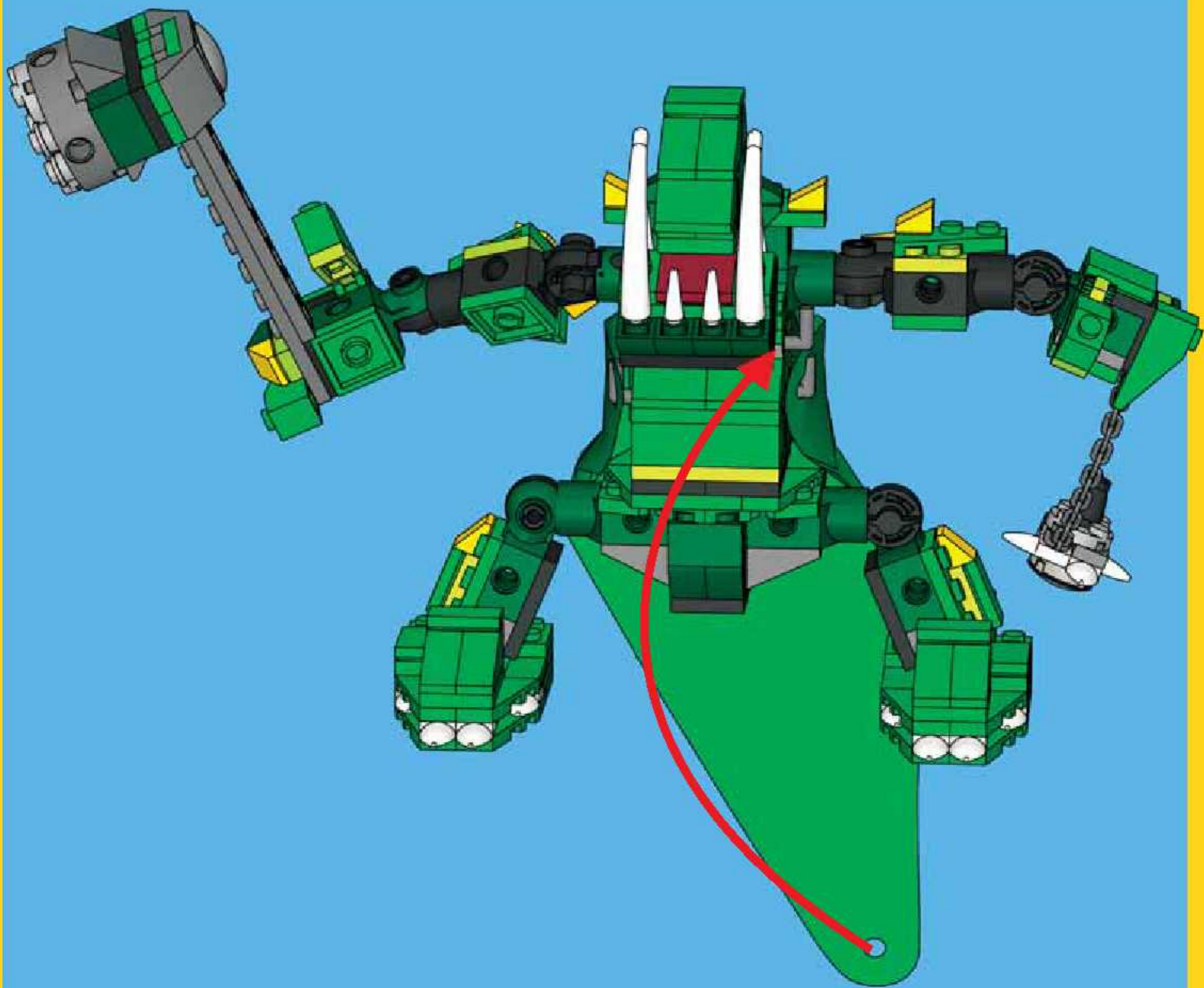

22



14x
306928



10x
243128



5x
4107762



4x
4187931



16x
302428

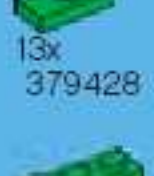

13x
379428



24x
4183062

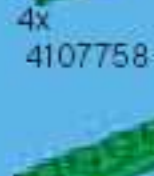

4x
4107758

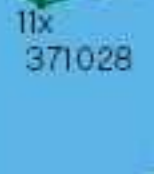

11x
371028



6x
346028

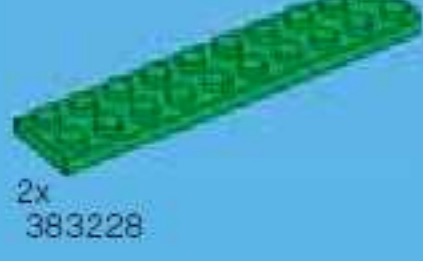

2x
383228



15x
302228



6x
302128



11x
4180538



11x
4180510

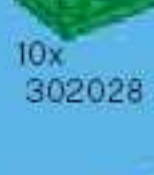

10x
302028



2x
379528



8x
4121969



8x
4107637



4x
303928



1x
4260371



4x
300528



4x
4112838



3x
300328



3x
4106356

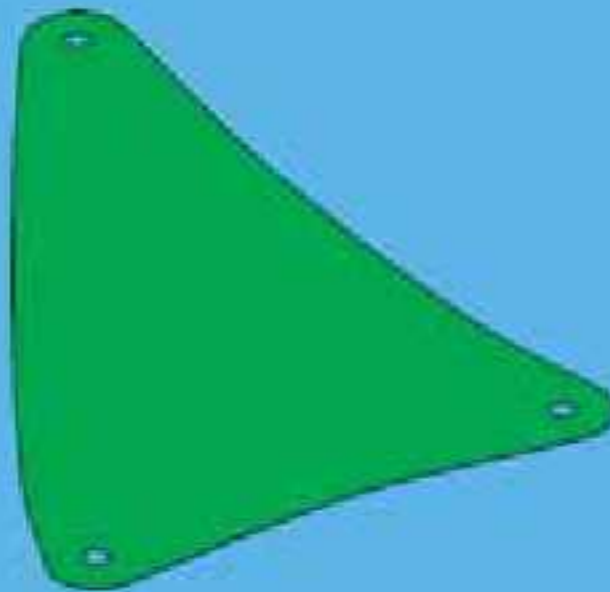

2x
4293994



2x
4277932



4x
4282746



4x
4285877



12x
4213374



14x
408126



6x
458926



2x
255526

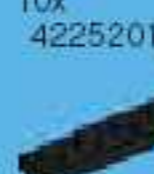

10x
4225201



7x
366626



2x
428226



2x
302226



4x
302126



6x
302026



1x
4251394



1x
4251393



2x
265326



6x
4273397



20x
4224792



1x
4249506



2x
4244370



2x
4182304



1x
612647



4x
3005747



2x
4177046



3x
4162582



3x
4206482



2x
4141630



12x
4283095



4x
4121965

2x
4163577

6x
3005749

28x
4164037

11x
4213303

12x
4187743

6x
4295522

4x
4221195

15x
4245570

2x
4275975

8x
4257583

6x
4257578

1x
4293615

1x
4293614

7x
4249058

18x
4265357

3x
4276005

3x
4276003

2x
4295523

2x
4295521

2x
4211483

6x
4211475

1x
4211436

8x
4211525

6x
4278273

3x
4211440

1x
4294909

4x
4210725

2x
4210779

2x
4227395

2x
421109

1x
4211035

10x
4210635

19x
4216973

4x
4257526

2x
4210892

12x
4210726

3x
4210788

3x
4210782

2x
4211002

4x
4260885

2x
4290149

2x
4290150

4x
4211064

2x
4211076

1x
4211097

1x
4284052

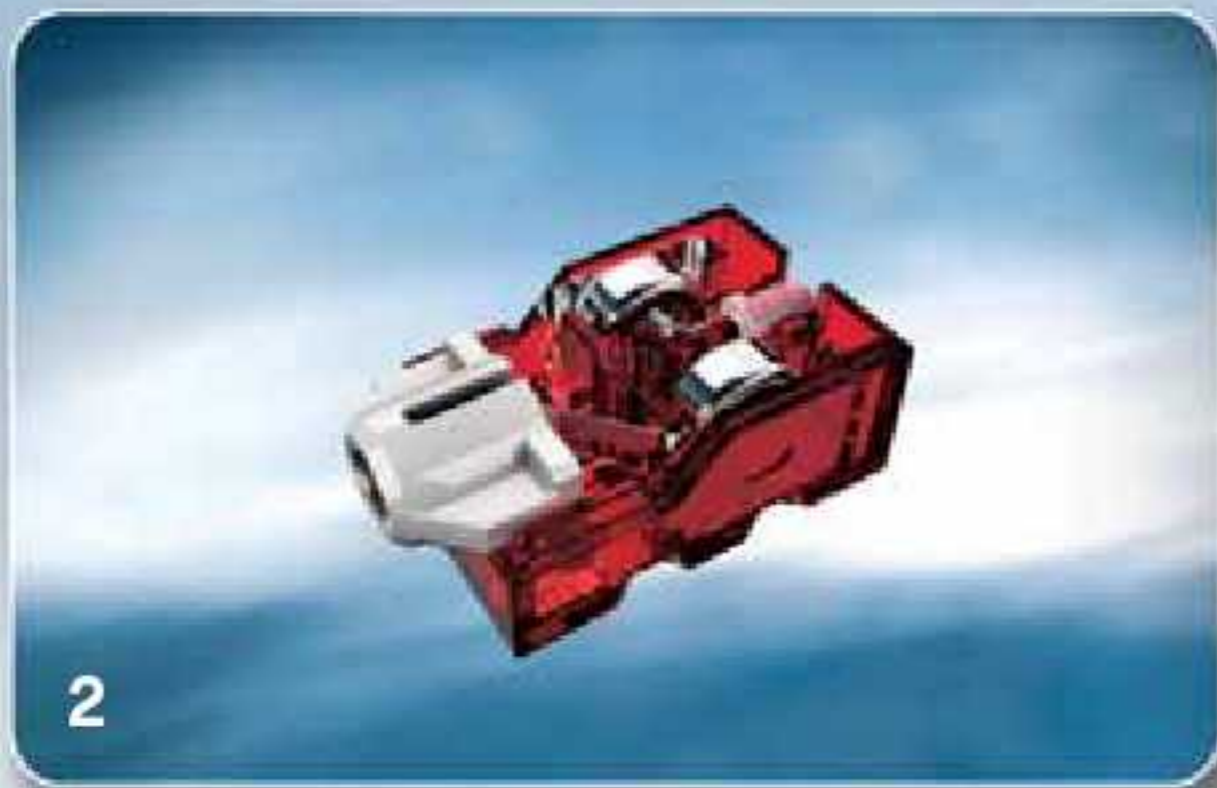

GB

Important information about batteries

Never use different types of batteries together, or a combination of old and new batteries. Always remove the batteries if the product is not to be used for a long time or if the batteries have run down. Never use damaged batteries. Only use batteries of the type recommended, or a corresponding type. Insert the batteries so that the poles are correctly positioned. Rechargeable batteries must be recharged using the correct battery charger under the supervision of an adult. You cannot recharge batteries while they are still in the product, and you must never try to do so. Never attempt to recharge non-rechargeable batteries. Never short-circuit the battery holder.

DE

Wichtige Information zu Batterien

Benutzen Sie niemals unterschiedliche Arten von Batterien oder alte und neue gleichzeitig. Nehmen Sie stets die Batterien heraus, wenn mit dem Modell längere Zeit nicht gespielt wird oder wenn die Batterien leer sind. Verwenden Sie niemals beschädigte Batterien. Verwenden Sie ausschließlich empfohlene bzw. geeignete Batterien. Achten Sie beim Einsetzen der Batterien auf die richtige Polung. Wiederaufladbare Batterien sollten mit einem geeigneten Ladegerät aufgeladen werden – unter der Aufsicht eines Erwachsenen. Batterien können und sollten niemals aufgeladen werden, während sie sich im Modell befinden. Versuchen Sie unter keinen Umständen, „normale“ Batterien wiederzuladen. Schließen Sie das Batteriefach niemals kurz.

FR

Informations importantes concernant les piles

Ne jamais utiliser un mélange de différents types de piles, ou de piles neuves et de piles anciennes ou déjà utilisées. Toujours retirer les piles si le produit n'est pas utilisé durant une période prolongée ou si les piles sont vides. Ne jamais utiliser de piles endommagées. Utiliser uniquement des piles du type recommandé ou d'un type équivalent. En insérant les piles, respecter scrupuleusement le sens d'orientation des pôles (+/-). Les piles rechargeables doivent être rechargées en utilisant un chargeur de piles adéquat et sous la surveillance d'un adulte. Il est impossible de recharger les piles quand elles sont installées dans le produit. Ne jamais tenter de le faire. Ne jamais essayer de recharger des piles non-rechargeables. Ne jamais court-circuiter le compartiment des piles.

IT

Importanti informazioni sulle batterie

Non usare mai contemporaneamente batterie di tipo diverso o batterie nuove a usate insieme. Rimuovere sempre le batterie qualora il prodotto non venga utilizzato per periodi prolungati, oppure se le batterie sono esaurite. Non utilizzare mai batterie danneggiate. Usare esclusivamente batterie del tipo raccomandato o un equivalente. Inserire le batterie avendo cura che la loro polarità sia corretta. Le batterie ricaricabili vanno ricaricate in un caricabatterie di tipo idoneo e con la supervisione di un adulto. Non è possibile e non bisogna mai tentare di ricaricare le batterie mentre queste sono inserite nel prodotto. Non tentare mai di ricaricare le batterie non ricaricabili. Non cortocircuitare mai il portabatterie.

NL

Belangrijke informatie over batterijen

Gebruik nooit verschillende soorten of nieuwe en oude batterijen tegelijkertijd. Verwijder de batterijen altijd als je het product lange tijd niet wilt gebruiken of als de batterijen leeg zijn. Nooit beschadigde batterijen gebruiken. Uitsluitend batterijen van het aanbevolen of overeenkomstige type gebruiken. Leg de batterijen met de polen in de juiste richting. Opladbare batterijen moeten in een voor dit doel bestemde oplader en onder toezicht van een volwassene opnieuw worden opgeladen. Opladbare batterijen kunnen niet in het product worden opgeladen en je mag dit ook niet proberen te doen. Probeer nooit niet-oplaadbare batterijen op te laden. Nooit de batterijhouder kortsluiten.

ES

Importante información sobre las baterías

No mezclar nunca diferentes tipos de baterías, ni utilizar baterías antiguas y nuevas a la vez. Sacar siempre las baterías, si el producto no se utiliza por un largo periodo de tiempo o si las baterías están desgastadas. No utilizar nunca baterías dañadas. Utilizar solo el tipo de baterías recomendado o uno correspondiente. Colocar las baterías de manera que los polos estén en su posición correcta. Las baterías recargables deben cargarse con un cargador adecuado bajo la supervisión de un adulto. Las baterías no pueden, ni deben recargarse mientras permanecen en el producto. No intentar nunca recargar baterías no recargables. Asegurarse que no se produzca un cortocircuito en el porta-baterías.

DK

Vigtig information om batterier

Brug aldrig forskellige typer batterier sammen eller nye og gamle batterier samtidig. Tæg altid batterierne ud, hvis du ikke skal bruge produktet i længere tid, eller hvis batterierne er brugt op. Anvend aldrig beskadigede batterier. Der må kun anvendes batterier af samme eller tilsvarende type som anbefalet. Batterierne skal være rigtigt når de i sættes. Genopladelige batterier skal oplades i en dertil beregnet oplader under opsyn af en voksen. Genopladelige batterier kan og må ikke forsegles opladet i produktet. Forsøg aldrig at genoplade ikke-genopladelige batterier. Kontakt aldrig batterikasseens kontaktpeder.

FI

Tärkeisiä tietoja paristoista

Älä koskaan käytä erityyppisiä paristoja yhdessä. Älä nykäänkin käytä vanhoja laturissa eikä vanhoja sitä uusia paristoja. Poista paristot tuotteenosta aina, kun se on pitkäaikaan eteen käytettävissä, tai kun paristot ovat tyhjentynyt. Älä koskaan käytä viallisia paristoja. Käytä vain tuotteen suositteimia tai vastaavatyypisiä paristoja. Aseta paristot eteen, etäi nevat osoittavat oikeaan suuntaan. Ladattavat paristot on ladattava oikeankäyttöä laiturissa silloin valvotussa. Ne on paristotuen tuotteen laturissa ajaksi. Älä koskaan yritä ladata paristoja, jotka ei ole tarkoitettu ladattaviksi. Älä koskaan yritä ottaa pois pois pariston kotelostaan viallis.

SE

Viktig information om batterier

Använd aldrig olika sorters batterier samtidigt, och inte heller en kombination av gamla och nya batterier. Ta alltid ur batterierna om produkten under en längre tid inte ska användas eller om batterierna är slut. Använd aldrig skadade batterier. Använd bara batterier av den typ som rekommenderats, eller av en motsvarande typ. Sätt i batterierna så att polarna hamnar i rätt läge. Laddningsbara batterier måste laddas med rätt slags batteriladdare och under en vuxens överinseende. Du kan inte ladda batterierna medan de förvaras i batteri i produkten, och du får heller aldrig försöka göra det. Försök aldrig ladda icke-laddningsbara batterier. Kontakta aldrig batteriutrymmets kontaktpyter.

PT

Informações importantes acerca das pilhas

Nunca use tipos diferentes de pilhas em conjunto, nem uma combinação de pilhas velhas e novas. Retire sempre as pilhas se o produto não vai ser utilizado durante muito tempo ou se as pilhas se tiverem gasto. Nunca use pilhas danificadas. Use apenas pilhas do tipo recomendadas ou de um tipo correspondente. Introduza as pilhas de forma a que os seus pólos sejam correctamente posicionados. Pilhas recarregáveis deverão ser recarregadas utilizando o recarregador de pilhas correcto sob a supervisão de um adulto. Não é possível recarregar pilhas recarregáveis enquanto elas ainda se encontram dentro do produto, e nunca devem ser feitas tentativas nesse sentido. Nunca tente recarregar pilhas não recarregáveis. Nunca feche cerca-circuitos do compartimento das pilhas.

GR

Σημαντικές πληροφορίες για τις μπαταρίες

Μη χρησιμοποιείτε ποτέ διαφορετικούς τύπους μπαταριών, ή παλιές και καινούριες μπαταρίες μαζί. Βγάλτε πάντα τις μπαταρίες αν δεν χρησιμοποιήσετε το προϊόν για αρκετό καιρό ή αν οι μπαταρίες έχουν αδειάσει. Ποτέ μη χρησιμοποιείτε χαλασμένες μπαταρίες. Χρησιμοποιείτε μόνο μπαταρίες του συνιστάμενου τύπου, ή αντίστοιχου τύπου. Βάλτε τις μπαταρίες με την σωστή πολικότητα. Θα πρέπει να φορτίζετε τις επαναφορτιζόμενες μπαταρίες χρησιμοποιώντας τον κατάλληλο φορτιστή μπαταριών υπό την επίβλεψη ενός ενήλικου. Δεν μπορείτε να επαναφορτίσετε τις μπαταρίες όταν αυτές βρισκονται μέσα στο προϊόν, και ποτέ μην επιχειρήσετε να κάνετε κάτι τέτοιο. Μην επιχειρήσετε ποτέ να επαναφορτίσετε μη επαναφορτιζόμενες μπαταρίες. Ποτέ μη βραχυκυκλώσετε τη θύκη των μπαταριών.

JP

電池の取り扱いに関する注意

異なるタイプの電池や、古い電池と新しい電池を混ぜて使用しないで下さい。新旧両方を使用しない時や電池の入れ忘れは、必ず電池を取り外してください。電池は正常とされている種類のみ、もしくは対応する種類のみに使用してください。電圧が適合して正しい方向に電池を入れてください。充電電池を使用する際は充電器の取扱説明書、正しく充電をして使用してください。自覚の中に入れておまかせする事は絶対に避けてください。充電器ではない電圧計や万用計、電圧計ショートさせたりしないでください。

CN

電池使用須知

切勿將不同種類的電池一起使用，亦不要把舊電池與新電池混合使用。如有一段長時間不會使用本產品或電池已耗盡，請把電池拆除。切勿使用已損壞之電池。只可使用圖冊中之電池型號，或其他標明式型號。請根據指示安裝電池。

你可以使用充電的插電電池，但必須採用適當的充電器，並在成年人的指導下方可進行充電。電池仍在產品內是不能充電的，請勿進行嘗試。切勿試圖為非插電電池充電。亦切勿自行換取電池箱的兩極，以免產生短路。

KR

간접시 사용시 주의 사항

다른 전지(리튬, 또는 세 전지)와 구 전지를 혼합해서 사용하지 마십시오. 종전지(리튬)와 구 전지를 혼합해서 사용하면 화재가 발생할 수 있습니다. 또한 충전 가능한(rechargeable battery)는 제품 안에서 충전할 수 없으므로, 별도로 충전하는 방법을 사용하십시오. 그리고, 충전 가능한(rechargeable battery)가 아닌 전지를 충전해서는 안 됩니다.

RU

Необходимая информация об элементах питания

Ни в коем случае не используйте одновременно элементы питания различных типов, а также элементы питания с разным сроком годности. В обязательном порядке выньте все элементы питания из термобатареи в случае, если вы не пользуетесь прибором в течение долгого времени либо в случае, если в элементах питания закончилась заряд. Ни в коем случае не используйте поврежденные элементы питания. Используйте только рекомендованные элементы питания, либо элементы питания соответствующего типа. Установите элементы питания, соблюдая указанную полярность. Аккумуляторные элементы питания должны подзарядиться в соответствующем зарядном устройстве под наблюдением взрослого. Ни в коем случае не пытайтесь подзарядить элементы питания, находящиеся в приборе. Ни в коем случае не пытайтесь подзарядить поврежденные элементы питания. Ни в коем случае не пытайтесь замкнуть полюса в устройстве для элементов питания.

PL

Ważne informacje dotyczące baterii

Nigdy nie należy stosować razem różnych rodzajów baterii ani stosować równocześnie starych i nowych baterii. Jeżeli produkt nie jest używany przez dłuższy czas lub jeżeli bateria się wyczerpała, należy wyjąć baterie. Nigdy nie należy stosować uszkodzonych baterii. Należy stosować wyłącznie zalecany rodzaj baterii lub rodzaj mi odpowiedni. Przy włączeniu baterii należy zwrócić uwagę na właściwe połączenie biegunów. Bateria akumulatorowa należy ładować w odpowiedniej ładowarce pod nadzorem osoby dorosłej. Nie można naładować baterii bez wyjścia ich z produktu i nigdy nie należy tego próbować. Nigdy nie należy próbować ładowania baterii jednorazowych. Nigdy nie należy doprowadzać do zwarcia w gniazdku baterii.

CZ

Důležité informace o bateriích

Nikdy nepoužívejte najednou různé typy baterií nebo kombinaci starých a nových baterií. Nebudete-li výrobek delší dobu používat nebo jsou-li baterie vybité, vždy je vyjměte z výrobku. Nikdy nepoužívejte poškozené baterie. Používejte pouze doporučené nebo odpovídající typy baterií. Baterie instalujte se správnou orientací pólu. Nabíjecí baterie musí být nabíjen ve vhodné nabíječce pod dohledem dospělé osoby. Nabíjecí baterie nelze nabíjet, jsou-li umístěny ve výrobku, a nemělo se o to ani pokoušet. Nikdy se nemělo nabíjet baterie, které nejsou nabíjecími. Nikdy nedotýkejte kontakty v přístroji pro baterie.

SK

Dôležitá informácia o batériách

Nikdy nepoužívajte naraz odlišné typy batérií ani kombináciu staré batérie a novými. Batérie vždy vyberte, ak sa výrobok nebude dlhšie používať, alebo ak sa batérie vybité. Nikdy nepoužívajte poškodené batérie. Používajte len odporúčané alebo zodpovedajúce typy batérií. Batérie vkladajte so správnou orientáciou pólov. Dobíjecí batérie sa musia nabíjať vo vhodnom nabíjači pod dozrom dospelého osoby. Dobíjecí batérie sa nemô nabíjať, ak sú umiestnené vo výrobku, a nemělo sa o to ani pokoušať. Nikdy sa nemělo nabíjať batérie, ktoré nie sú dobíjecími. Nikdy nedotýkajte kontakty v prístroji pro batérie.

HU

Fontos tudnivalók az elemekről

Soha ne használjunk különböző típusú elemeket, illetve ne használjunk új és használt elemet egyszerre. Minél tovább tartunk el az elemeket, ha a készüléket előre láthatóan hosszú ideig nem fogjuk használni, vagy ha az elemek lemerültek. Soha ne használjunk megromlott elemet. Csak az ajánlott típusú, vagy annak megfelelő elemet használjuk. Az elemeket a polaritásuknak megfelelő módon helyezik be. Az akkumulátorokat csak a megfelelő akkumulátoröltővel szabad feltölteni, egy felnőtt segítségével kell ezt megtenni. Az akkumulátorokat nem tölthetjük fel úgy, hogy azok a termékben vannak, ezt meg sem szabad próbálnunk. Soha ne próbáljuk meg feltölteni a nem tölthető elemeket. Soha ne hozzunk létre rövidzárlatot az elemekről közvetve közvetlenül.

UA

Необхідна інформація про батарейки

Ніколи не використовуйте одночасно батарейки різних типів або батарейки з різними строками використання. Обов'язково виймайте батарейки з прибору якщо довгочасно не користуєтесь їм, або якщо в батарейках вже скінчилась заряд. Ніколи не використовуйте пошкоджені батарейки. Використовуйте батарейки лише рекомендованого або відповідного типу. Встановлюйте батарейки, дотримуючись заданої полярності. Акумуляторні батарейки повинні зарядитись у відповідному зарядному пристрої під наглядом дорослого. В будь-якому випадку не намагайтесь підзарядити батарейки, що знаходяться в приборі. В будь-якому випадку не намагайтесь підзарядити батарейки, що не підлягають підзарядці. В будь-якому випадку не намагайтесь зробити коротке замкнення в пристрої для батарей.

HR

Važna informacija o baterijama

Nikada ne koristite različite vrste baterija zajedno, kao ni kombinaciju starih i novih baterija. Uvijek izvadite baterije ako uređaj neće biti korišten duže vrijeme ili ako su baterije prazne. Nikada ne koristite oštećene baterije. Upotrebljavajte samo preporučenu vrstu baterija ili njima ekvivalentni tip. Umetnite baterije tako da su (u polovni ispravno orijentirani. Baterije koje se mogu puniti moraju biti punjene u odgovarajućem punjaču baterija pod nadzorom odrasle osobe. Ne možete puniti baterije dok su umetnute u uređaj i to nikada niti ne pokušavajte. Nikada ne pokušavajte napuniti baterije koje se ne mogu puniti. Nikada izbjegavajte spojiti polove baterija.

SR

Важна информација о батеријама

Никада не користите различите типове батерија заједно, и не користите старе батерије са новим. Увек извадите батерије ако уређај неће дуго времена бити коришћен или ако су батерије празне. Никада не употребљавайте оштећене батерије. Користите препоручени тип батерија или еквивалентног или одговарајућег типа. Правилно стављање батерија гарантује да полуси буду правилно попуњени. Батерије се пуњавају са уређајом пуњача за батерије одређеног типа и под надзором одрасле особе. Батерије се не могу пуњити док су у уређају, и то не смате ни да покушавате. Никада не покушавајте да напуњите батерије које се не могу пуњити. Никада не покушавајте повезати полуси батерија.

SI

Pomenbna informacija o baterijskih vložkih
Nikoli ne uporabite različne vrste baterijskih vložkov skupaj ali pa nove vložke skupaj z rabljenimi. Če so se baterijski vložki izpraznili ali če izgledajo nekoč uporabljeni dlje časa, morate vložke vedno odnesti. Nikoli ne uporabite poškodovanih baterijskih vložkov. Uporabite samo priporočen tip baterijskih vložkov ali enakovredne vložke. Baterijske vložke vezavite tako, da sta pola plus in minus pravilno usmerjena. Baterijske vložke za ponovno polnjenje morajo ostati polni z ustreznimi polnilcem samo pod nadzorom odrasle osebe. Pred polnjenjem morate vložke vedno tožati iz igrača. Nikoli ne smete polniti baterijskih vložkov, medtem ko so še vedno v igraču. Nikoli ne poskušajte polniti baterijske vložke, ki niso namenjeni za ponovno polnjenje. V prostoru za baterijske vložke ne smete nikoli povzročiti kratkega stika.

RO

Informații importante cu privire la baterii
Nu folosiți niciodată împreună tipuri diferite de baterii și nici combinații de baterii noi și vechi. Încălțați întotdeauna bateriile dacă produsul nu este folosit timp îndelungat sau dacă bateriile s-au epuizat. Nu folosiți niciodată baterii deteriorate. Folosiți numai baterii de tipul recomandat, sau de un tip corespunzător. Introduceți bateriile astfel ca polișii să fie în poziția corectă. Bateriile reîncărcabile trebuie reîncărcate utilizând un dispozitiv de încălzire adecvat, sub supravegherea unui adult. Bateriile nu pot fi reîncărcate cât timp sunt încă în produs, și nu încercați niciodată să le încălțați astfel. Nu încercați niciodată să reîncălțați baterii care nu sunt reîncărcabile. Nu scurtați niciodată bornele supercapacitorului bateriei.

BG

Важна информация за батериите
Не използвайте различни типове батерии едновременно, нито комбинация от стари и нови батерии. Винаги изключвайте батериите, ако използвате новия да се използват продължително време или ако батериите не се използват. Не използвайте повредени батерии. Използвайте само батерии от приоръчания тип или еквивалент на него тип. Поставете батериите така, че полярността да се съответства правилно. Акумулаторните батерии трябва да се зареждат с подходящо зареждащо устройство под надзор на възрастни. Батериите не могат да се зареждат, докато са поставени в изделията, така че не трябва да се опитвате да правите това. Не се опитвайте да зареждате батерии, които не са акумулаторни. Не свързвайте в едно електрическо кълаче на батериите.

LV

Svarīgs informācija par barošanas elementiem
Nekad vienlaikus nelietojiet dažādu tipu, kā arī jaunus un vecus barošanas elementus. Arvien izņemiet barošanas elementus, ja tie izskatās vai to darbības laikā izstaro ilgāku laiku netiek lietots. Nekad nelietojiet bojātus barošanas elementus. Lietojiet tikai ieteiktam tipa barošanas elementus vai tiem atbilstošus analogus, ieviešot barošanas elementus, jāievieš pareizi to pievienojuma polaritāte (+/-). Iztīrījamu barošanas elementu iztīrīšanai jāizmanto atbilstošs barošanas elementu tīrītājs, uzklājot šķīviņus plaušulā uzraudzībā, iztīrījamu ieviešamu barošanas elementus iztīrīt nav iespējams, mēģinājumi to darīt nav pieņemami. Nekad netaisniet uzlādēt netaisnījamu barošanas elementus. Nekad nepieļaujiet tiešgumu starp barošanas elementu tāpēc kontaktiem.

EE

Oluline teave patareide kohta
Mitme kunagi ära pane mitmessele aiasse koos erinevat tüüpi patareide, samuti vanu ja uusi patareid. Kui mitmessele ei kasutata pikka aega, võta patareid välja. Ka tühjaks saanud patareid tuleb mitmessele välja võtta. Ära kasuta kahjustatud patareid. Kasuta ainult ettenähtud tüüpi või näle sarnaselt patareid. Pane patareid mitmessele aiasse nii, et plus- ja miinuskaabli asend oleks õige. Alakõli tuleb kasutada ainult nende ettenähtud akudele, et vältida veele juurdepääsu. Alakõli ei saa kasutada sel ajal, kui need on mitmessele sees. Ära kunagi püüa nii teha. Ära mitte kunagi proovi akudele kasutada teisi patareid. Patareid kasutamise vahel ei tohi tekkida kontakt.

LT

Svarbi informacija apie elementus
Nenaudoškite vienu metu skirtingu tipu elementais, taip pat su naujais elementais nenaudoškite senų elementais. Išimkite elementus iš įkėlio, jeigu nenaudoškite gaminiu ilgą laiką arba netekis lietuoti. Nekad nenaudoškite bojūtus barošanas elementus. Lietojiet tik ieteiktam tipa barošanas elementus vai tiem atbilstošus analogus, ieviešot barošanas elementus, jāievieš pareizi to pievienojuma polaritāte (+/-). Iztīrījamu barošanas elementu iztīrīšanai jāizmanto atbilstošs barošanas elementu tīrītājs, uzklājot šķīviņus plaušulā uzraudzībā, iztīrījamu ieviešamu barošanas elementus iztīrīt nav iespējams, mēģinājumi to darīt nav pieņemami. Nekad netaisniet uzlādēt netaisnījamu barošanas elementus. Nekad nepieļaujiet tiešgumu starp barošanas elementu tāpēc kontaktiem.

TR

Piller hakkında önemli bilgiler

Hiçbir zaman değişik tipte pilleri ya da eski pilleri yeni pilleri bir arada kullanmayın. Pili Grün uzun süre kullanılmayacak ya da piller bitmiş, pilleri çıkarın. Hiçbir zaman zarar görmüş piller kullanmayın. Yalnız önerilen tipte piller ya da bunların dengi olan piller kullanın. Pilleri kutularını doğru şekilde çıkartın. Pilleri çıkarırken, bitince yeniden doldurulamayan piller doğru pil dolduruyuyu kullanarak, bir yenisinin demetini alanda doldurulamadır. Doldurulamayan pilleri Grünün içindeki kullanılmayacak, hiçbir zaman bunu yapmaya çalışmayın. Hiçbir zaman, bitince doldurulamayan tip pilleri yeniden doldurmaya çalışmayın. Hiçbir zaman pil kutusunu kısa süre yapırmayın.





CREATOR

