

LEGO

CREATOR

7-12

4894 - 2



Ideas



Instructions





Advanced Build
Profimodelle
Construction avancée
Costruzione avanzata
Geavanceerd bouwen
Construcción avanzada
Byg avanceret
Tähtäville rakentajalle
Bygg avancerat
Construção Avançada
Eğilimli ve Karmaşık
Profiteknik



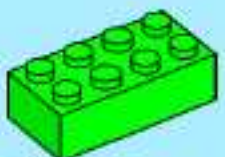

2x

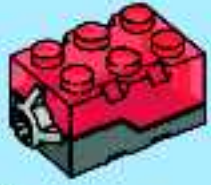

1x

6

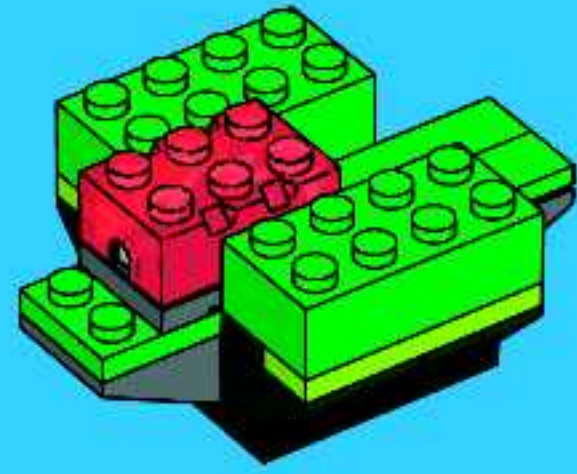

1x

1x

1x

1x

1x

7

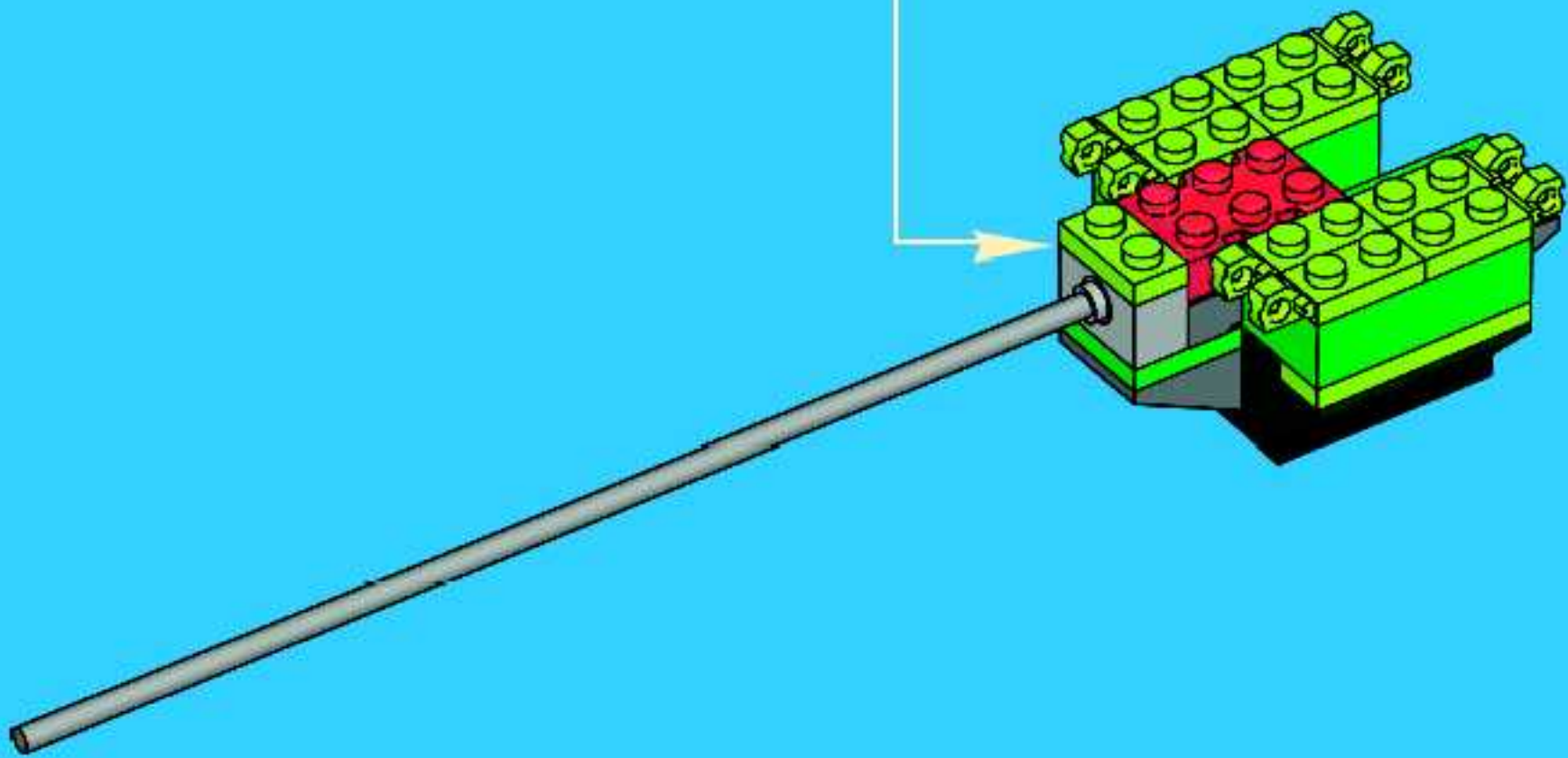
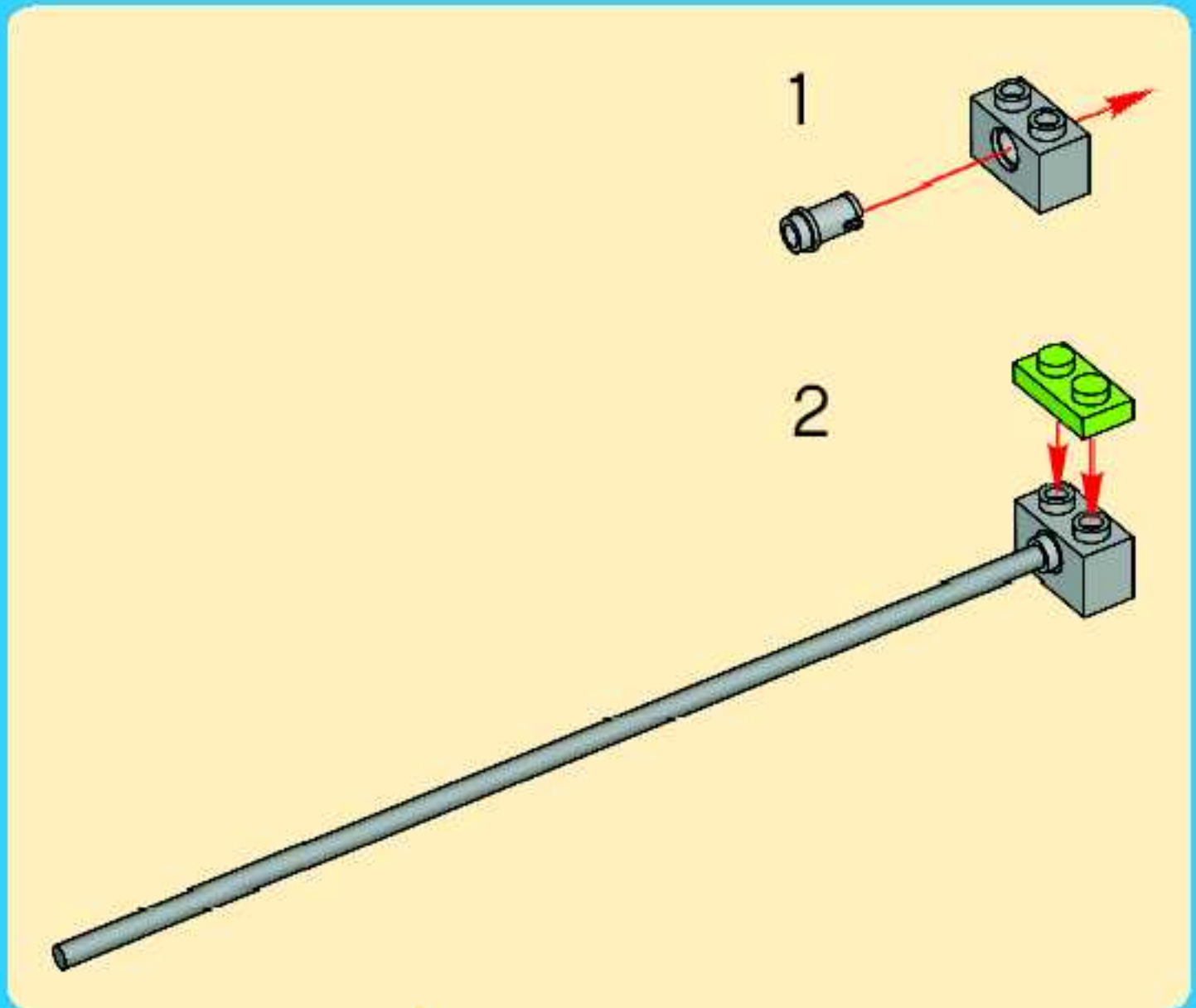

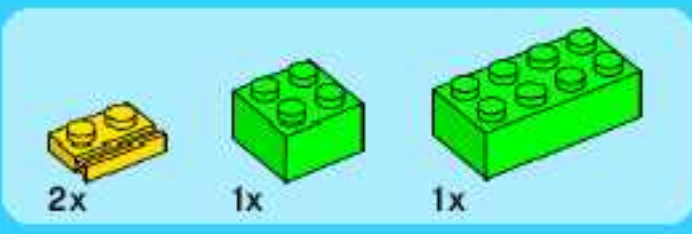

8

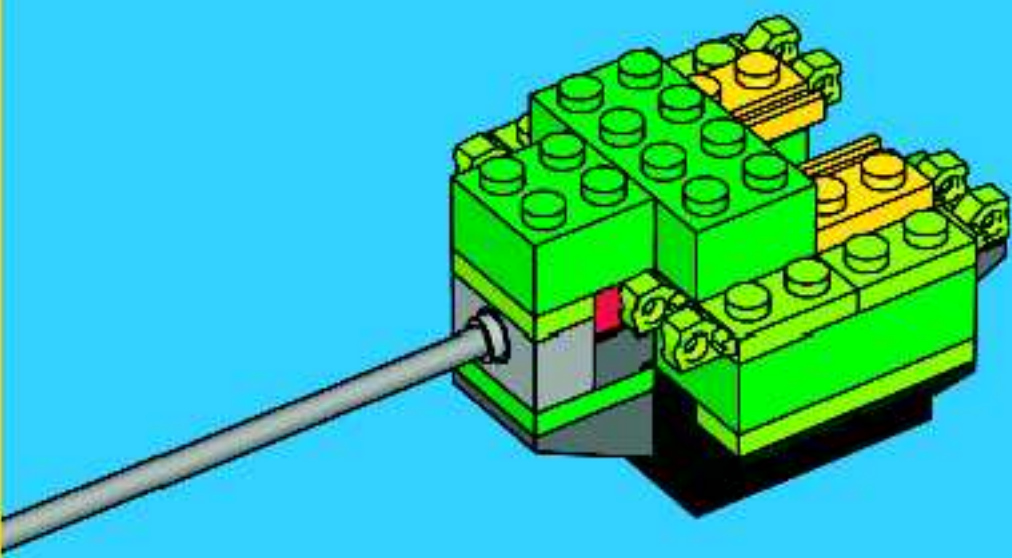

10

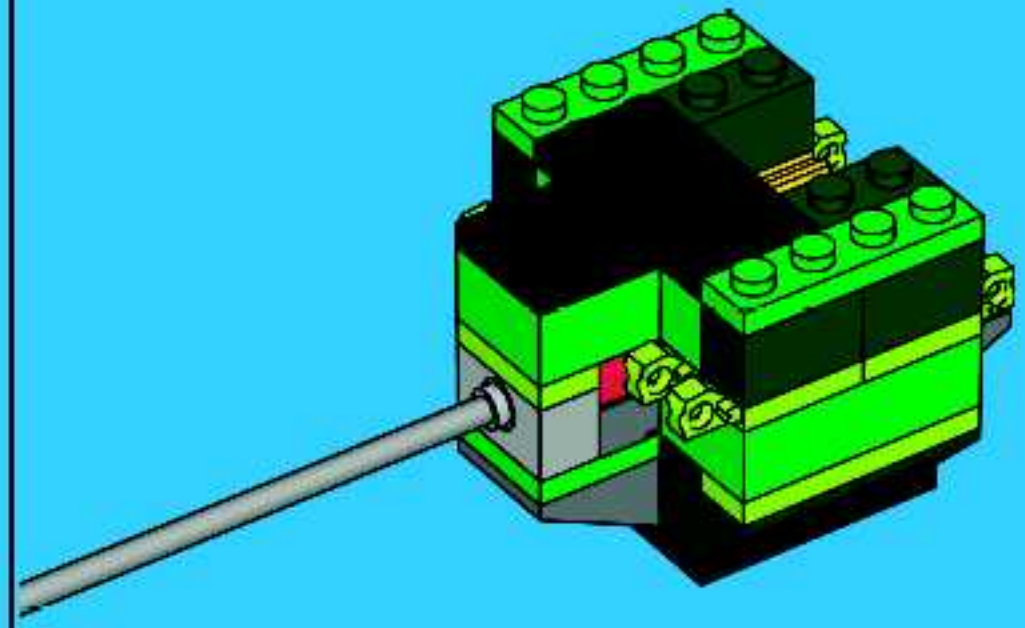

9

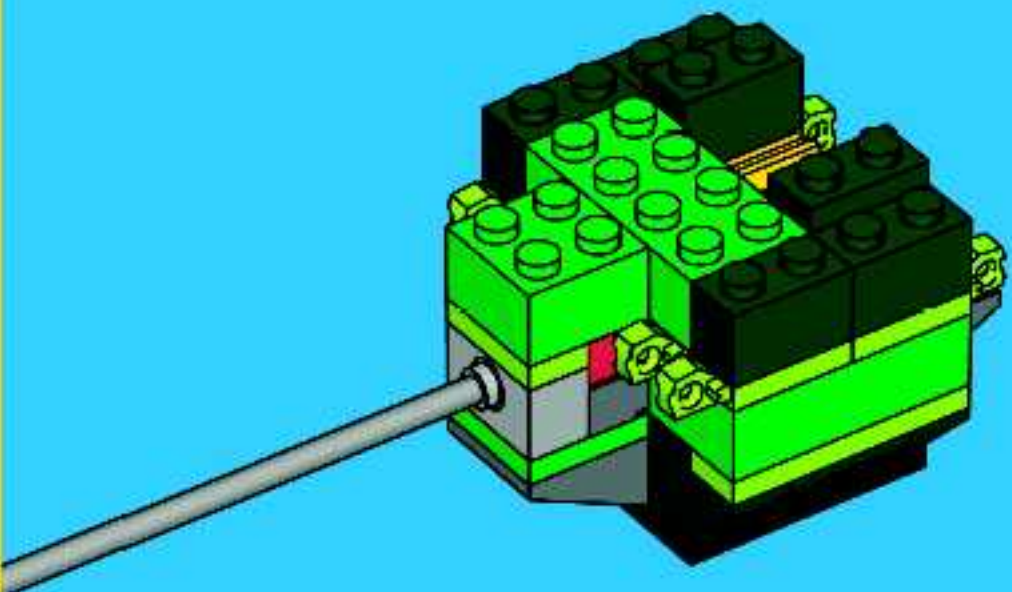

11

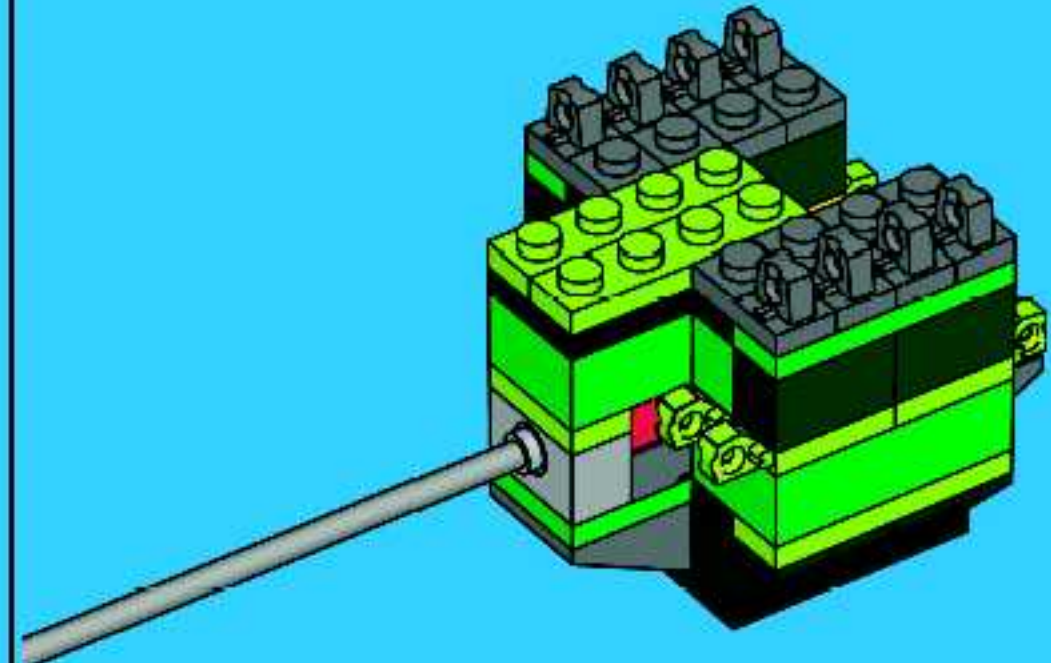



4x



1x

12

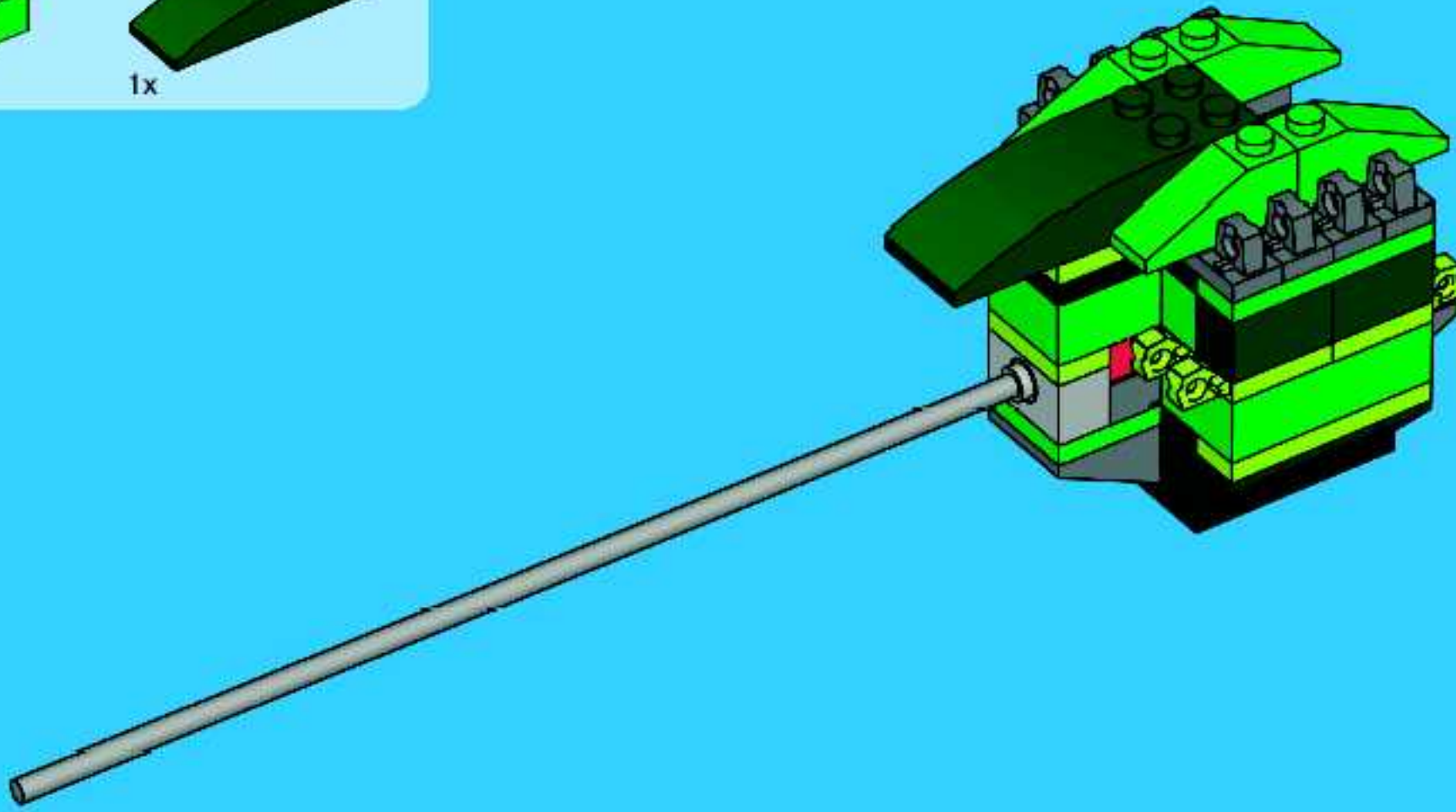

1x



2x

13

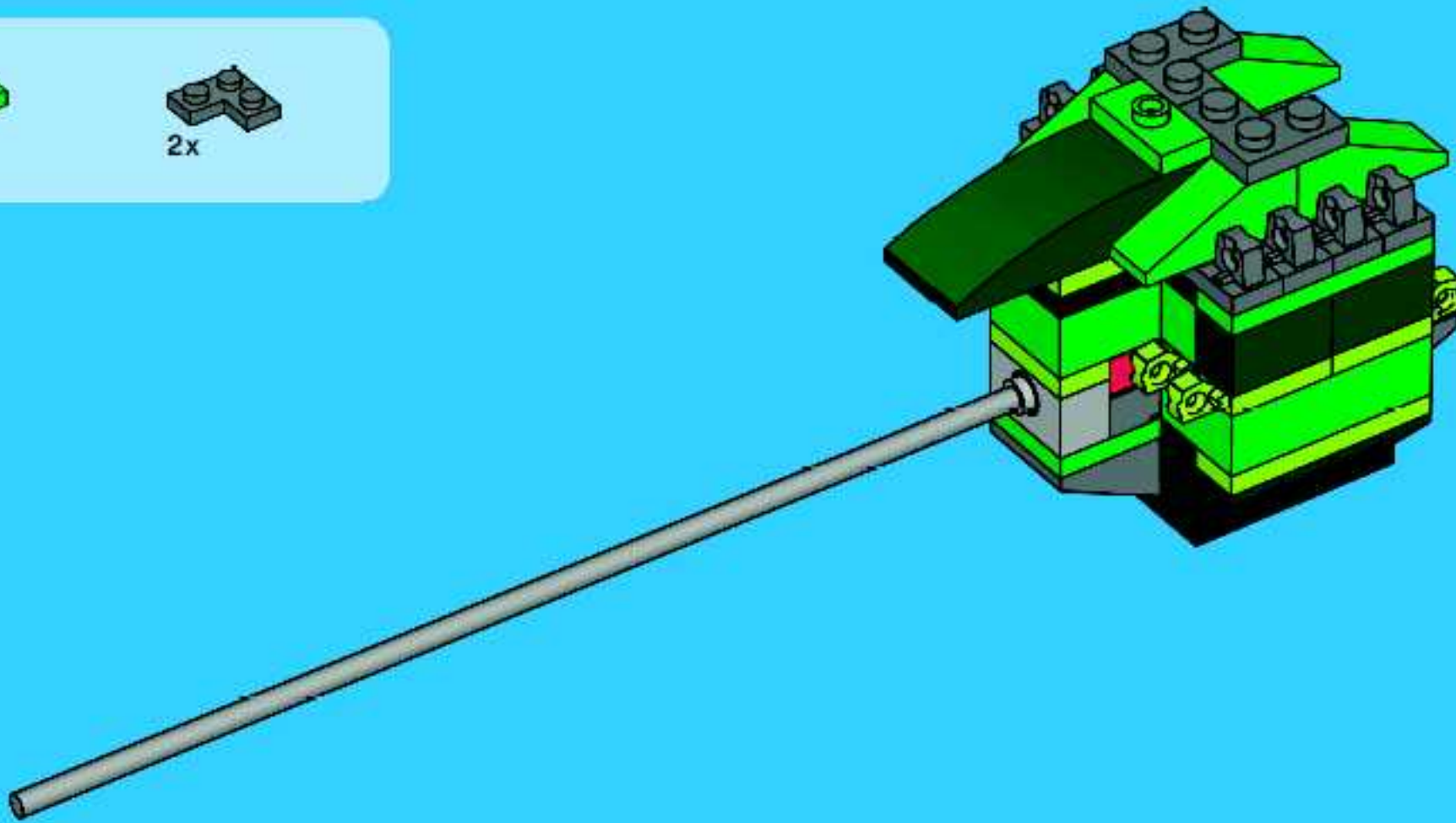

1x



1x

14

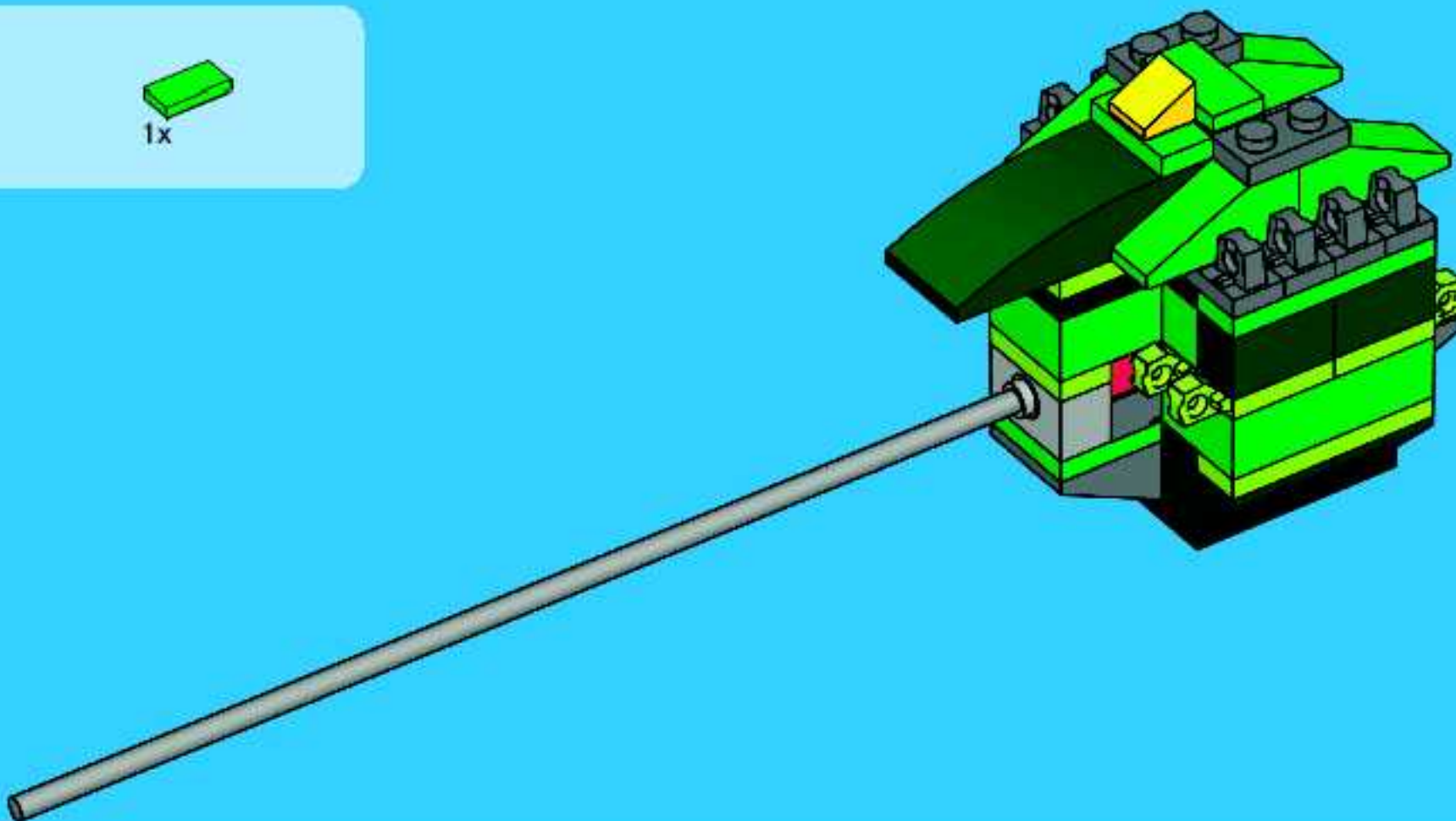

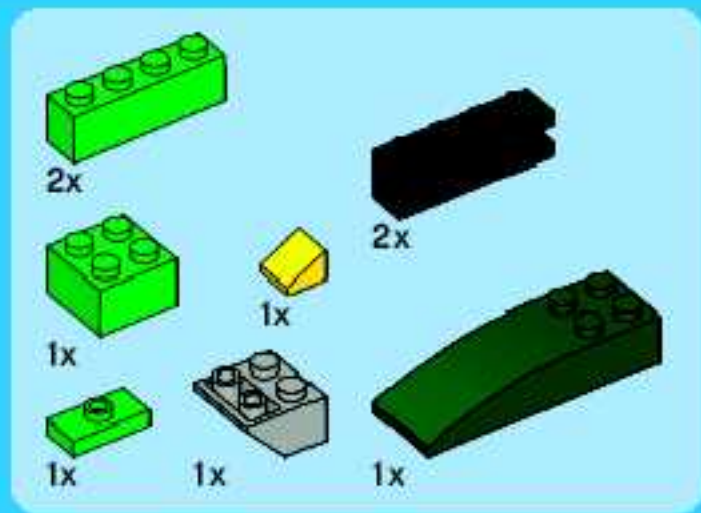

15

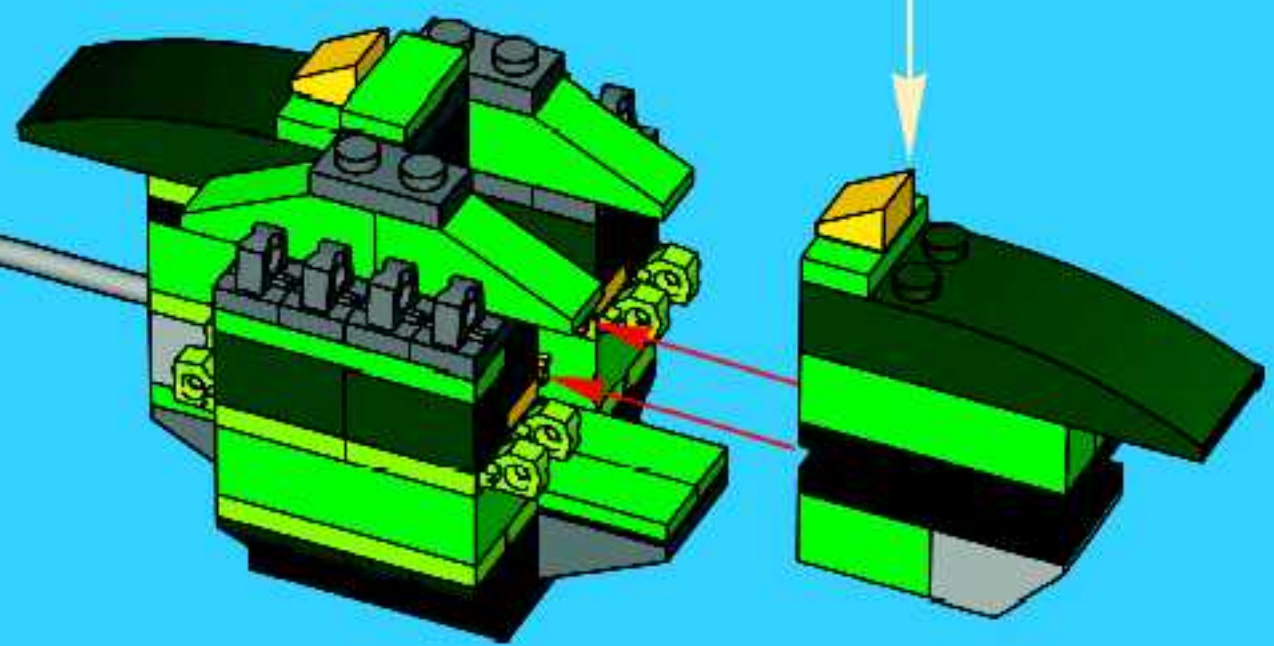
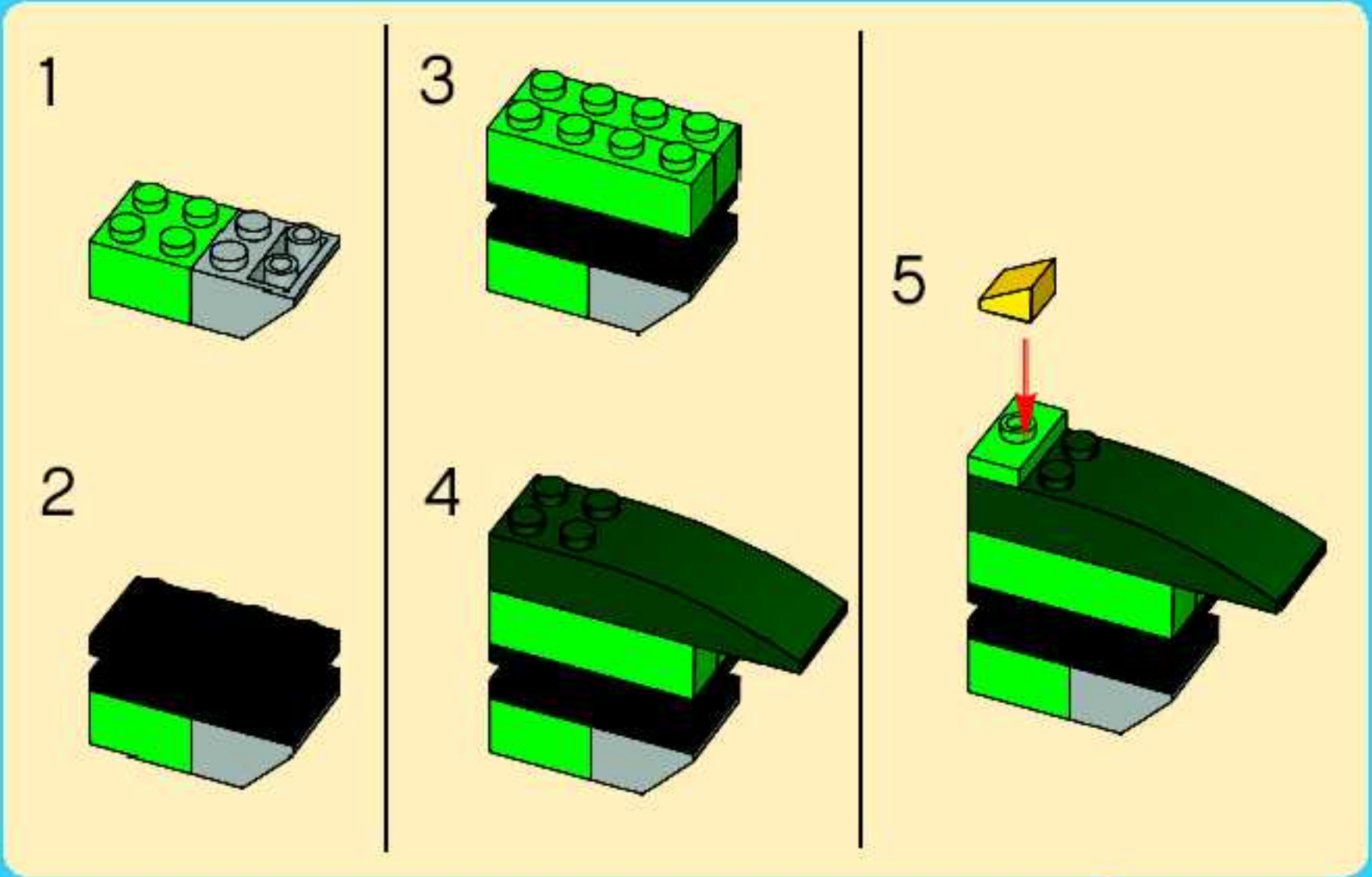

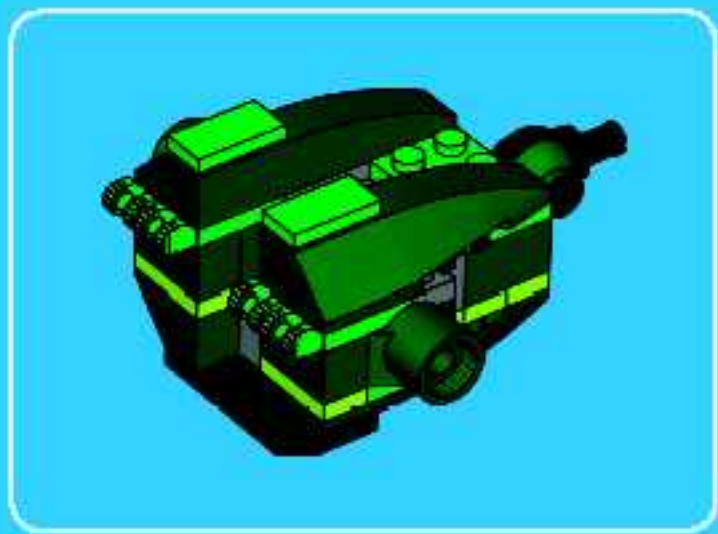

1

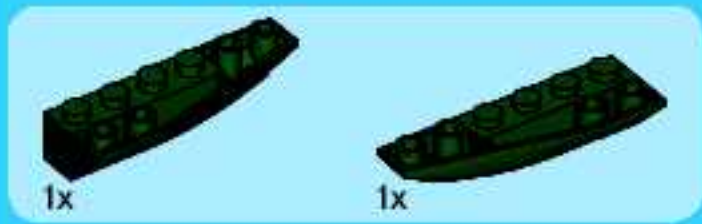
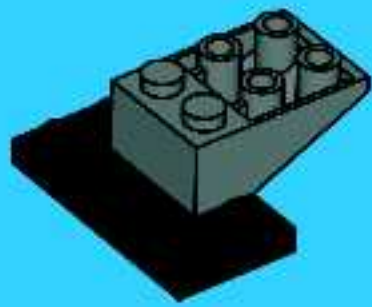

2

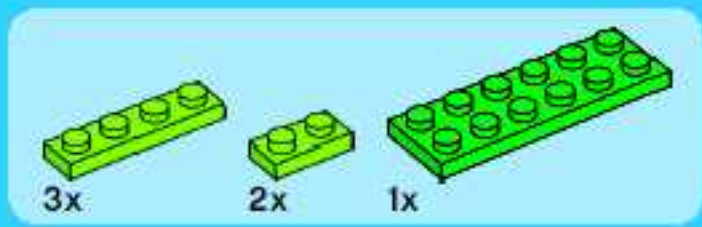
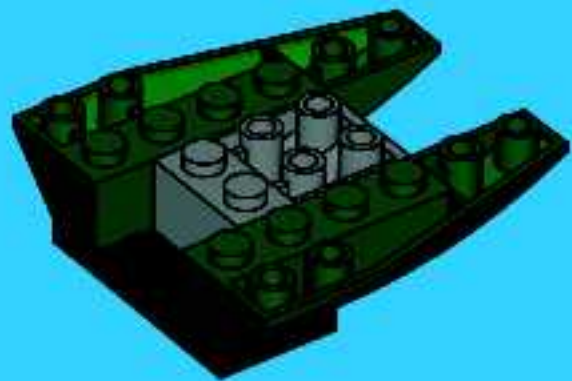

3

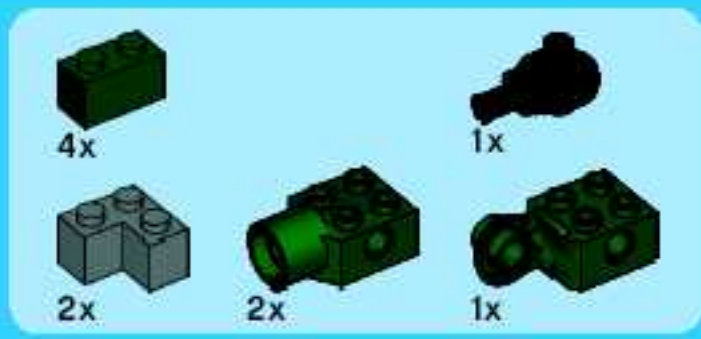
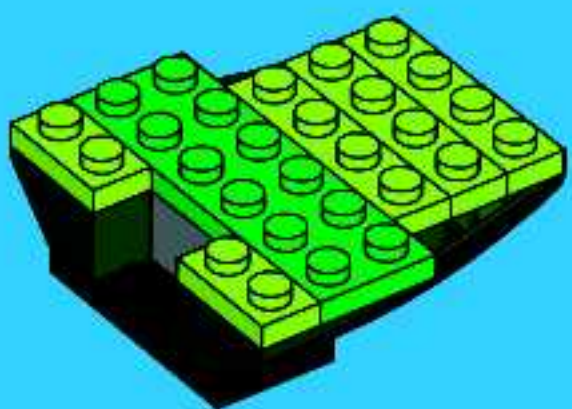

4

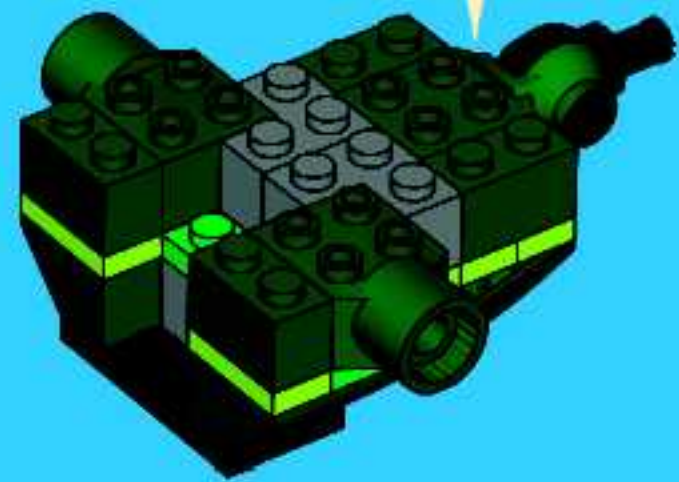

5

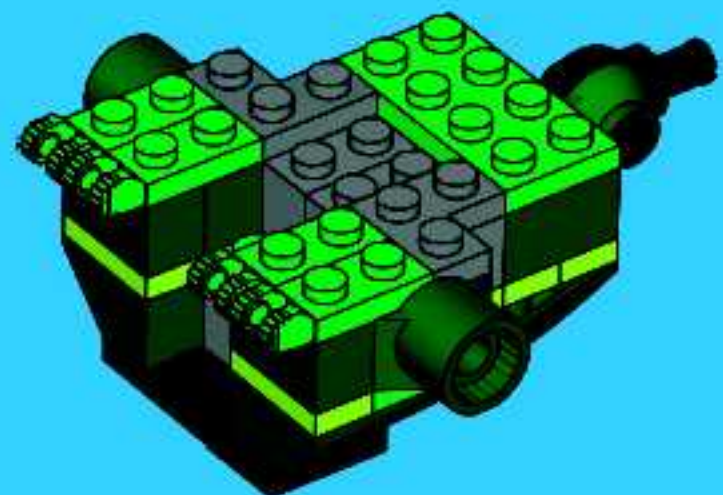

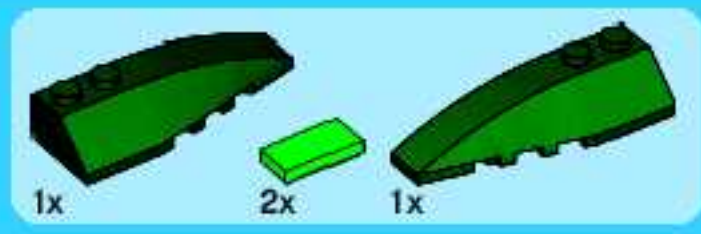

6

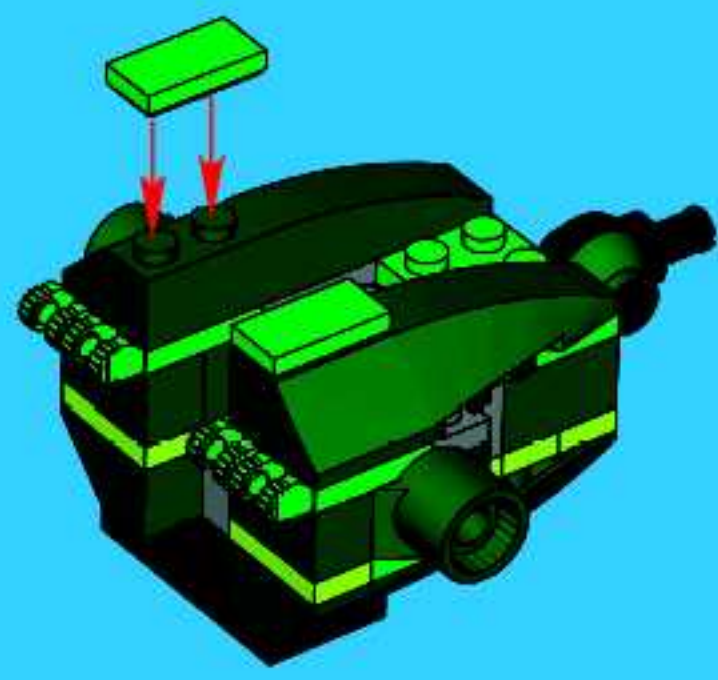

16

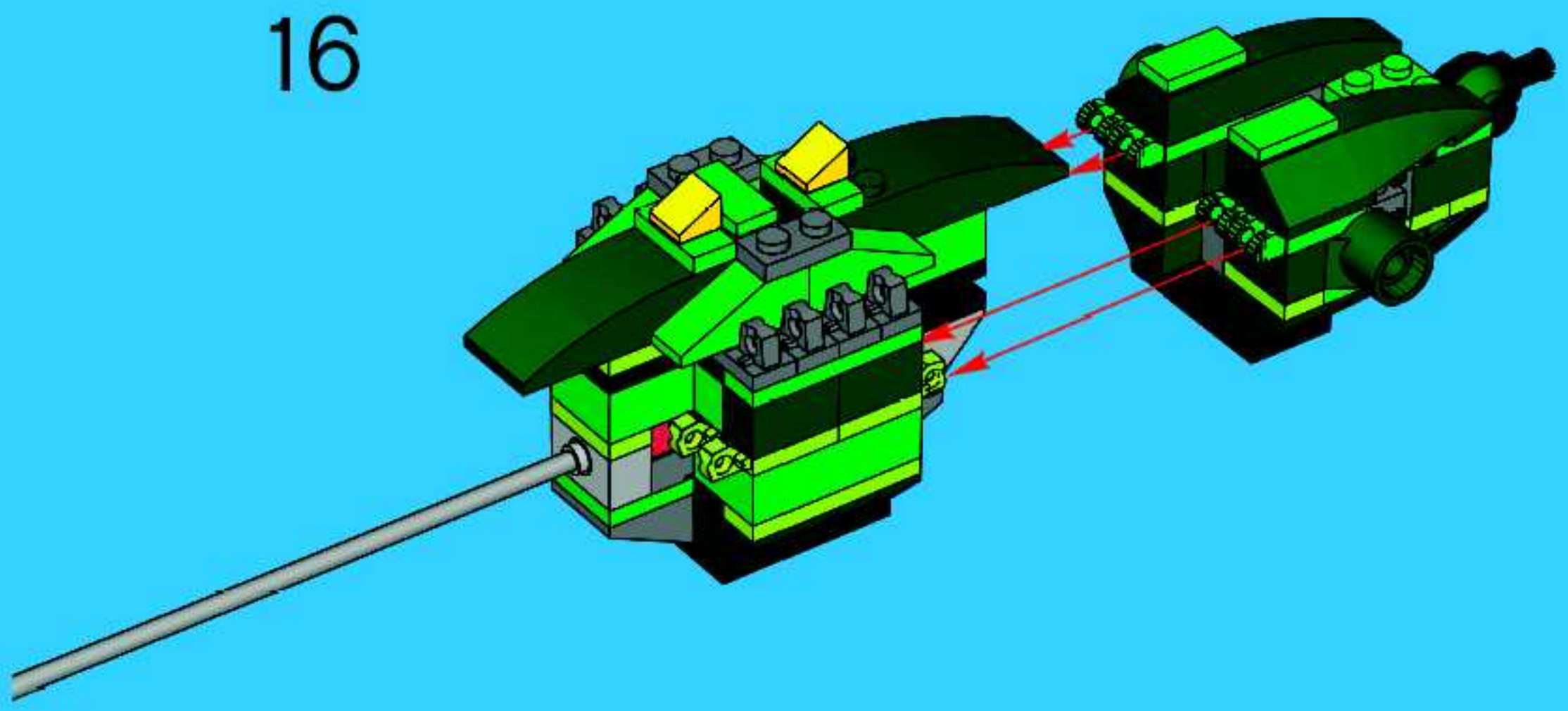

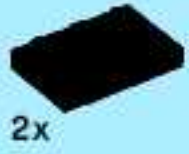

2x

1

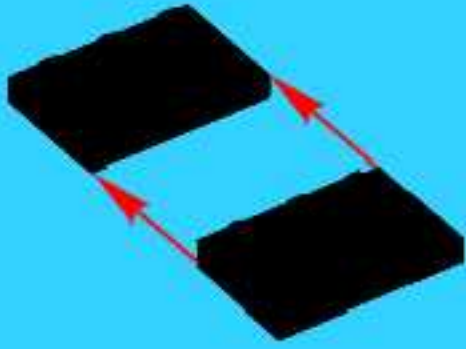

1x



1x

2

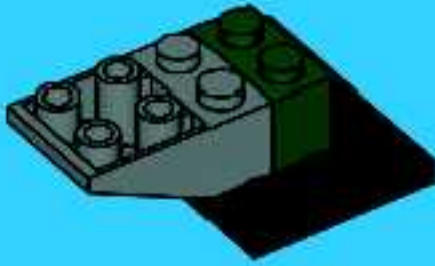

1x



2x



1x

3

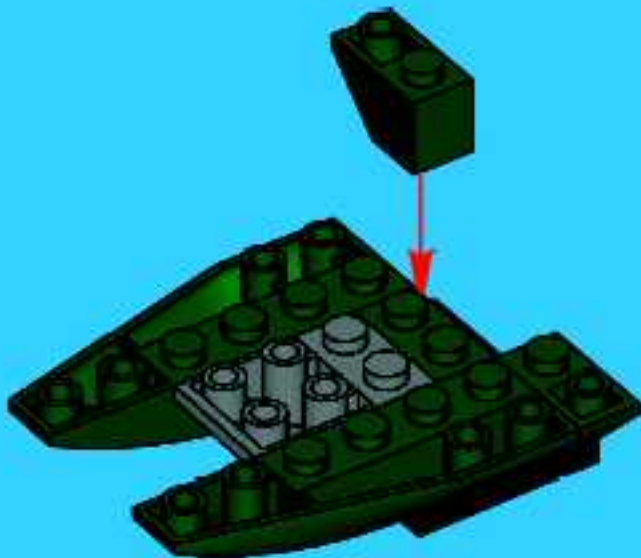

2x



1x



1x

4

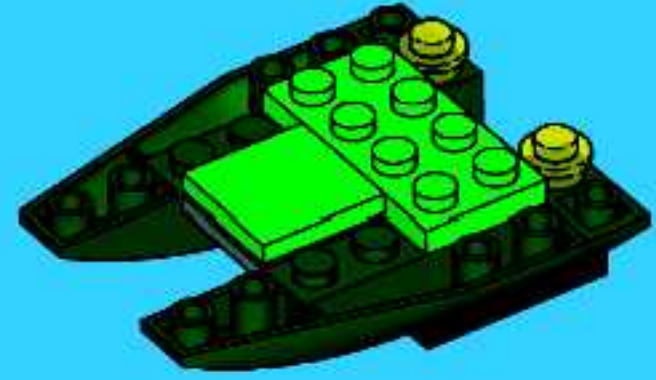

2x



2x



2x

5

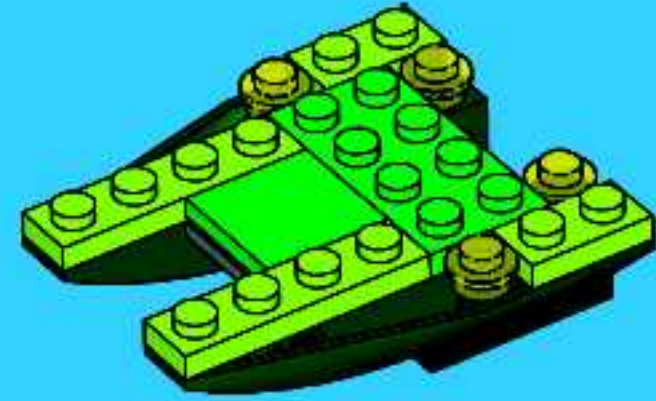

2x



2x



6x



2x

6

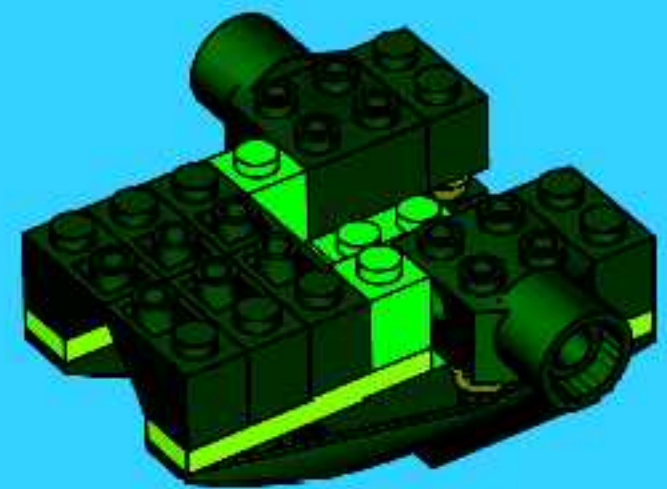



7

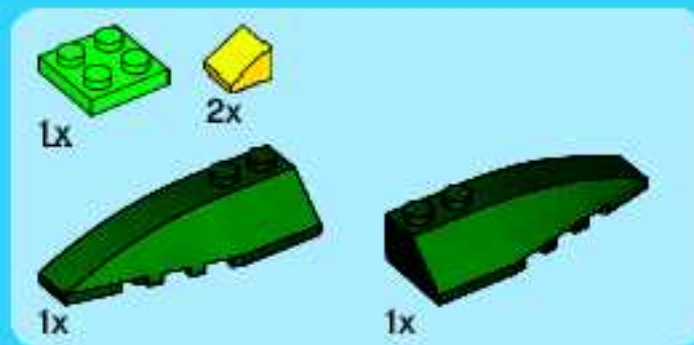
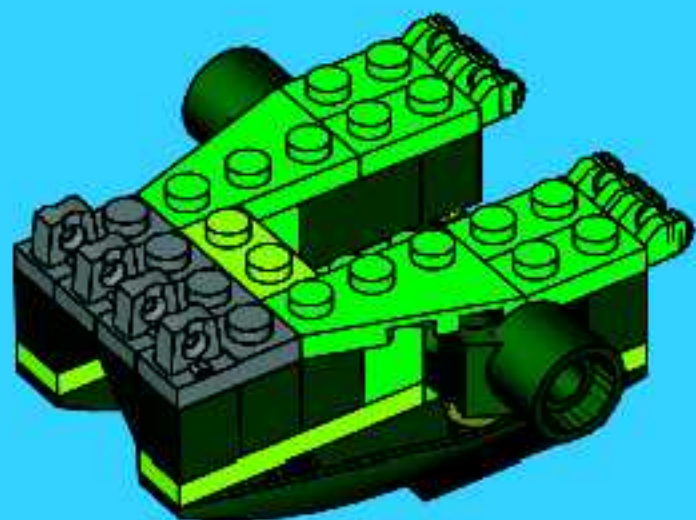

8

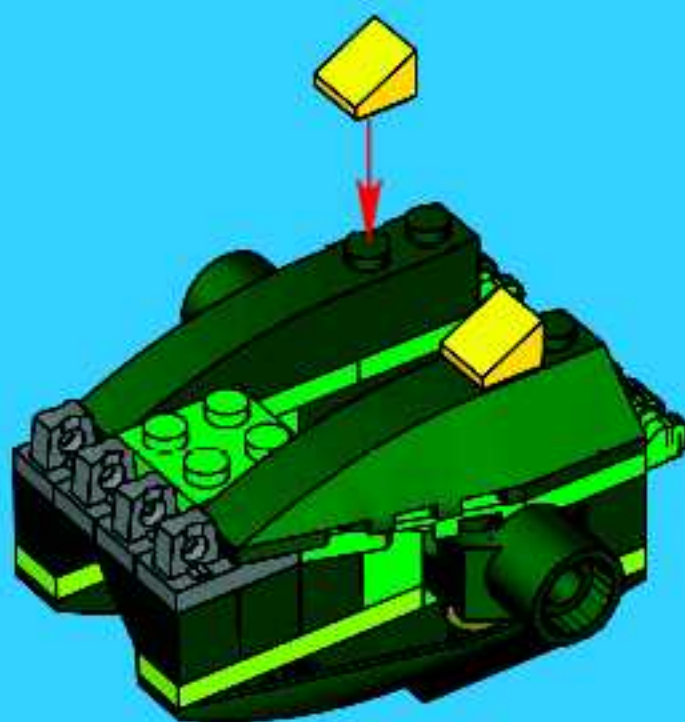

17

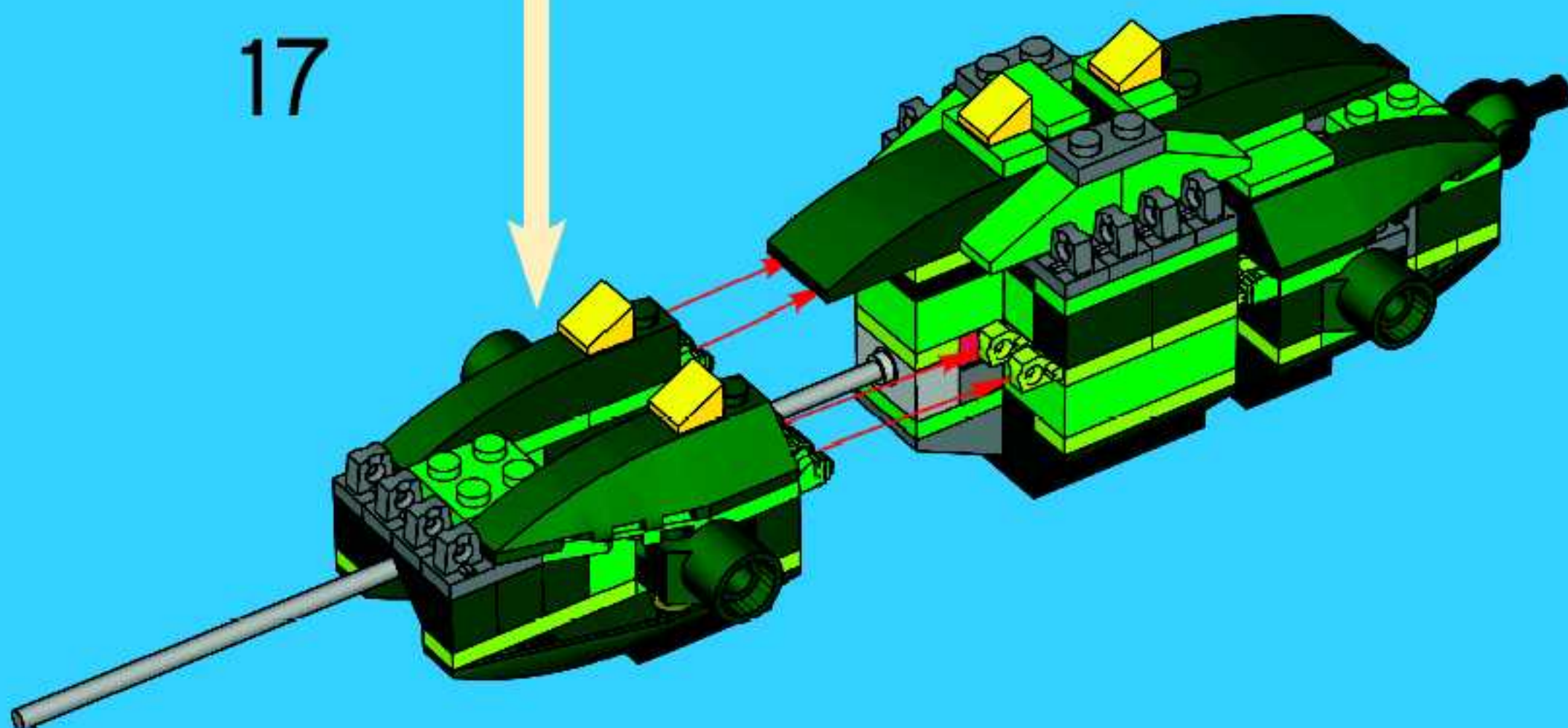

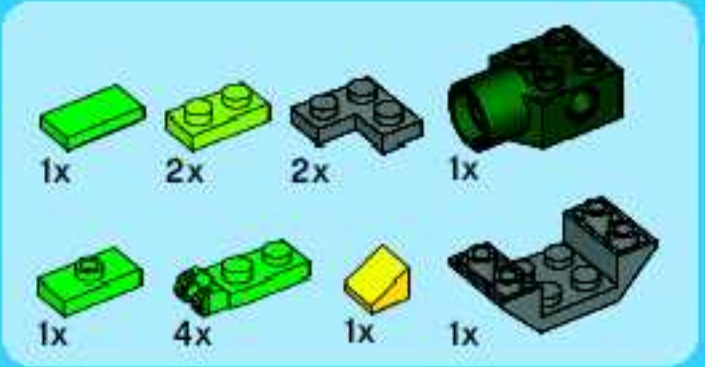

18

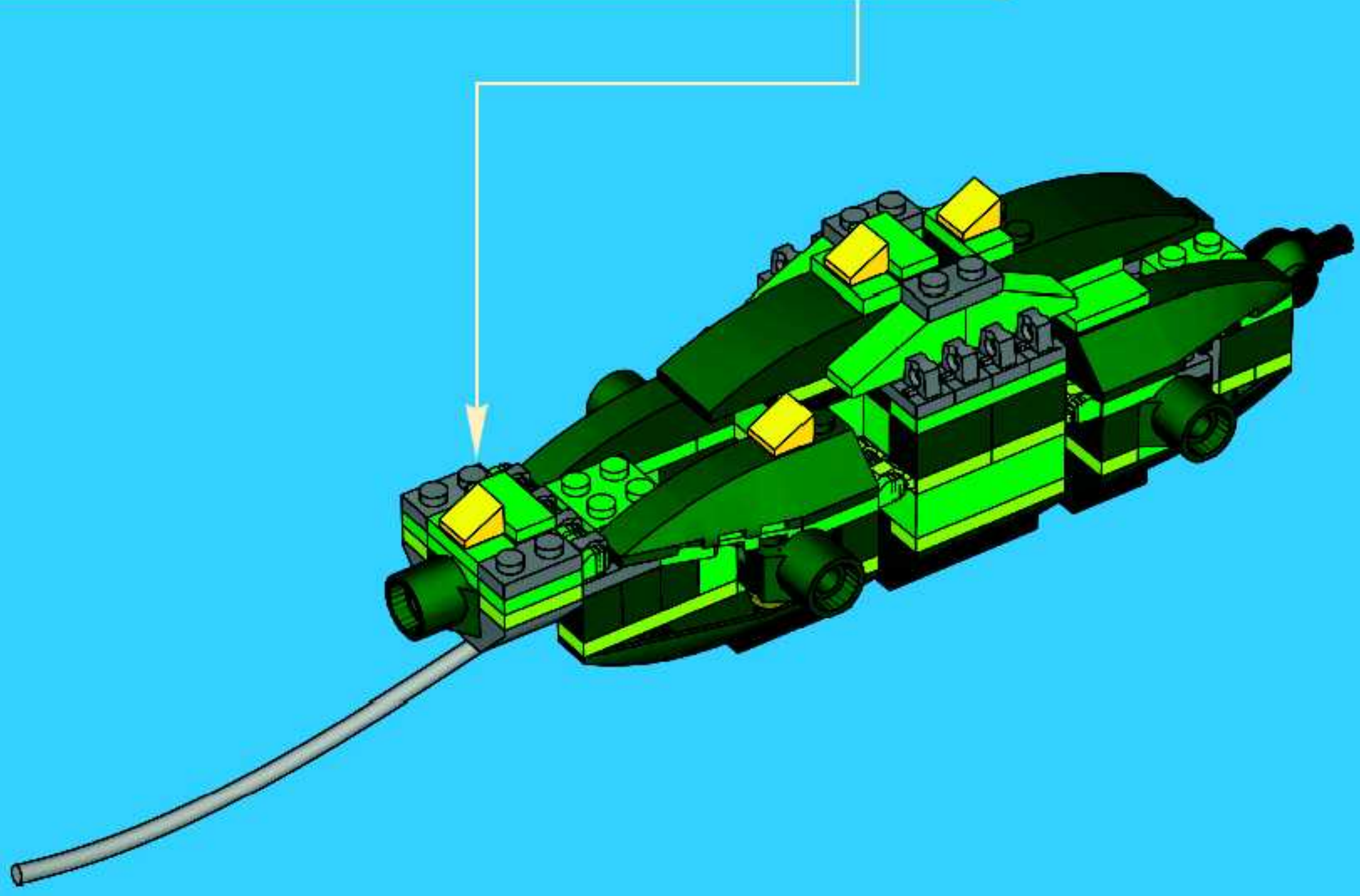
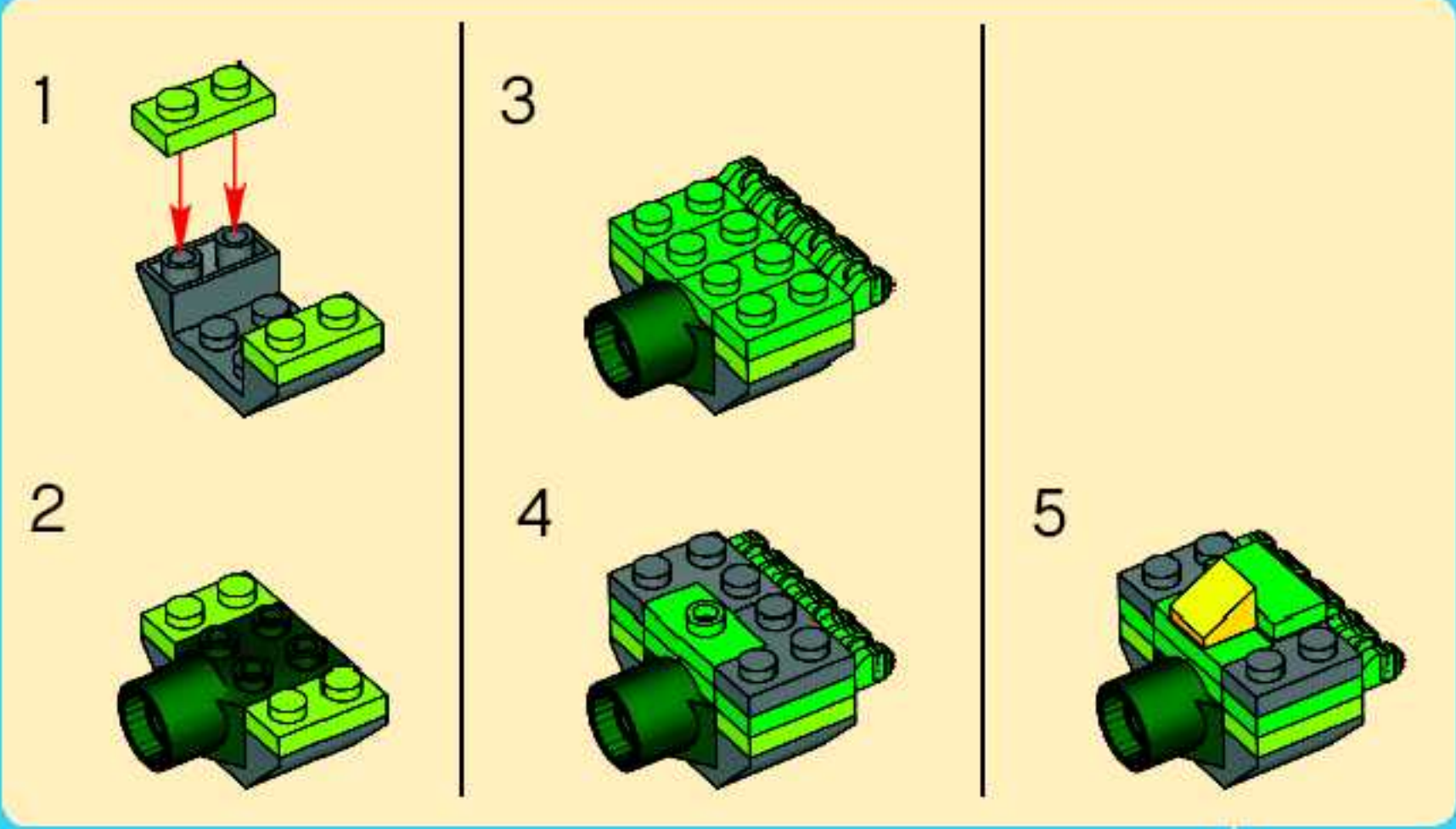

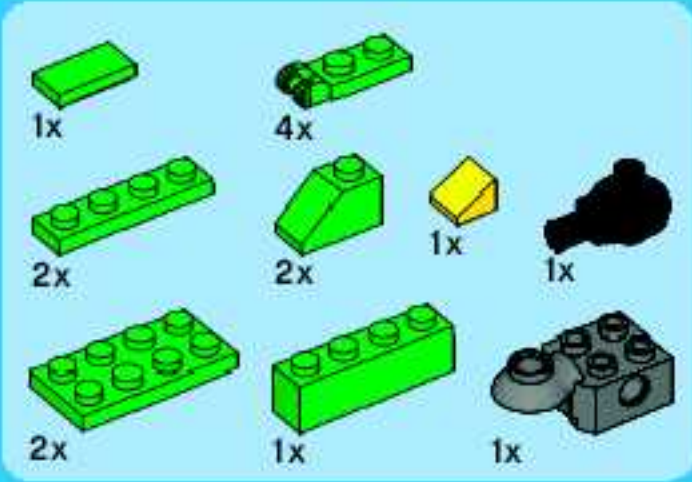

19

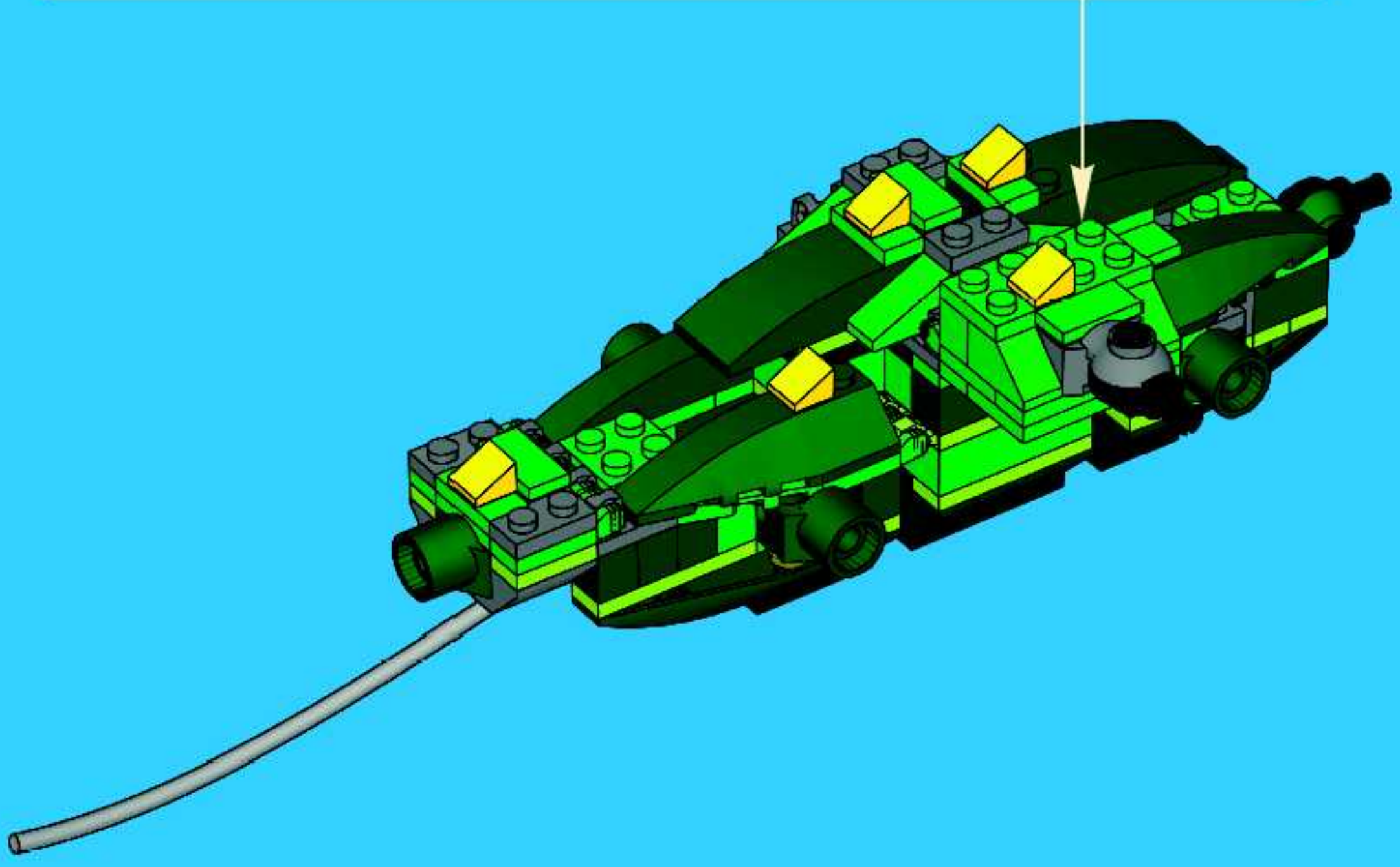
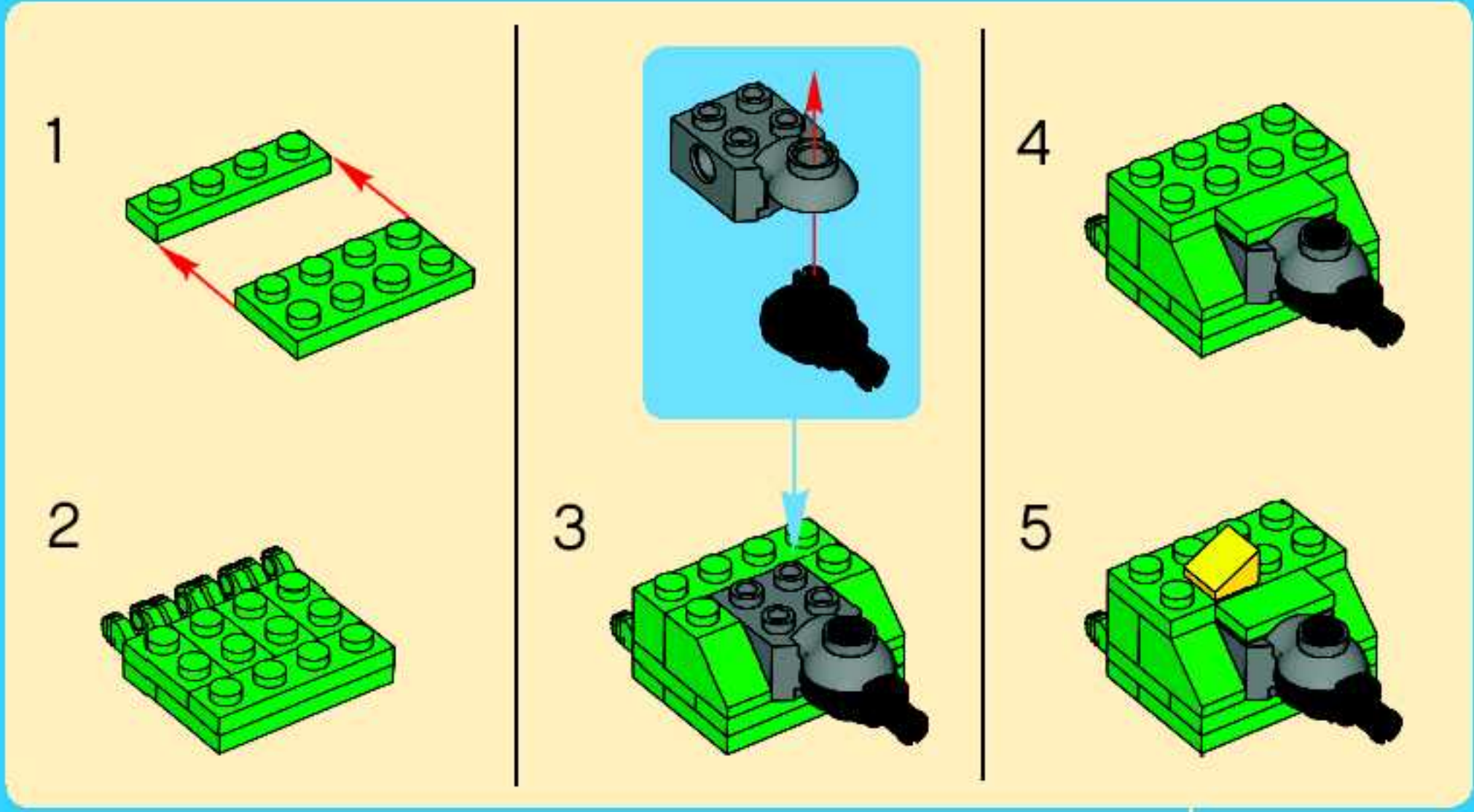

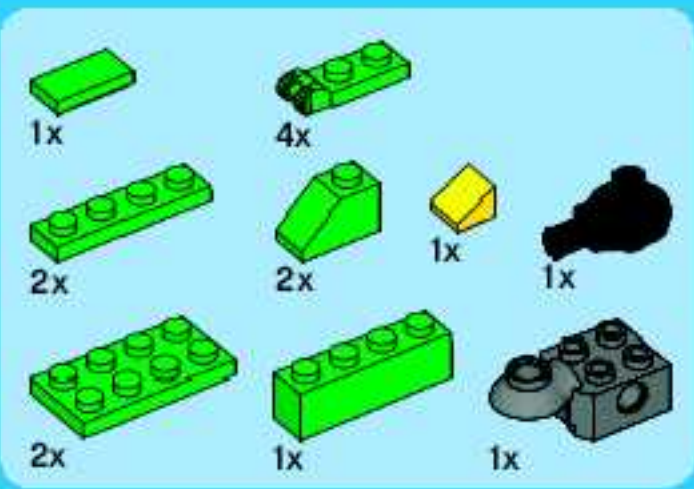

20

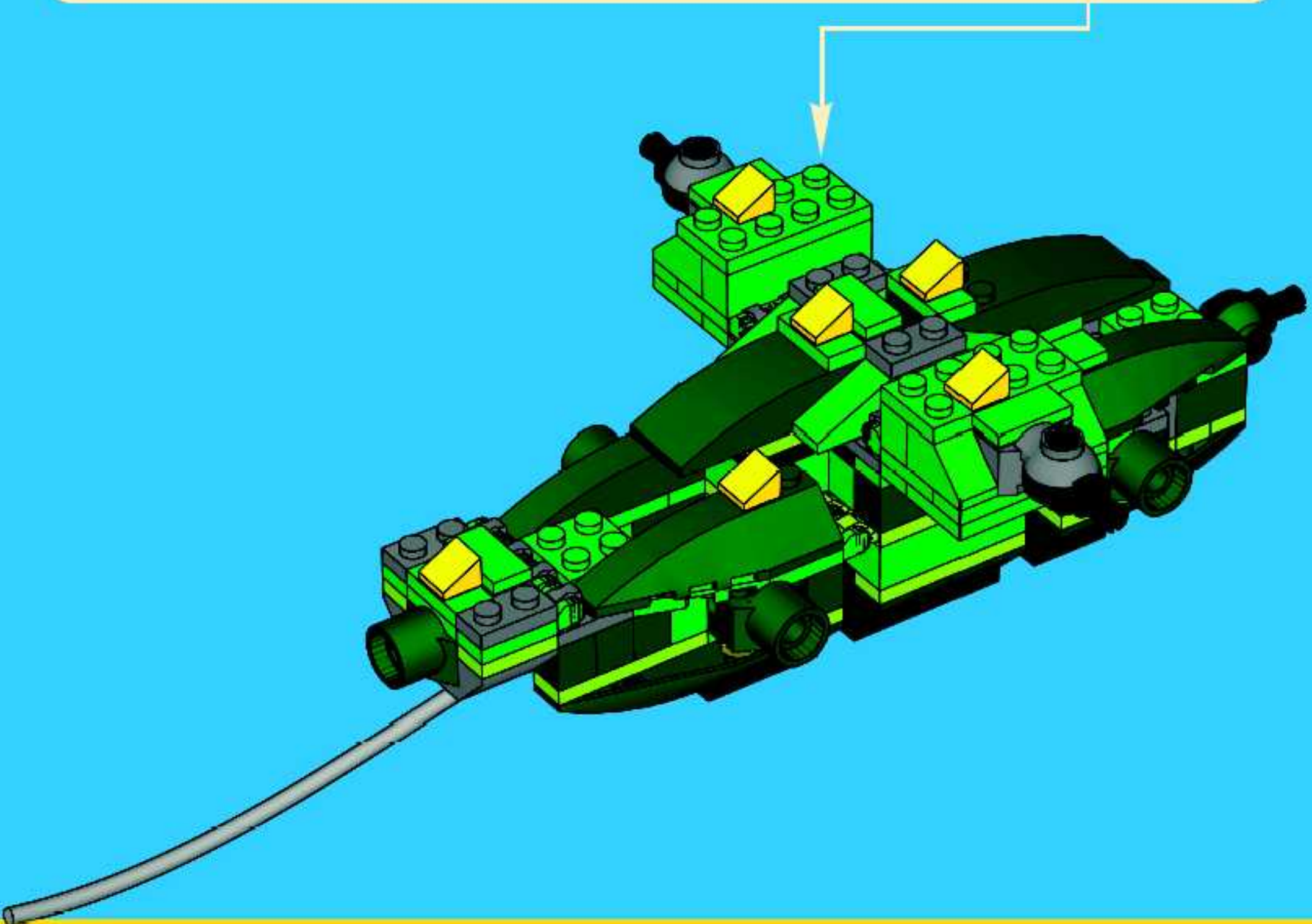
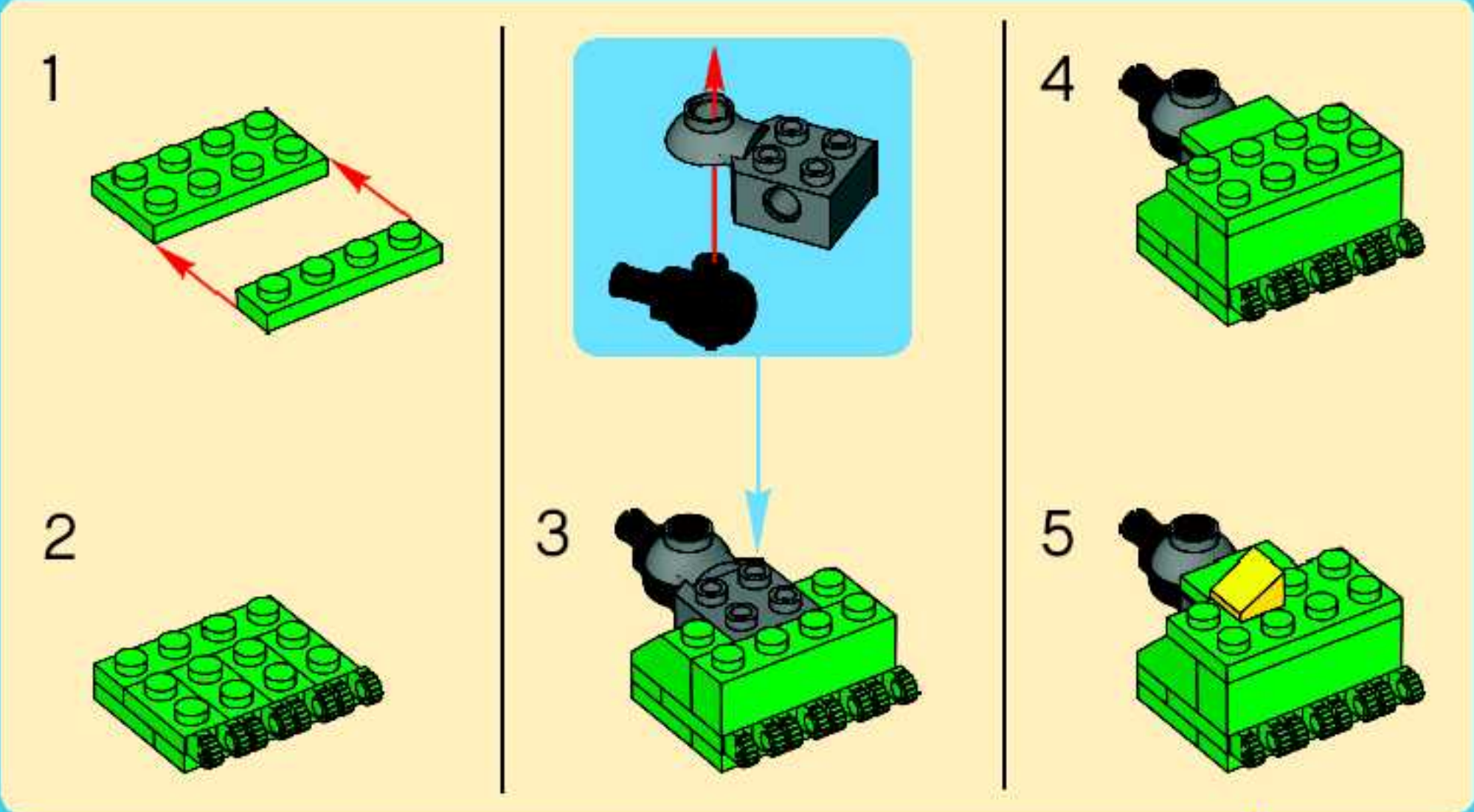

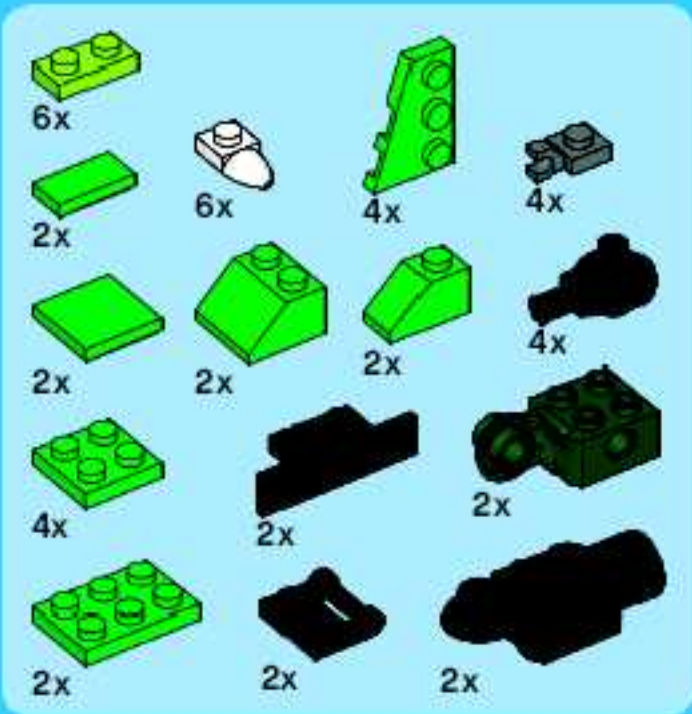
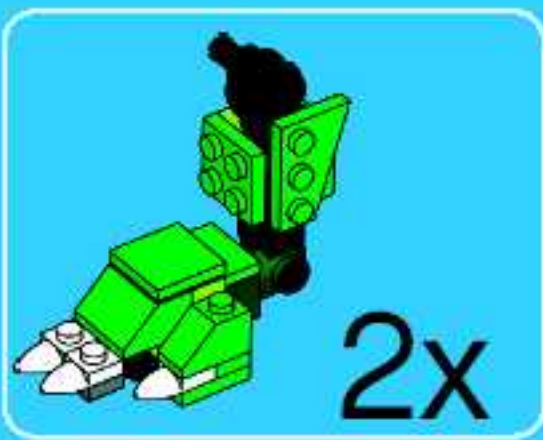

21

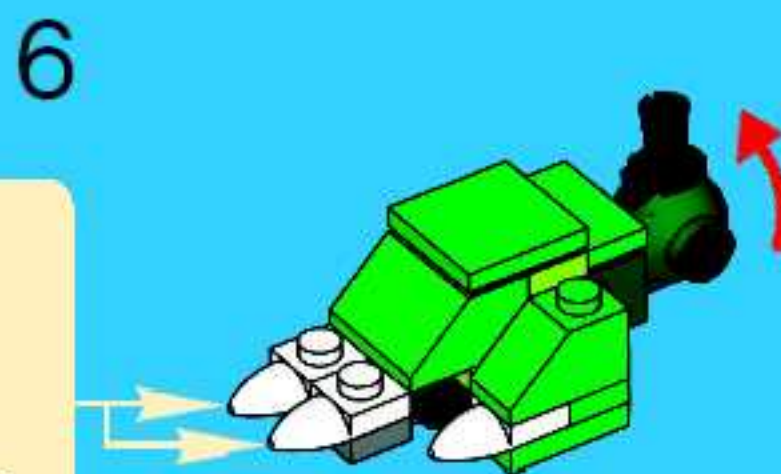
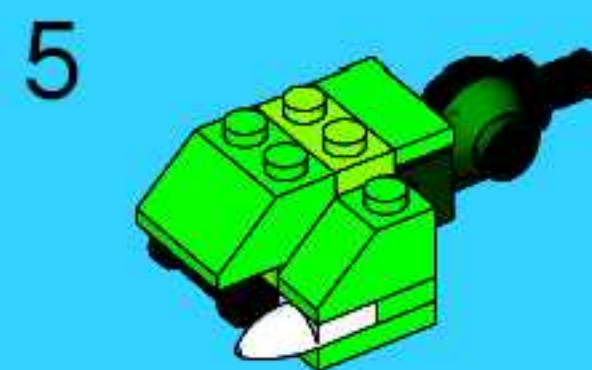
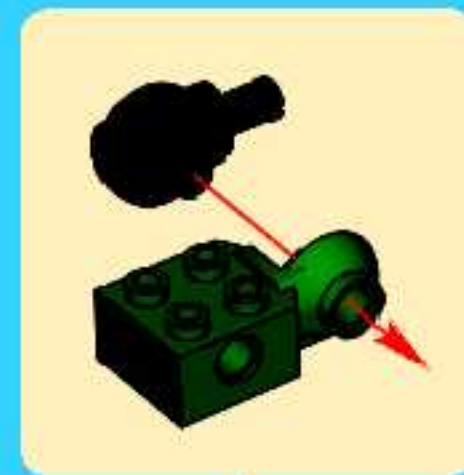
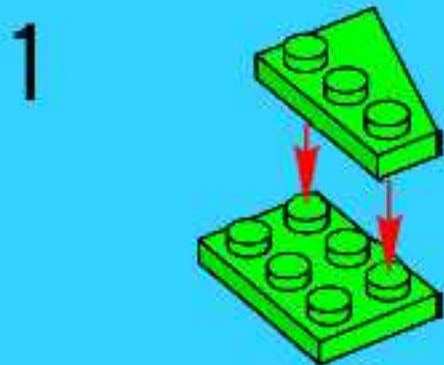

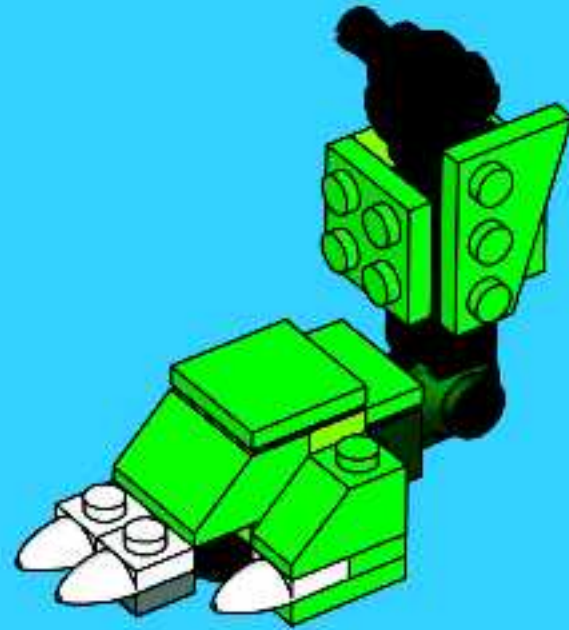
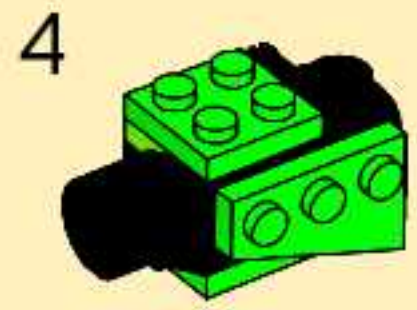
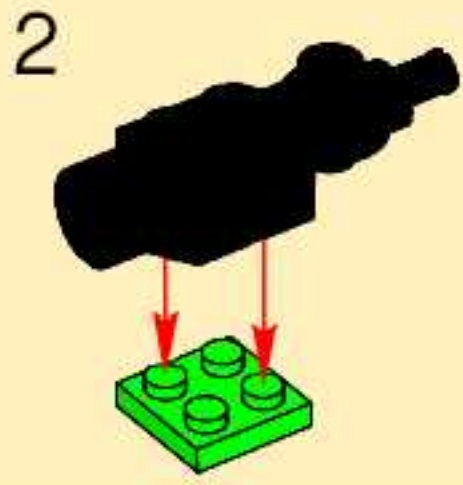
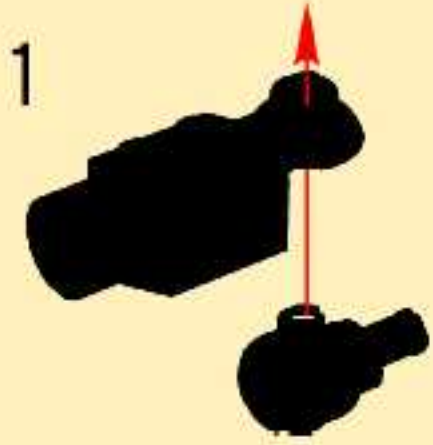

2x

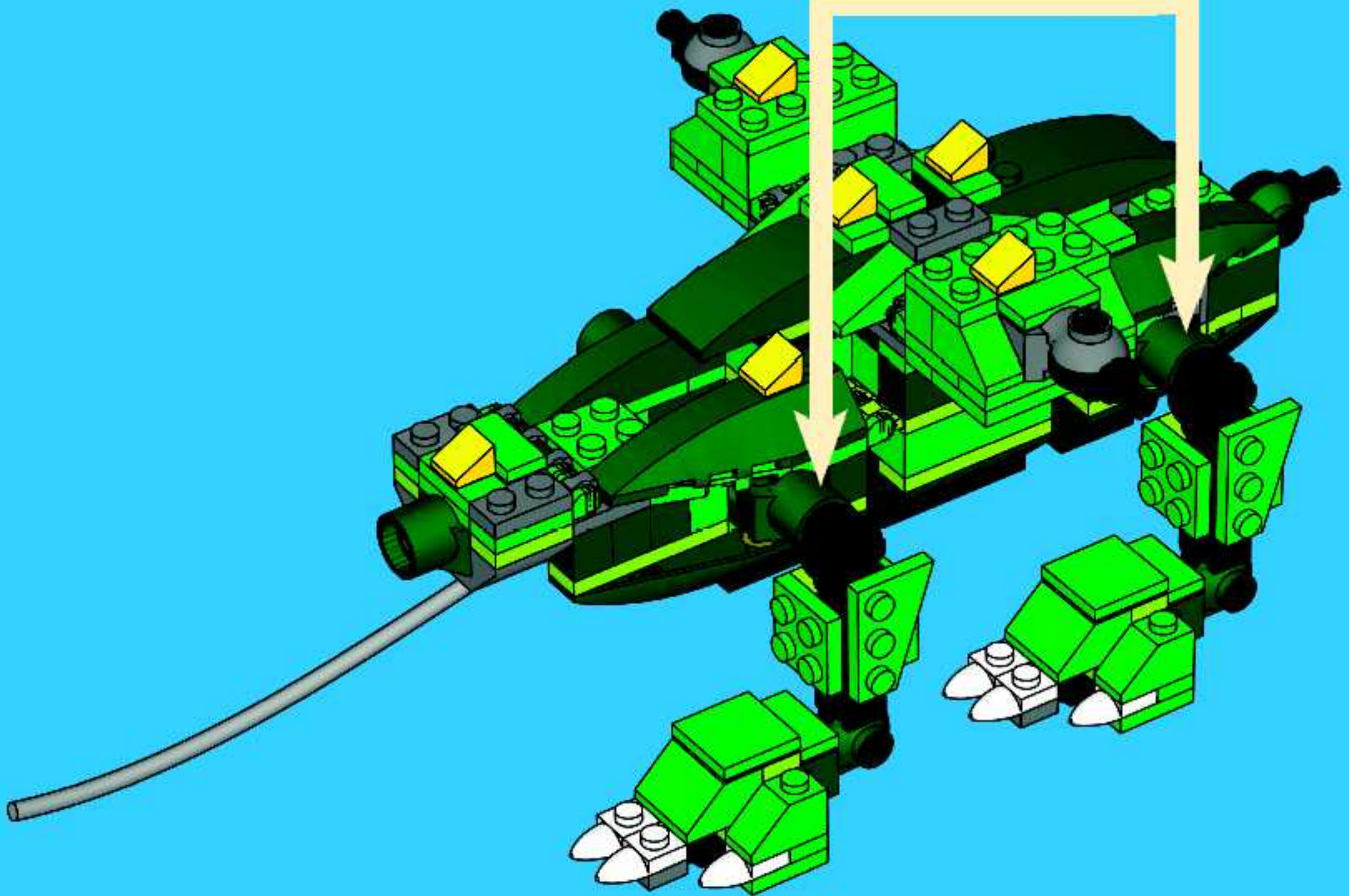

1



2

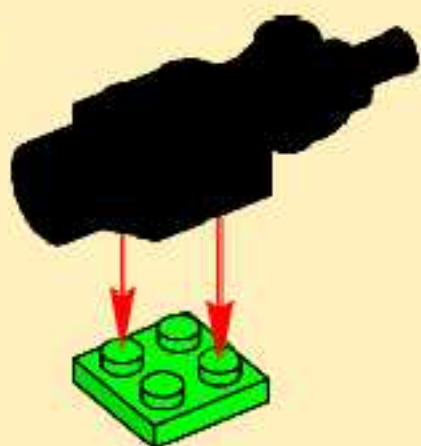

3

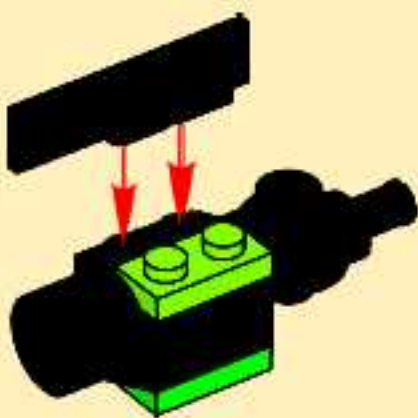

4

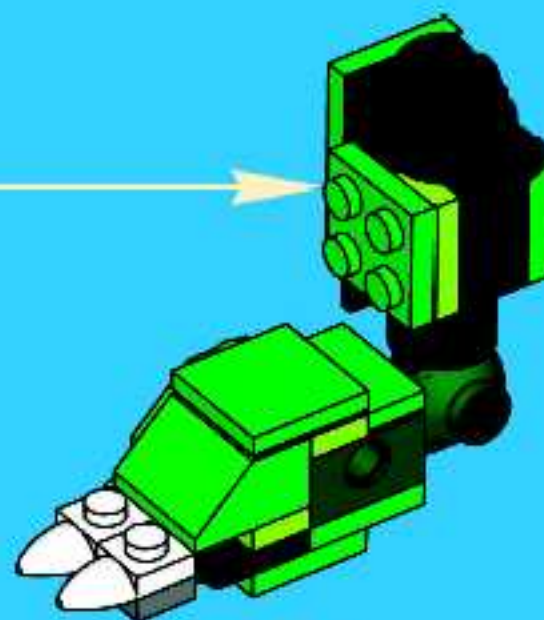
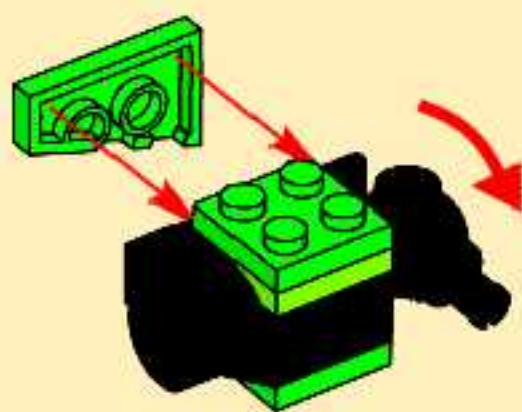

2x

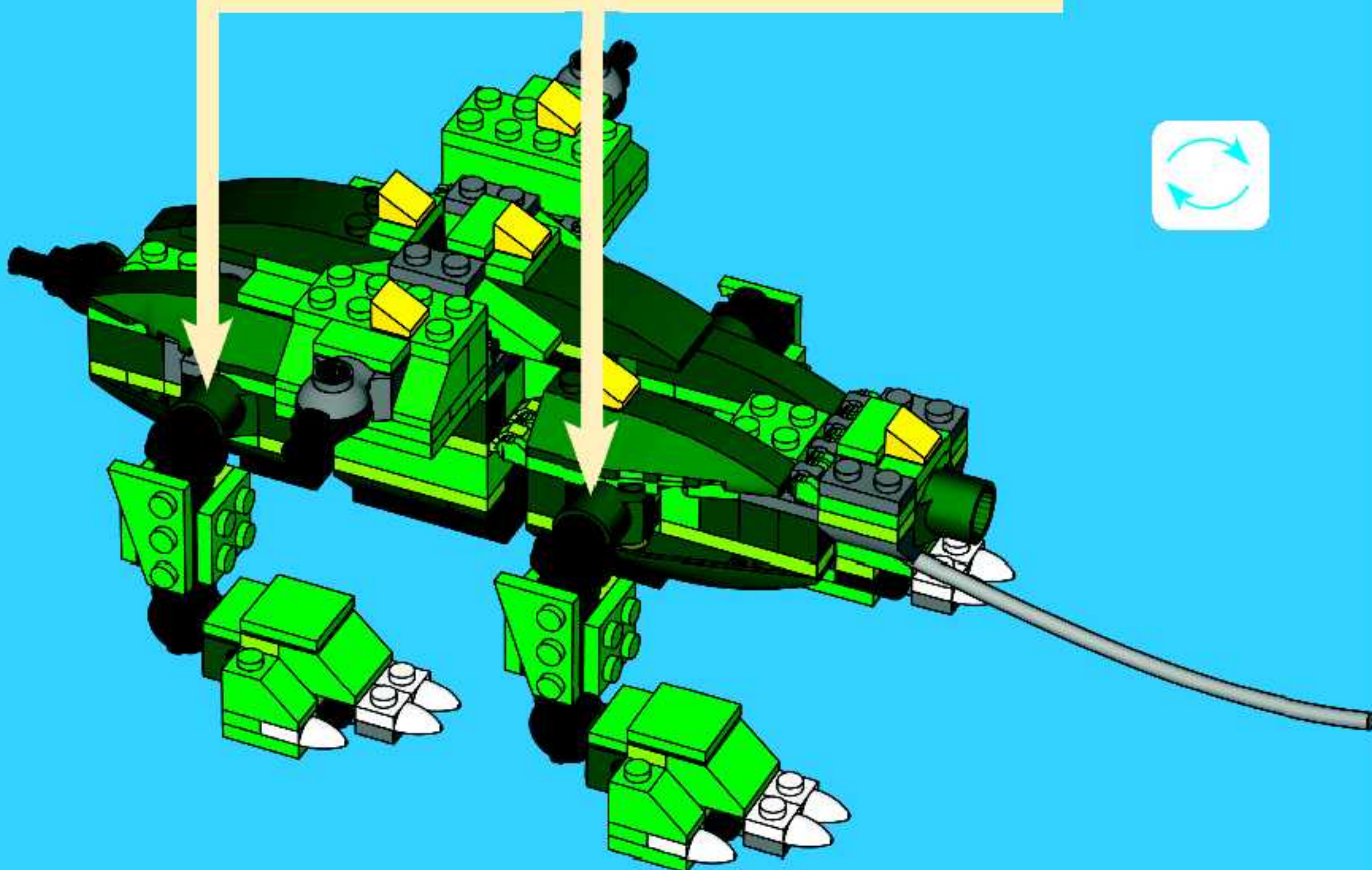

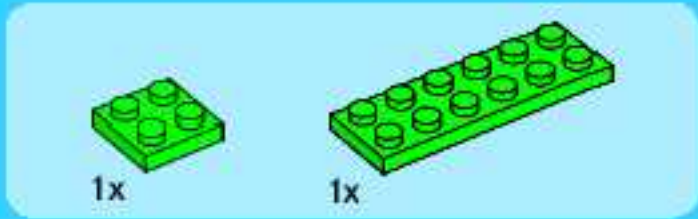
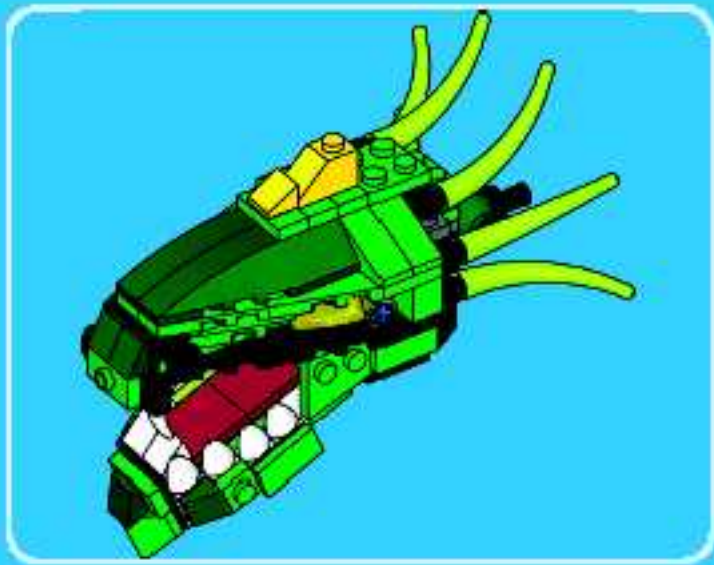

1

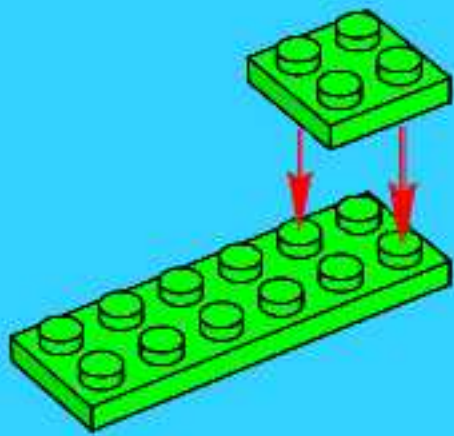

2

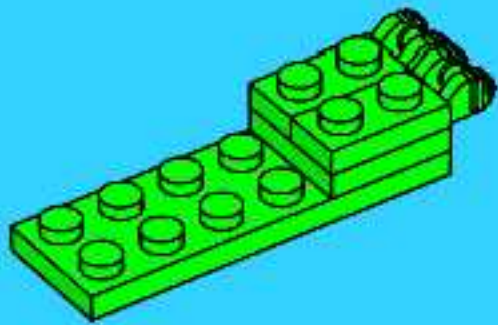

3

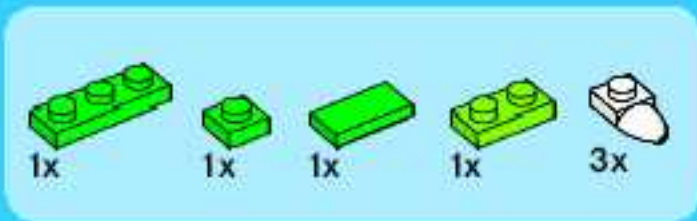
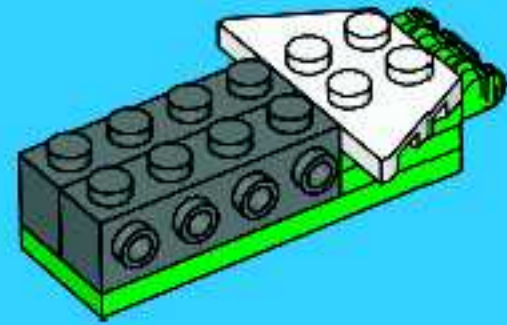

4

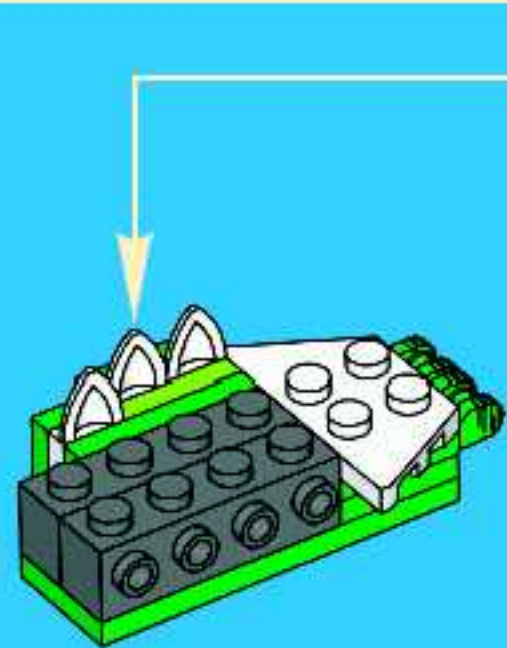
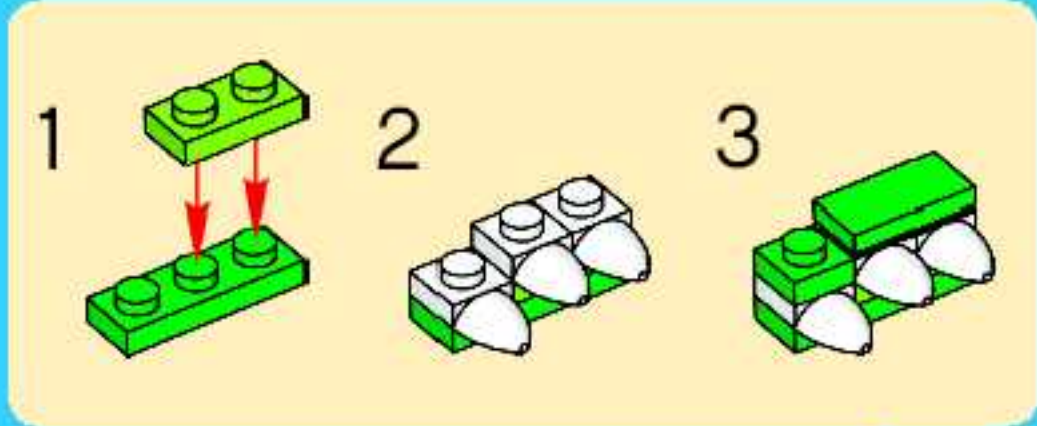

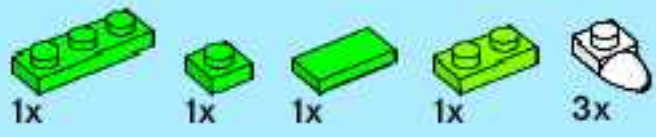

5

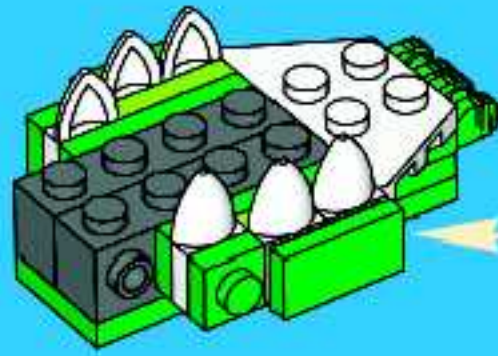
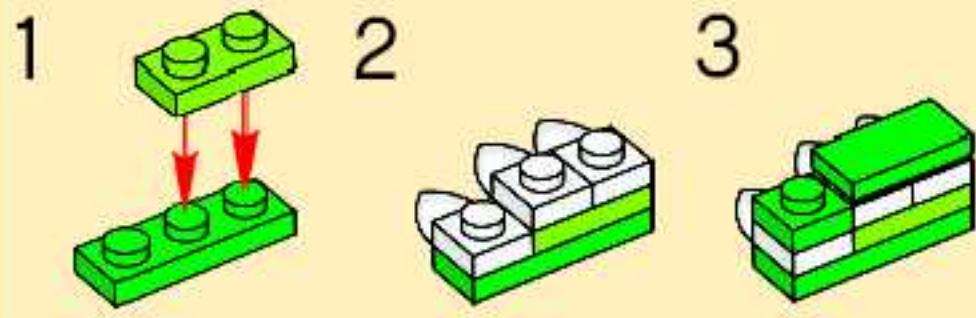

6

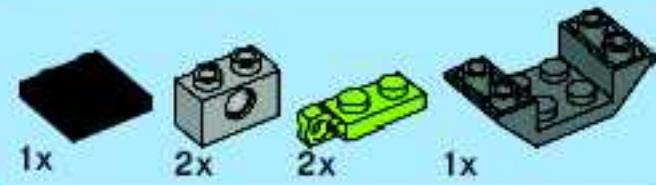
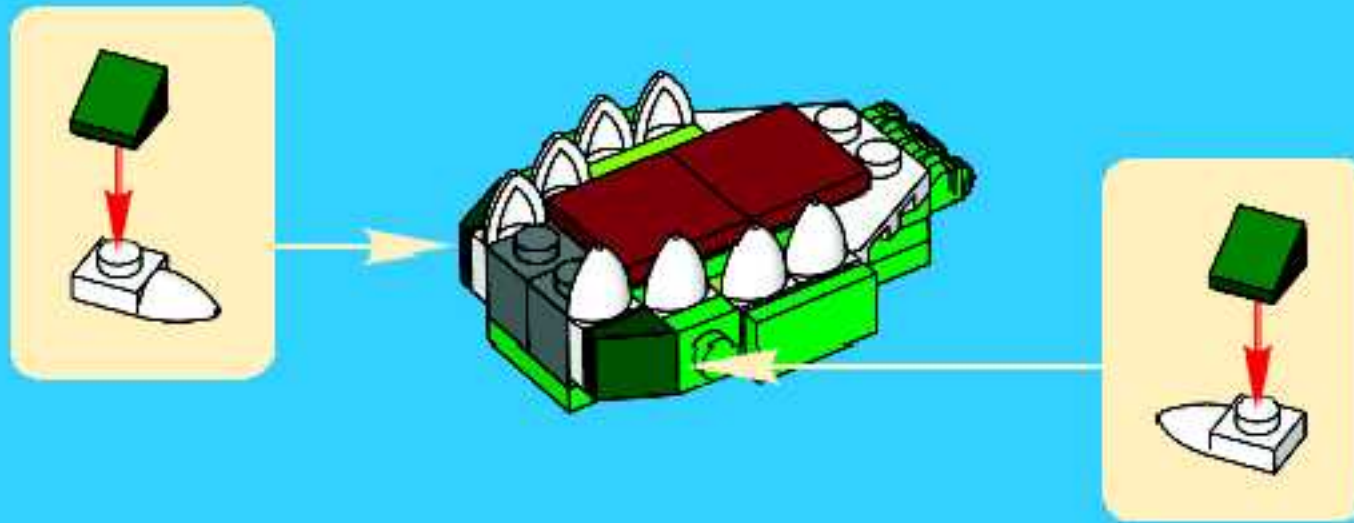

7

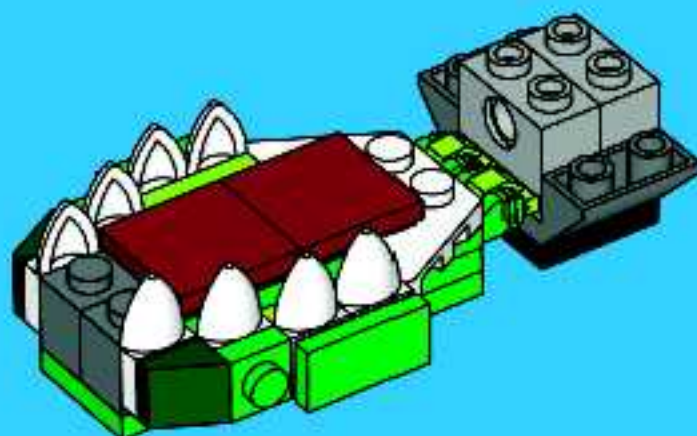
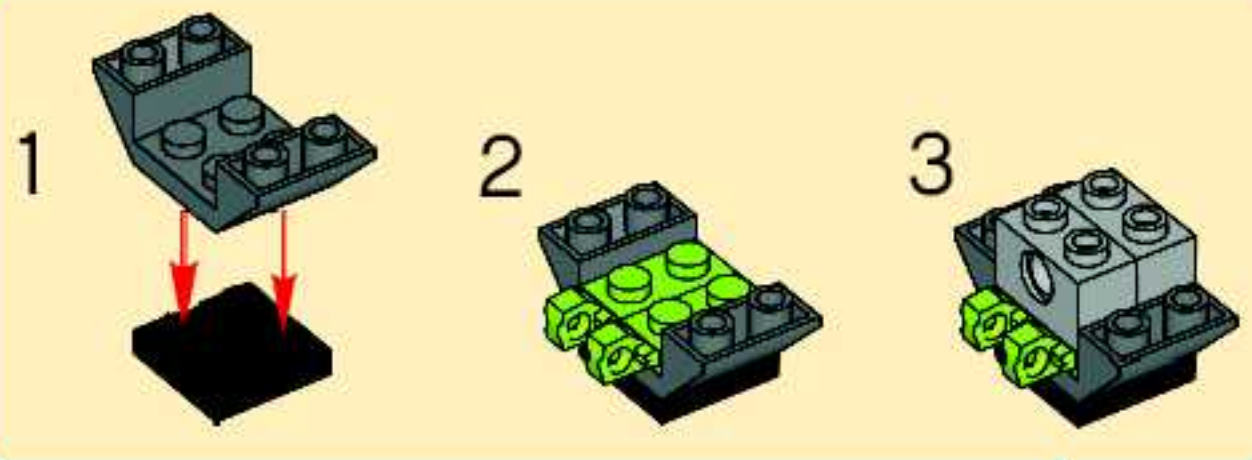



8

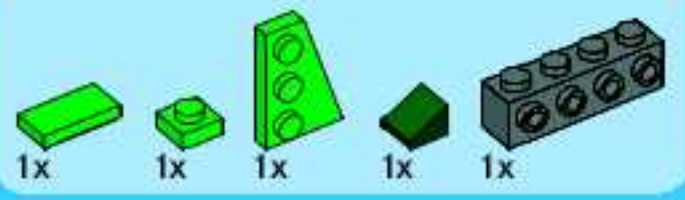
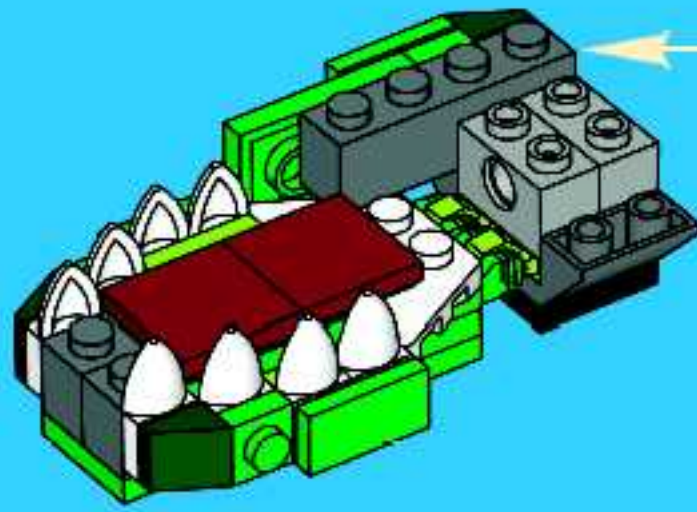
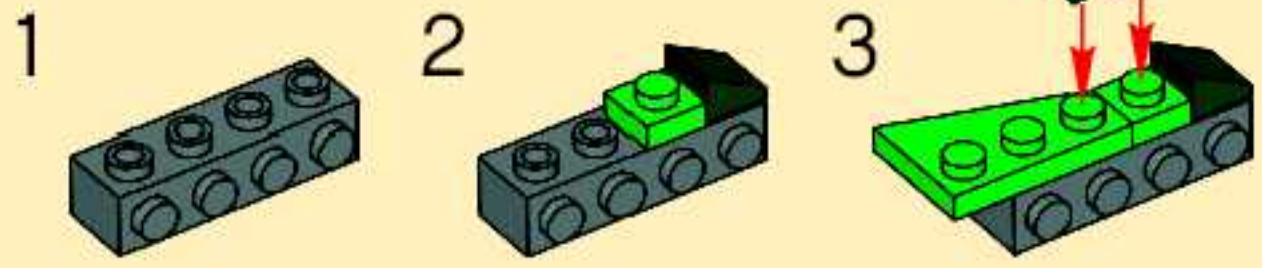

9

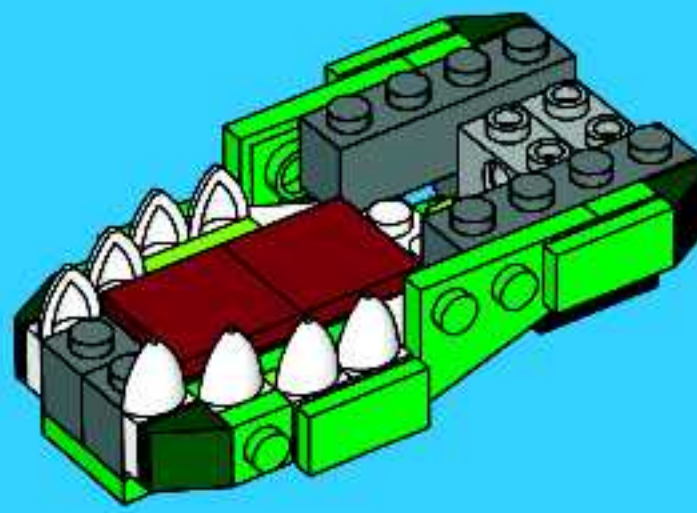
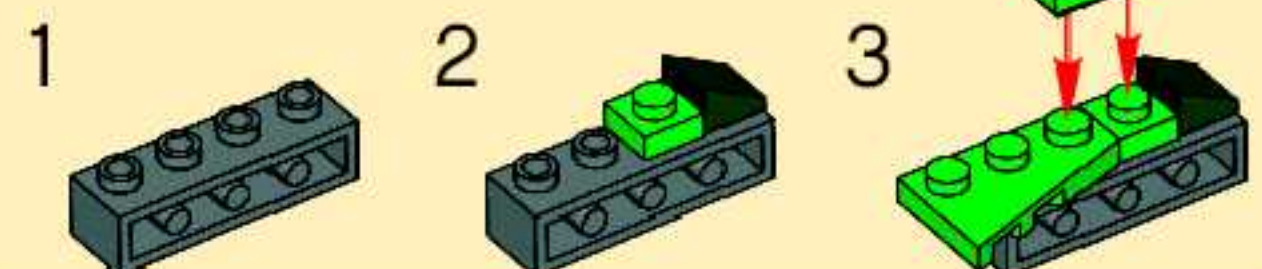

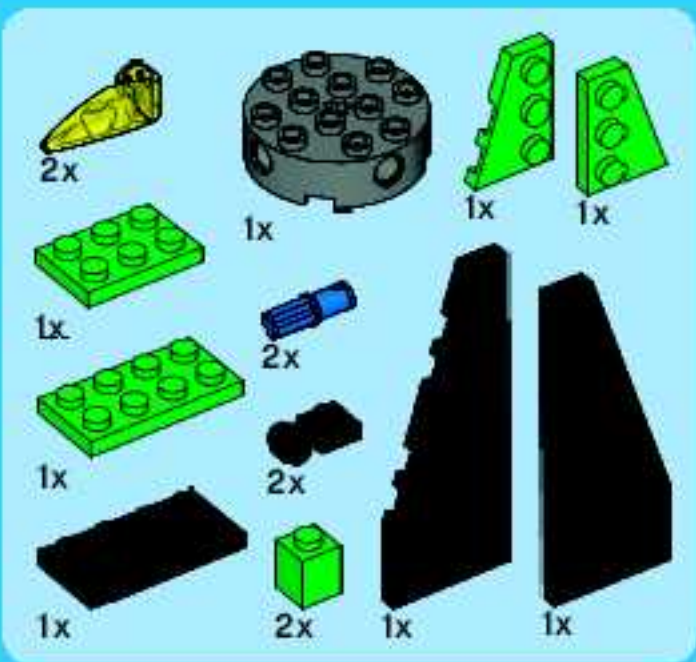

10

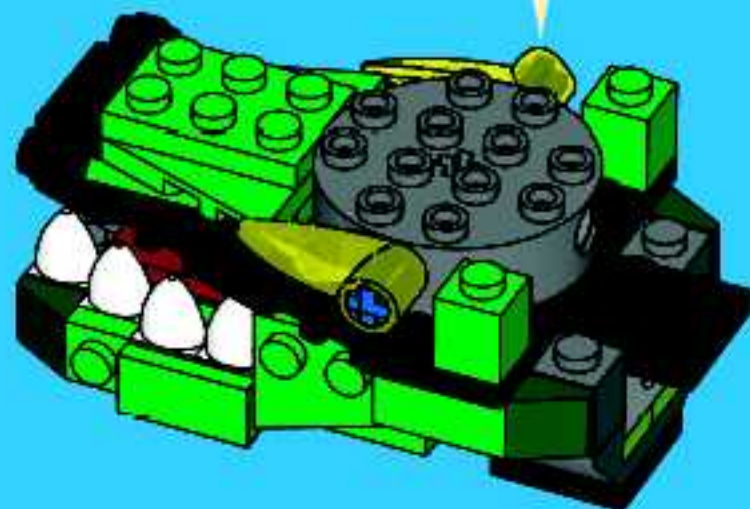
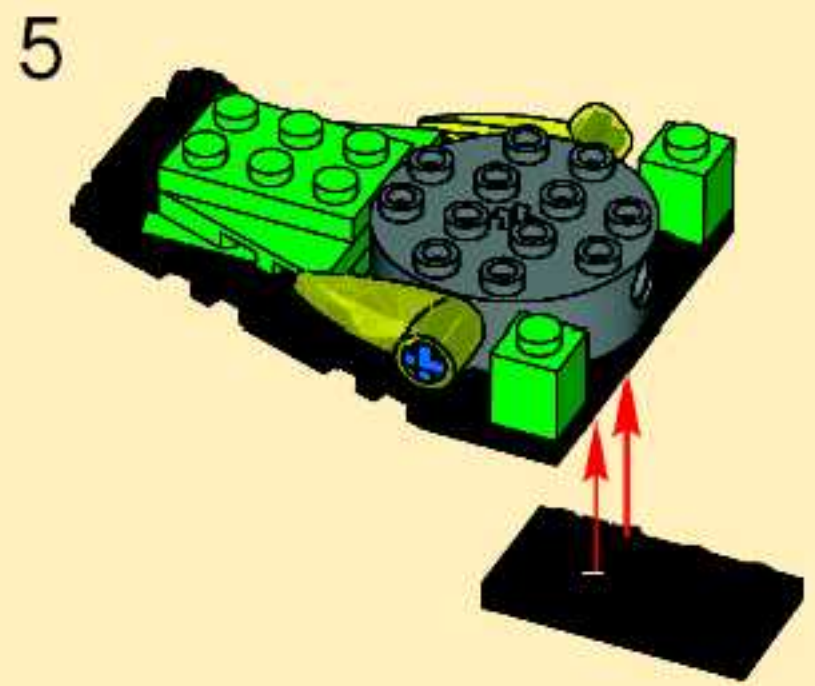
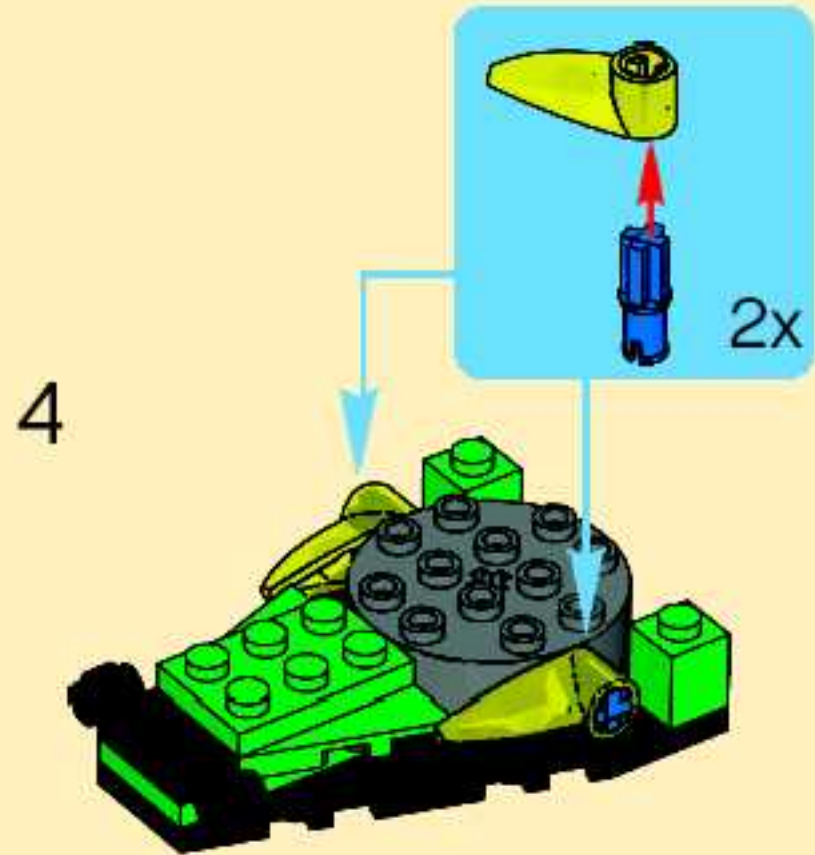
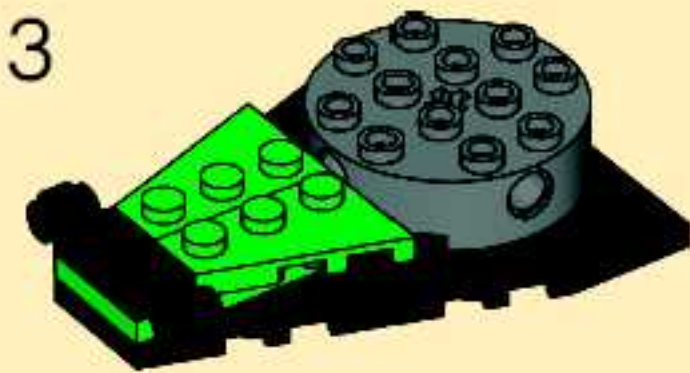
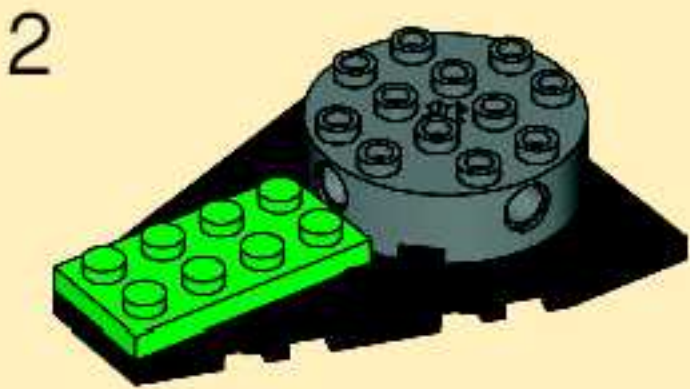
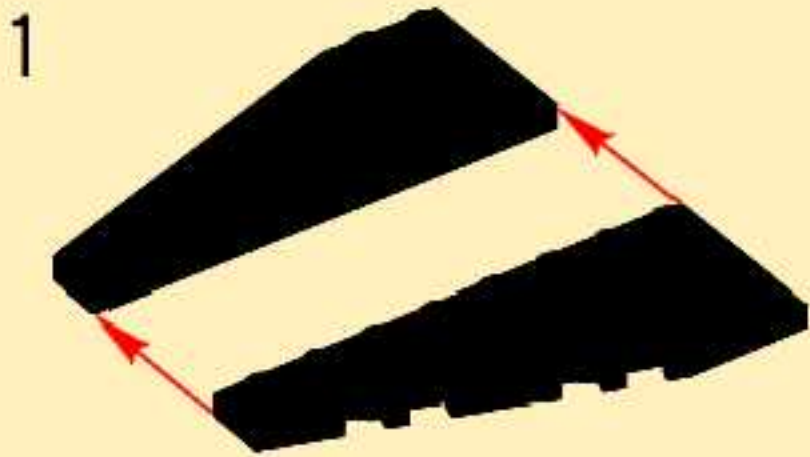



11

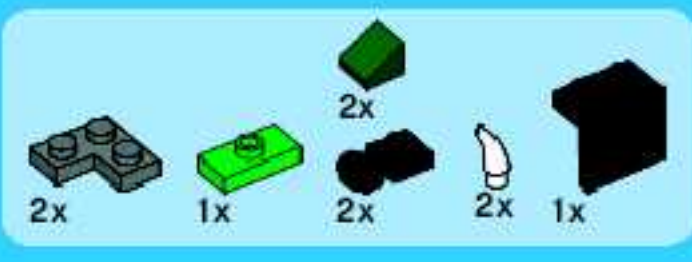
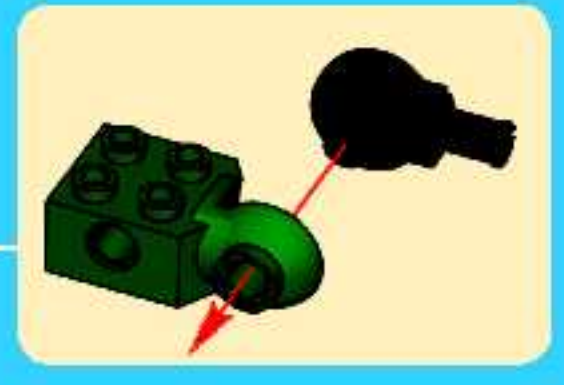
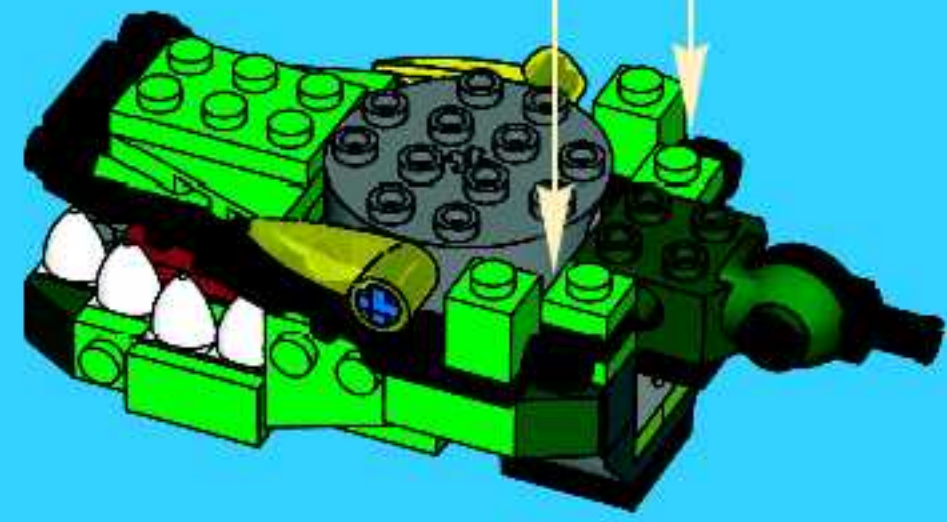
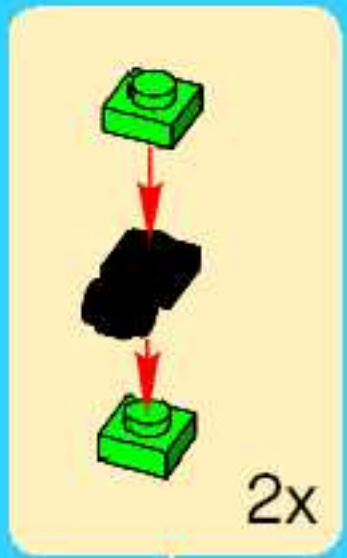

12

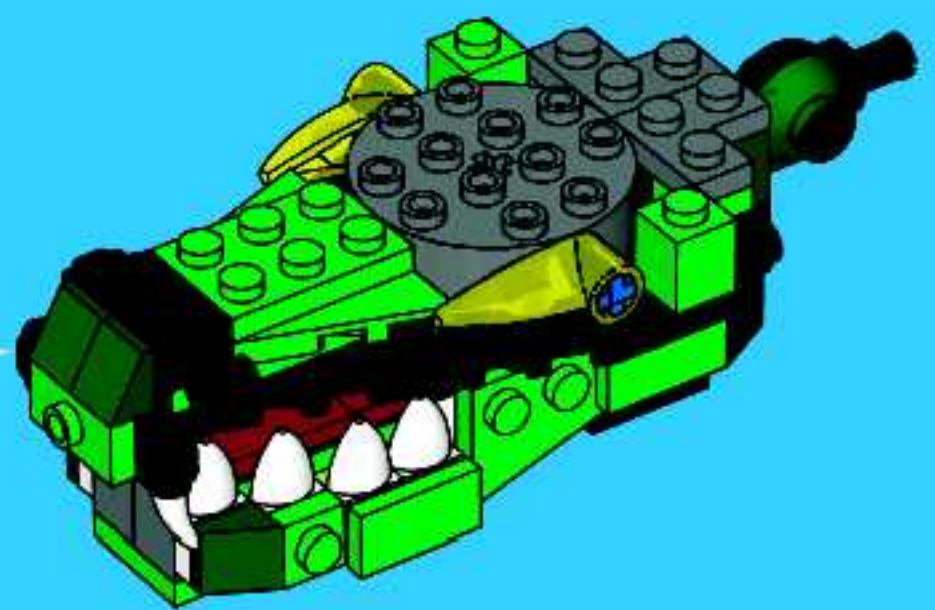
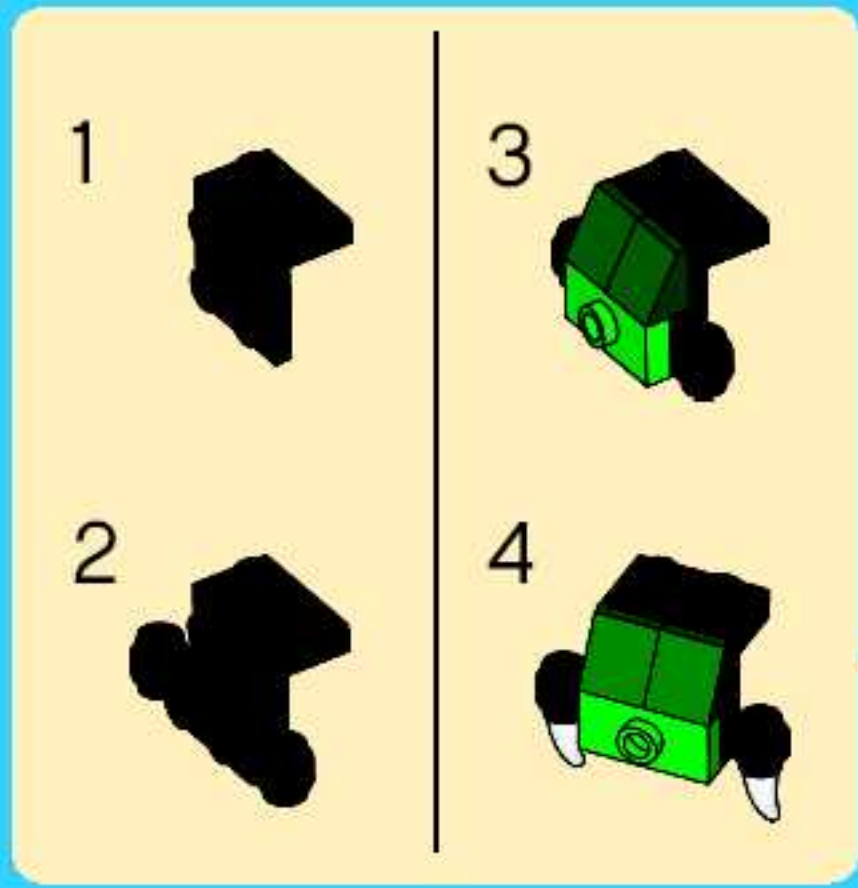



2x

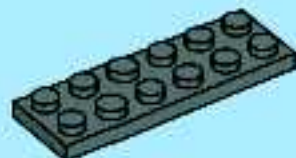

1x

13

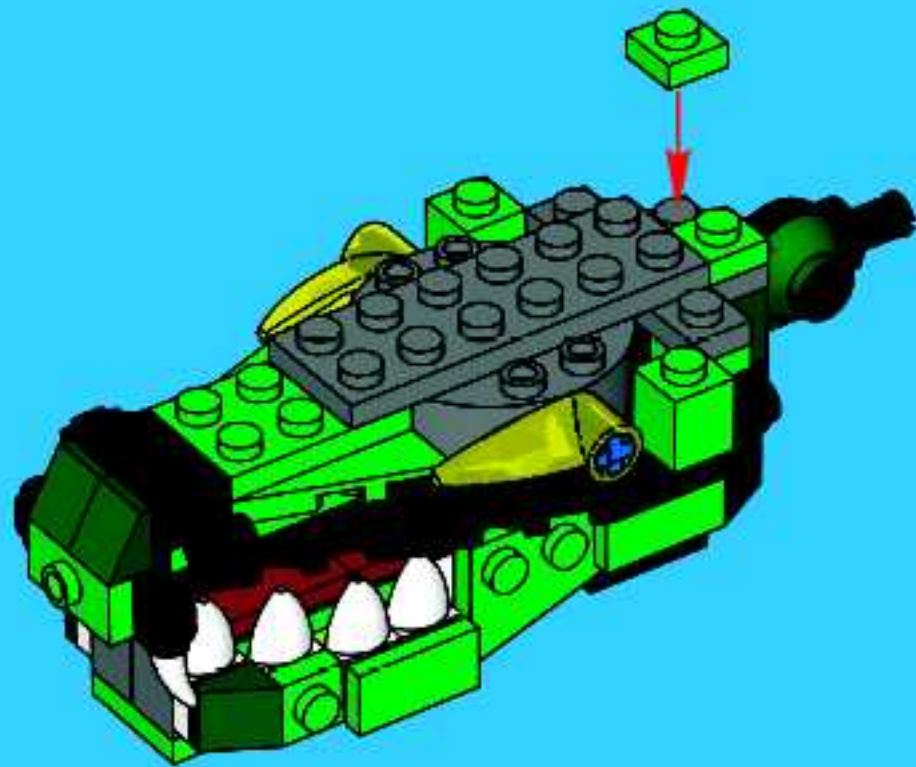

1x



2x

15

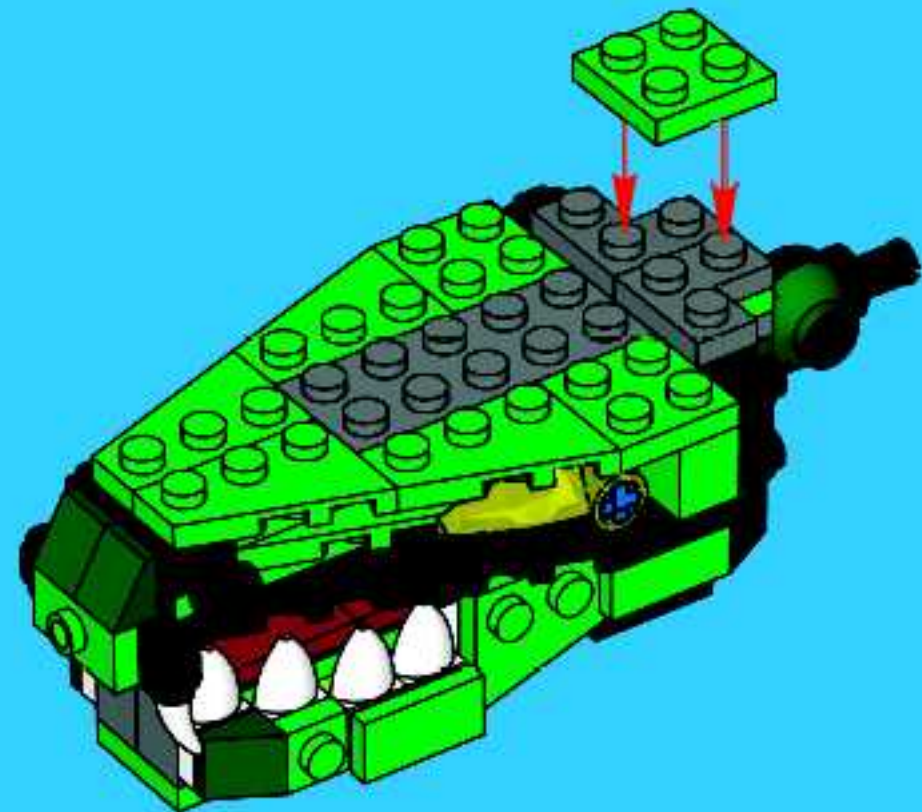

2x



2x

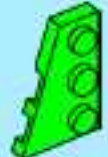

2x



2x

14

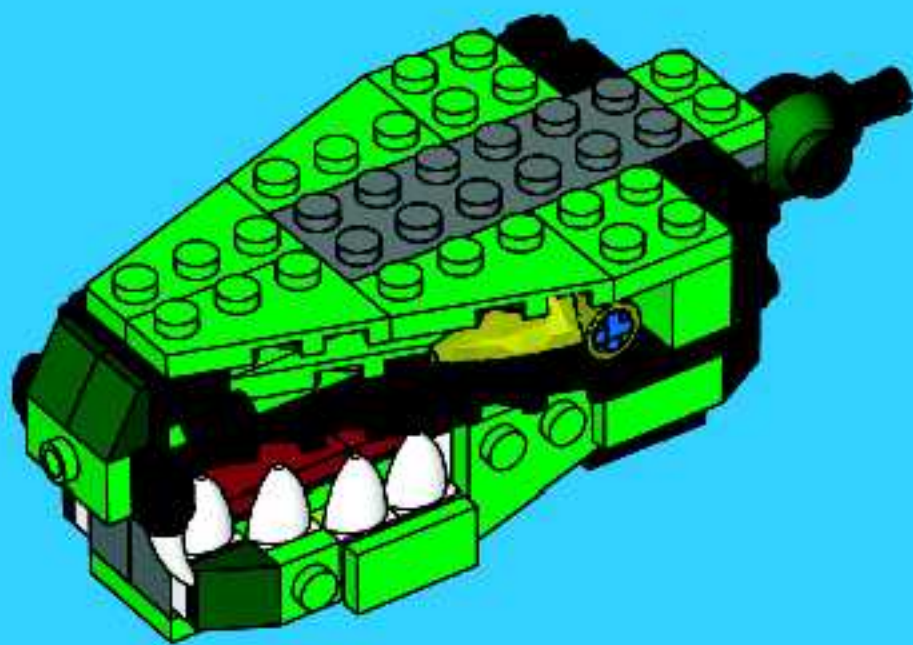

2x



4x

16

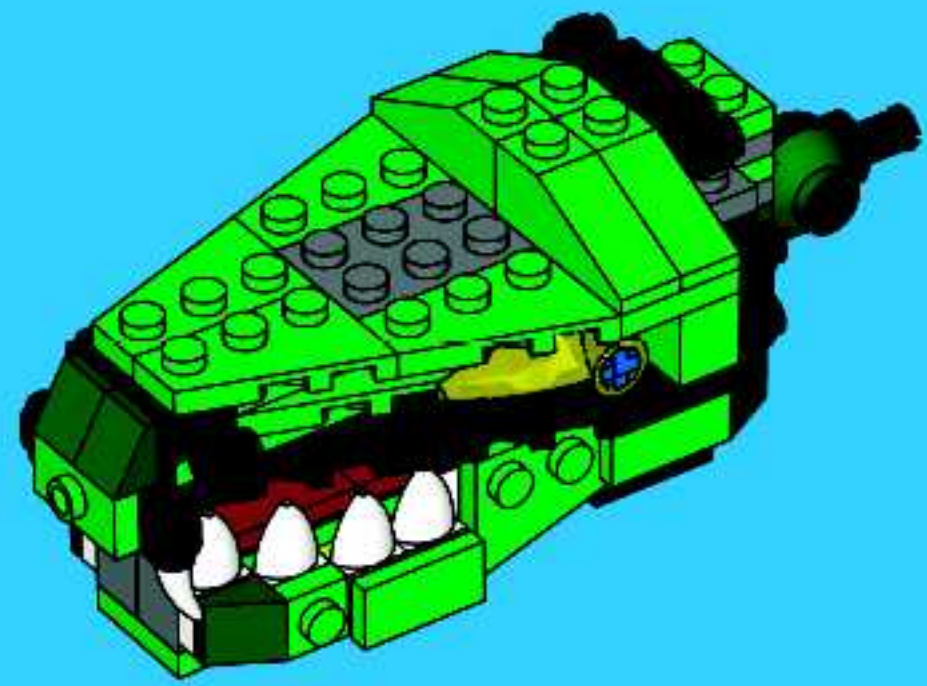

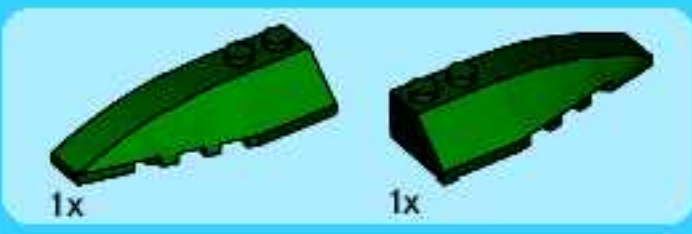

17

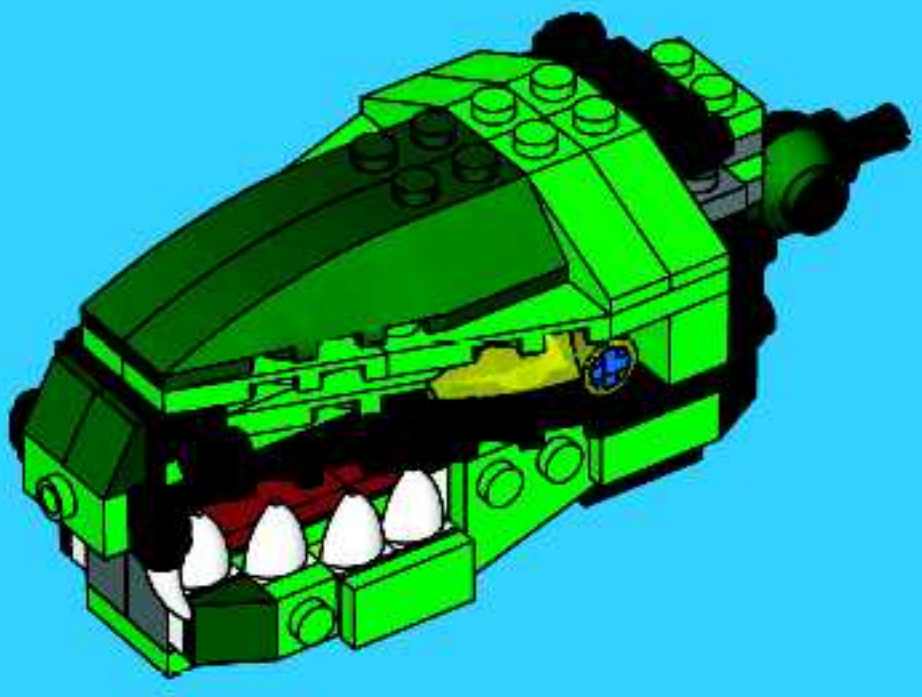

18

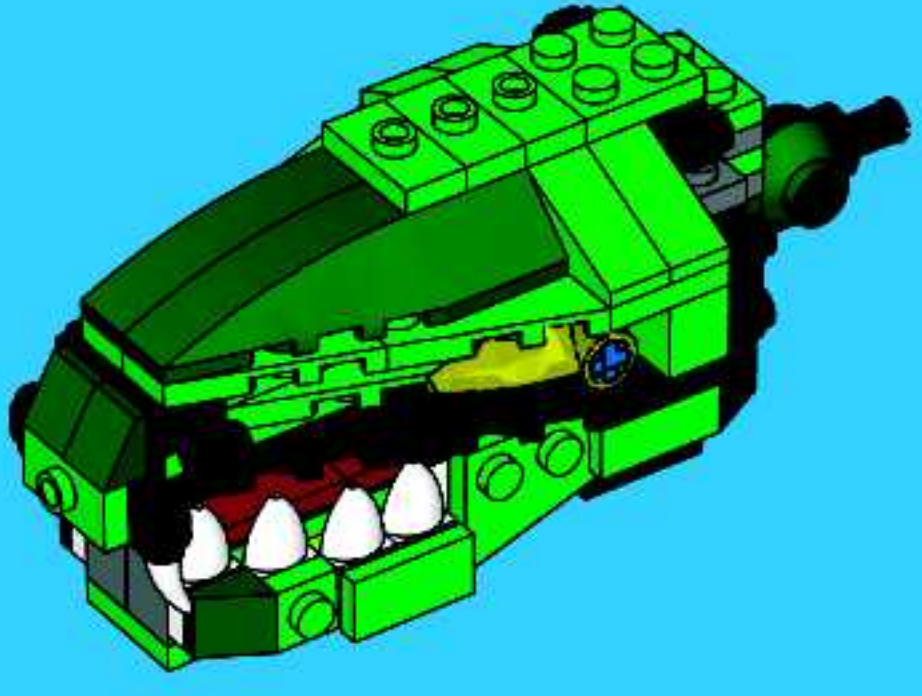

19

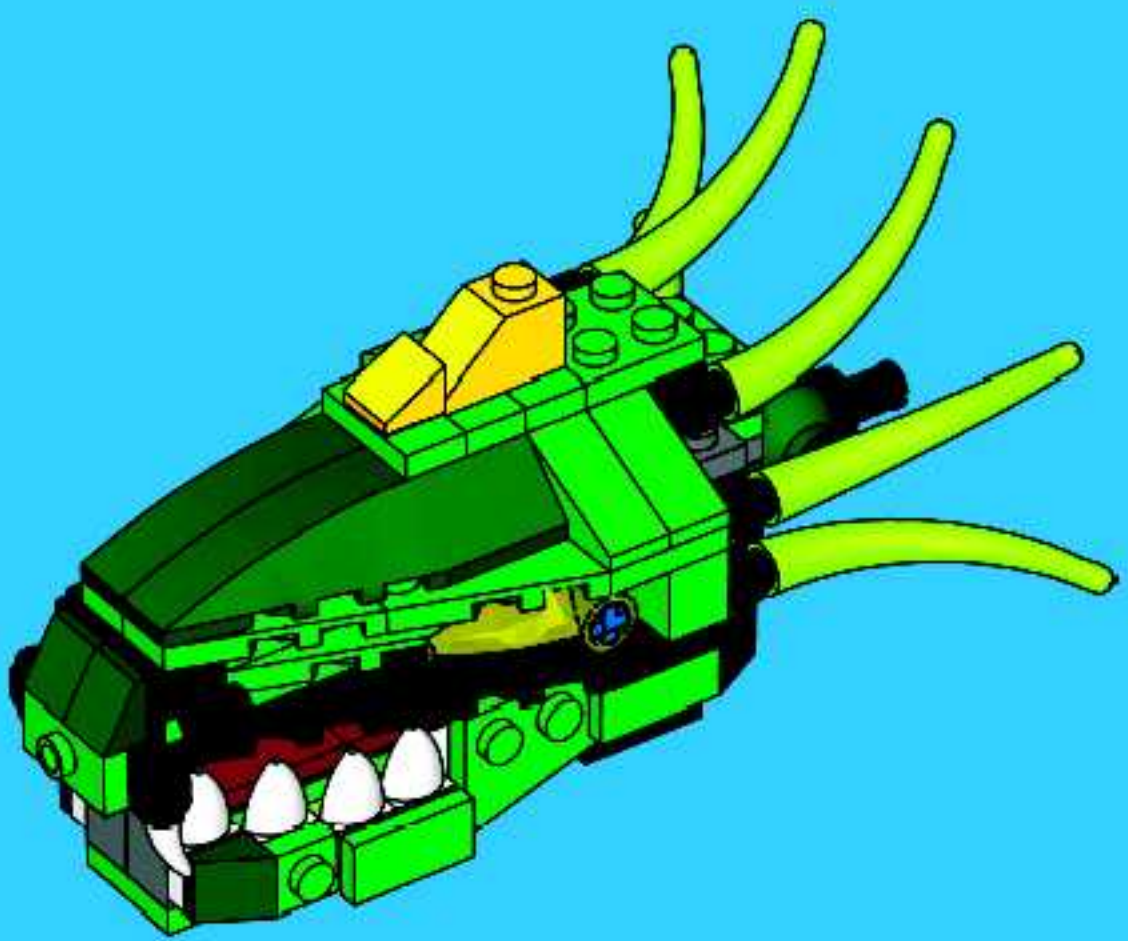

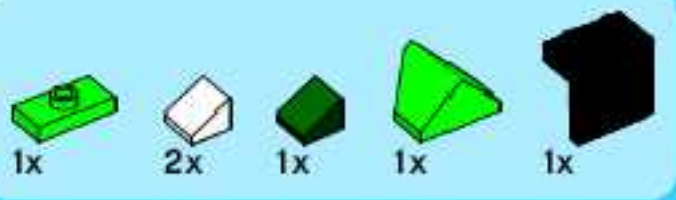

20

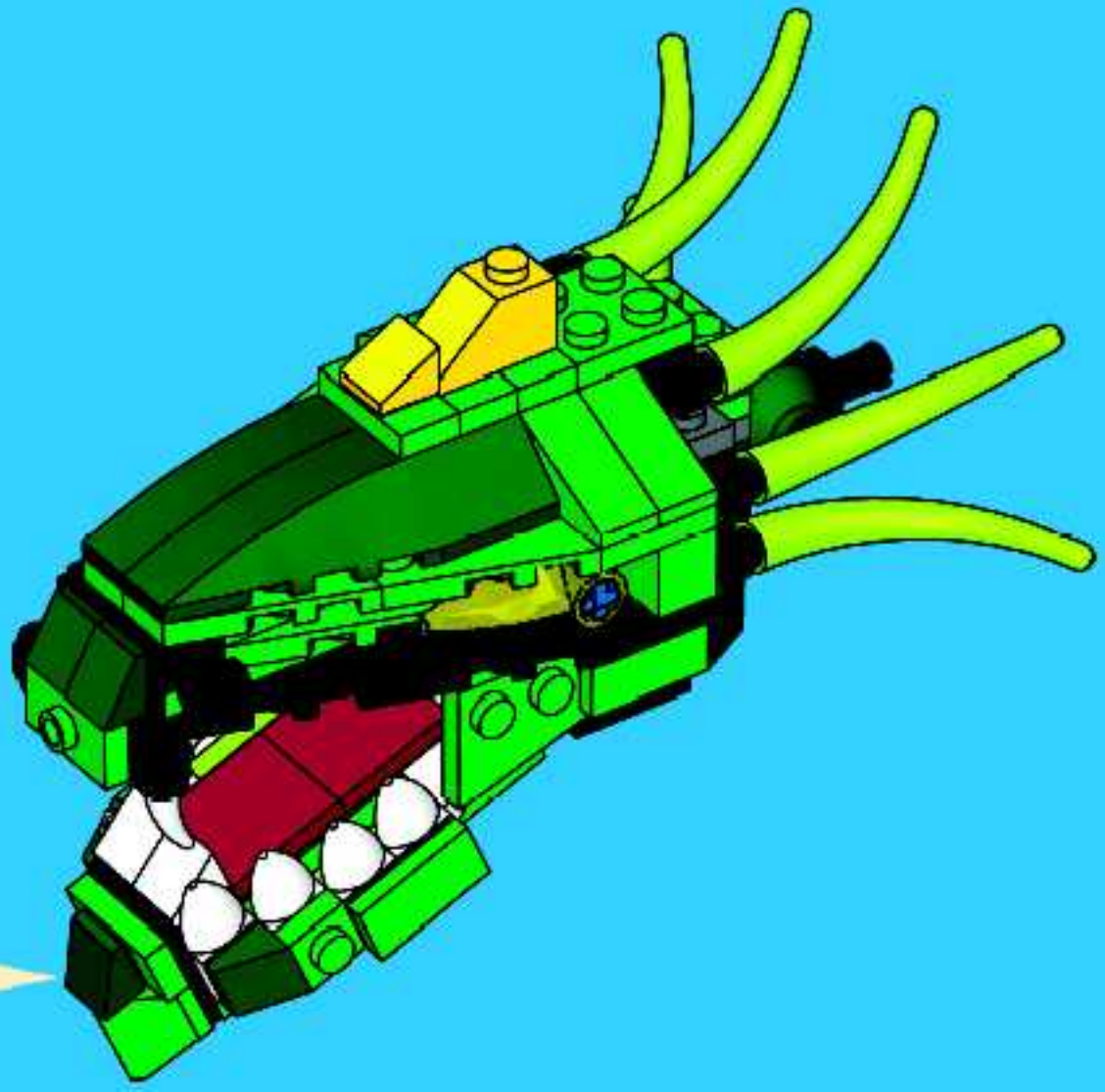
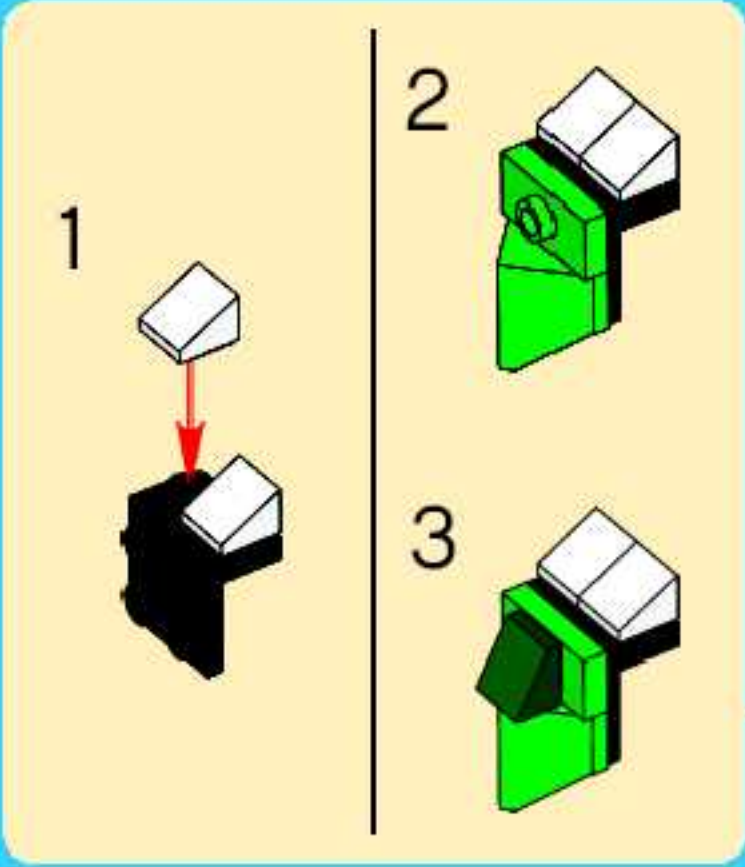

23

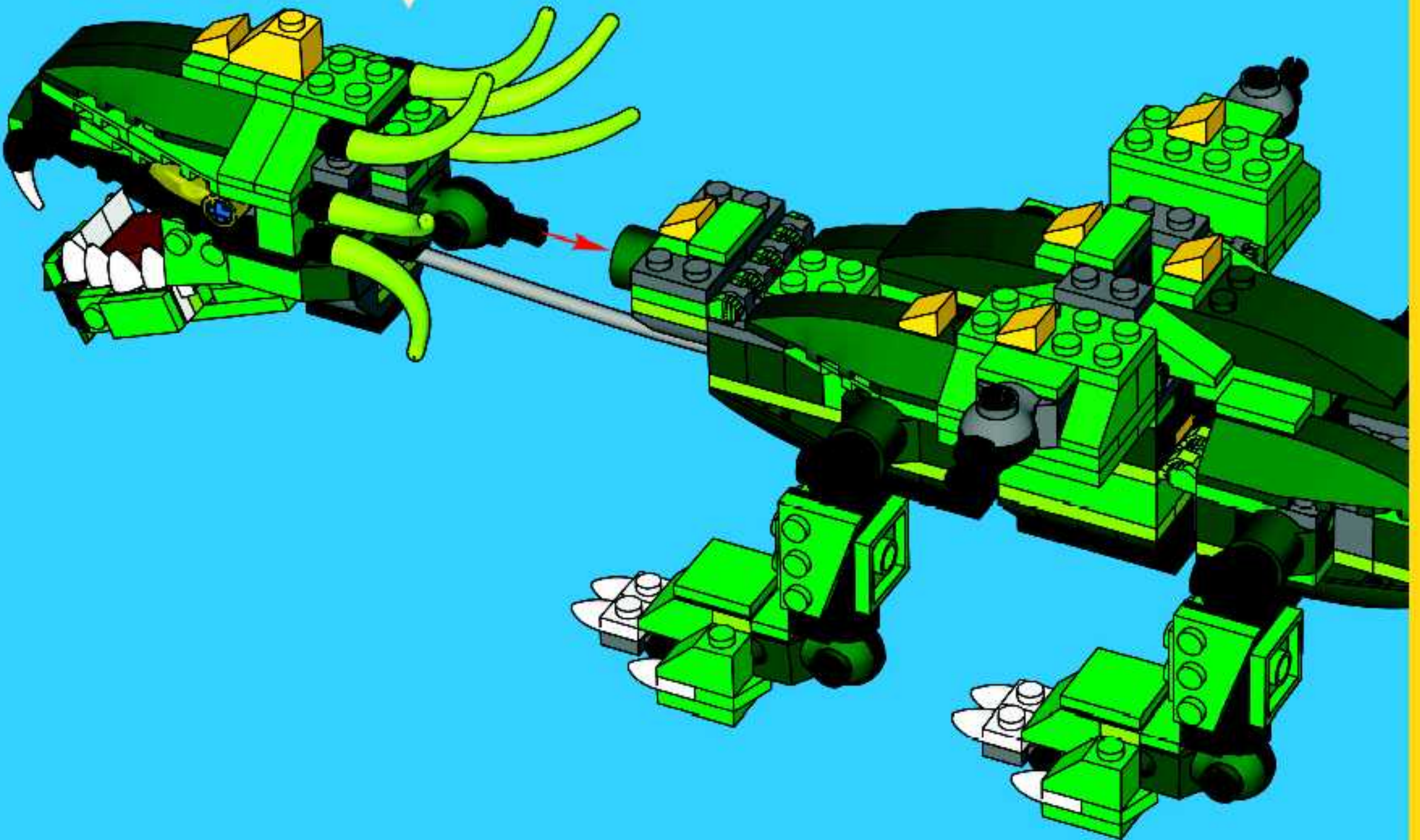







4x

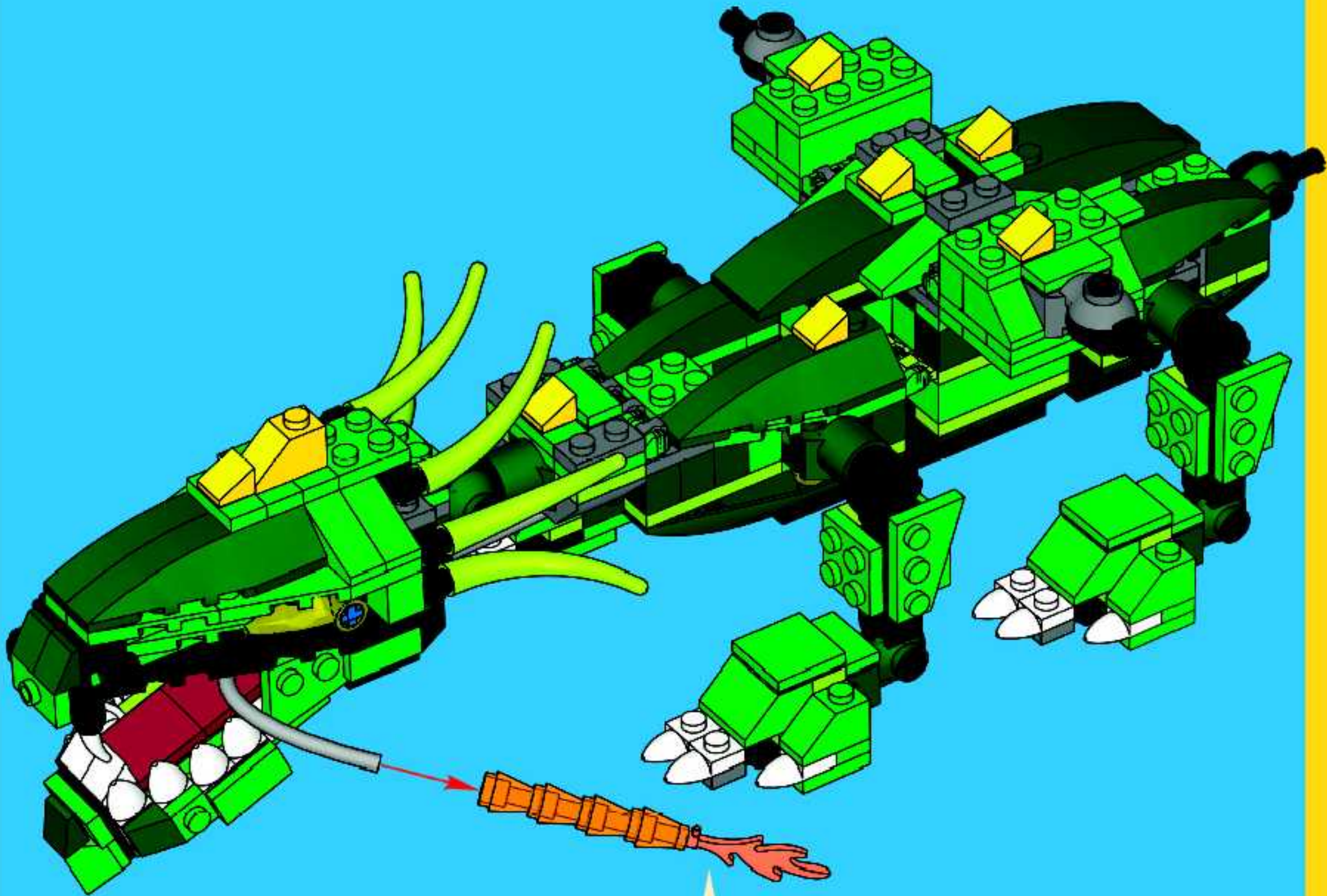

1x

24



1   

2 

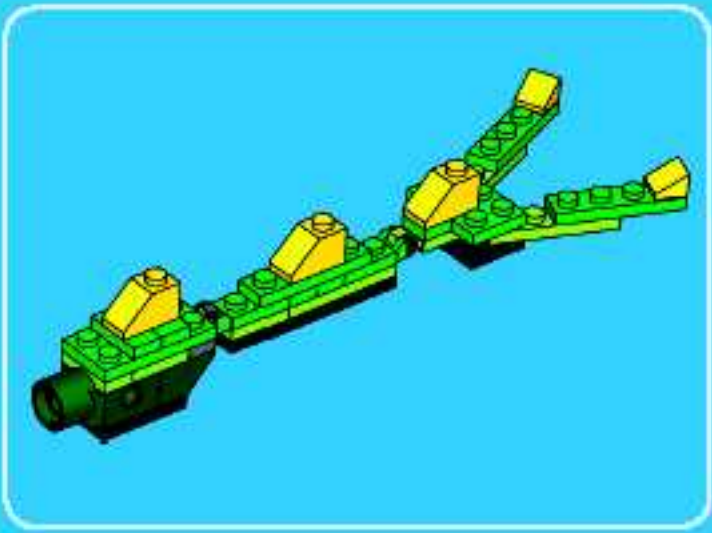

1

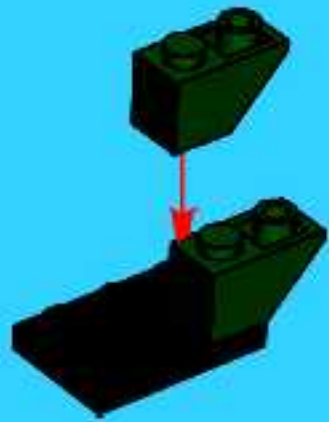

2



3

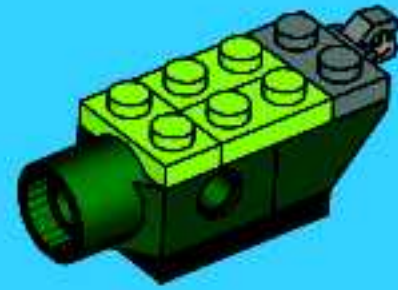

4

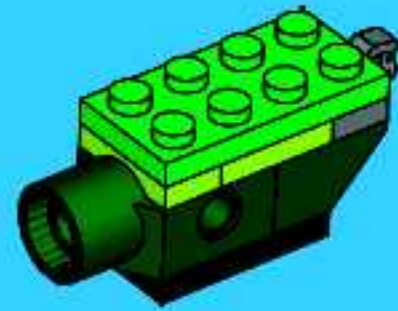

5

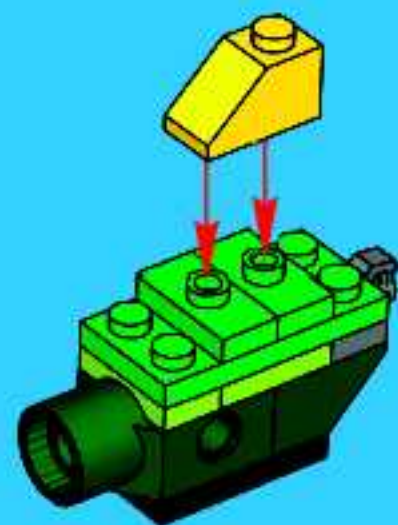

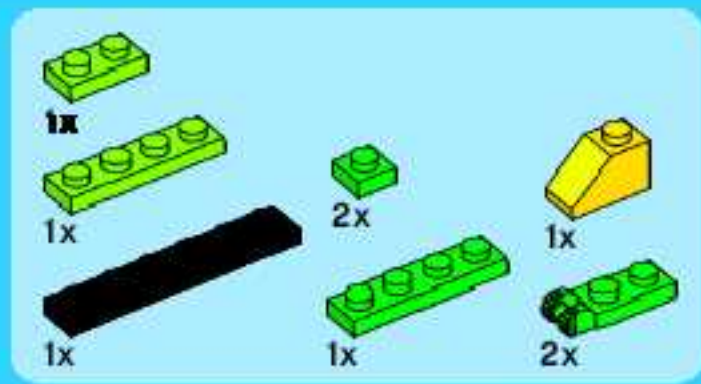

6

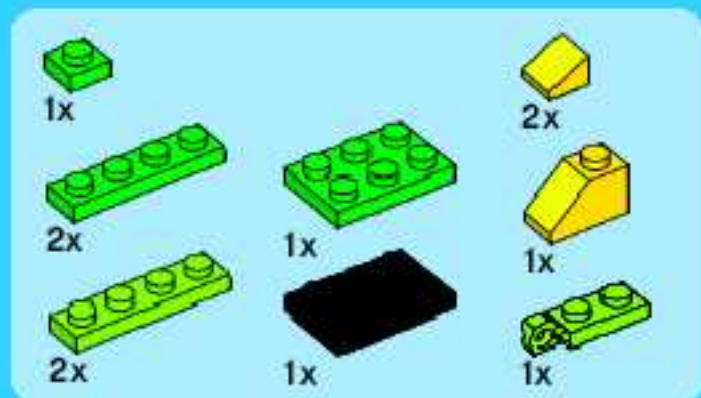
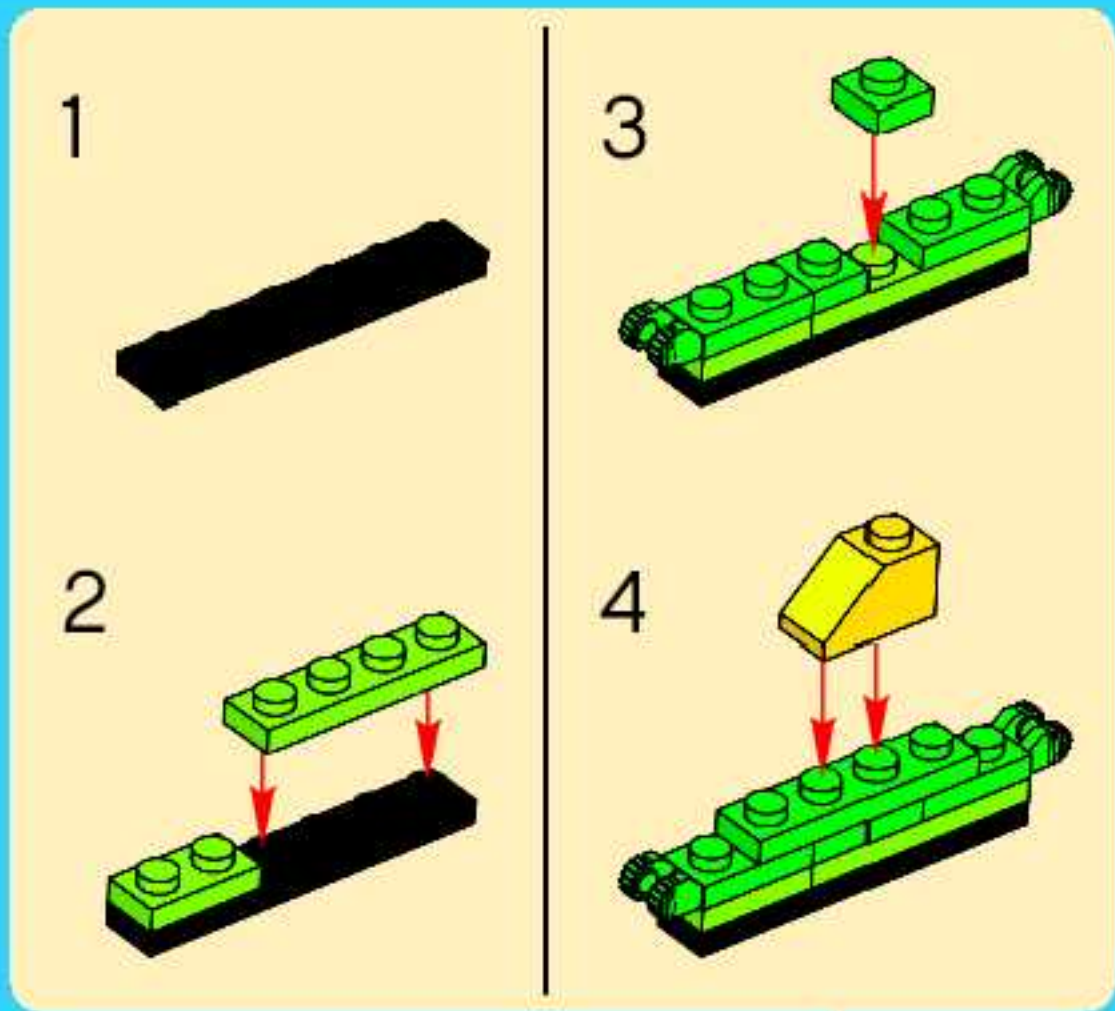
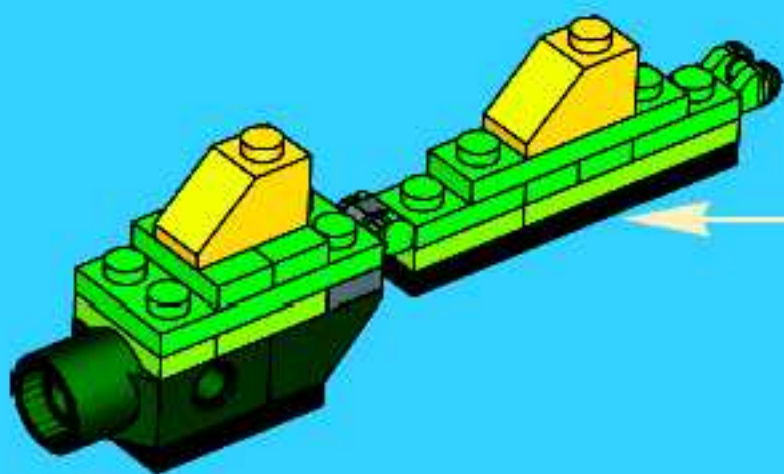

7

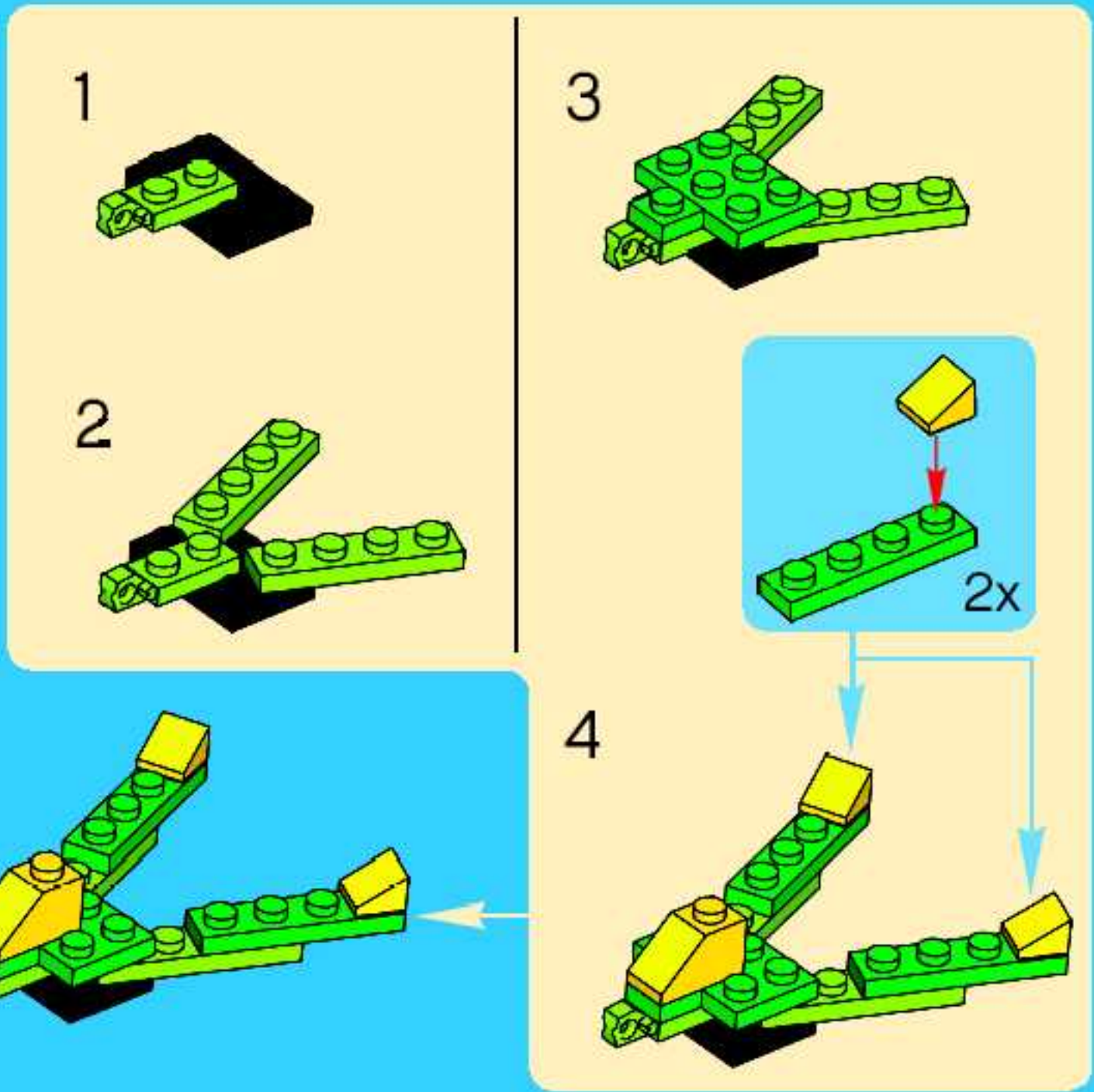
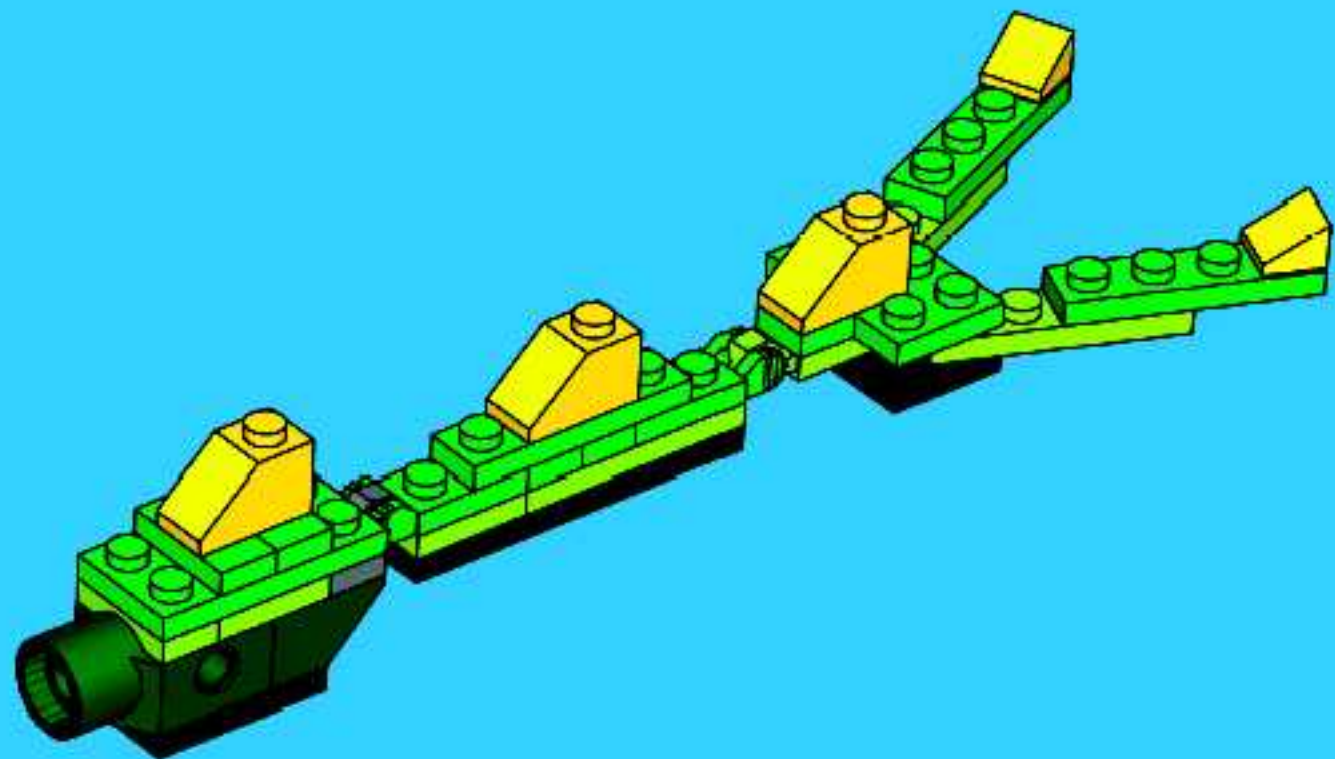

25

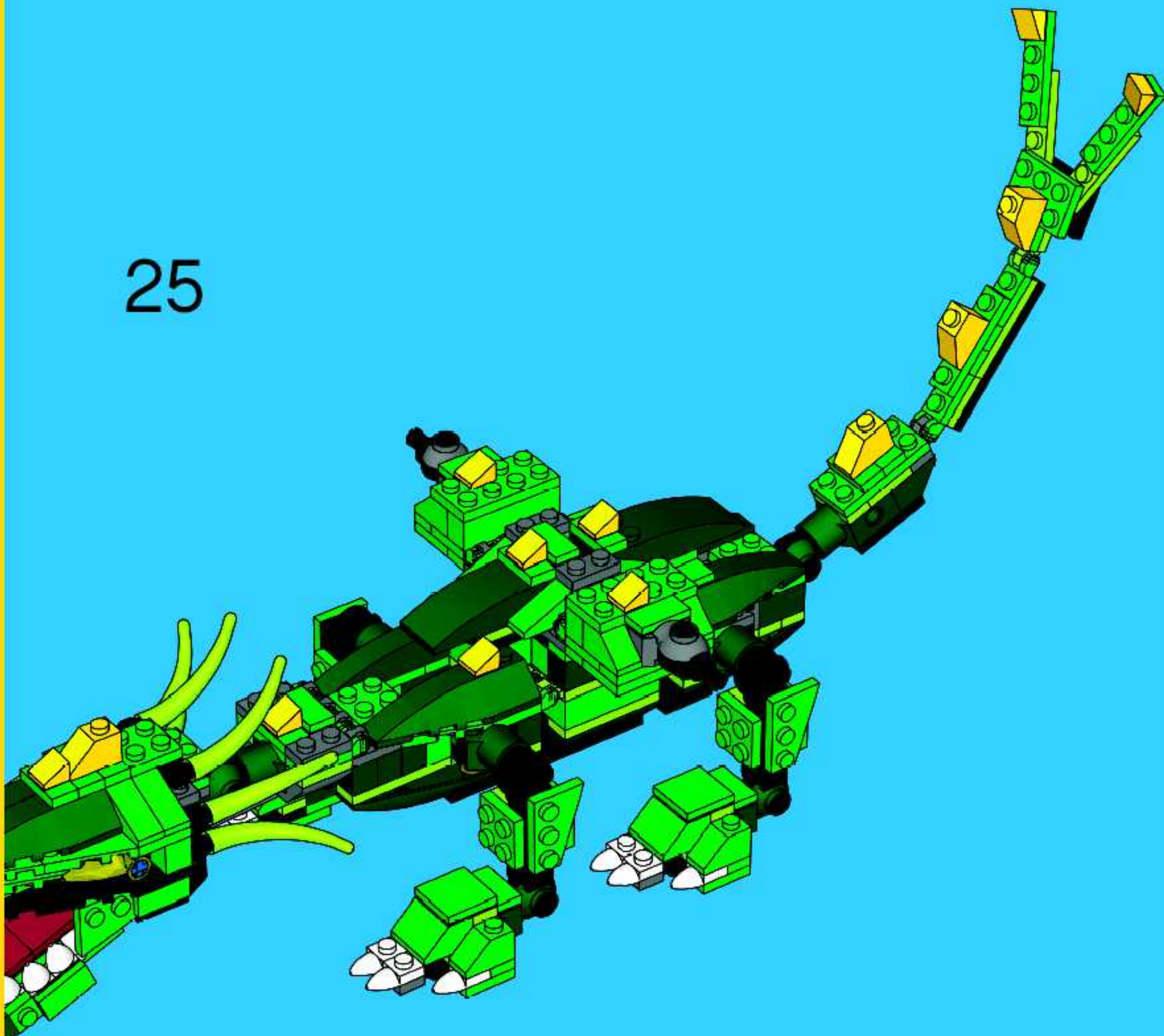

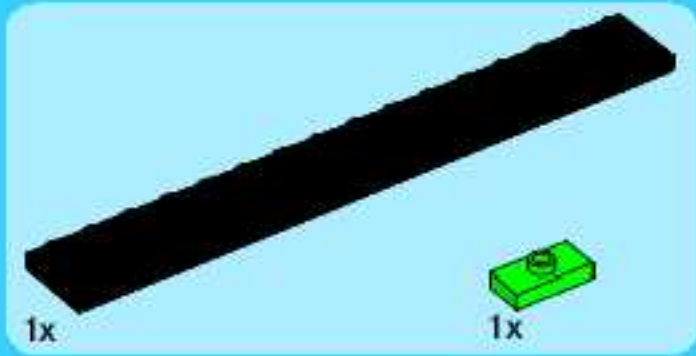
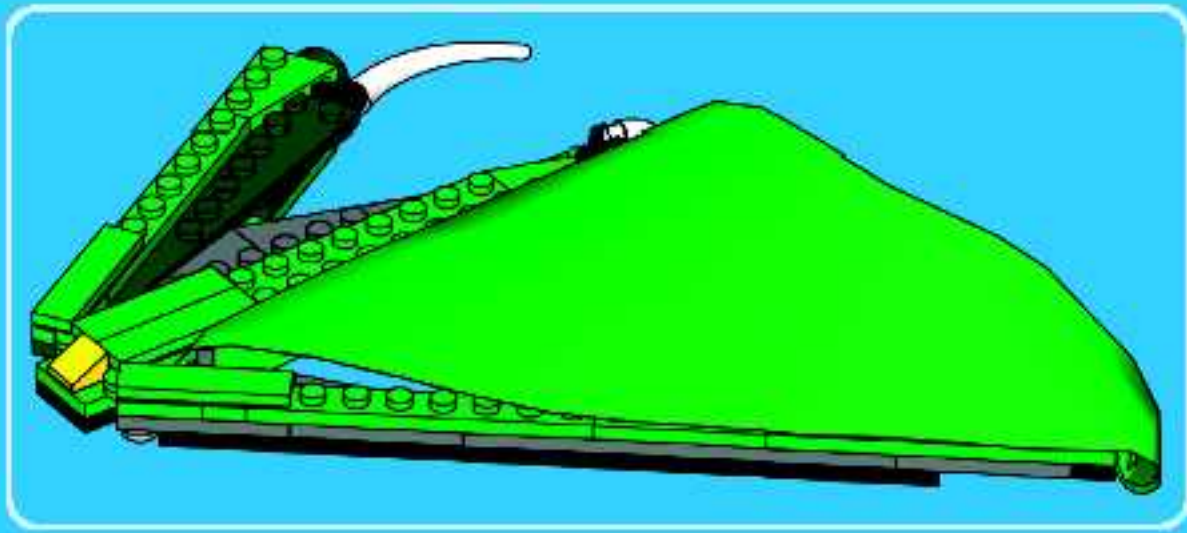

1

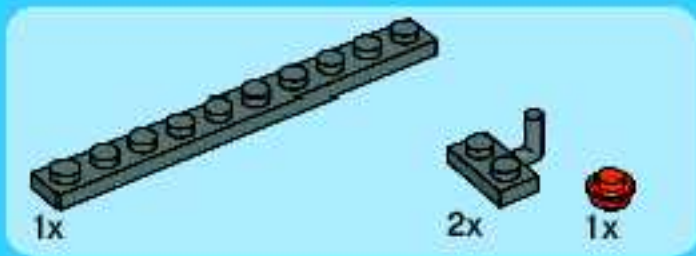

2

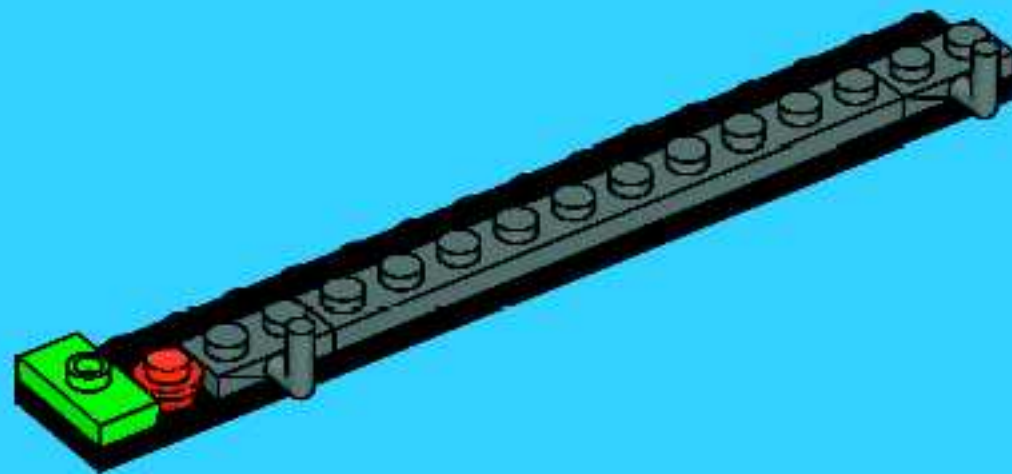

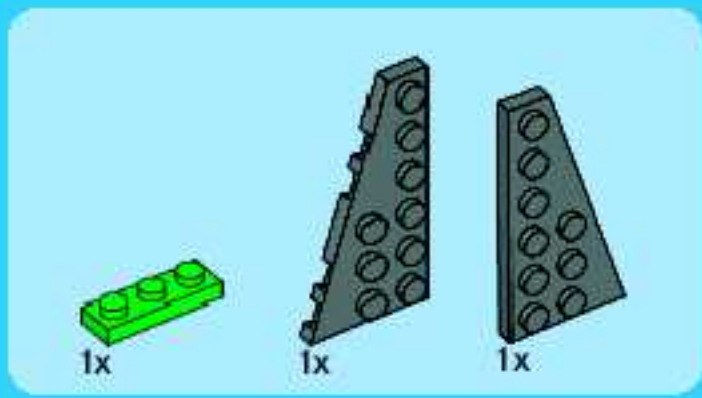

3

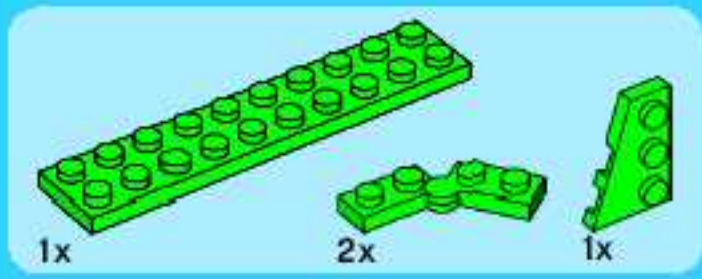
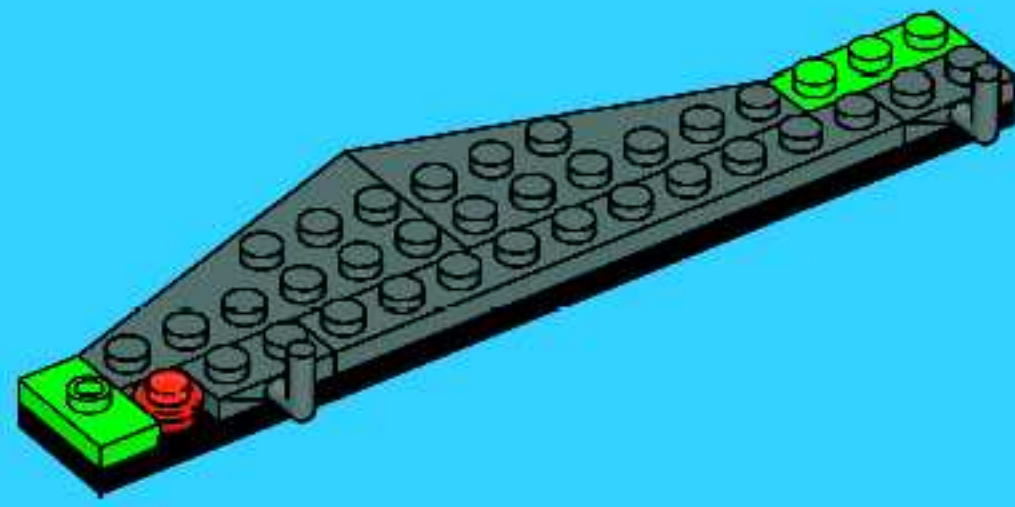

4

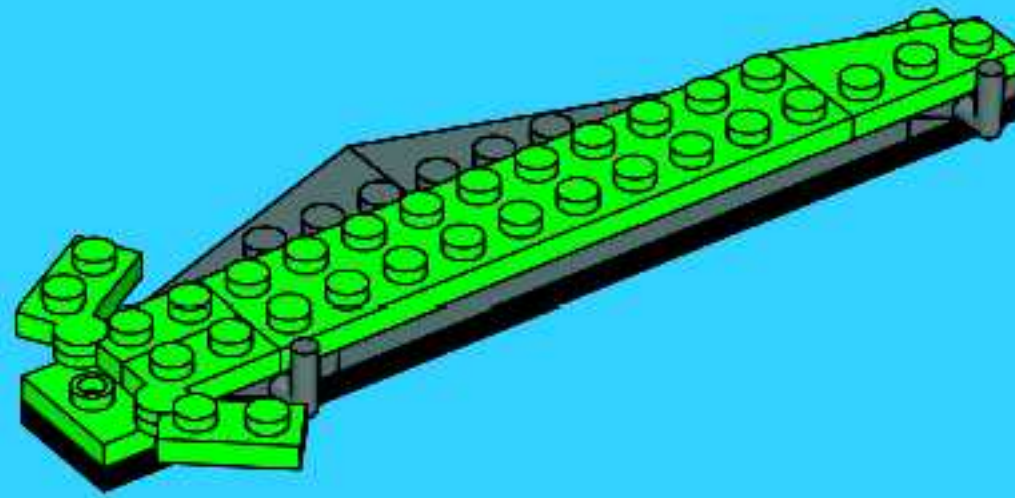

5

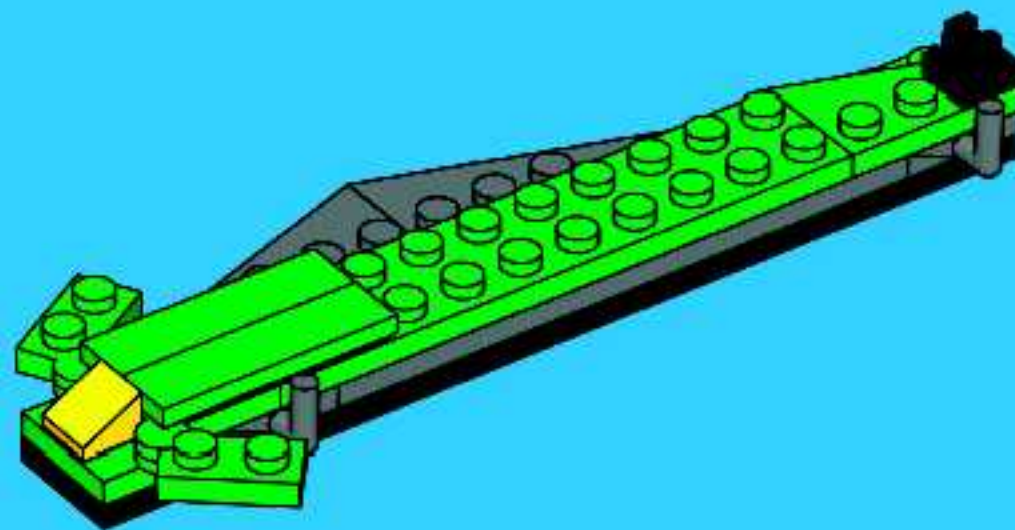

5

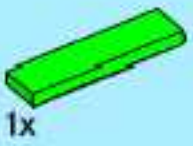
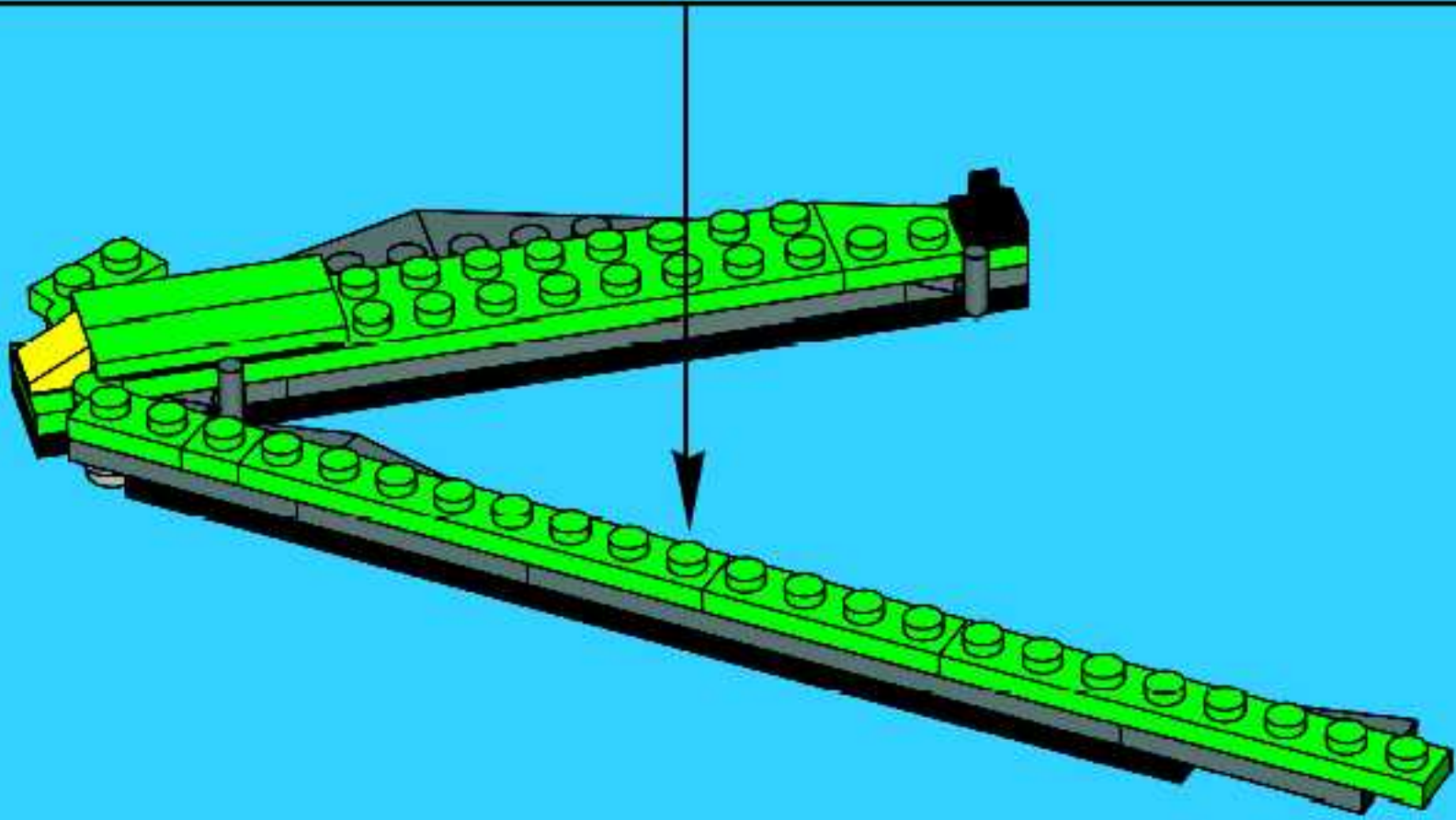
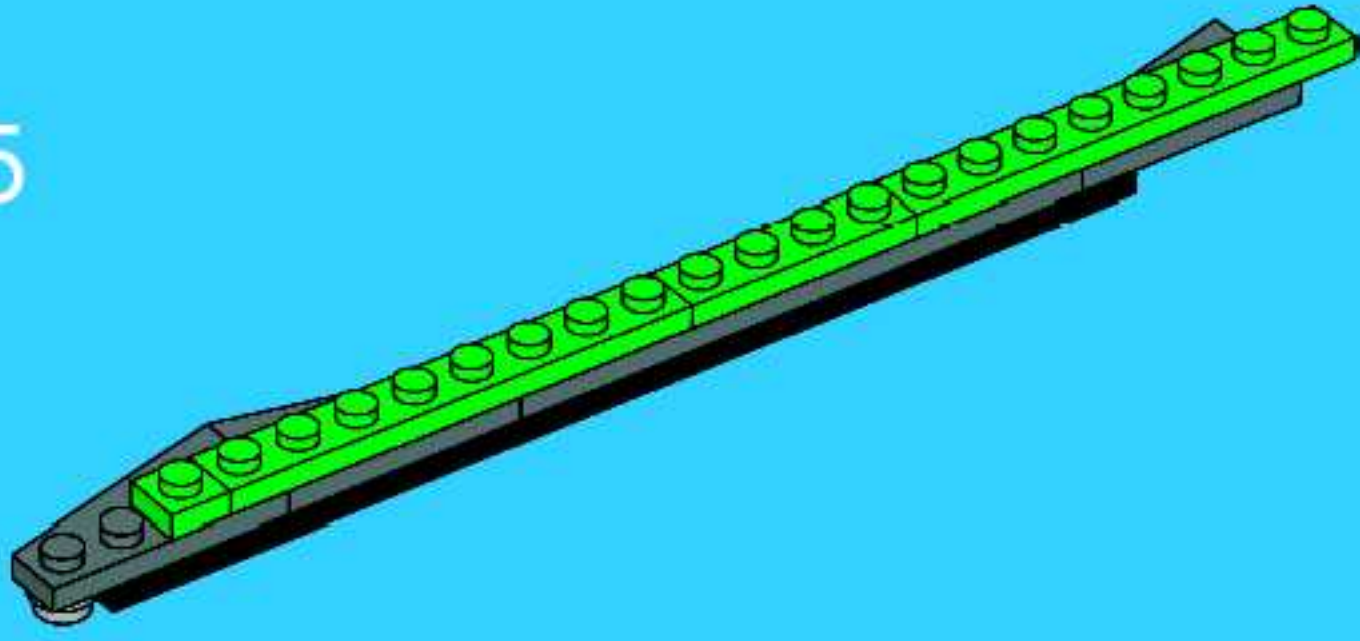

7

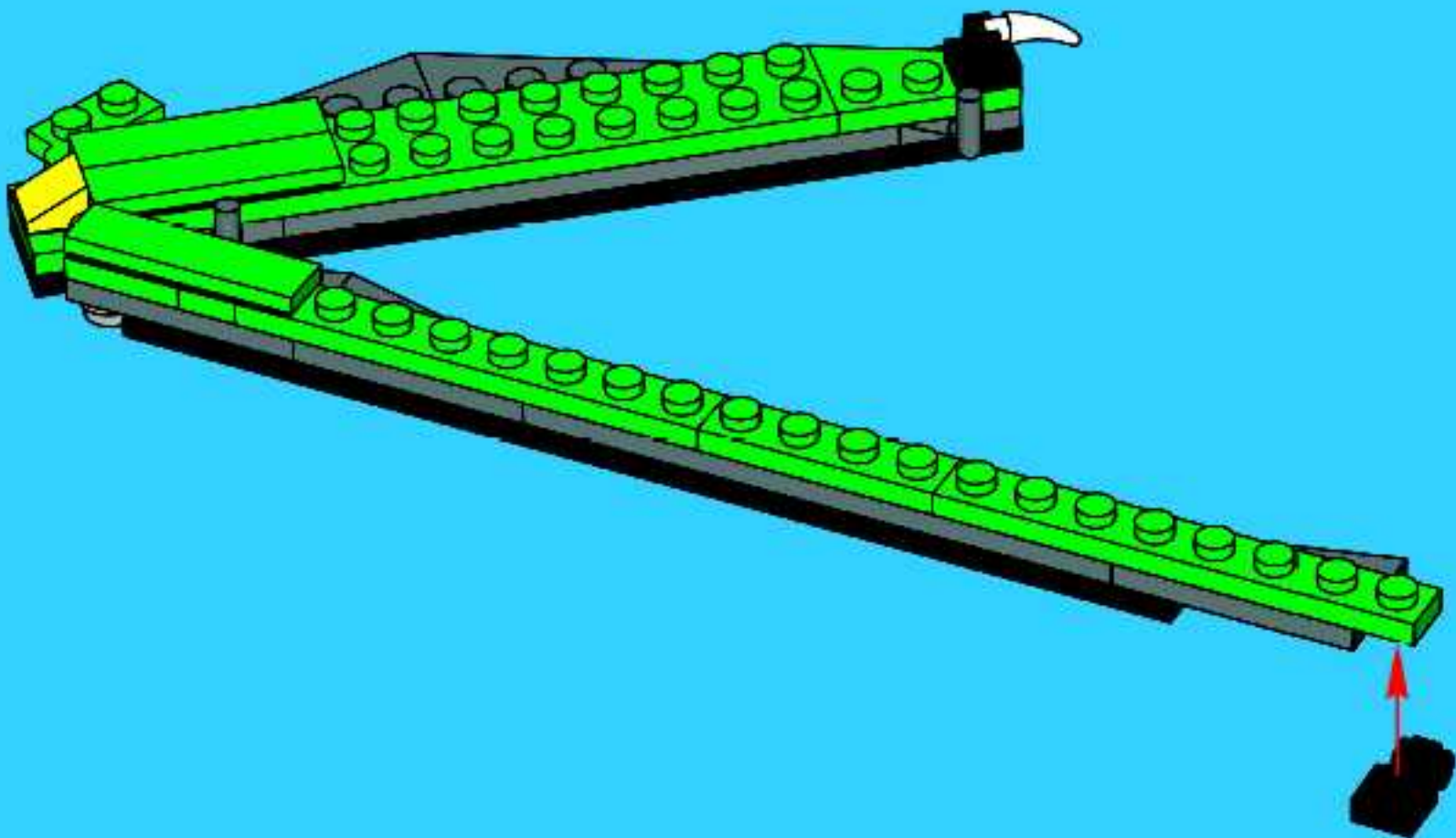

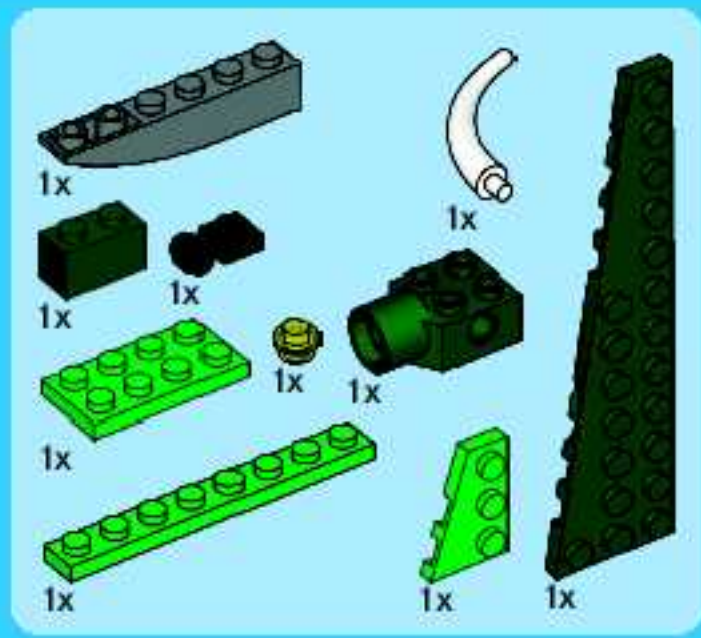

8

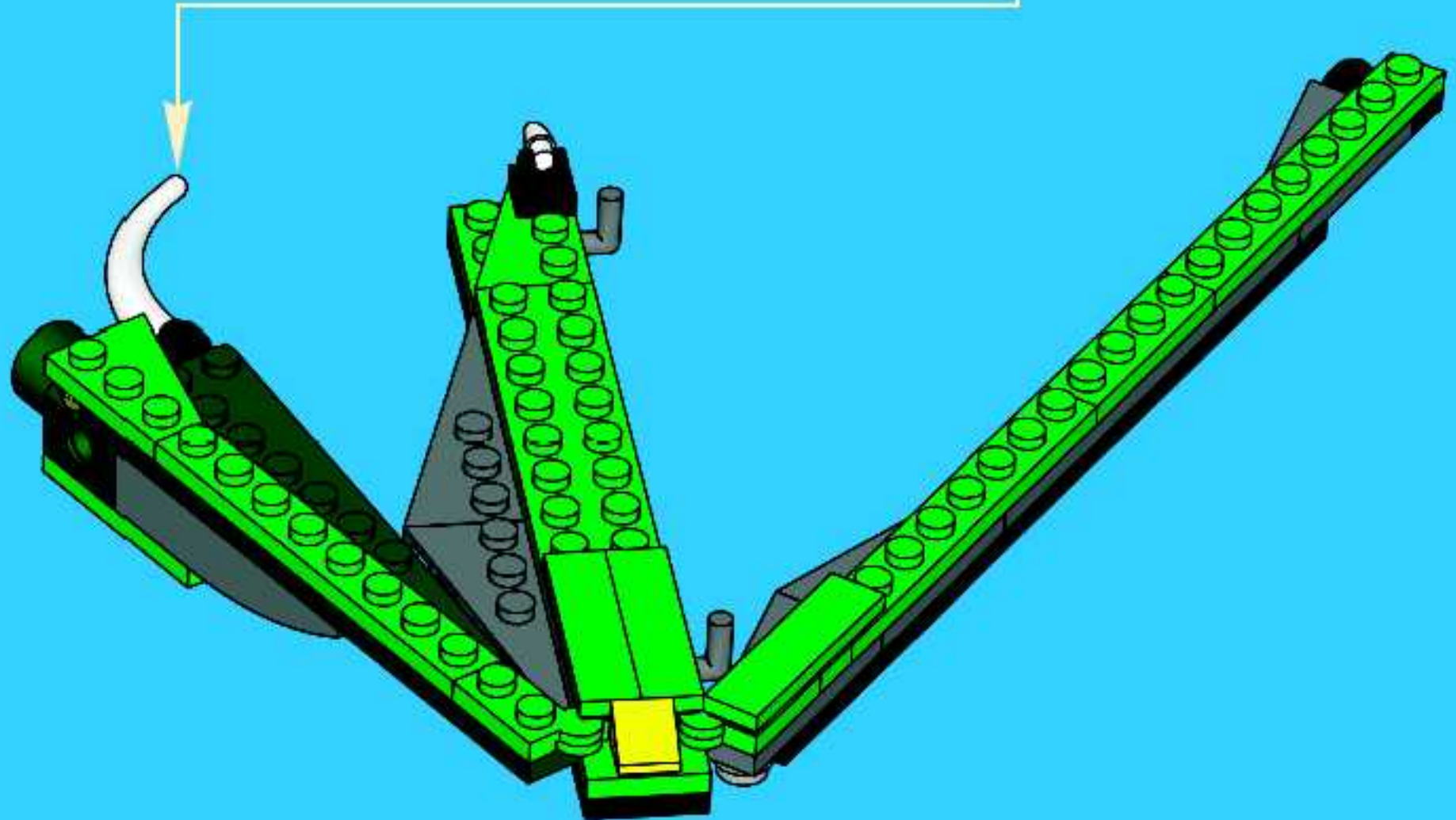
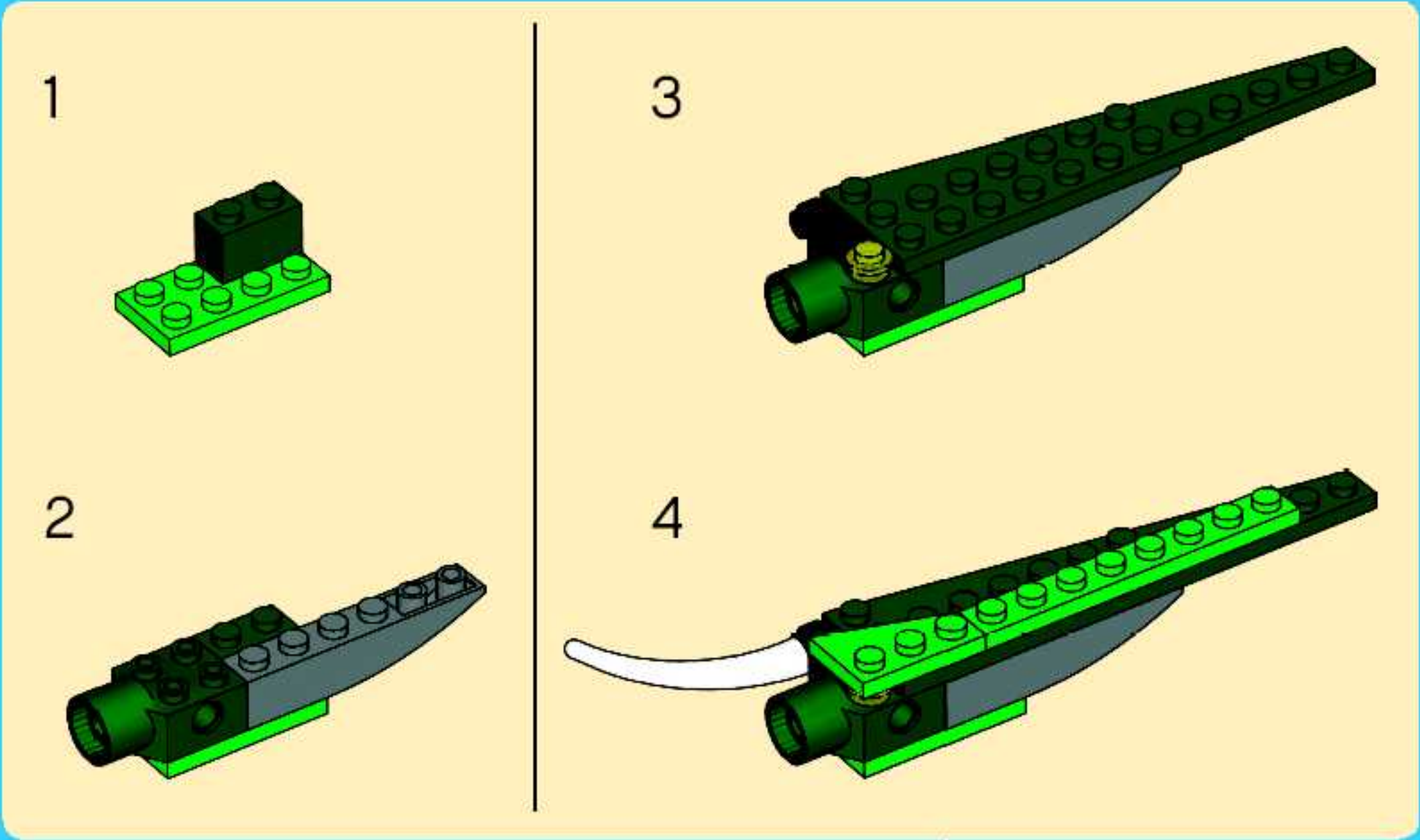

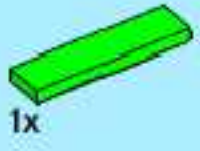

1x

9

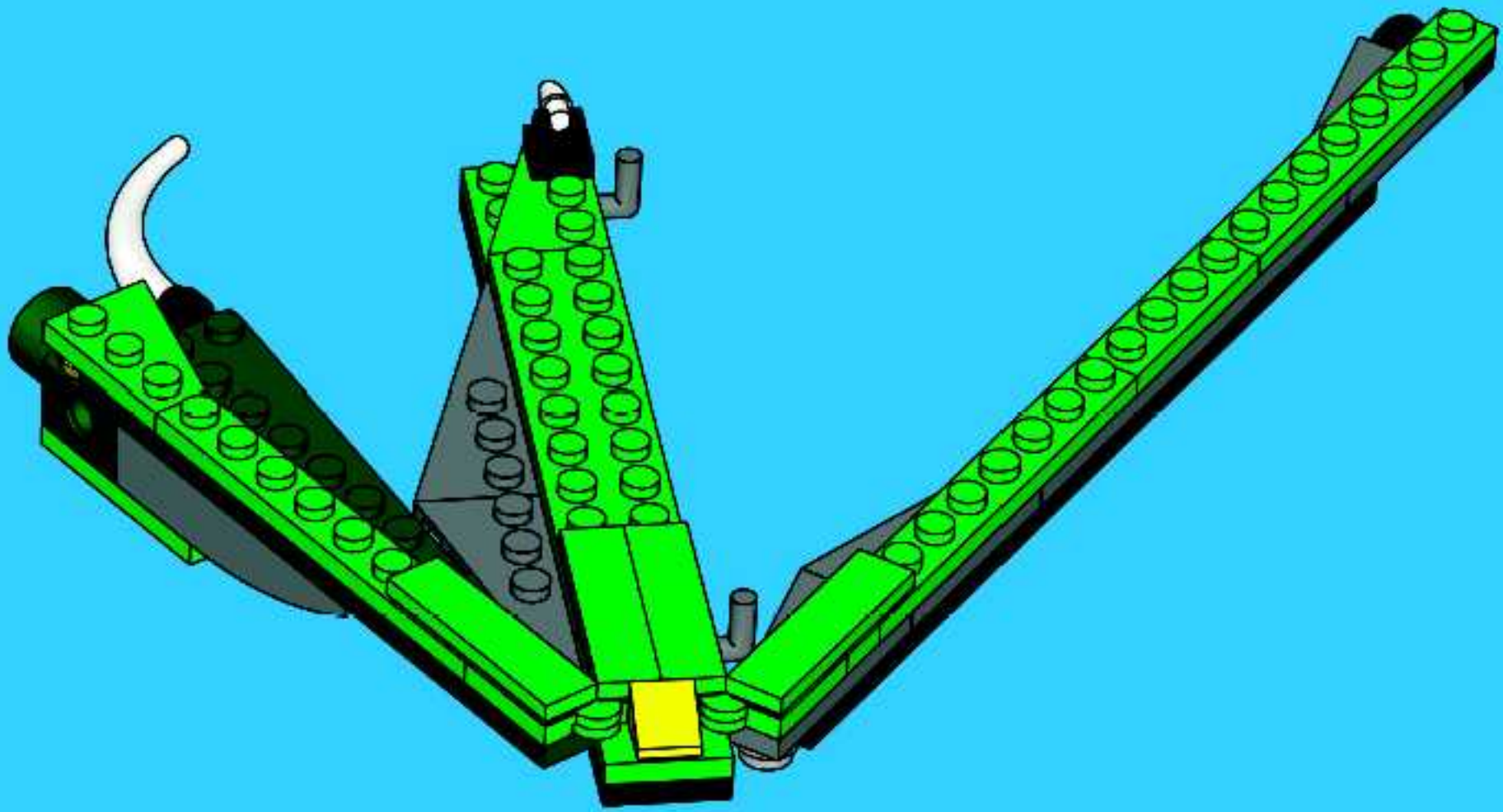

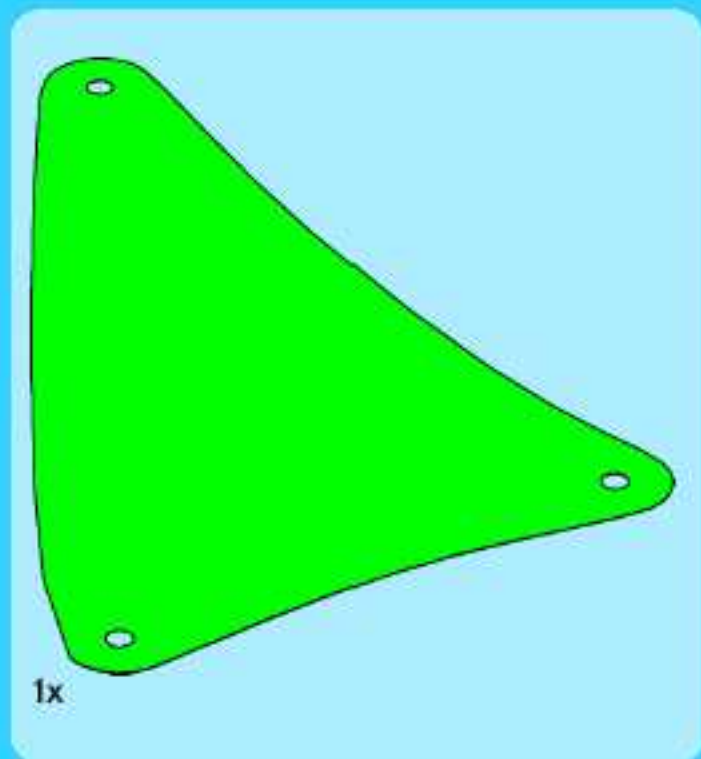

10

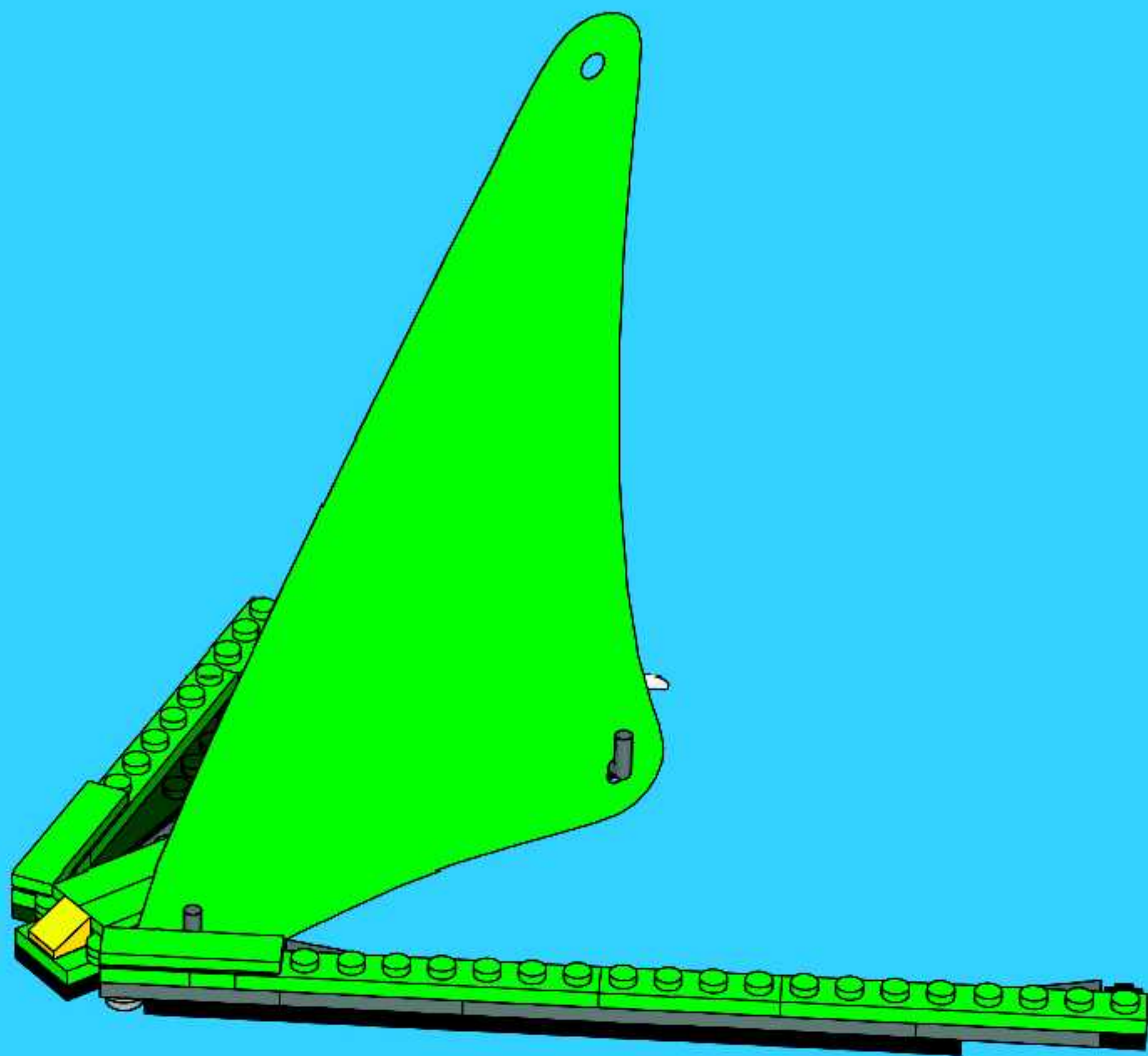



11

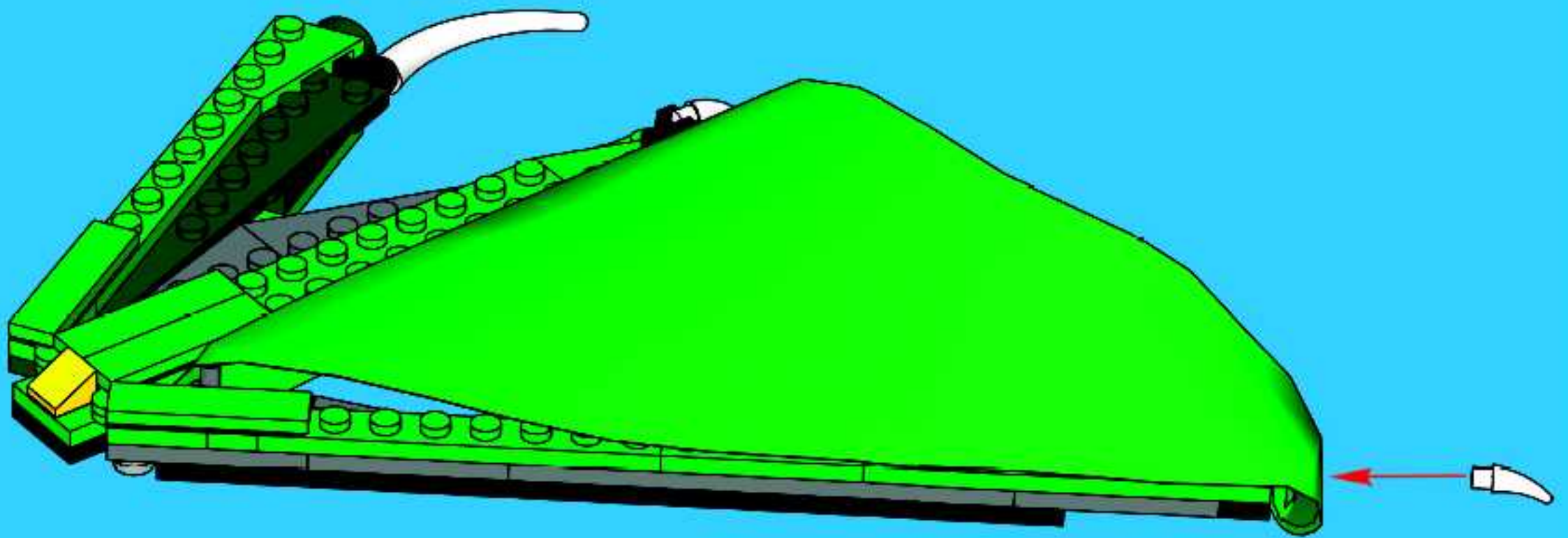

26



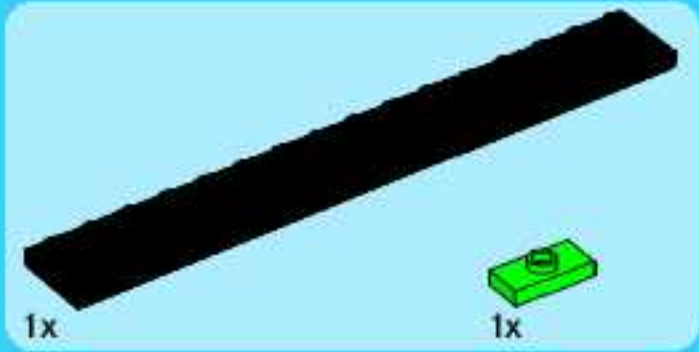
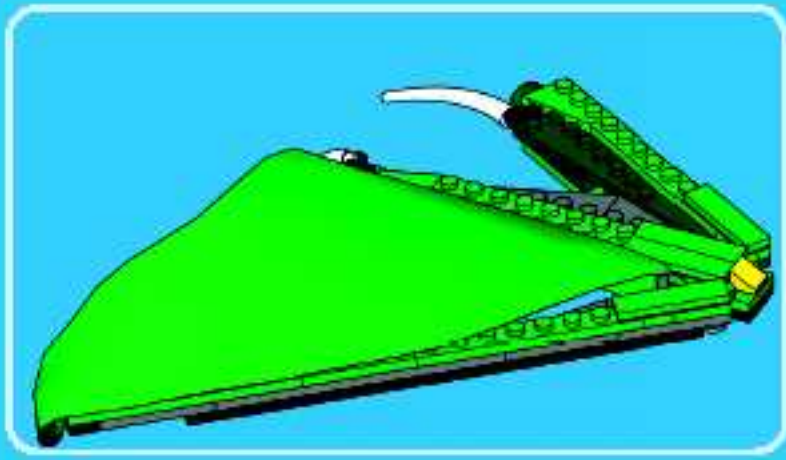

1

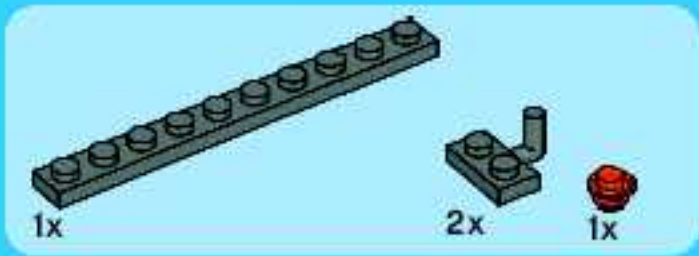

2

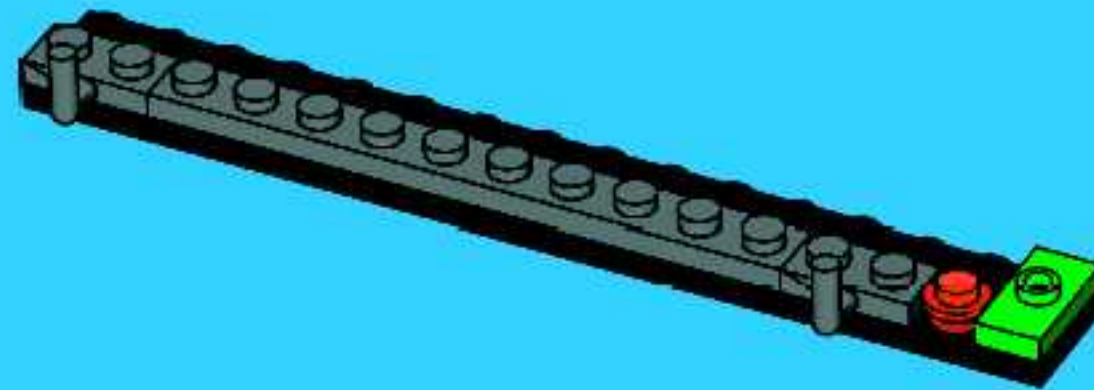

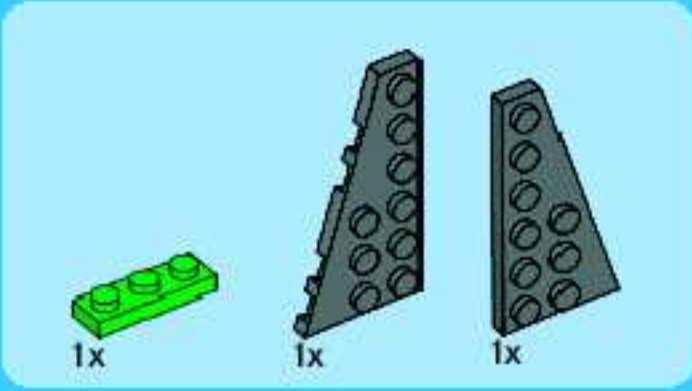

3

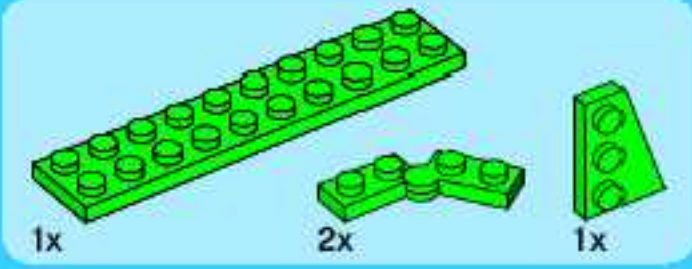
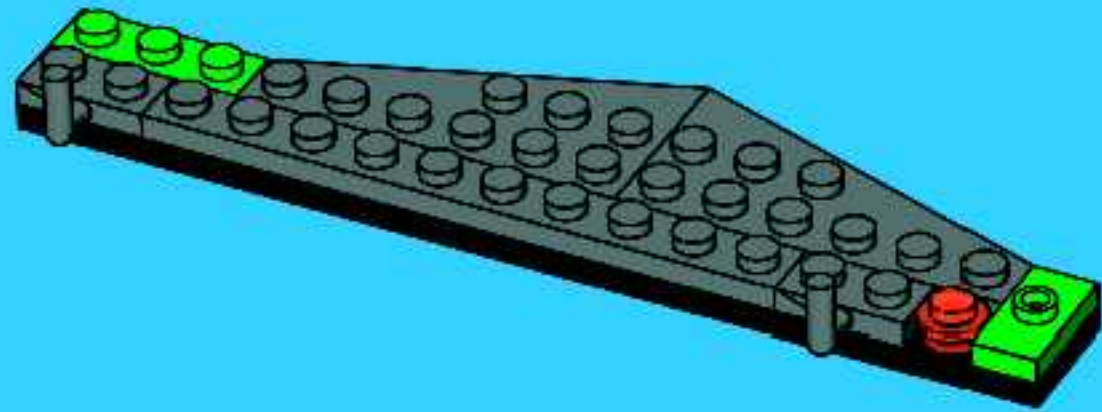

4

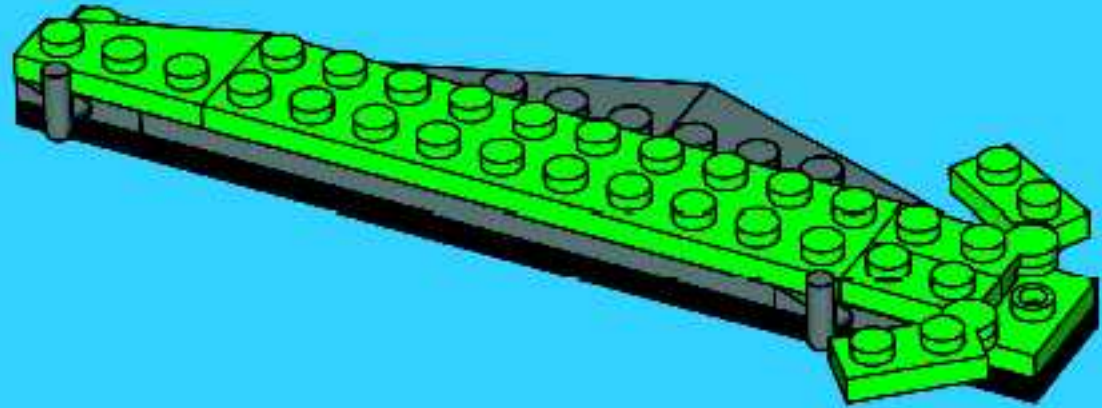

5

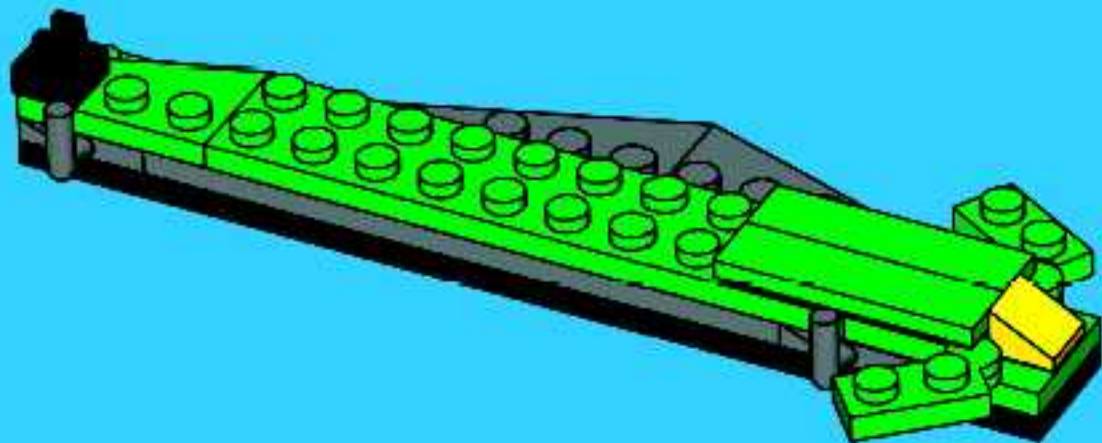

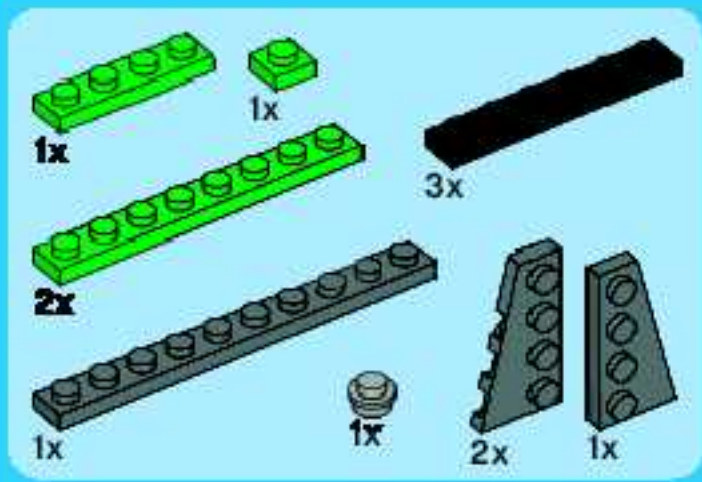

6

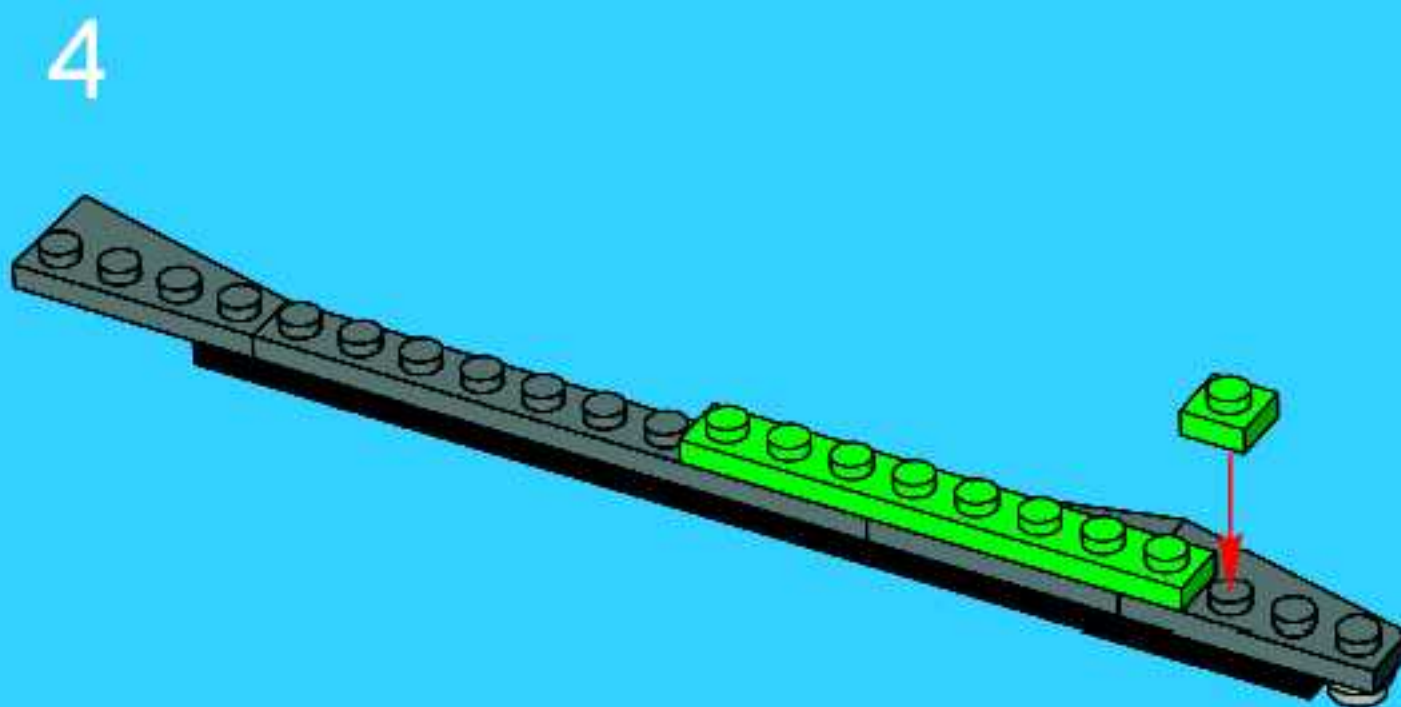
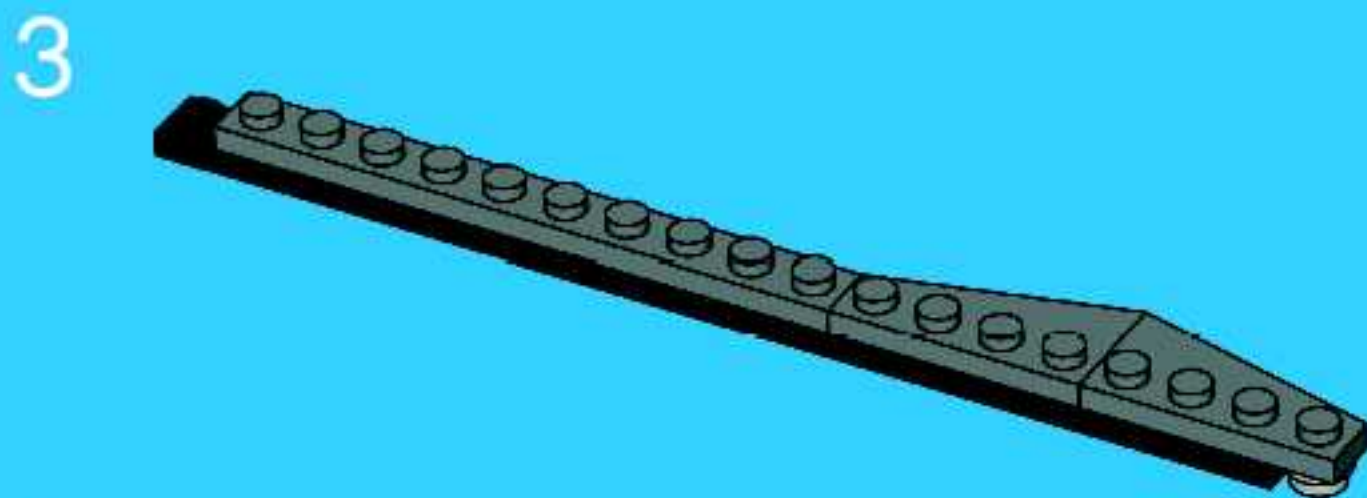
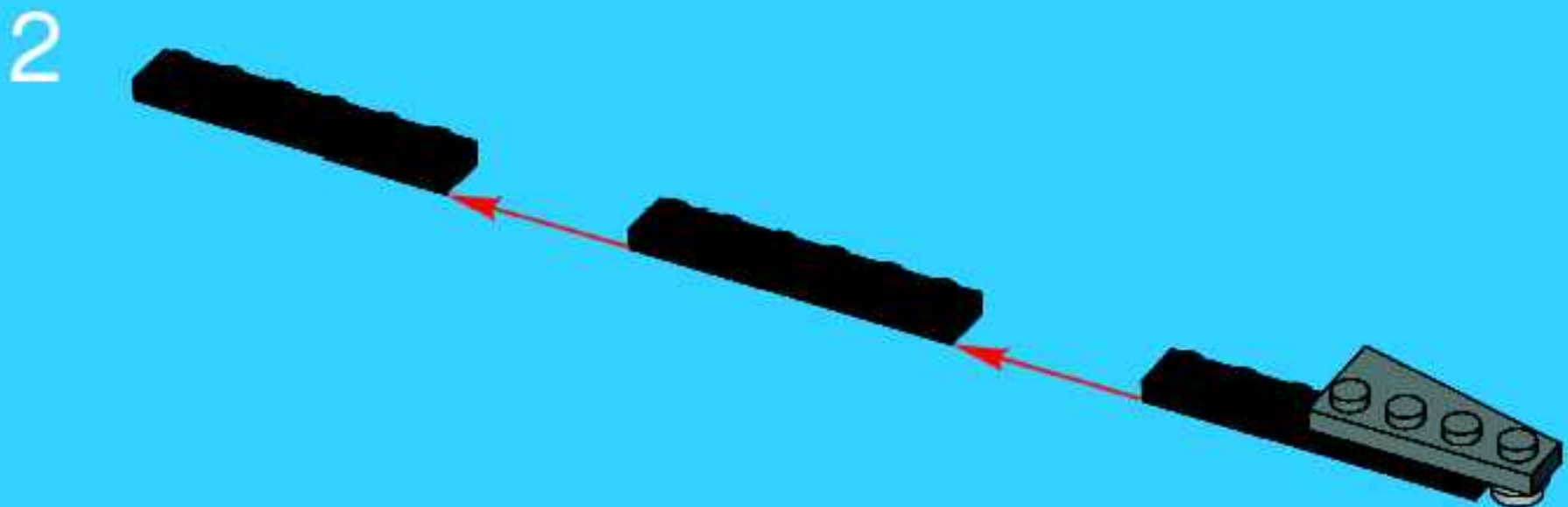

5

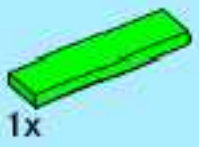
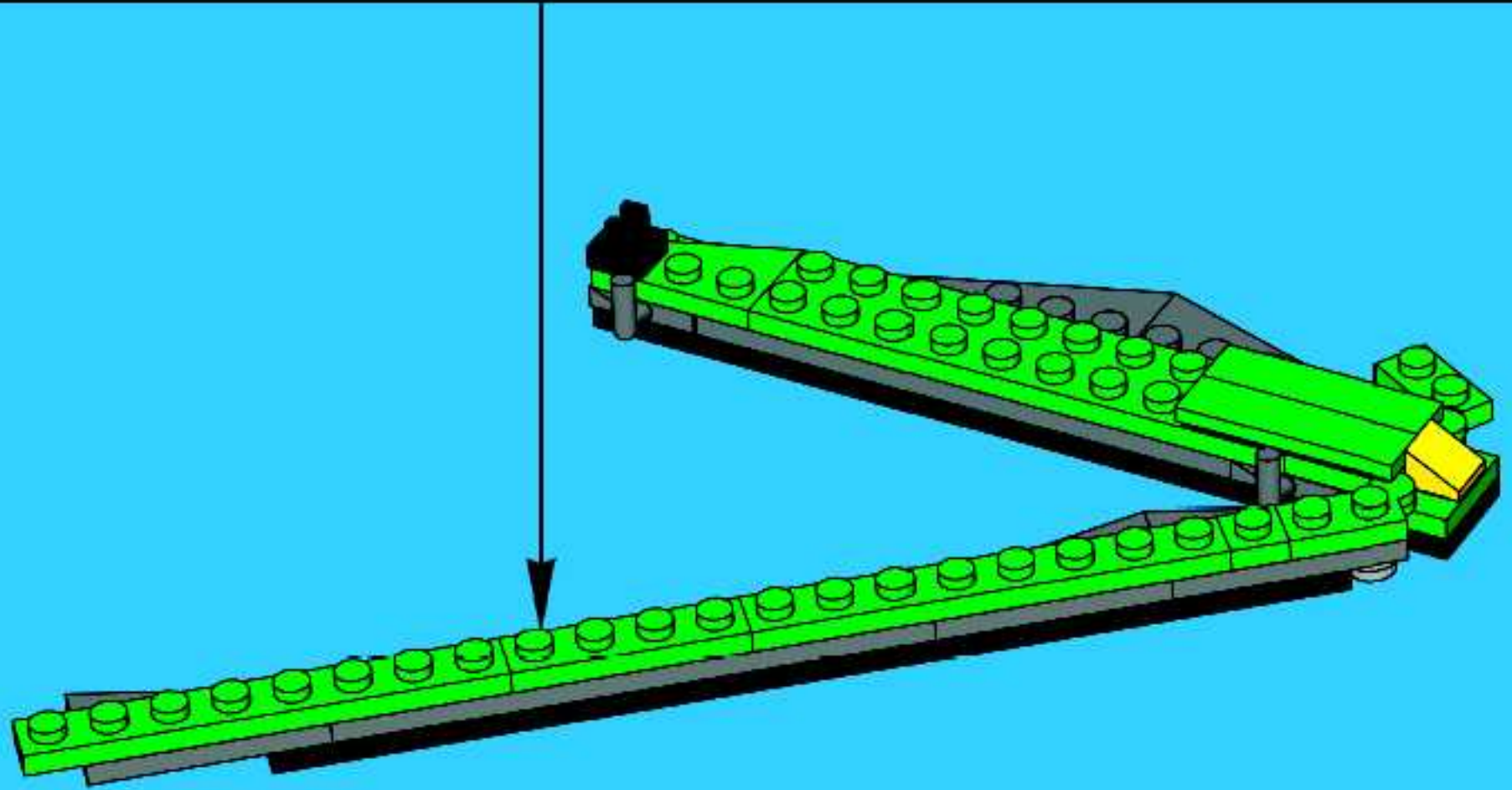
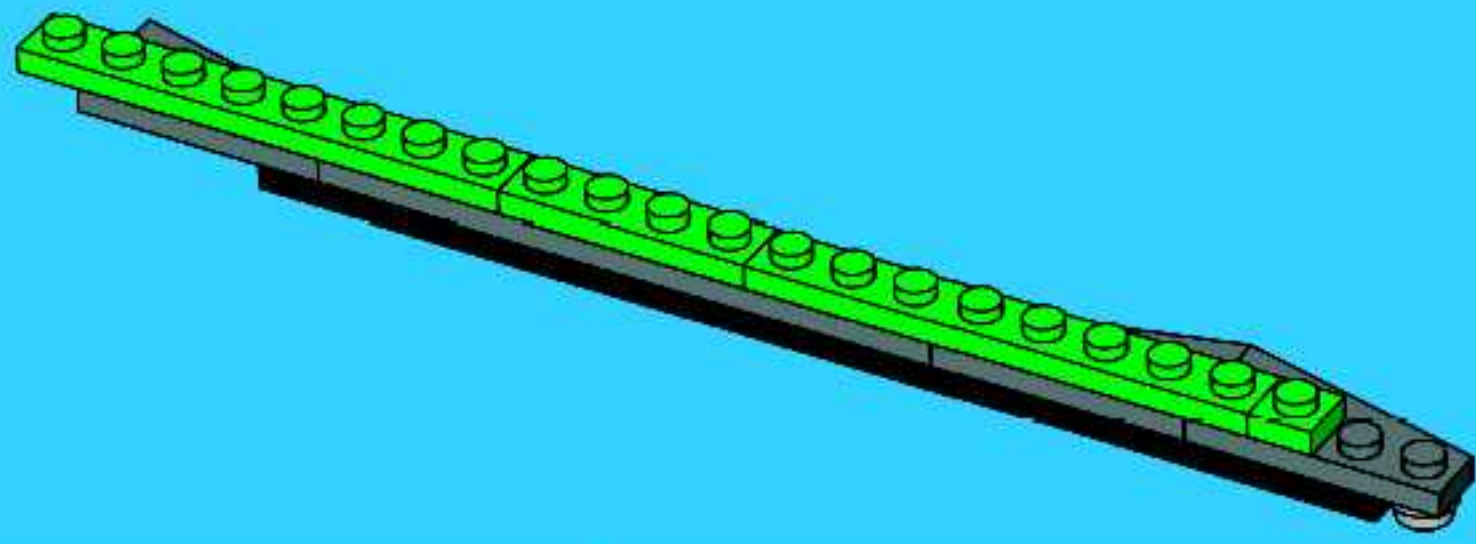

7

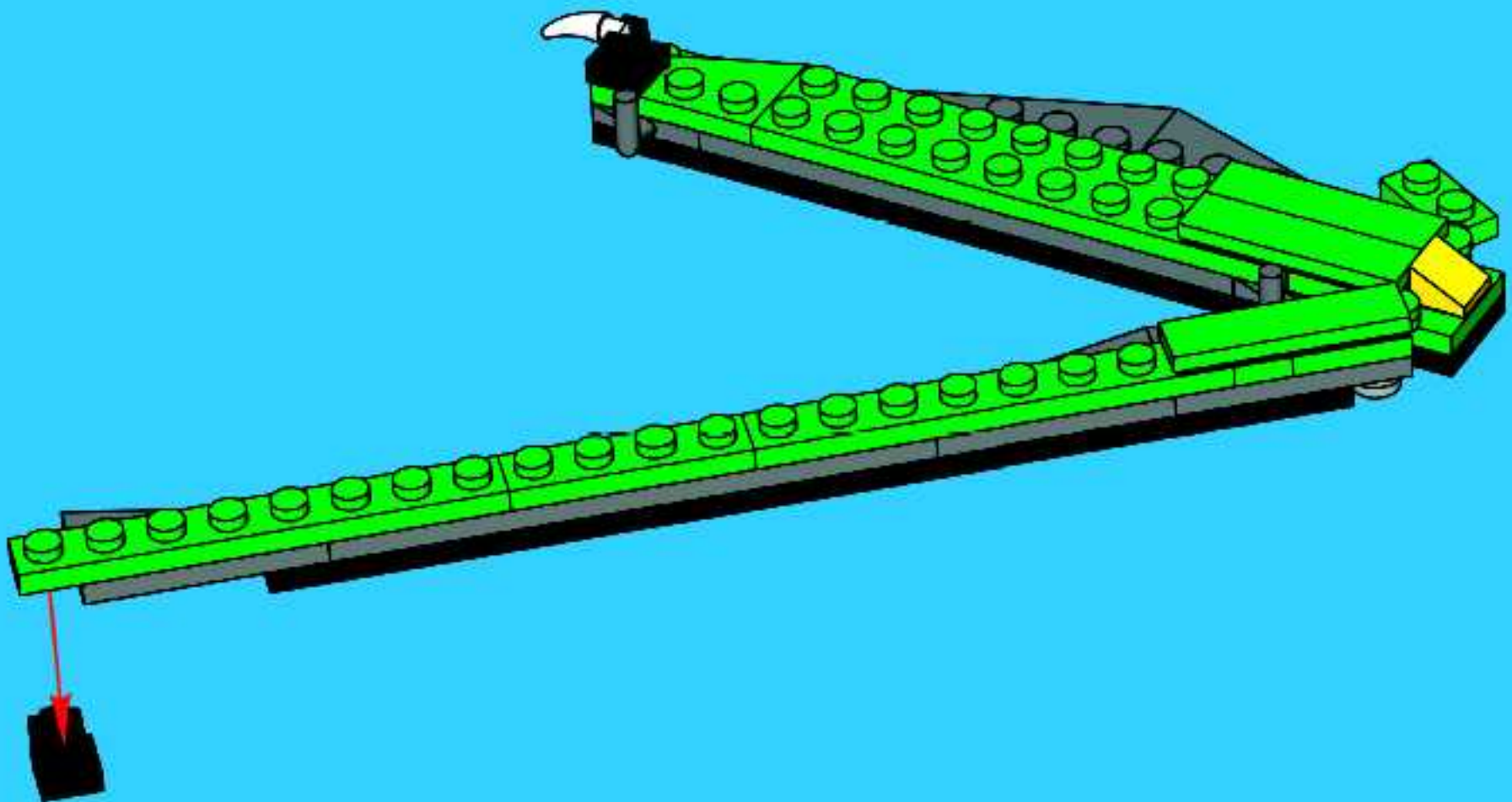

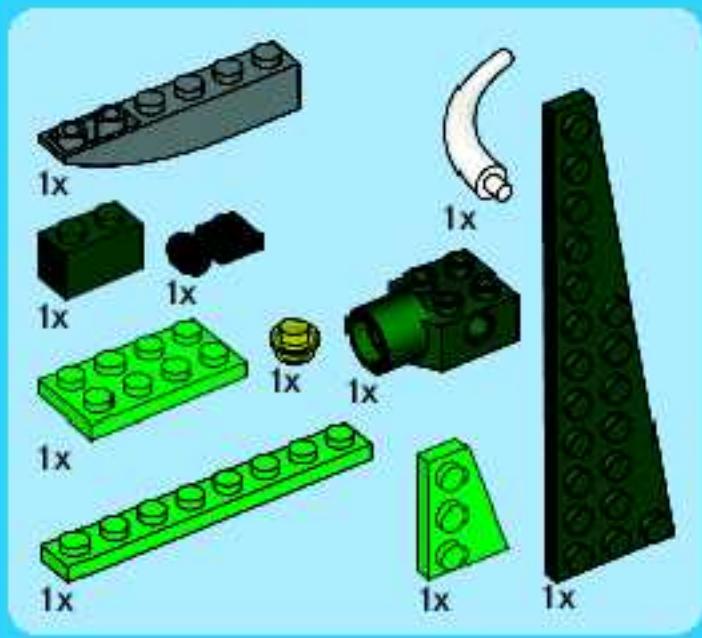

8

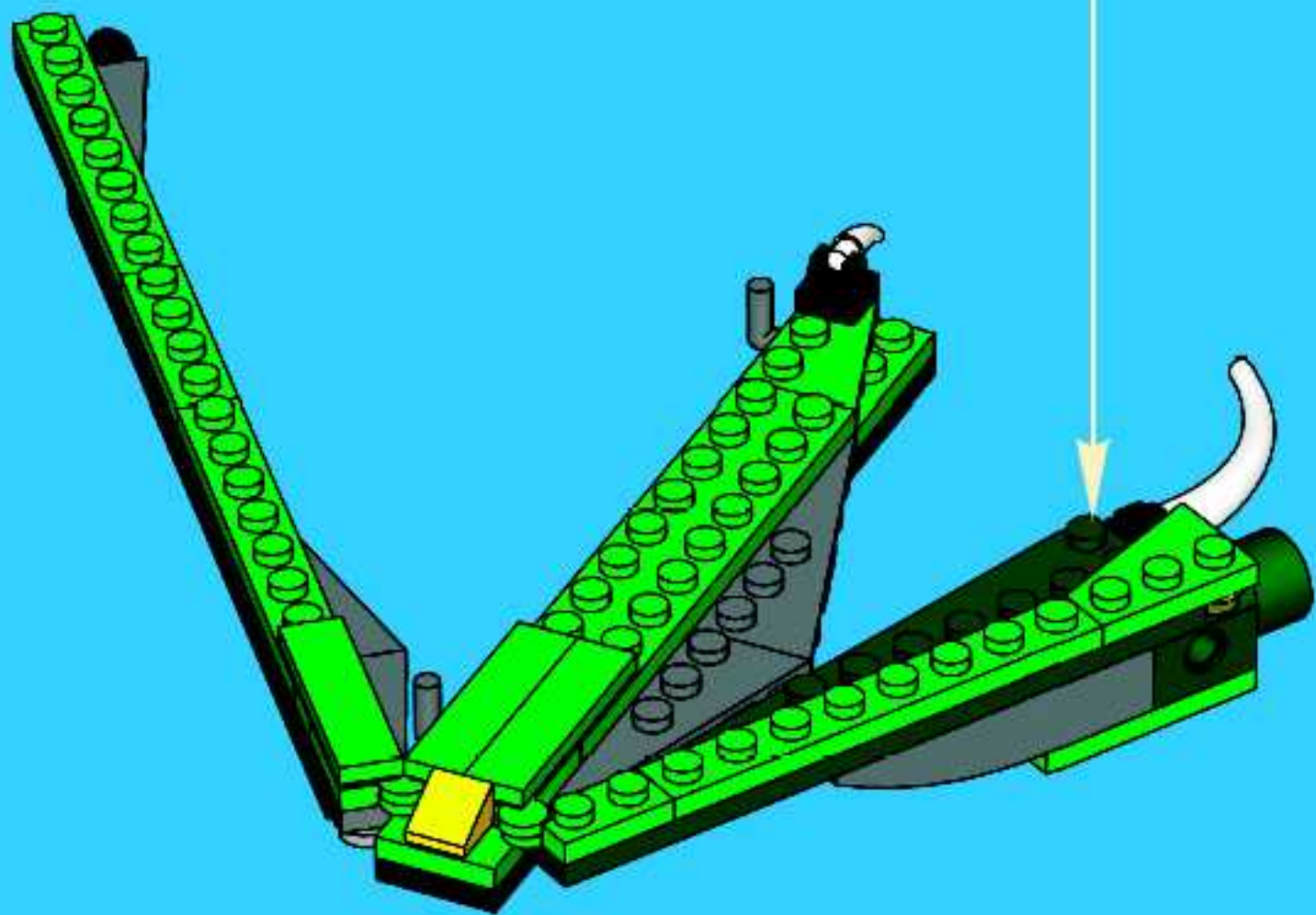
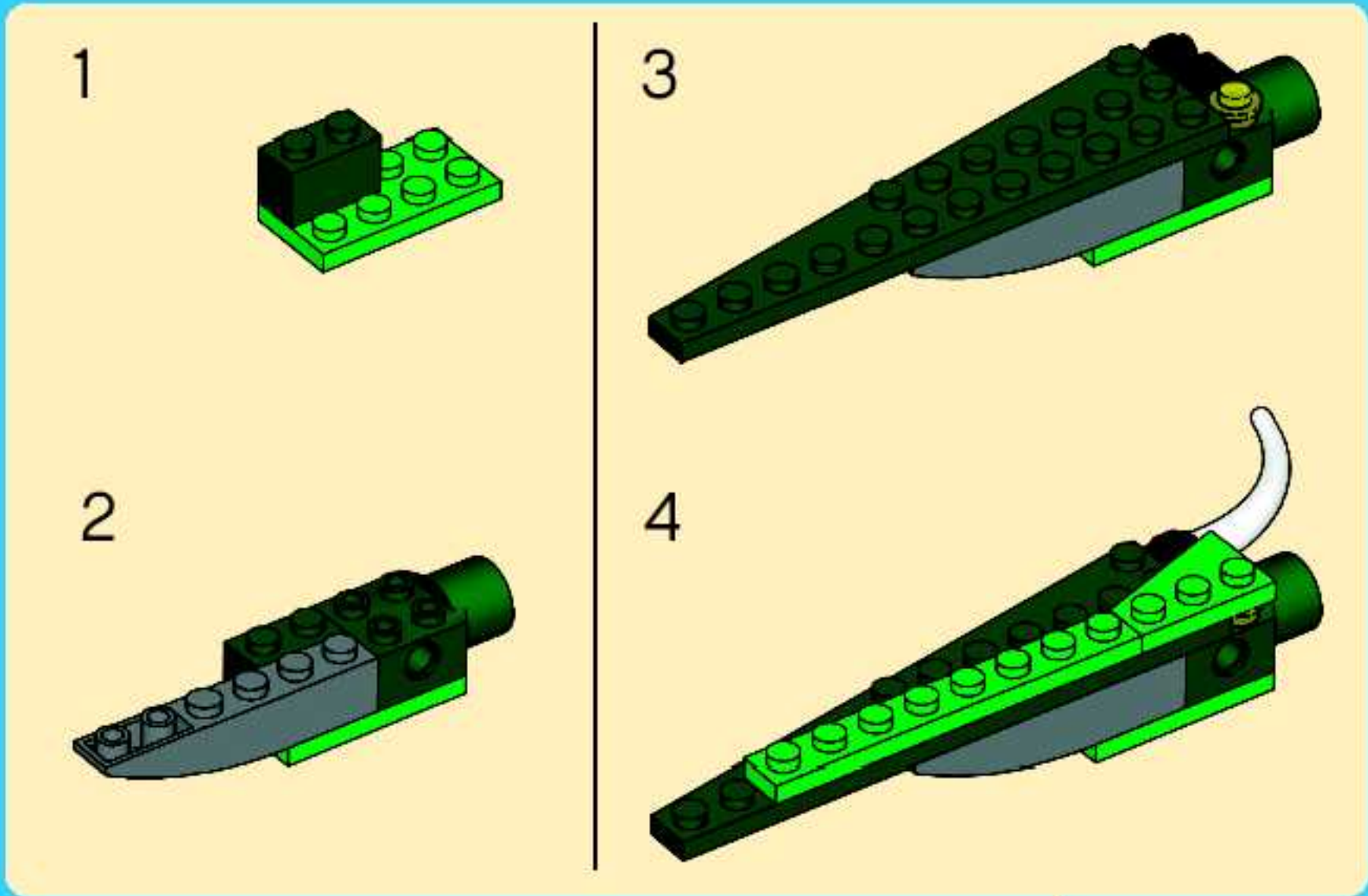

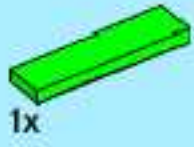

1x

9

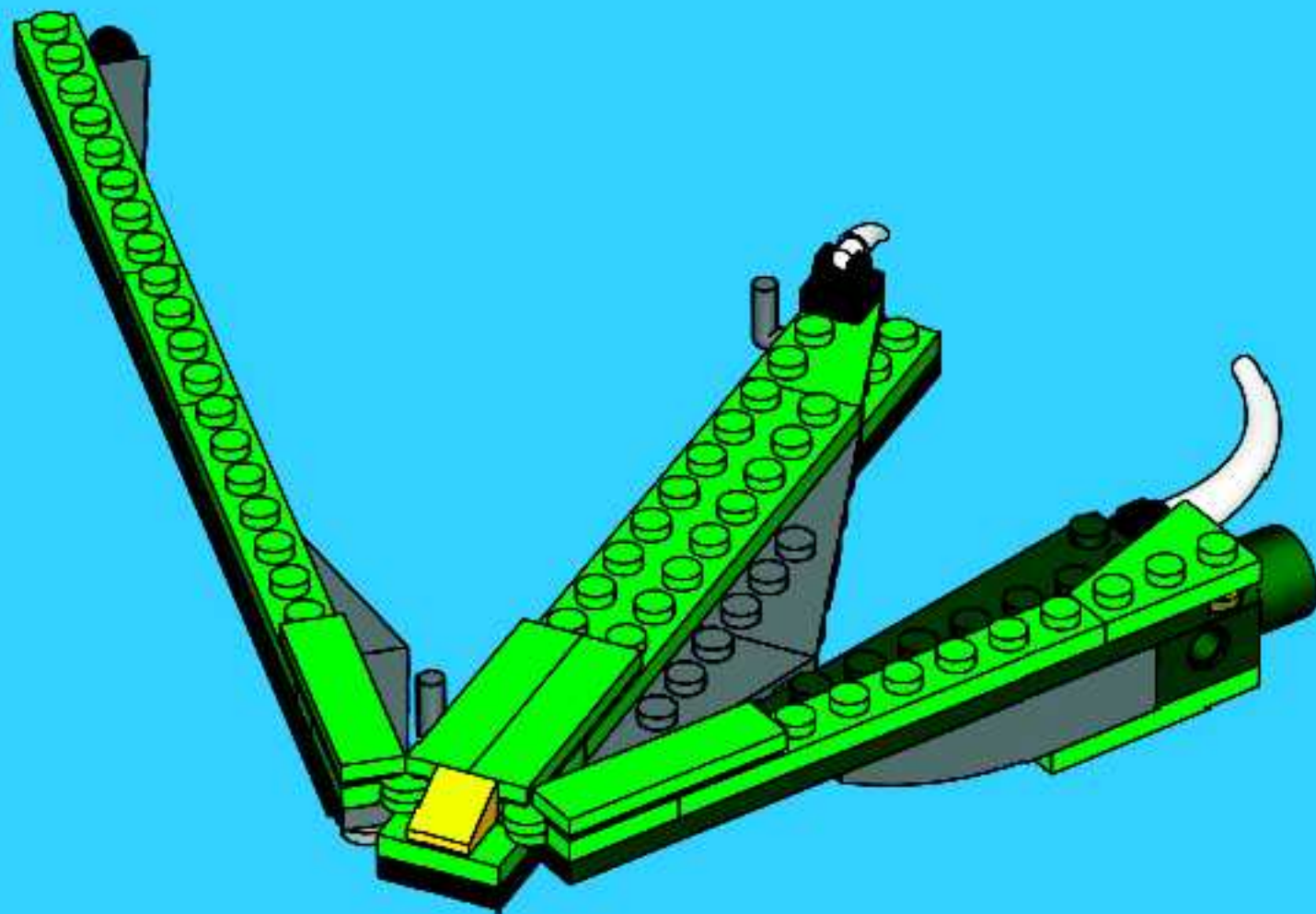

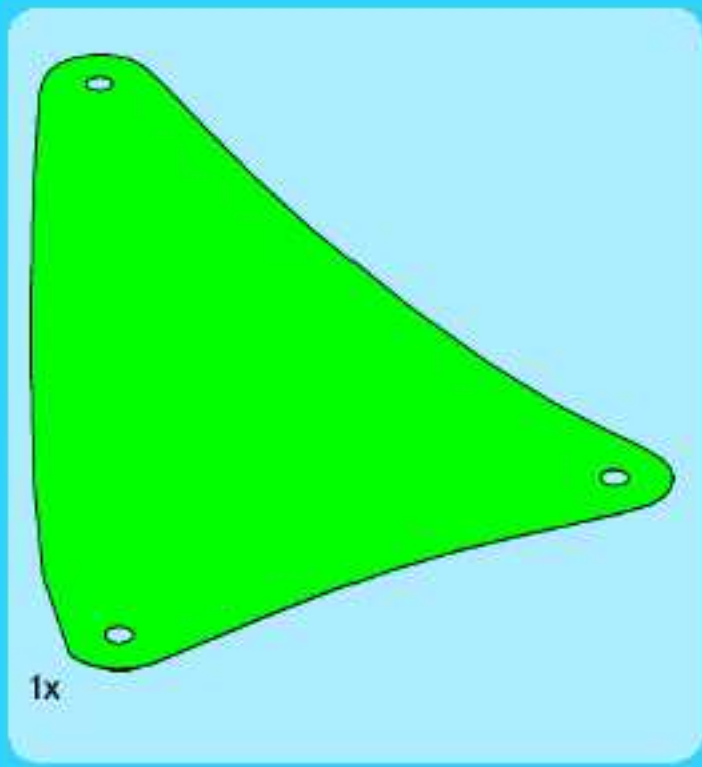

10

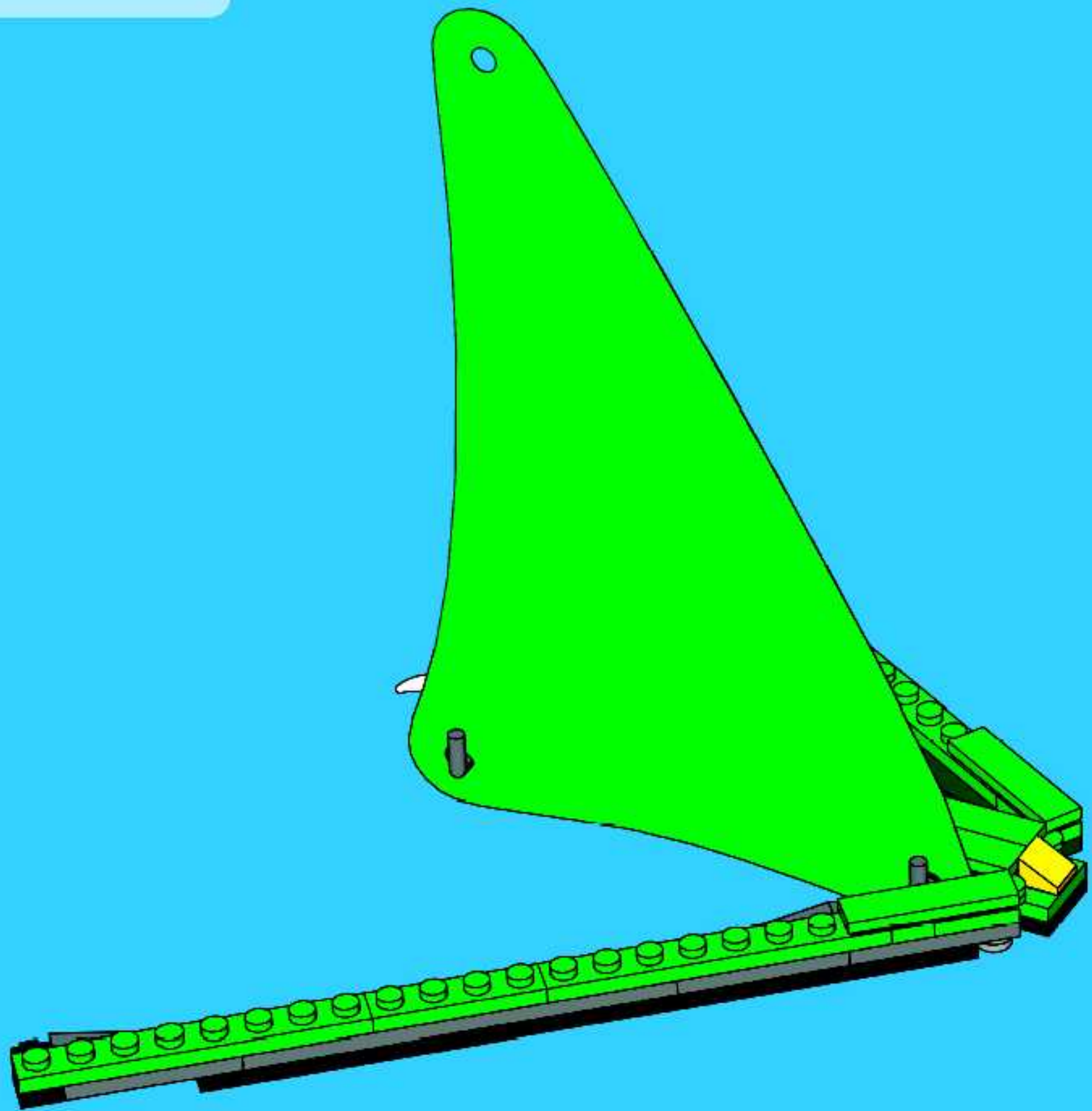



11

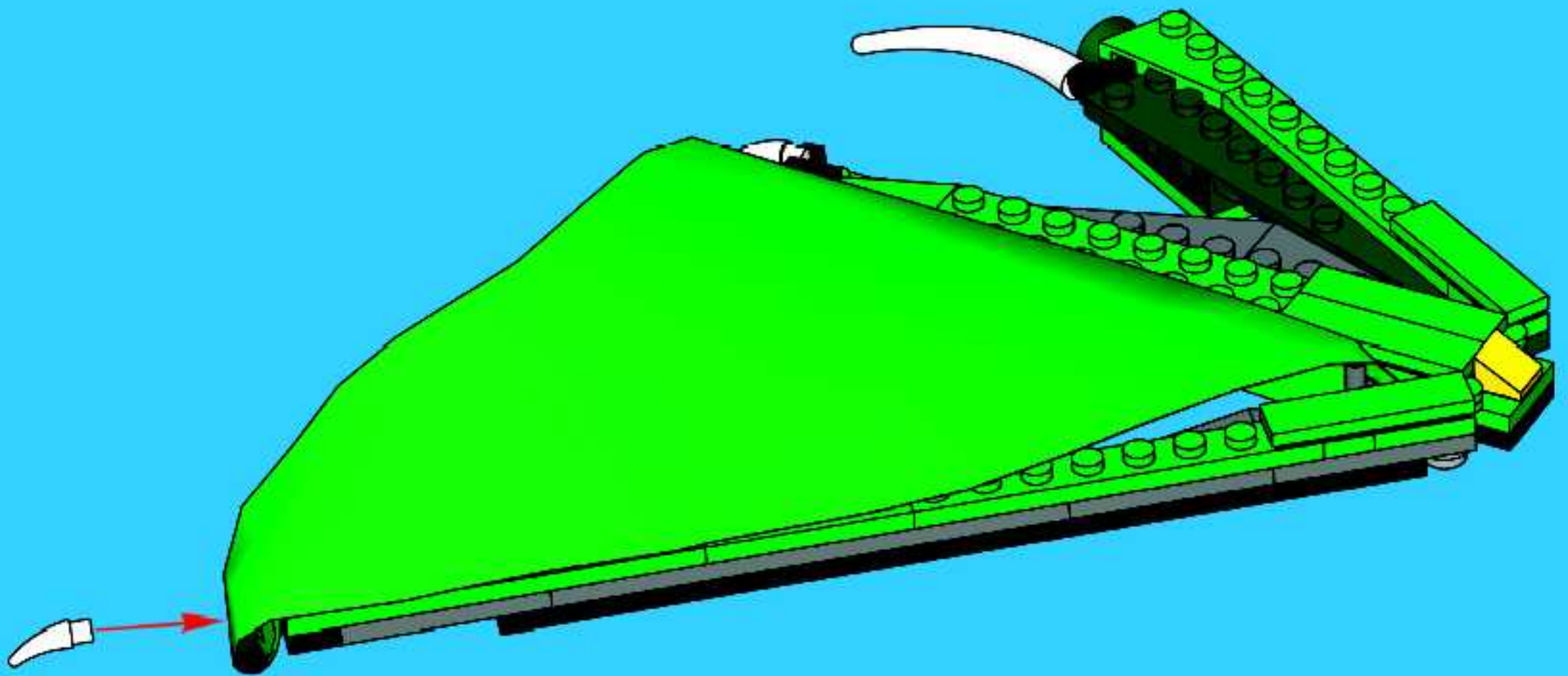

27

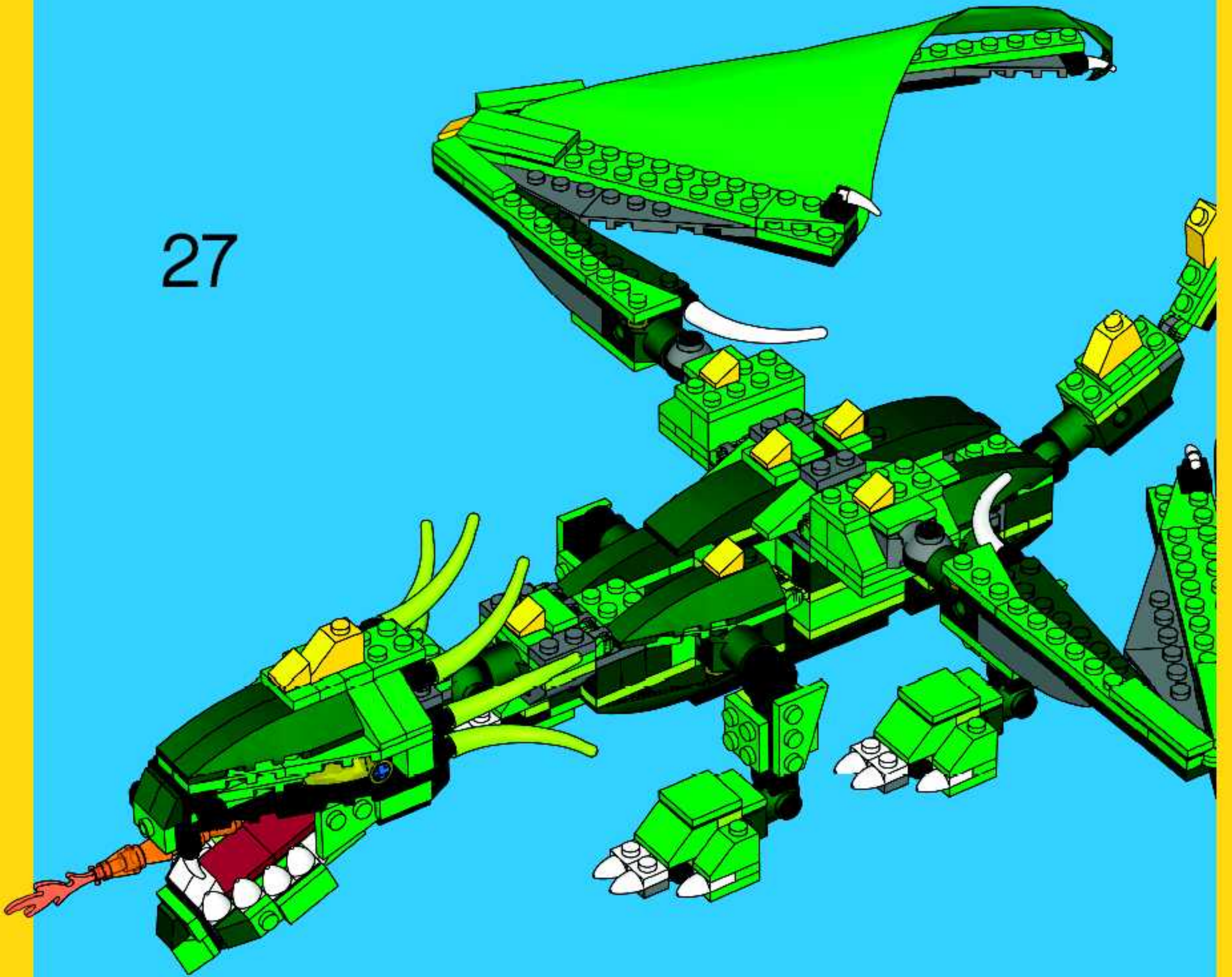

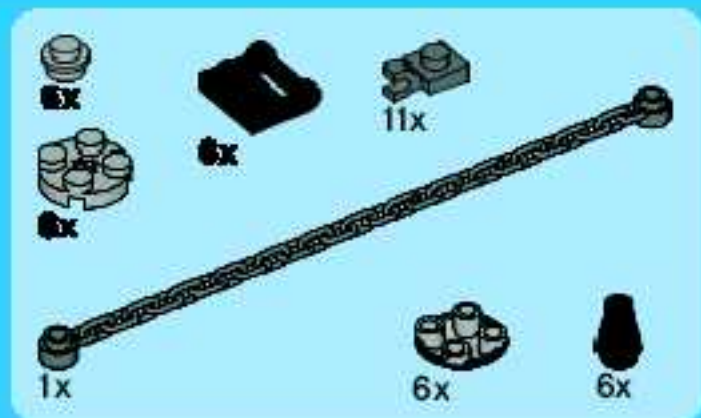

28

1. Attach the black rectangular piece to the top of the grey 1x3 Technic brick with holes. Red arrows indicate the connection points.
2. Attach the grey axle to the grey 1x3 Technic brick with holes. The chain is already attached to the axle.
3. Attach the black rectangular piece to the axle. Red arrows indicate the connection points.
4. Attach the grey circular piece to the black rectangular piece. Red arrows indicate the connection points.

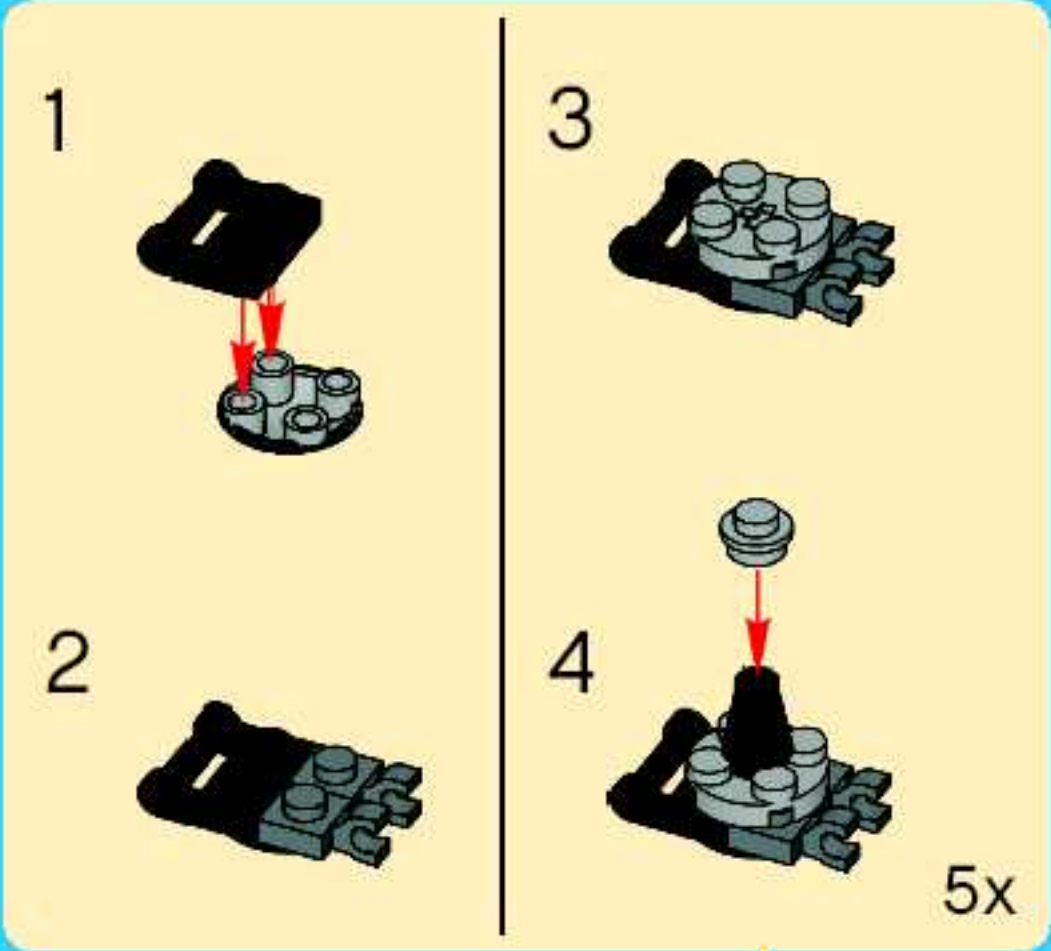

5

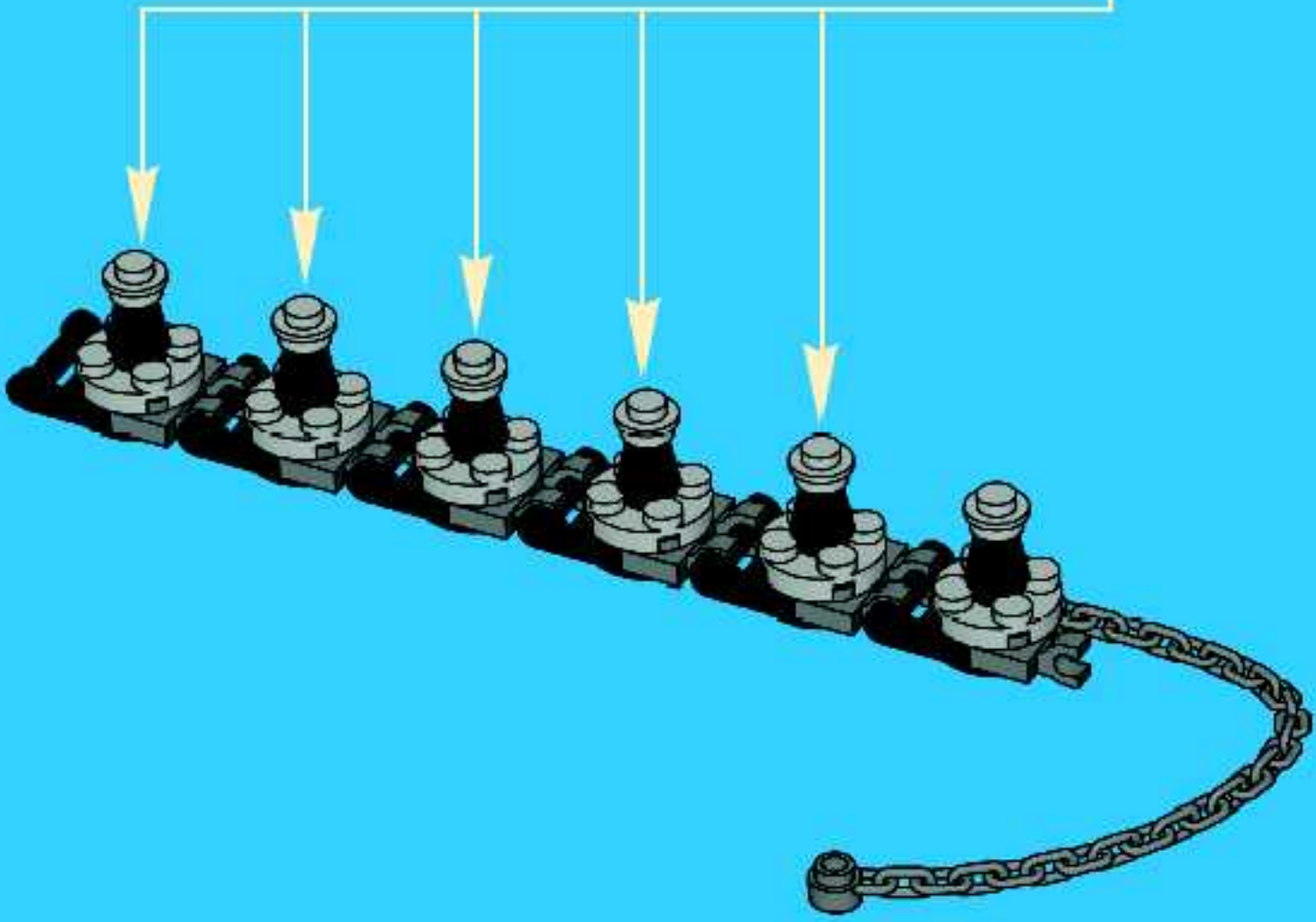

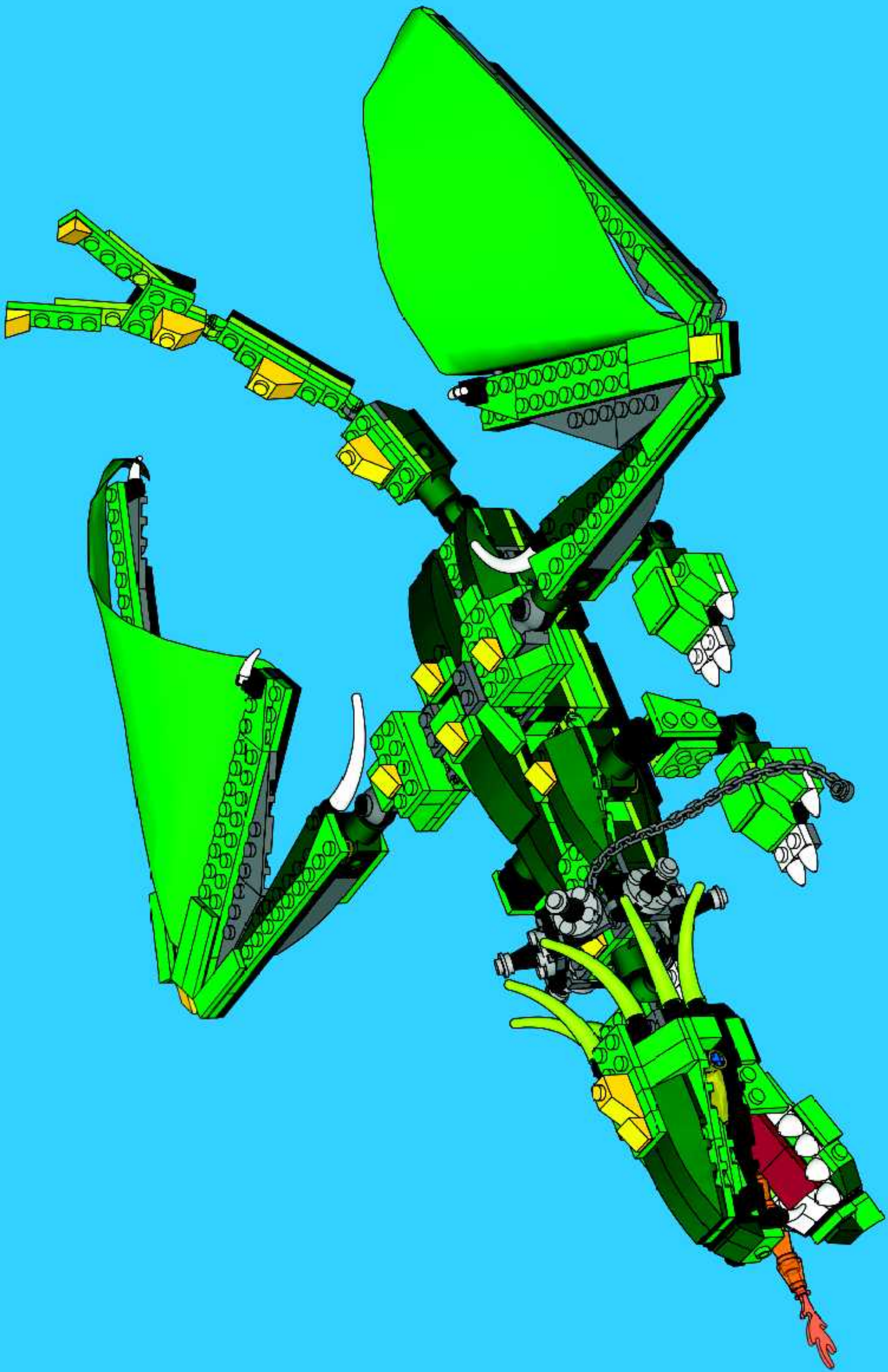

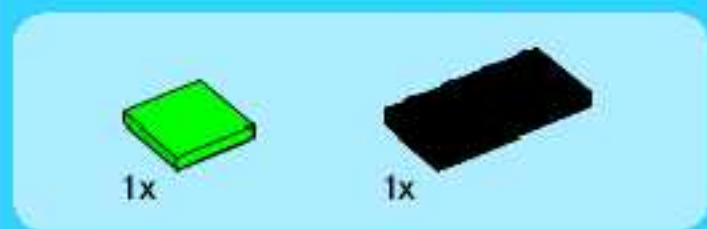
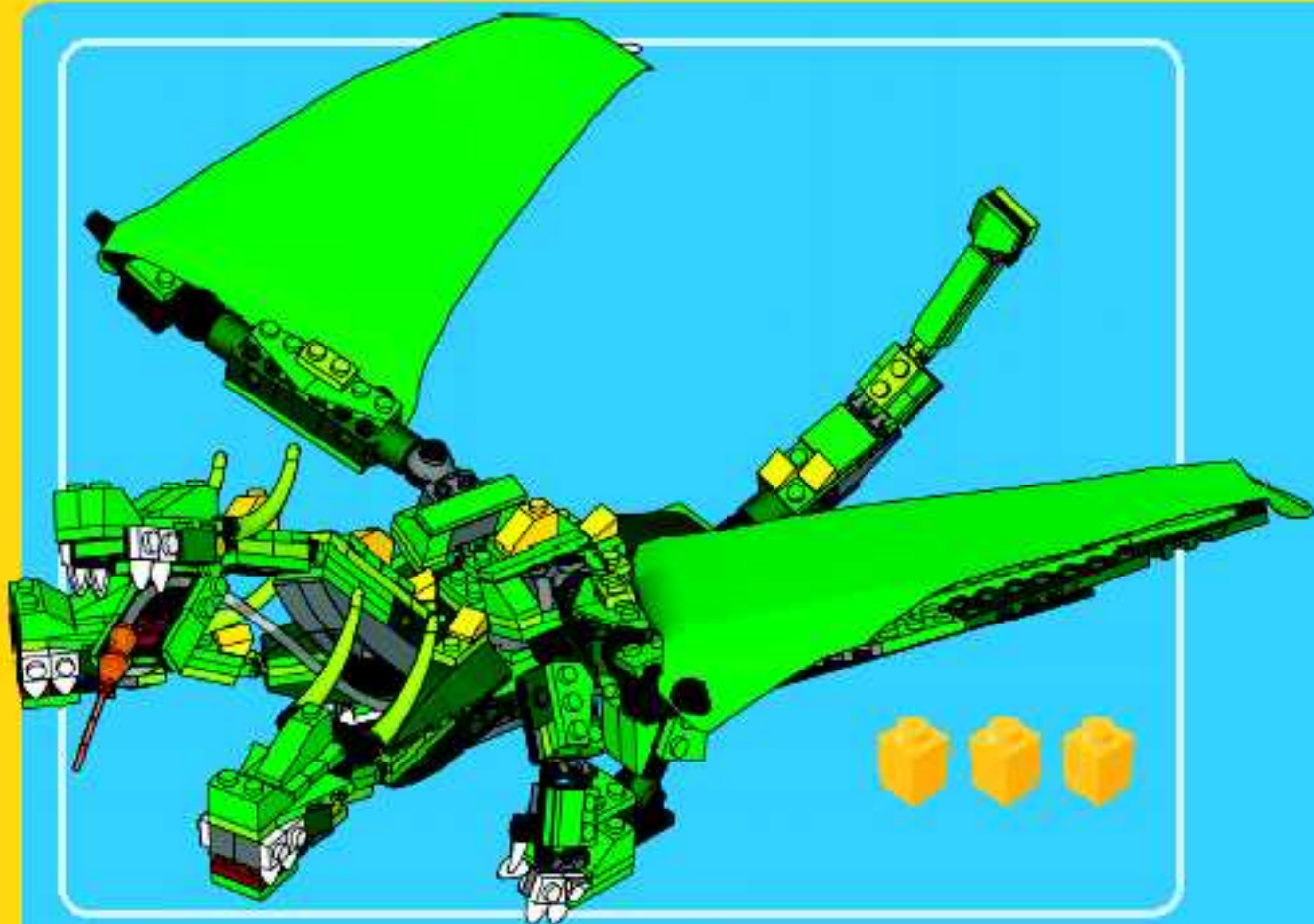

1

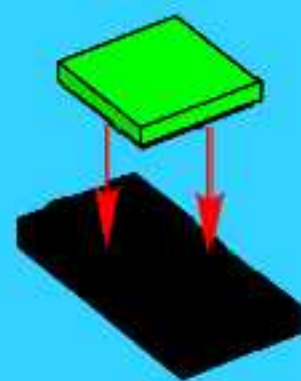

2

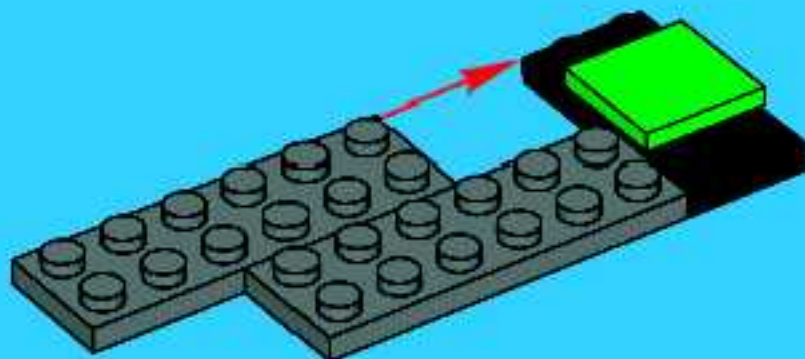

3

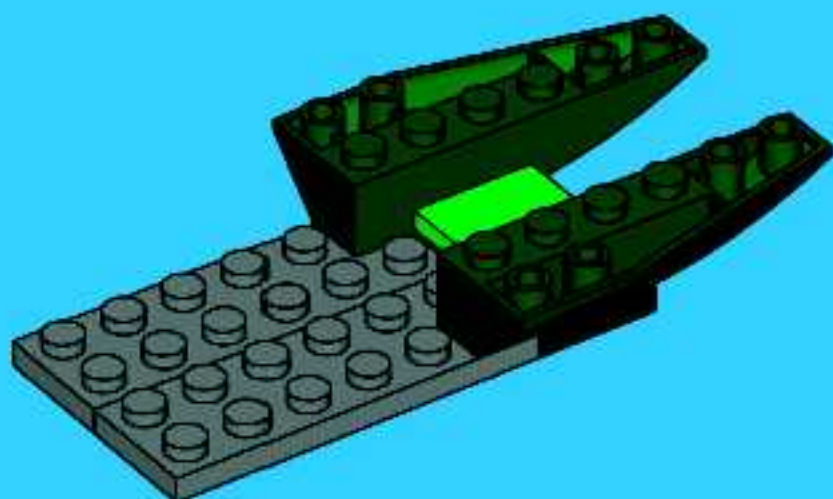

4

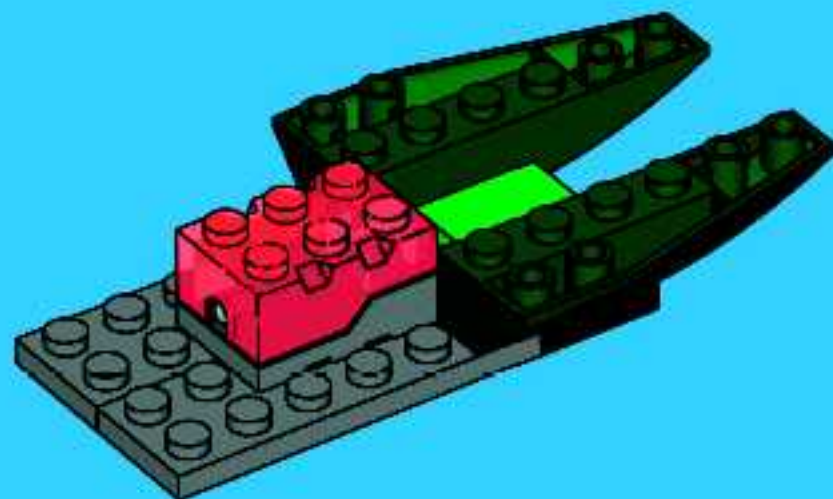

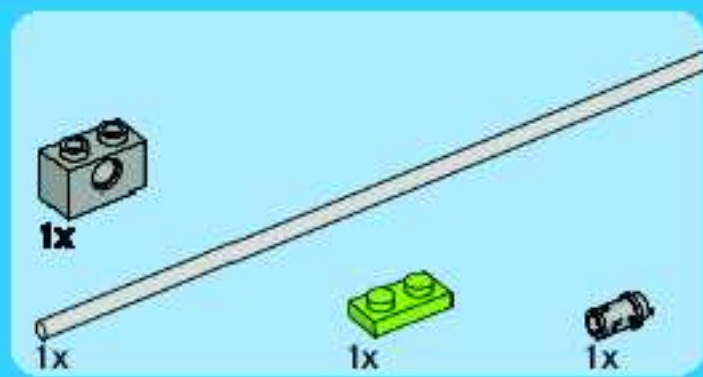

5

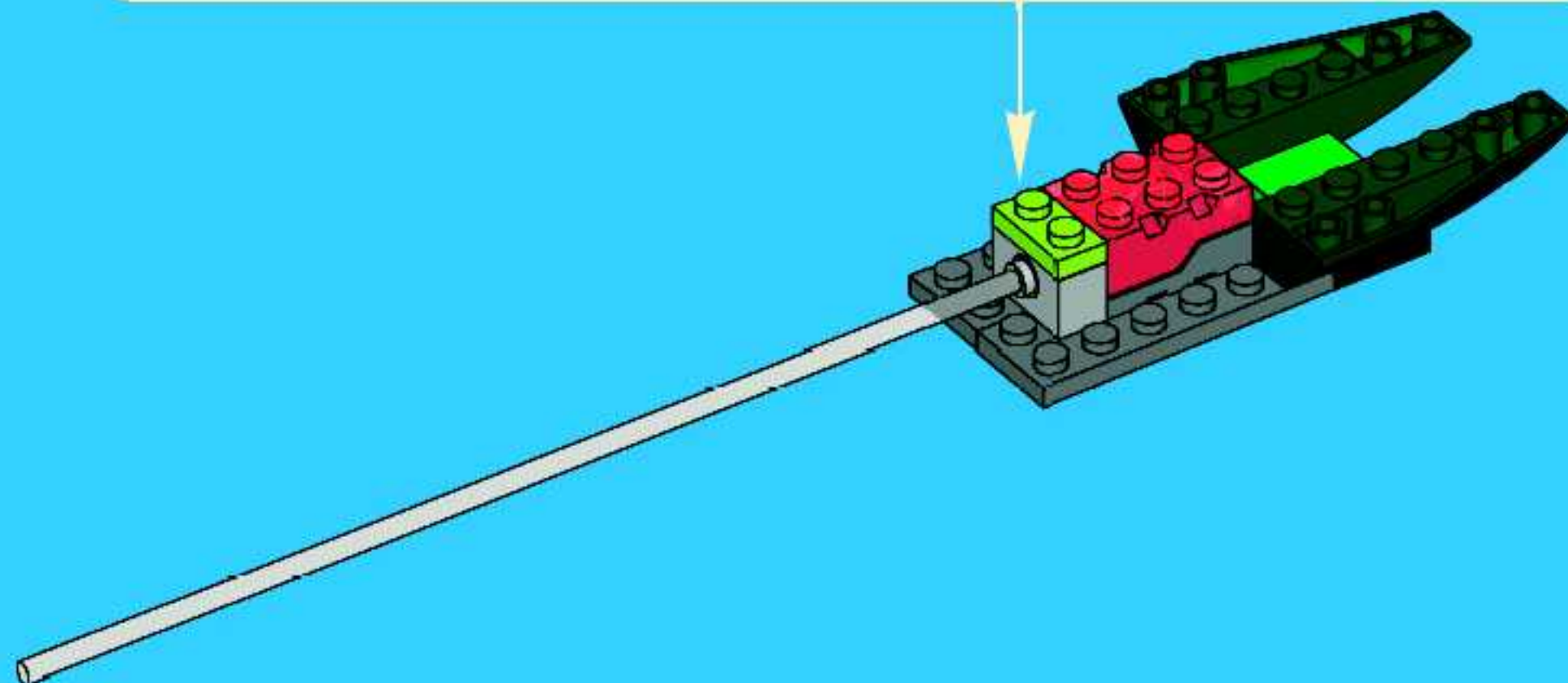
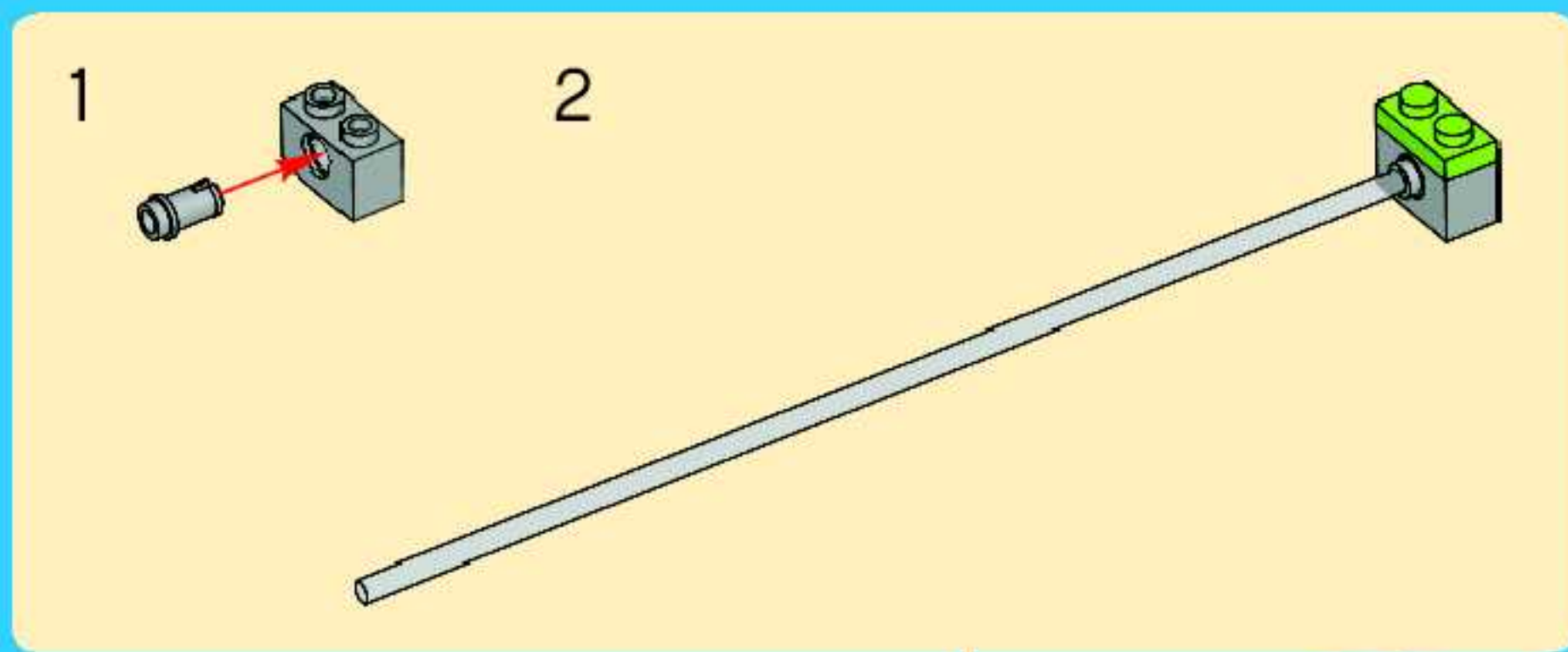

6

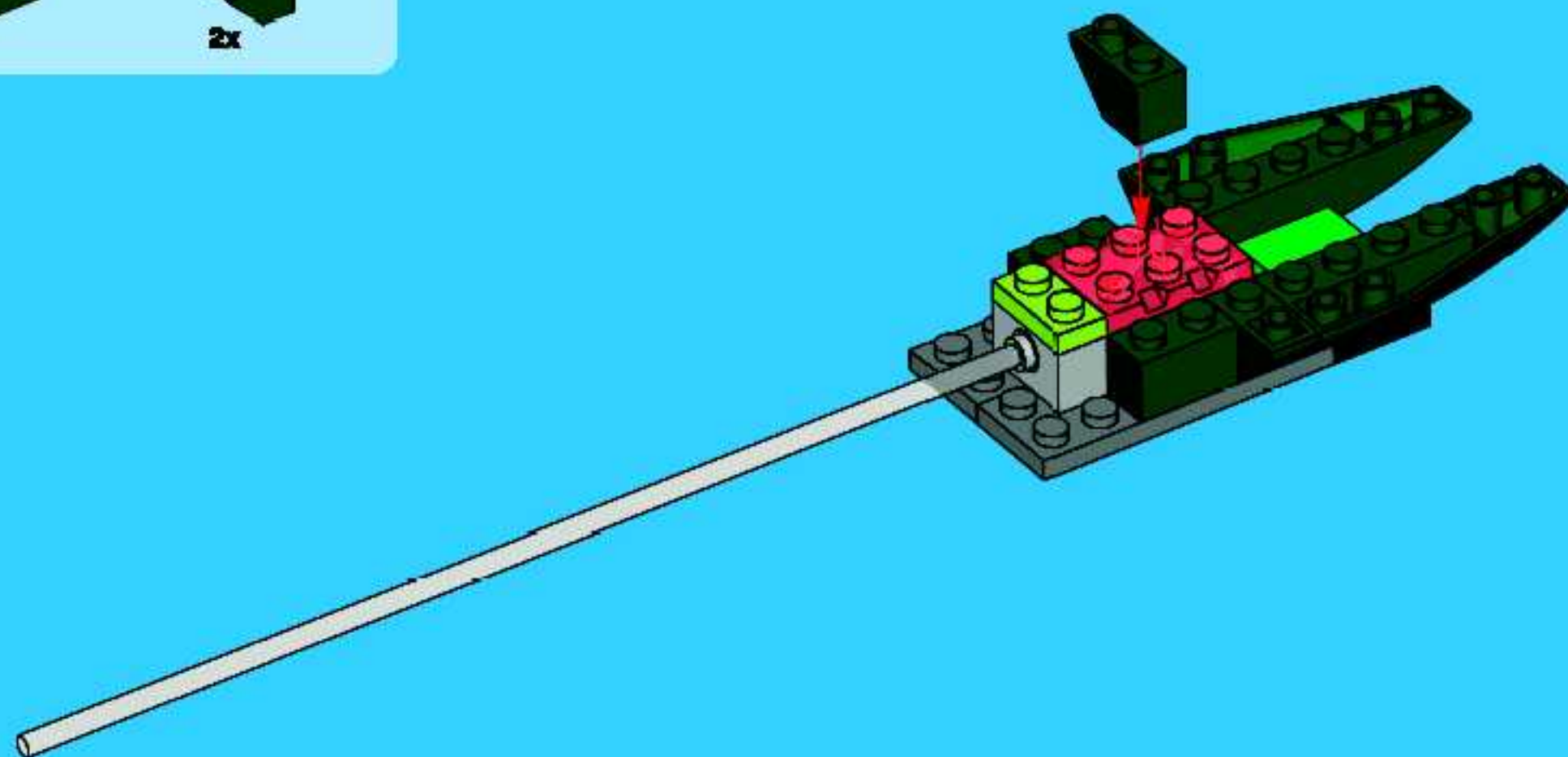



7

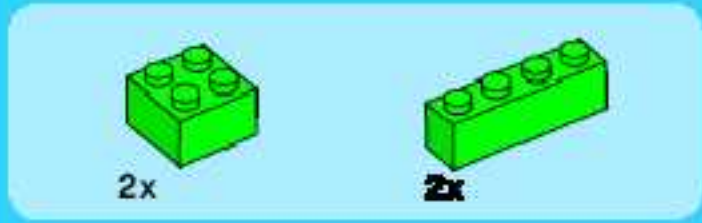
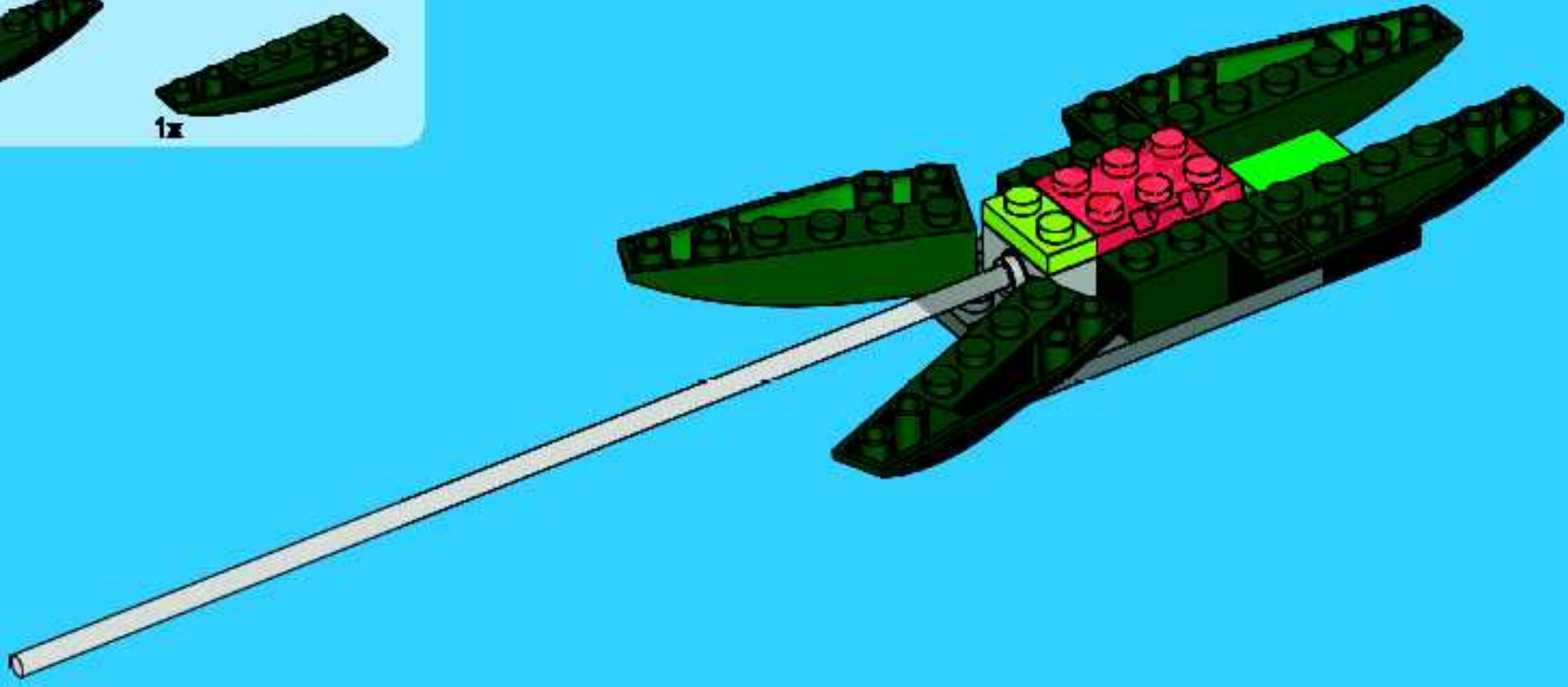

8

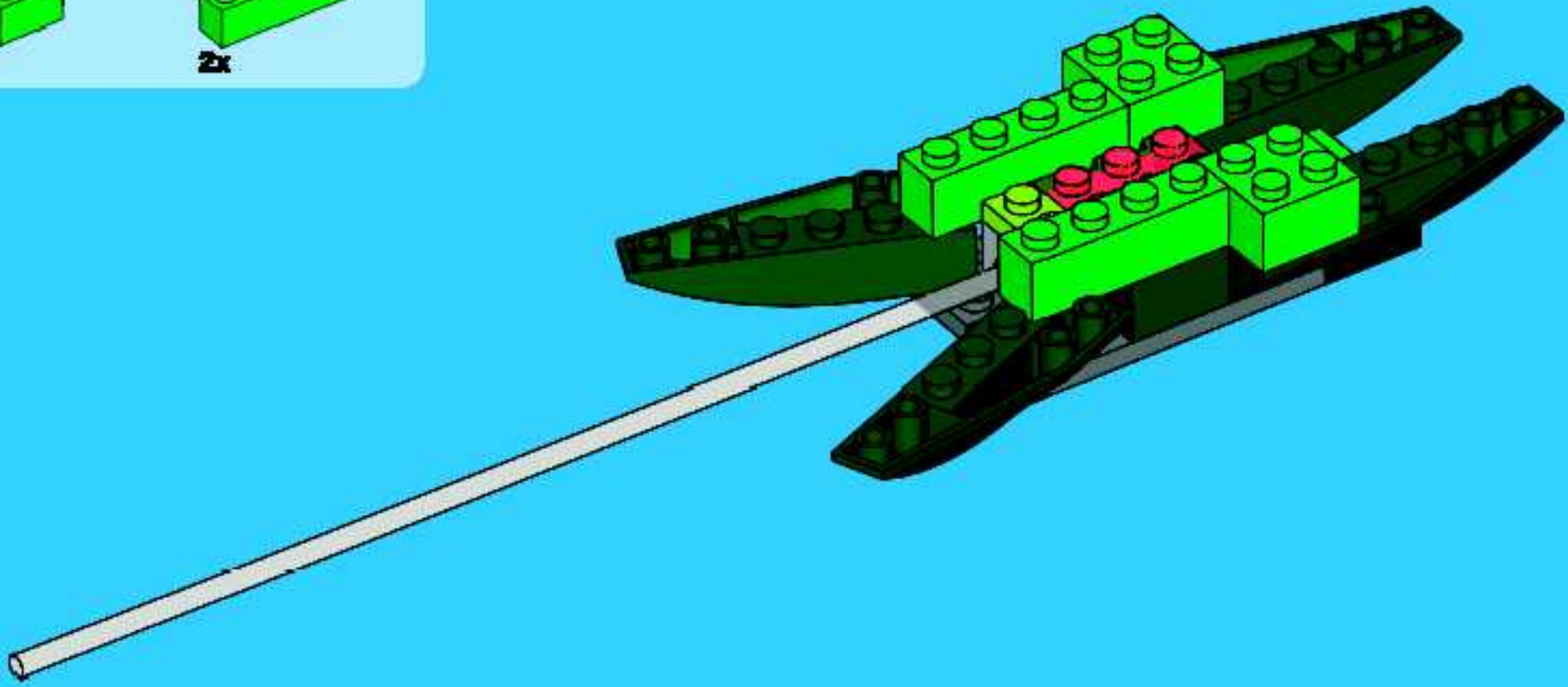

9

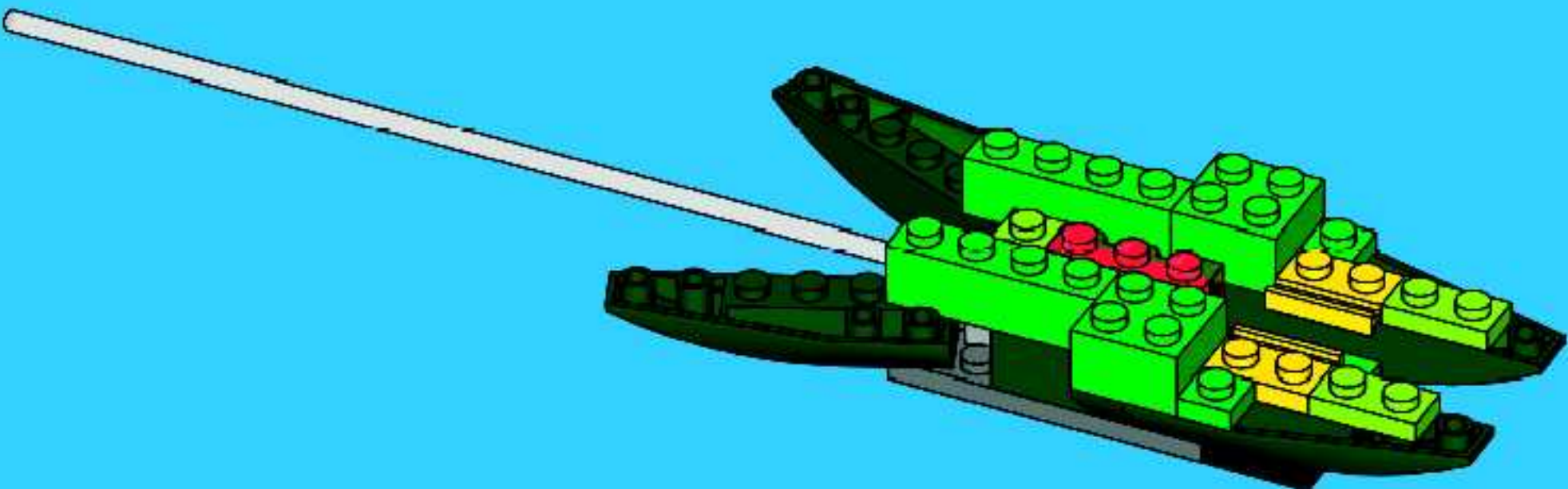

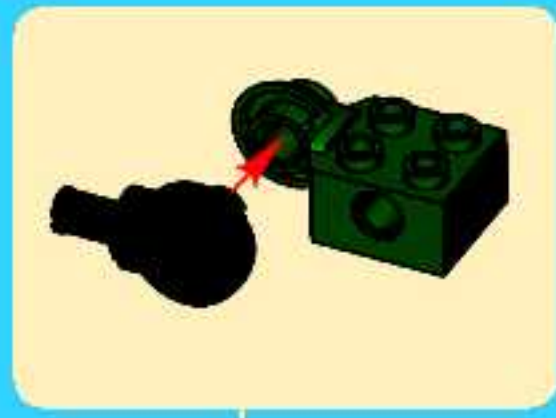
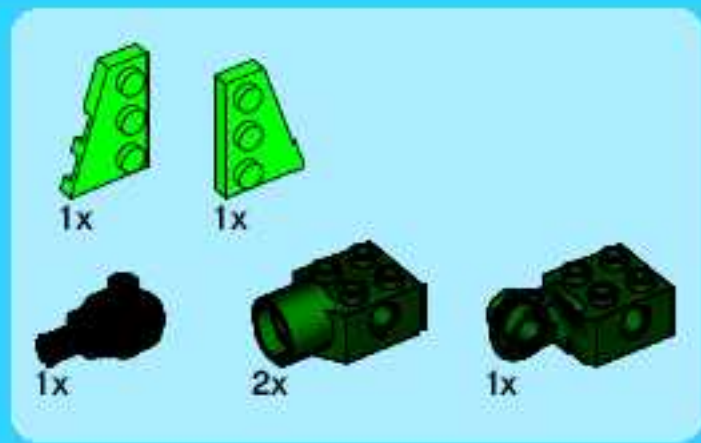

10

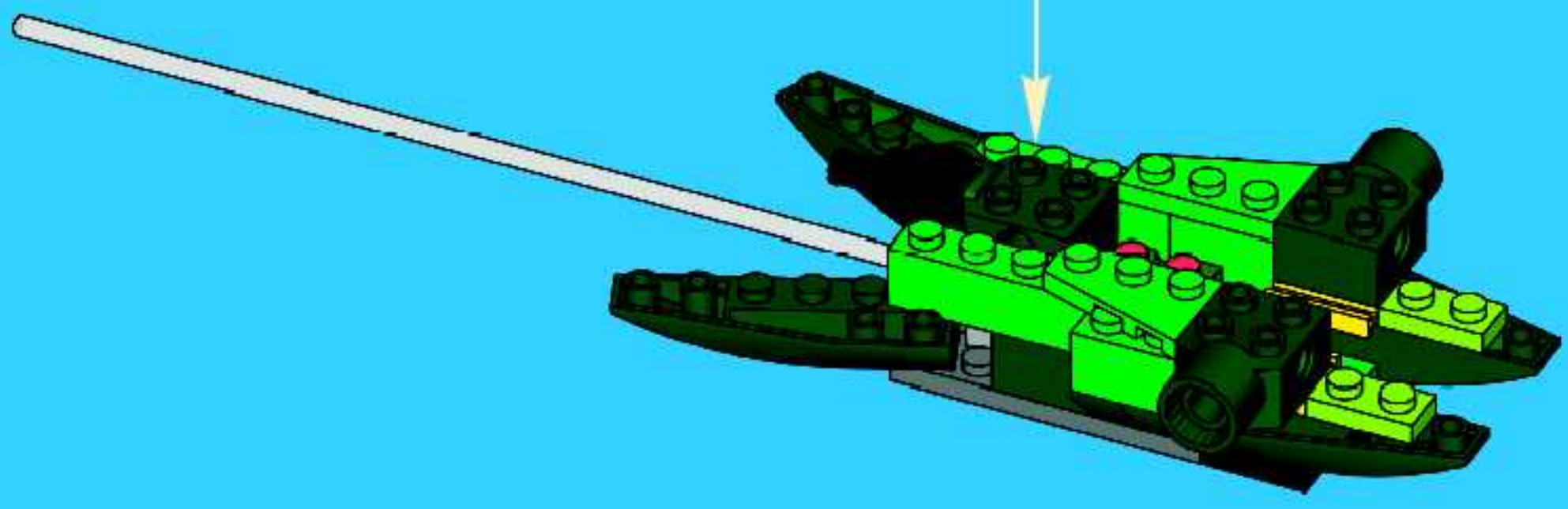

11

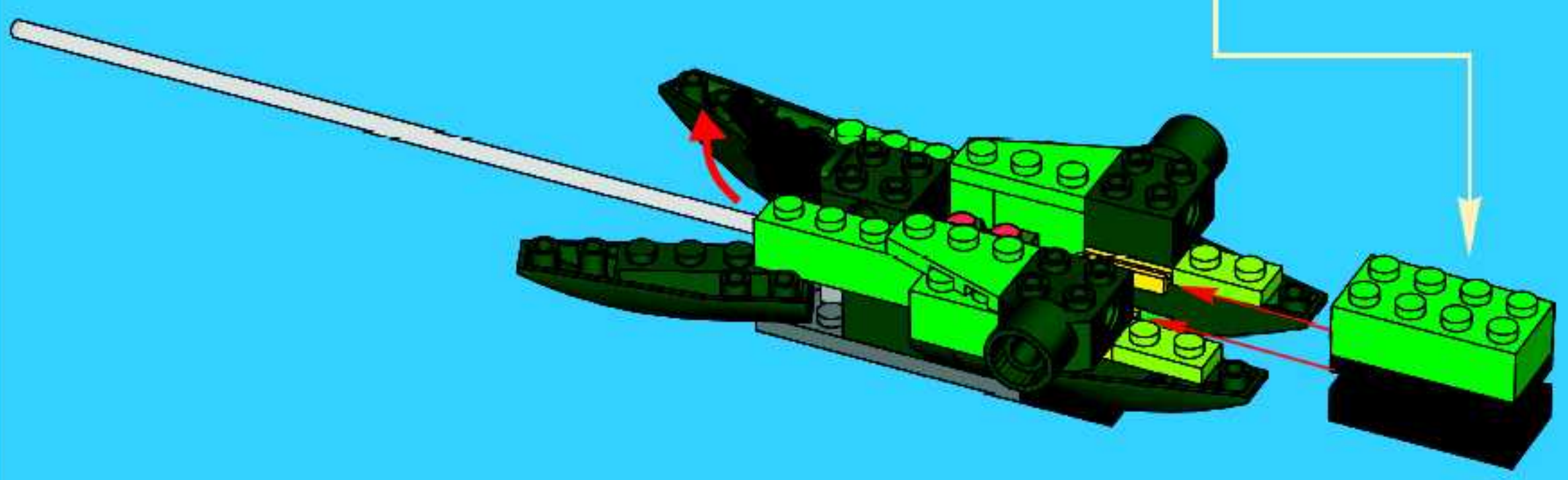
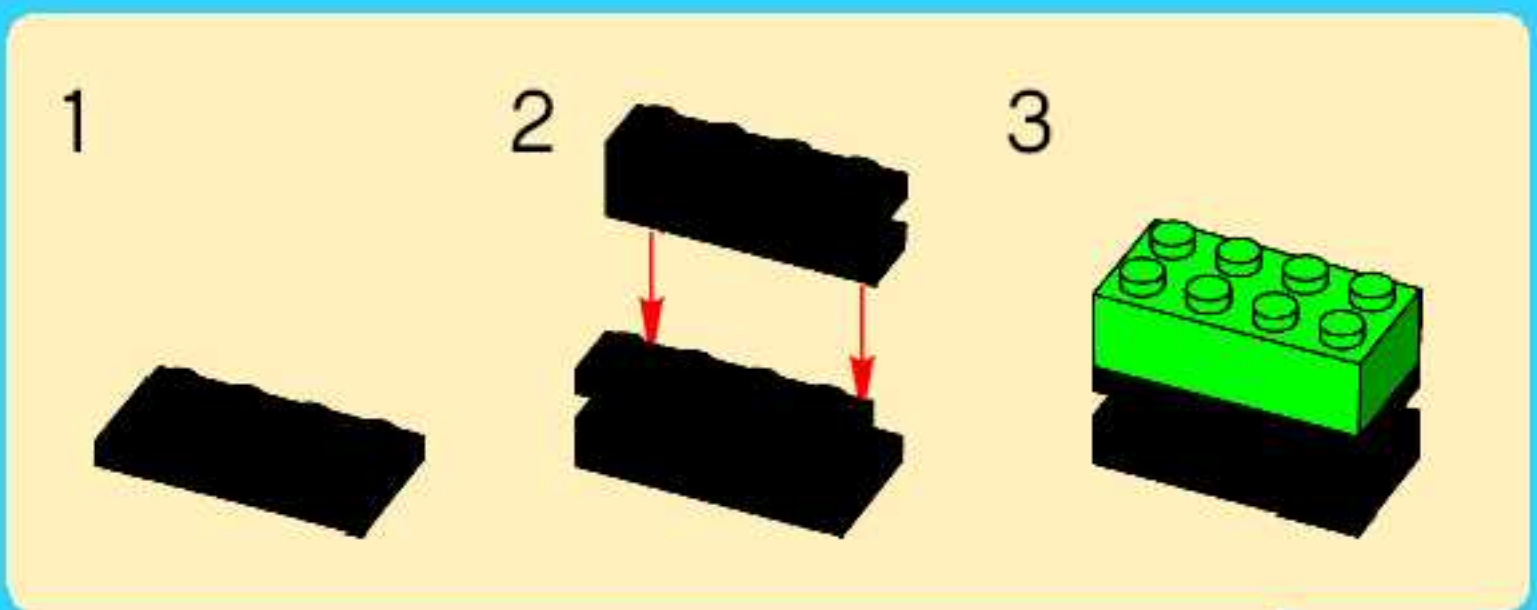

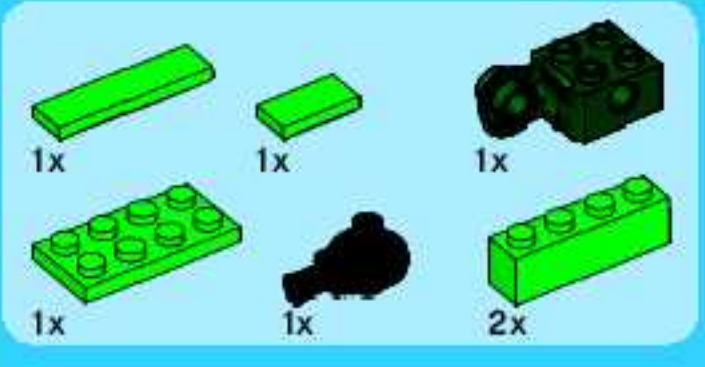

12

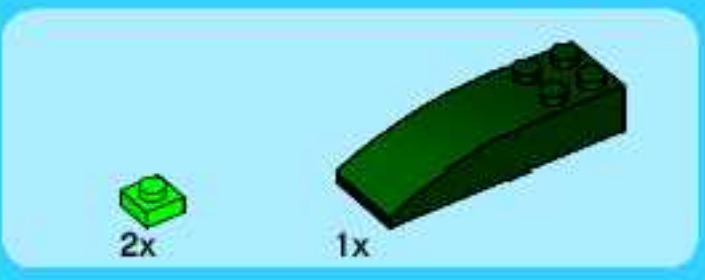
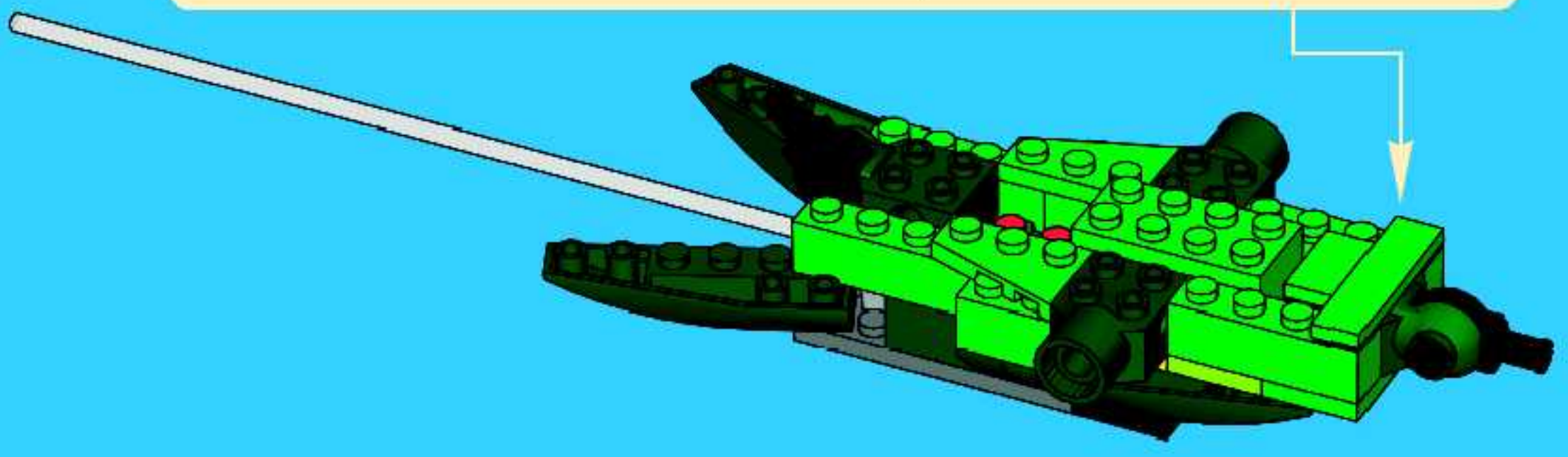
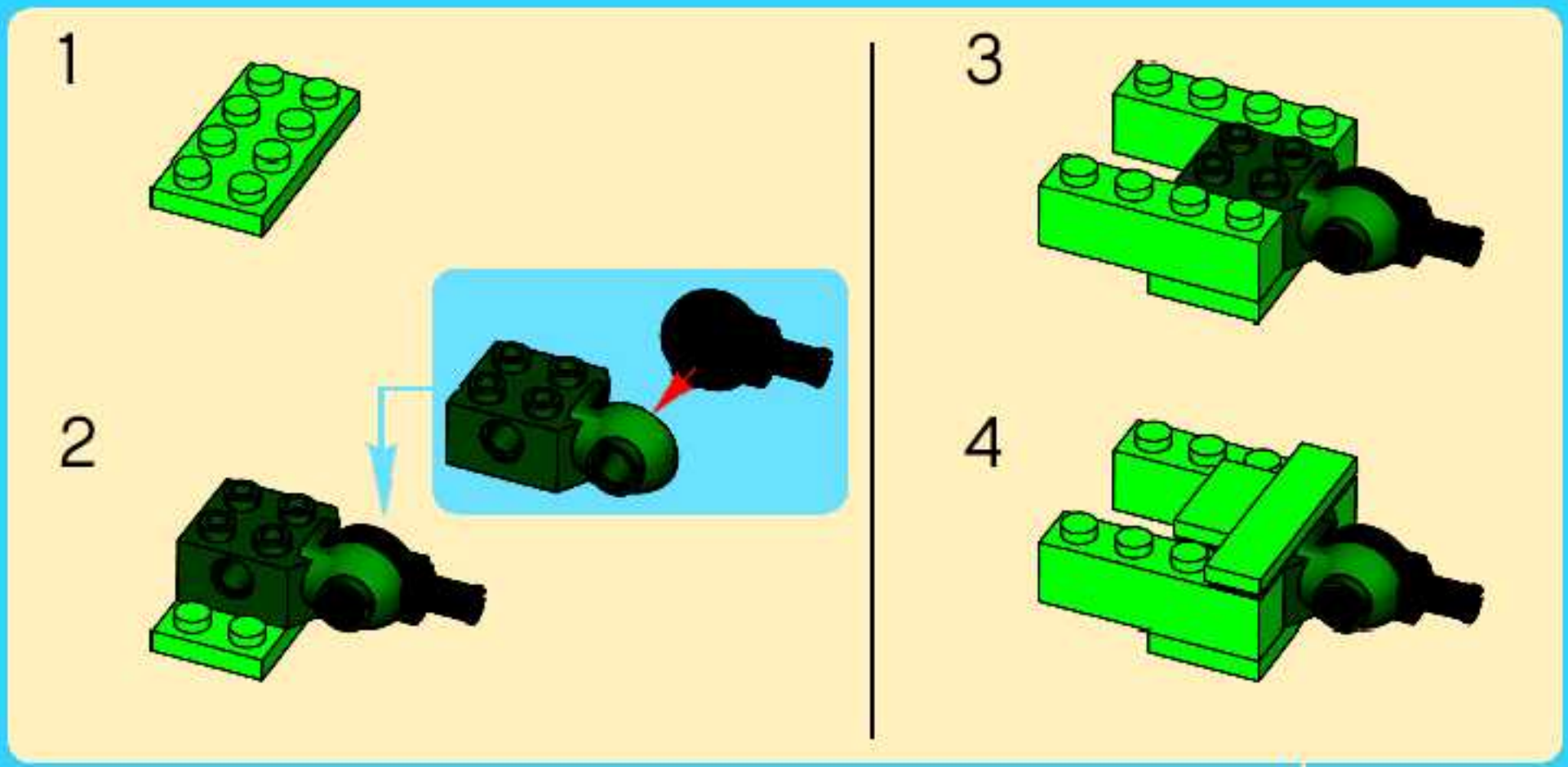

13

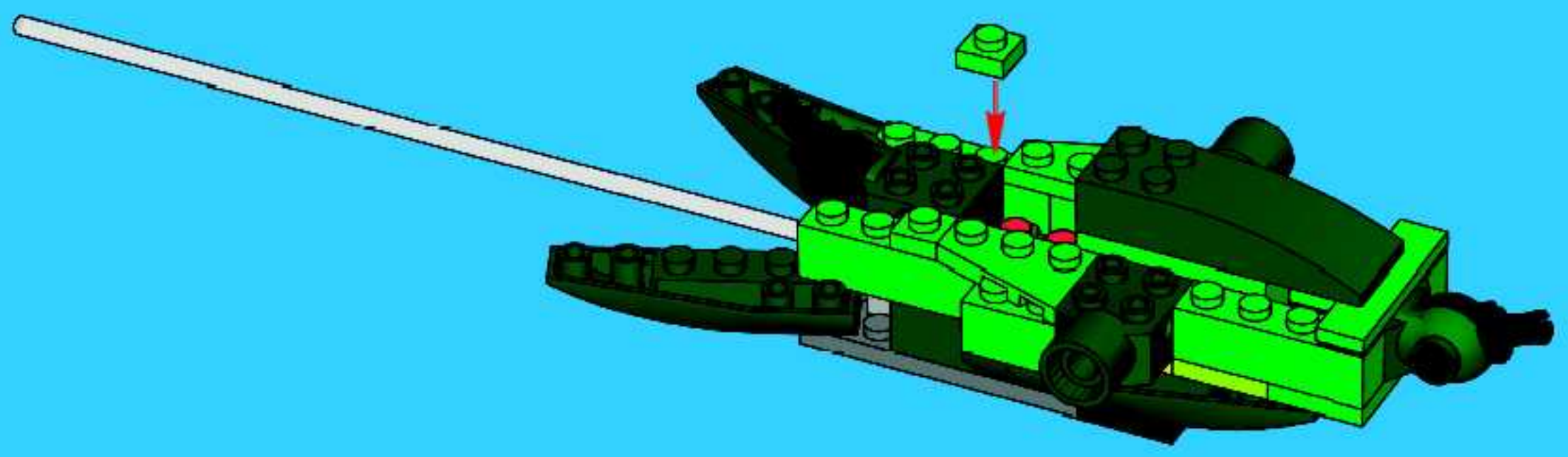



1x



1x



1x

14

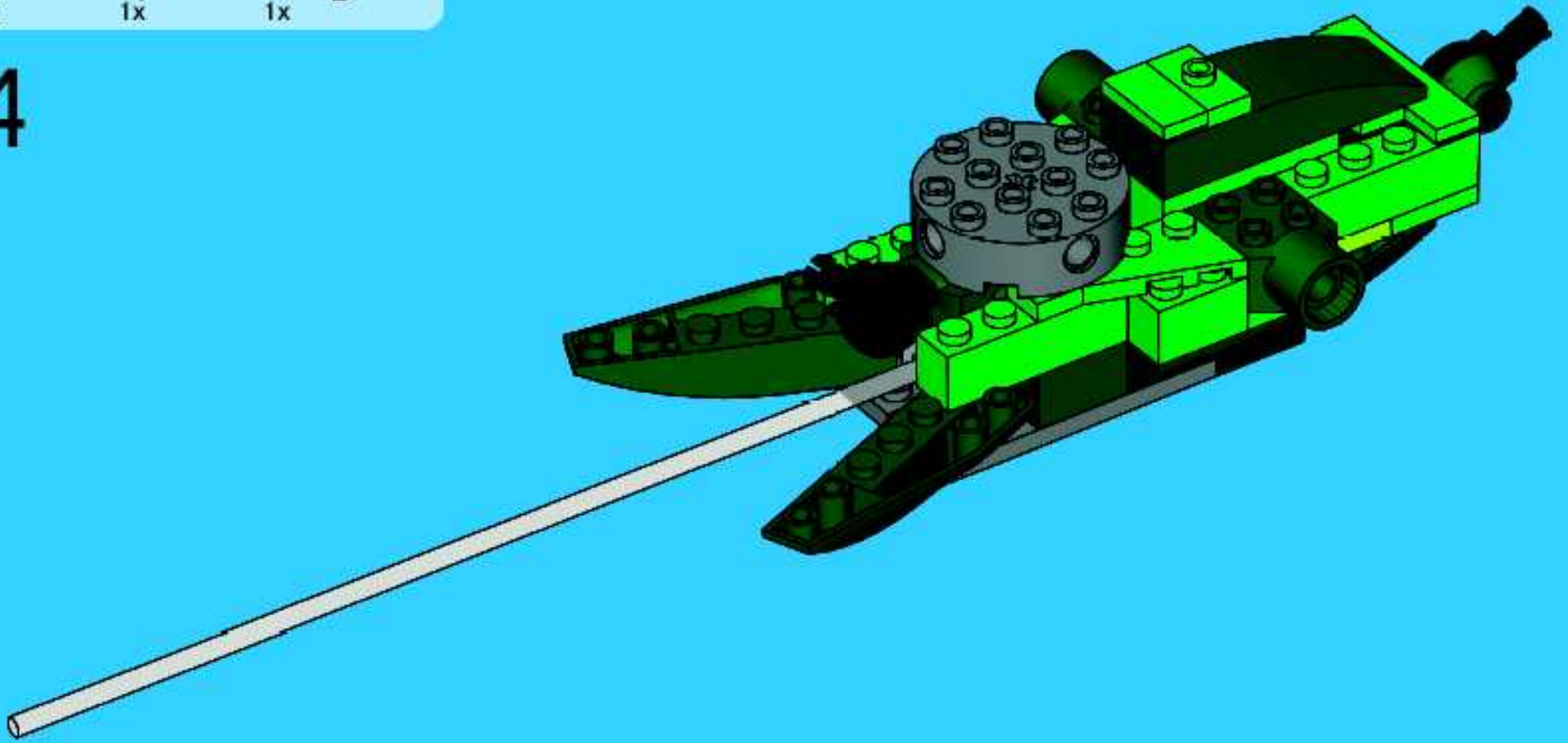

3x



6x



2x



4x

15

1

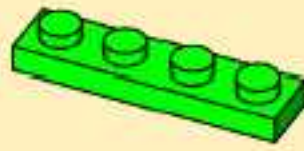

2

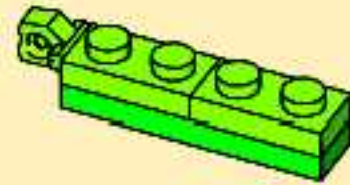

3

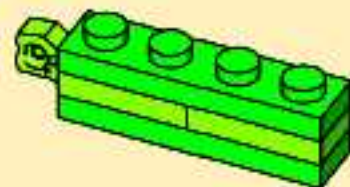

2x

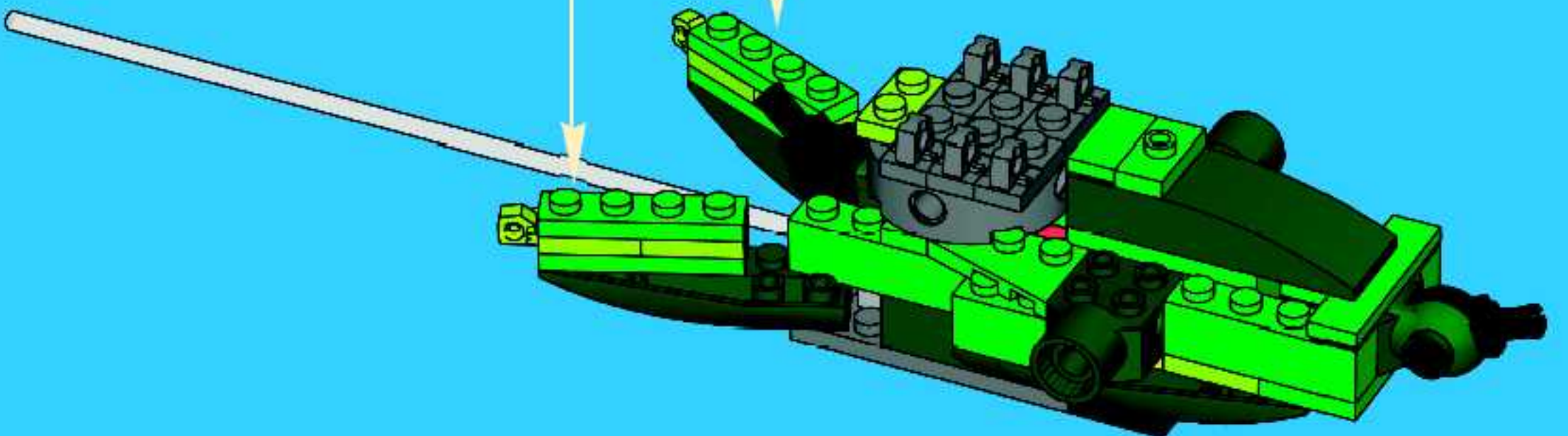

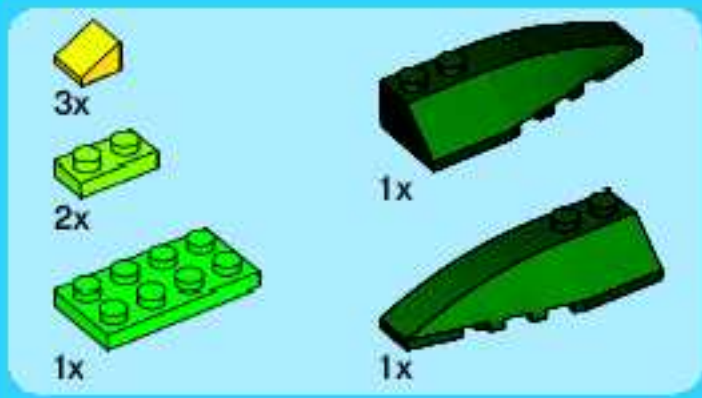

16

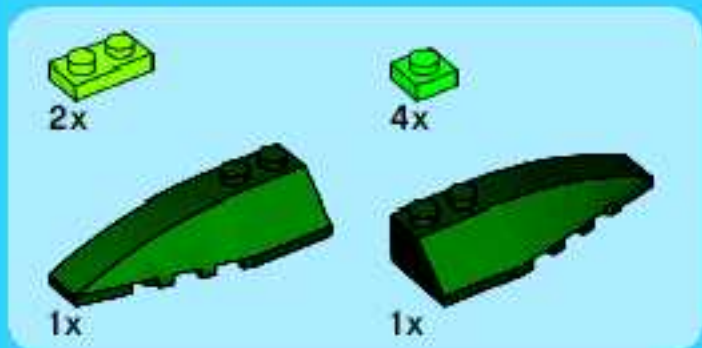
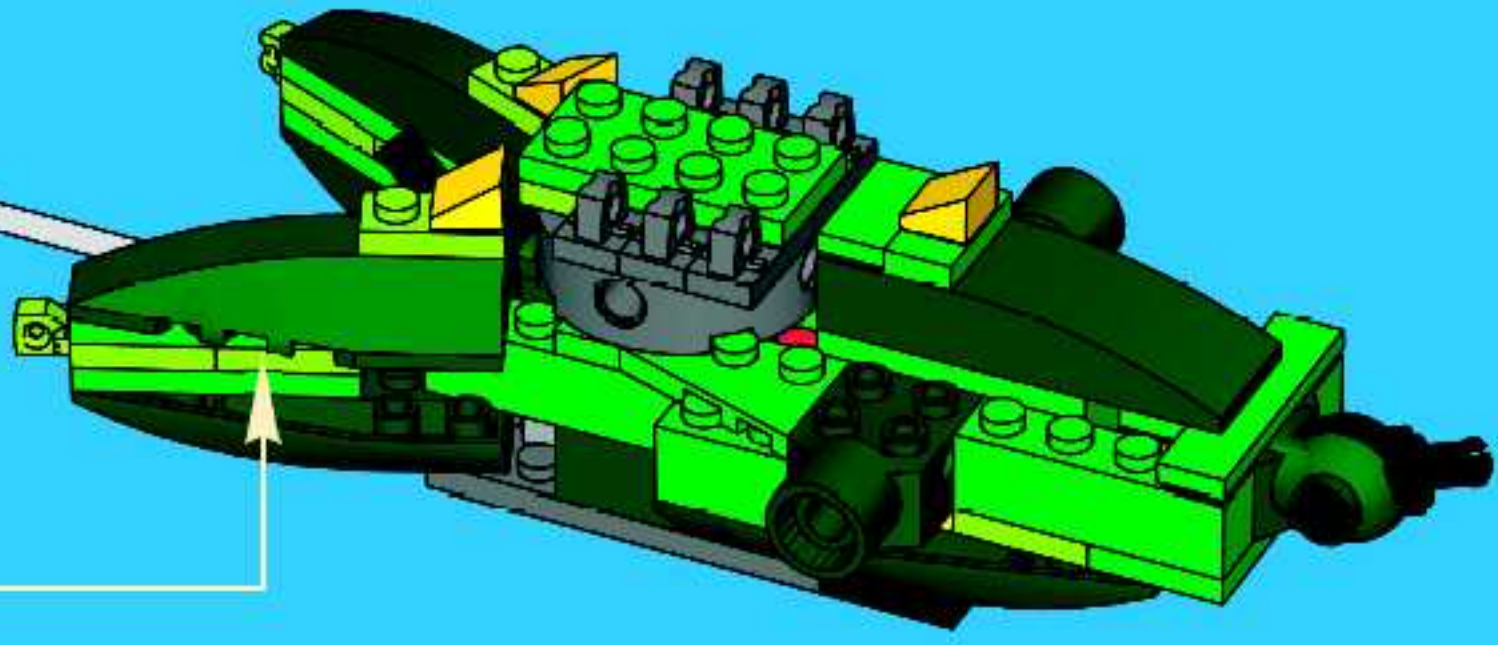
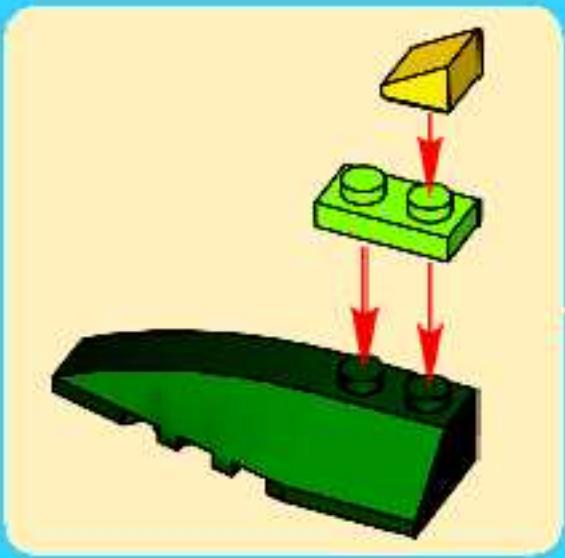
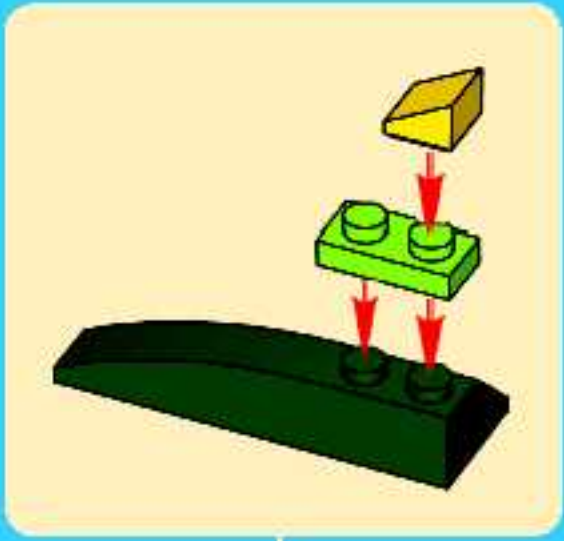

17

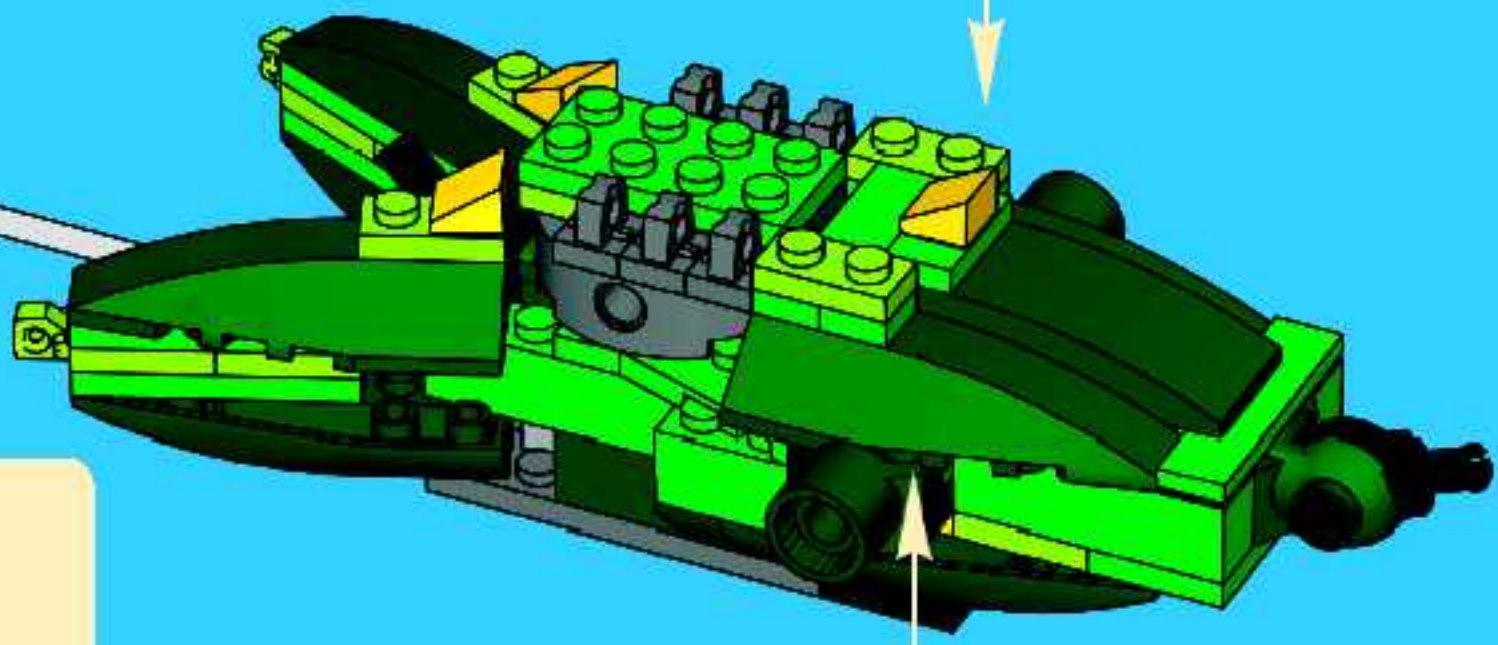
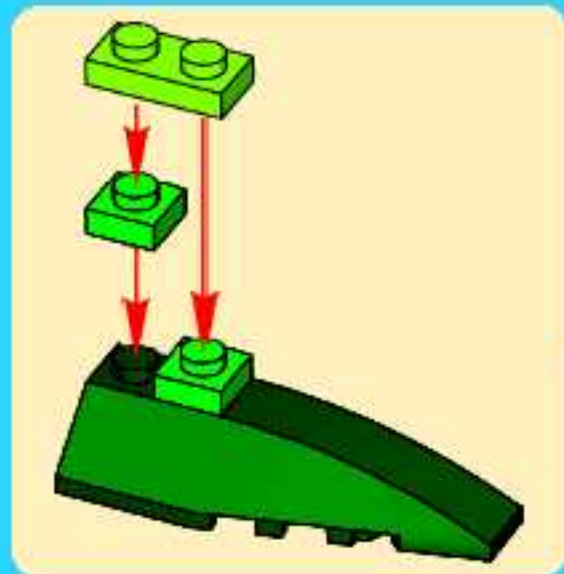
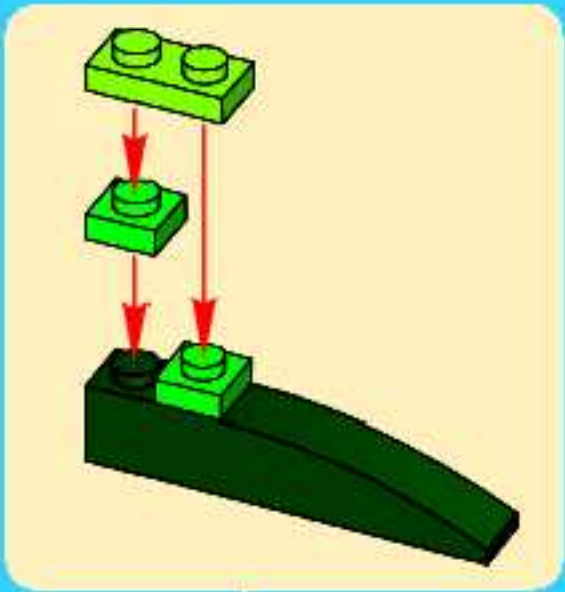



2x



1x

18

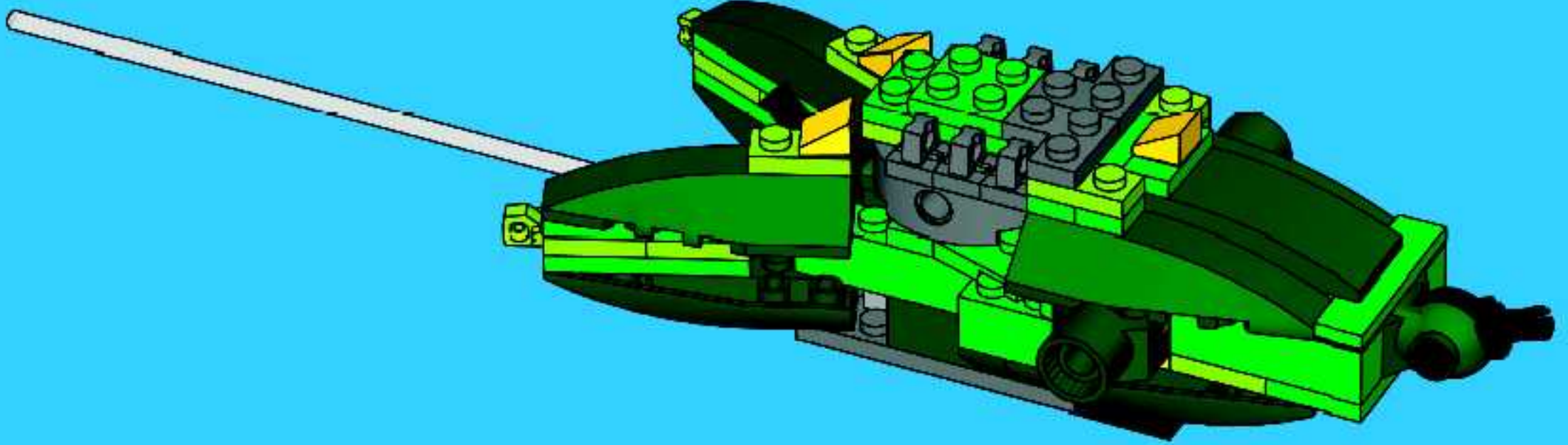

1x



2x

19

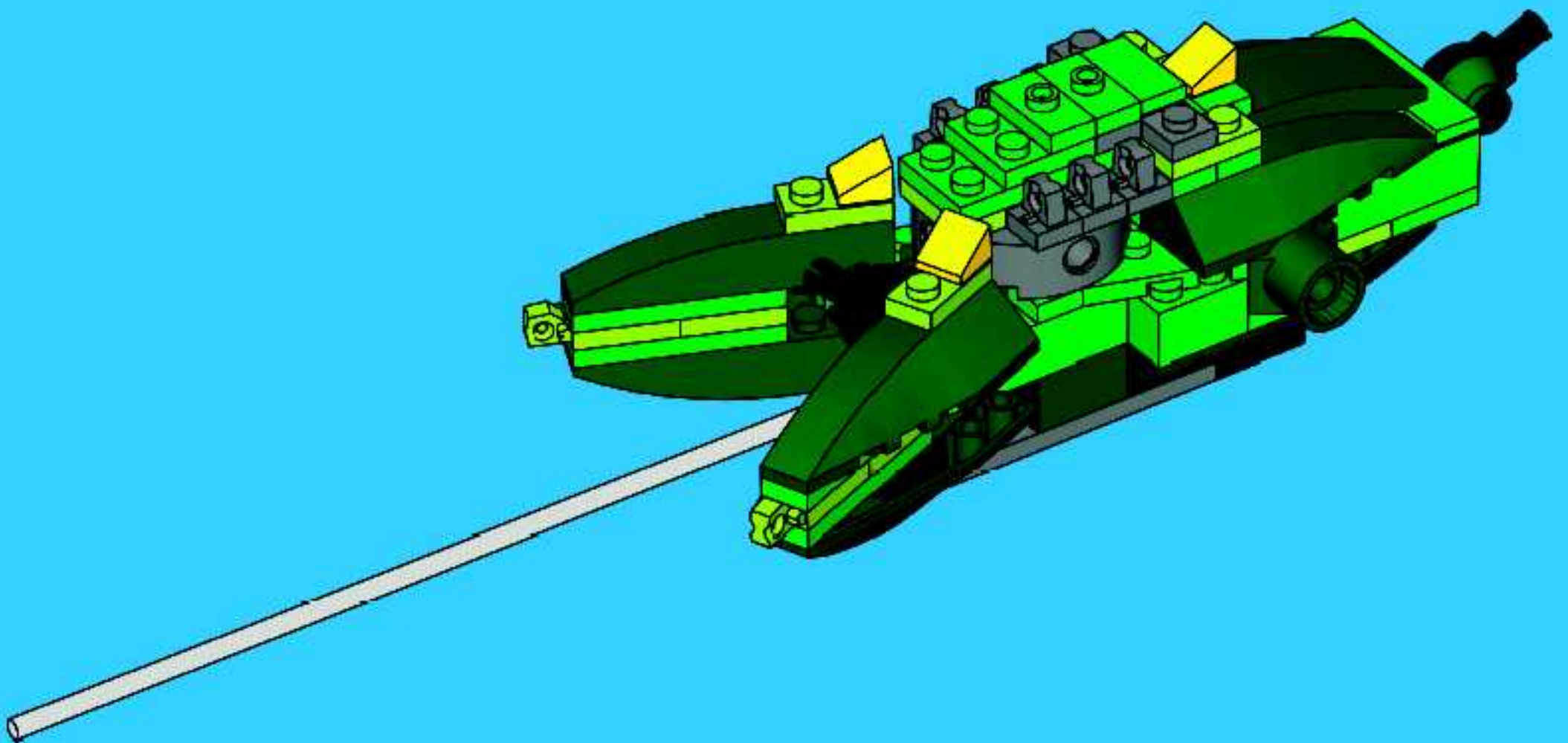

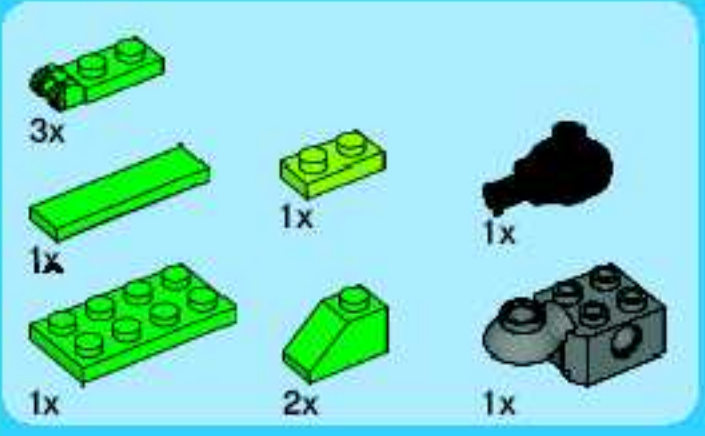

20

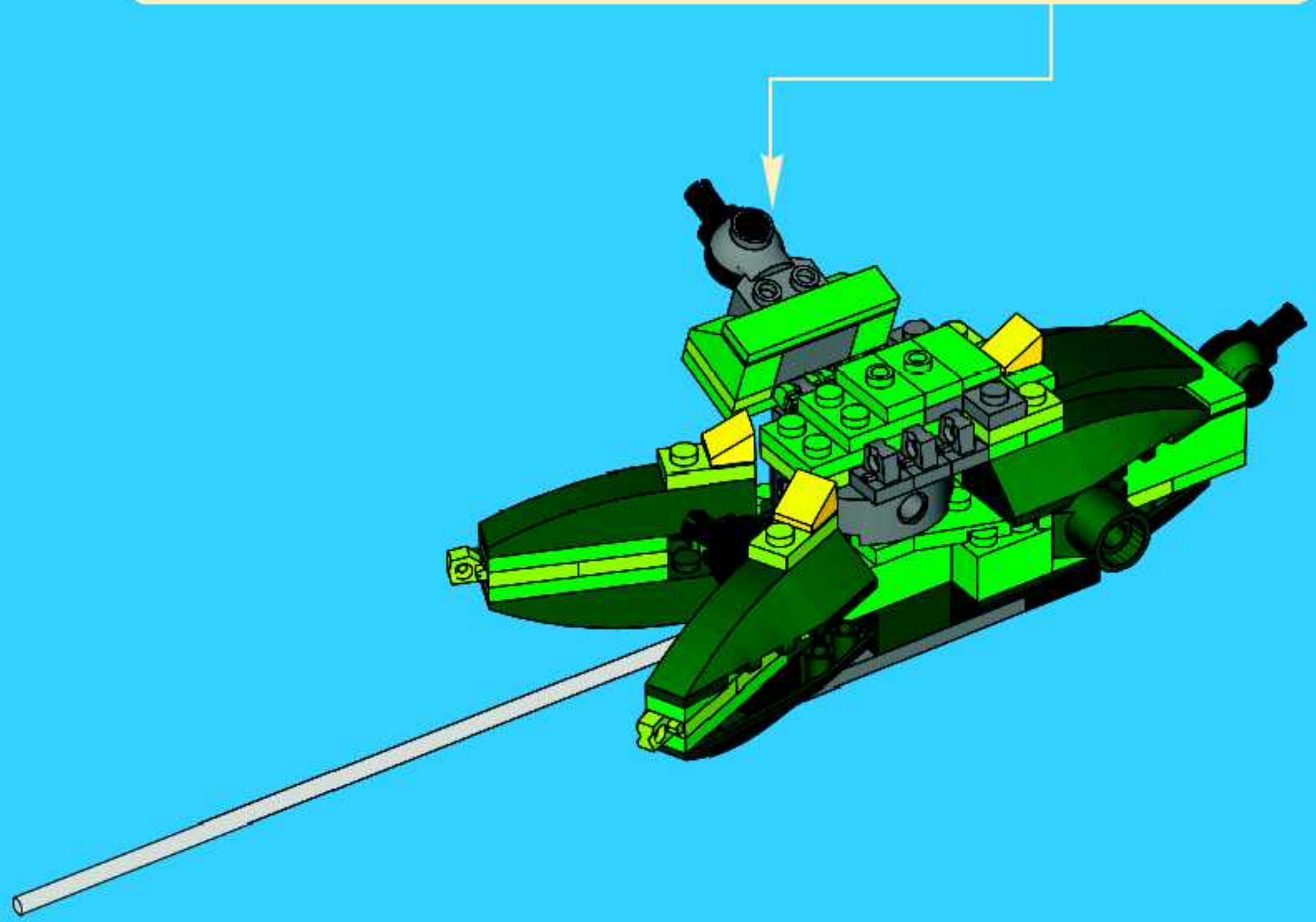
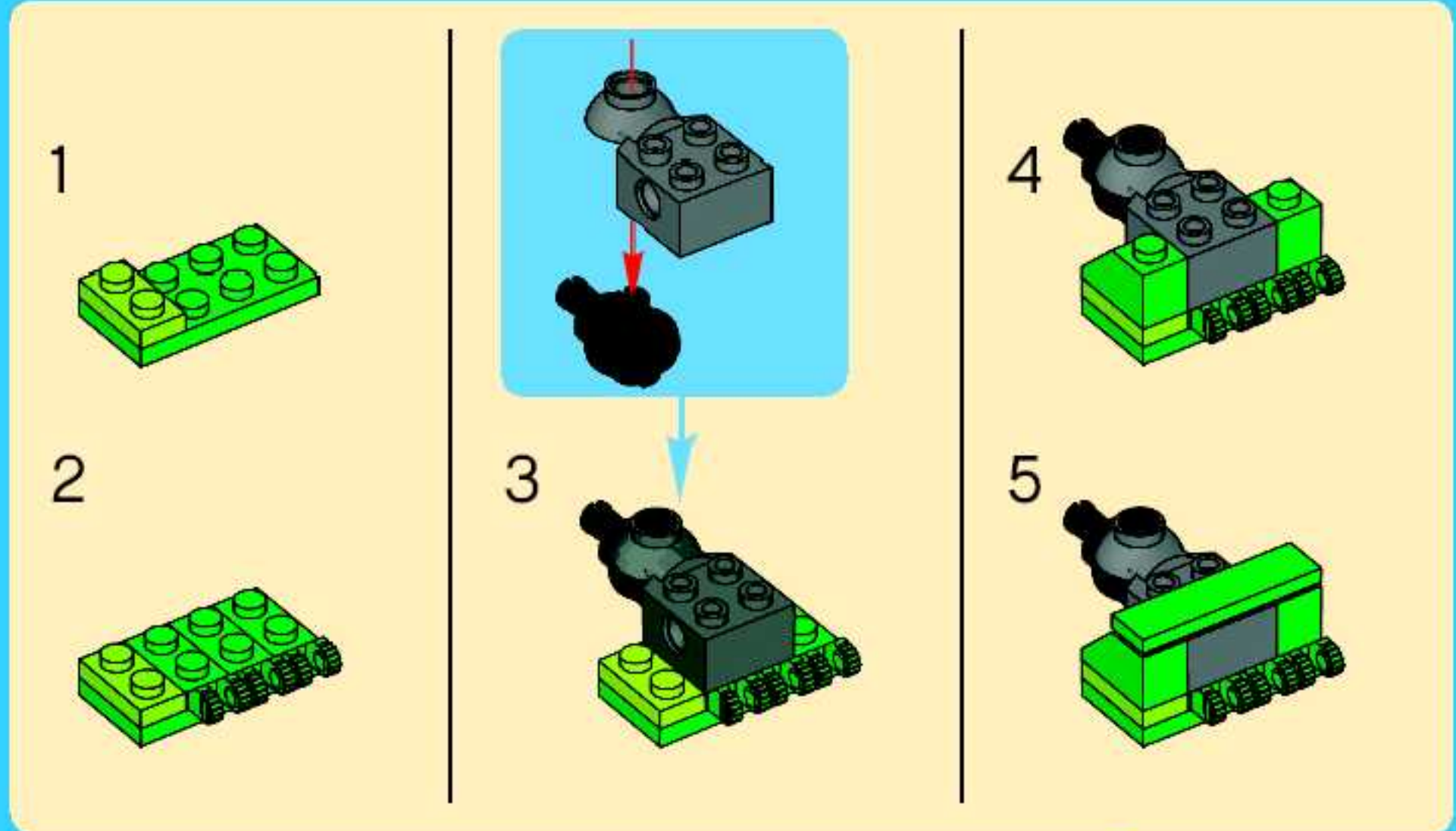

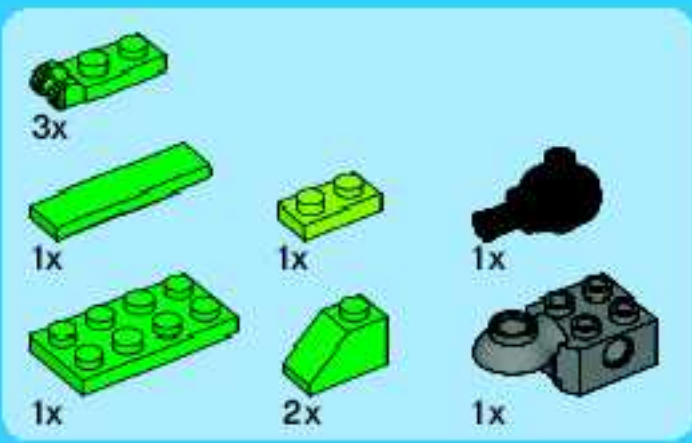

21

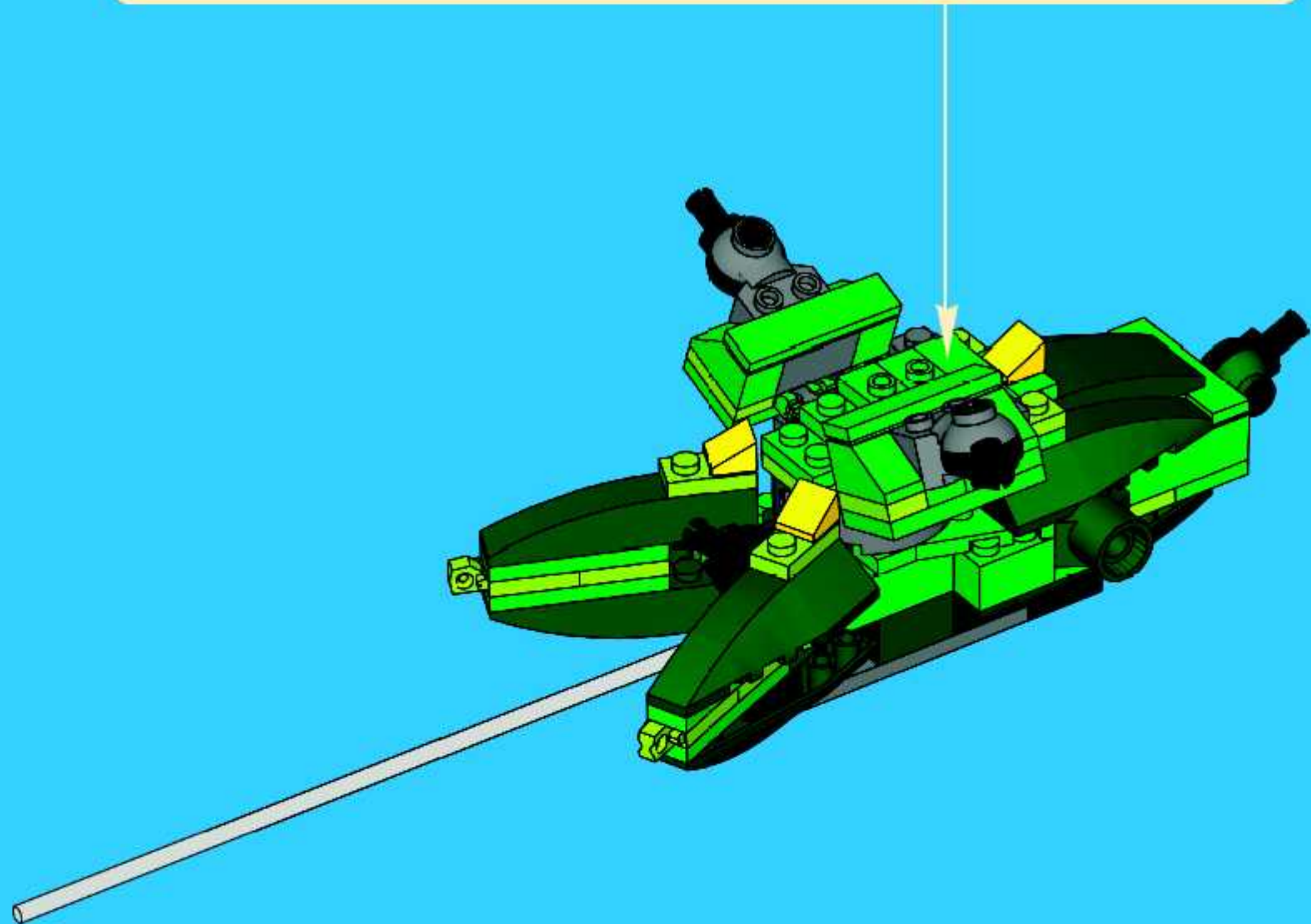
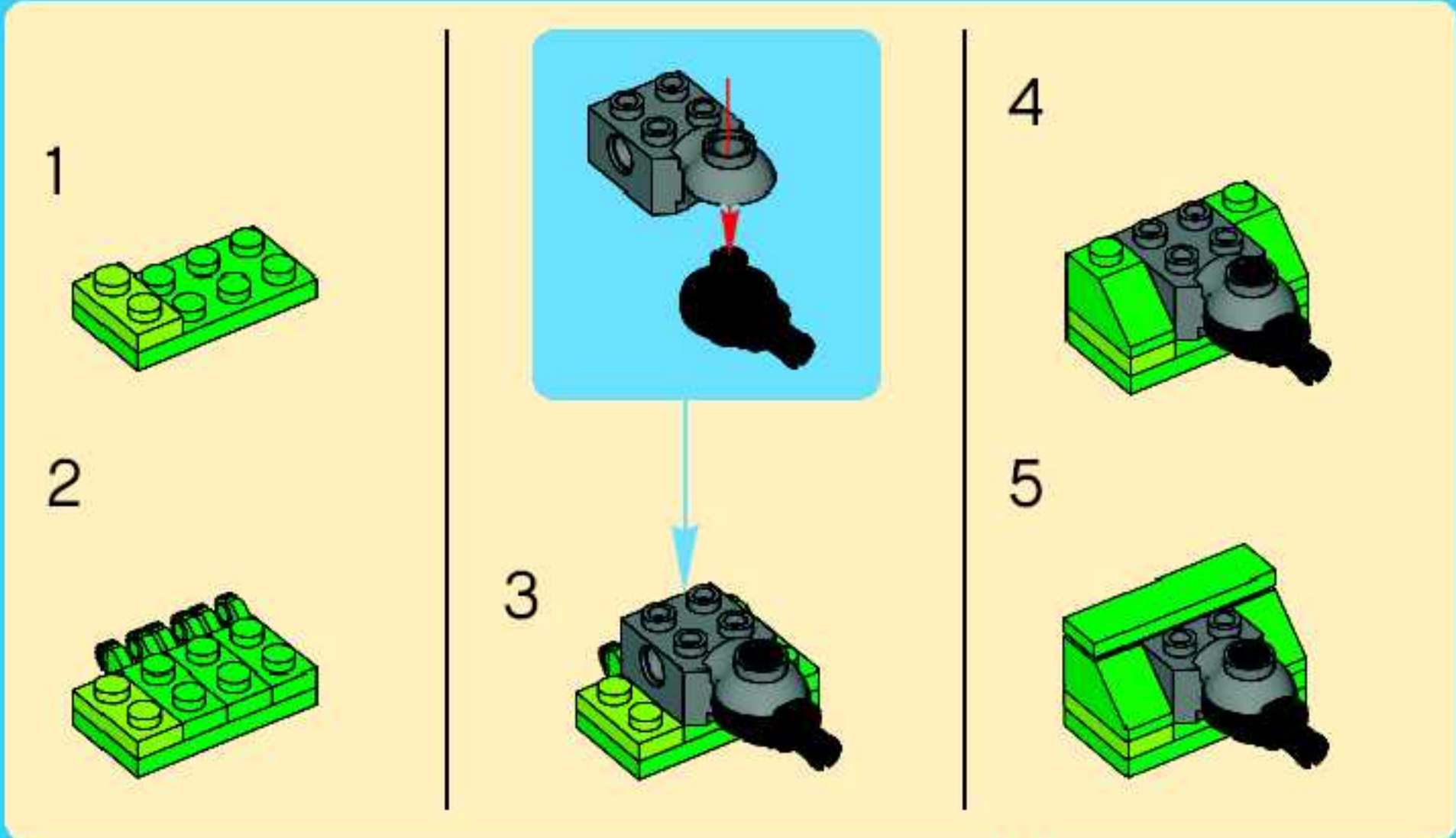

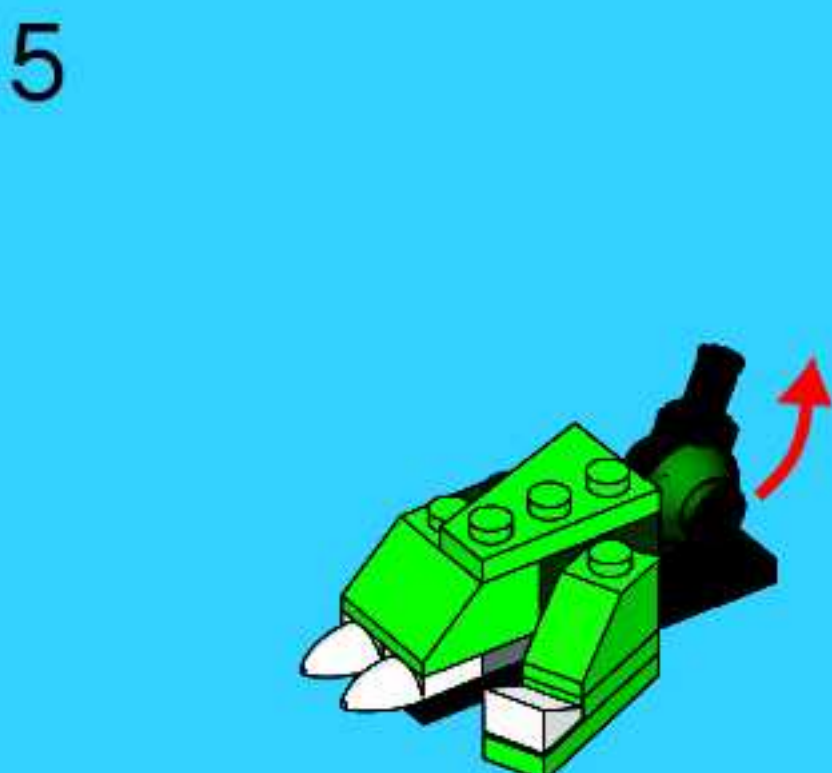
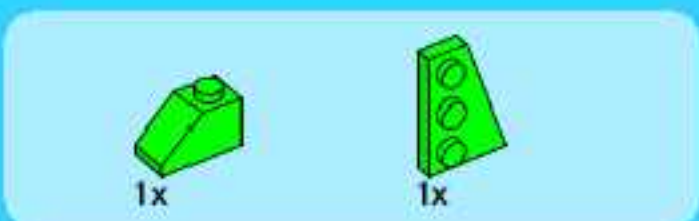
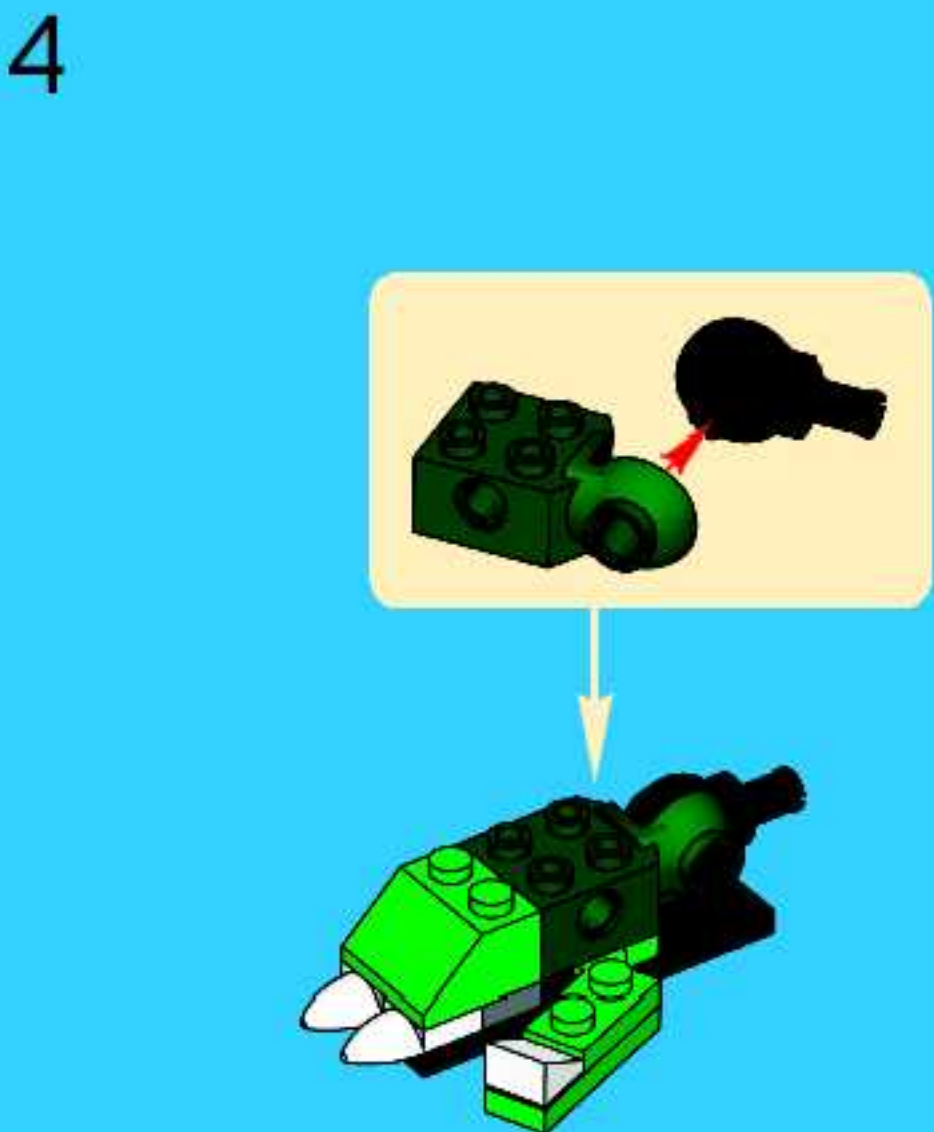
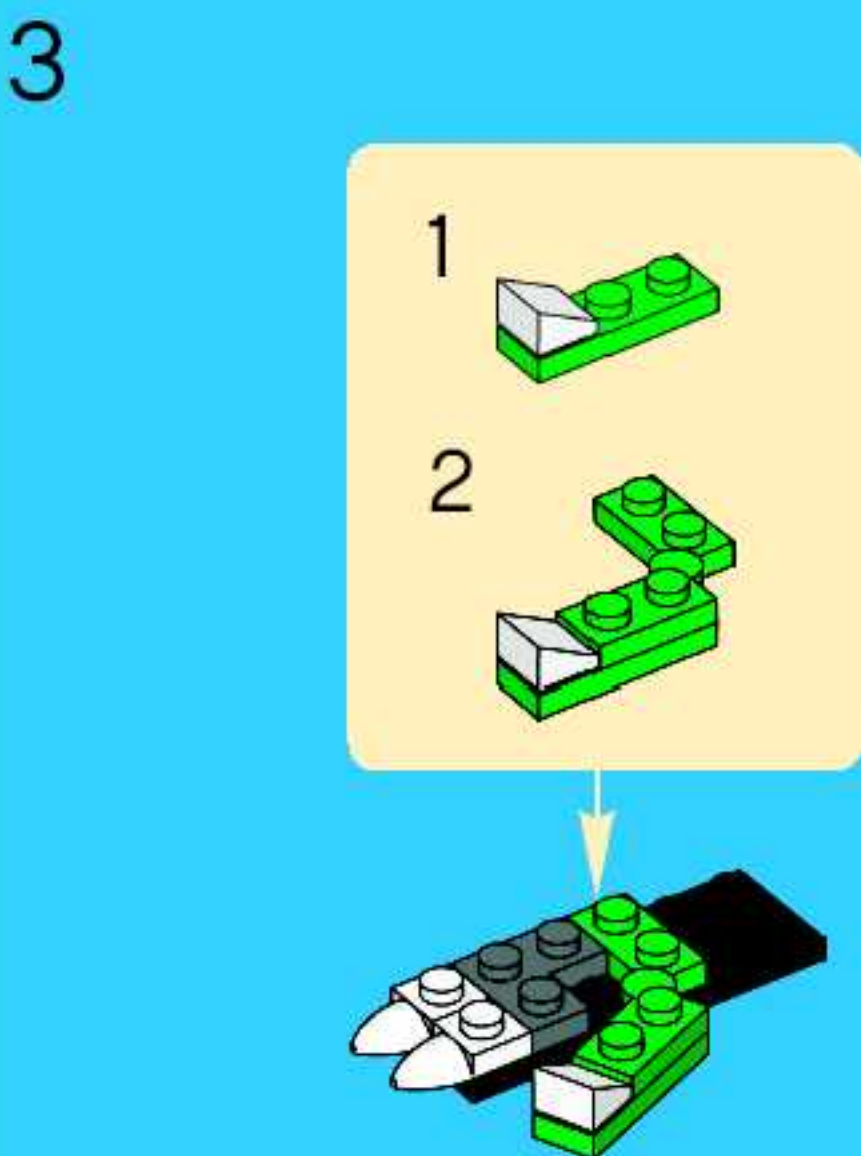
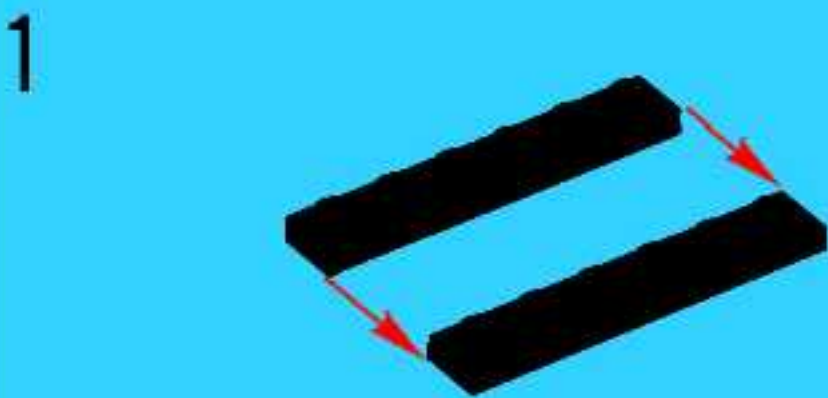
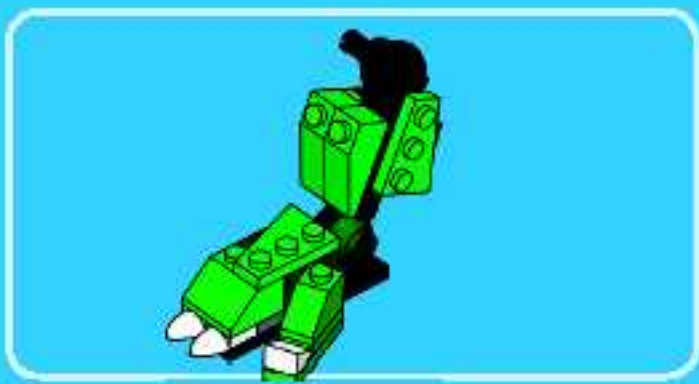

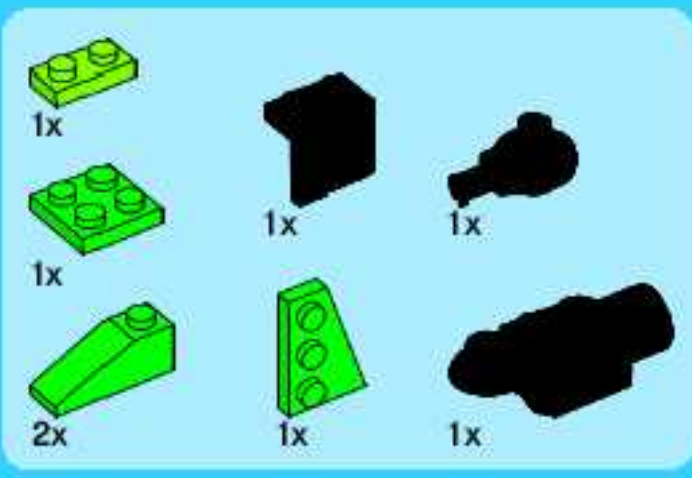

6

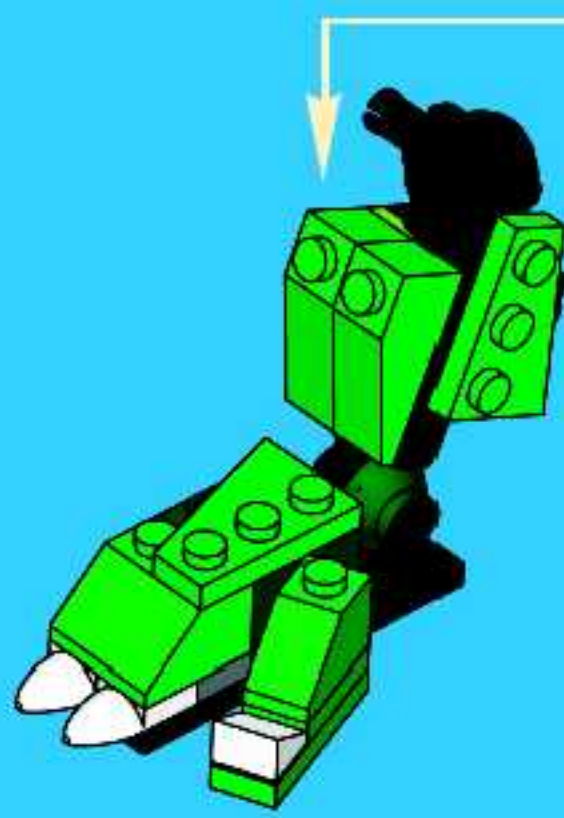
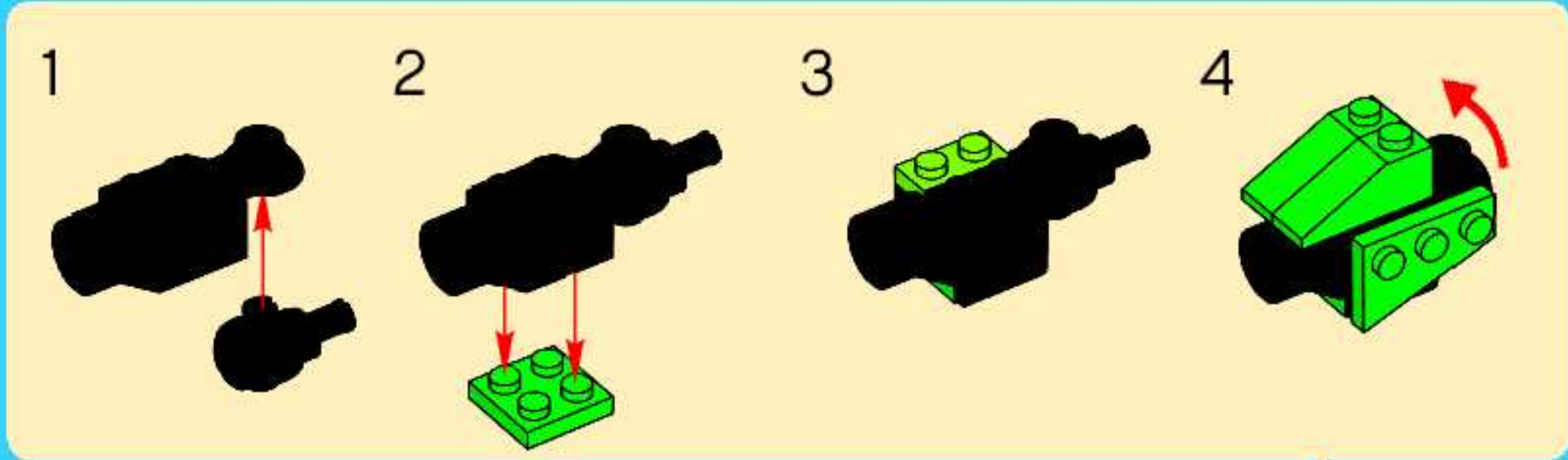

22





2x

1

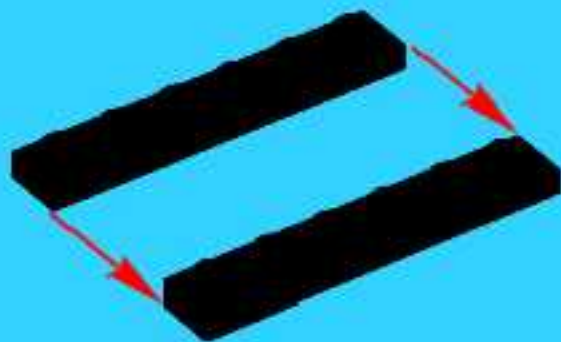

2x



1x

2

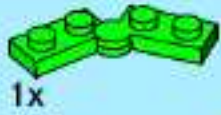
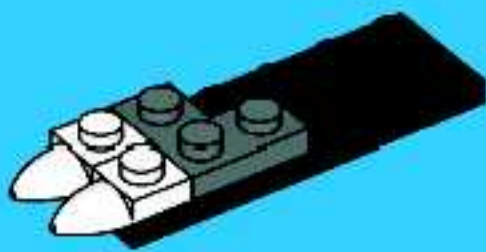

1x



1x



1x



1x

3

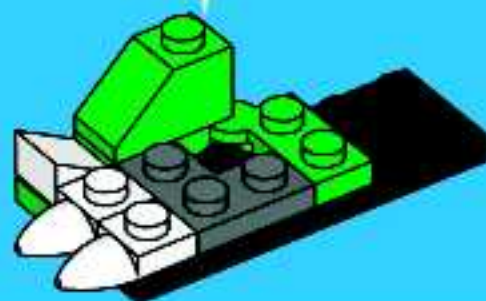
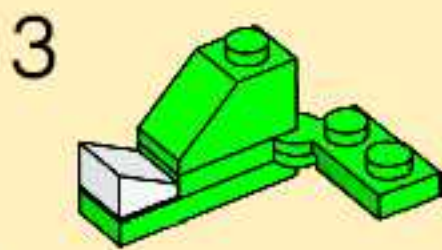
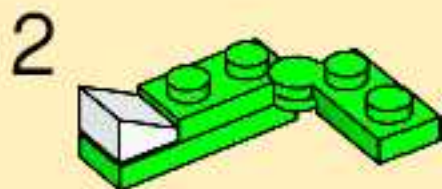

1x



1x



1x

4

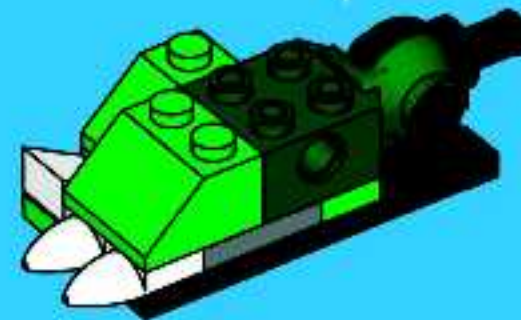
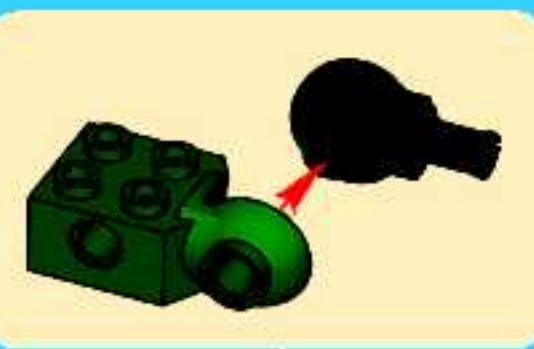

1x

5

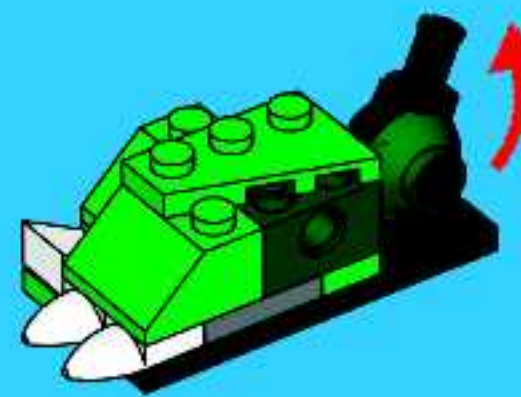

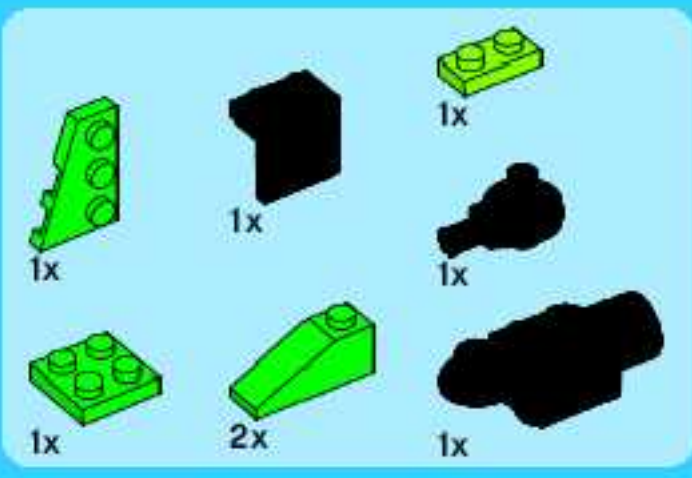

6

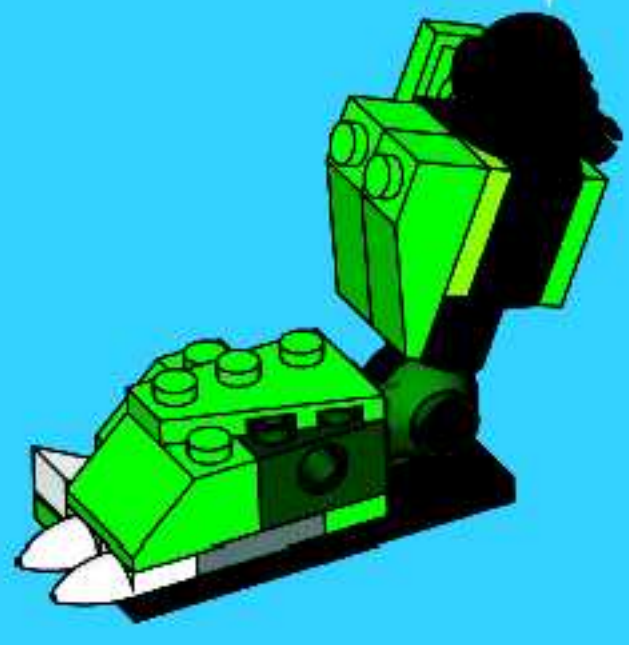
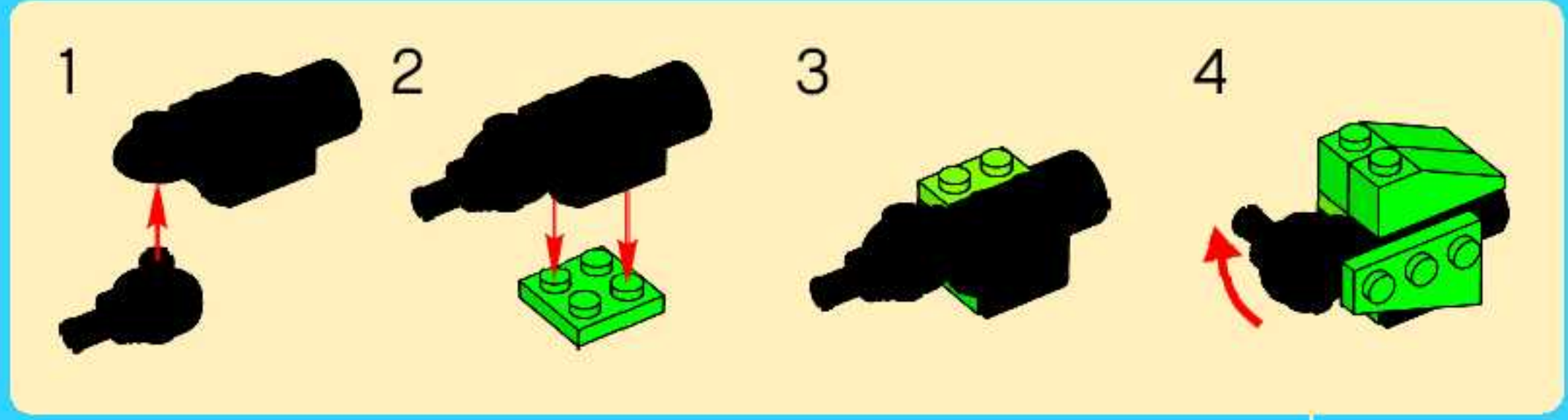

23



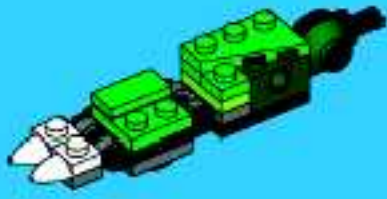

1

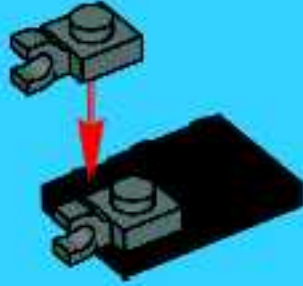

2

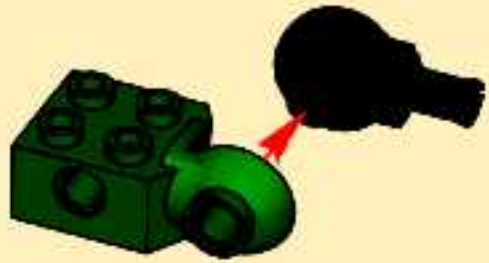

3



4

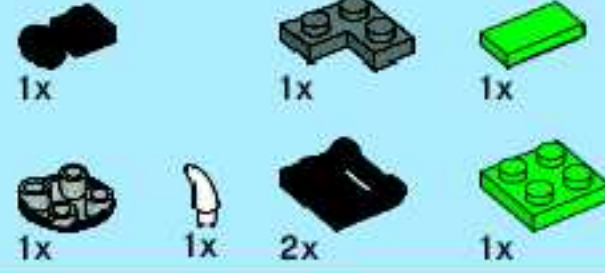
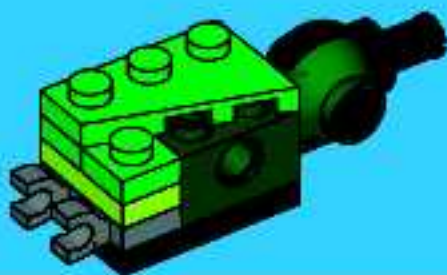

5

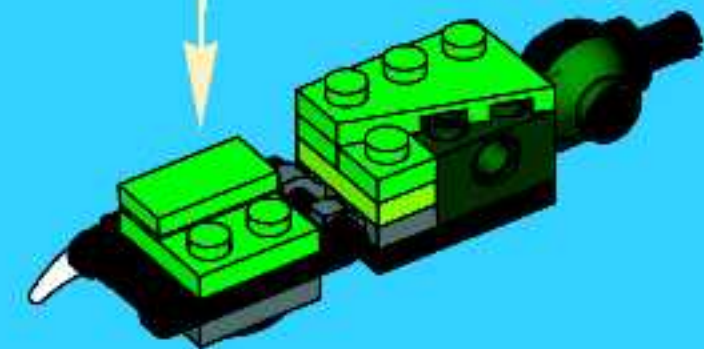
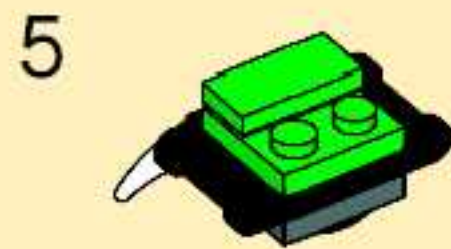
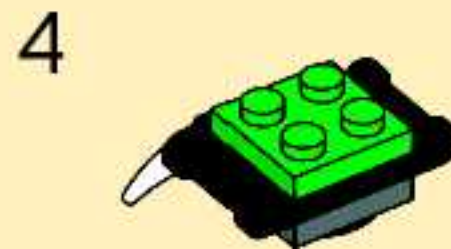
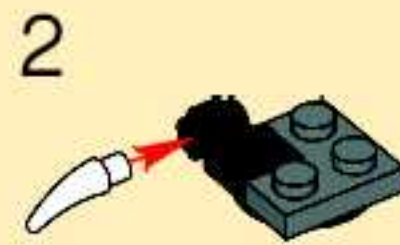
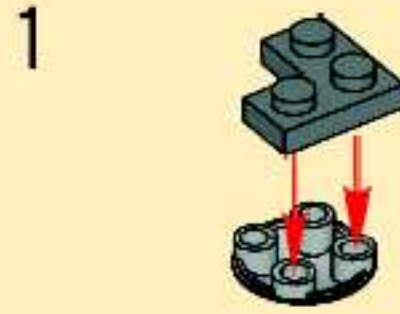



6

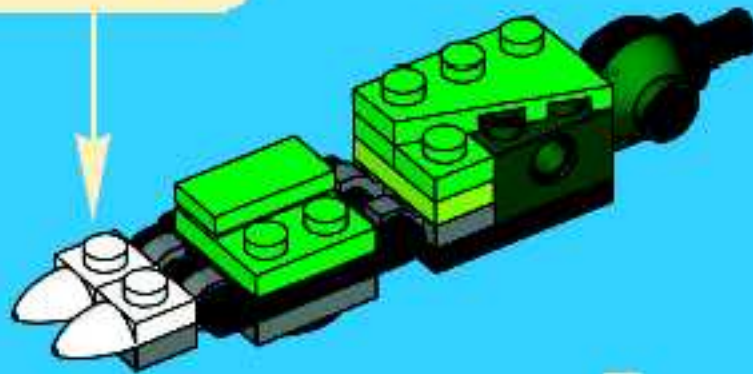
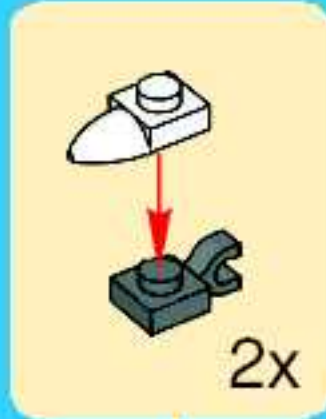

24

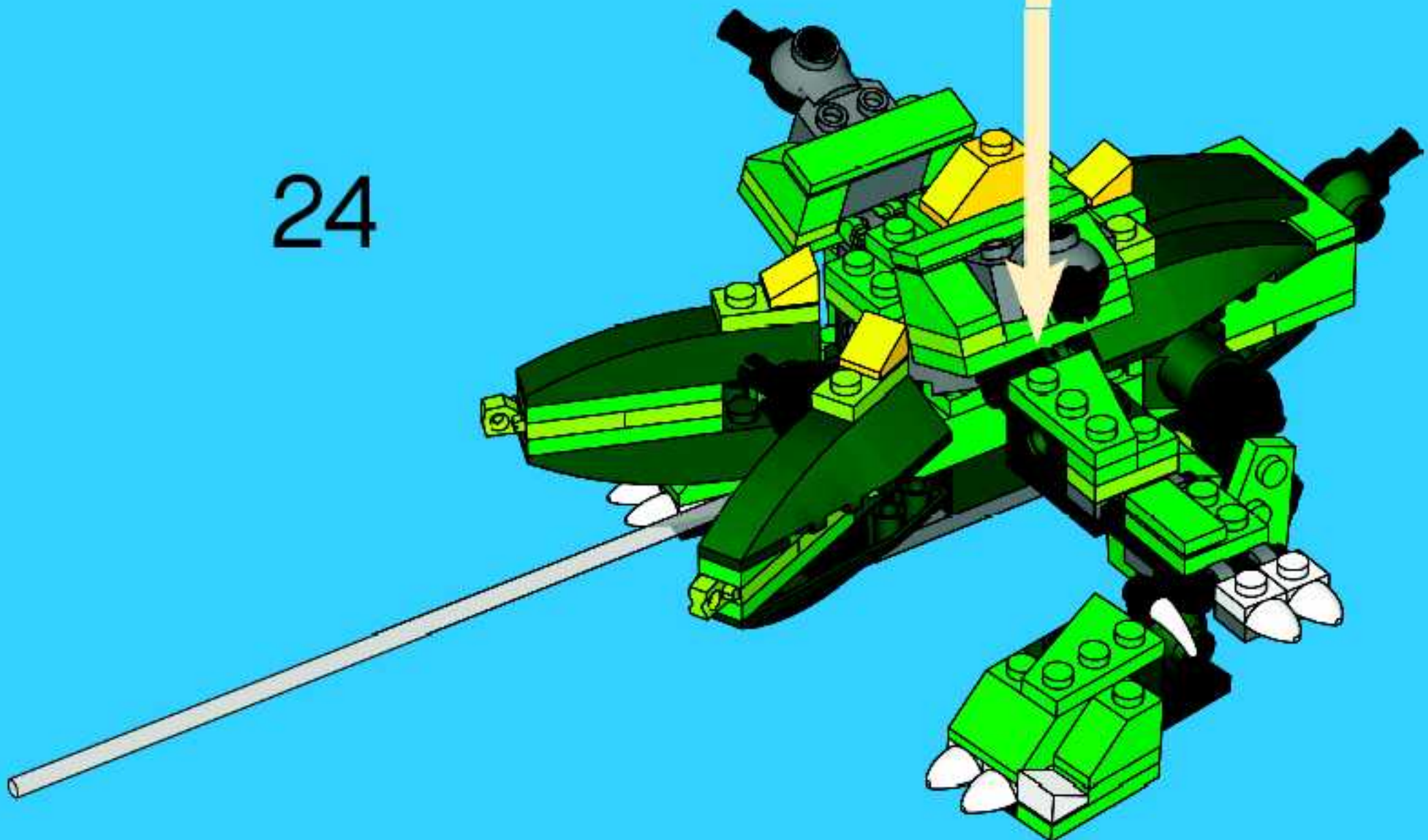

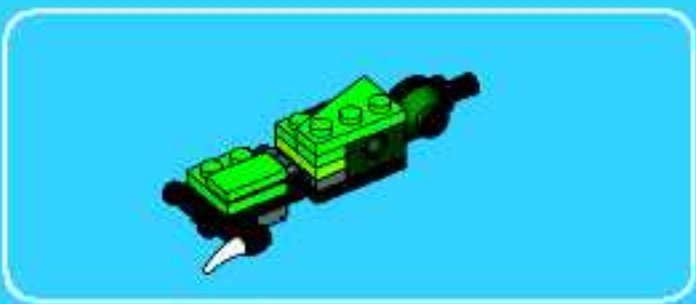

1

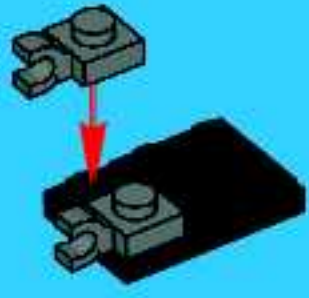

2

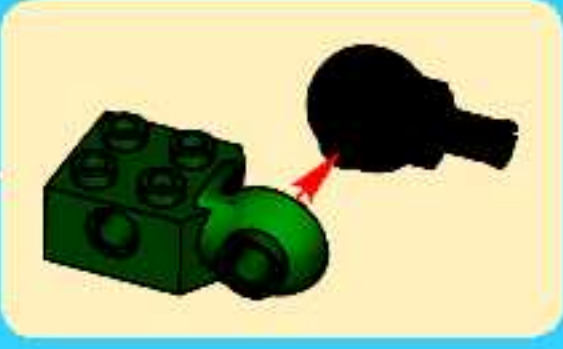

3

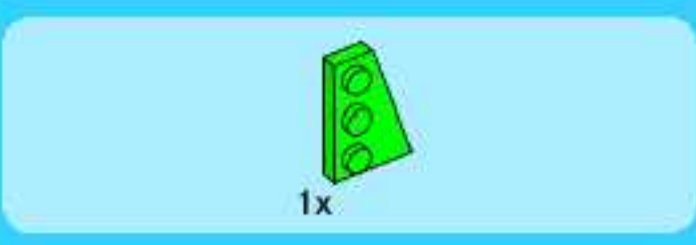

4

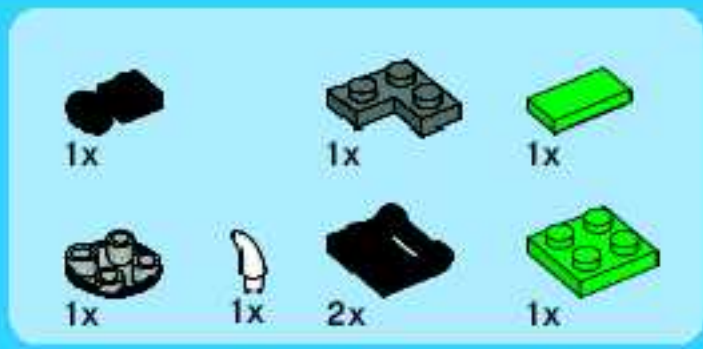
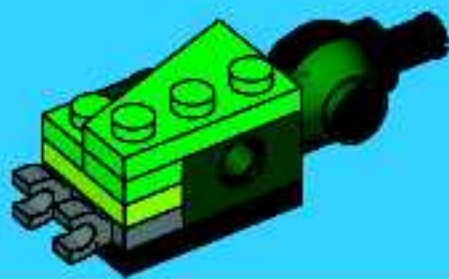

5

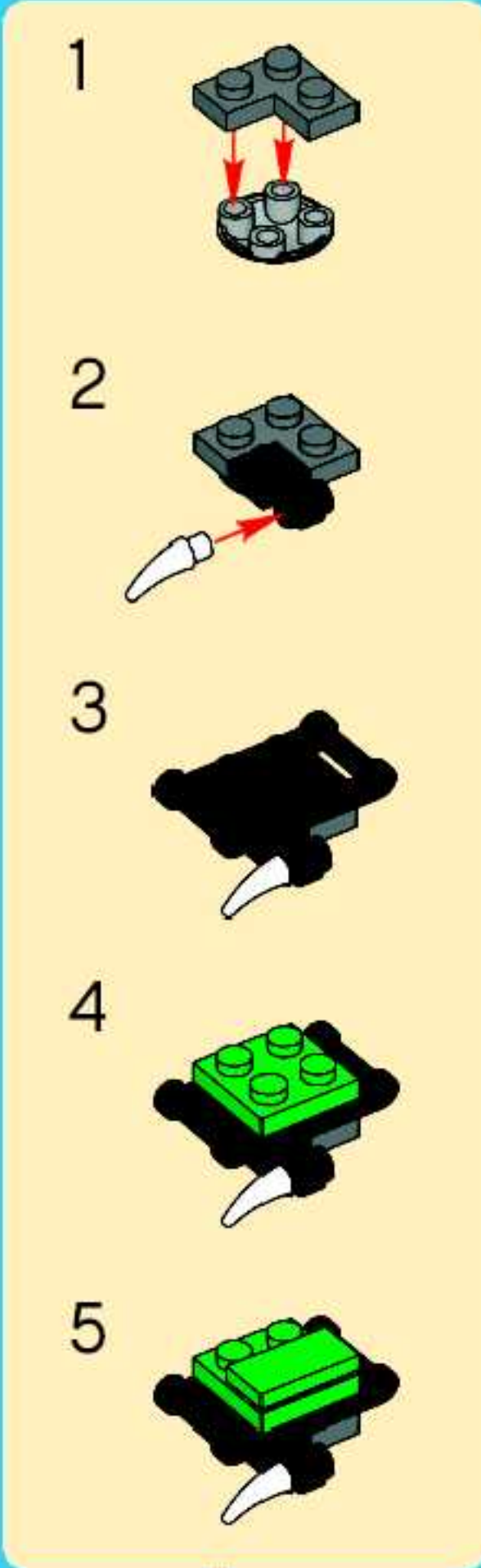

1

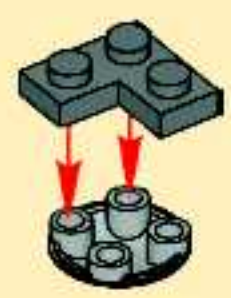

2

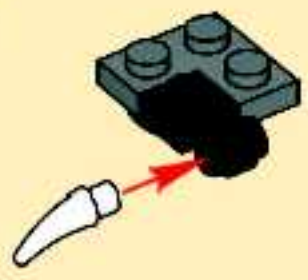

3



4



5

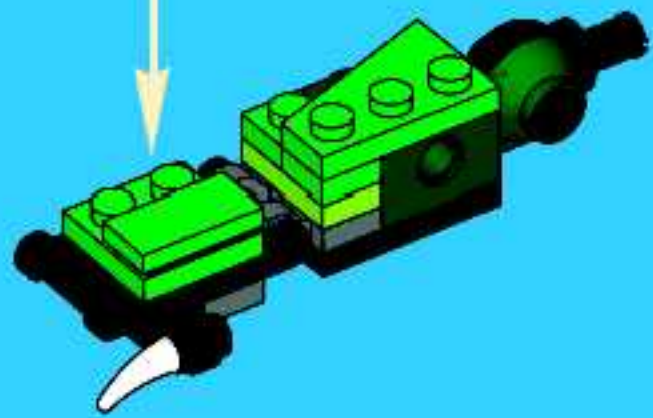



6

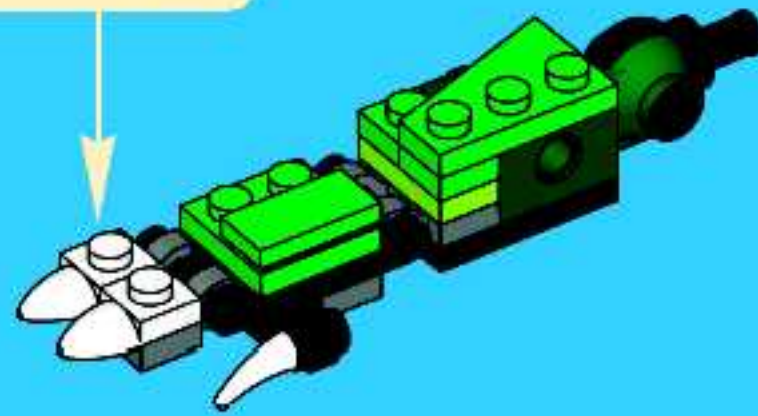
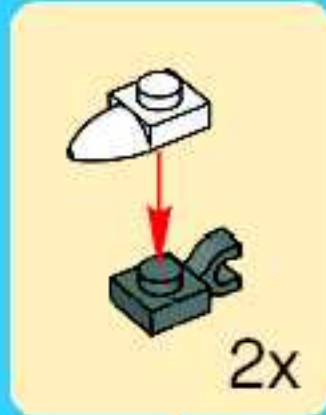

25

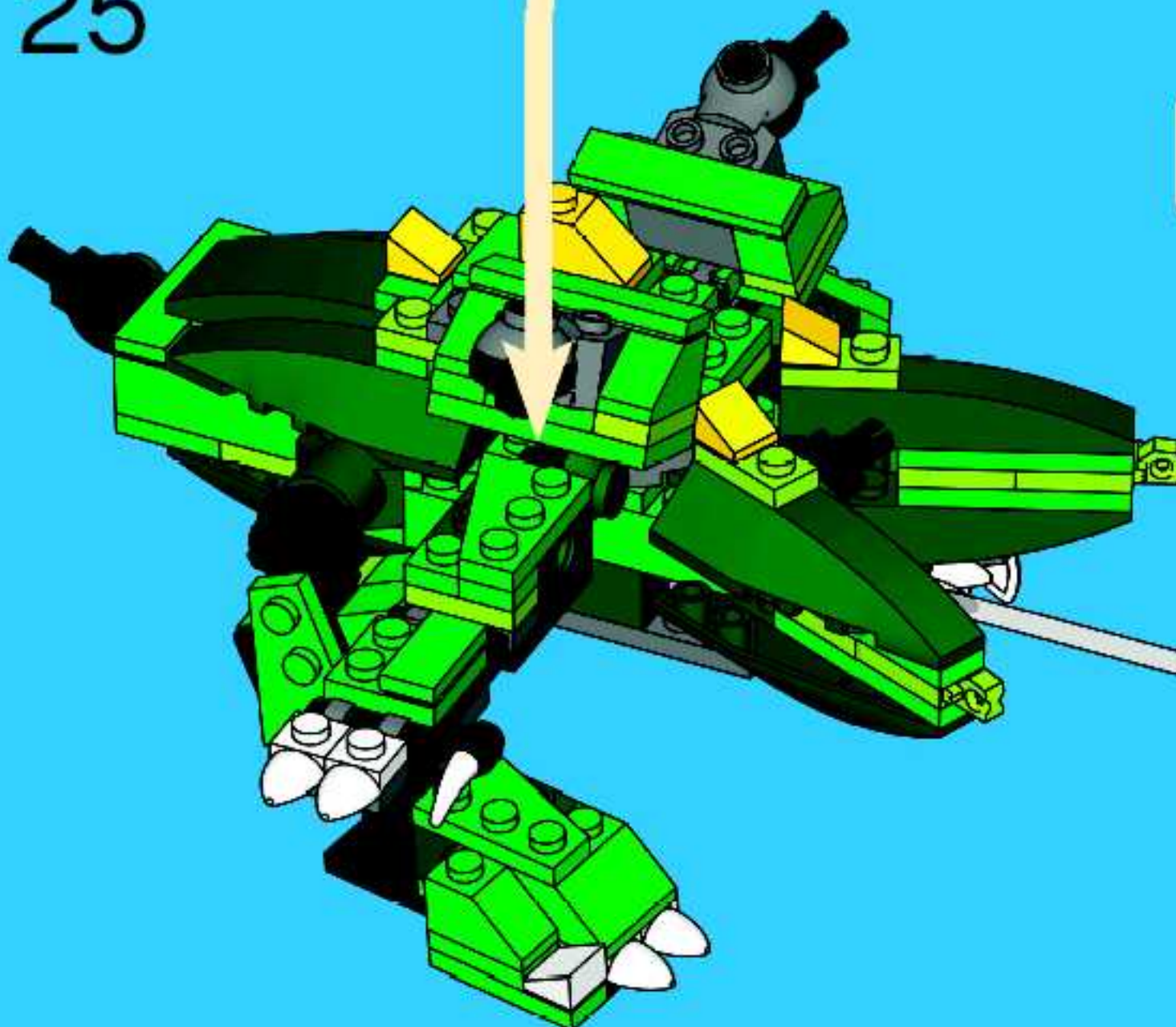

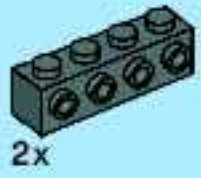
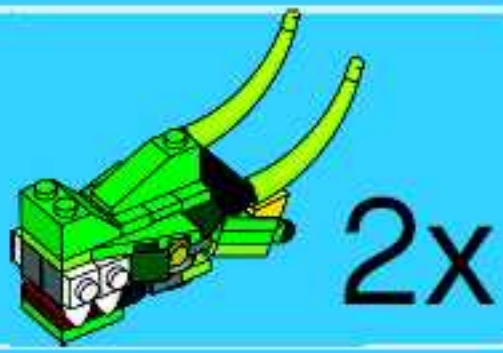

1

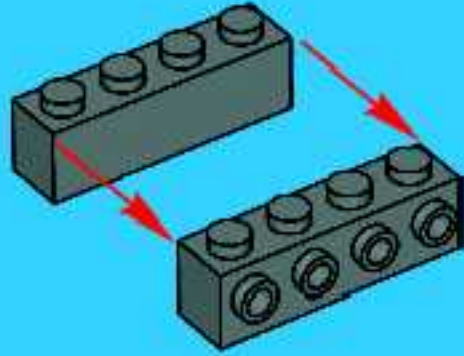

2

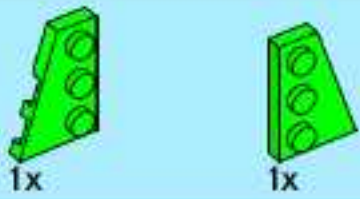

3

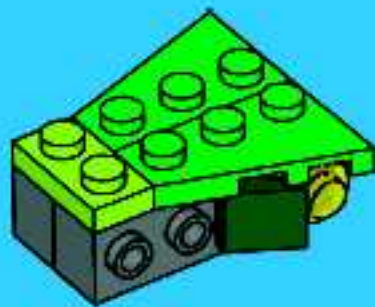

4

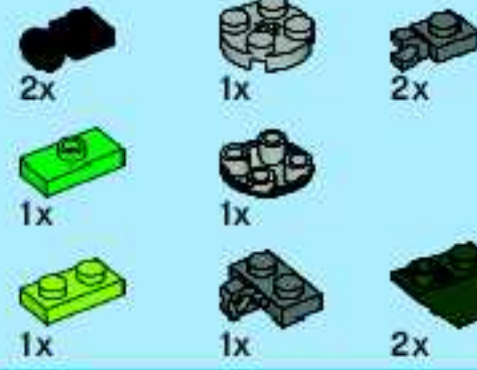
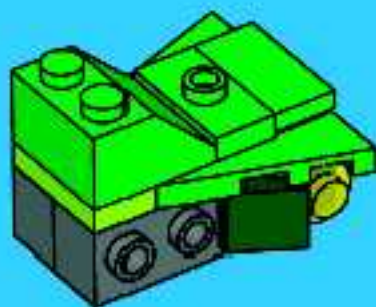

5

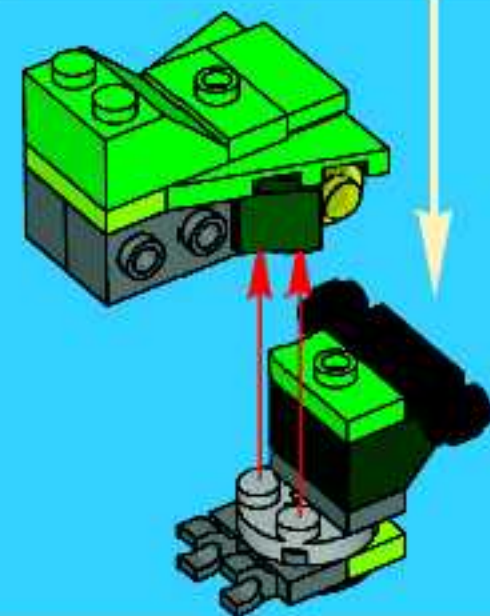
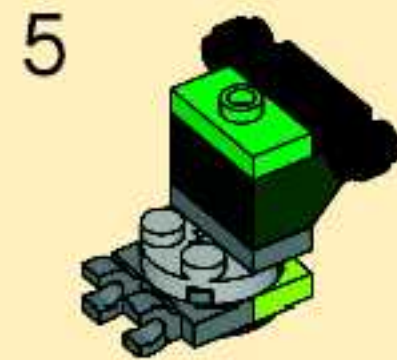
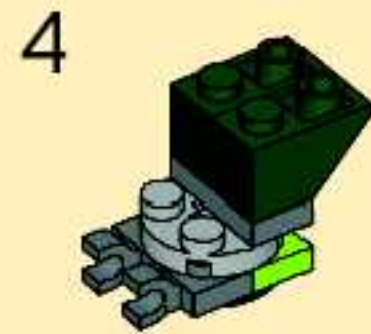
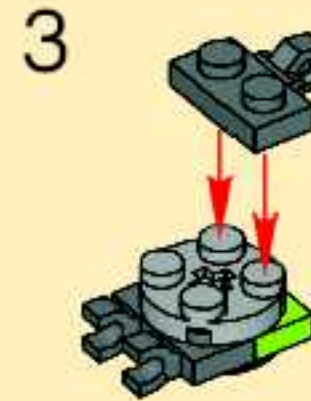



6

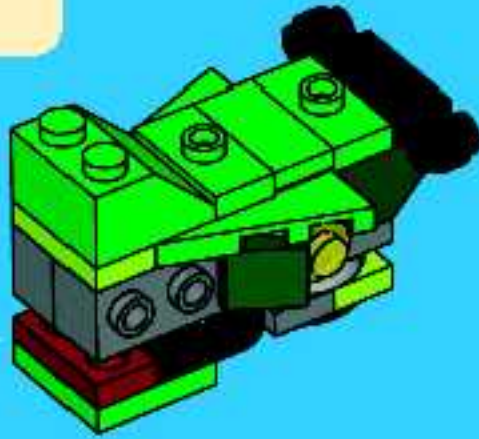

7

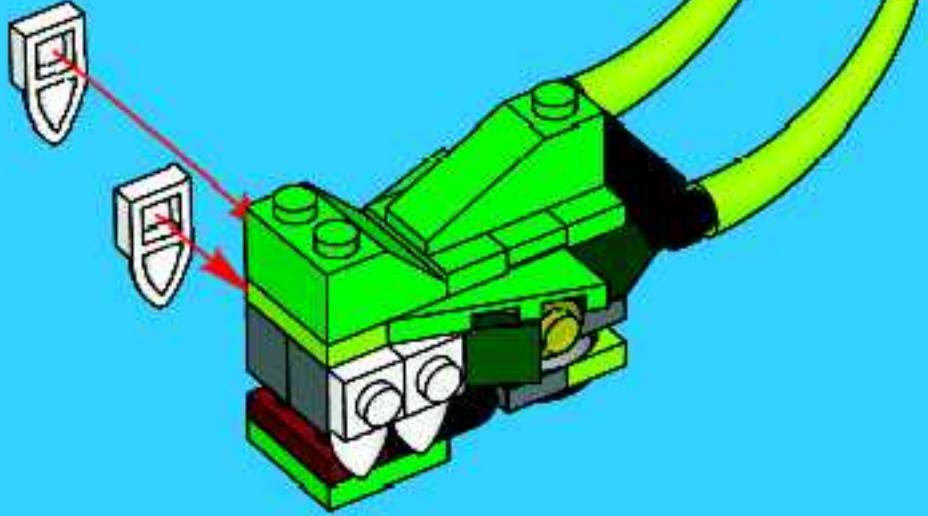

8

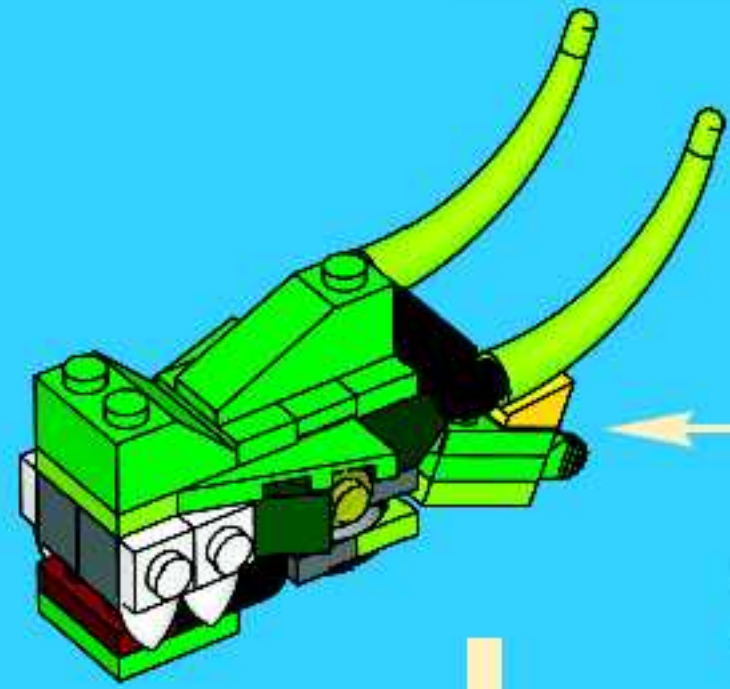
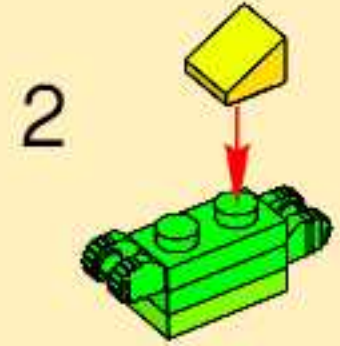
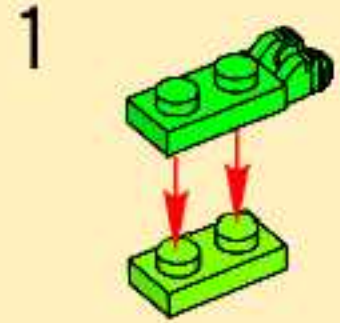

2x

26

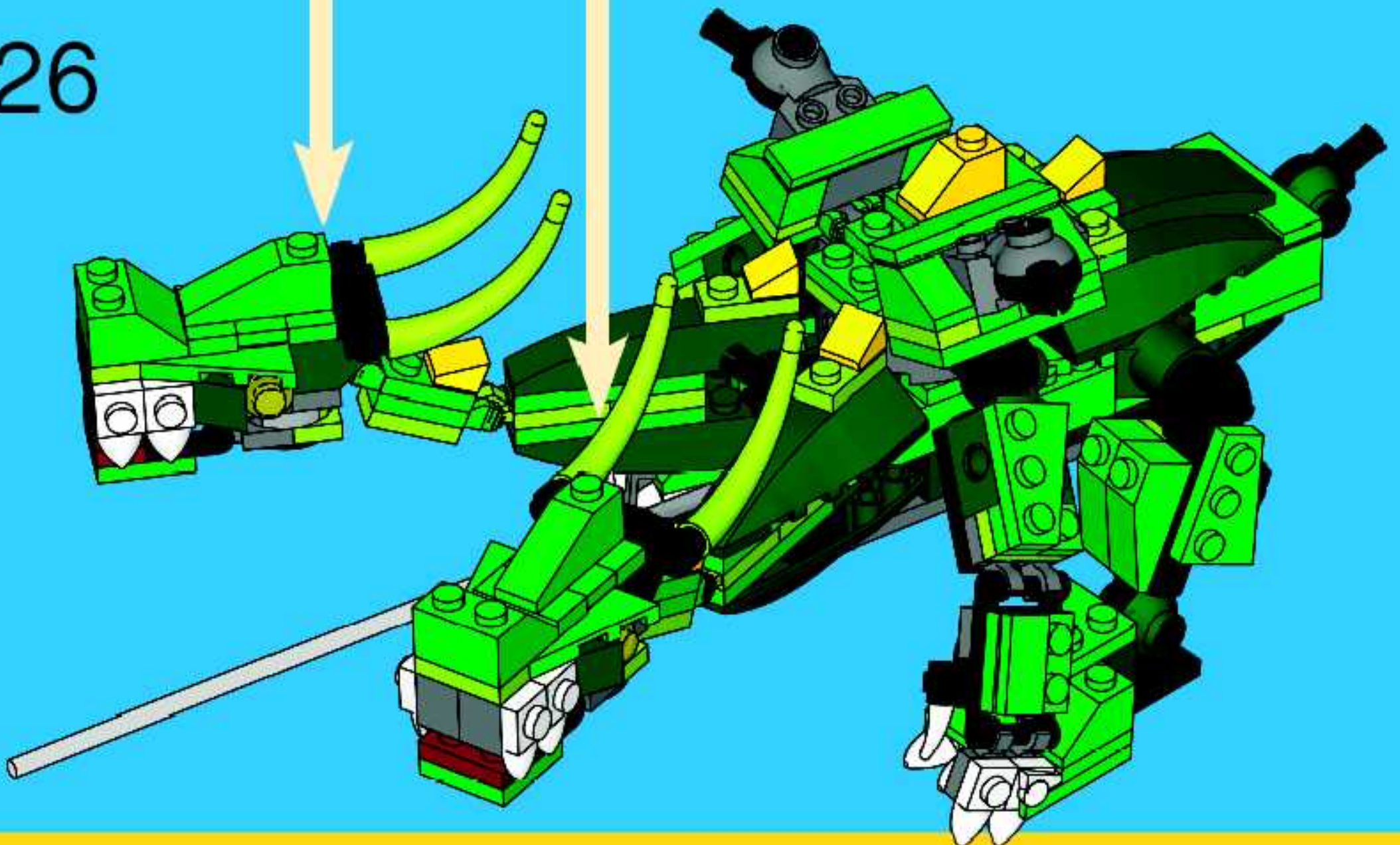

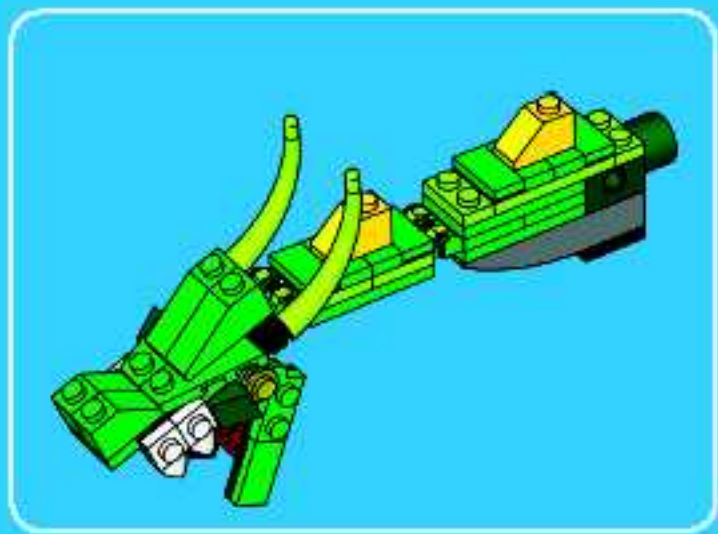

1

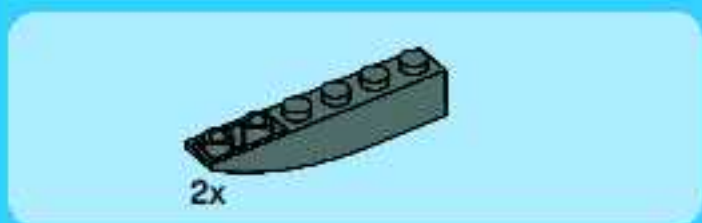

2



3

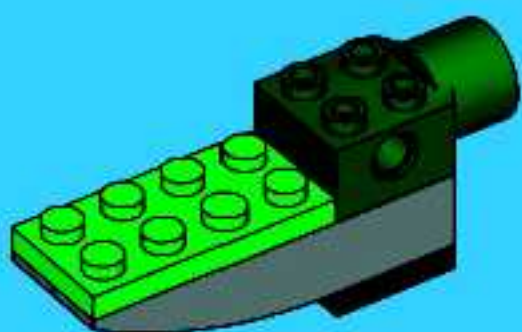

4

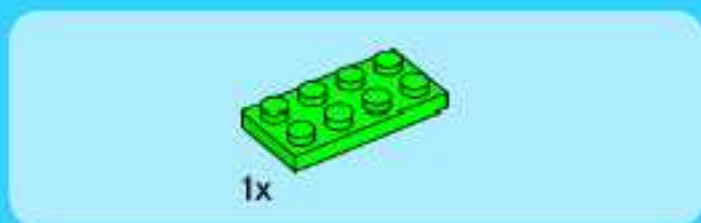
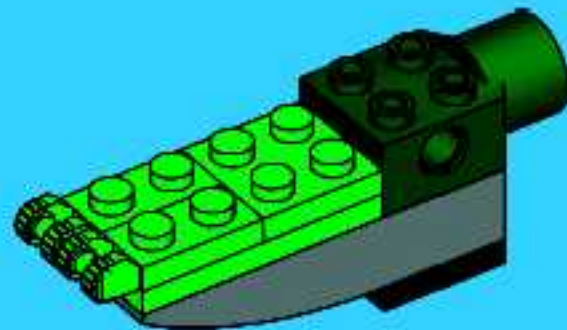

5

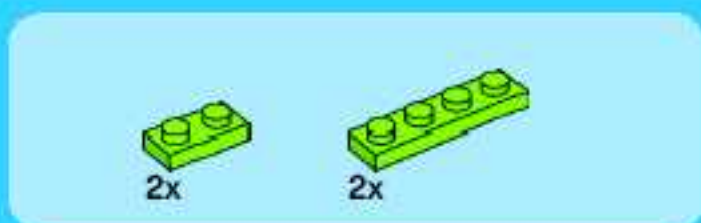
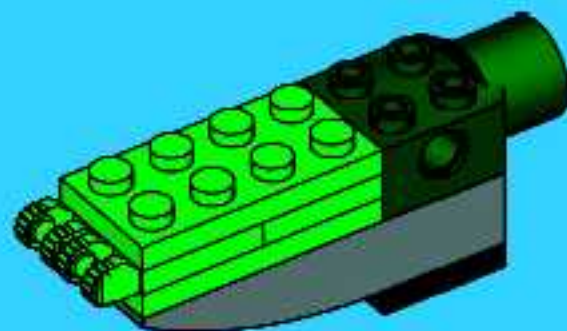

6

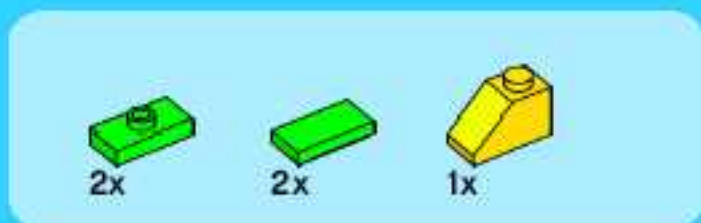
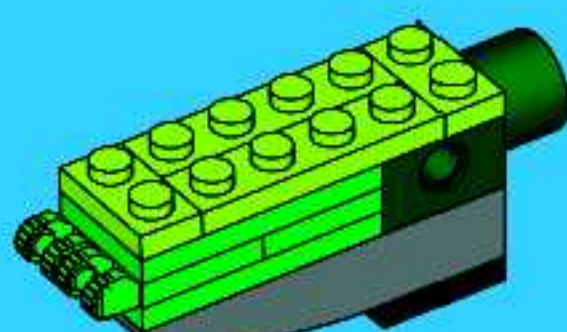

7

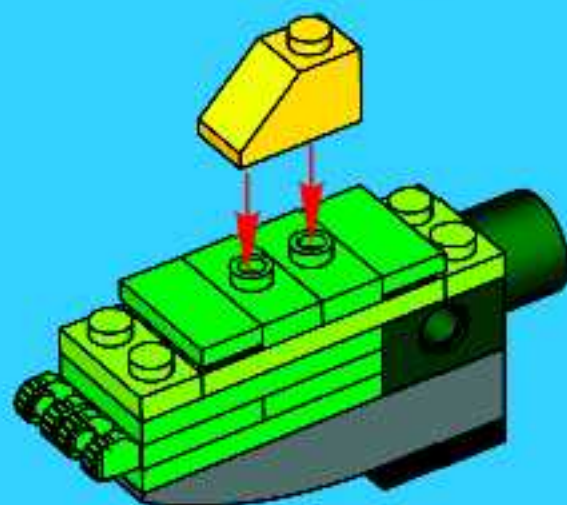

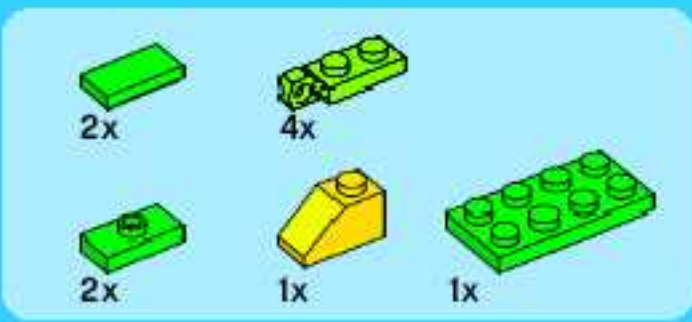

8

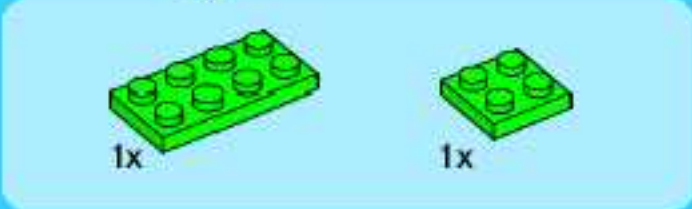
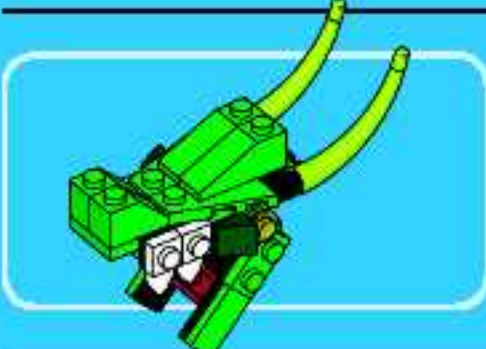
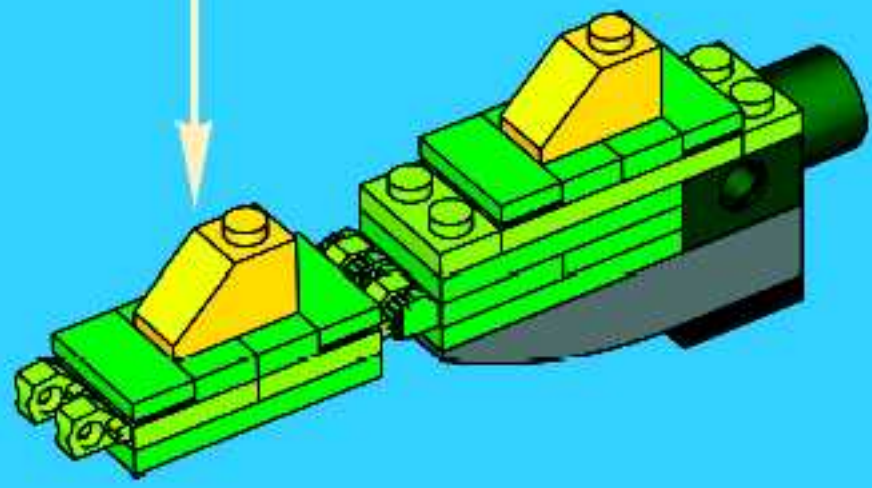
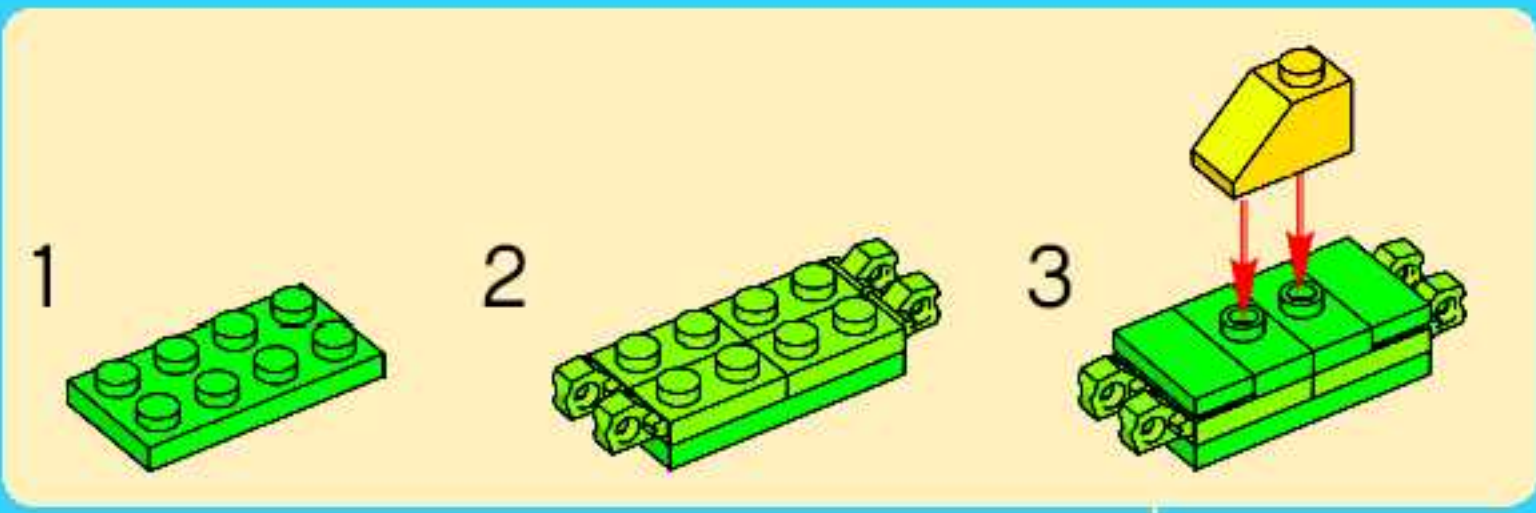

1

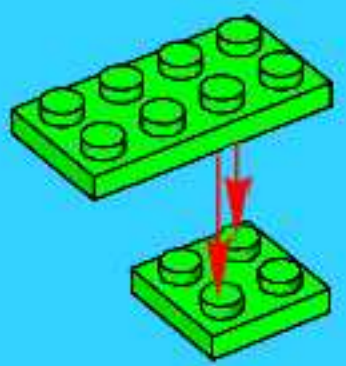

2

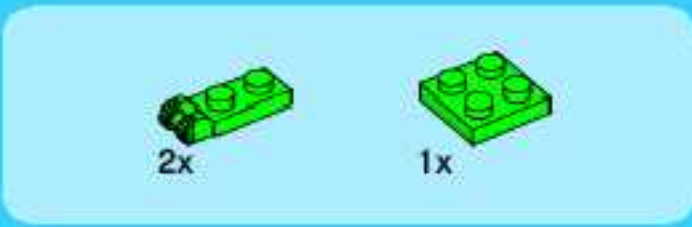
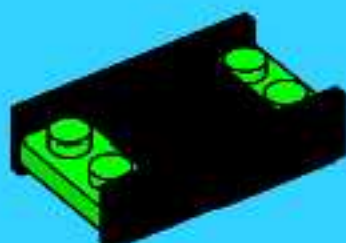

3

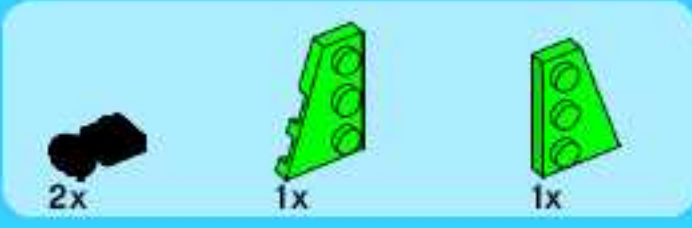
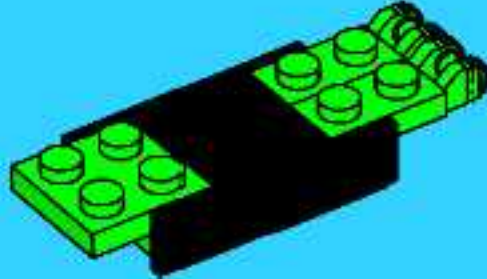

4

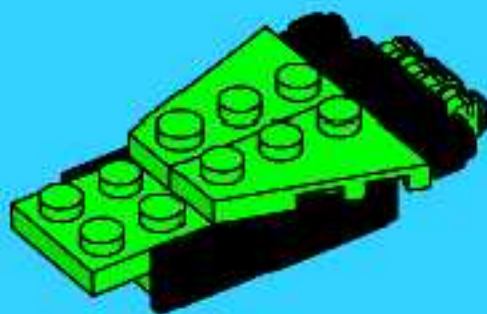

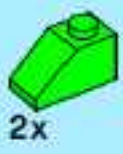

2x

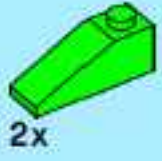

2x

5

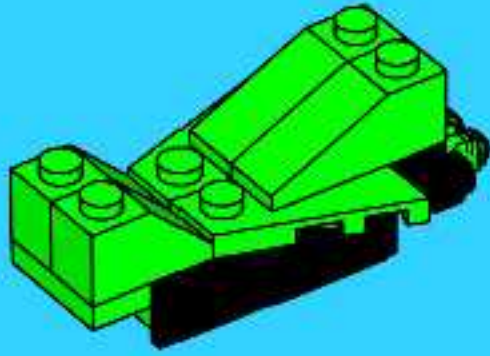

1x



1x



1x



1x



2x

6

1



2

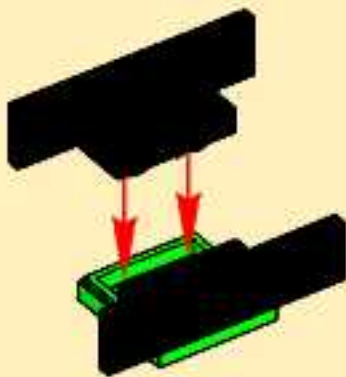

3

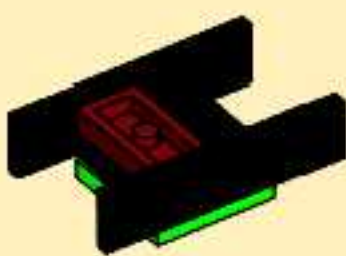

4

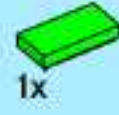
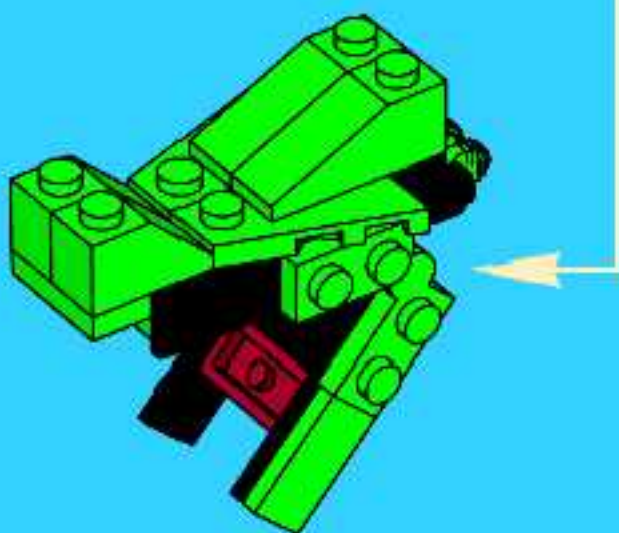
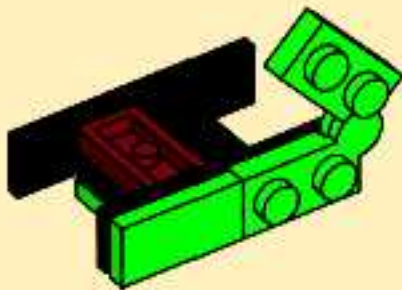

1x



1x

7

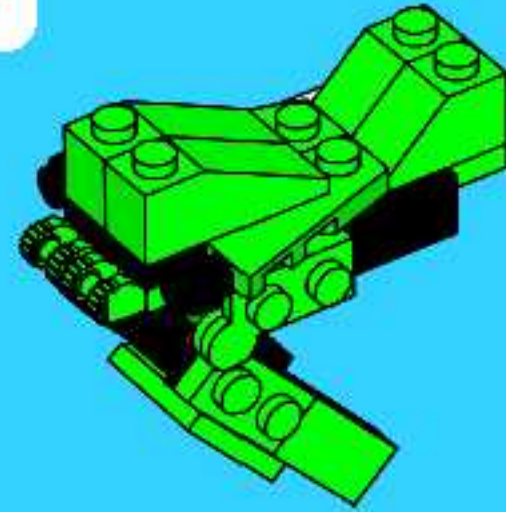

1x

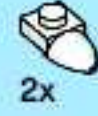

2x



1x

8

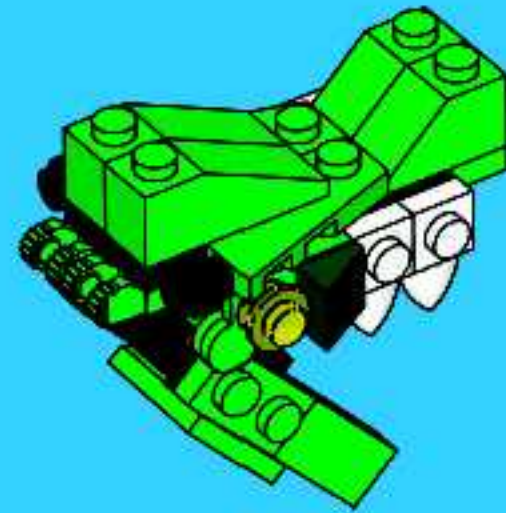

1x



2x



1x

9

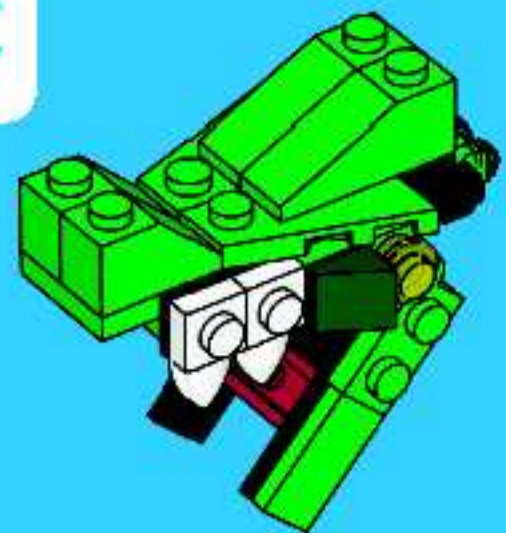



2x

10

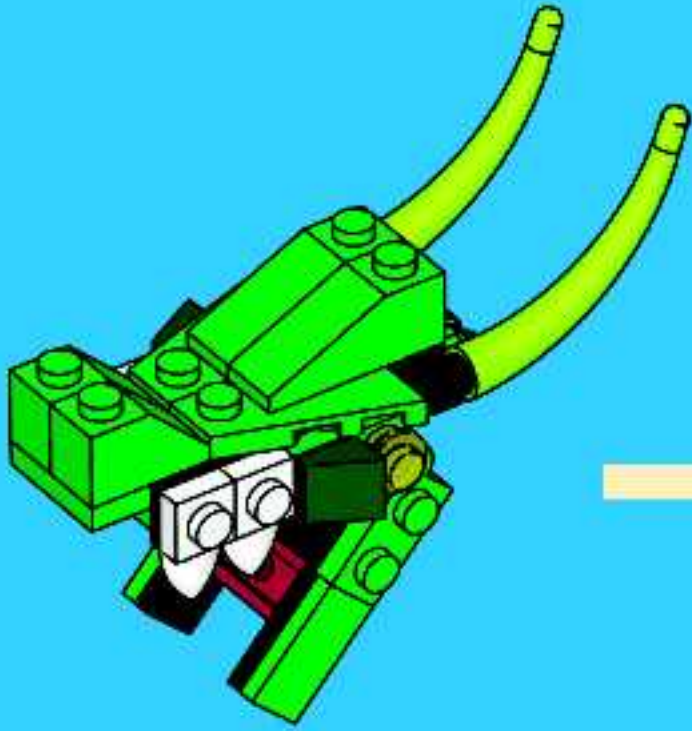

9

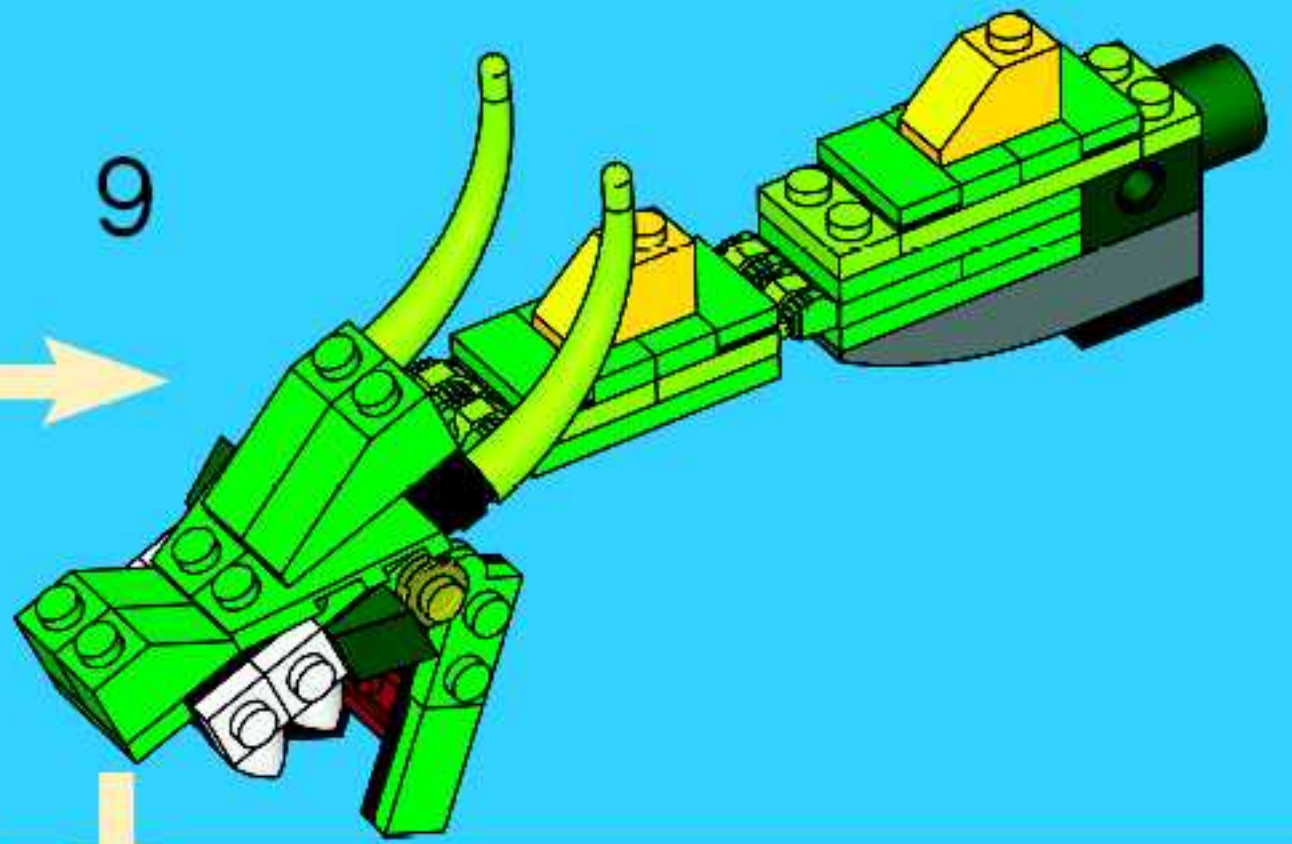

27

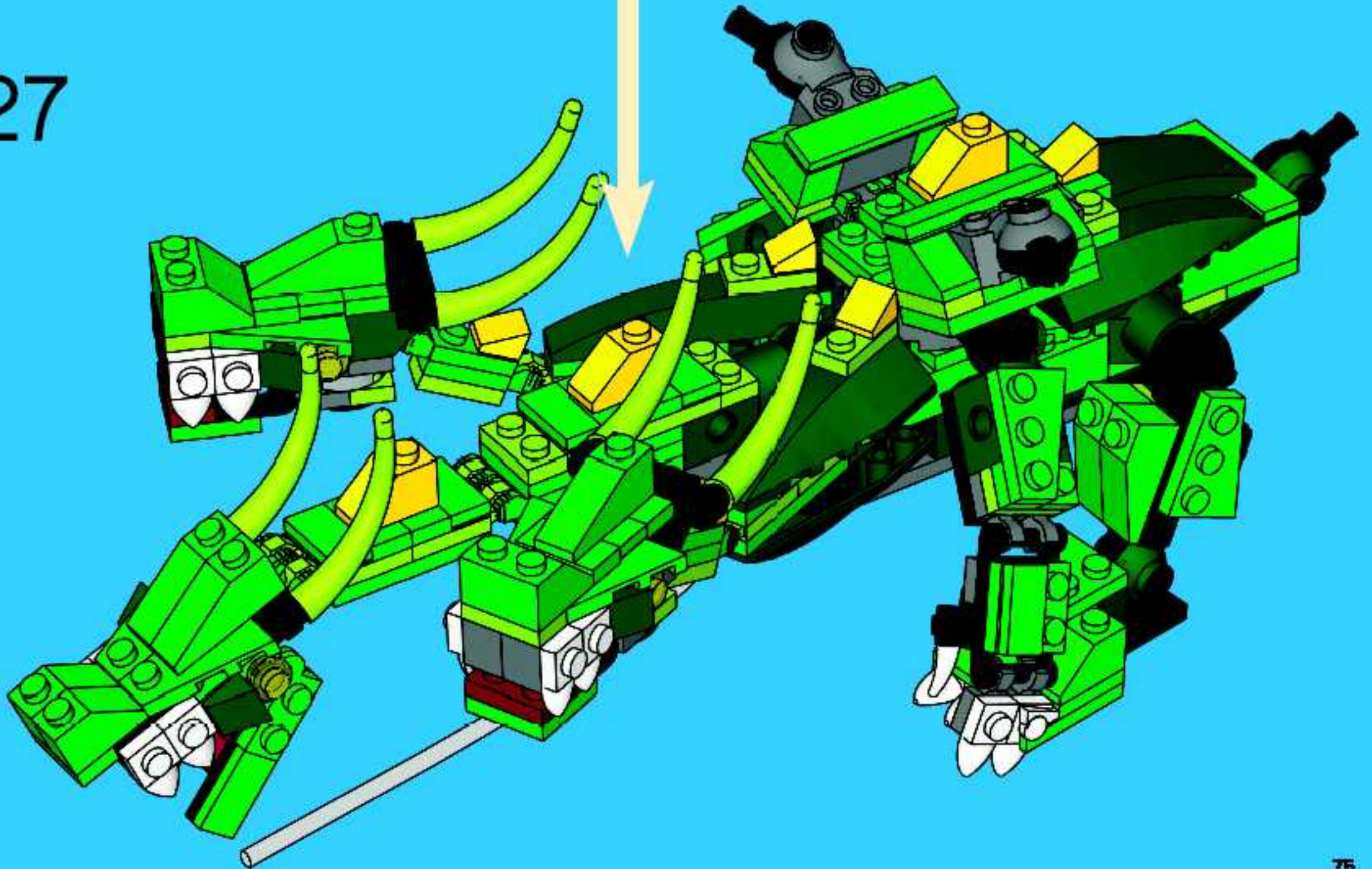



1x



2x

28

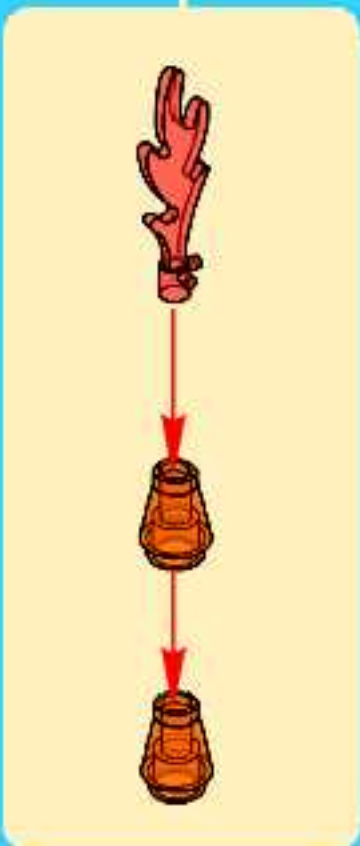
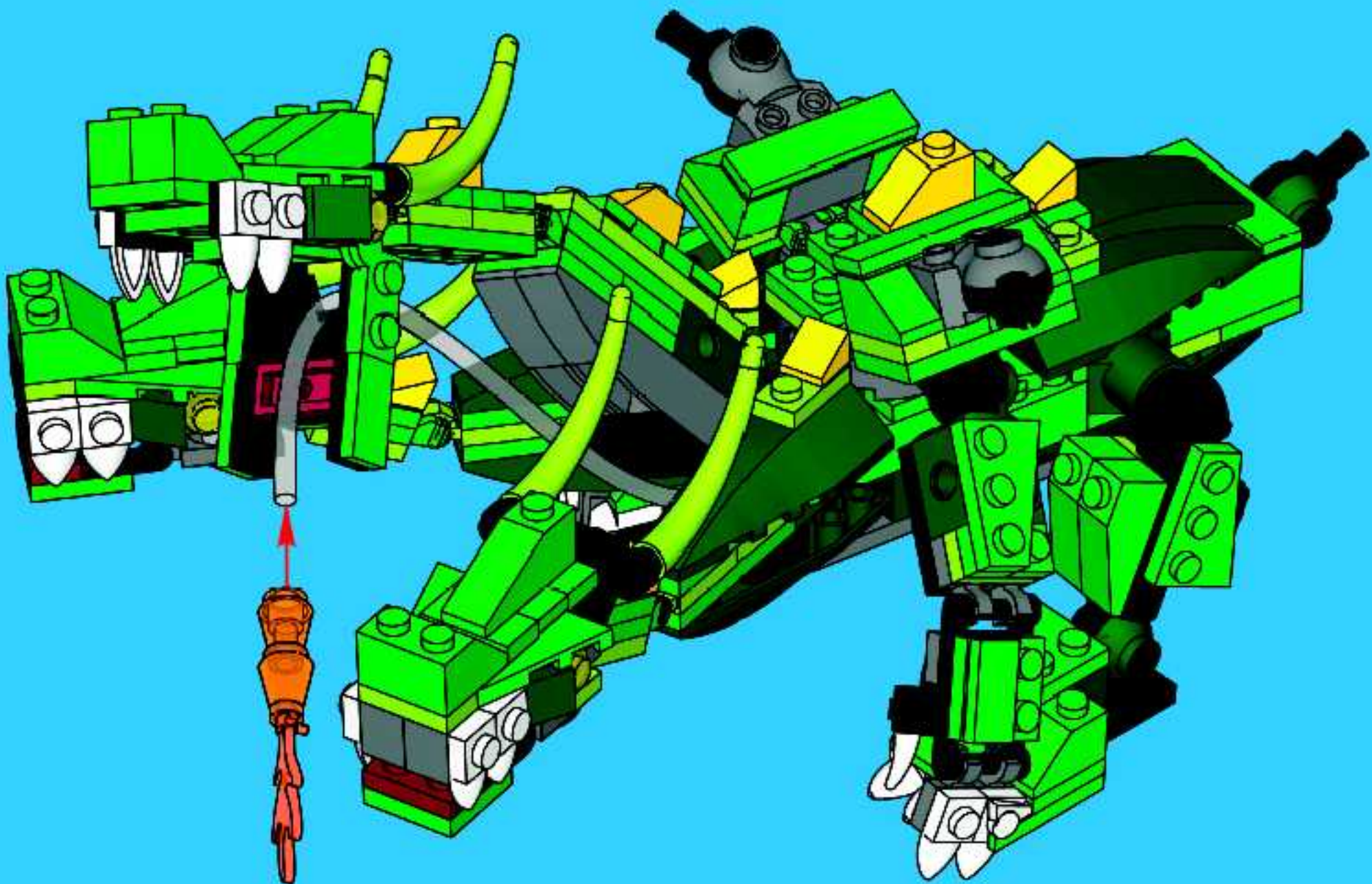

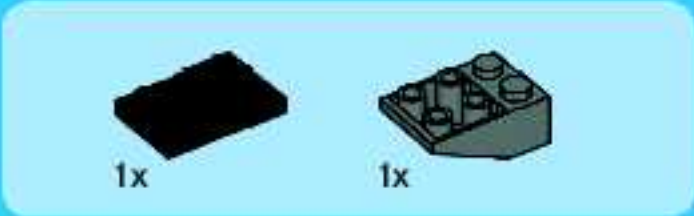
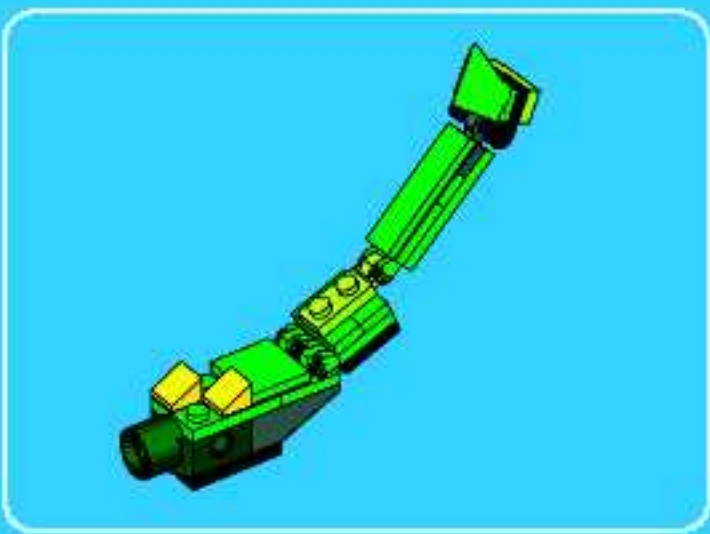

1

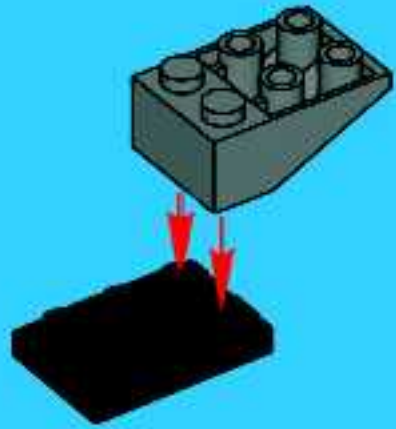

2



3

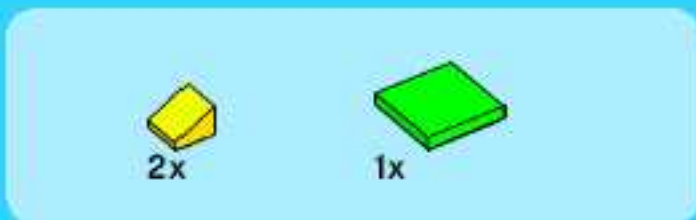
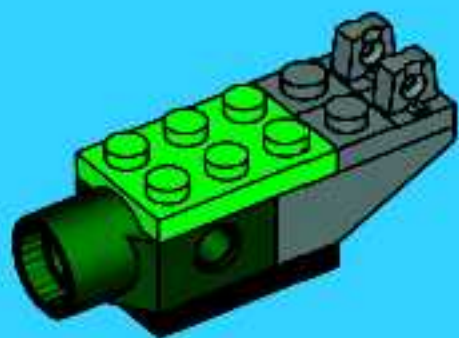

4

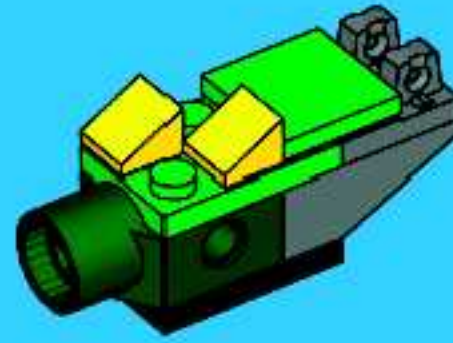

5

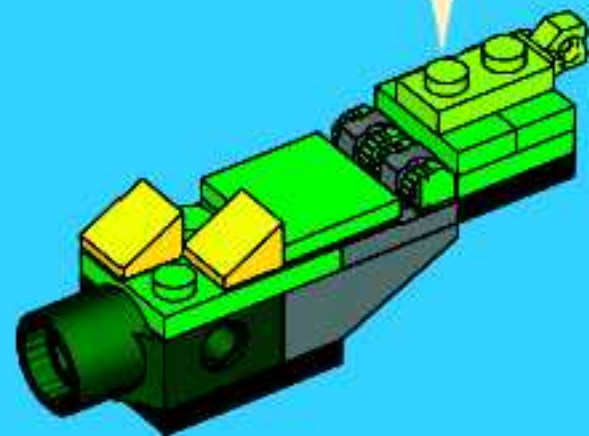
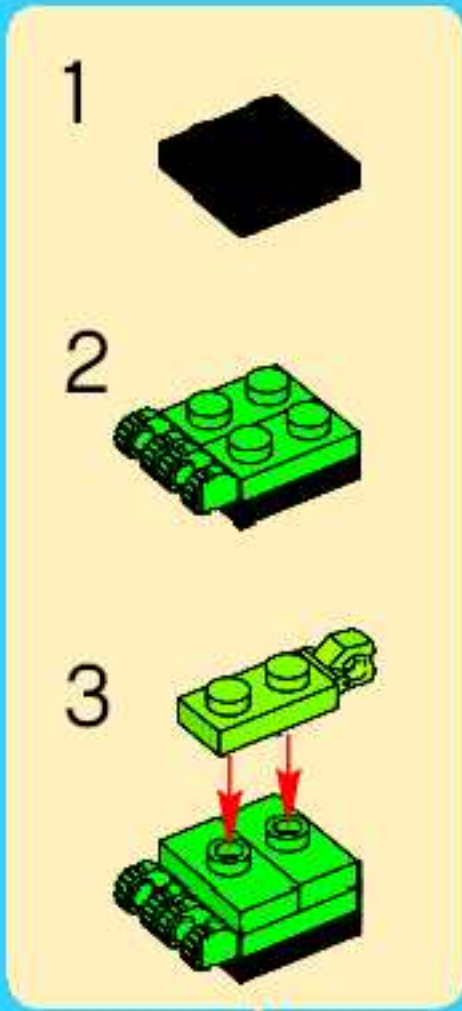

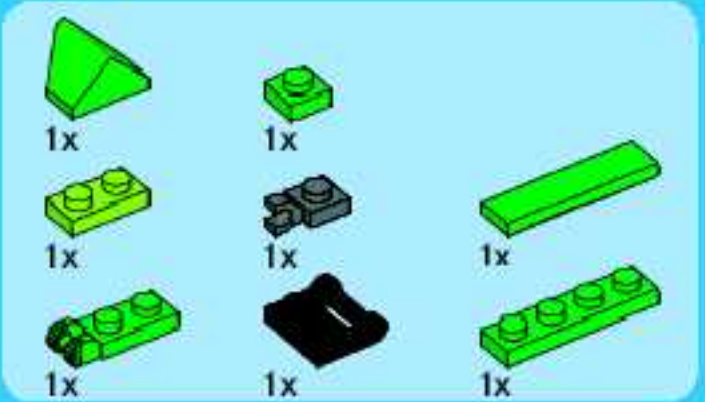

6

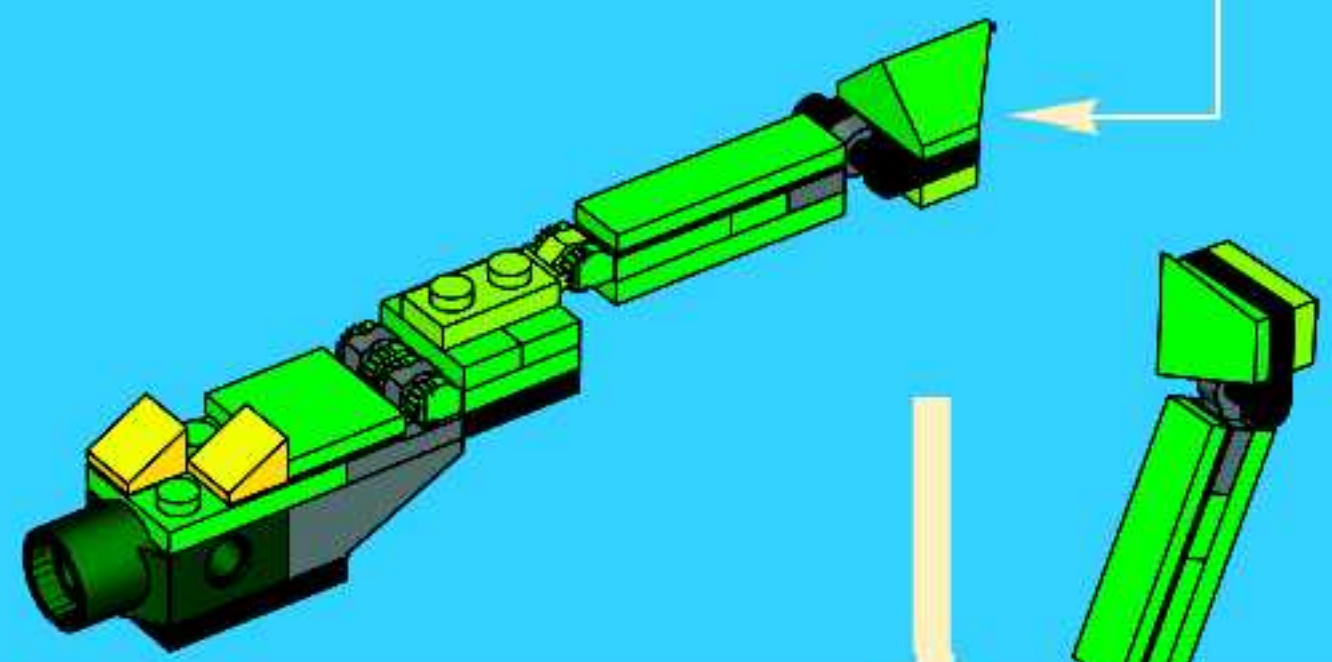
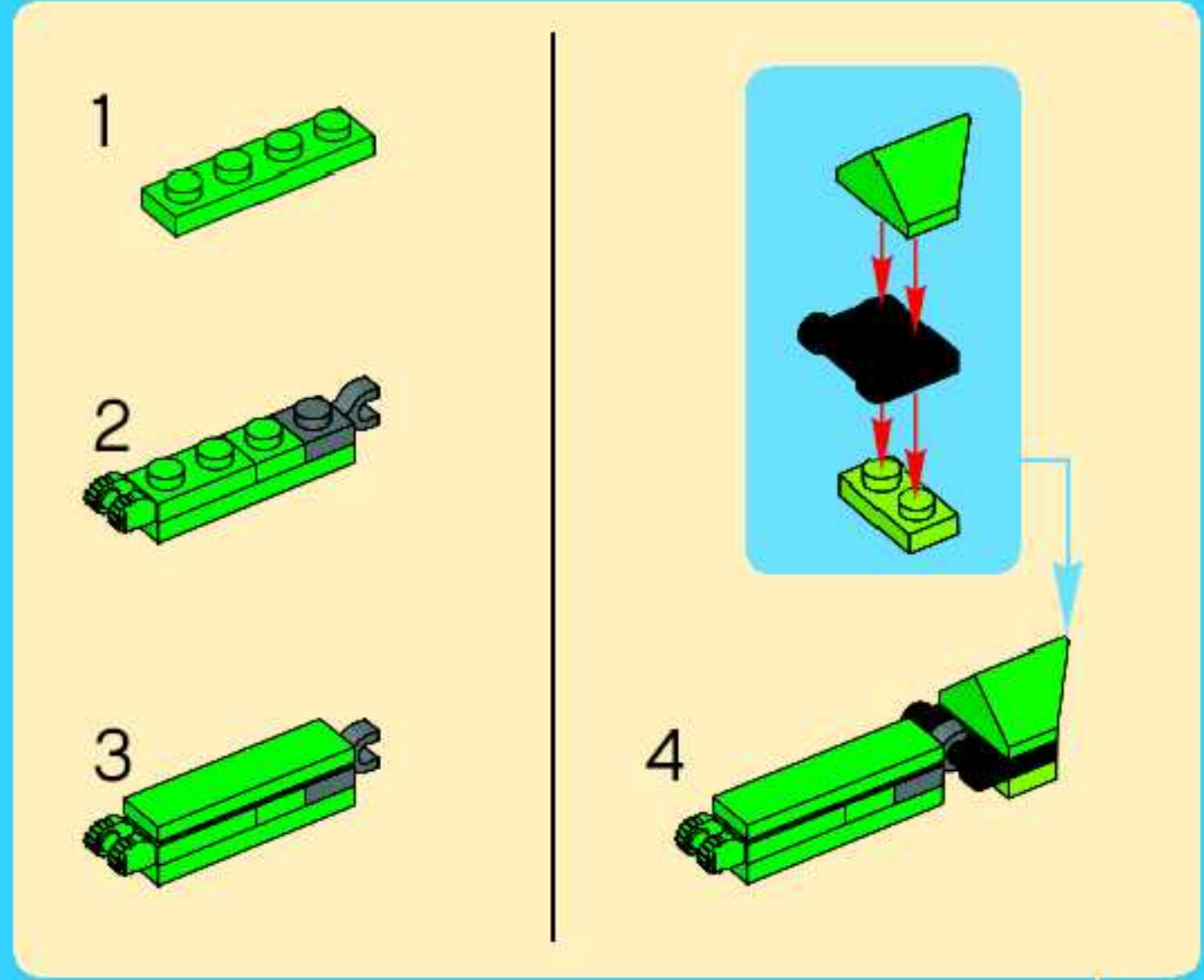

29



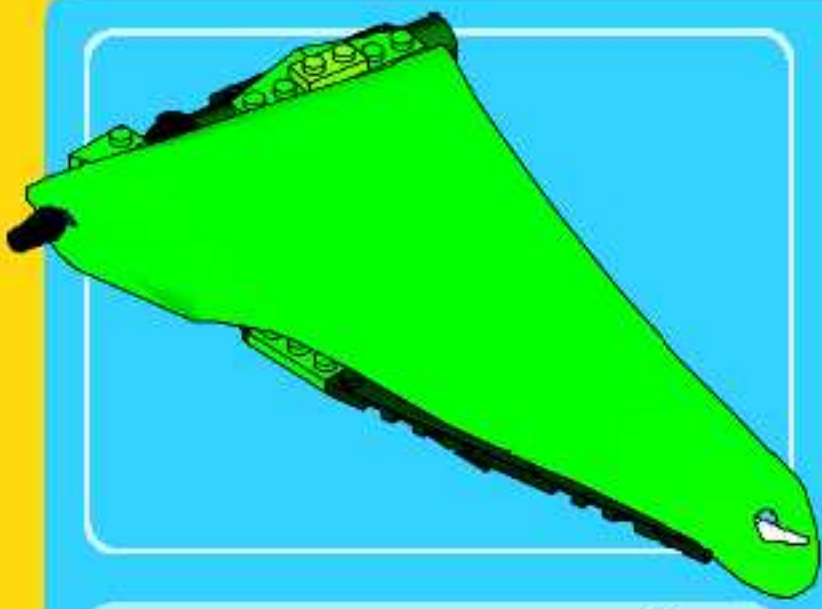

2x

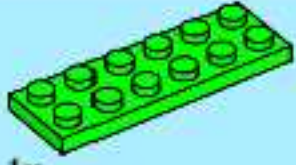

1x

1

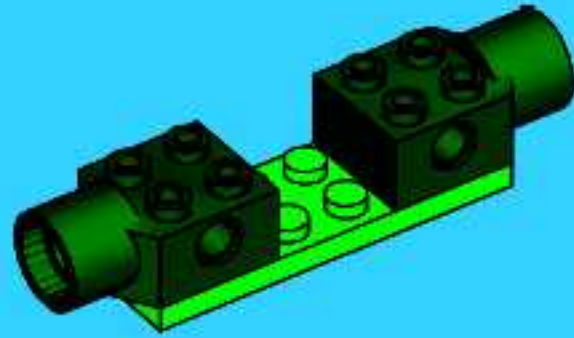

1x



2x

2

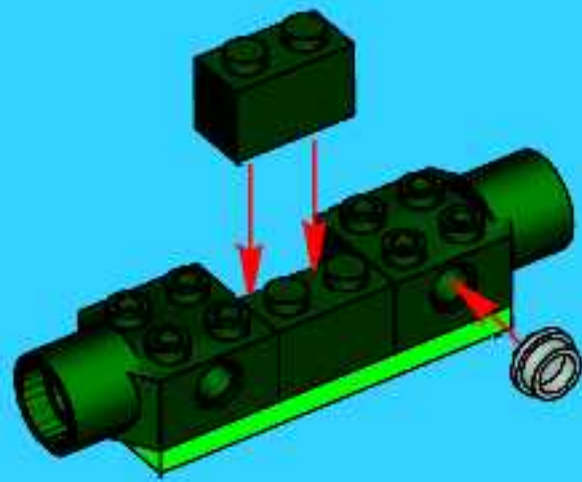

1x



1x

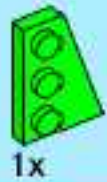

1x

3

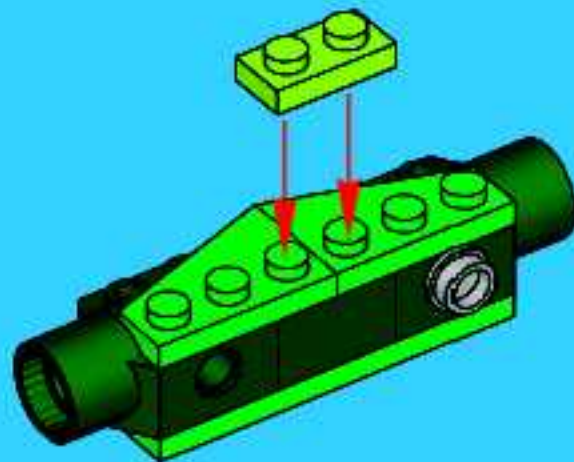

4

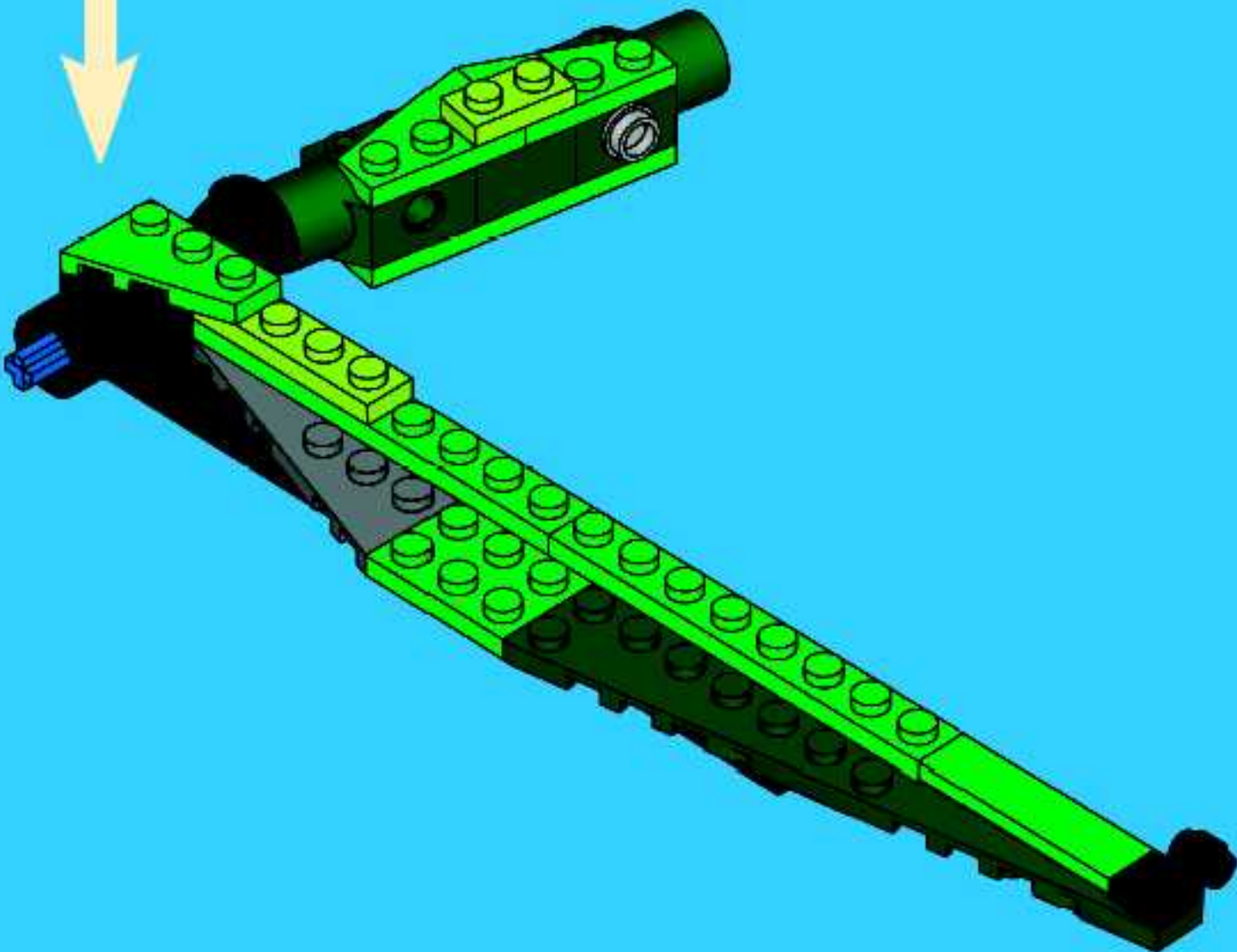
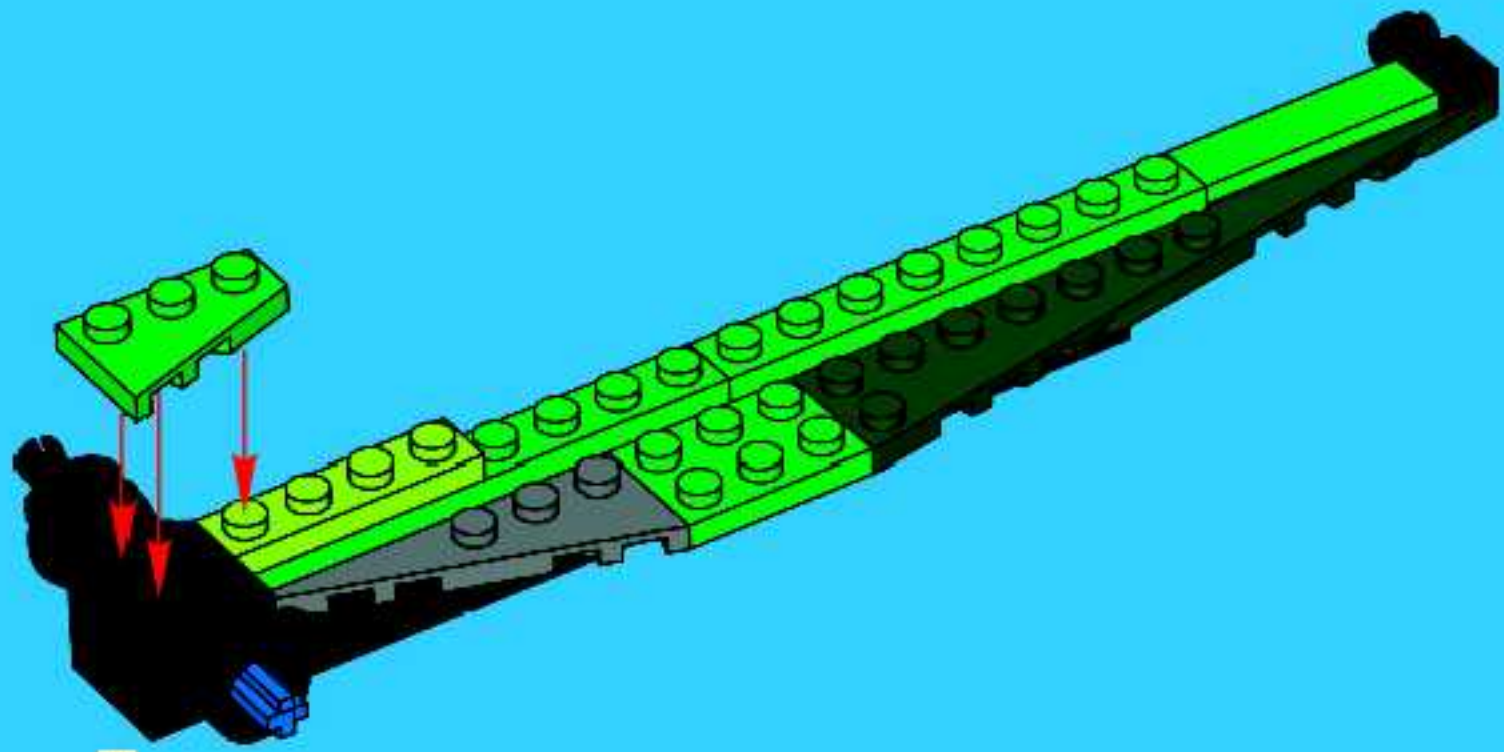

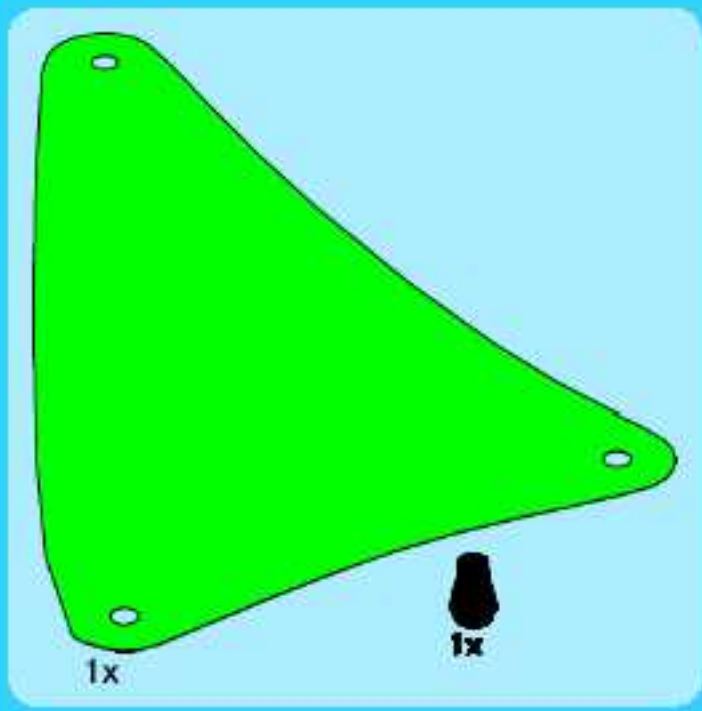

5



6

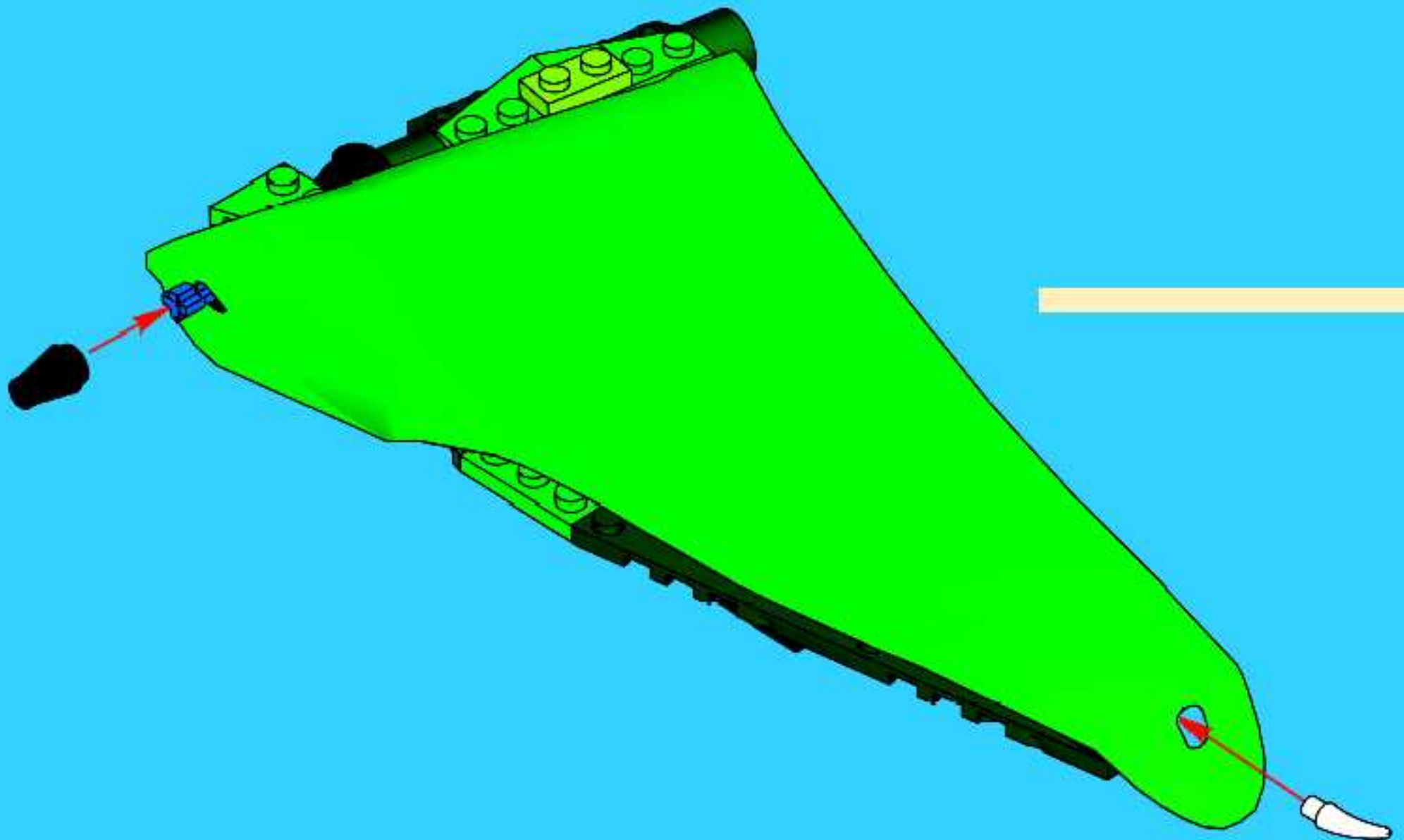

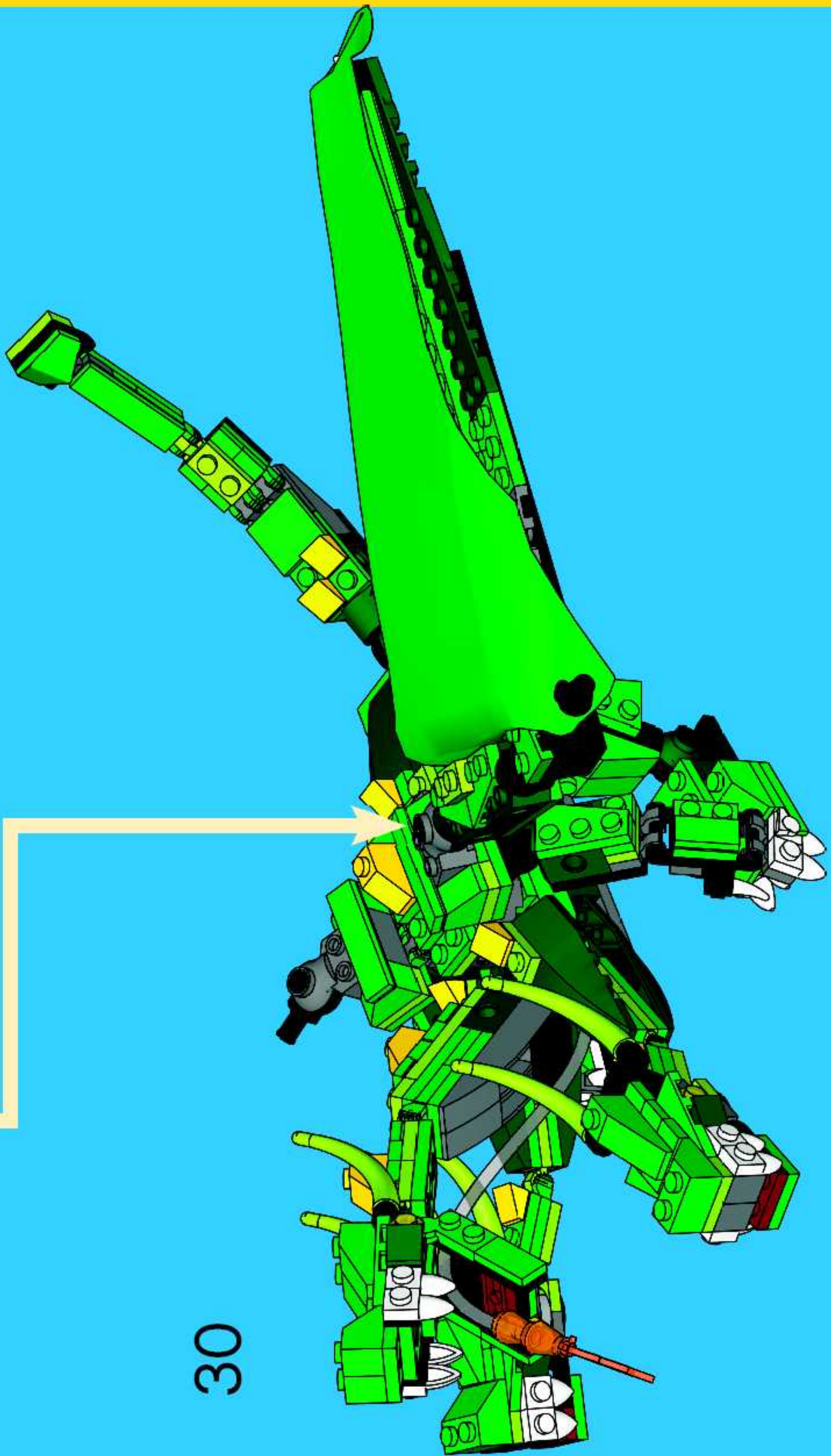

30

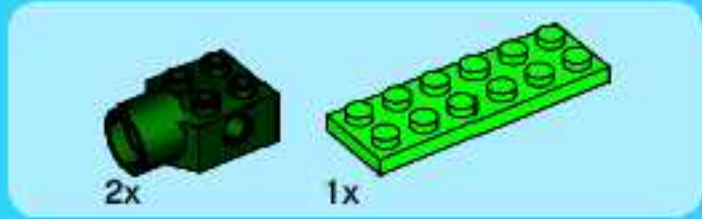
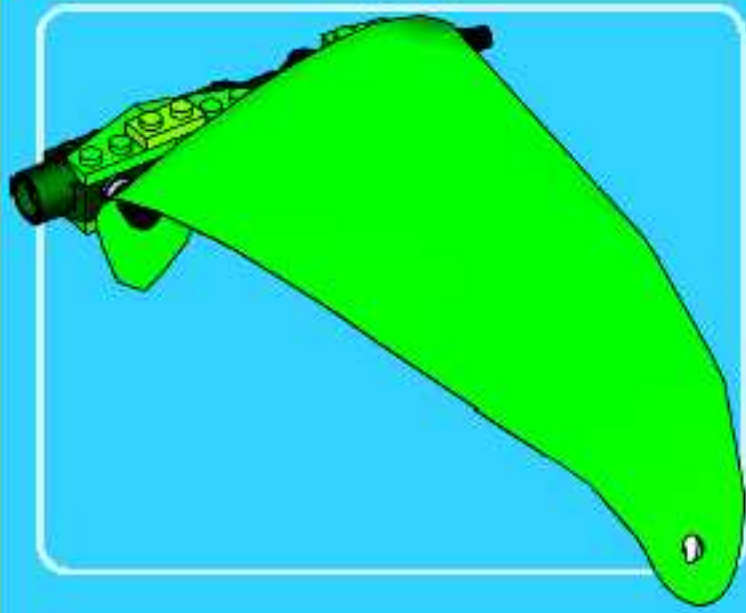

1

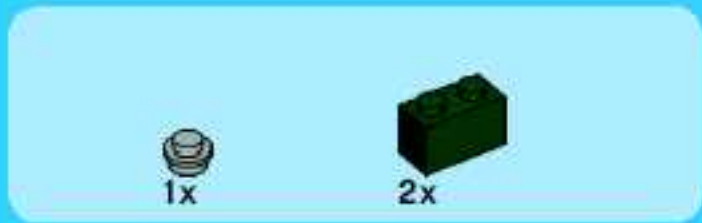
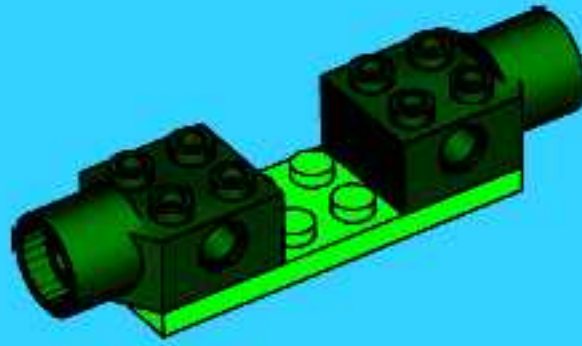

2

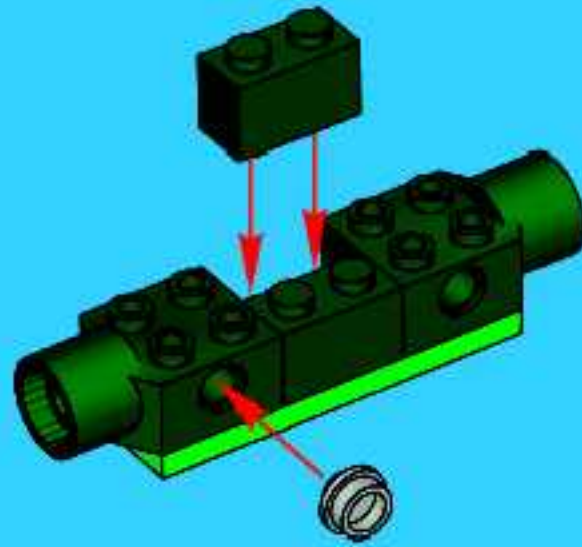

3

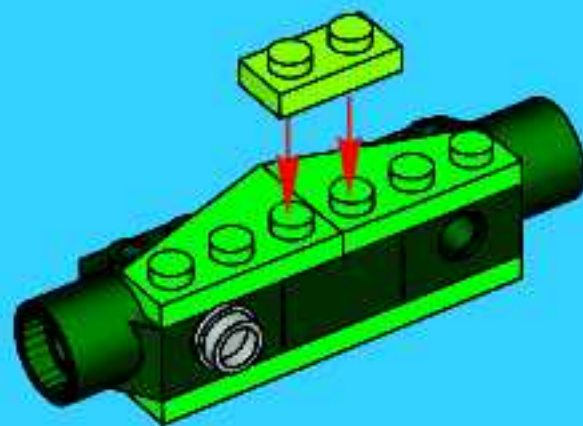

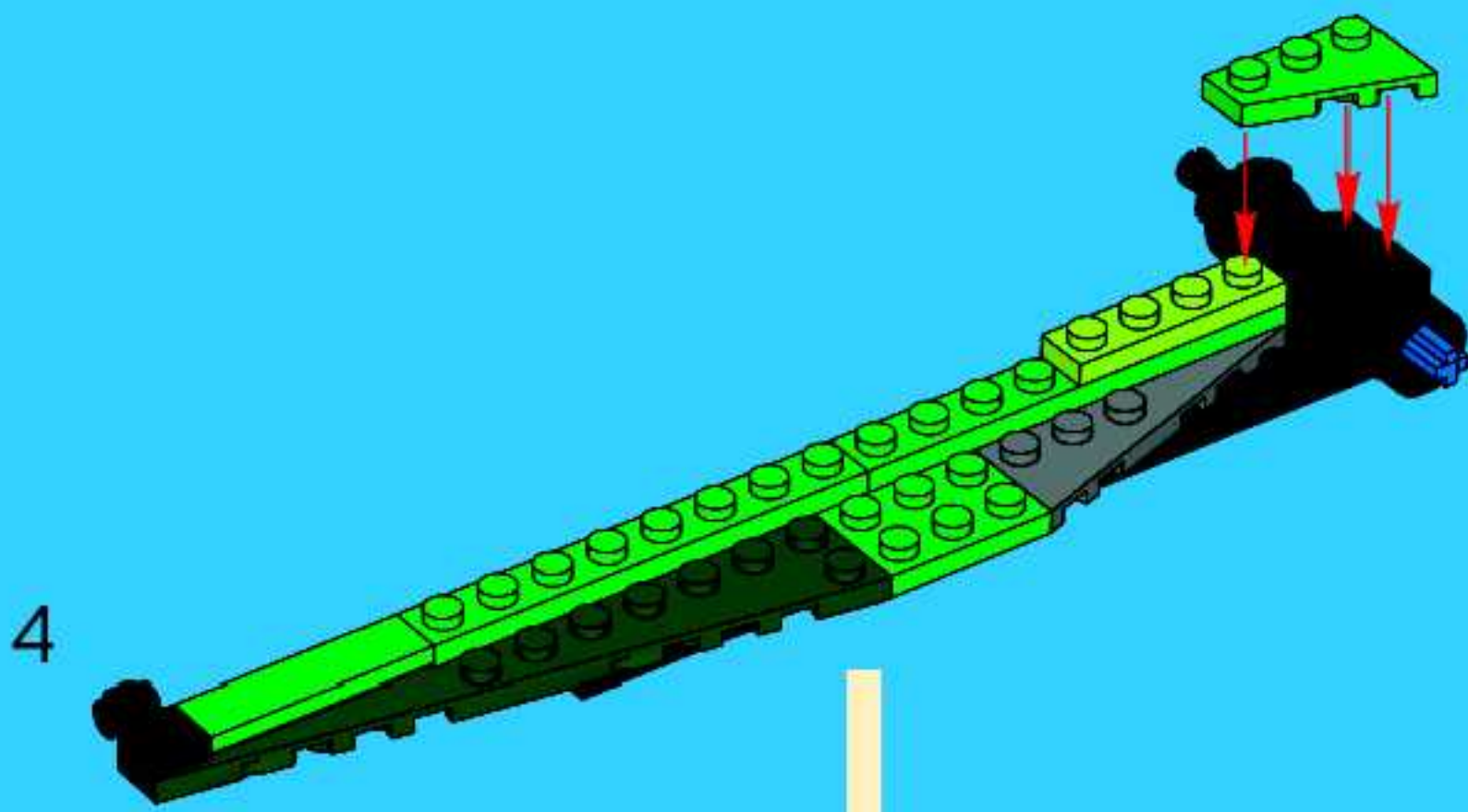

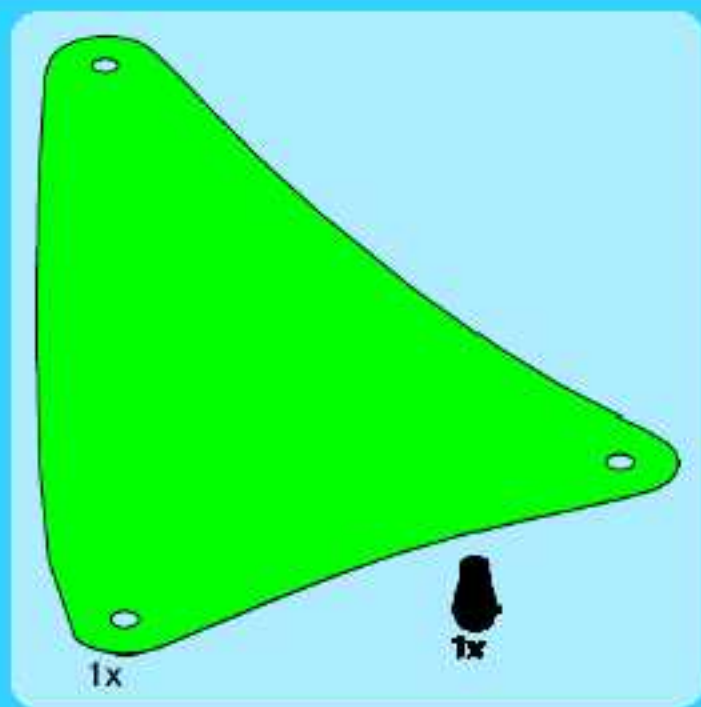

5

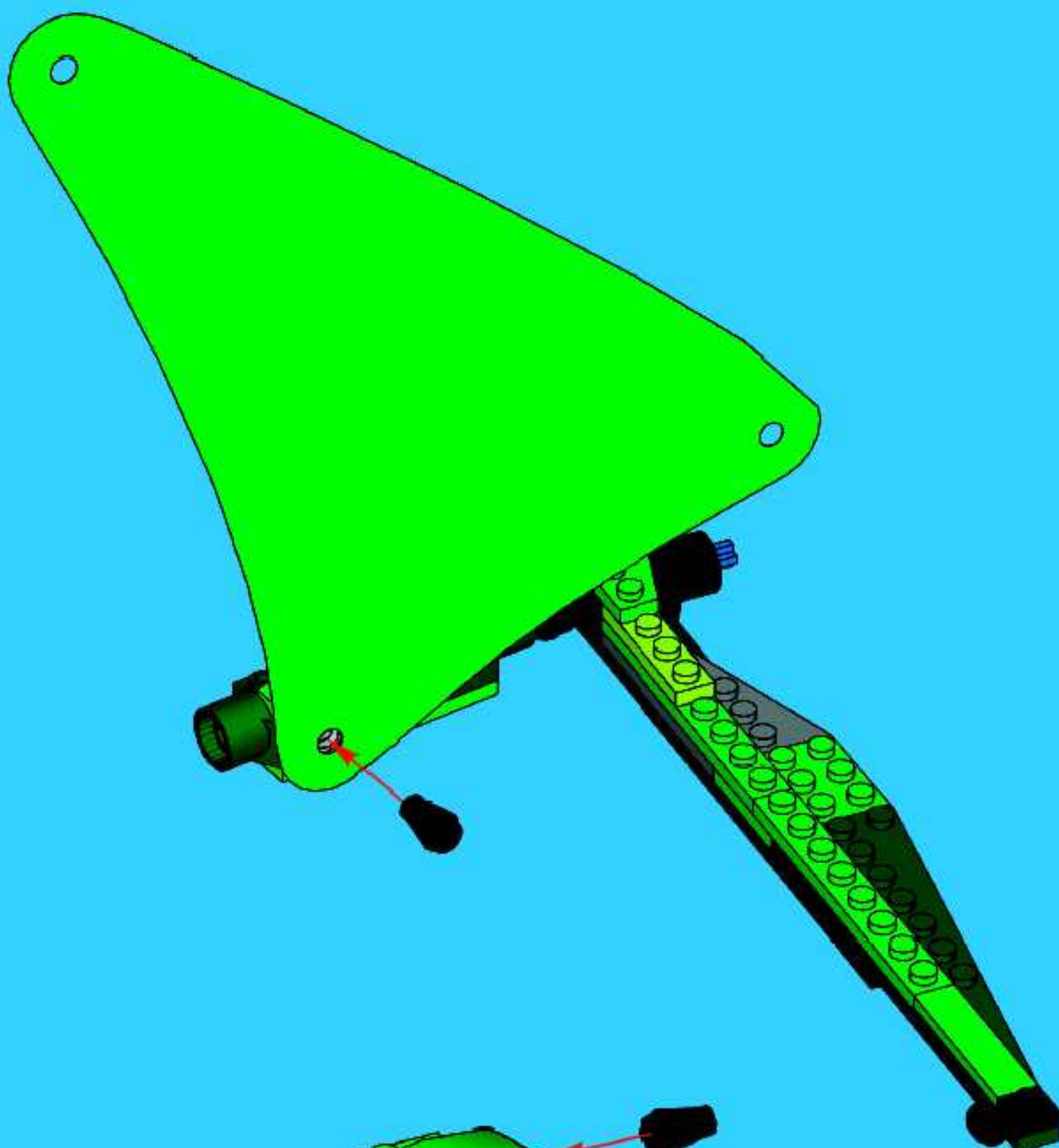

6

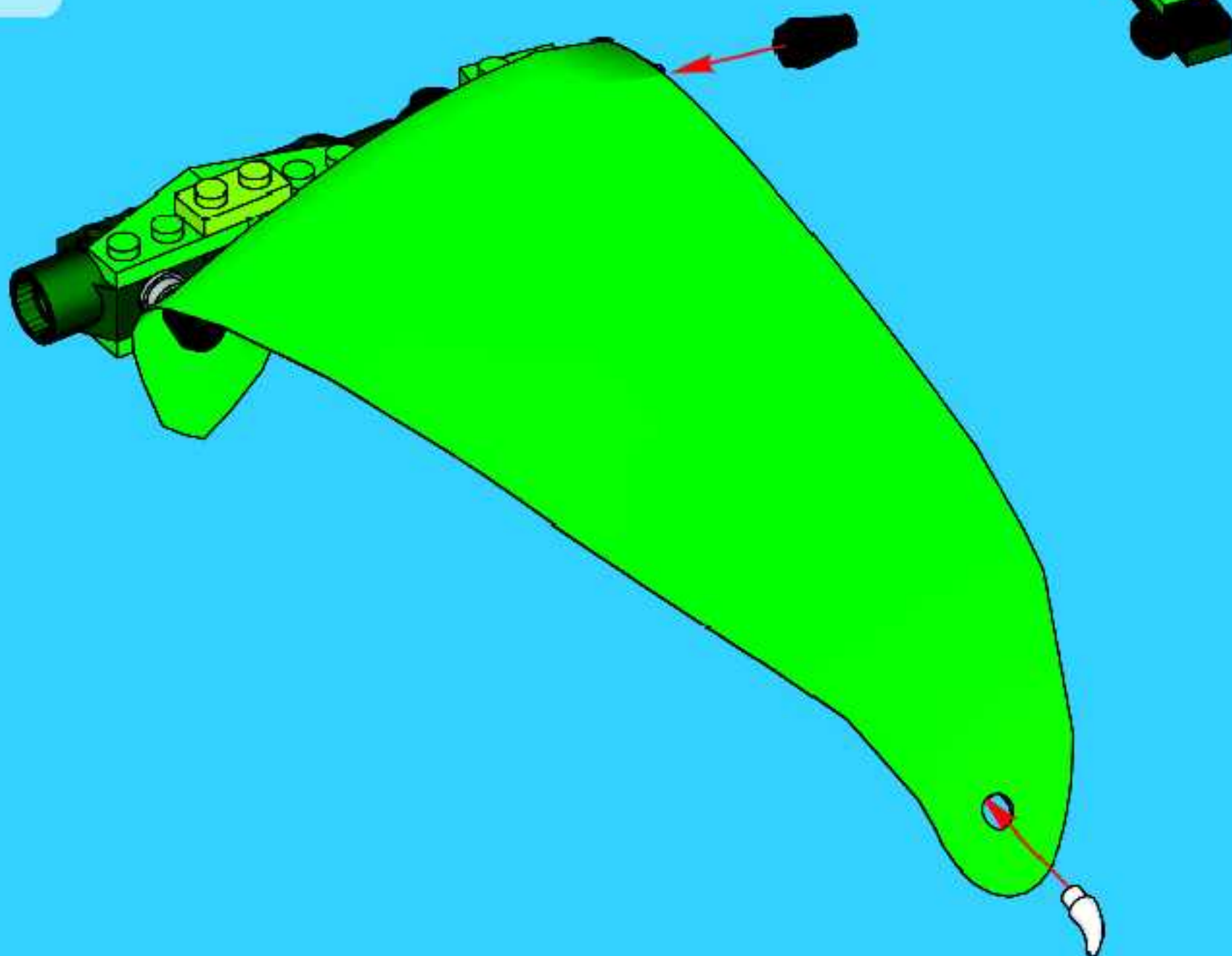



31





Win! Gagne! 当たります Gewinne!

Win LEGO products

We would like to know what you think about your new LEGO product. Log on to the web address below for further instructions.

Gagne des produits LEGO

Nous aimerions savoir ce que tu penses de ton nouveau produit LEGO. Tu obtiendras davantage d'informations en visitant le site Internet indique ci-dessous.

Gewinne LEGO produkte

Wir sind sehr an deiner Meinung über dein neues LEGO Produkt interessiert. Gehe einfach zu der unten angegebenen Webadresse – dort findest du weitere Informationen.

Estimado usuario LEGO

Al contestar algunas preguntas en inglés, francés, alemán o japonés, en el sitio www.acnielsen.aim.dk/lego, podrás participar en el sorteo de algunos valiosos premios LEGO.

Caro Consumidor da LEGO

Ao responder a algumas perguntas em Inglês, Francês, Alemão ou Japonês no endereço www.acnielsen.aim.dk/lego irá participar num concurso para ganhar valiosos prémios da LEGO.

Kedves ifjú LEGO Vásárló

Ha ellátogatsz a www.acnielsen.aim.dk/lego honlapra és ott angol, francia, német vagy japán nyelven megválaszolsz néhány kérdést, akkor részt veszel egy versenyben, amelyben értékes LEGO díjakat nyerhetsz.

抽選でレゴ®製品が当たります

私たちは、皆さんがお買い求めのレゴ®製品についてどんな感想をお持ちか、知りたいと思っています。質問に答えて、美しいレゴ製品の抽選に応募しませんか。アンケートの回答には、ほんの3分ほどしかかかりません！詳しくは、以下のウェブアドレスまでアクセスしてください。

www.acnielsen.aim.dk/LEGO



Any questions regarding your new LEGO product, please contact:

Customer Service | Kundenservice

Service Consommateurs

Servicio Al Consumidor at

www.lego.com/service or dial



00800 5346 5555



1-800-422-5346



Discover the **LEGO® UNIVERSE!**
 Entdecke das **LEGO® UNIVERSUM!**
 Ontdek het **LEGO® UNIVERSUM!**
 Découvre **L'UNIVERS LEGO®!**



FREE LEGO Magazines
 Des Magazines LEGO GRATUITS !
 GRATIS LEGO Magazine
 KOSTENLOSE LEGO Magazine



BIC26 BIC26 BI06U BI06U BI06F BI06C BI06C BI06C BI06N
 Sign up now! Jetzt anmelden!
 Abonne-toi maintenant ! Meld je nu aan!
<http://club.LEGO.com/signup>



www.LEGOshop.com/catalog

