



LEGOS OF
CHIMA

70115



WARNING: CHOKING HAZARD.
Toy contains small parts and a small ball.
Not for children under 3 years.





AVERTISSEMENT : RISQUE D'ÉTOUFFEMENT.
Le jouet contient des petites pièces ainsi qu'une petite boule.
Il ne convient pas aux enfants de moins de 3 ans.



ADVERTENCIA: PELIGRO DE ASFIXIA.
Juguete que contiene partes pequeñas y una pelota pequeña.
No recomendado para niños menores de 3 años.

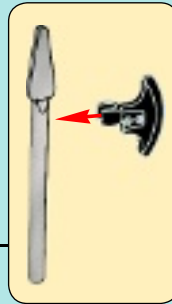
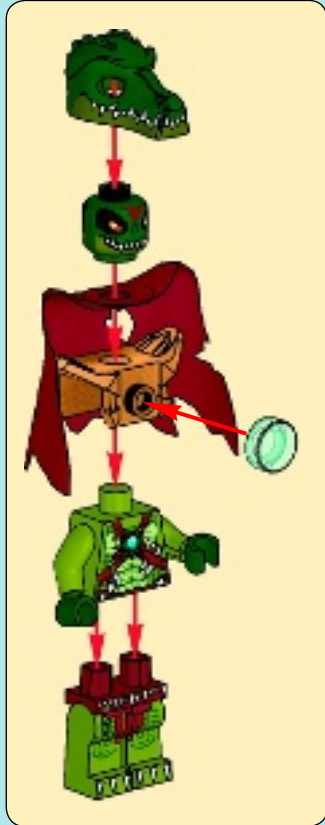

1



2



2x

1



2



1



2





1

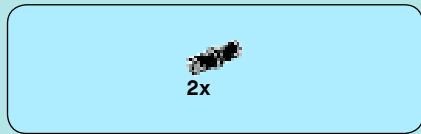
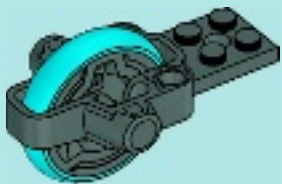

2



3



1x

4





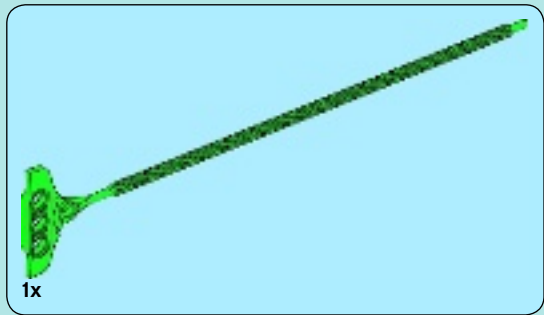

5

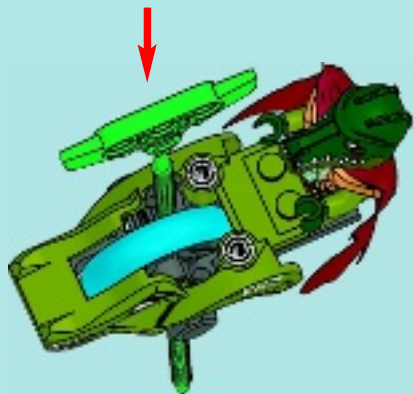





1x



1x

1

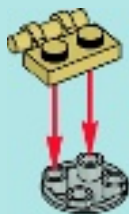

1x

2





2x

3



4





1x



1x

1



2x

2





2x

3

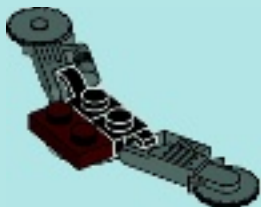

4





1

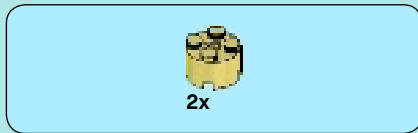
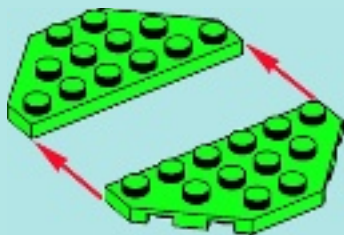

2

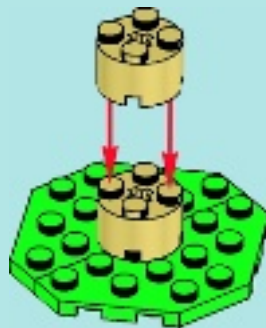

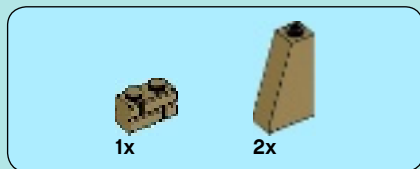

3



4





1x



2x

5



1x



2x

6





1x



2x

7



4x



1x

8

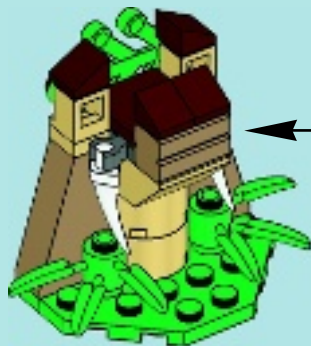

1



2





9

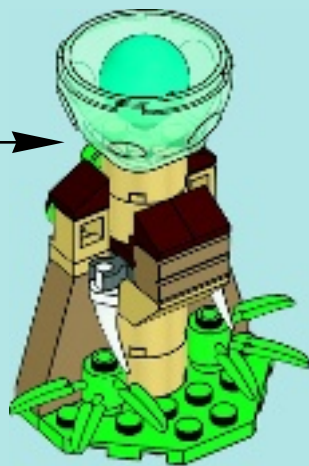
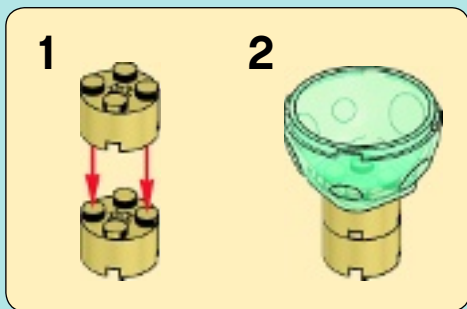



1

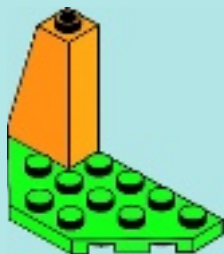

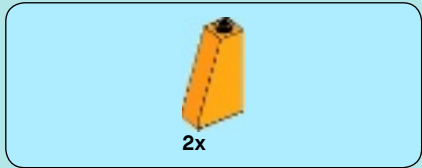

2

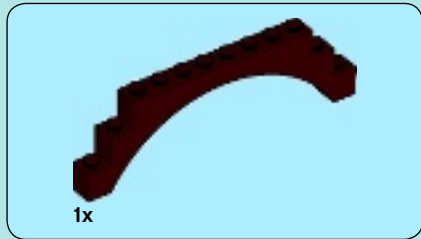

3

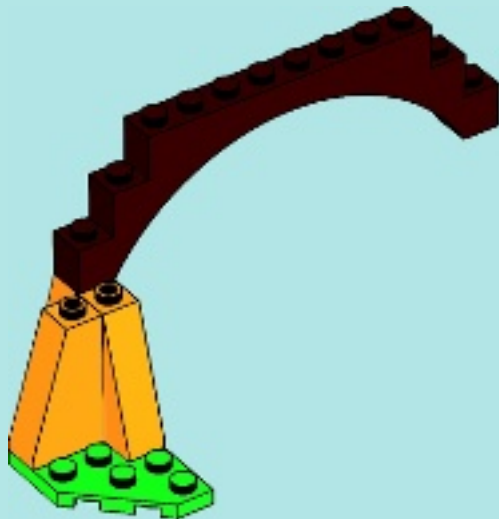

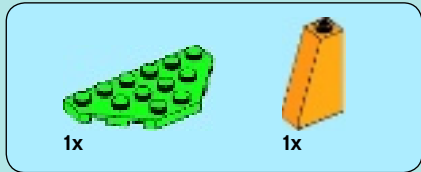

1

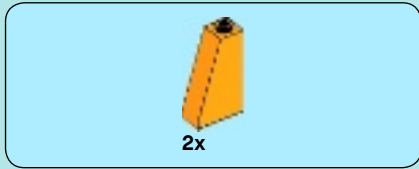

2

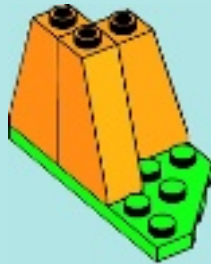

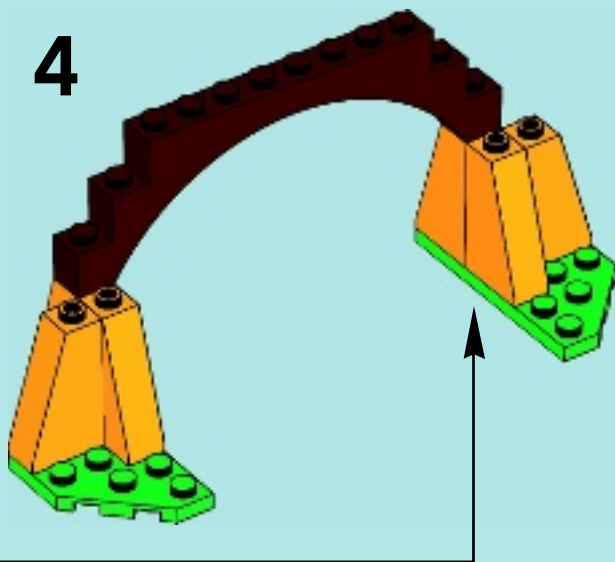



2x

5

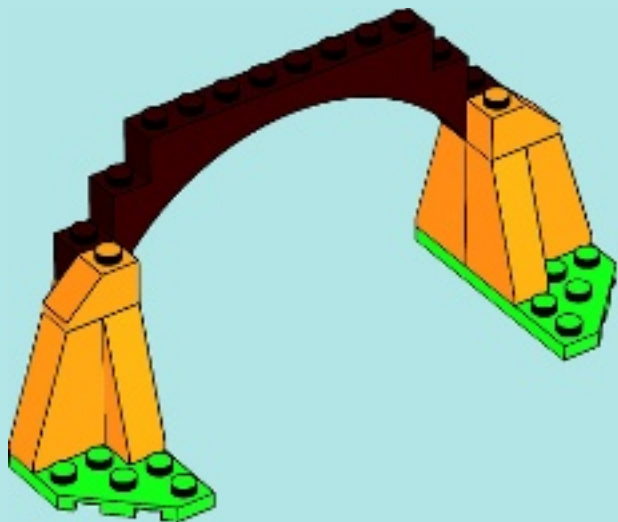

2x

6

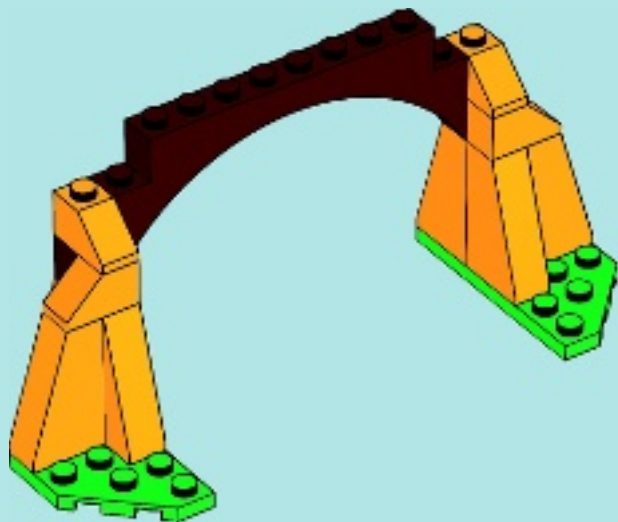



2x



4x

7

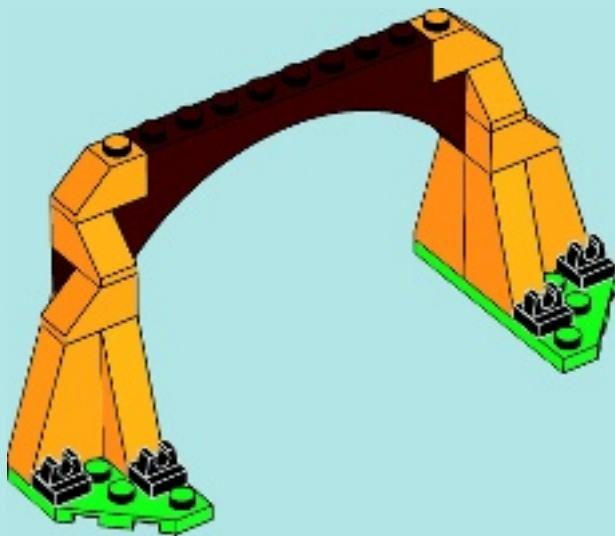



4x

8

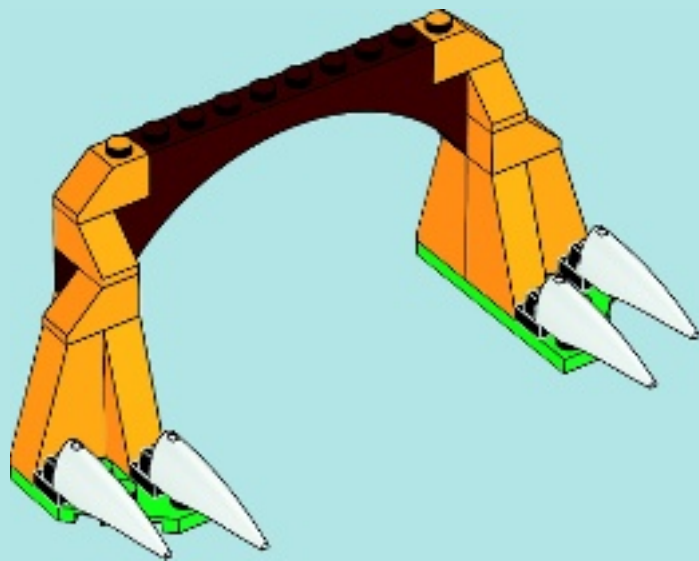

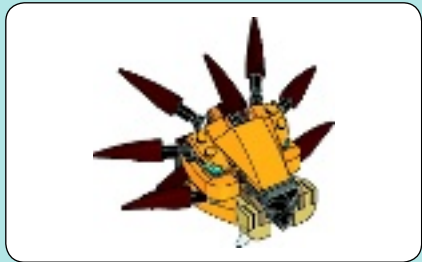

1

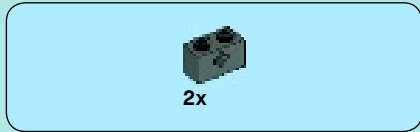

2

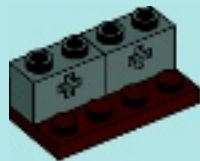

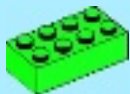

1x

3

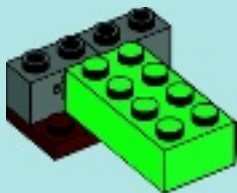

2x

4

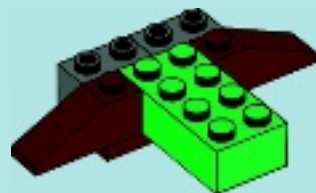



2x

5

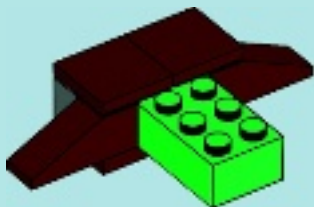

2x

6

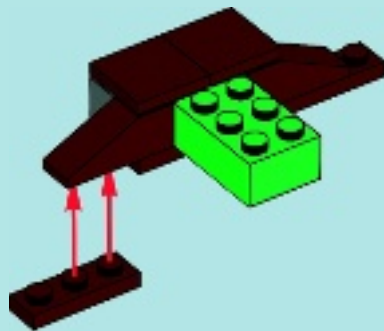



4x

7

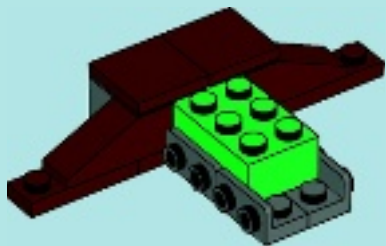

2x



2x

8

1



2

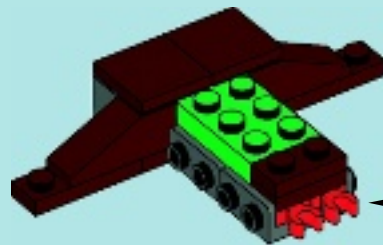
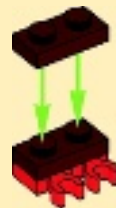



2x

9

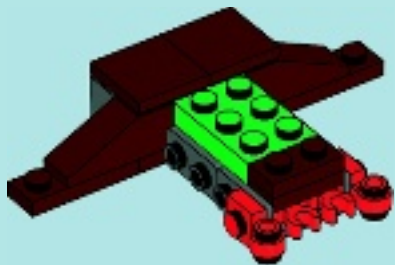

4x

10

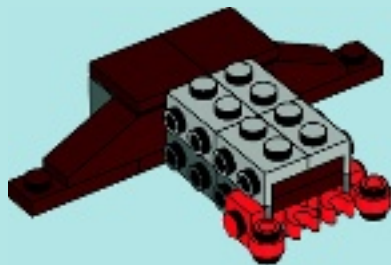



1x



1x

11

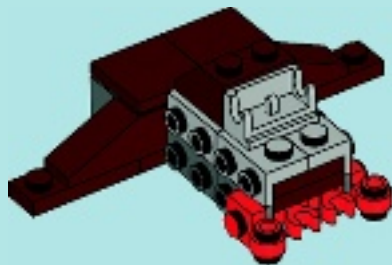

2x

12

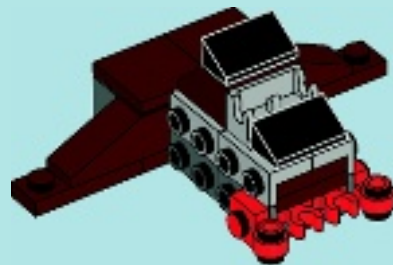



1x

13

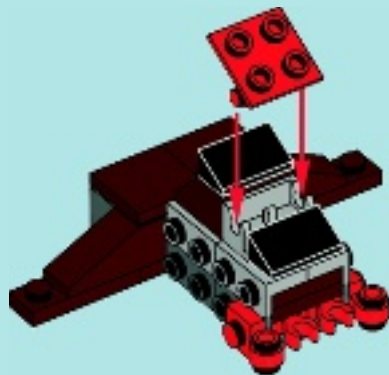



1x

1



1x

2



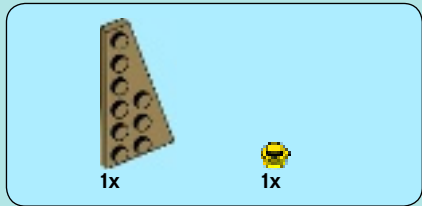

3

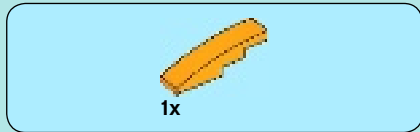

4

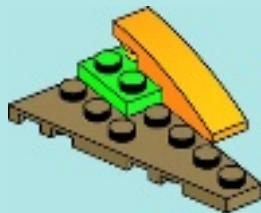



5

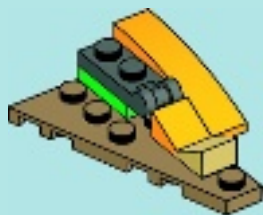

14

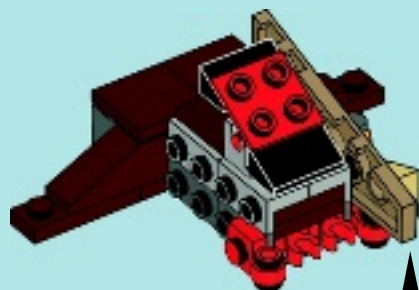



1x

1



1x

2



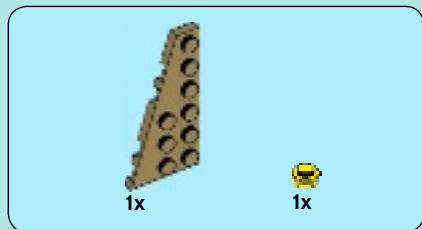

3

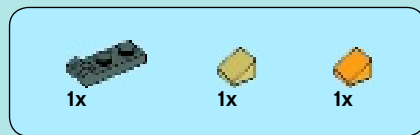

4



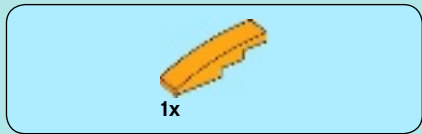

5

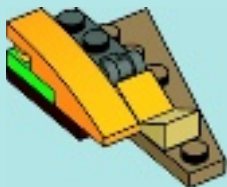

15

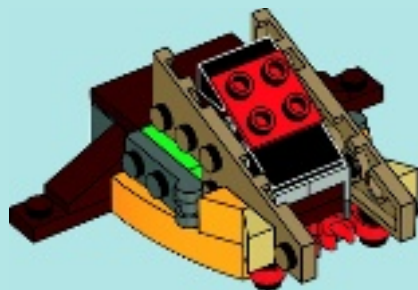

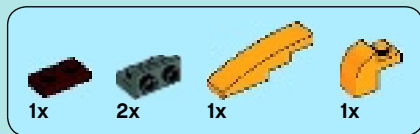

16

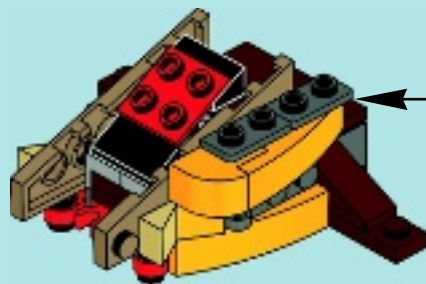
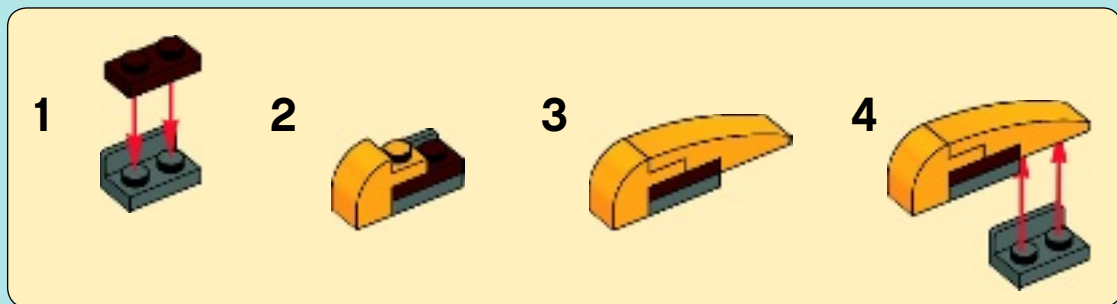

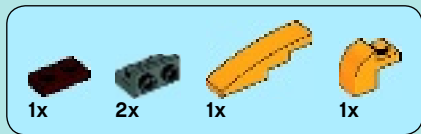

17

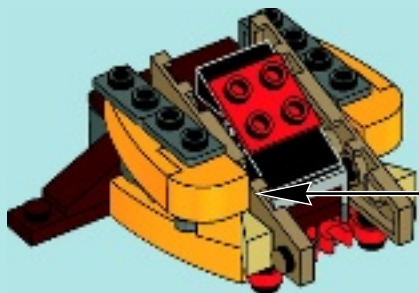
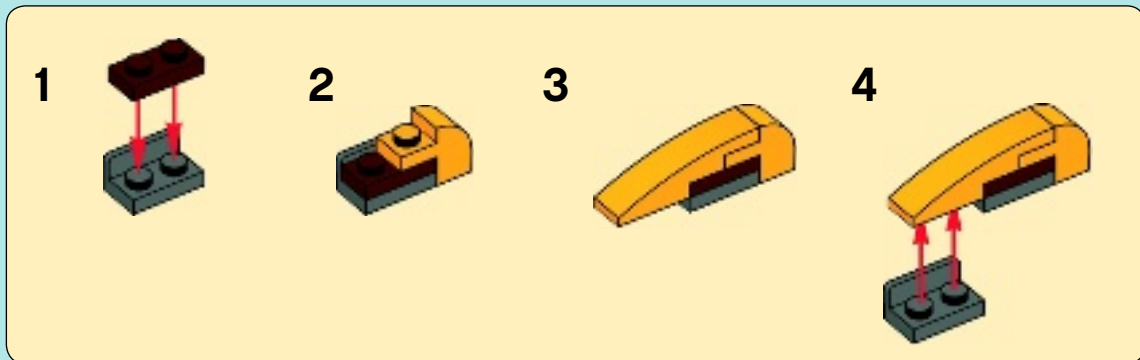



2x

18

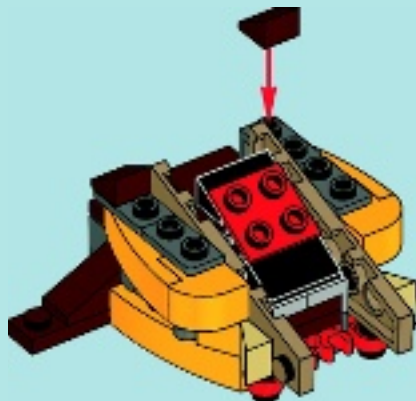

2x

19

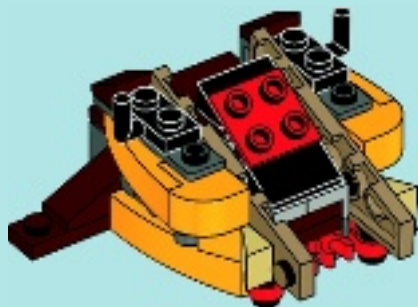



2x

20

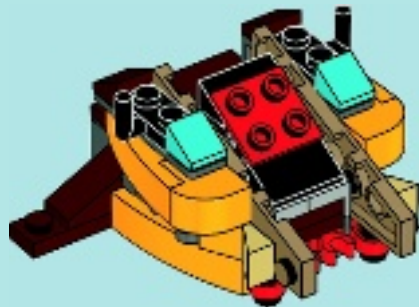

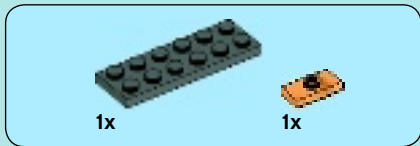

1

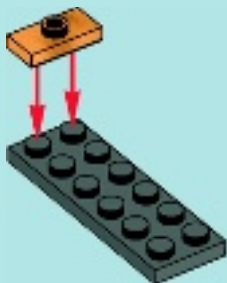

2





1x



1x



1x

3



1x



2x

4



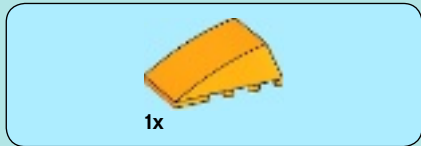

5

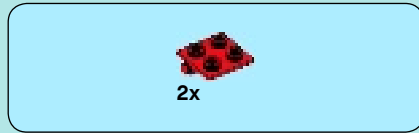
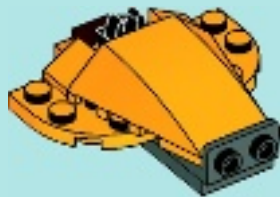

6

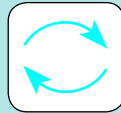



2x

7

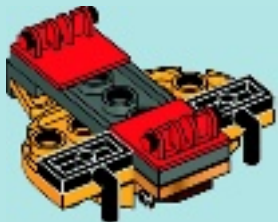

1x

8

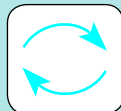

21

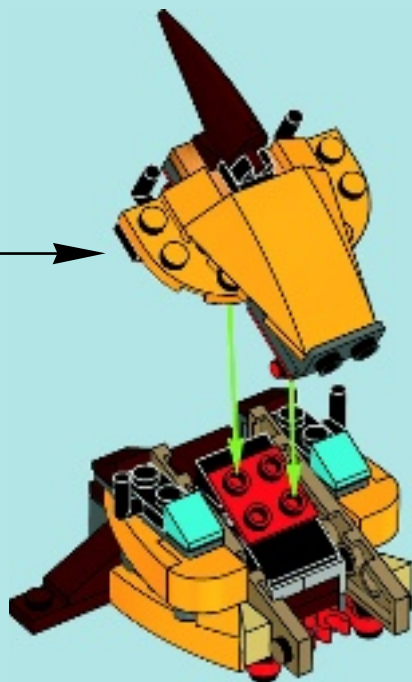



2x



2x

22

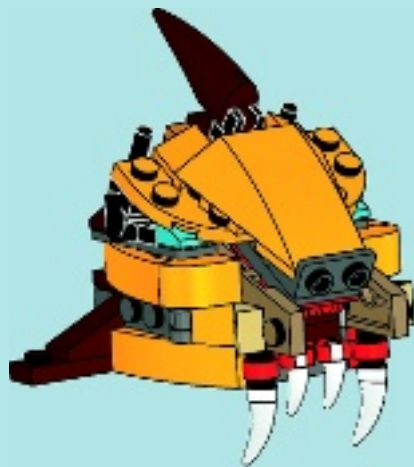



1x



2x



1x

23



1

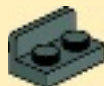

2

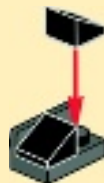

3

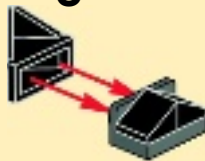

4





2x



2x

24

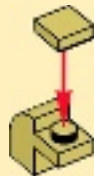
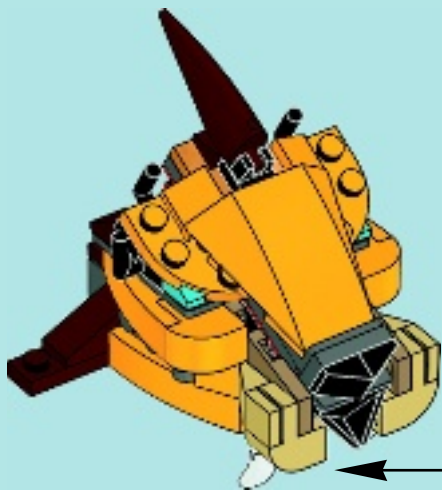

2x



25

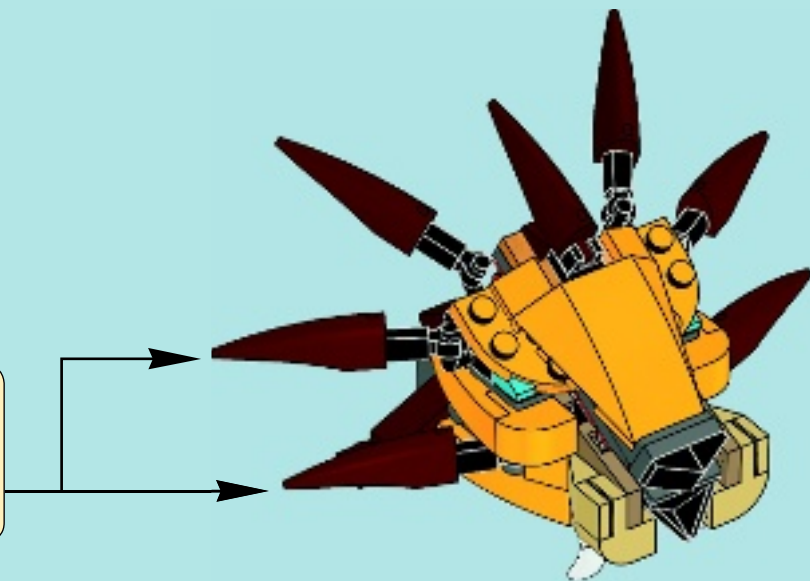
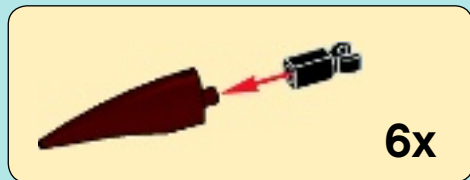

26

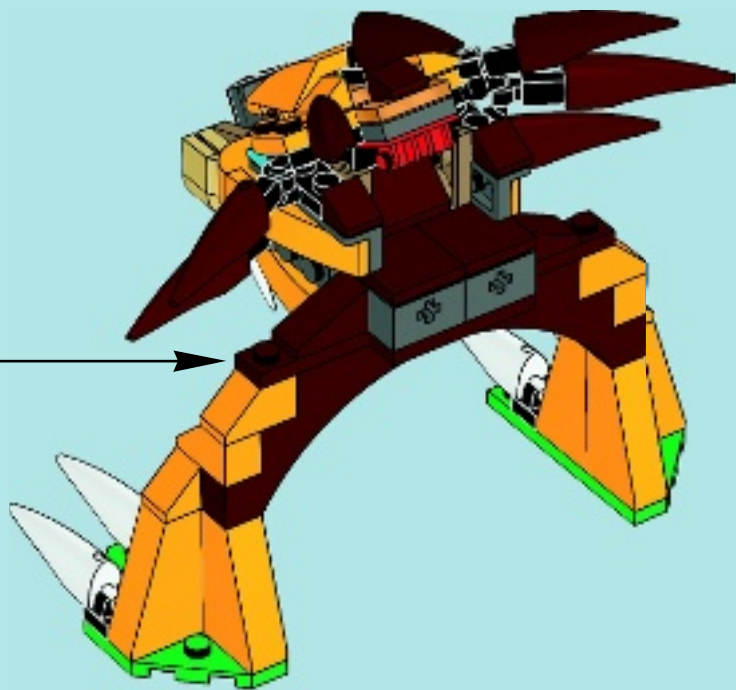



1

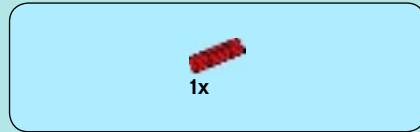
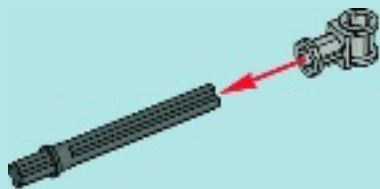

2

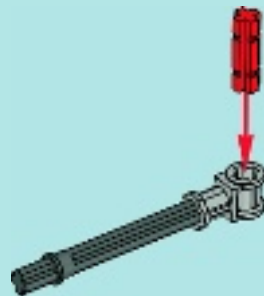



1x

3

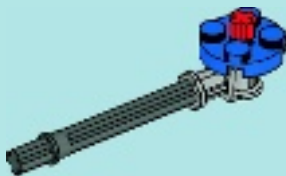

1x



1x

4

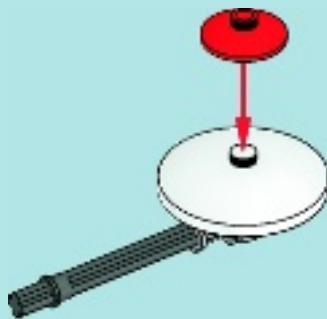

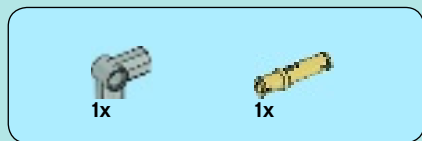

5

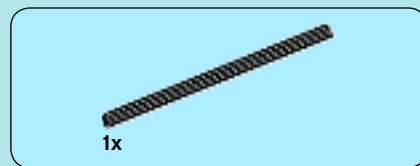
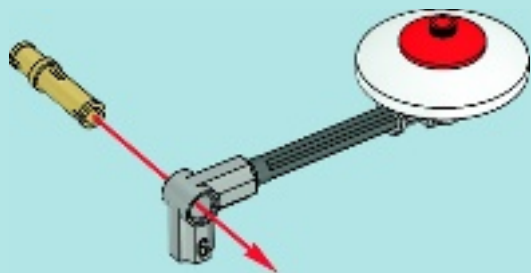

6

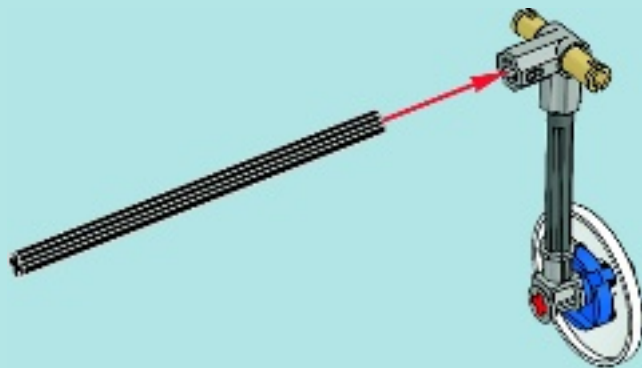
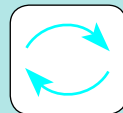

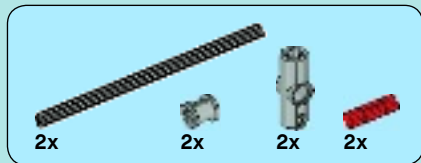
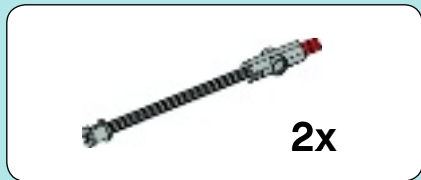

7

1

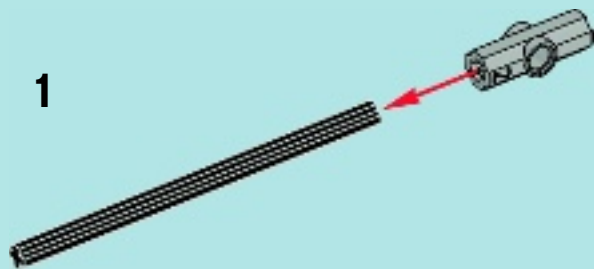

2

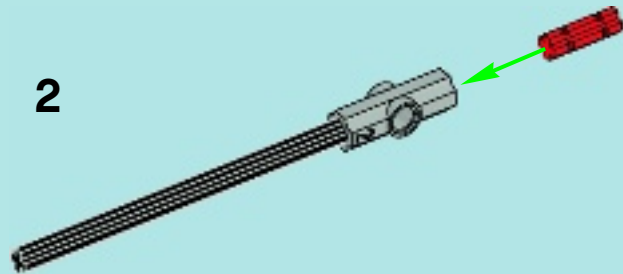

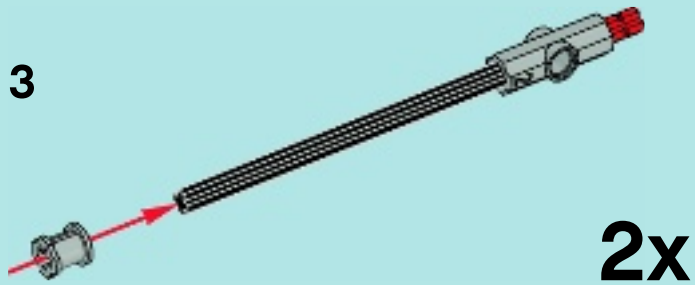

8

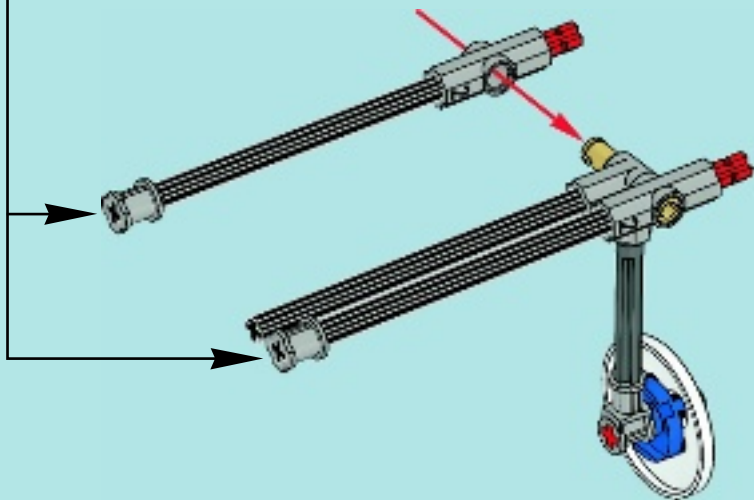

27

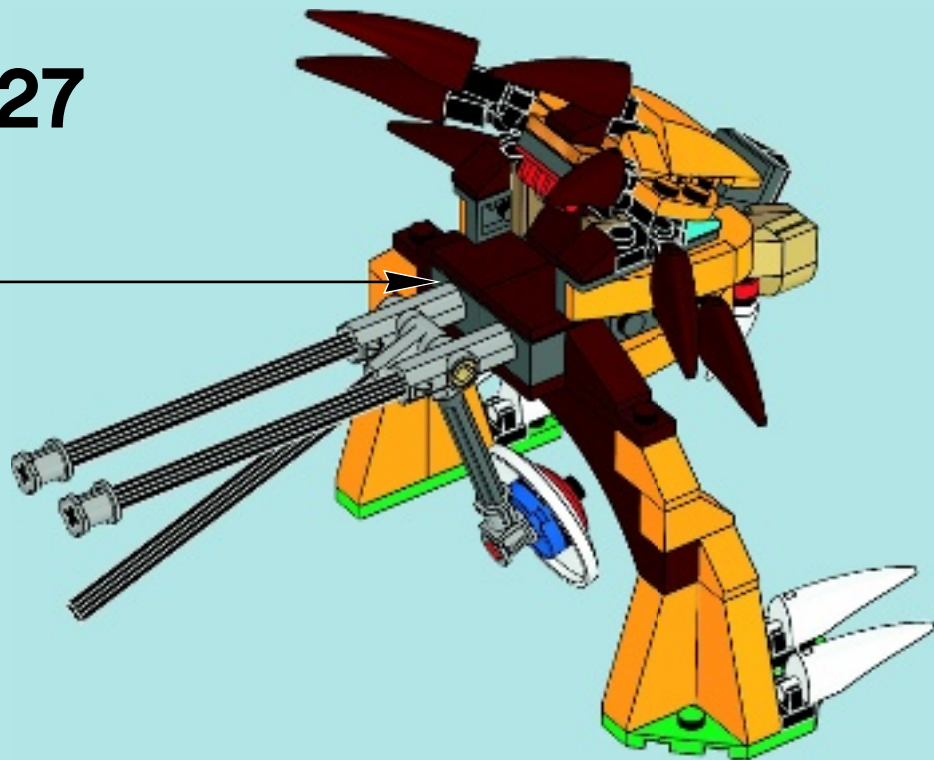



1x

28

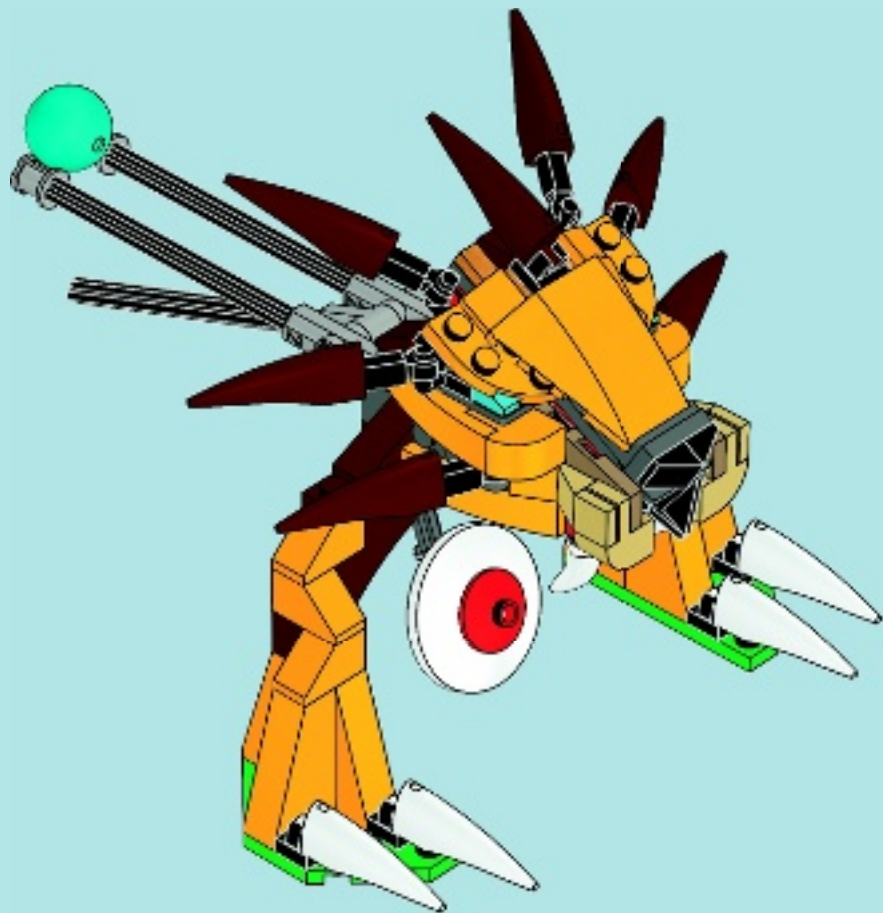

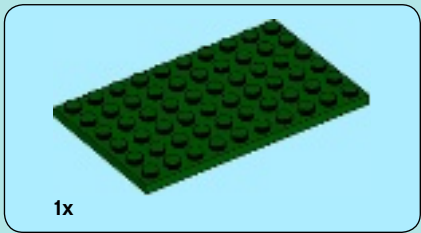

1

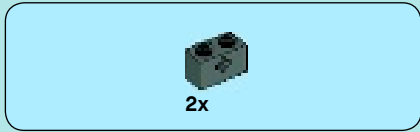
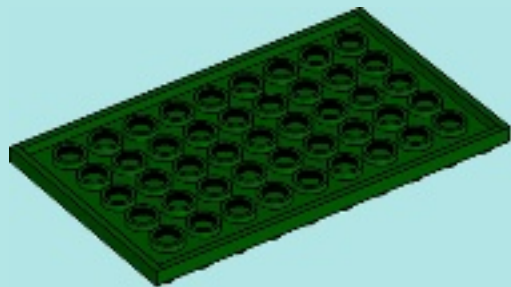

2

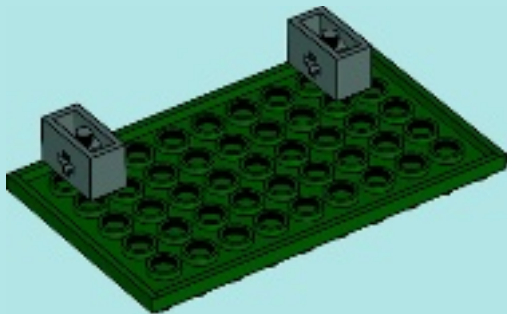

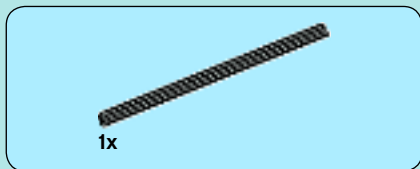

3

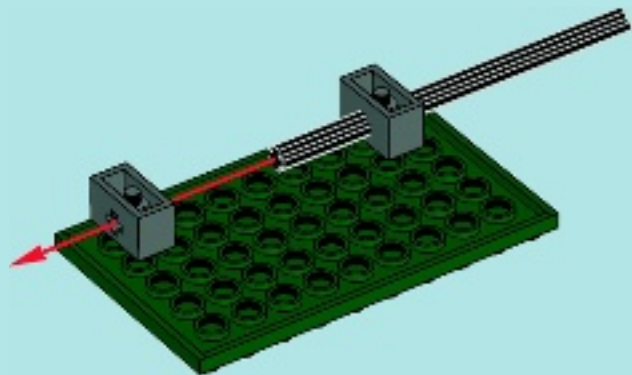

4

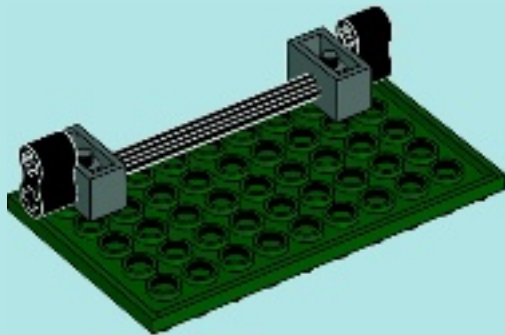



1x

5

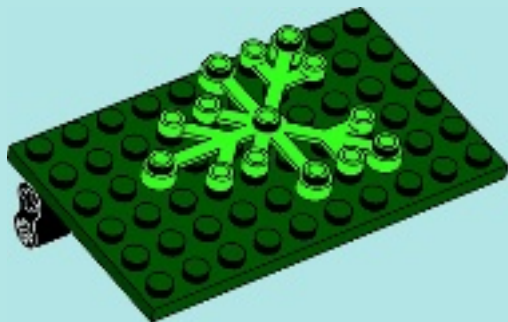
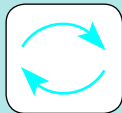



1x
4625528



1x
396001



2x
4568387



4x
4566256



4x
6015883



2x
4118793



4x
4125220



2x
4516055



1x
4118866



2x
4273526



1x
4113233



2x
4125253



2x
4140593



1x
6021694



1x
6021599



1x
4514554



2x
4588003



2x
4632572



1x
4585146



3x
613421



3x
4142865



1x
403223



1x
6022545



2x
614124



2x
4504382



2x
4548180



2x
4517925



1x
4220539



5x
6030718



4x
4569733



3x
4273400



6x
6015891



4x
4121715



2x
4198367



4x
373726



1x
4124108



1x
4106356



3x
302228

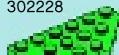

4x
241928



1x
242328



2x
4114348



1x
4129872



2x
4523157



1x
6019984



1x
4611880



1x
4611883



1x
4116927



1x
6024040



1x
6021583



2x
6022171



2x
4619520



1x
4124073



12x
6019570



2x
6024162



2x
4646577



2x
4653509



1x
6002851



1x
6002849



1x
6022566



1x
6023935



1x
6024901

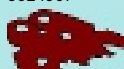

1x
6022368



1x
6027604



1x
6020778



1x
6023165



1x
6022517



1x
6022275



2x
4261397



1x
4549214



Customer Service
Kundenservice
Service Consommateurs
Servicio Al Consumidor
LEGO.com/service or dial



00800 5346 5555 :     

1-800-422-5346 :  



2x
6023185



4x
6023173



6x
6023157



6x
6023161



4x
6020093



1x
6020141



2x
6022078



1x
6024902



3x
4271949



7x
4504376



1x
4211202



2x
4211197



1x
4584719



5x
4211150



4x
4211152



1x
4211186



7x
6021493



1x
4509886



4x
4654582



2x
4278273



1x
4211469



2x
4211567



2x
4211622



1x
4211553



2x
4587212



4x
4210935



2x
6022161



1x
4211002



10x
6000606



2x
4521187



2x
4211080



2x
6021353



1x
4508553



LEGO CHIMA

EJULA



70004 70013
70101



LAVAL



70005 70115



CRAGGER



70006 70115



RAZAR



70003 70012
70100



ERIS



70003



LONGTOOTH



70005 70113



CRIMINUS



70006 70103



WAKZ



70004 70113



LEGO.com/chima



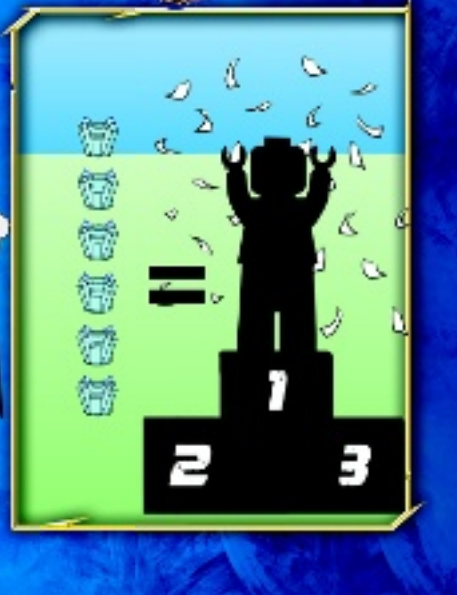



1. **Tribe** 2. **Battle Powers:** 🐾 Instinct 🐾 Speed 🐾 Courage 🐾 Strength
 3. **CHI Bonus:** When you flip a card, you may pay 1 CHI crystal to add the CHI bonus to any connected battle power.



1. **Stamm** 2. **Kräfte:** 🐾 Instinkt 🐾 Geschwindigkeit 🐾 Mut 🐾 Stärke
 3. **CHI-Bonus:** Wenn du eine Karte aufdeckst, kannst du einen CHI-Kristall zahlen, um den CHI-Bonus zu erhalten. Dieser Bonus gilt nur für eine mit dem CHI verbundene Kraft.



1. **Tribu** 2. **Pouvoirs:** 🐾 Instinct 🐾 Vitesse 🐾 Courage 🐾 Force
 3. **Bonus CHI :** Quand tu retournes une carte, tu peux ajouter des points Bonus à tout pouvoir relié au CHI, contre le don d'un cristal CHI.



1. **Tribù** 2. **Poteri :** 🐾 Istinto 🐾 Velocità 🐾 Coraggio 🐾 Forza
 3. **Bonus :** Quando scopri una carta, puoi pagare 1 cristallo CHI per aggiungere un CHI bonus al potere scelto per la battaglia.



1. **Stam** 2. **Krachten:** 🐾 Instinct 🐾 Snelheid 🐾 Moed 🐾 Spierkracht
 3. **CHI bonus:** Als je een kaart omdraait, mag je 1 CHI kristal betalen om de CHI bonus toe te voegen aan een daarmee verbonden kracht.



1. **Tribu** 2. **Poderes de combate:** 🐾 Instinto 🐾 Velocidad 🐾 Valentía 🐾 Fuerza
 3. **Bonificación de CHI:** Al dar la vuelta a una carta, puedes pagar 1 cristal de CHI para asignar la bonificación de CHI a cualquier poder de combate conectado.



1. **Stamme** 2. **Kampevner:** 🐾 Instinkt 🐾 Hastighed 🐾 Mod 🐾 Styrke
 3. **CHI-bonus:** Når du vender et kort, kan du betale én CHI-kristal for at føje CHI-bonusen til en forbundet kampevne.



1. **Heimo** 2. **Taisteluvoimat:** 🐾 Vaisto 🐾 Nopeus 🐾 Rohkeus 🐾 Voima
 3. **CHI-bonus:** Kun käännät kortin, sinun on maksettava 1 CHI-kristalli lisätäksesi CHI-bonusen johonkin kytketyistä taisteluvoimista.



1. **Stam** 2. **Stridskrafter:** 🐾 Instinkt 🐾 Snabbhet 🐾 Mod 🐾 Styrka
 3. **CHI-bonus:** När du vänder på ett kort kan du betala 1 CHI-kristall för att addera CHI-bonusen till en av de anslutna stridskrafterna.



1. **Tribo** 2. **Poderes de combate:** 🐾 Instinto 🐾 Velocidade 🐾 Coragem 🐾 Força
 3. **Bônus CHI:** Quando viras uma carta, podes pagar 1 cristal CHI para acrescentares o bônus CHI a qualquer poder de combate associado.



1. **Φυλή** 2. **Πολεμικές ικανότητες:** 🐾 Ενστικτο 🐾 Ταχύτητα 🐾 Θάρρος 🐾 Δύναμη
 3. **Εξτρα Βαθμίοι CHI:** Όταν γυρίσεις μια κάρτα, μπορείς να δώσεις 1 κρύσταλλο CHI για να προσθέσεις τους εξτρα βαθμίους CHI σε οποιαδήποτε πολεμική ικανότητα συνδέεται με αυτούς.



1. **種族** 2. **バトルパワー:** 🐾 本能 🐾 スピード 🐾 勇気 🐾 強さ
 3. **CHI(チー)のボーナス:** カードを裏返す時、CHI(チー)のクリスタルを1個使えば、バトルパワーのどれかにCHI(チー)のボーナスを加えることができる。



1. **部落** 2. **战斗能量:** 🐾 本能 🐾 速度 🐾 勇气 🐾 力量
 3. **奖励真气:** 翻开卡片时, 你可以消费一个真气水晶, 将相应真气添加到任何相连的战斗能量中。



1. **종족** 2. **배틀 파워:** 🐾 직감 🐾 스피드 🐾 용기 🐾 힘
 3. **키보너스:** 카드 한장을 뒤집고 키 크리스탈 1개를 지불하면 관련된 배틀 파워에 키보너스를 추가할 수 있습니다.



1. **Klan** 2. **Боевые способности:** 🐾 Интуиция 🐾 Скорость 🐾 Храбрость 🐾 Сила
 3. **Чи-бонус:** Когда ты переворачиваешь карточку, ты можешь использовать 1 Чи-кристалл и получить возможность добавить Чи-бонус к любой соответствующей боевой способности.



1. **Plemię** 2. **Moce bitewne:** 🐾 Instykt 🐾 Szybkość 🐾 Odwaga 🐾 Siła
3. **Bonus CHI:** Gdy odkryjesz kartę, możesz zapłacić 1 kryształ CHI, aby dodać bonus CHI do dowolnej połączonej błyskawicy mocy bitewnej.



1. **Kmen** 2. **Bojové schopnosti:** 🐾 Instykt 🐾 Rychlost 🐾 Odvaha 🐾 Siła
3. **CHI bonus:** Když otočíš kartu, můžeš zaplatit 1 CHI krystal, a tím navýšit jednu z bojových schopností označených bleskem o CHI bonus.



1. **Kmeň** 2. **Bojové schopnosti:** 🐾 Inštinkt 🐾 Rýchlosť 🐾 Odvaha 🐾 Siła
3. **CHI bonus:** Keď otočíš kartu, môžeš zaplatiť 1 CHI kryštál, a tým pridať CHI bonus na všetky bojové sily zvýraznené s bleskom.



1. **Törzs** 2. **Harckészségek:** 🐾 Megérzés 🐾 Gyorsaság 🐾 Bátorság 🐾 Erő
3. **CHI bonus:** Ha felütsz egy kártyát, bármelyik csatolt harckészséghez vásárolhatsz 1 CHI kristályal CHI bónusz.



1. **Клан** 2. **Бойові сили:** 🐾 Інстинкт 🐾 Швидкість 🐾 Хоробрість 🐾 Міць
3. **CHI-бонус:** Коли ти перевертаєш картку, тобі може випасти 1 CHI кристал ти можеш віддати 1 CHI кристал ти матимеш змогу додати CHI-бонус до будь-якої відповідної бойової сили.



1. **Pleme** 2. **Borbene moći:** 🐾 Instinkt 🐾 Brzina 🐾 Hrabrost 🐾 Snaga
3. **CHI nagrada:** Kada okreneš kartu, možeš platiti 1 CHI kristal kako bi dodao CHI nagradu bilo kojoj borbenoj moći.



1. **Племе** 2. **Борбене моћи:** 🐾 Инстинкт 🐾 Брзина 🐾 Храброст 🐾 Снага
3. **Чи бонус:** Када обрнеш картицу, мораш платити 1 чи кристал да би додао чи бонус својој борбеној моћи.



1. **Pleme** 2. **Војне моћи:** 🐾 Nagon 🐾 Hitrost 🐾 Pogum 🐾 Moč
3. **CHI Bonus:** Ko obrneš karto, lahko plačaš 1 CHI kristal, da bi kateri koli povezani bojni moči dodal CHI bonus.



1. **Trib** 2. **Puteri de luptă:** 🐾 Instinct 🐾 Viteză 🐾 Curaj 🐾 Putere
3. **Bonus CHI:** Când întorci o carte, poți plăti 1 cristal CHI pentru a adăuga bonusul CHI la oricare putere de luptă asociată.



1. **Племе** 2. **Бойни сили:** 🐾 Инстинкт 🐾 Скорост 🐾 Кураж 🐾 Сила
3. **CHI бонус:** Кога то обврнете карта, можете да платите 1 кристал CHI, за да добавите бонуса CHI към която и да е свързана бойна сила.



1. **Cilts** 2. **Cīņas spēki:** 🐾 Instinkts 🐾 Ātrums 🐾 Drosmē 🐾 Izturība
3. **Či bonus.** Paceļot karti, vari samaksāt vienu 1 Či kristālu, lai pievienotu Či bonusu jebkuram saistītajam cīņas spēkam.



1. **Hõim** 2. **Lahinguvõimed:** 🐾 Instinkt 🐾 Kiirus 🐾 Vaprus 🐾 Tugevus
3. **CHI boonused:** Kaarti ümber pöörates võid mis tahes lahinguvõimele CHI boonuse lisamiseks maksta ühe CHI kristalli.



1. **Genitis** 2. **Kovos galios:** 🐾 Instinktas 🐾 Greitis 🐾 Drasa 🐾 Jėga
3. **Či premija:** Apvertęs kortelę gali sumokėti 1 Či kristalą, kad pridėtum Či premiją prie bet kurios kovos galios.



1. **Kabile** 2. **Savaş güçleri:** 🐾 İlgüdü 🐾 Hız 🐾 Cesaret 🐾 Güç
3. **CHI bonusu:** Bir kart çevirdiğinizde, bağlı herhangi bir savaş gücüne CHI bonusu eklemek için 1 CHI kristali ödeyebilirsiniz.



HOW TO PLAY

1. Compete with your Speedorz.
2. The winner flips a card and chooses a battle power.
3. The other player flips a card. Compare the chosen power on both cards.
4. The player with the highest power wins 2 CHI crystals.
5. The first player to get 6 CHI crystals wins the battle.

CHI power: When you flip a card, you may pay 1 CHI crystal to add the CHI bonus to any connected battle power.



SPIELANLEITUNG

1. Tretet mit euren Speedorz im Wettkampf gegeneinander an.
2. Der Gewinner deckt eine Karte auf und wählt eine Kraft aus.
3. Der andere Spieler deckt eine Karte auf. Vergleicht die gewählten Kräfte der beiden Karten.
4. Der Spieler mit der höheren Kraft gewinnt 2 CHI-Kristalle.
5. Gewonnen hat der Spieler, der als Erster 6 Kristalle gesammelt hat.

CHI-Bonus: Wenn du eine Karte aufdeckst, kannst du einen CHI-Kristall zahlen, um den CHI-Bonus zu erhalten. Dieser Bonus gilt nur für eine mit dem CHI verbundene Kraft.



COMMENT JOUER

1. Relève le défi Speedorz.
2. Le gagnant retourne une carte et choisit un pouvoir pour combattre.
3. L'autre joueur retourne une carte. Tu peux maintenant comparer le pouvoir choisi sur les deux cartes.
4. Le joueur avec le pouvoir le plus élevé gagne deux cristaux CHI.
5. Le premier joueur à obtenir 6 cristaux CHI gagne le combat.

Bonus CHI : Quand tu retournes une carte, tu peux ajouter des points Bonus à tout pouvoir relié au CHI, contre le don d'un cristal CHI.



REGOLE DEL GIOCO

1. Sfidatevi con gli Speedorz.
2. Il vincitore scopre una carta e sceglie un potere.
3. L'altro giocatore scopre una carta. Confrontate il potere scelto su entrambe le carte.
4. Il giocatore con il potere più alto vince 2 cristalli CHI.
5. Il primo giocatore che conquista 6 cristalli CHI vince la battaglia.

Bonus CHI: Quando scopri una carta, puoi pagare 1 cristallo CHI per aggiungere un CHI bonus al potere scelto per la battaglia.



ZO SPEEL JE HET SPEL

1. Hou een wedstrijd met je Speedorz.
2. De winnaar draait een kaart om en kiest een kracht.
3. Dan draait de andere speler een kaart om.
4. Vergelijk de gekozen kracht van de 2 kaarten.
4. De speler met de hoogste kracht wint 2 CHI kristallen.
5. De speler die als eerste 6 CHI kristallen verzamelt, wint het gevecht.

CHI bonus: Als je een kaart omdraait, mag je 1 CHI kristal betalen om de CHI bonus toe te voegen aan een daarmee verbonden kracht.



CÓMO SE JUEGA

1. Compíte con tu Speedorz. 2. El ganador da la vuelta a una carta y elige un poder de combate. 3. El otro jugador da la vuelta a una carta. Ambas cartas se comparan en relación con el poder elegido. 4. El jugador que posea más poder gana 2 cristales de CHI. 5. El primer jugador en conseguir 6 cristales de CHI gana el combate.

Bonificación de CHI: Al dar la vuelta a una carta, puedes pagar 1 cristal de CHI para asignar la bonificación de CHI a cualquier poder de combate conectado.



SÅDAN SPILLER DU

1. Konkurrer med jeres Speedorz. 2. Vinderen vender et kort og vælger en kampevne. 3. Den anden spiller vender et kort. Sammenlign den valgte evne på de to kort. 4. Spilleren med det højeste tal vinder to CHI-krystaller. 5. Den første spiller, der får seks CHI-krystaller, vinder kampen.

CHI-bonus: Når du vender et kort, kan du betale én CHI-krystal for at føje CHI-bonussen til en forbundet kampevne.



PELIOHJEET

1. Kilpaille Speedorzisi kanssa. 2. Voittaja kääntää kortin ja valitsee taisteluvoiman. 3. Muut pelaajat kääntävät kortin. Vertaa molempien korttien valittua voimaa. 4. Pelaaja, jonka voima on suurempi, voittaa 2 CHI-kristallia. 5. Taistelun voittaa ensimmäisenä 6 CHI-kristallia kerännyt pelaaja.

CHI-bonus: Kun käännät kortin, sinun on maksettava 1 CHI-kristalli lisätäksesi CHI-bonusen johonkin kytketyistä taisteluvuimista.



SÅ HÄR GÅR DET TILL

1. Tävla med era Speedorz. 2. Vinnaren vänder på ett kort och väljer en stridskraft. 3. Den andra spelaren vänder på ett kort. Jämför den valda stridskraften på båda korten. 4. Spelaren med högst kraft vinner 2 CHI-kristaller. 5. Den första spelare som får 6 CHI-kristaller vinner striden.

CHI-bonus: När du vänder på ett kort kan du betala 1 CHI-kristall för att addera CHI-bonusen till en av de anslutna stridskrafterna.



COMO JOGAR

1. Compete com o teu Speedorz. 2. O vencedor vira uma carta e escolhe um poder de combate. 3. O outro jogador vira uma carta. Compara o poder escolhido em ambas as cartas. 4. O jogador com o poder mais elevado ganha 2 cristais CHI. 5. O primeiro jogador a obter 6 cristais CHI ganha o combate.

Bónus CHI: Quando viras uma carta, podes pagar 1 cristal CHI para acrescentares o bónus CHI a qualquer poder de combate associado.



ΠΩΣ ΠΑΙΖΕΤΑΙ

1. Ξεκινήστε την αναμέτρηση με τα Speedorz σας. 2. Ο νικητής γυρίζει μια κάρτα και διαλέγει πολεμική ικανότητα. 3. Ο άλλος παίκτης γυρίζει μια κάρτα. Συγκρίνετε την ικανότητα που διαλέξατε στις δύο κάρτες. 4. Ο παίκτης με τη μεγαλύτερη ικανότητα κερδίζει 2 κρυστάλλους CHI. 5. Ο πρώτος παίκτης που συγκεντρώνει 6 κρυστάλλους CHI κερδίζει τη μάχη.

Έξτρα Βαθμοί CHI: Όταν γυρίζεις μια κάρτα, μπορείς να δώσεις 1 κρύσταλλο CHI για να προσθέσεις τους έξτρα βαθμούς CHI σε οποιαδήποτε πολεμική ικανότητα συνδέεται με αυτούς.



やり方

1. スピードーズバトルをする。2. 勝者はカードを裏返してバトルパワーを選ぶ。3. 相手もカードを裏返す。先に選んだバトルパワーを見比べる。4. パワーの高いプレイヤーがCHI(チー)のクリスタルを2個獲得する。5. CHI(チー)のクリスタルを先に6個手に入れた方がバトルの勝者となる。

のボーナス:カードを裏返す時、CHI(チー)のクリスタルを1個使えば、バトルパワーのどれかにCHI(チー)のボーナスを加算することができる。



玩法

1. 迎接挑战。2. 赢家翻开一张卡片,选择战斗能量。3. 另一名玩家也翻开一张卡片。比较两张卡片上的能量。4. 卡片能量高的玩家可以赢得两个真气水晶。5. 首先积累到6个真气水晶的玩家赢得战斗。

奖励真气:翻开卡片时,你可以消费一个真气水晶,将相应真气添加到任何相连的战斗能量中。



플레이 방법

1. 스피드즈 배틀을 시작해보세요. 2. 이긴 쪽이 카드 한 장을 뒤집어 배틀 파워를 선택합니다. 3. 상대방이 카드 한 장을 뒤집습니다. 양쪽 카드의 선택한 파워를 비교합니다. 4. 파워가 높은 쪽이 키 크리스탈 2개를 획득합니다. 5. 키 크리스탈 6개를 먼저 따낸 쪽이 배틀에 이깁니다.

키 보너스: 카드 한 장을 뒤집고, 키 크리스탈 1개를 지불하면 관련된 배틀 파워에 키 보너스를 추가할 수 있습니다.



ПРАВИЛА ИГРЫ

1. Сразитесь в прохождении препятствий на Чимашиклах. 2. Победитель переворачивает карточку и называет любую боевую способность. 3. Другой игрок должен перевернуть свою карточку. Сравните выбранные победителем способности на ваших карточках. 4. Игрок с самой сильной способностью получает Чи-кристалл. 5. Побеждает игрок, который первым получит 6 Чи-кристаллов.

Чи-бонус: когда ты переворачиваешь карточку, ты можешь использовать 1 Чи-кристалл и получить возможность прибавить баллы к той боевой способности, которая соединена молнией с Чи-бонусом на твоей карточке.



ZASADY GRY

1. Walcz swoimi pojazdami Speedorz. 2. Zwycięzca odkrywa kartę i wybiera moc bitewną. 3. Drugi gracz odkrywa kartę. Porównaj wybraną moc na obu kartach. 4. Gracz z najwyższą mocą zdobywa 2 kryształy CHI. 5. Bitwę wygrywa gracz, który jako pierwszy zdobędzie 6 kryształów CHI.

Bonus CHI: Gdy odkryjesz kartę, możesz zapłacić 1 kryształ CHI, aby dodać bonus CHI do dowolnej połączonej błyskawicą mocy bitewnej.



PRAVIDLA HRY

1. Pusť sa do boje se svým Speedorzem. 2. Víťaz otočí kartu a zvolí si bojovú schopnosť. 3. Druhý hráč otočí kartu. Hráči si porovnajú vybranú bojovú schopnosť na svých kartách. 4. Hráč s vyššou bojovou schopnosťou vyhráva 2 CHI kryštály. 5. Hru vyhráva hráč, ktorý ako prví nasbíra 6 CHI kryštály.

CHI bonus: Když otočíš kartu, můžeš zaplatit 1 CHI krystal, a tím navýšit jednu z bojových schopností označených bleskem o CHI bonus.



PRAVIDLÁ HRY

1. Pusť sa do boja so svojím Speedorz. 2. Víťaz otočí kartu a zvolí si bojovú schopnosť. 3. Druhý hráč otočí kartu. Porovnaj te zvolenú bojovú schopnosť na oboch kartách. 4. Hráč s vyššou bojovou schopnosťou vyhráva 2 CHI kryštály. 5. Hru vyhráva hráč, ktorý ako prvý nazbiera 6 CHI kryštálov.

CHI bonus: Keď otočíš kartu, môžeš zaplatiť 1 CHI kryštál, a tým pridať CHI bonus na všetky bojové sily zvýraznené s bleskom.



JÁTÉKSZABÁLY

1. Versenyezz a Speedorzoddal. 2. A nyertes felüt egy kártyát és harckésztséget választ. 3. A másik játékos felüt egy kártyát. Hasonlíts össze mindkét kártyán a kiválasztott harckésztség erejét. 4. A legerősebb lap 2 CHI kristályt nyer. 5. Akinek először lesz 6 CHI kristálya, az nyer.

CHI bónusz: Ha felütsz egy kártyát, bármelyik csatolt harckésztséghez vásárolhatsz 1 CHI kristályal CHI bónuszt.



ПРАВИЛА ГРИ

1. Розіграйте завдання. 2. Переможець перевертає картку та обирає бойову силу. 3. Інший гравець перевертає картку. Порівняйте обрані сили на обох картках. 4. Гравець з максимальною силою отримує 2 Чи-кристали. 5. Перемагає гравець, який першим отримує 6 Чи-кристалів.

Чи-бонус: Коли ти перевертаєш картку, тобі може випасти 1 Чи-кристал ти можеш віддати 1 Чи-кристал і ти матимеш змогу додати Чи-бонус до будь-якої відповідної бойової сили.



KAKO SE IGRA

1. Odigraj izazov. 2. Pobjednik okreće kartu i odabire borbenu moć. 3. Drugi igrač okreće kartu. Usporedite odabrane moći na obje karte. 4. Igrač s najvećom moći osvaja 2 CHI kristala. 5. Prvi igrač koji osvoji 6 CHI kristala pobjeđuje u bitci.

CHI nagrada: Kada okreneš kartu, možeš platiti 1 CHI kristal kako bi dodao CHI nagradu bilo kojoj borbenoj moći.



КАКО ИГРАТИ

1. Одиграјте такмичење. 2. Победник обрће картицу и бира борбену моћ. 3. Други играч обрће картицу. Упоредите изабрану моћ на обе картице. 4. Играч са највећом моћи осваја 2 чи кристала. 5. Први играч који сакупи 6 чи кристала је победник.

Чи бонус: Када обрнеш картицу, мораш платити 1 чи кристал да би додао чи бонус својој борбеној моћи.



КАКО ИГРАТИ

1. Такмј с својим Speedorzom. 2. Zmagovalec obrne karto in si izbere bojno moč. 3. Други играlec обрне karto. Primerajta izbrano bojno moč na kartah. 4. Igralec z večjo močjo dobi 2 CHI kristala. 5. Zmaga prvi igralec, ki dobi 6 CHI kristalov.

CHI bonus: Ко обрнеš karto, lahko plačaš 1 CHI kristal, da bi kateri koli povežani bojni moči dodal CHI bonus.



CUM SE JOACĂ

1. Intră în competiție cu Speedorz-ul tău. 2. Câștigătorul întoarce o carte și alege o putere de luptă. 3. Celălalt jucător întoarce o carte. Comparați puterea aleasă pe cele două cărți. 4. Jucătorul cu cea mai mare putere câștigă 2 cristale CHI. 5. Primul jucător care obține 6 cristale CHI câștigă lupta.

Bonus CHI: Când întorci o carte, poți plăti 1 cristal CHI pentru a adăuga bonusul CHI la oricare putere de luptă asociată.



КАК СЕ ИГРАЕ

1. Състезавайте се със Speedorz. 2. Победителят обръща карта и избира бойна сила. 3. Другият играч обръща карта. Сравнете избраната сила и на двете карти. 4. Играчът с най-висока сила печели 2 кристала CHI. 5. Първият играч, който събере 6 кристала CHI, печели играта.

CHI бонус: Когато обърнете карта, можете да платите 1 кристал CHI, за да добавите бонуса CHI към която и да е свързана бойна сила.



KĀ SPĒLĒT

1. Sacentieties ar saviem Speedorz varoņiem. 2. Uzvarētājs paceļ kārti un izvēlas cīņas spēku. 3. Otrs spēlētājs paceļ kārti. Salīdziniet izvēlēto spēku abās kārtīs. 4. Spēlētājs, kura spēks ir lielāks, iegūst 2 čī kristālus. 5. Spēlētājs, kura spēks ir mazāks, iegūst 6 čī kristālus, ir uzvarējis cīņā.

Čī bonuss. Paceļot kārti, vari samaksāt vienu 1 Čī kristālu, lai pievienotu Čī bonusu jebkuram saistītajam cīņas spēkam.



MÄNGU KÄIK

1. Võistelge oma Speedorziga. 2. Võitja pöörab kaardi ümber ja valib lahinguvõime. 3. Teine mängija pöörab kaardi ümber. Võrrelege valitud võimet mõlemal kaardil. 4. Suurema võimega mängija saab kaks CHI kristalli. 5. Lahingu võidab mängija, kes kogub esimesena kuus CHI kristalli.

CHI boonus: Kaarti ümber pöörates võid mis tahes lahinguvõimele CHI boonuse lisamiseks maksta ühe CHI kristalli.



KAIP ŽAISTI

1. Rungtyniauk su savo Speedorz. 2. Laimėjojas apverčia kortelę ir pasirenka kovos galią. 3. Kitas žaidėjas apverčia kortelę. Palygink abiejose kortelėse nurodytas kovos galias. 4. Didesnė kovos galių turintis žaidėjas laimi du Či kristalus. 5. Kovą laimi pirmasis 6 Či kristalus surinkęs žaidėjas.

Či premija: Apvertęs kortelę gali sumokėti 1 Či kristalą, kad pridėtum Či premiją prie bet kurios kovos galios.



NASIL OYNANIR

1. Speedorz ile yarışın. 2. Kazanan bir kart açar ve bir savaş gücü seçer. 3. Rakip oyuncu bir kart açar. Her iki kartta seçilen gücü karşılaştırın. 4. En yüksek güce sahip oyuncu 2 CHI kristali kazanır. 5. 6 CHI kristali kazanan ilk oyuncu savaşta kazanır.

CHI bonusu: Bir kart açıldığında, bağlı herhangi bir savaş gücüne CHI bonusu eklemek için 1 CHI kristali ödeyebilirsiniz.



70115



70100



70101



70102



70103



70103



CHIMA

LEGO

LEGO CHIMA



LEGO.COM/CHIMA



3

www.LEGOclub.com/Max

LEGO club™

FREE*! GRATIS! GRATUIT!

*Paid subscription in Australia and New Zealand.
*Abonnement payant en Australie et Nouvelle-Zélande.

©2013 The LEGO Group.





WIN!

Go to www.LEGOsurvey.com/product to fill out a survey for a chance to win a cool LEGO® Product.

No purchase necessary.

Open to all residents where not prohibited.



www.LEGOsurvey.com/product

GEWINNE!

Nimm an der Umfrage auf www.LEGOsurvey.com/product teil und hab die Chance ein cooles LEGO® Produkt zu gewinnen!

Die Teilnahme am Gewinnspiel führt zu keinerlei Kaufverpflichtungen. Teilnahme in allen nicht ausgeschlossenen Ländern möglich.

WIN!

Ga naar www.LEGOsurvey.com/product, vul een enquêteformulier in en maak kans op een cool LEGO® product.

Geen aankoopverplichting. Iedereen mag deelnemen, uitgezonderd ingezetenden van landen waar een enquêteverbod geldt.

GAGNE!

Visite www.LEGOsurvey.com/product pour répondre à un questionnaire et avoir une chance de gagner un produit LEGO® très cool!

Aucune obligation d'achat. Ouvert à tous les résidents des pays autorisés.

当てよう!

www.LEGOsurvey.com/product にアクセスして、アンケートにご記入ください。当選者にはレゴ®製品を差し上げます。

お買い上げの必要はありません。禁止されていない限り、すべての皆様にご利用いただけます。



LEGO.com

6040471

LEGO and the LEGO logo are trademarks of the/son des marques de commerce de/son marcas registradas de LEGO Group. ©2013 The LEGO Group.