



NINJAGO

Masters of Spinjitzu



70502



**COLE
INCLUDED**

1

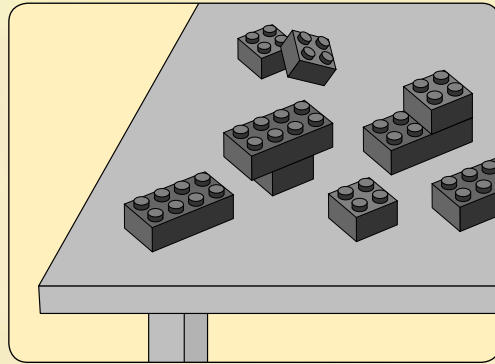
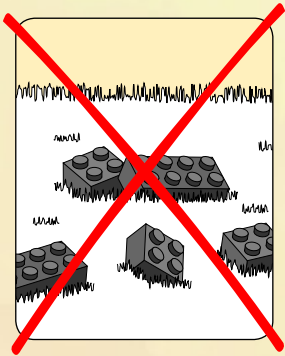

2

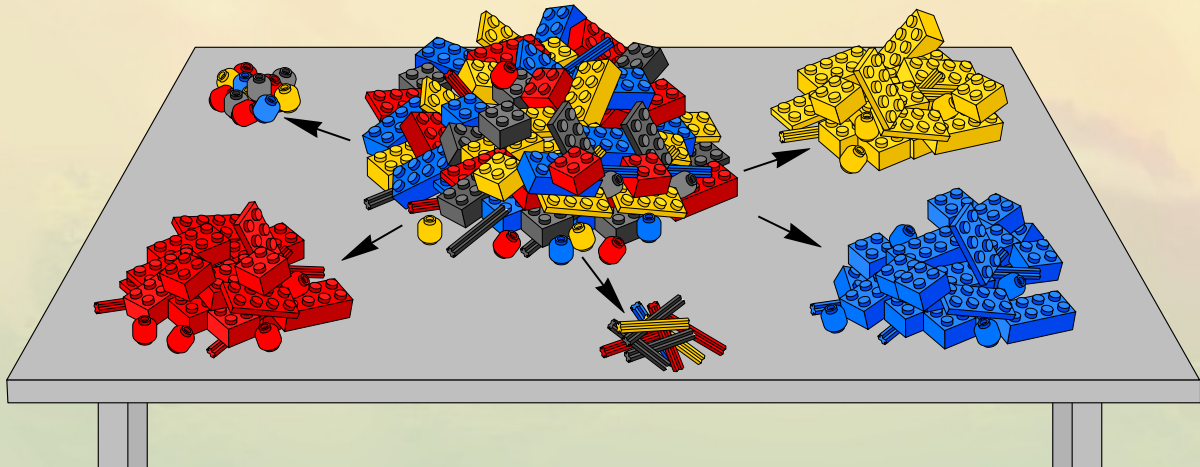

**COLE INCLUDED
COLE INCLUS
INCLUYE A COLE**

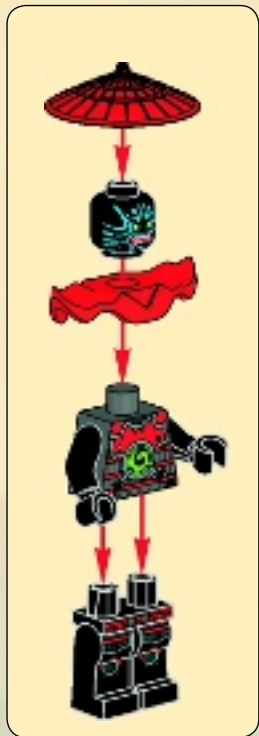

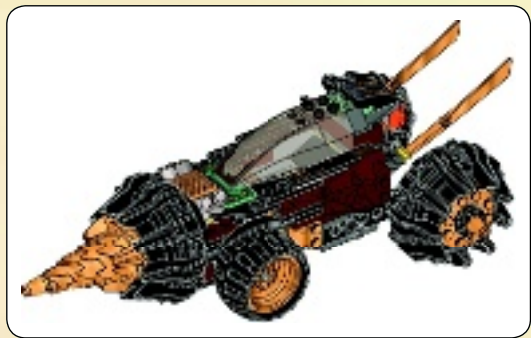

1





1x



1x

2

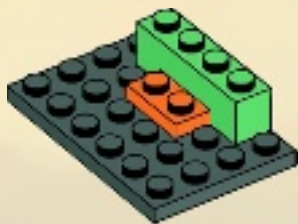

2x

3

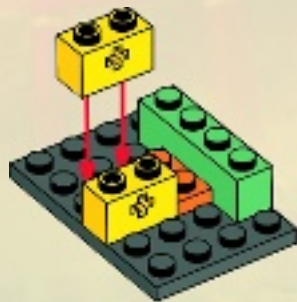

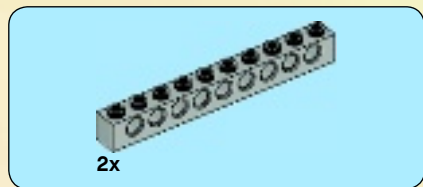

4

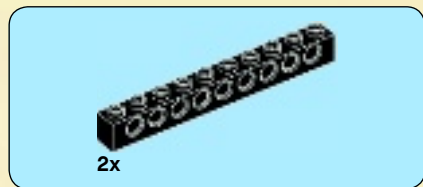
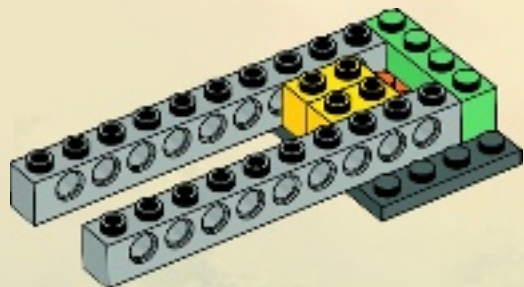

5

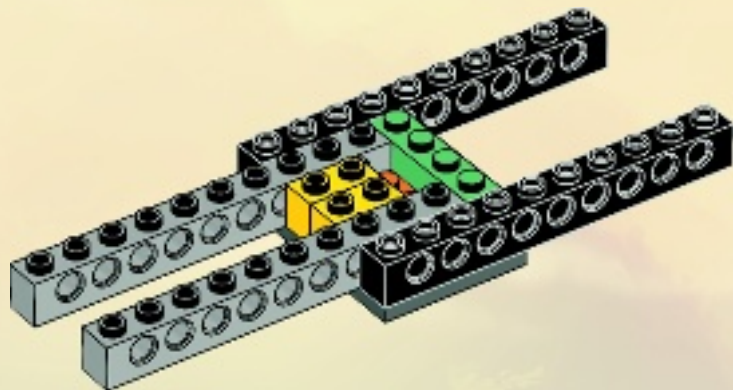

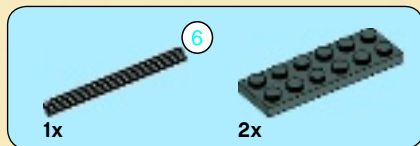

6

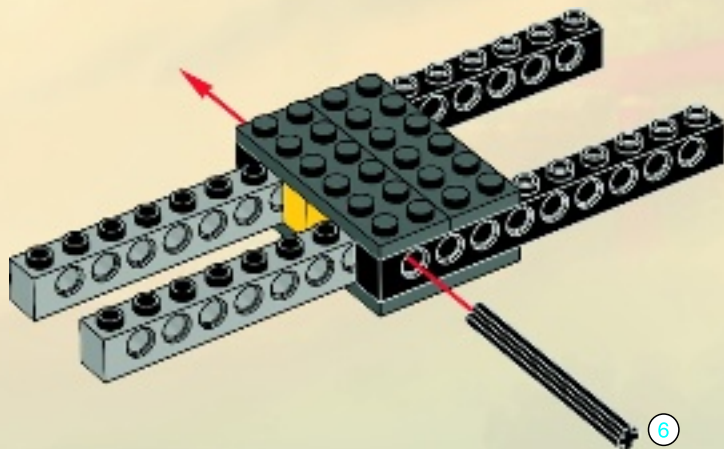



1x



2x

7

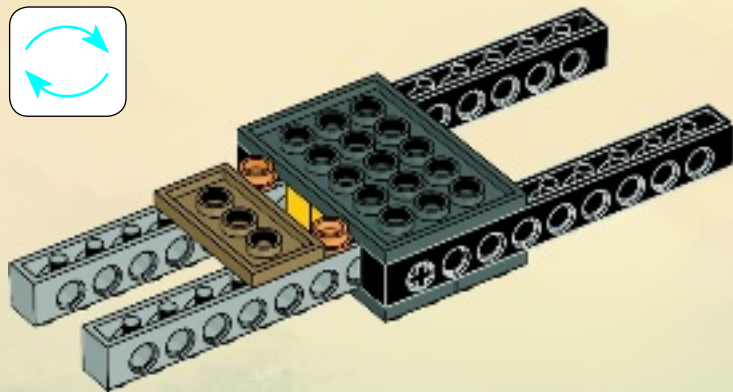
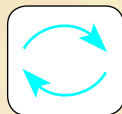

8



2x



2x

8

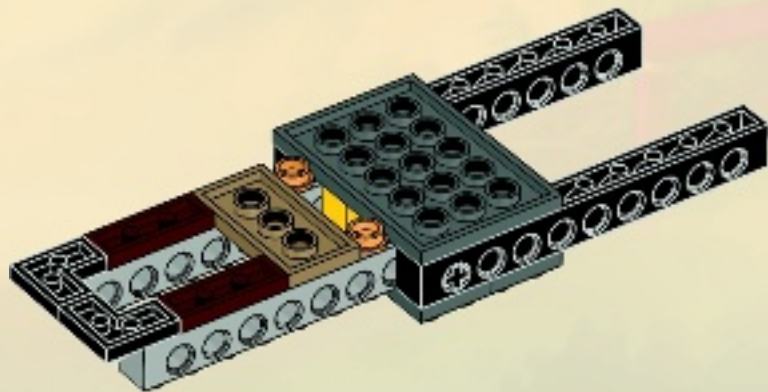



2x



2x

9

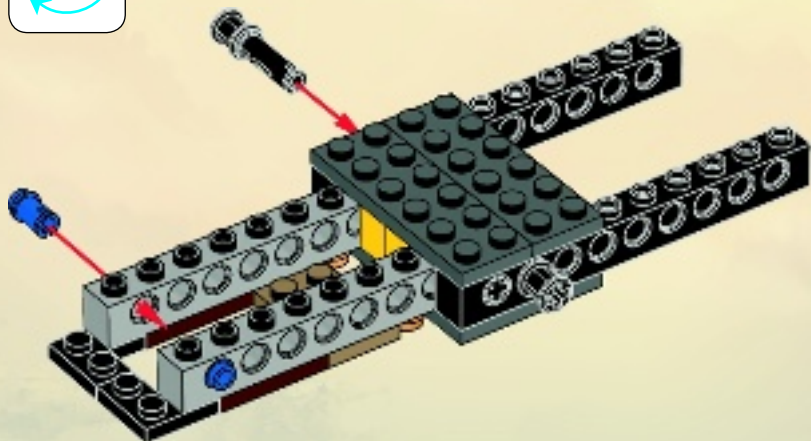
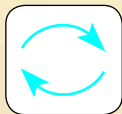



1x



4x

10





11

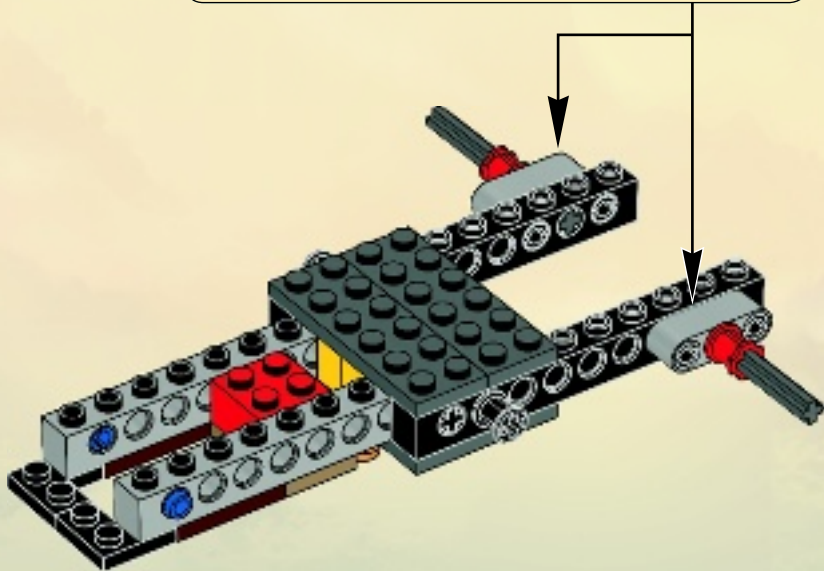
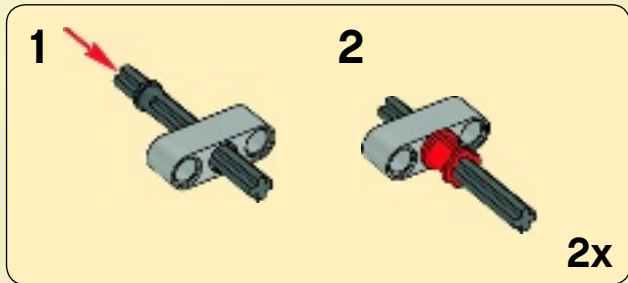

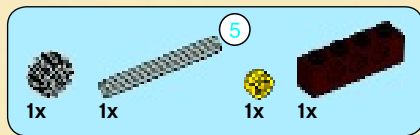

12

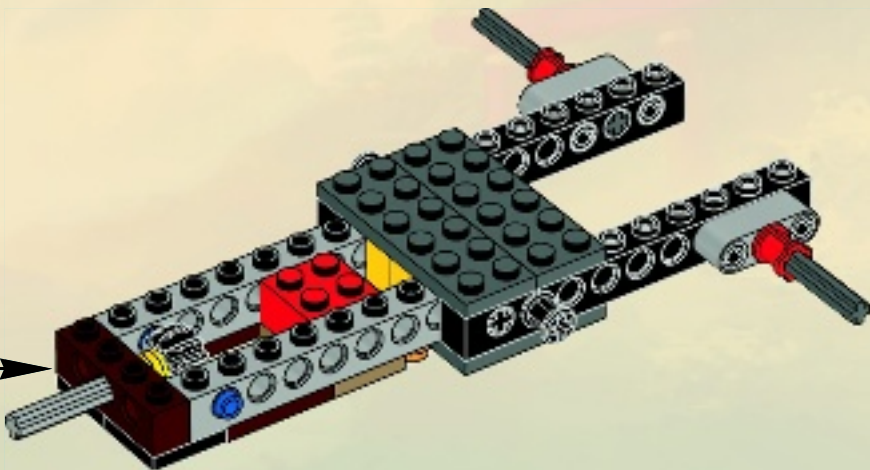
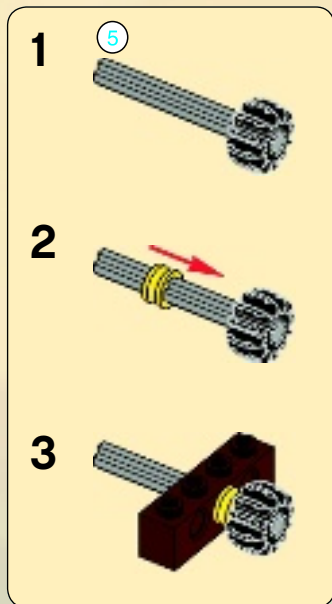

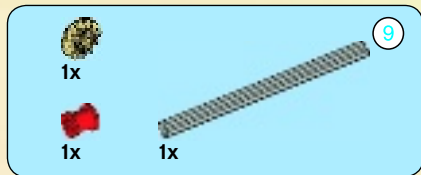

13

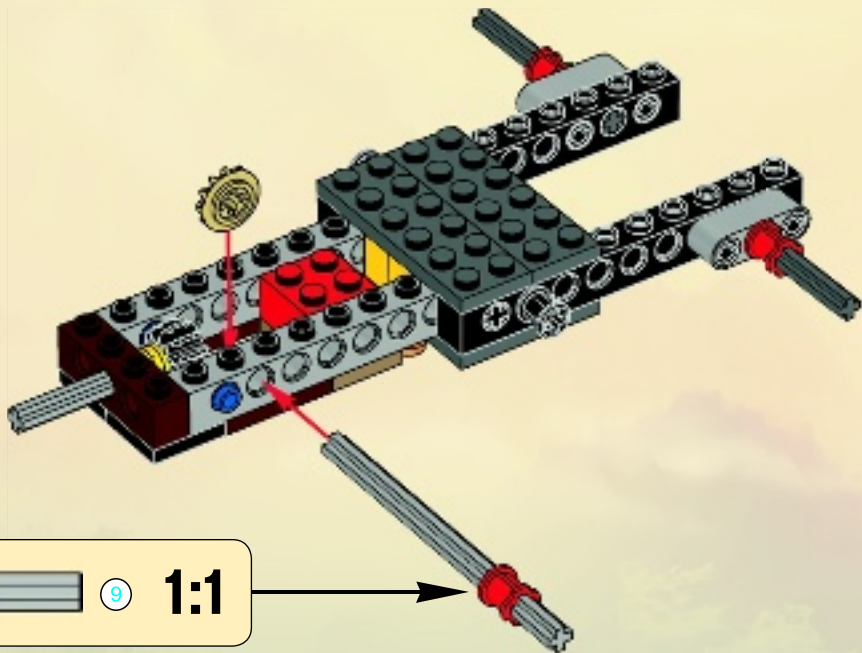



1x

14

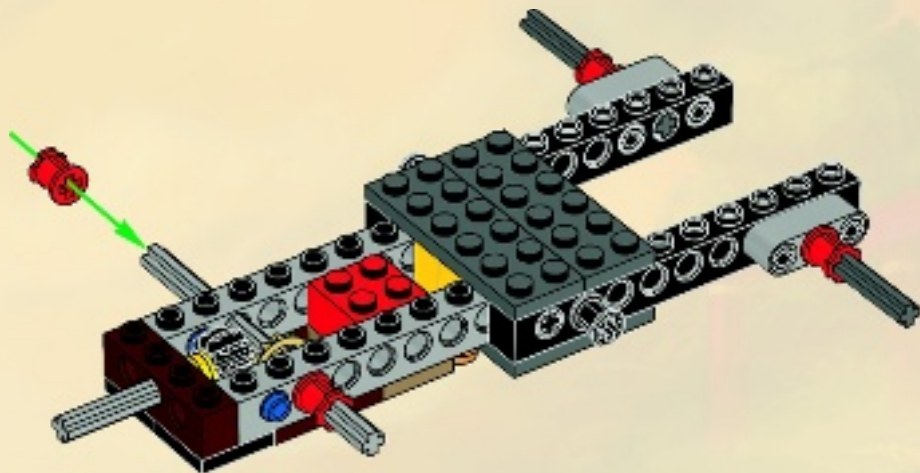



1x



2x

15

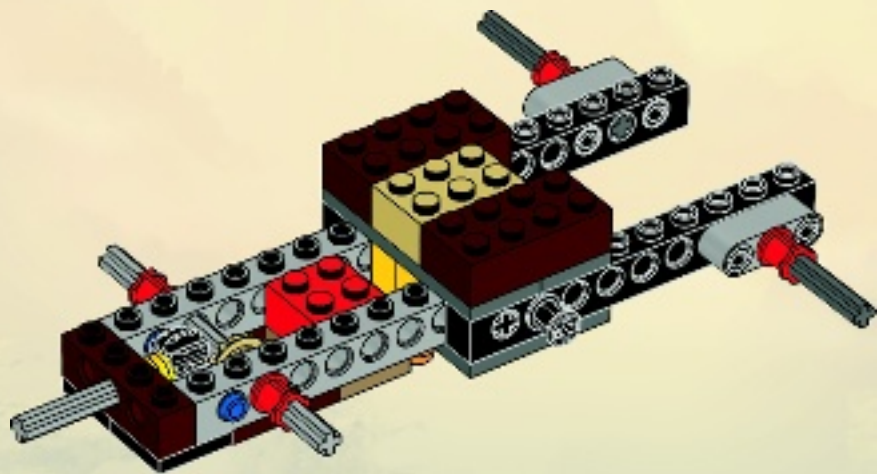



2x

16

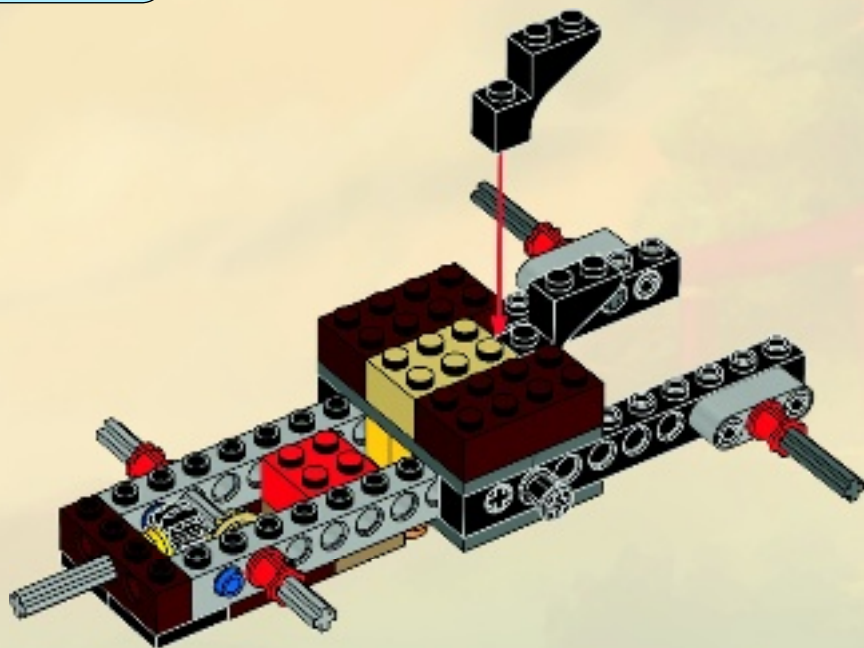



2x



1x

17

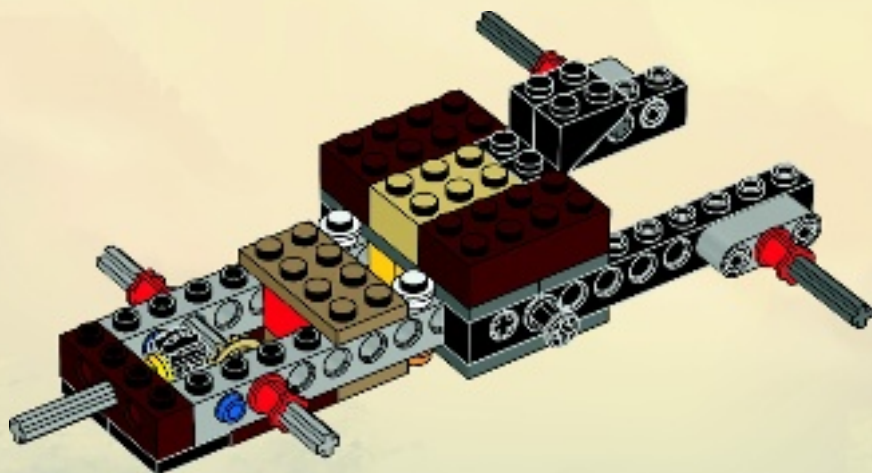



2x



2x

18

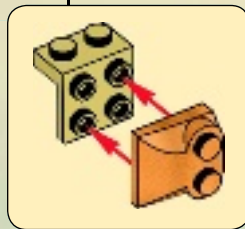
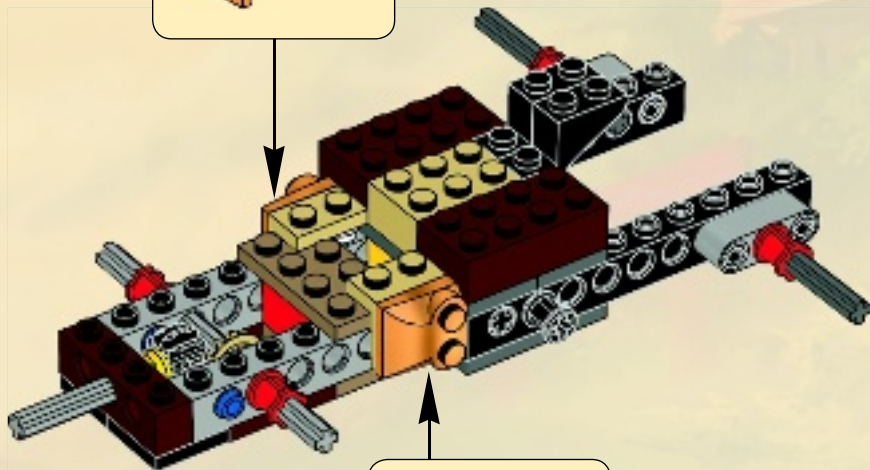
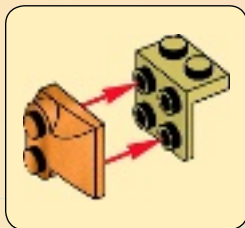

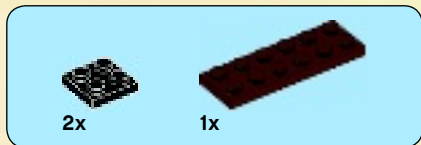

19

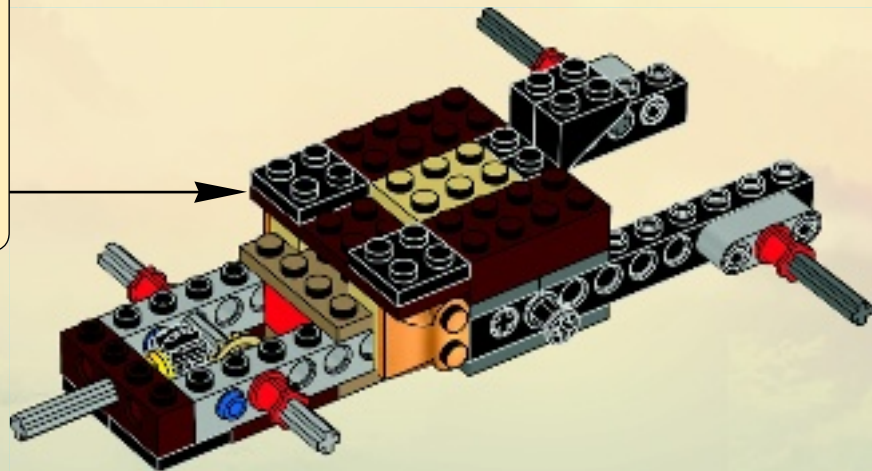
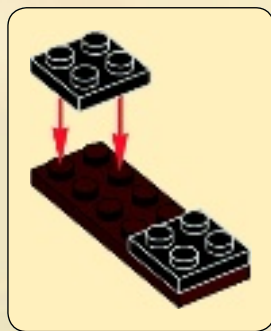

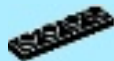

2x



2x

20

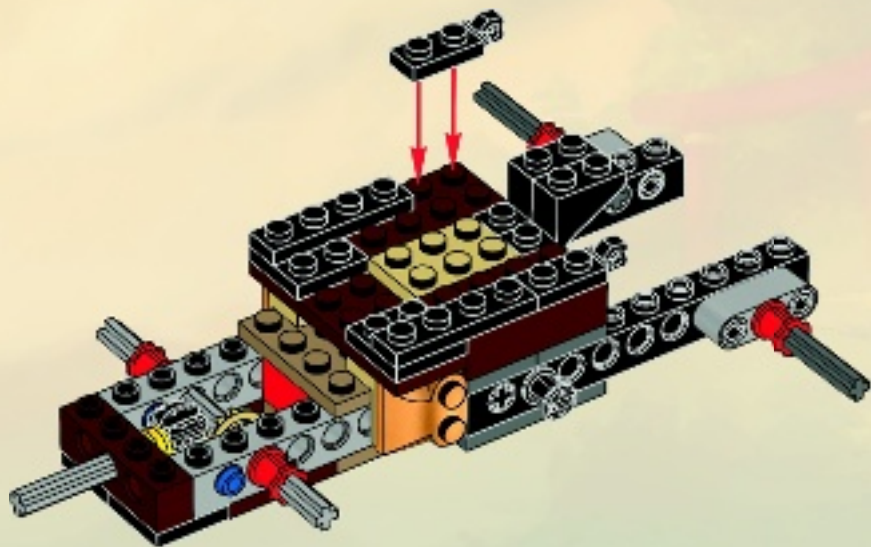



21

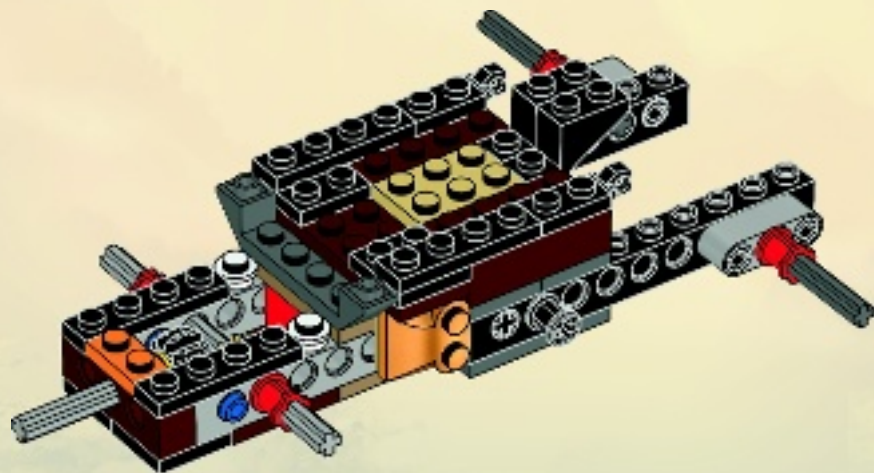

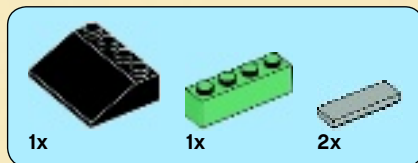

22

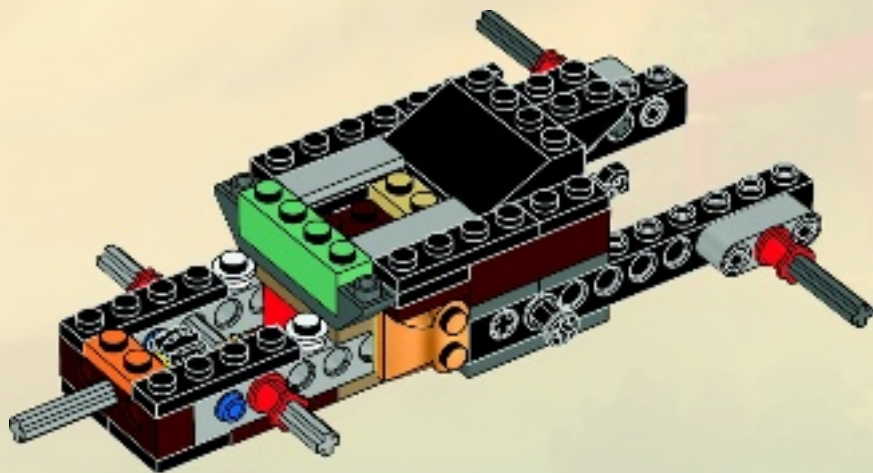

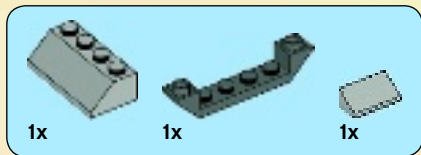

23

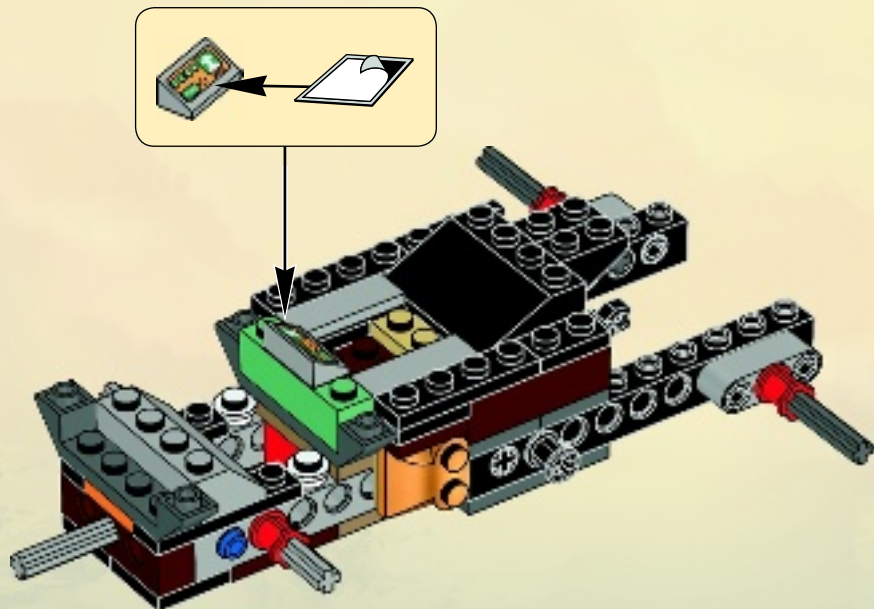

24



2x



1x

24

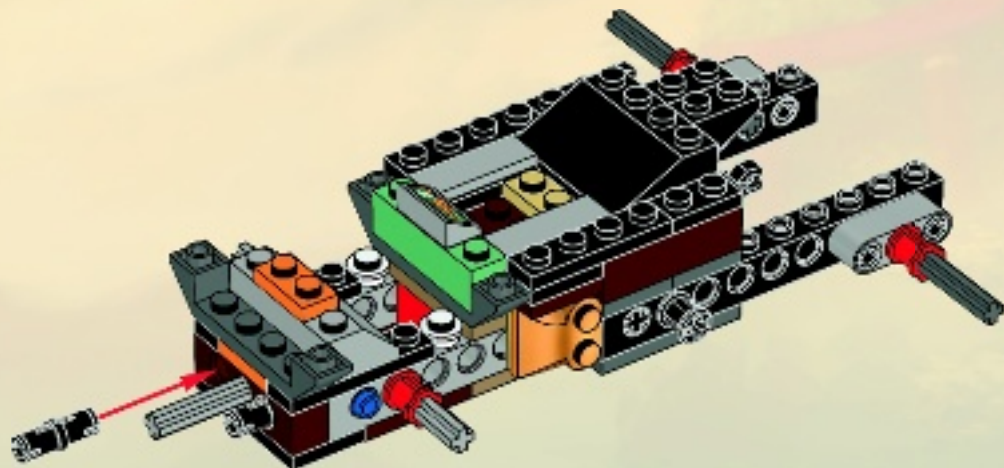



2x



1x

25

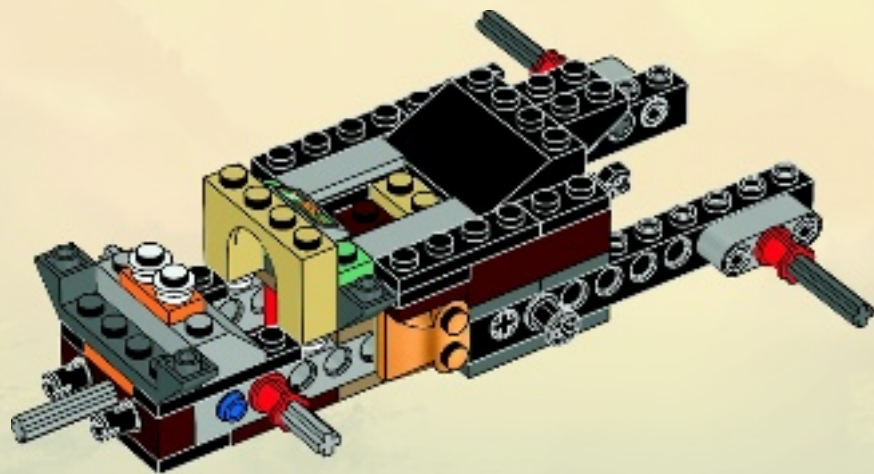

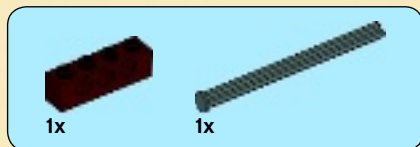

26

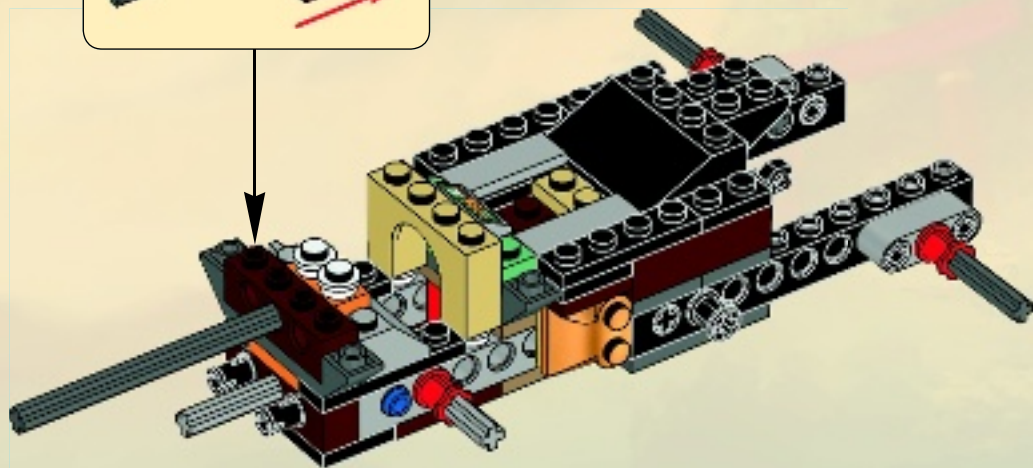
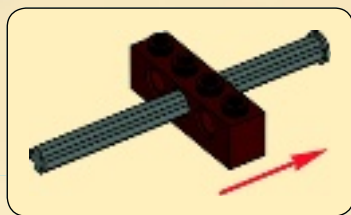



2x



1x

27

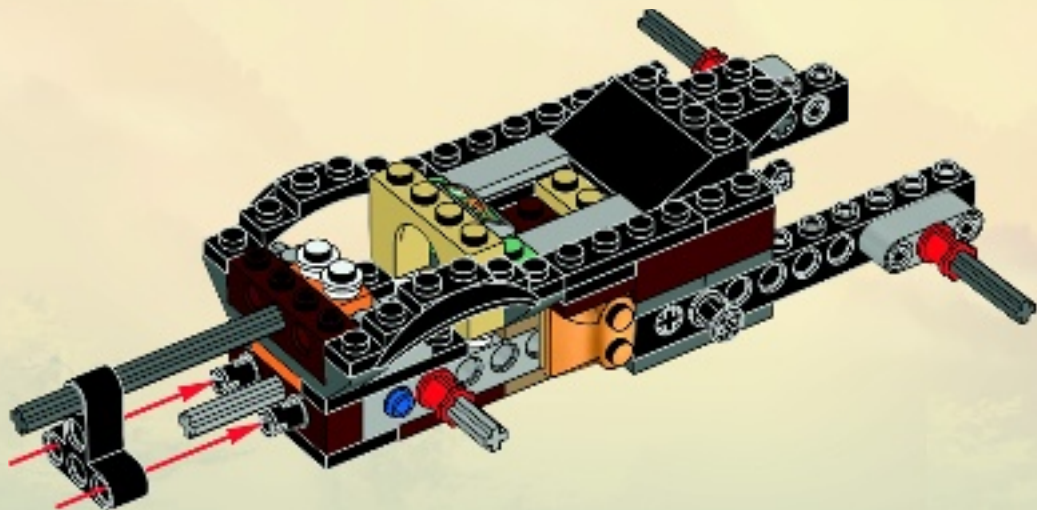

28



2x

28

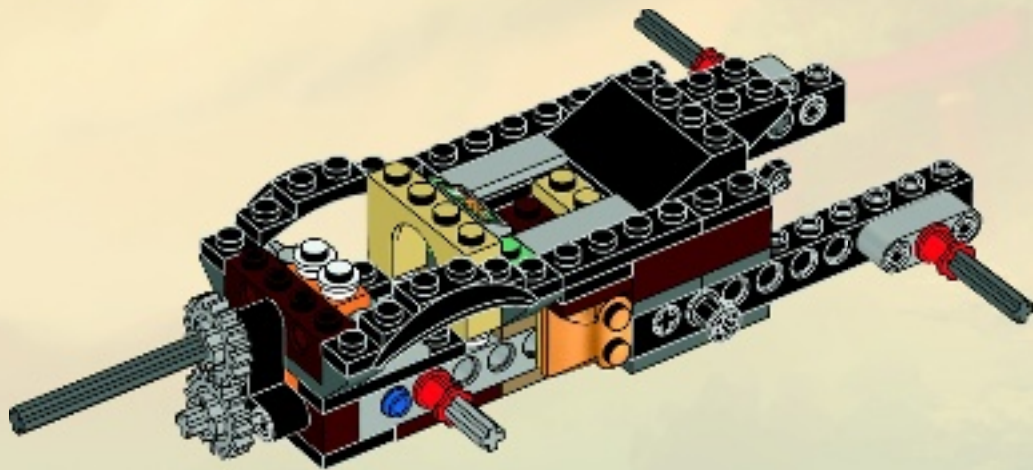



1x

29

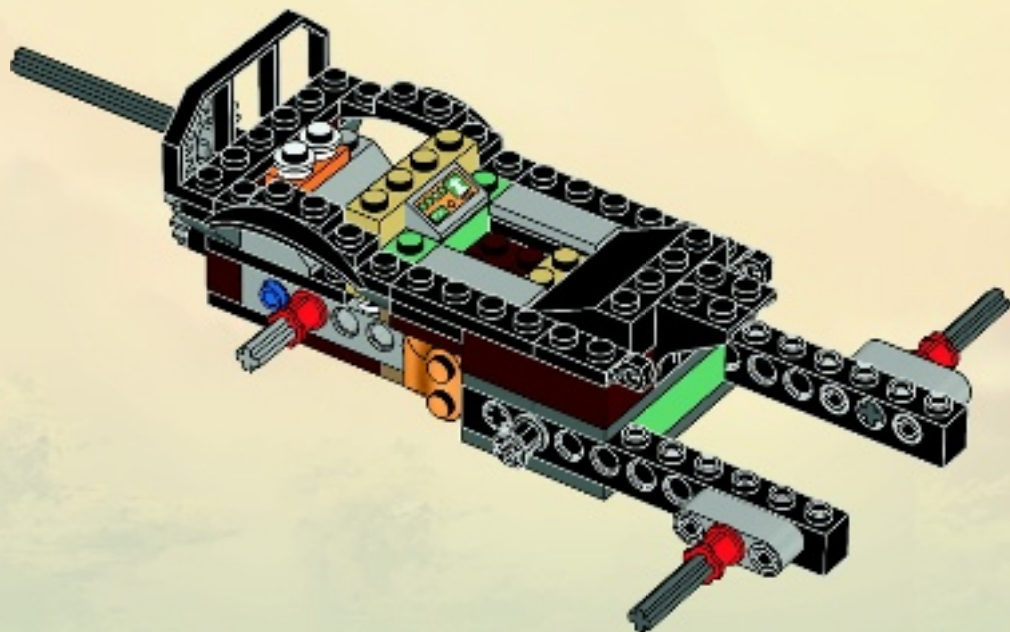

30



30

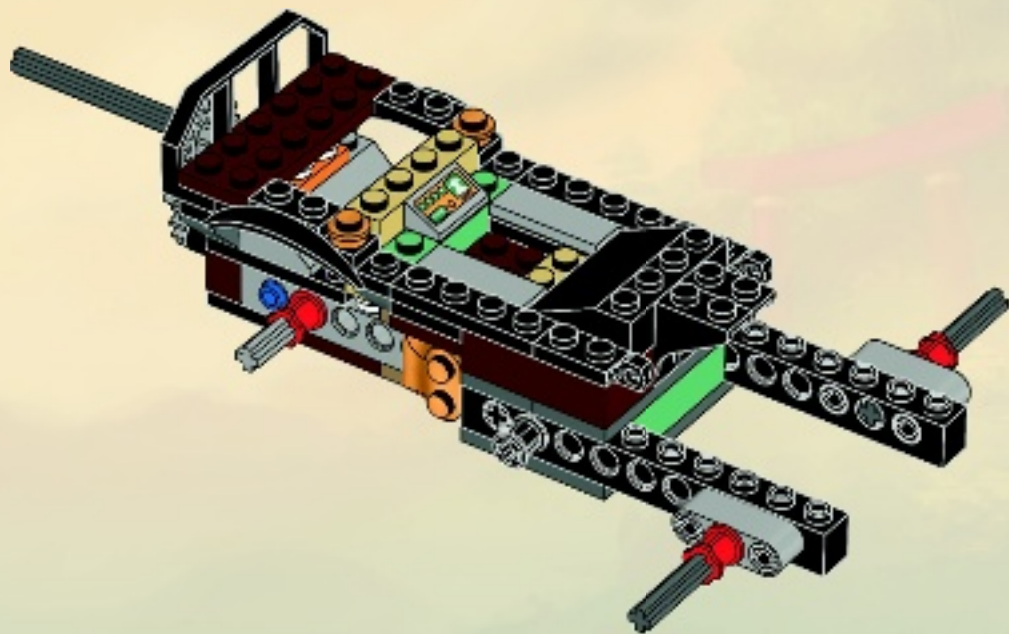



31

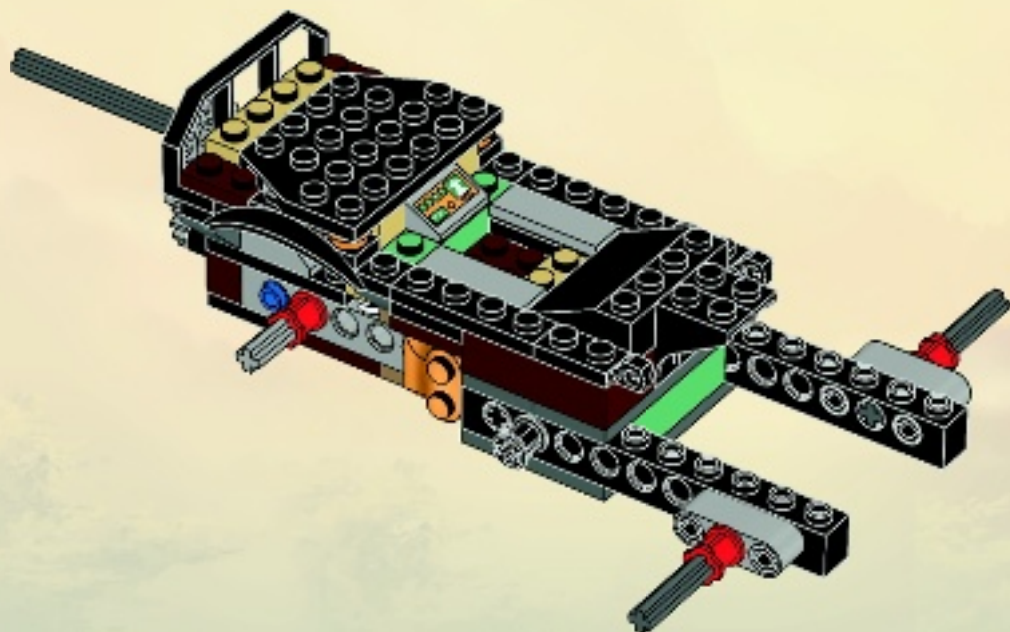



2x



2x

33

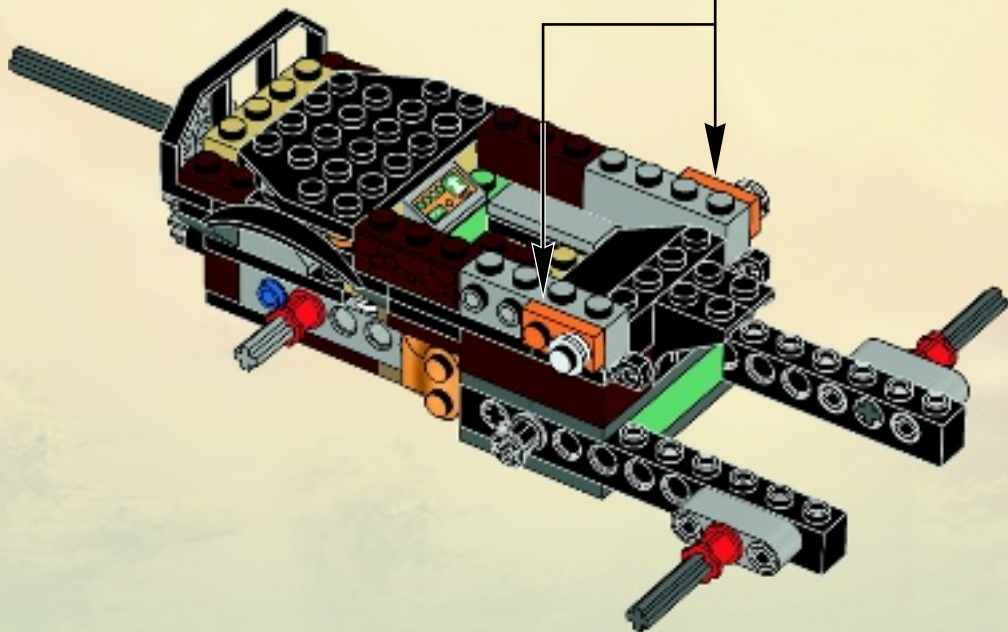
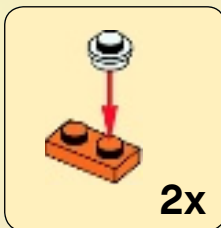



1x



1x



1x

34

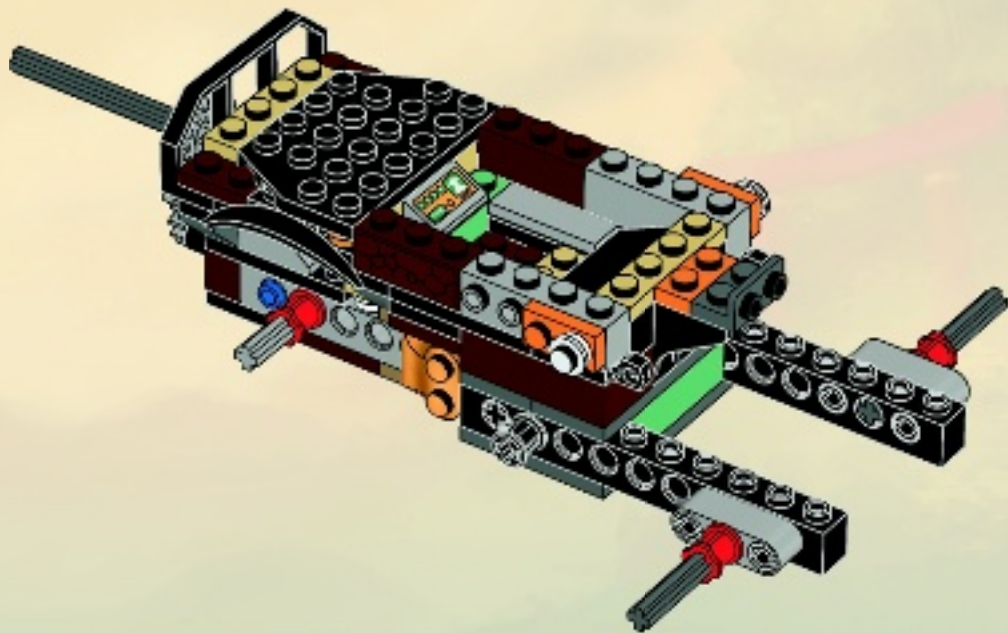

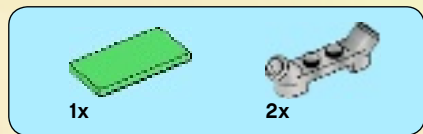

35

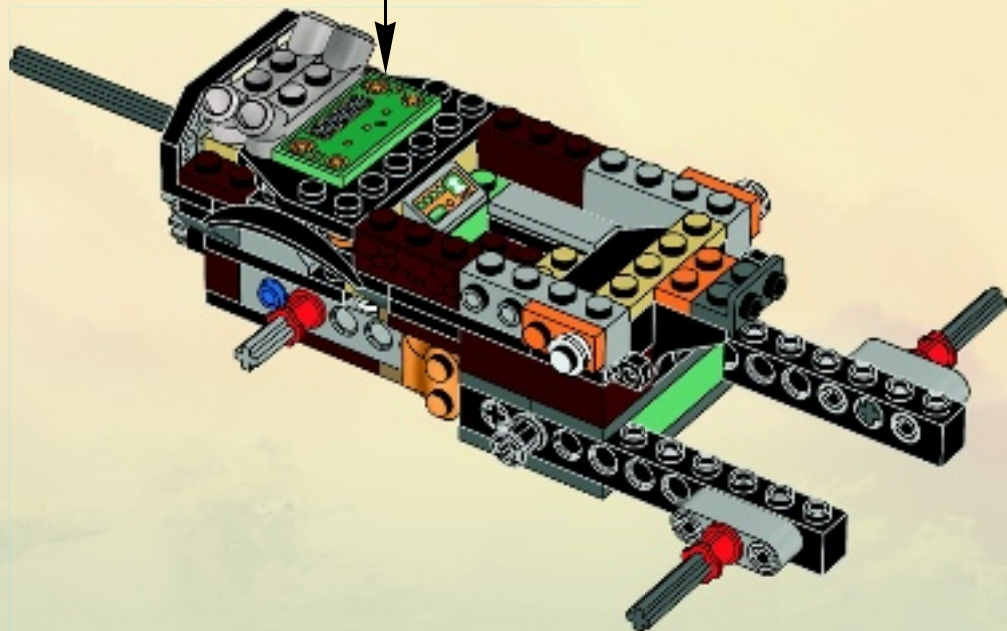
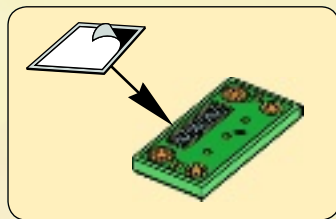



37

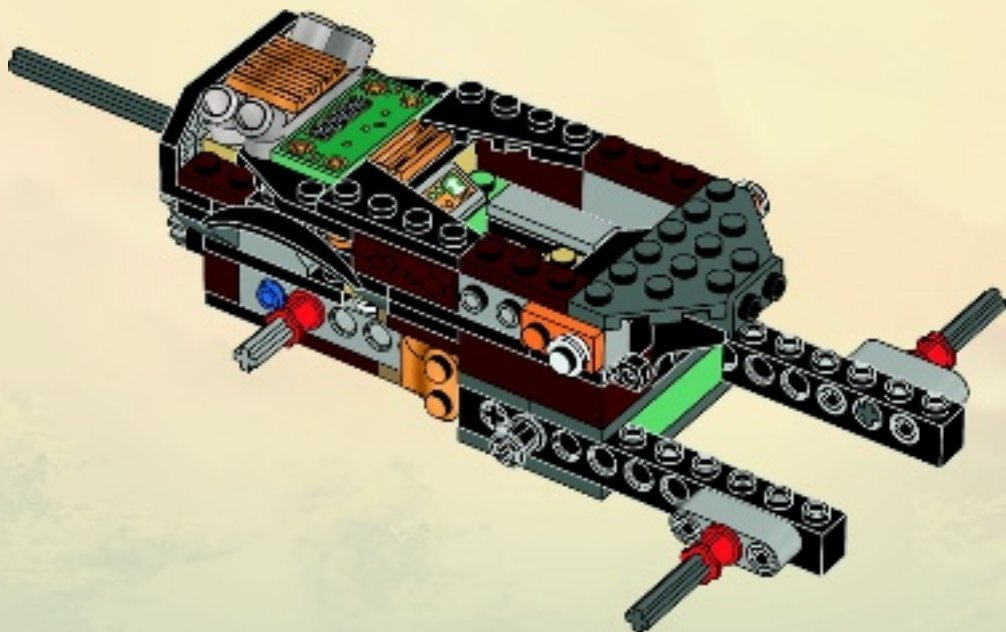



38

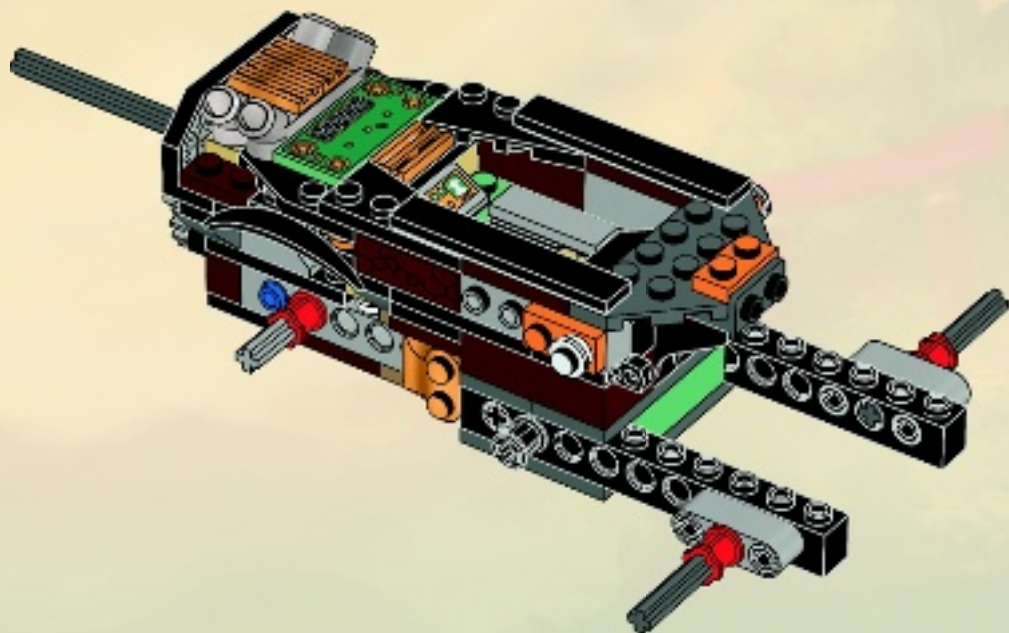



2x

39

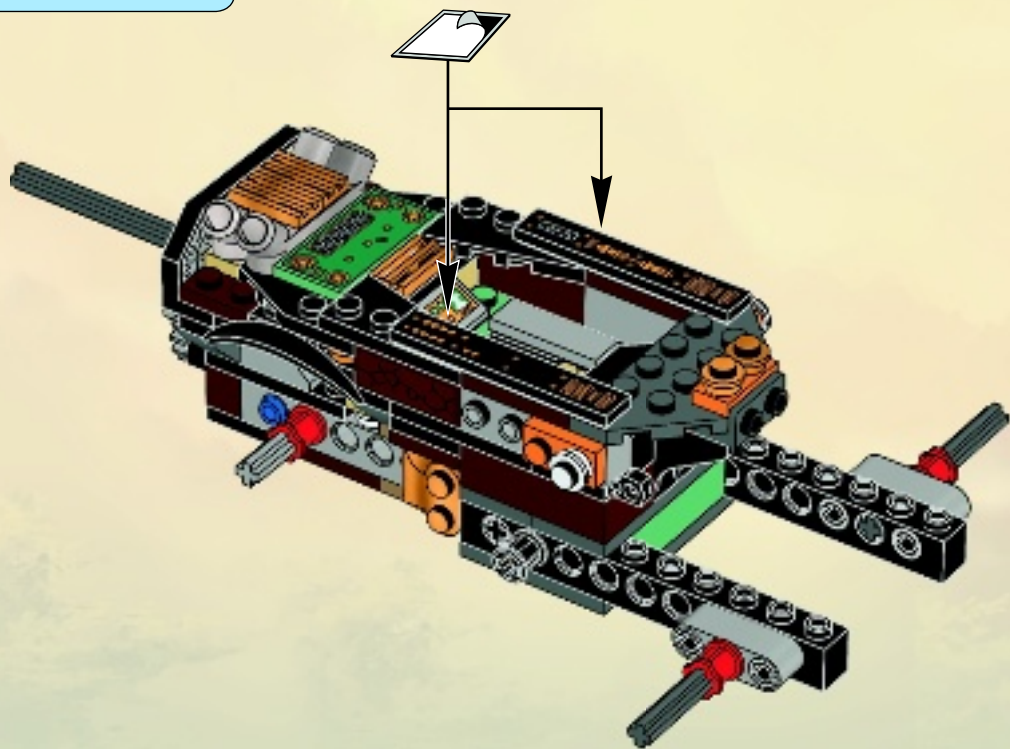



2x

40

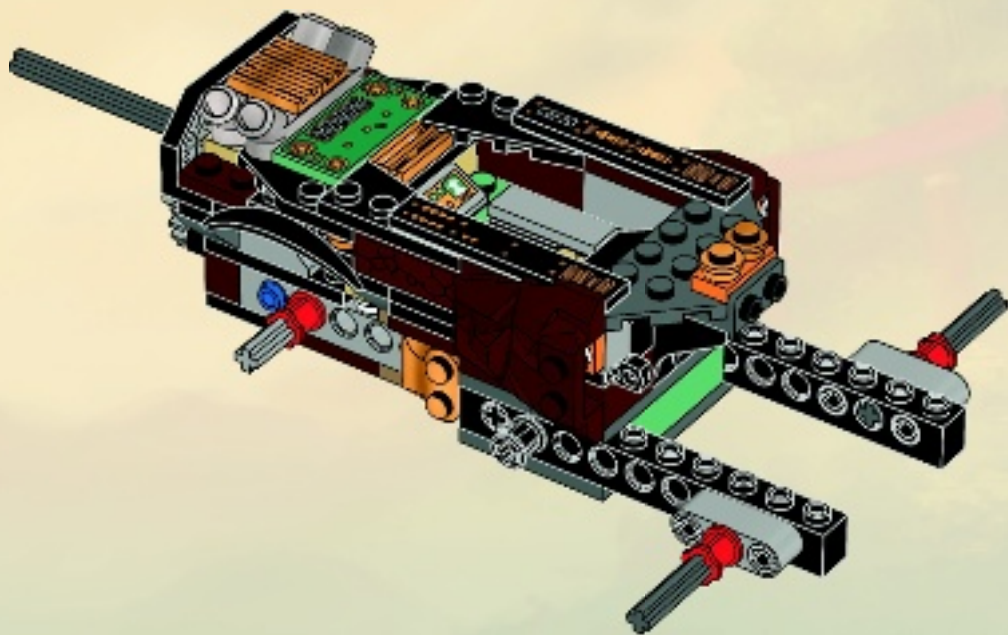



1x



1x

41

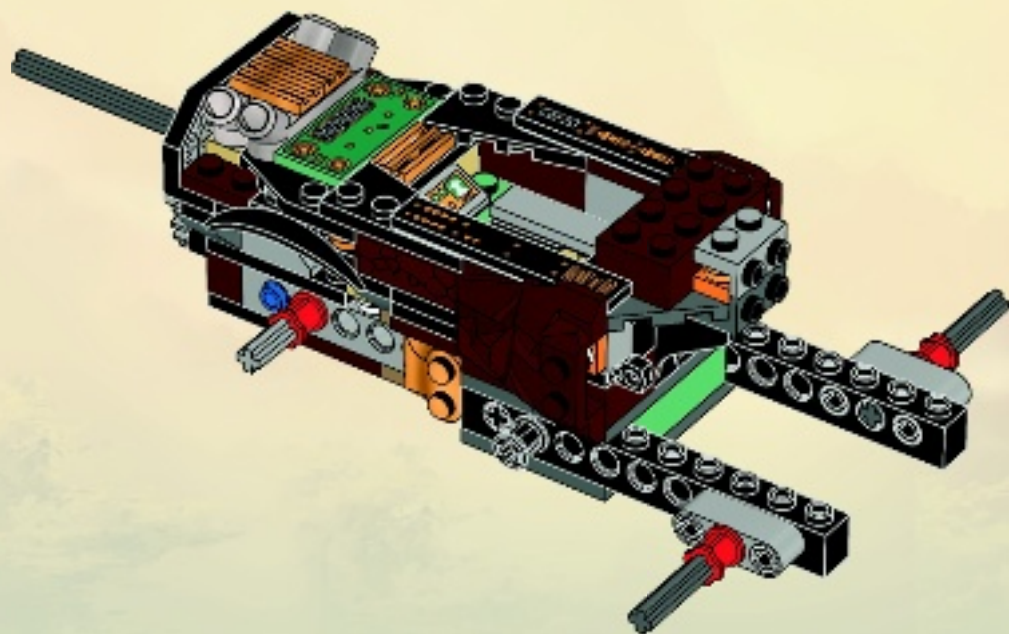

42



1x



2x

42

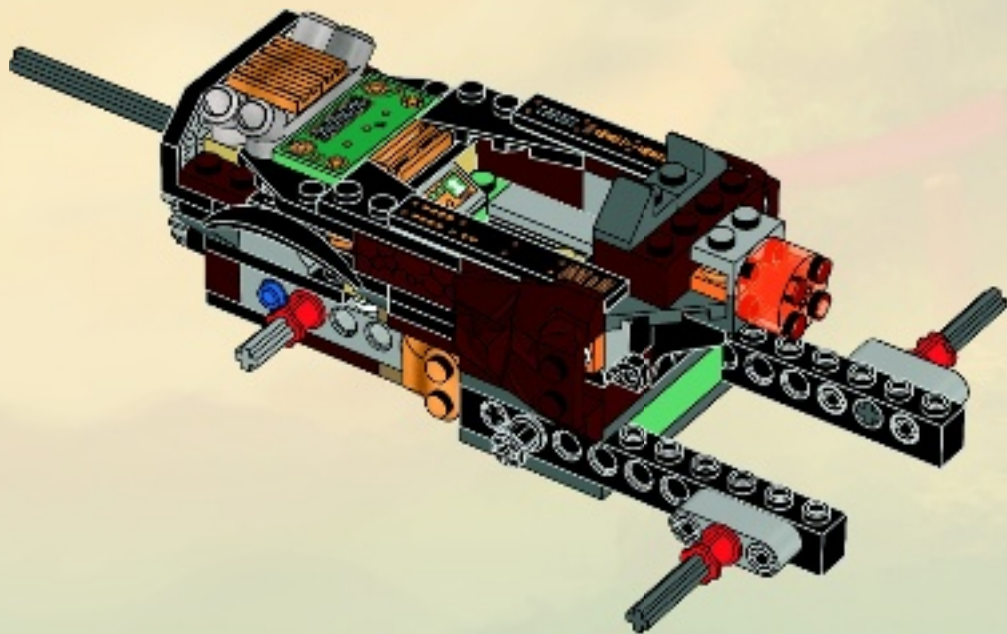



2x

44

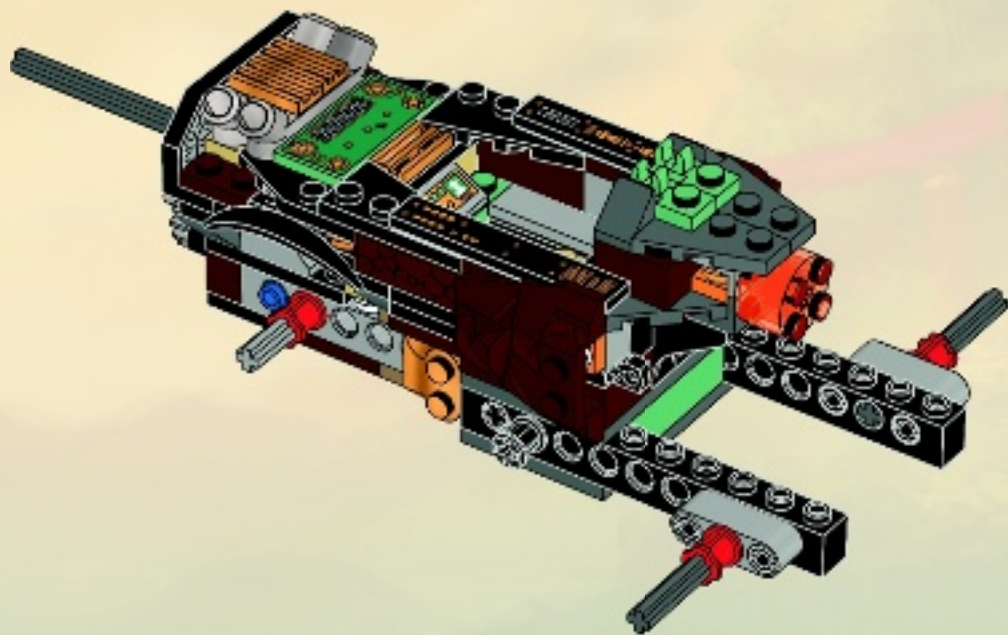



2x

45

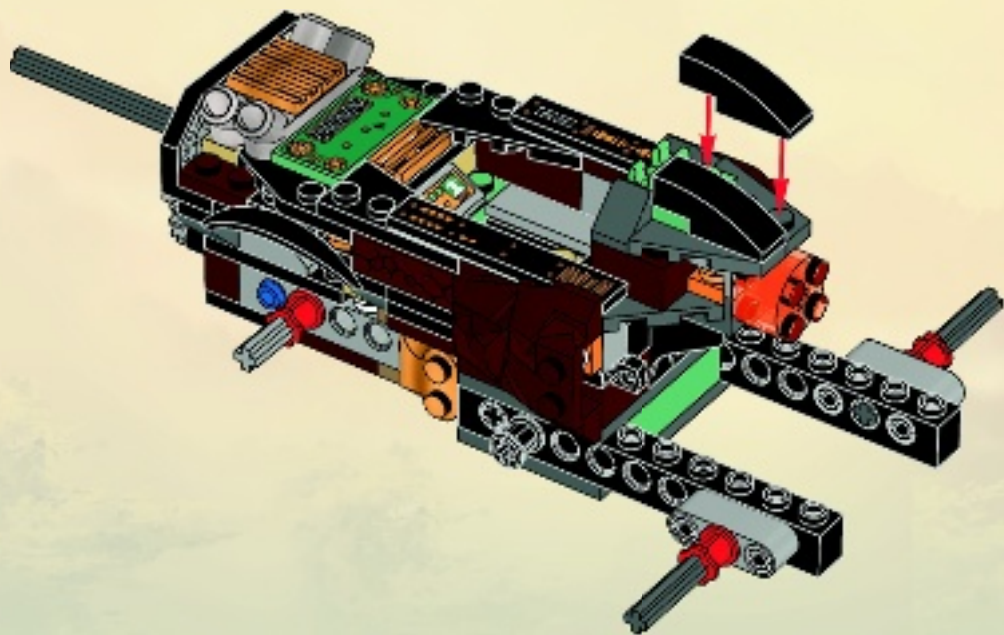

46

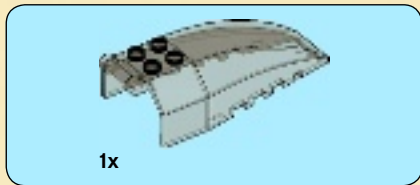

46

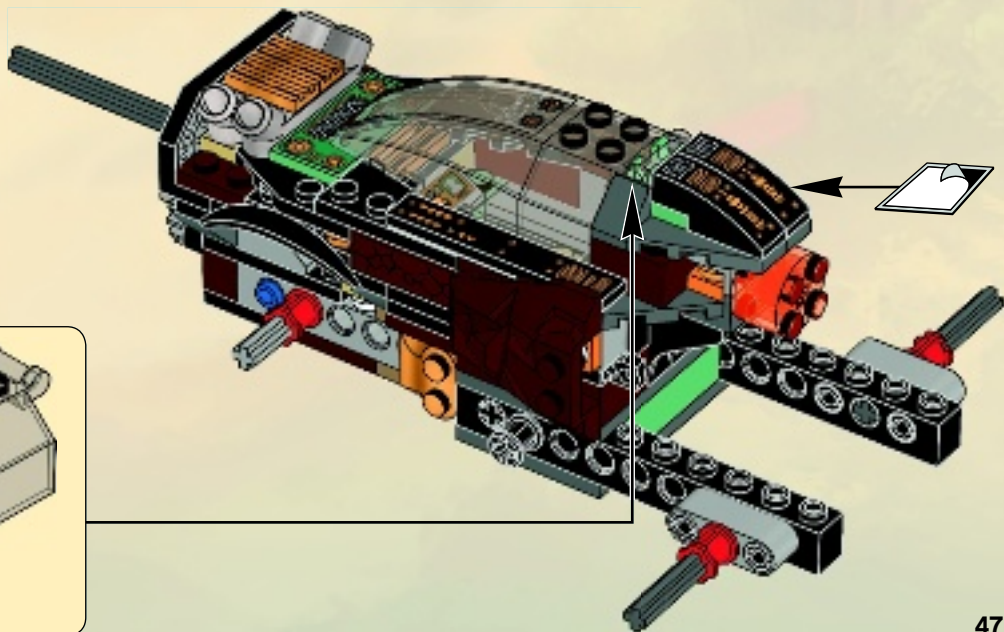
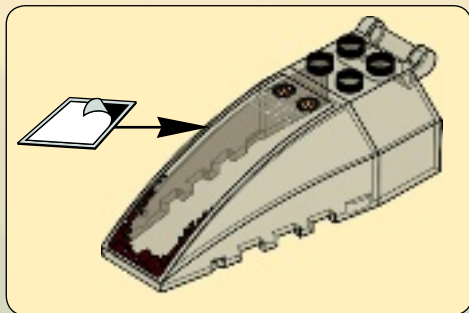

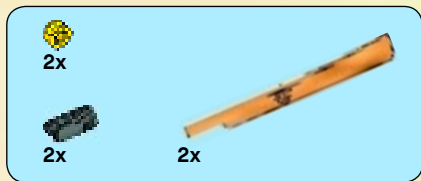

47

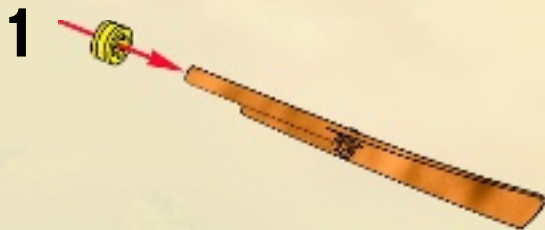

2x

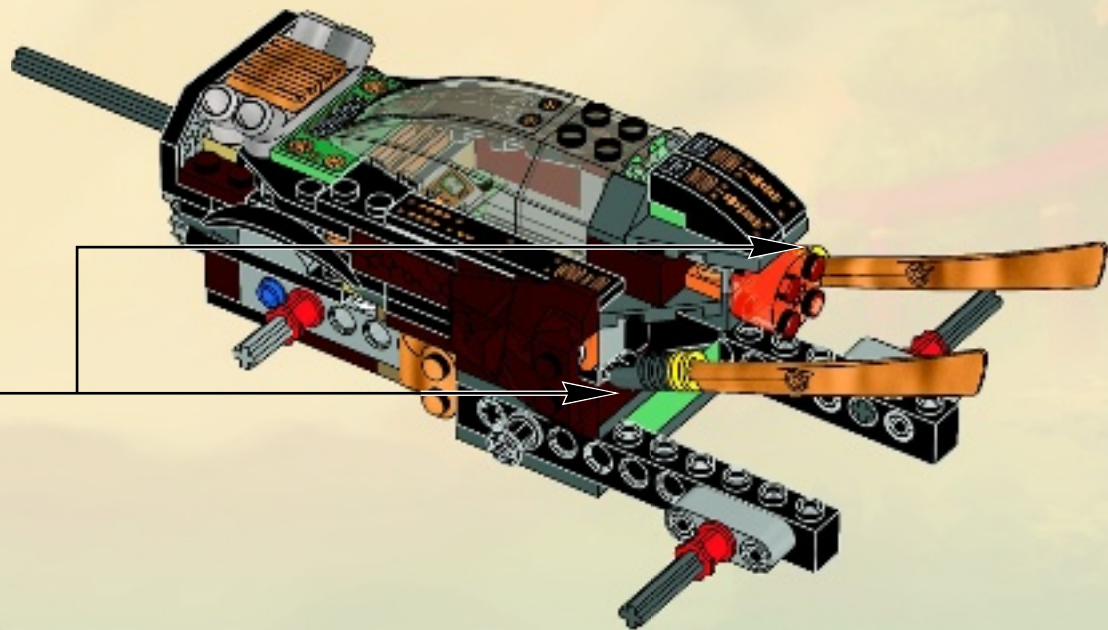

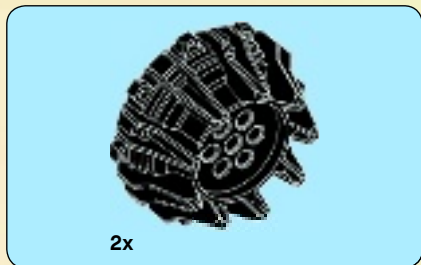

48

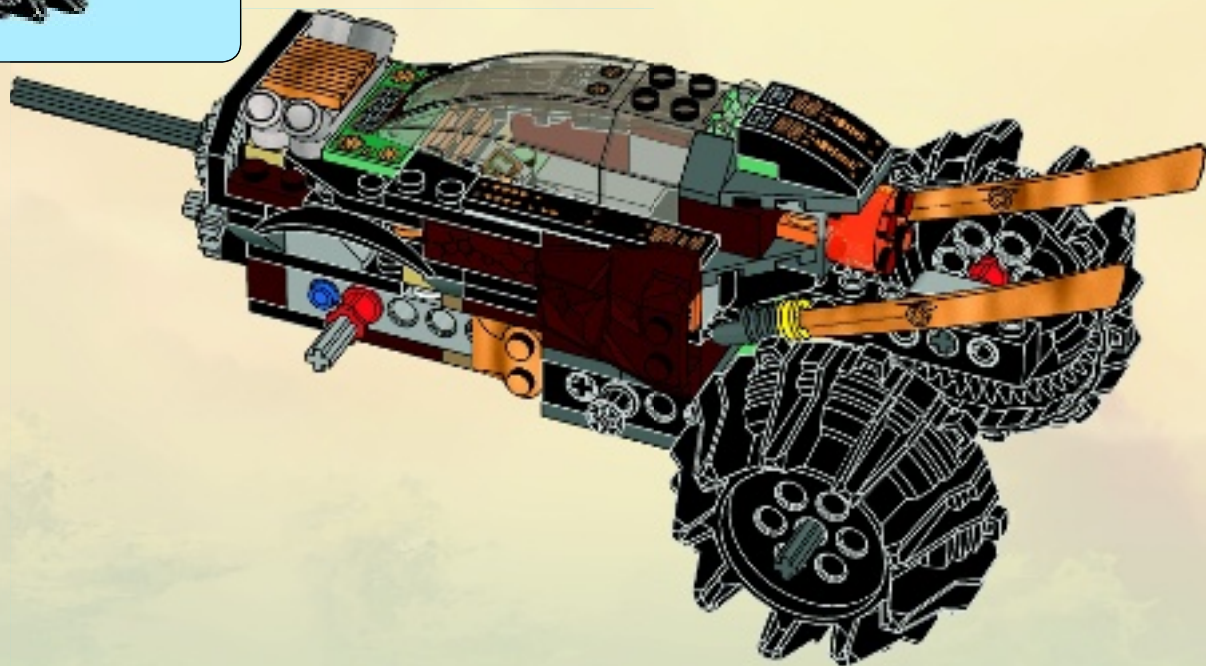



49

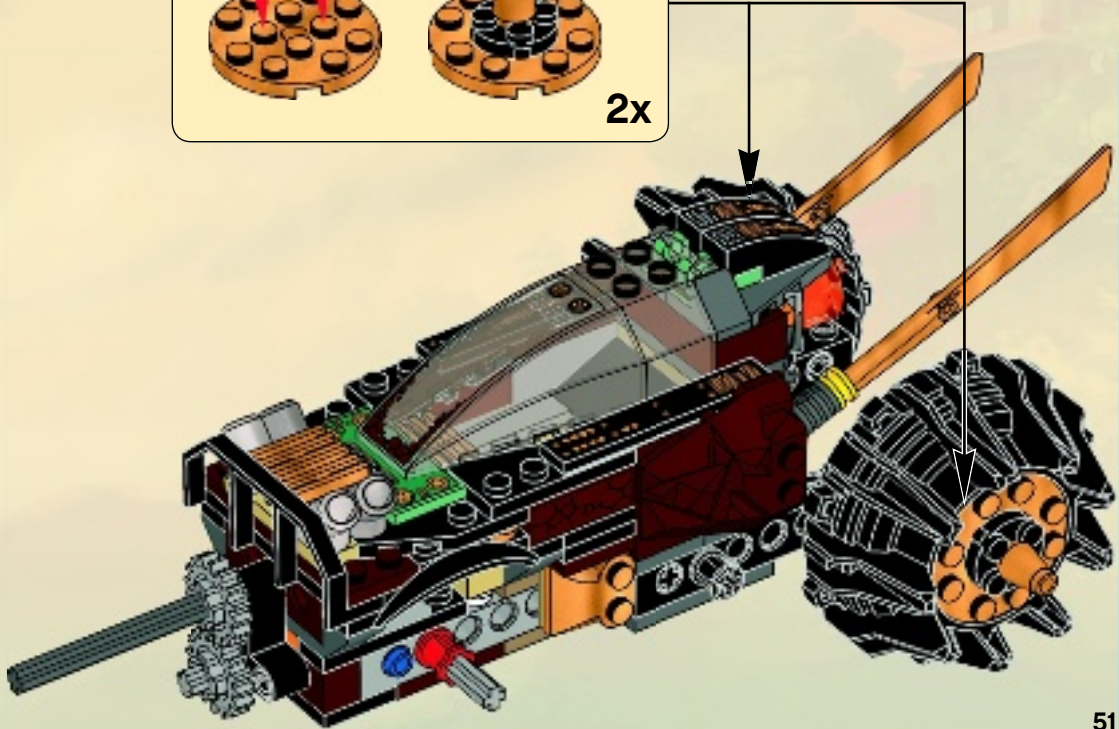
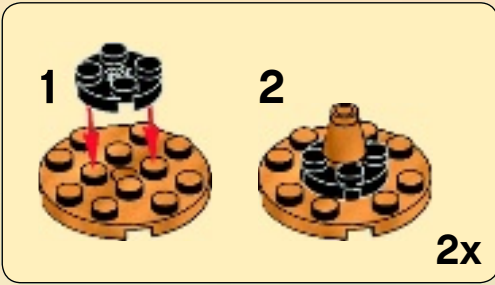

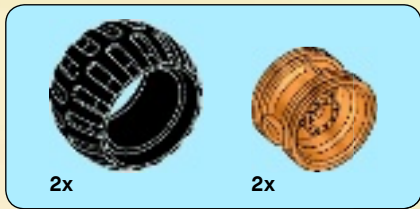

50

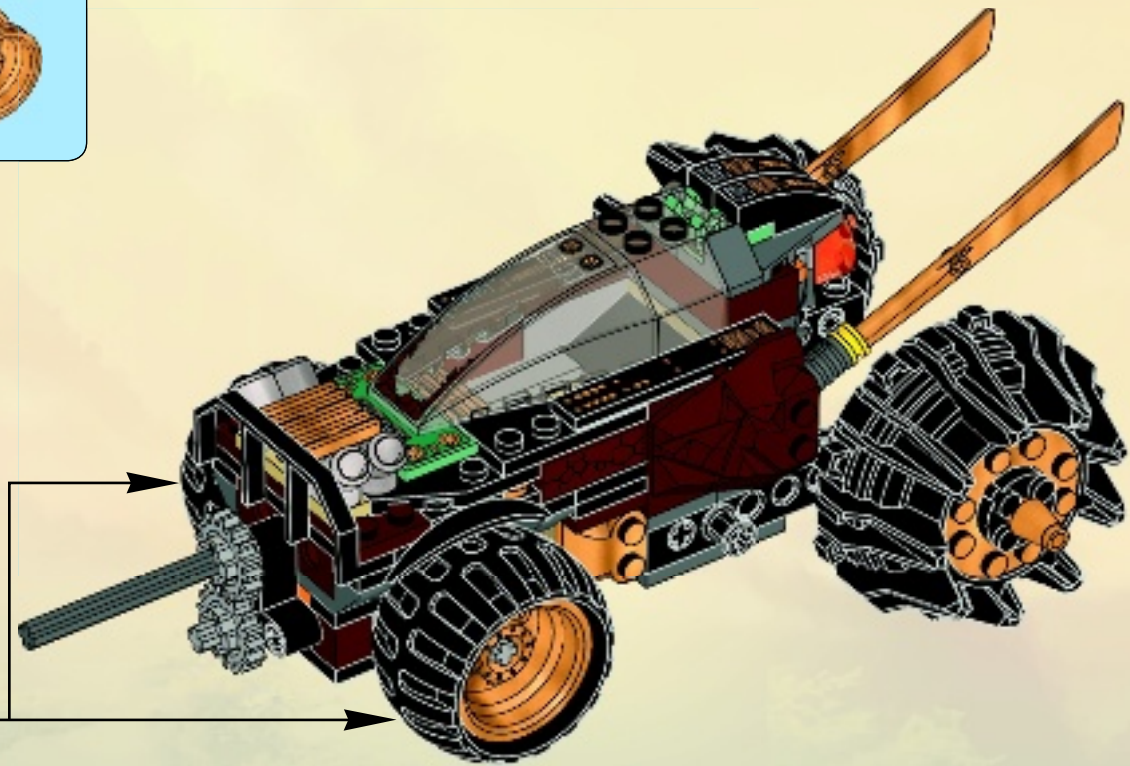
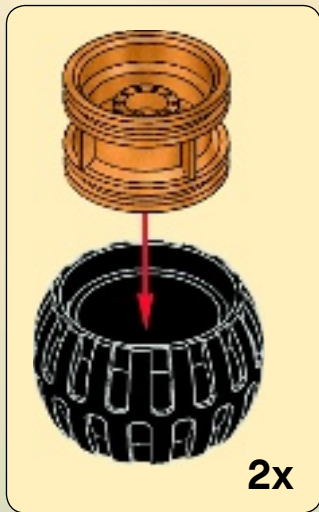

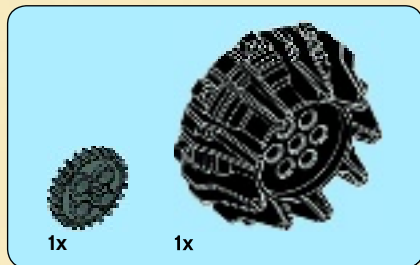

51



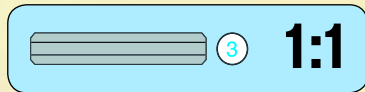

52



3

54

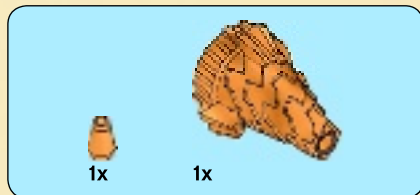

53

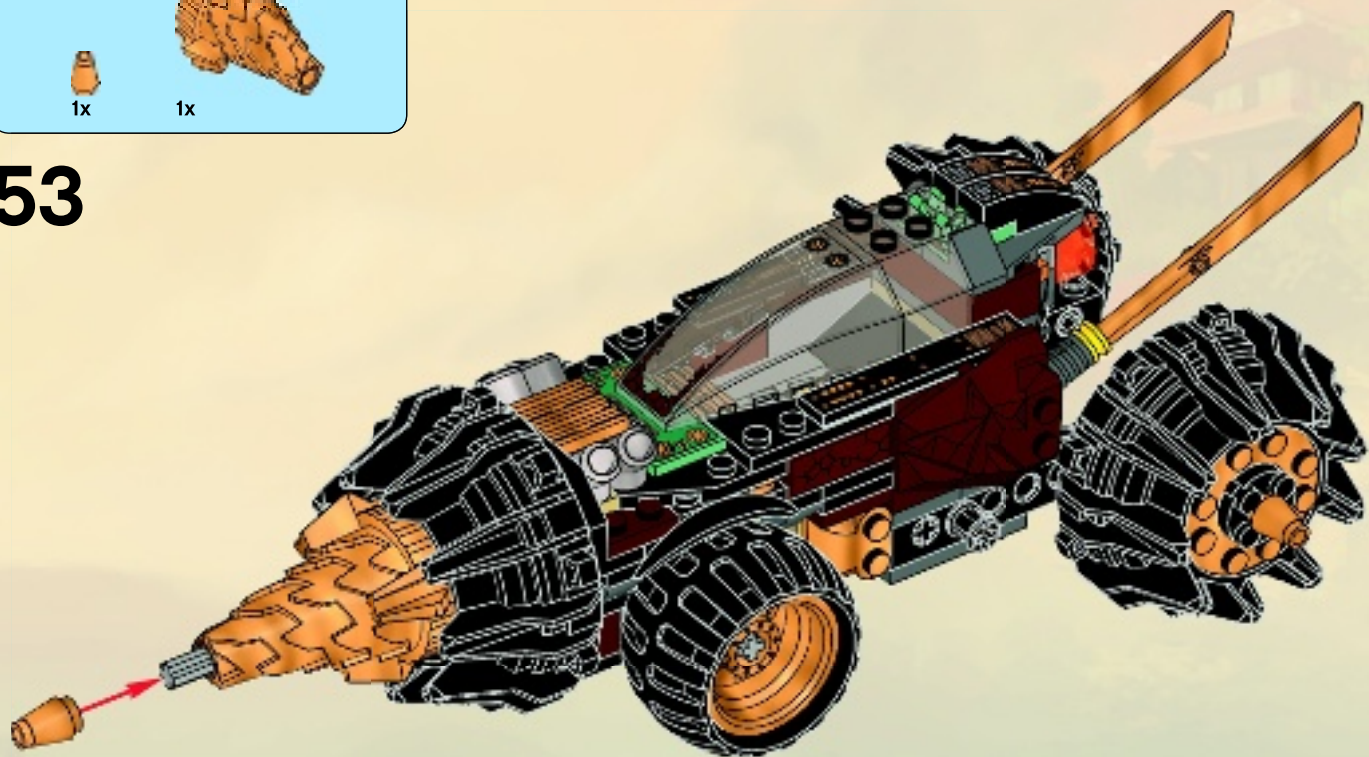





8x 614101
 1x 4159739
 1x 6031057
 2x 4113233
 2x 4278046
 1x 4565452
 1x 300321
 1x 6016173
 1x 6020757

4x 4227155
 1x 4513174
 2x 4143005
 2x 4233484
 1x 4611426
 3x 4239601
 2x 273026
 1x 329726
 2x 4251161

2x 4581280
 2x 302226
 2x 242026
 4x 371026
 2x 4183043
 2x 663626
 1x 4161332
 1x 4160869

2x 403226
 1x 4129572
 1x 658326
 1x 6019226
 1x 6020160
 1x 6018409
 1x 6017976
 1x 4114206

1x 6032095
 2x 4518826
 2x 4547625
 1x 4552347
 6x 4121715
 2x 4140801
 1x 370626
 1x 4177431

3x 4538782
 1x 611647
 1x 6022644
 7x 4177932
 1x 4598530
 2x 4267874
 2x 4521947

2x 4625236
 1x 4633693
 2x 4211220
 3x 4211201
 2x 4267994
 4x 4211152
 2x 4211247
 2x 6022902

6



2x
4211636



2x
4211374



2x
4640536



1x
4568637



1x
4211409



1x
4654582



2x
4558169



2x
4211655



1x
4211815



1x
4211639

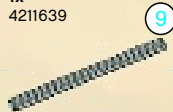

1x
4535768



1x
6000606



2x
4621917



2x
4210695



1x
4514558



1x
6018493



1x
4210869



1x
4210872



2x
4294180



2x
4508553

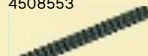

1x
4499858



1x
4210984



2x
4211002



1x
4211115



2x
4632100



6x
4523159



3x
4490599



3x
4529247



1x
4640843



2x
4286597



2x
6013297



2x
4646843



2x
4648531



1x
6018478



Customer Service

Kundenservice

Service Consommateurs

Servicio Al Consumidor

LEGO.com/service or dial



00800 5346 5555 :



1-800-422-5346 :



LEGO NINJAGO
Masters of Spinjitzu



70505

70504

70503

70502

70501

70500



WIN!

Go to www.LEGOsurvey.com/product to fill out a survey for a chance to win a cool LEGO® Product.

No purchase necessary.

Open to all residents where not prohibited.



www.LEGOsurvey.com/product

GEWINNE!

Nimm an der Umfrage auf www.LEGOsurvey.com/product teil und hab die Chance ein cooles LEGO® Produkt zu gewinnen!

Die Teilnahme am Gewinnspiel führt zu keinerlei Kaufverpflichtungen. Teilnahme in allen nicht ausgeschlossenen Ländern möglich.

WIN!

Ga naar www.LEGOsurvey.com/product, vul een enquêteformulier in en maak kans op een cool LEGO® product.

Geen aankoopverplichting. Iedereen mag deelnemen, uitgezonderd ingezetenden van landen waar een enquêteverbod geldt.

GAGNE!

Visite www.LEGOsurvey.com/product pour répondre à un questionnaire et avoir une chance de gagner un produit LEGO® très cool!

Aucune obligation d'achat. Ouvert à tous les résidents des pays autorisés.

当てよう!

www.LEGOsurvey.com/product にアクセスして、アンケートにご記入ください。当選者にはレゴ®製品を差し上げます。

お買い上げの必要はありません。禁止されていない限り、すべての皆様にご利用いただけます。



LEGO.com

6034827

LEGO and the LEGO logo are trademarks of the/son des marques de commerce de/son marcas registradas de LEGO Group. ©2013 The LEGO Group.