

The LEGO logo is displayed in its characteristic white font with a black outline, set against a red square background.

Kingdoms

The Kingdoms crest features a shield with a red and white vertical design and a golden lion rampant, flanked by two crossed golden swords.

7189



WARNING: CHOKING HAZARD.
Toy contains small parts and a small ball.
Not for children under 3 years.



AVERTISSEMENT : RISQUE D'ÉTOUFFEMENT.
Le jouet contient des petites pièces ainsi qu'une petite boule.
Il ne convient pas aux enfants de moins de 3 ans.



ADVERTENCIA: PELIGRO DE ASFIXIA.
Juguete que contiene partes pequeñas y una pelota pequeña.
No recomendado para niños menores de 3 años.

1

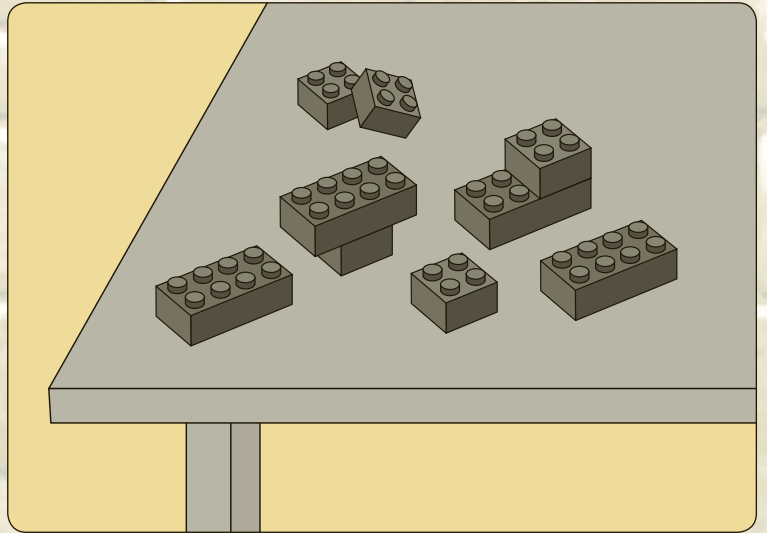
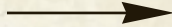
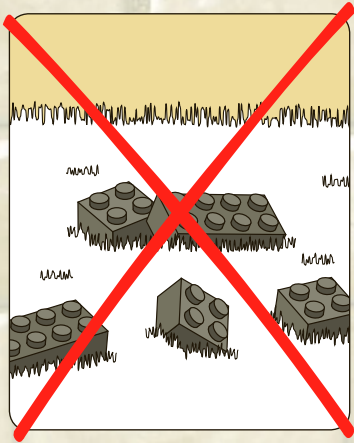

2



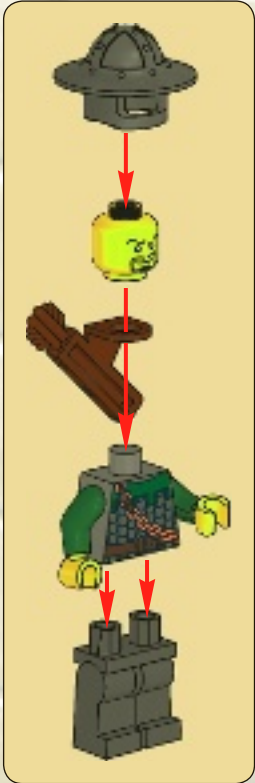

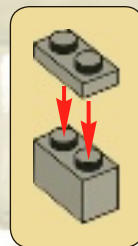

1

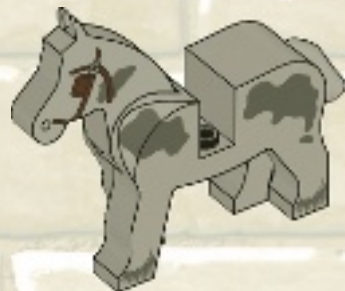

2



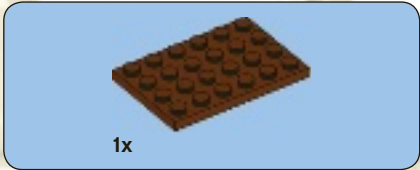

1

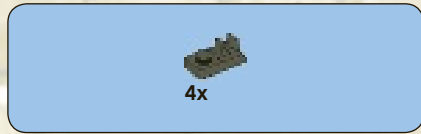

2

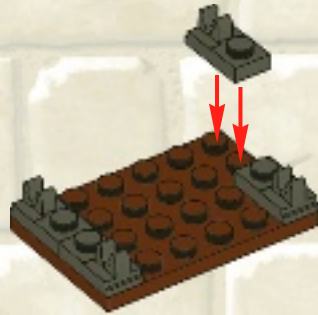



3



4

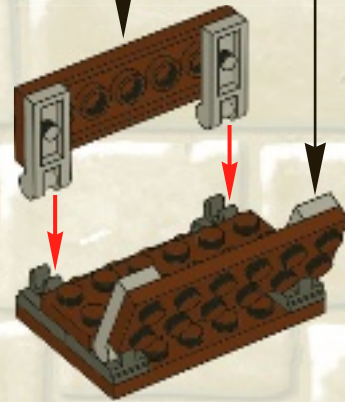
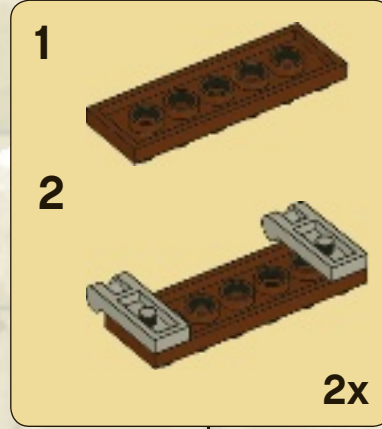

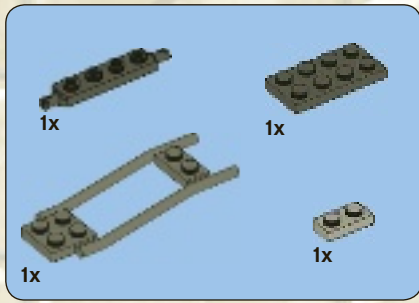

5

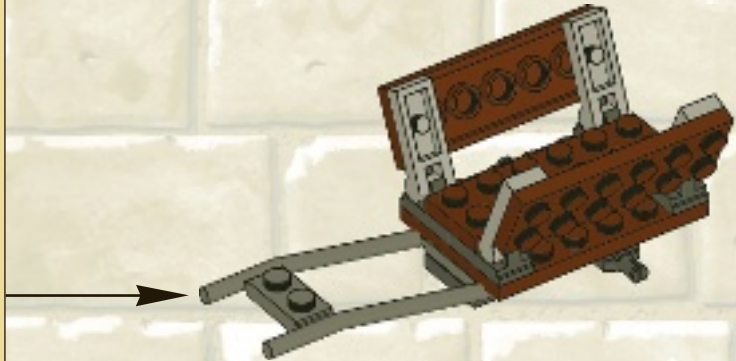
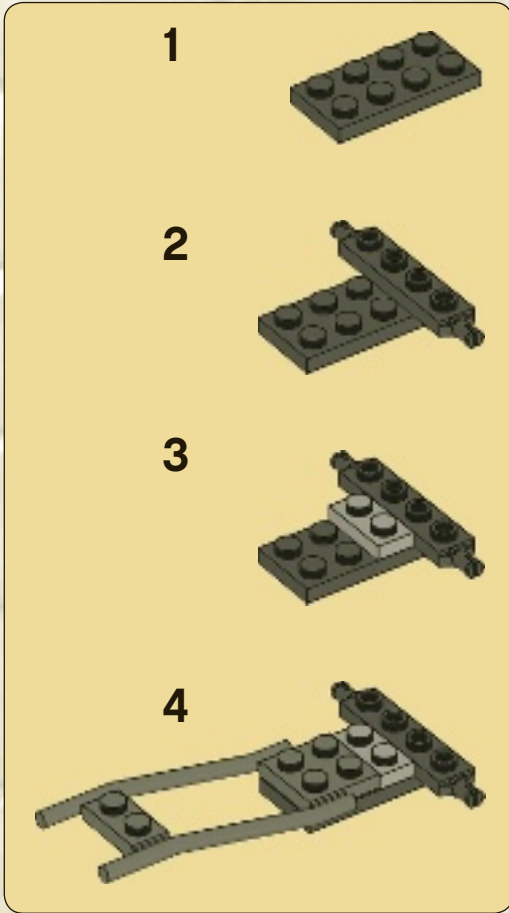

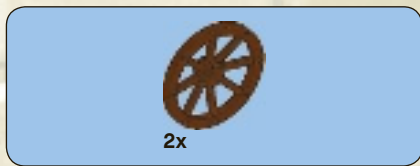

6

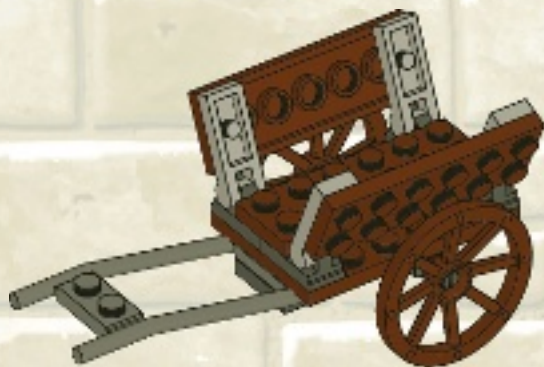

7

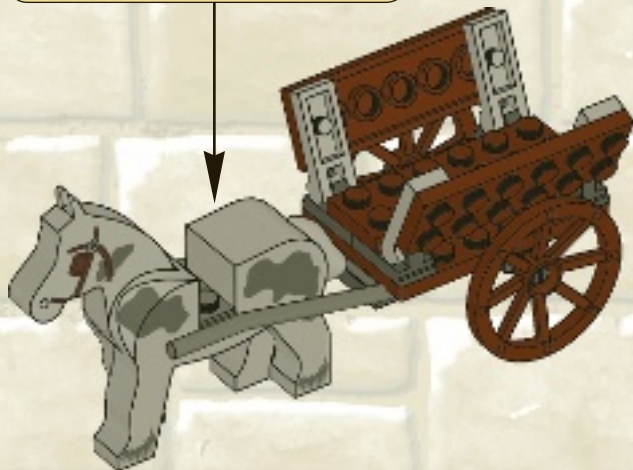
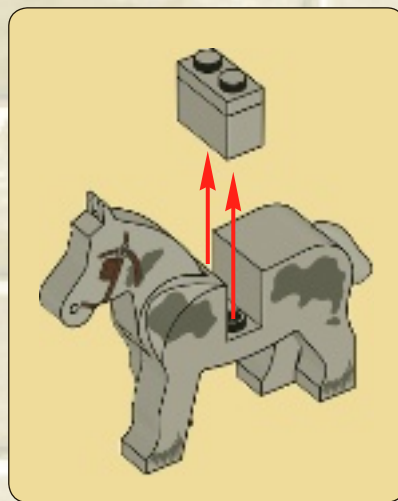

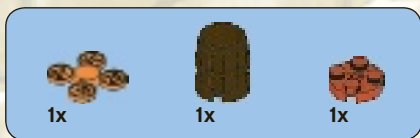

8

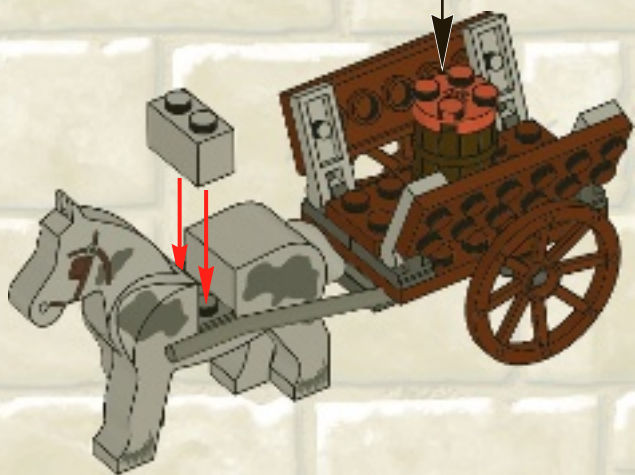
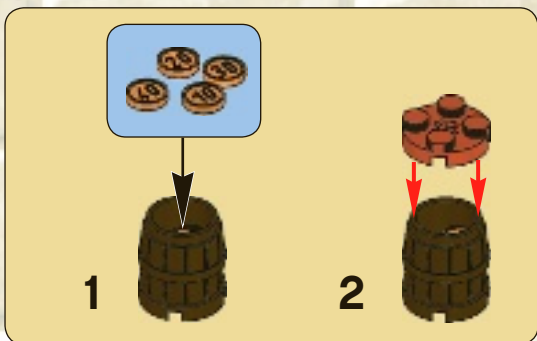

9

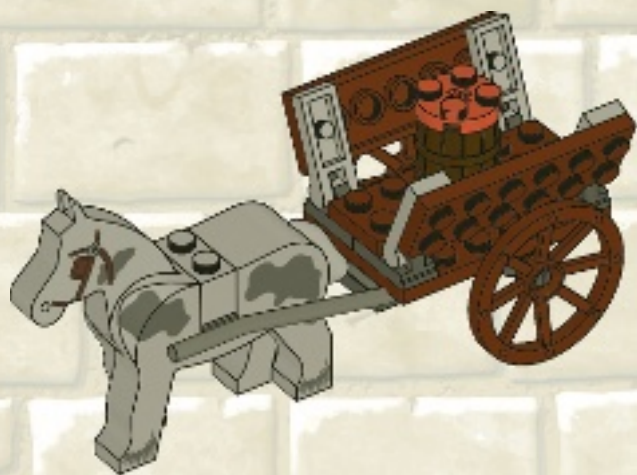

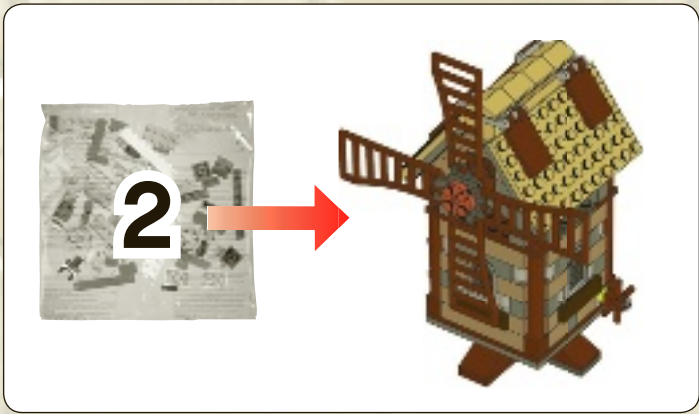

1

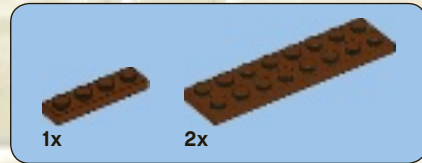

2





1x

3

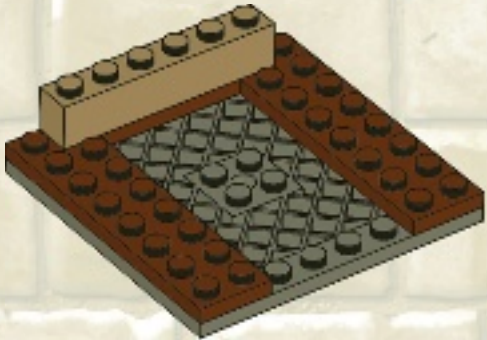

1x



2x

4

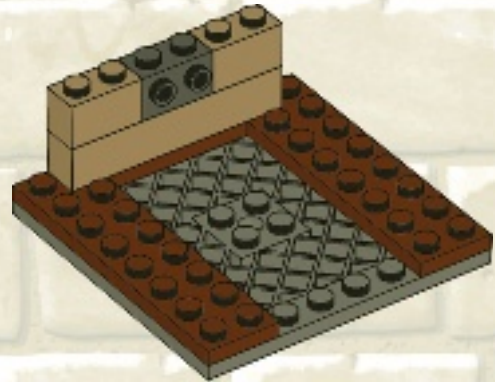



2x



2x

5



1x



1x

6





2x

7

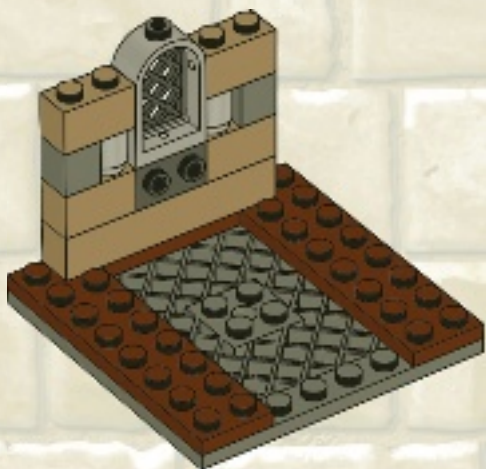

1x



2x

8



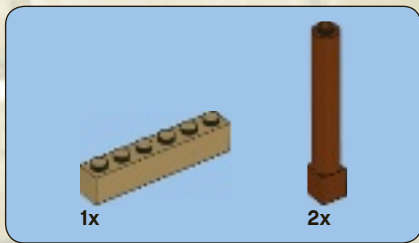

9

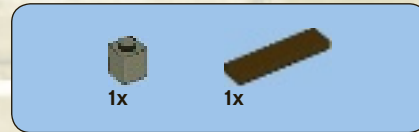
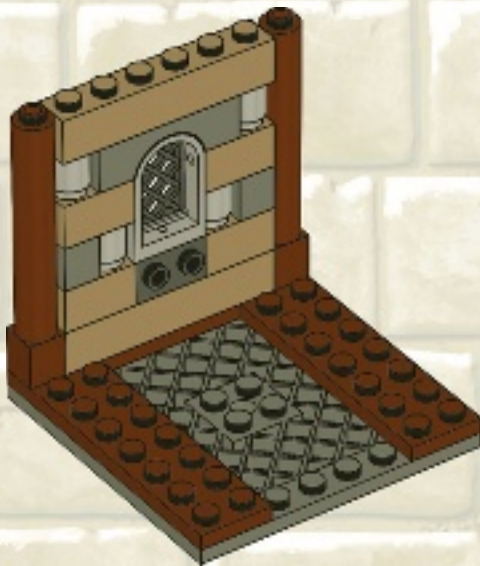

10

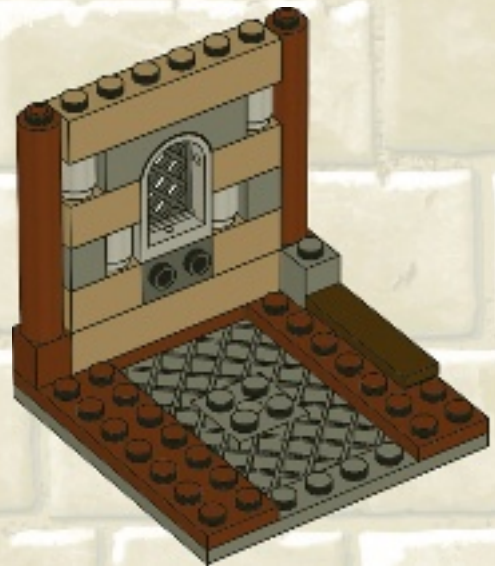



1x



2x

11

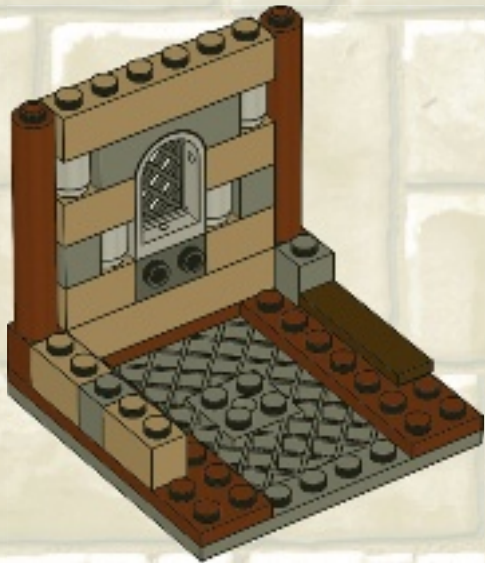

1x



1x



1x



2x

12

1



2



3



5

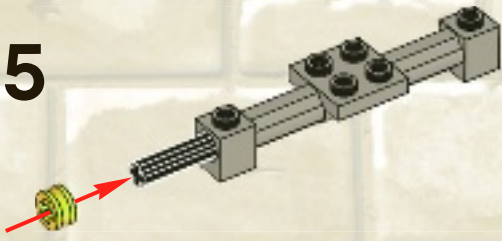

6

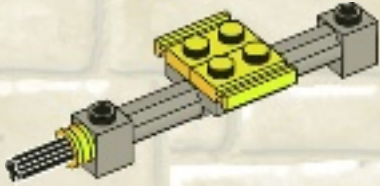

7

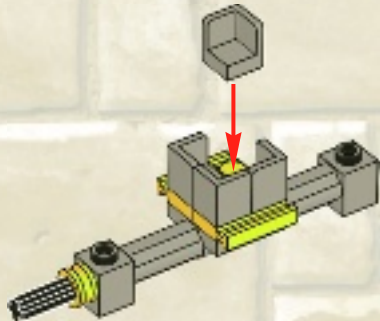

8

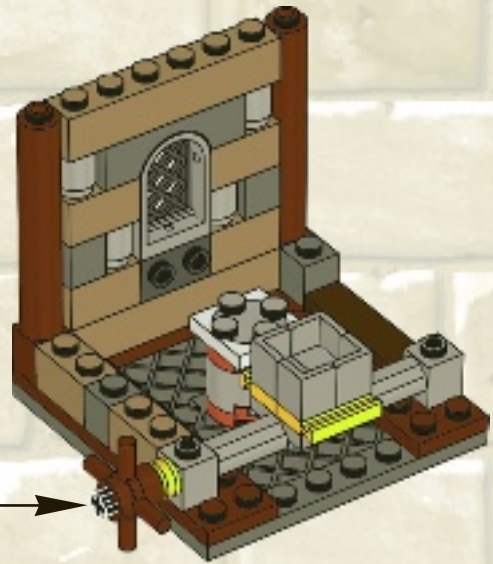
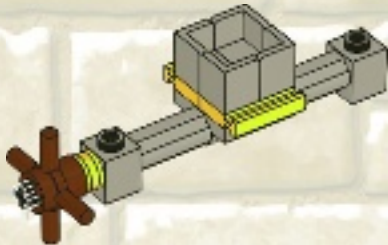

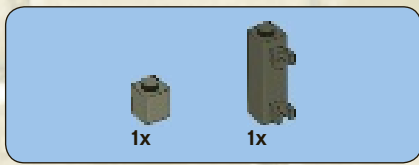

14

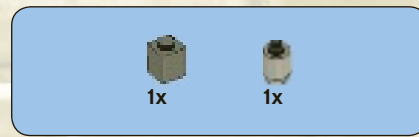
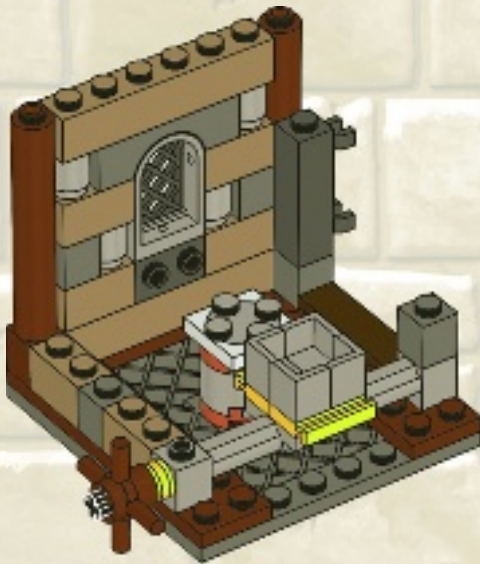

15

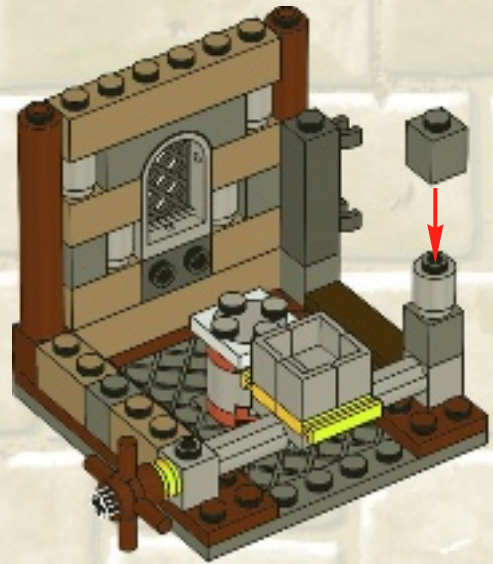

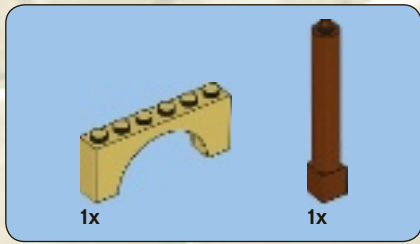

16

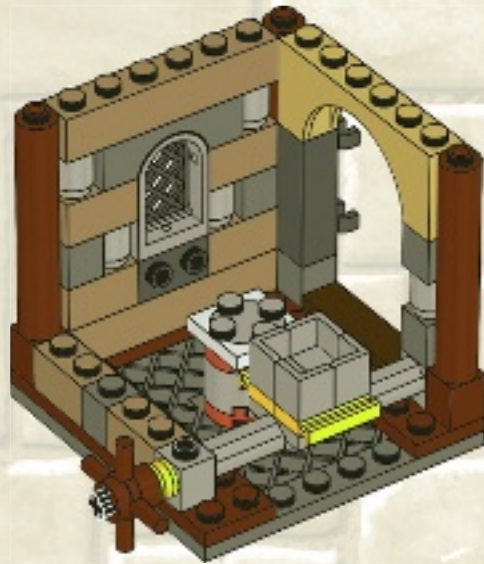

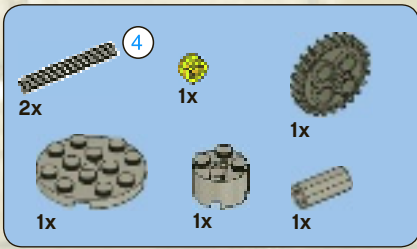

17

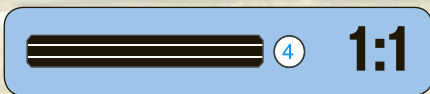
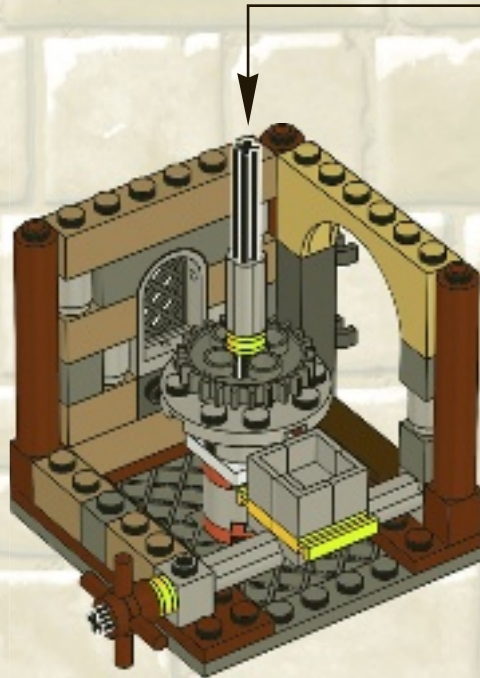
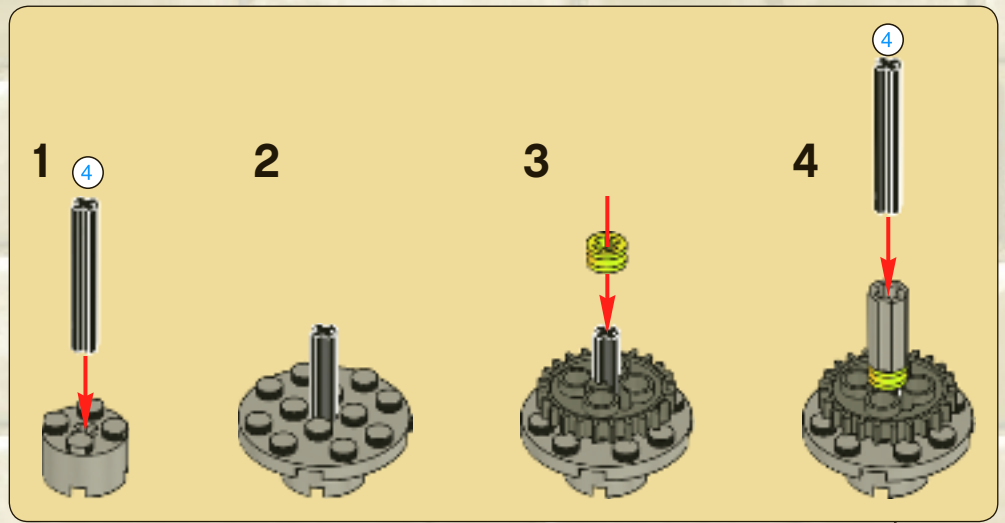



1x



2x

18

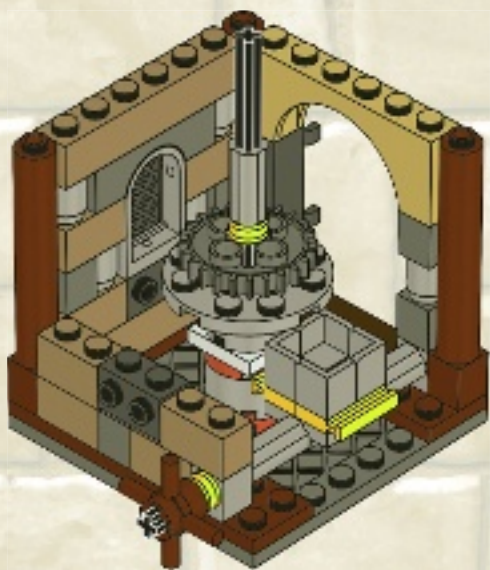

2x



2x

19

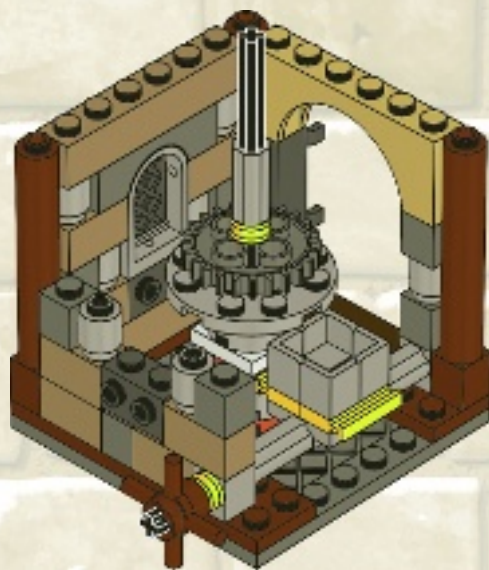



1x



1x

20

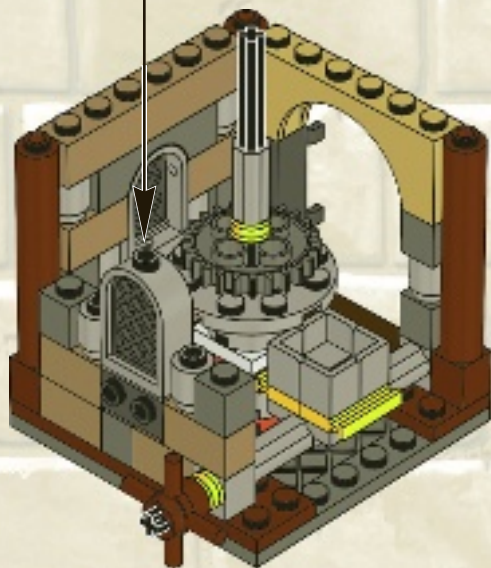
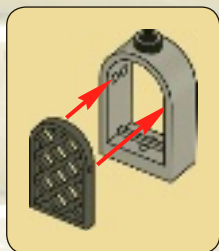

2x

21

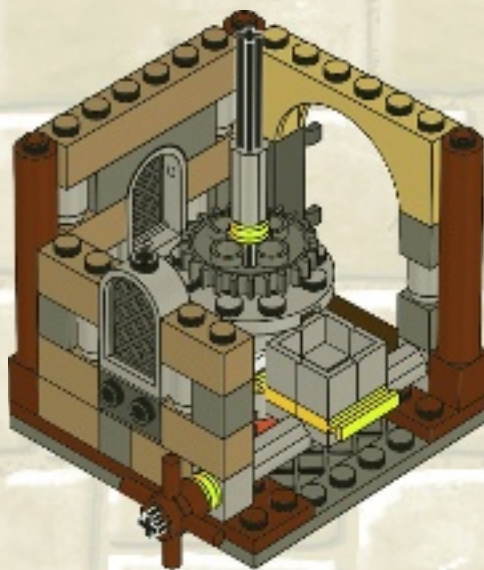



22

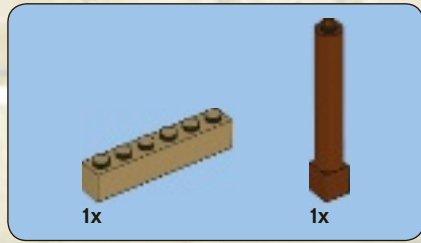
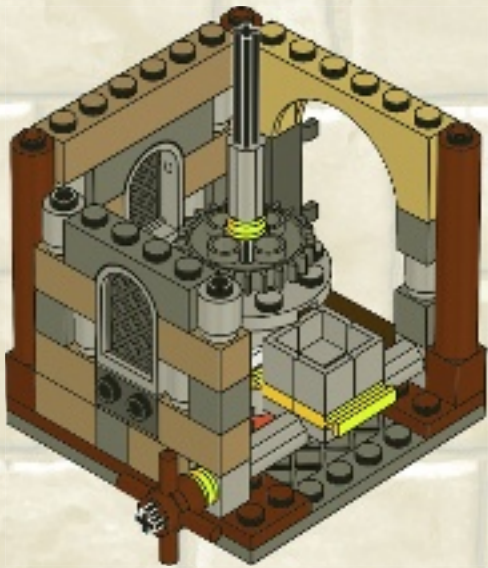

23

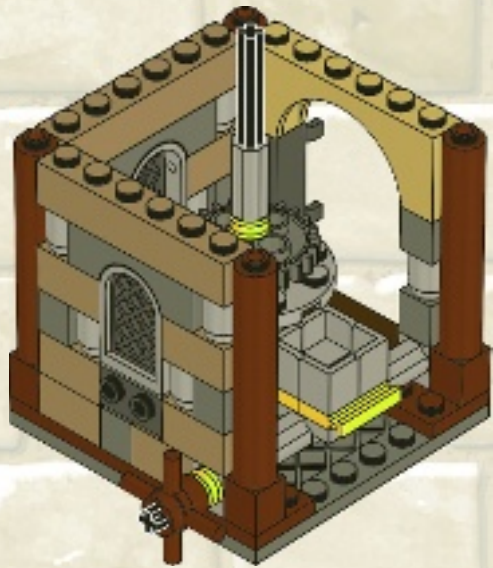

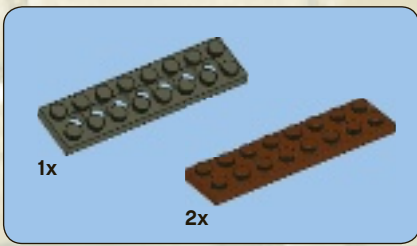

24

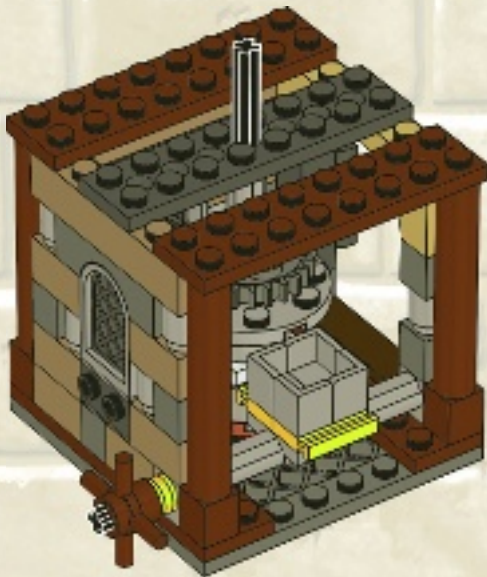

25

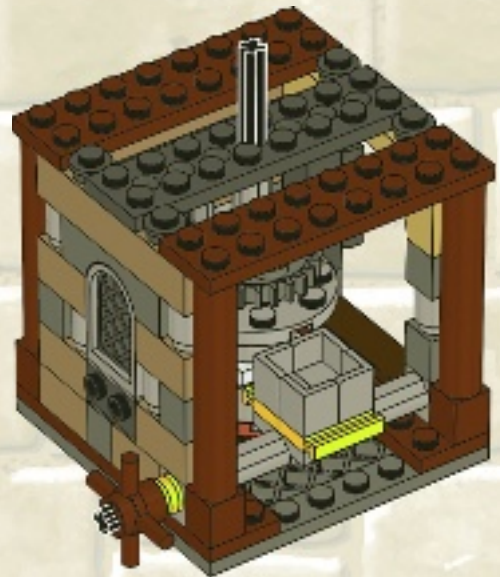



1x



1x

26

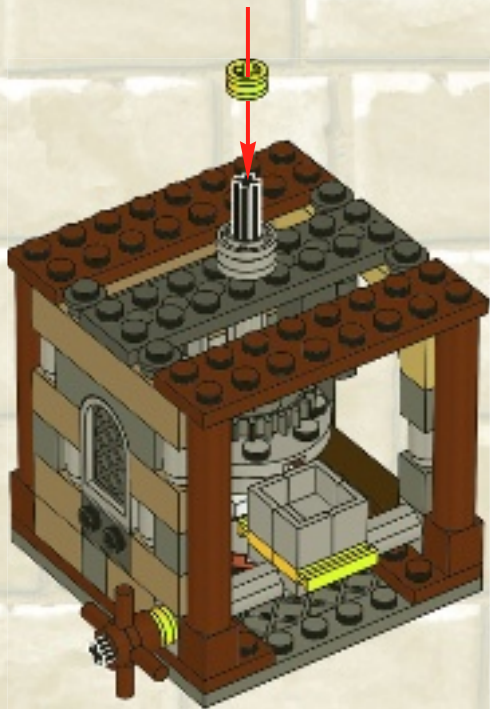

4x

27

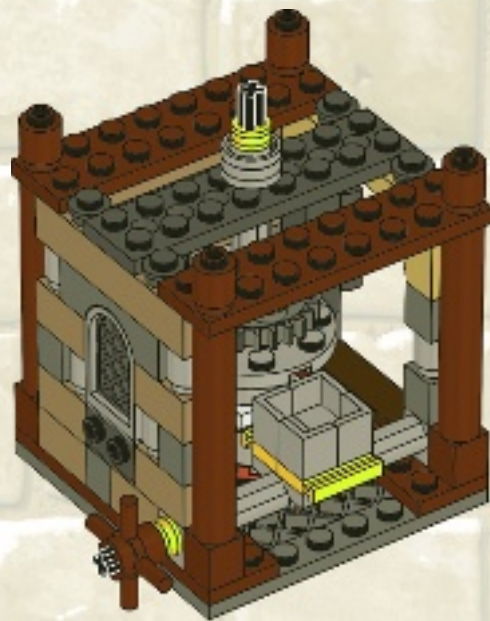



6x

28

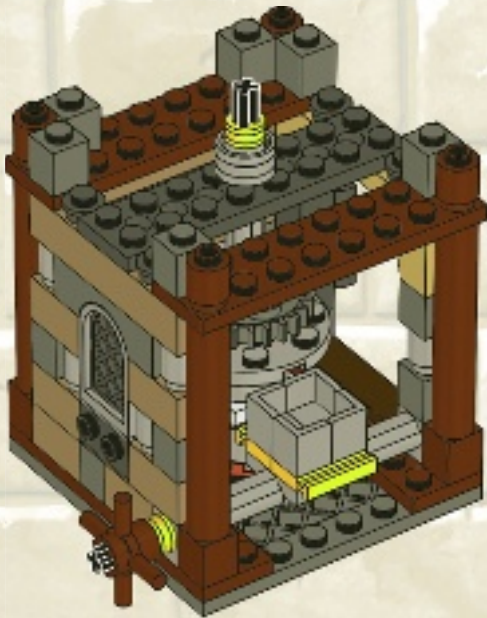

1x

29

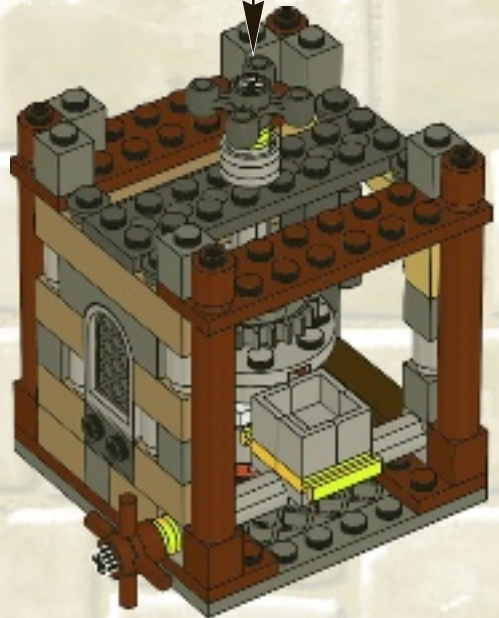



4x

30

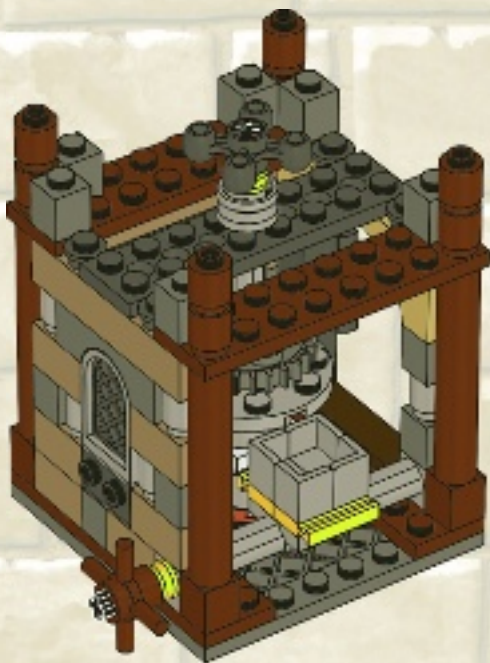

3x

31

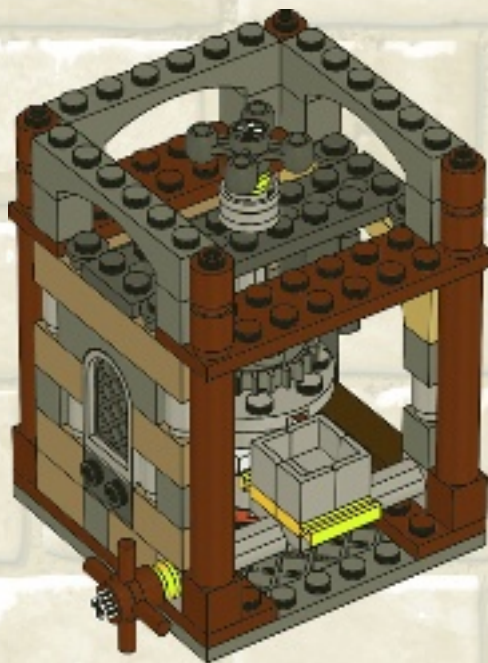

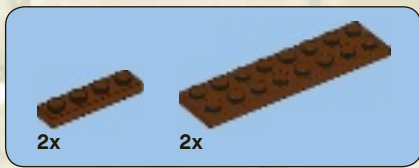

32

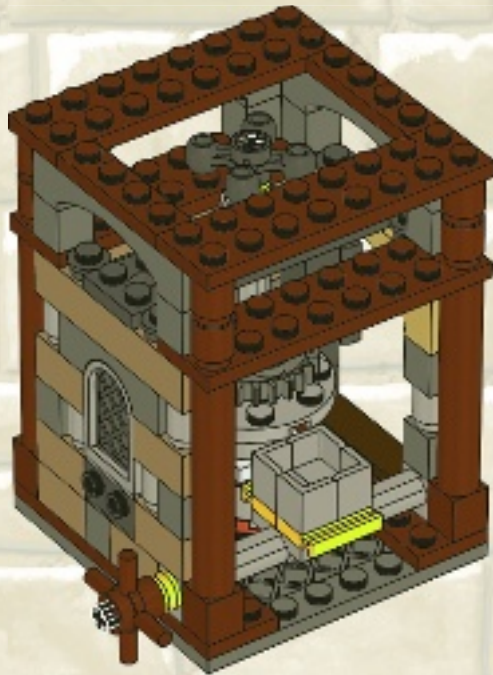



1

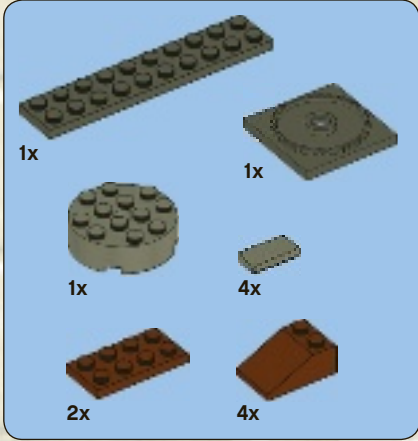

2



33

3



4

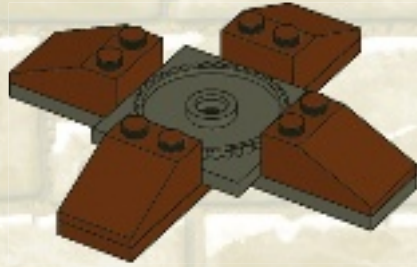
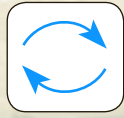

5



6



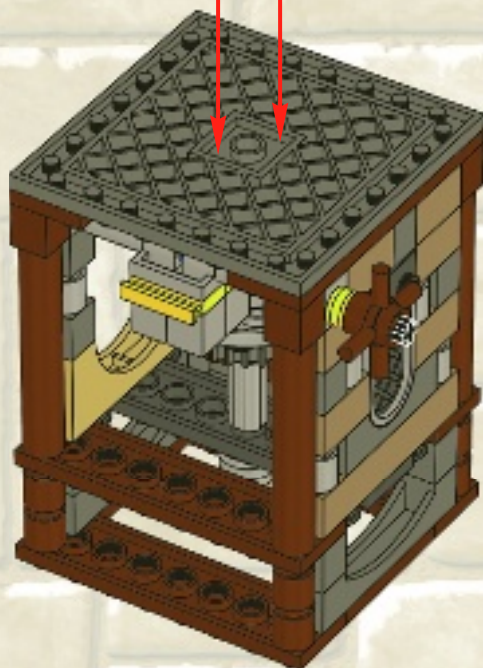
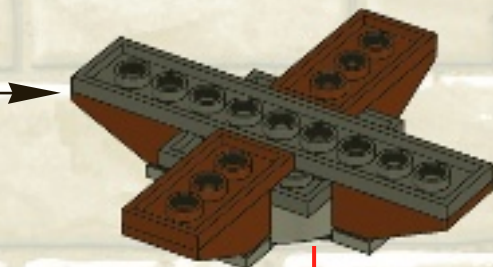

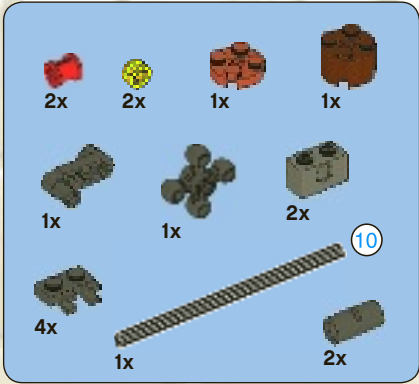

34

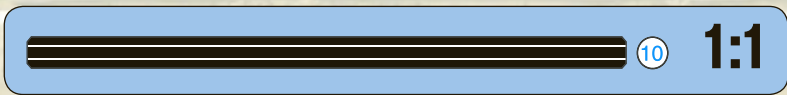

5



6

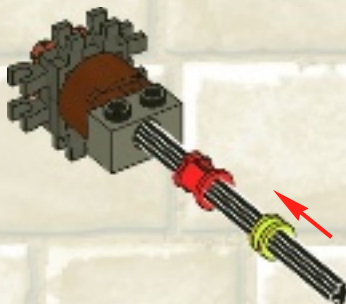

7

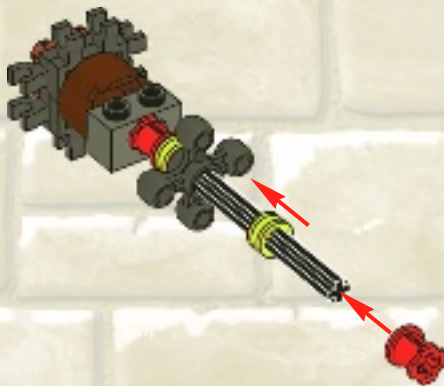

8

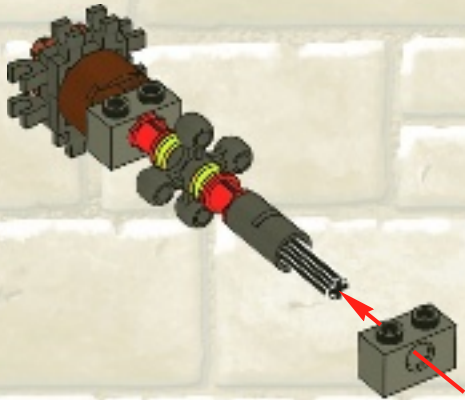

9

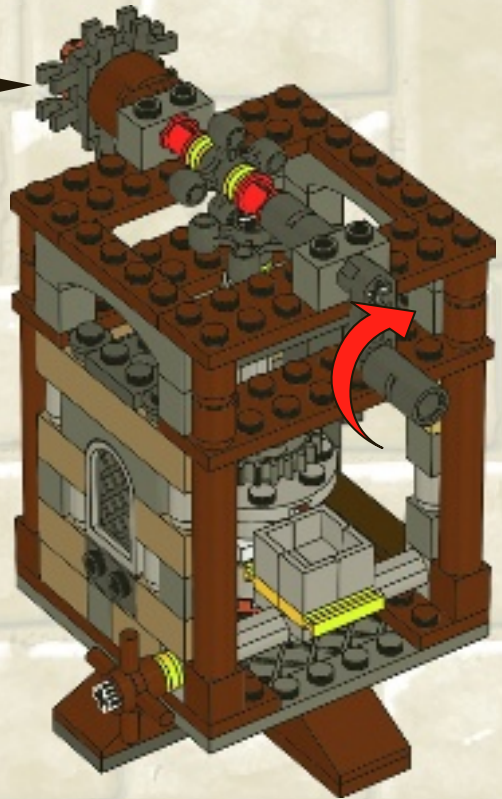
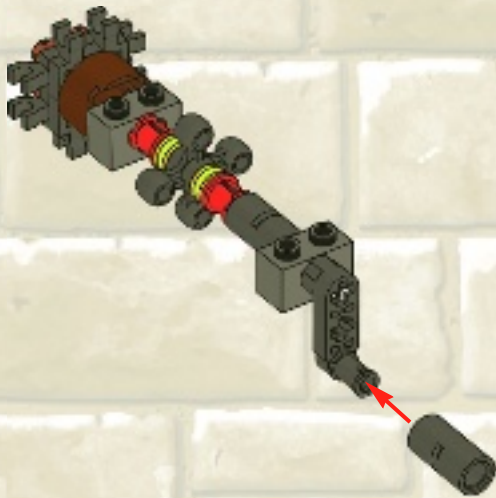



4x



4x

35

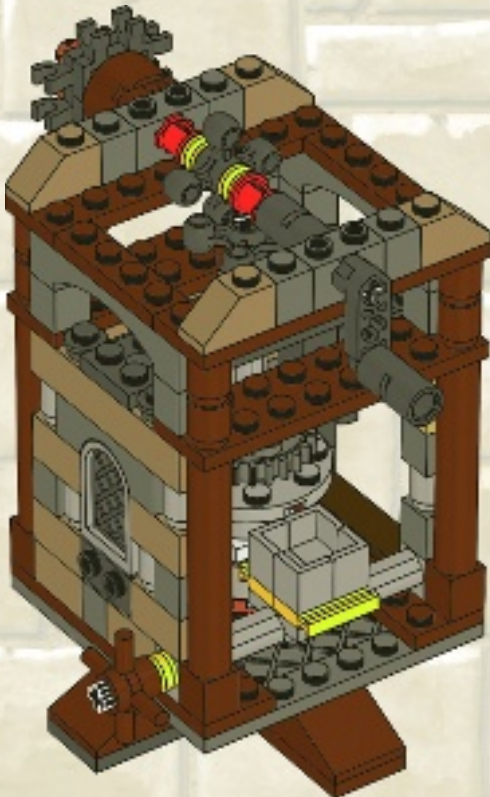

2x



4x

36

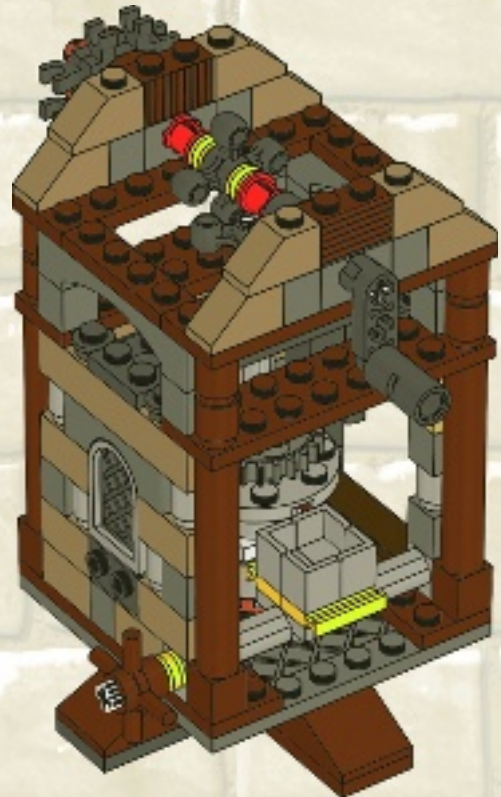



4x

37

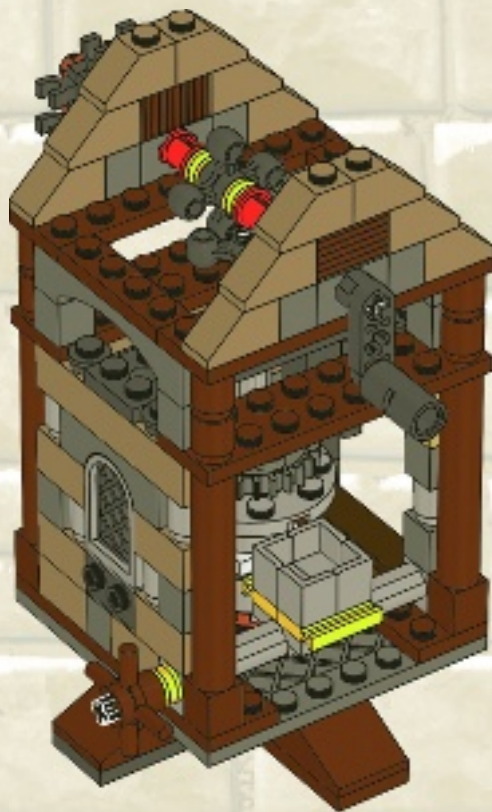

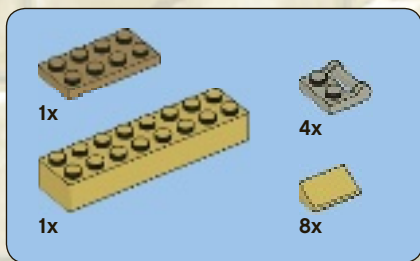

38

1

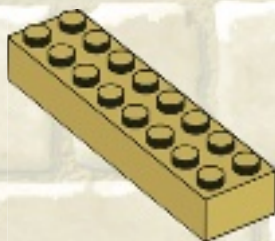

2

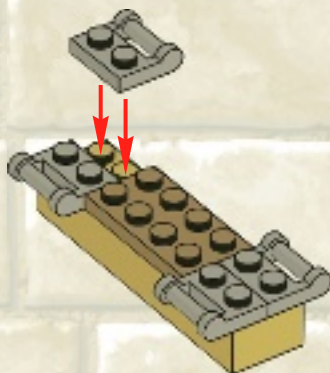

3

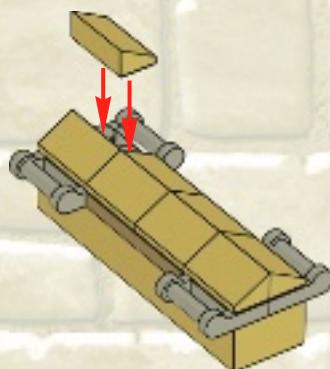

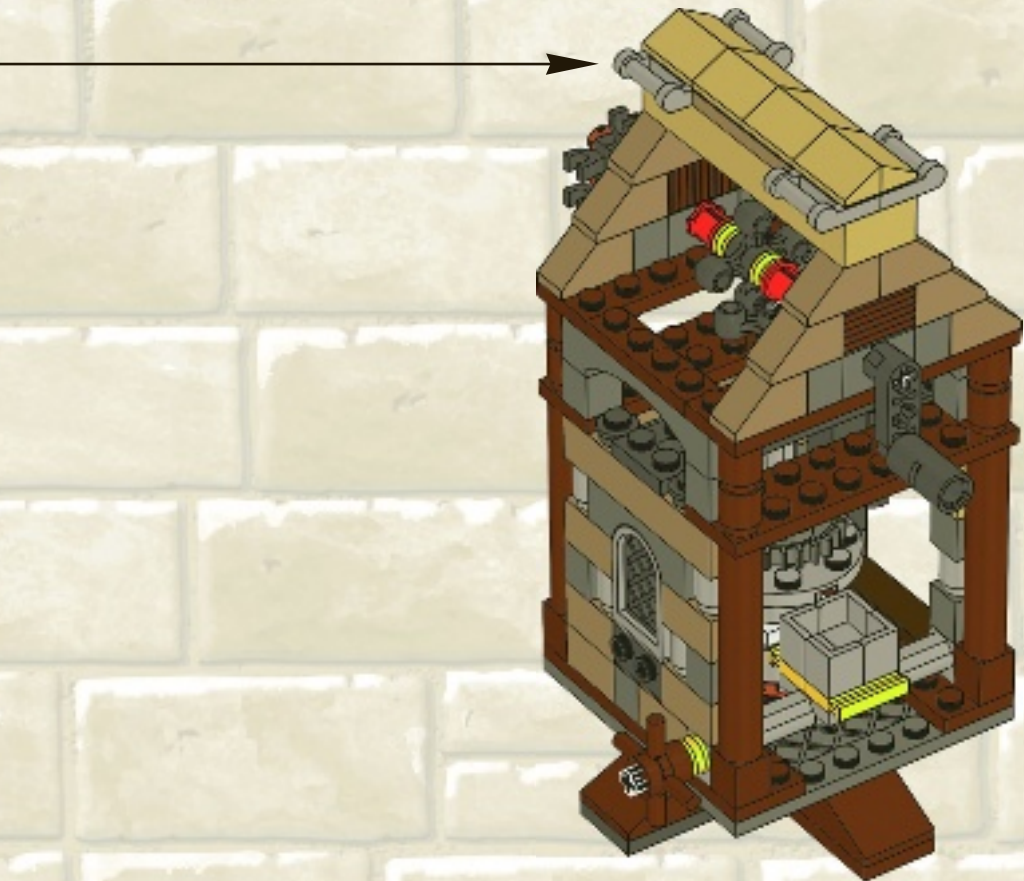

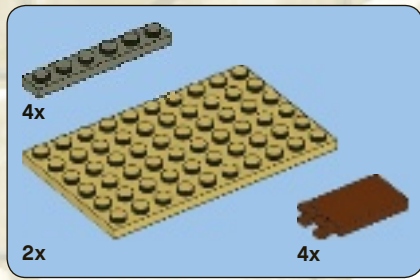

39

1



2

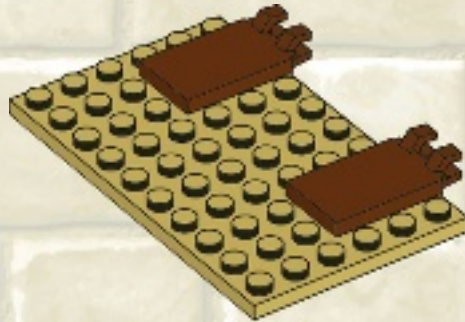

3

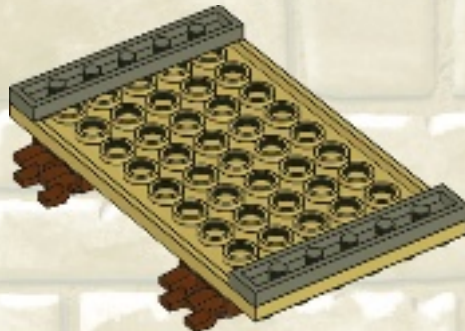
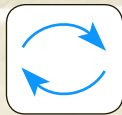

2x

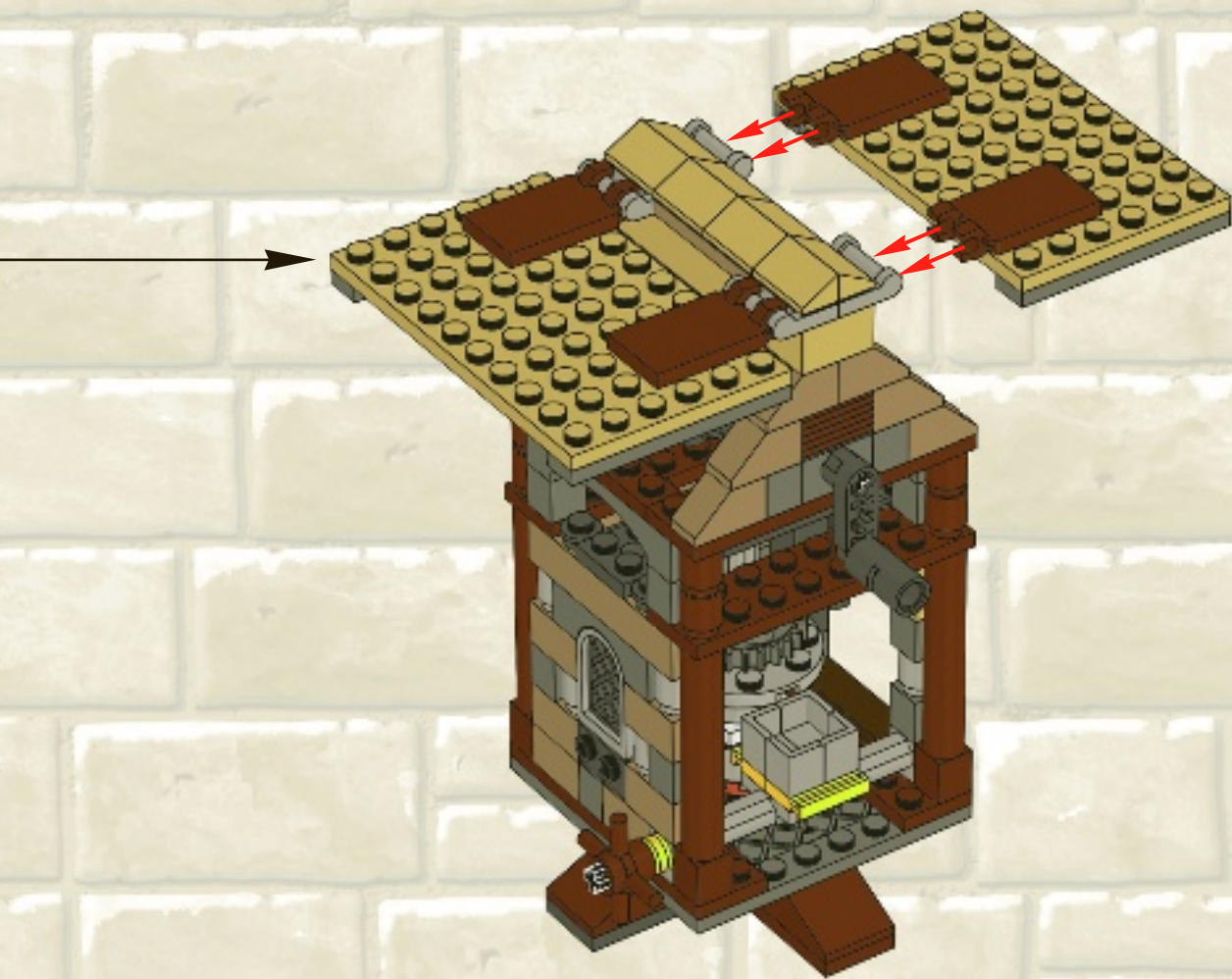

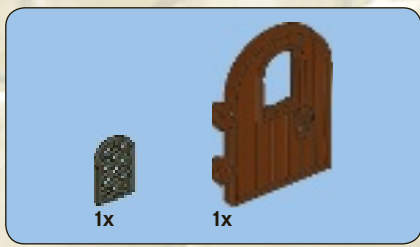

40

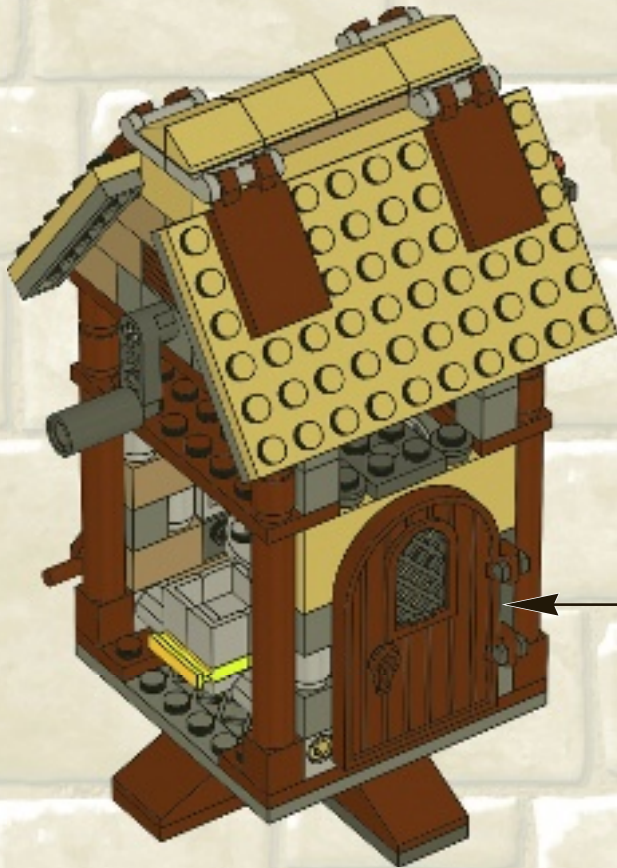

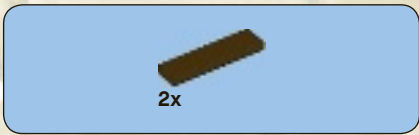

41

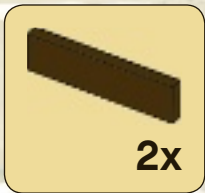



4x

42

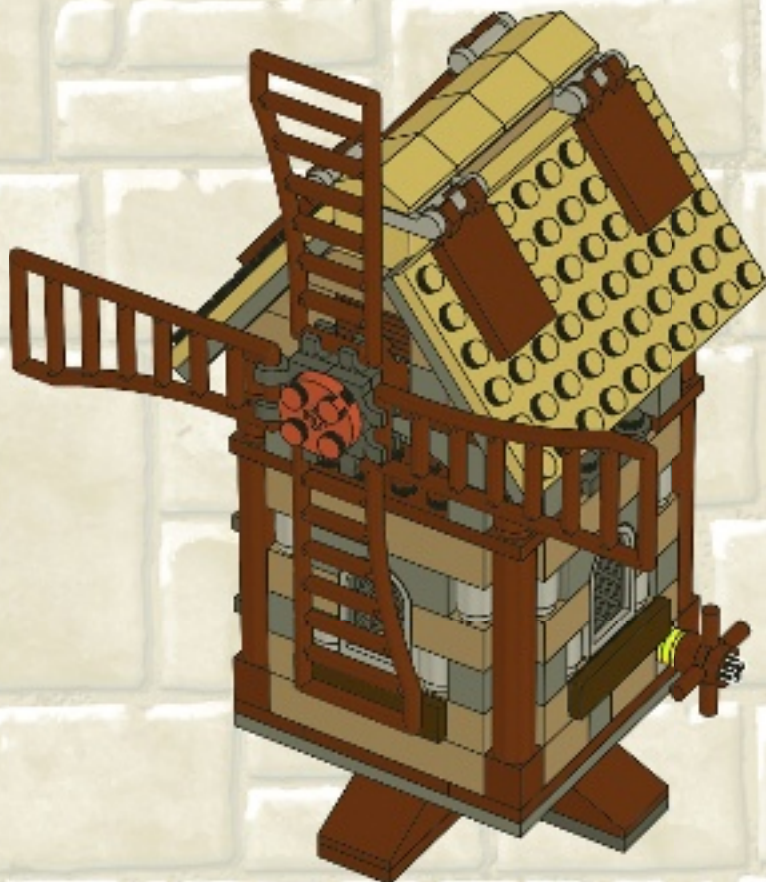

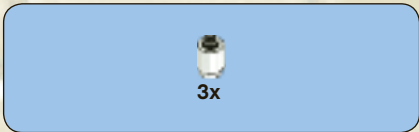

43

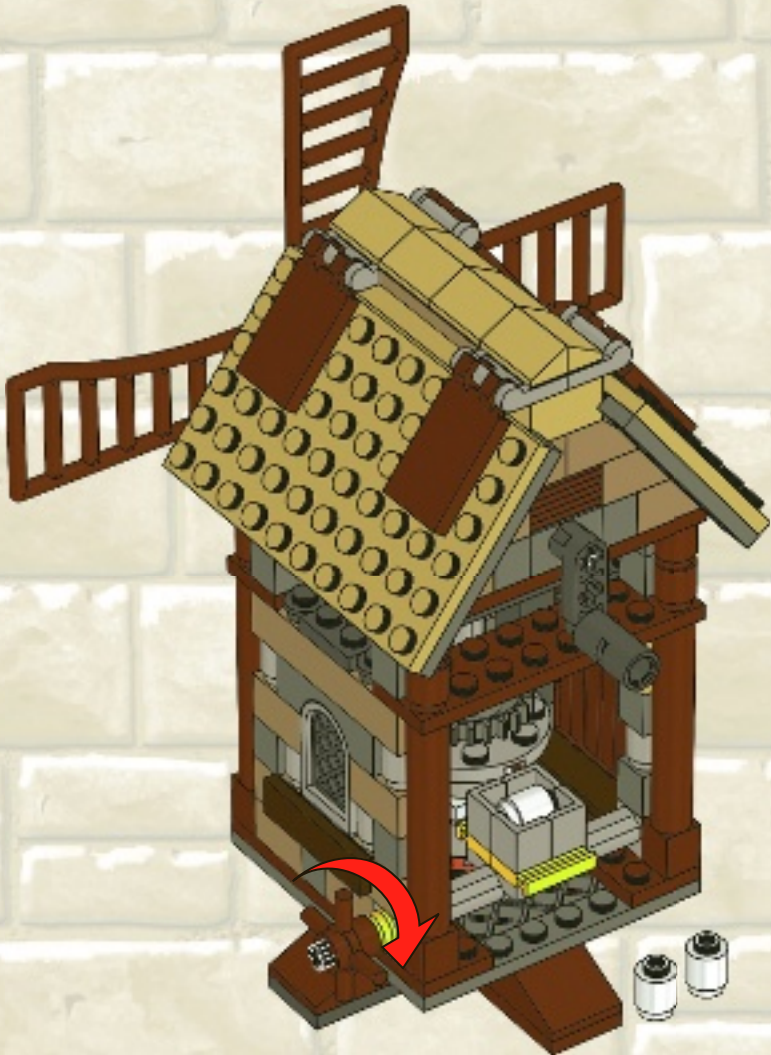



Kingdoms



7187

6918



7188





WIN!

Go to www.LEGOsurvey.com/product
to fill out a survey for a chance
to win a cool LEGO® Product.

No purchase necessary.

Open to all residents where not prohibited.

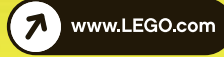

www.LEGOsurvey.com/product

GEWINNE! WIN!

Nimm an der Umfrage auf
www.LEGOsurvey.com/product
teil und hab die Chance ein cooles
LEGO® Produkt zu gewinnen!

Die Teilnahme am Gewinnspiel führt zu keinerlei
Kaufverpflichtungen. Teilnahme in allen nicht
ausgeschlossenen Ländern möglich.

Ga naar www.LEGOsurvey.com/product,
vul een enquêteformulier
in en maak kans op een
cool LEGO® product.

Geen aankoopverplichting.
Iedereen mag deelnemen, uitgezonderd
ingezetenden van landen waar een
enquêteverbod geldt.

GAGNE! 当てよう!

Visite www.LEGOsurvey.com/product
pour répondre à un
questionnaire et avoir une chance de
gagner un produit LEGO® très cool!

Aucune obligation d'achat.
Ouvert à tous les résidents des pays
autorisés.

www.LEGOsurvey.com/product にアクセスして、
アンケートにご記入ください。当選者にはレゴ®
製品を差し上げます。

お買い上げの必要はありません。

禁止されていない限り、すべての皆様にご利用いただけます。