



INDIANA JONES™

7198



LAST CRUSADE™

1

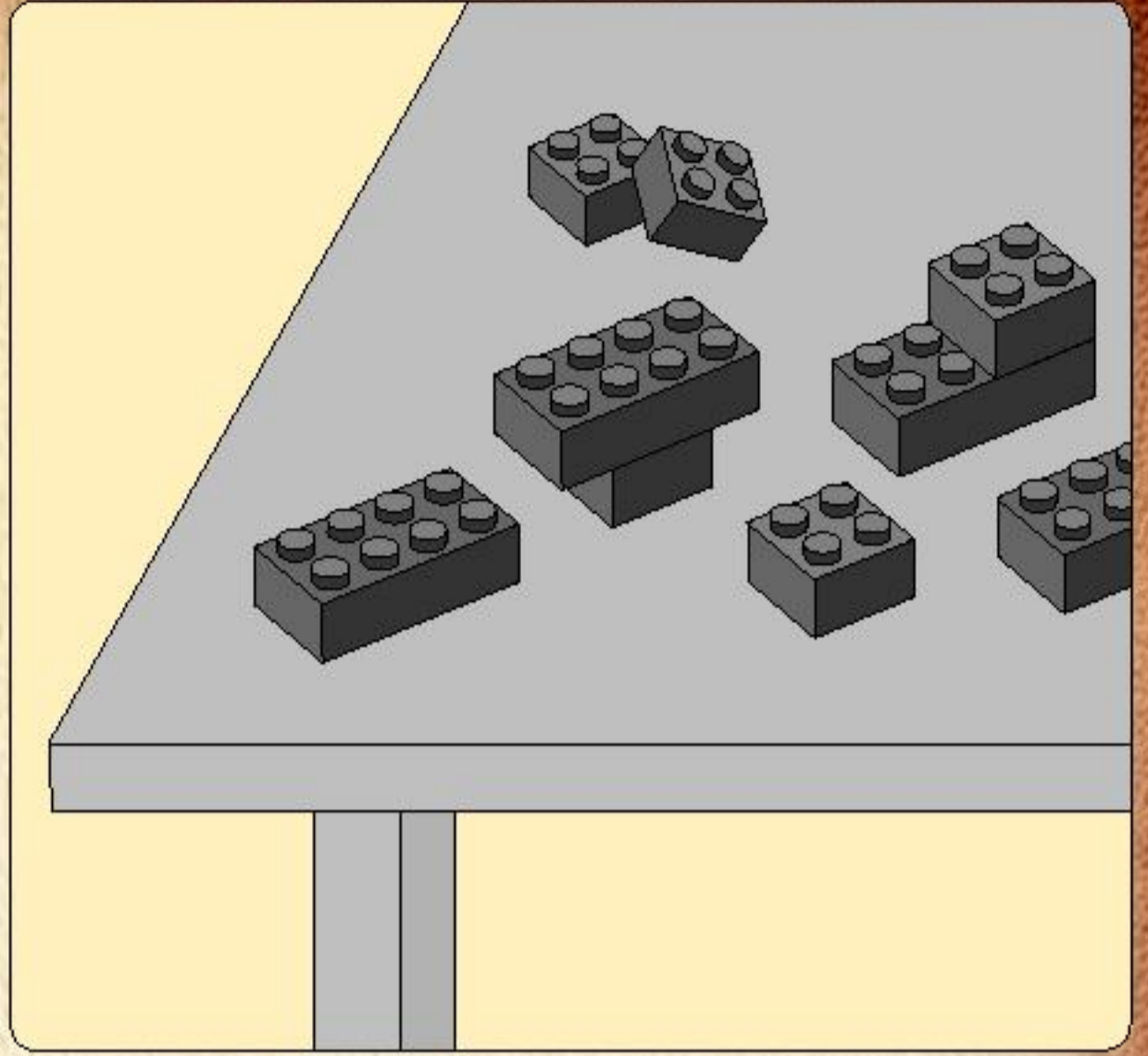
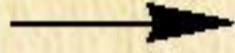
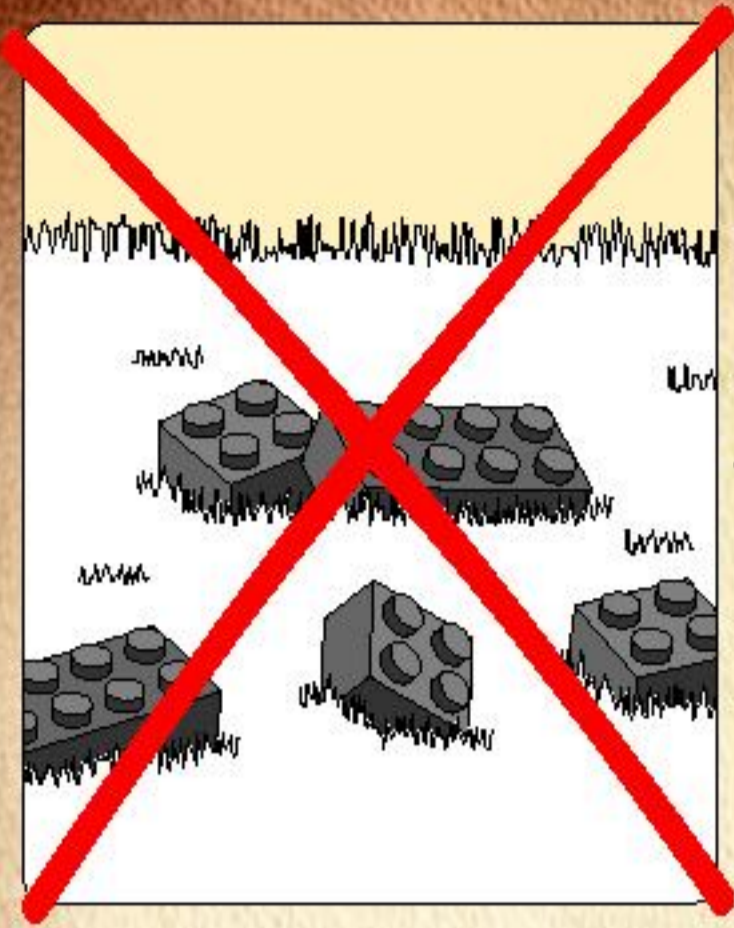

2

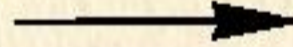

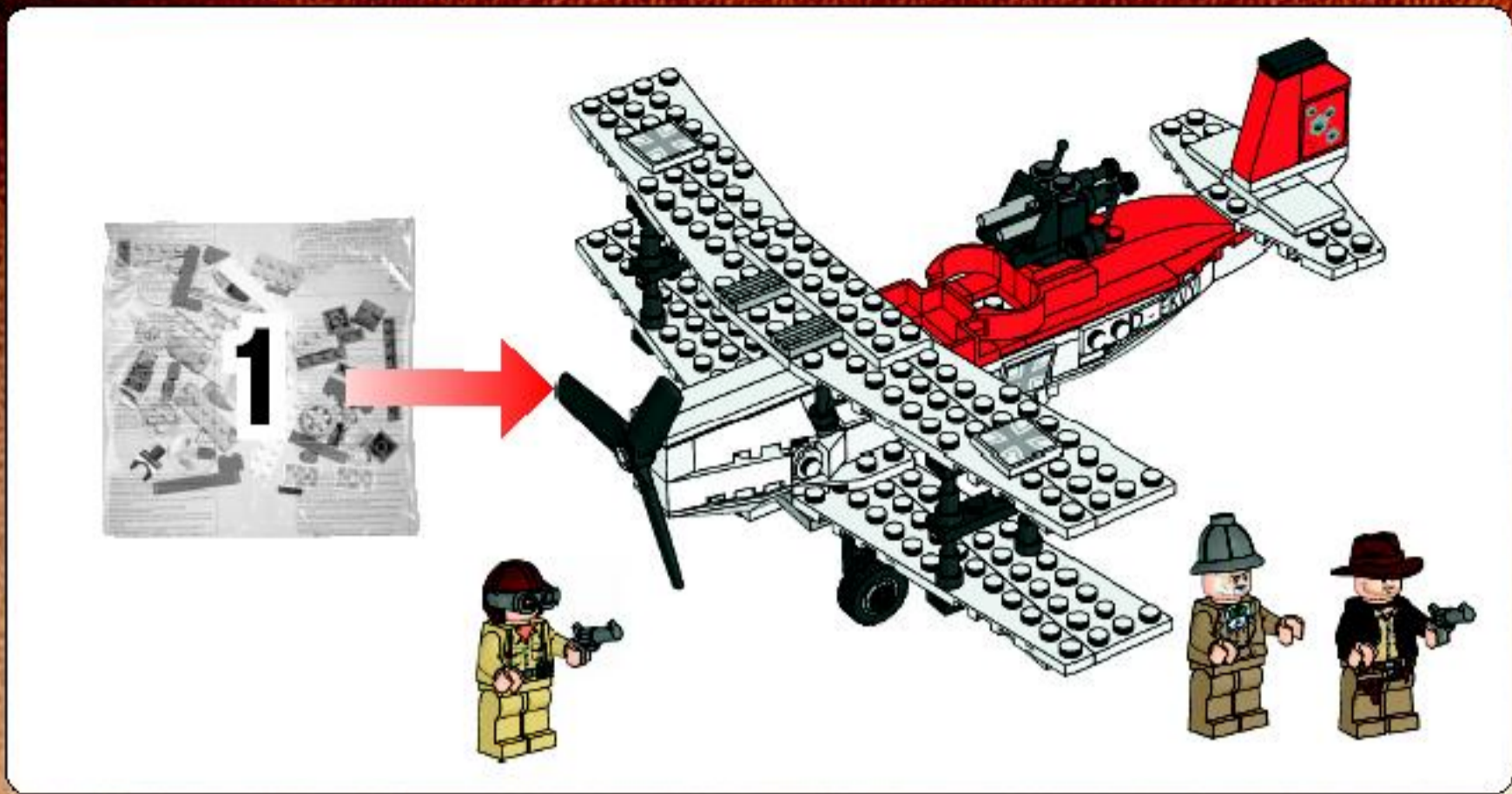

3

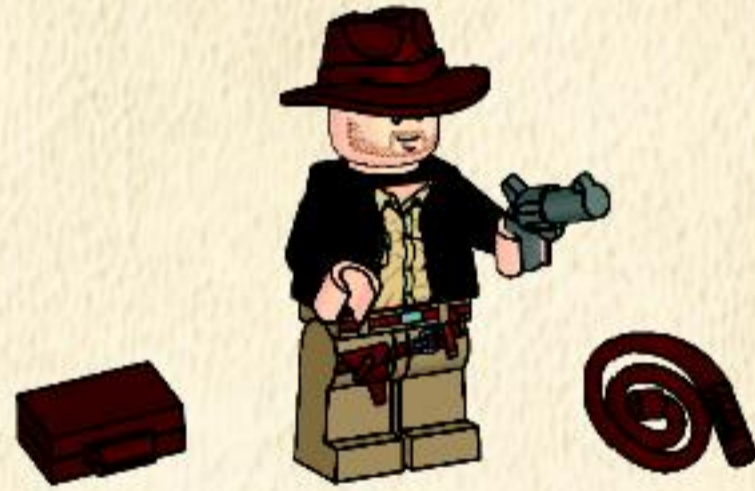
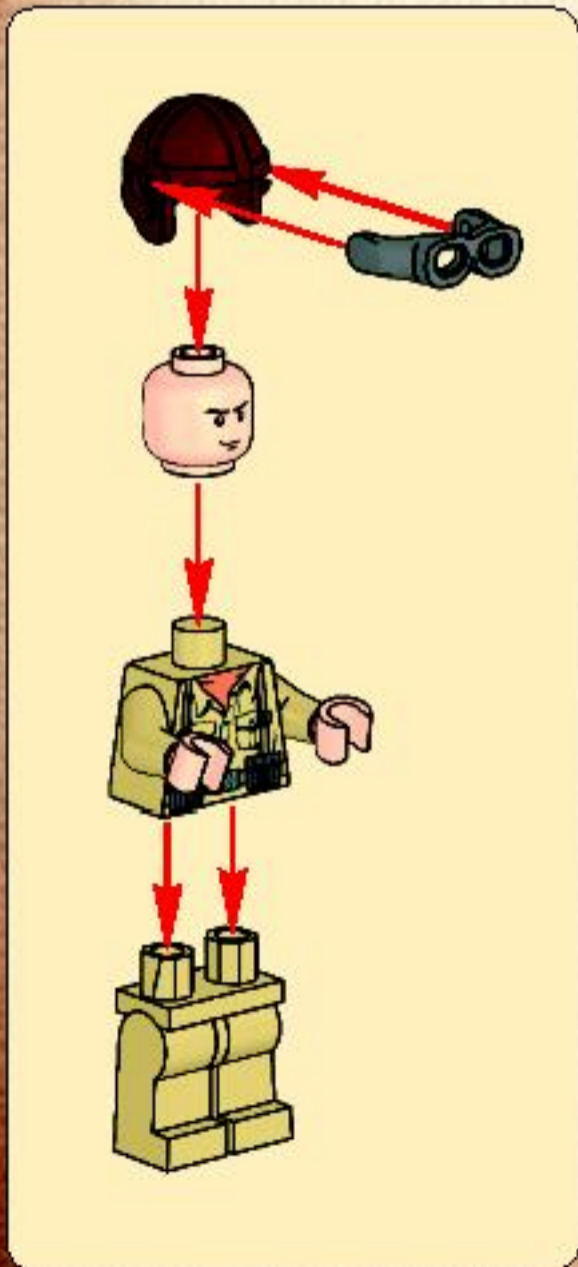

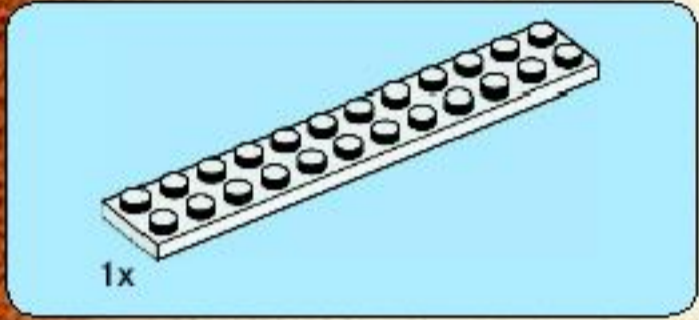
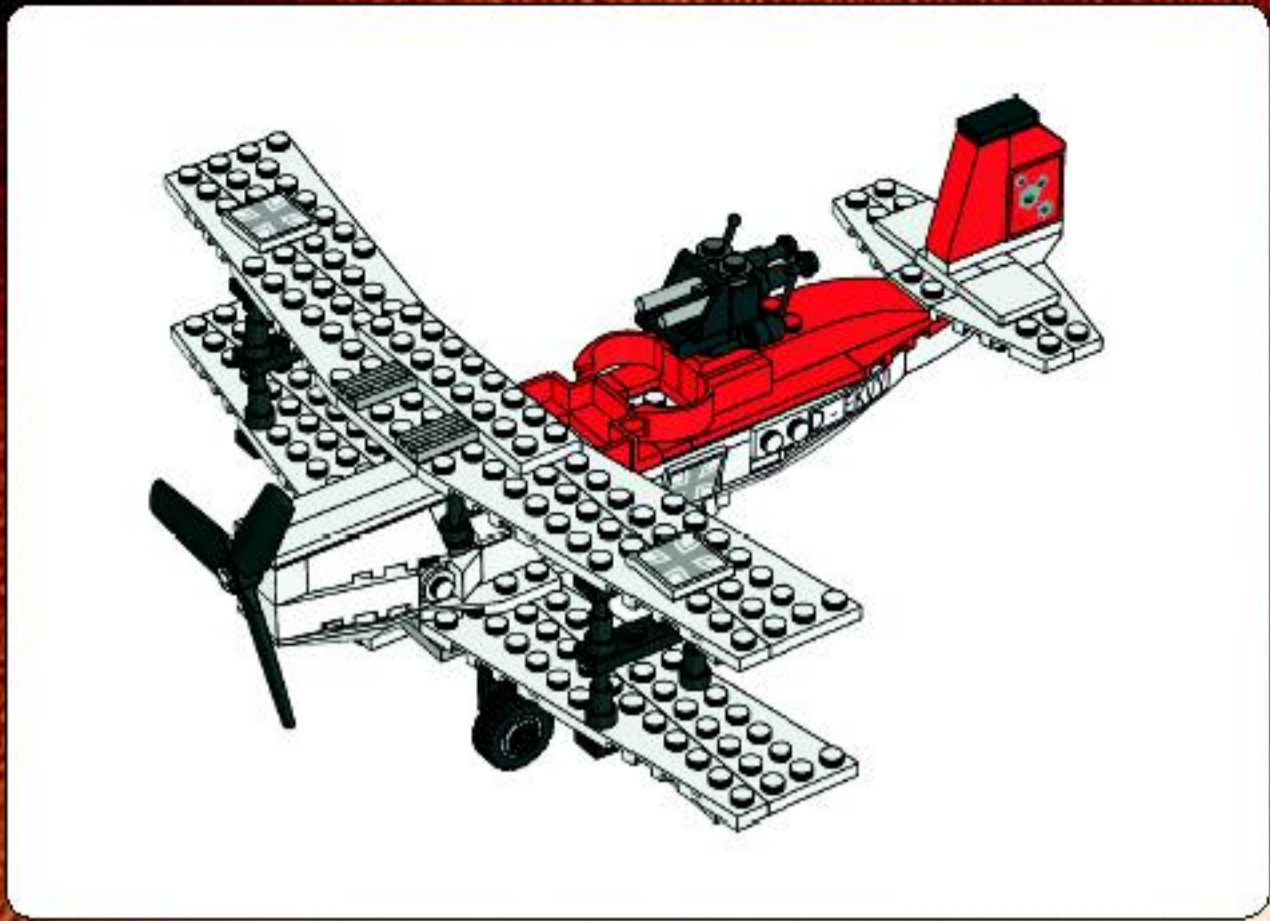

1

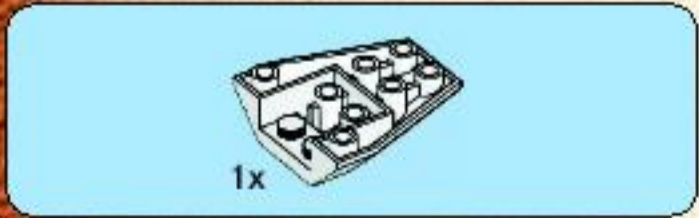
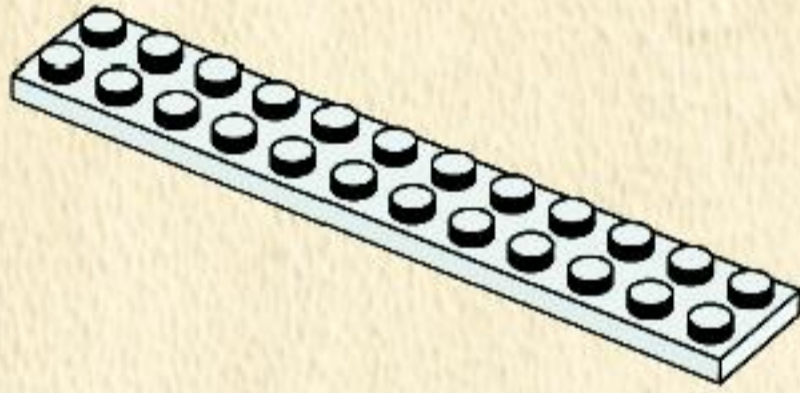

2

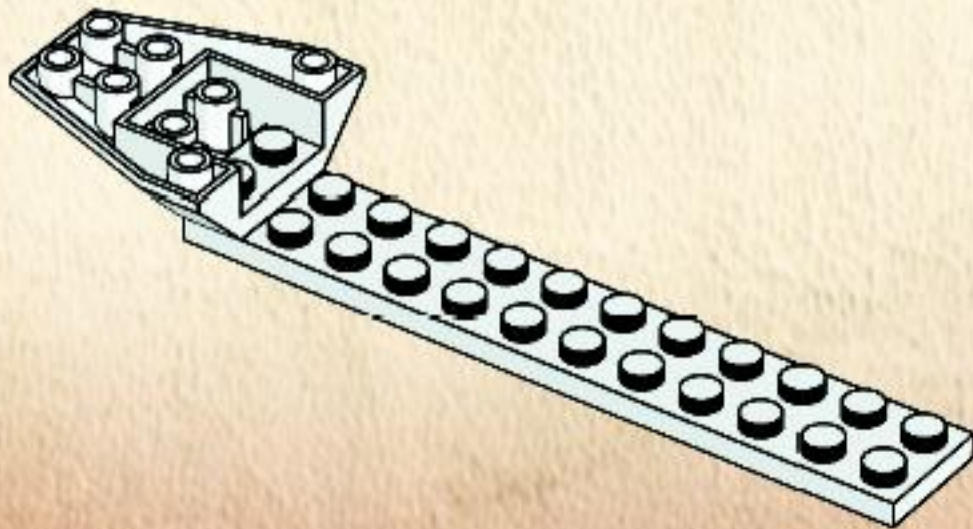

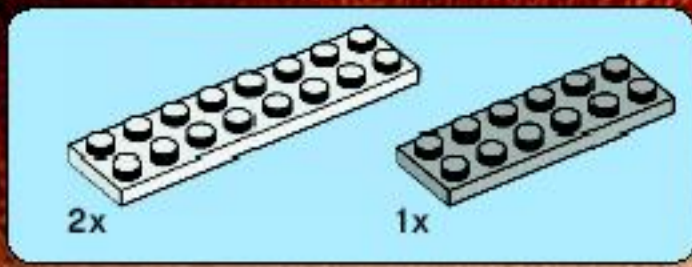

3

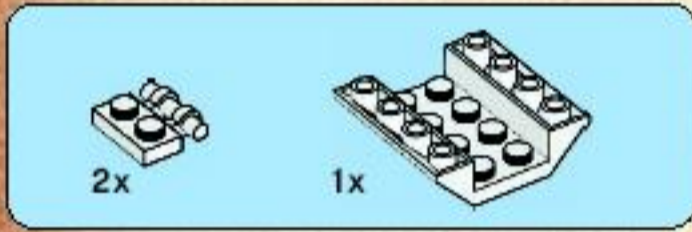
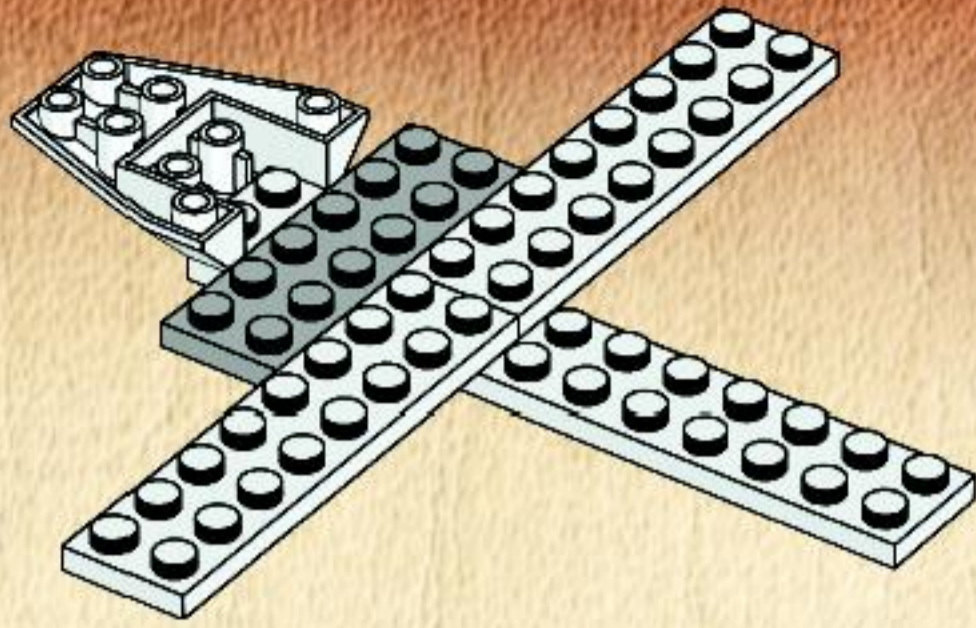

4

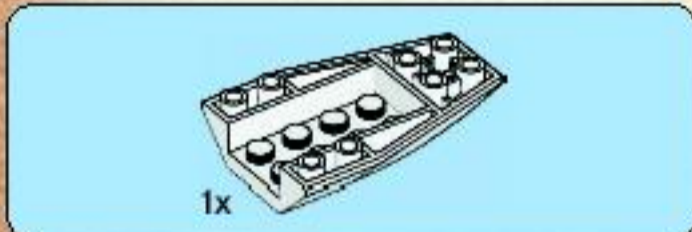
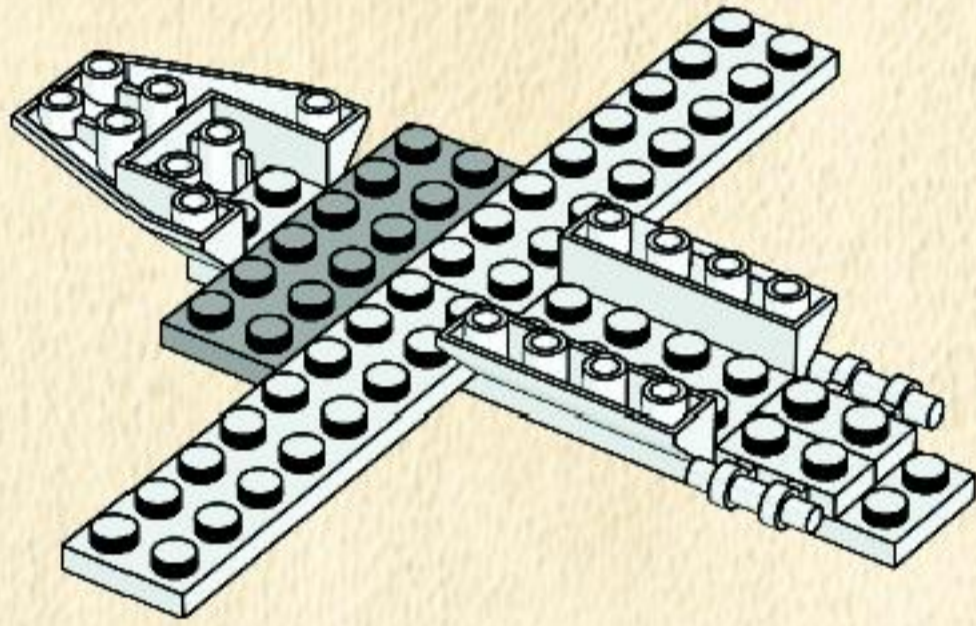

5

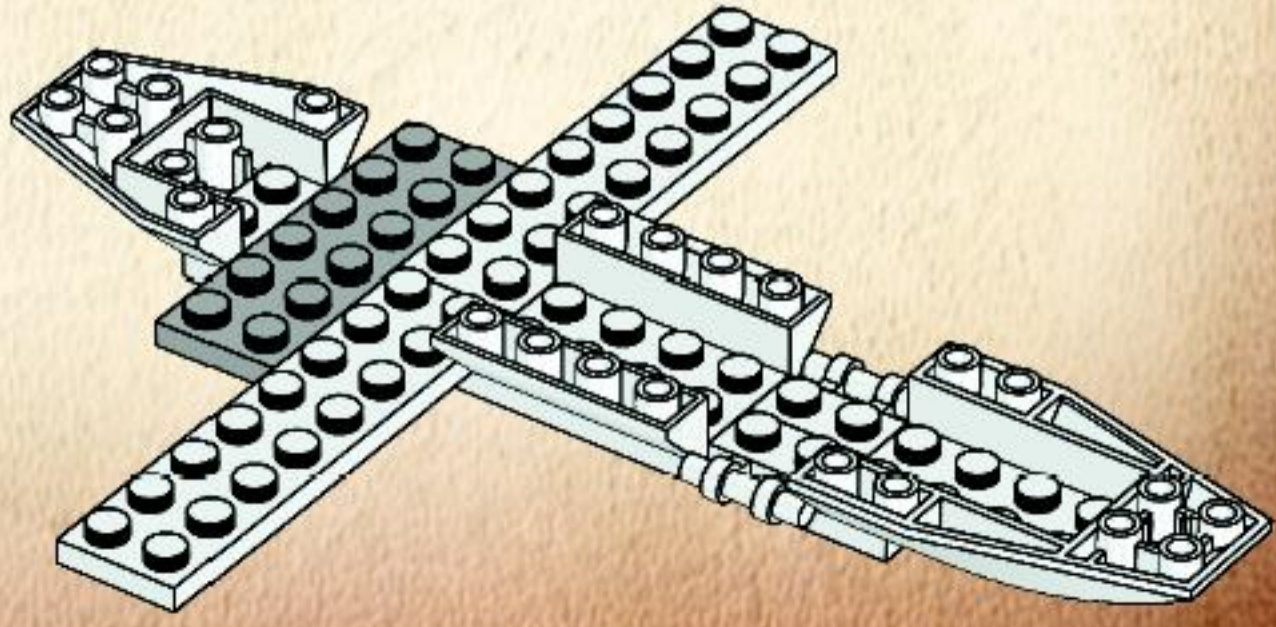



6

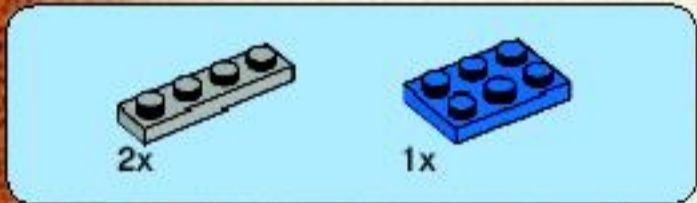
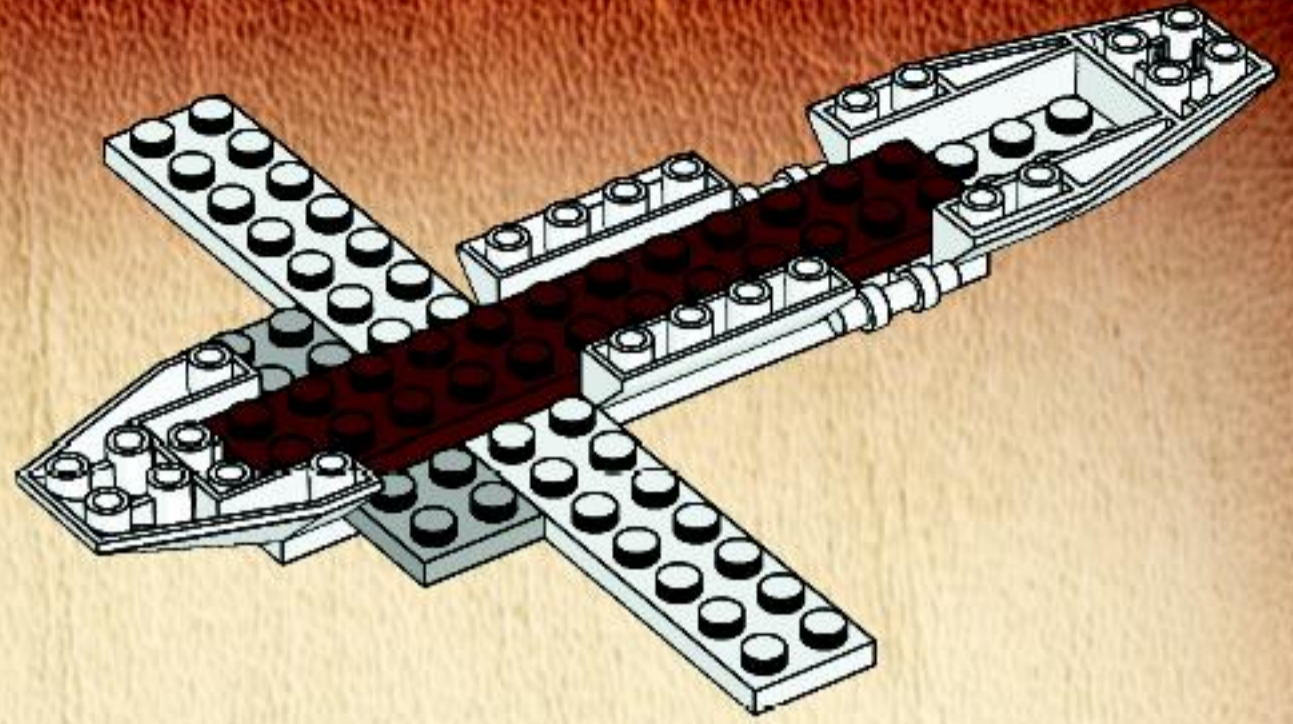

7

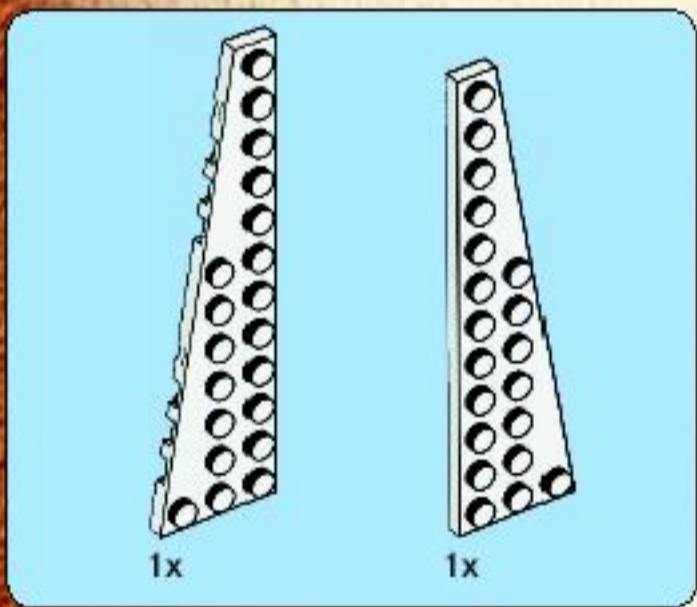
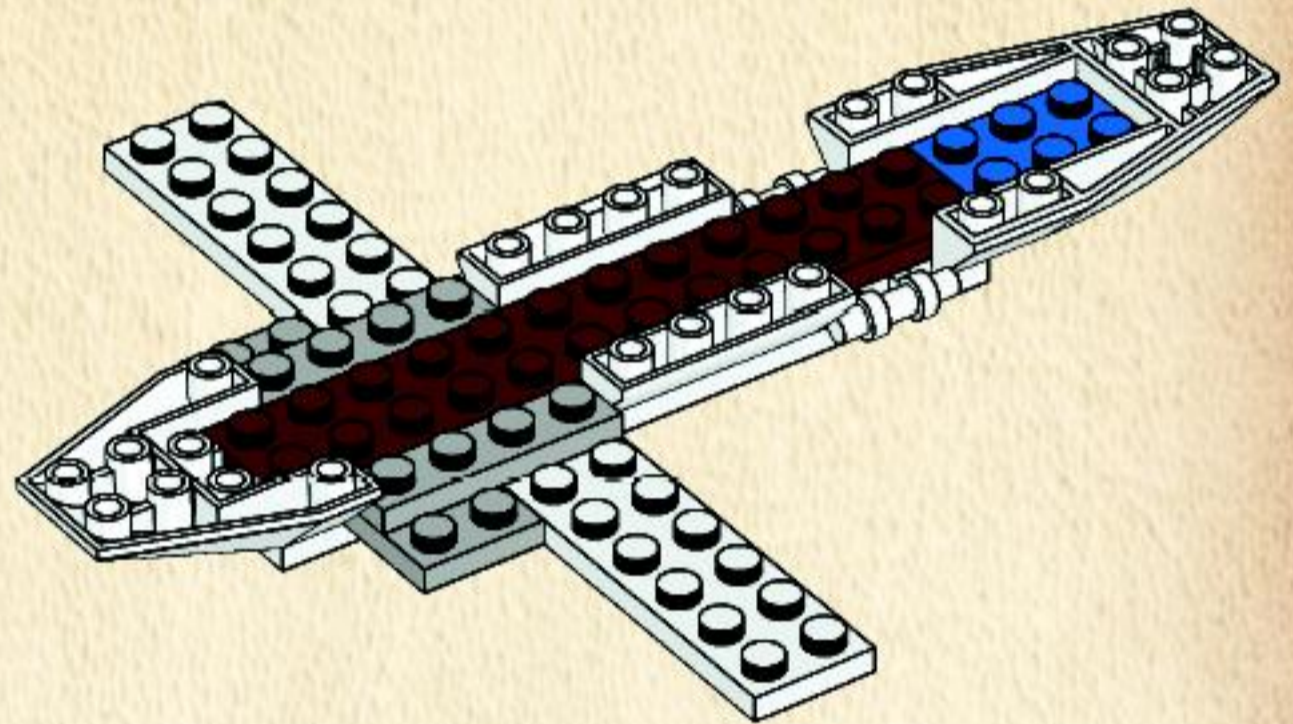

8

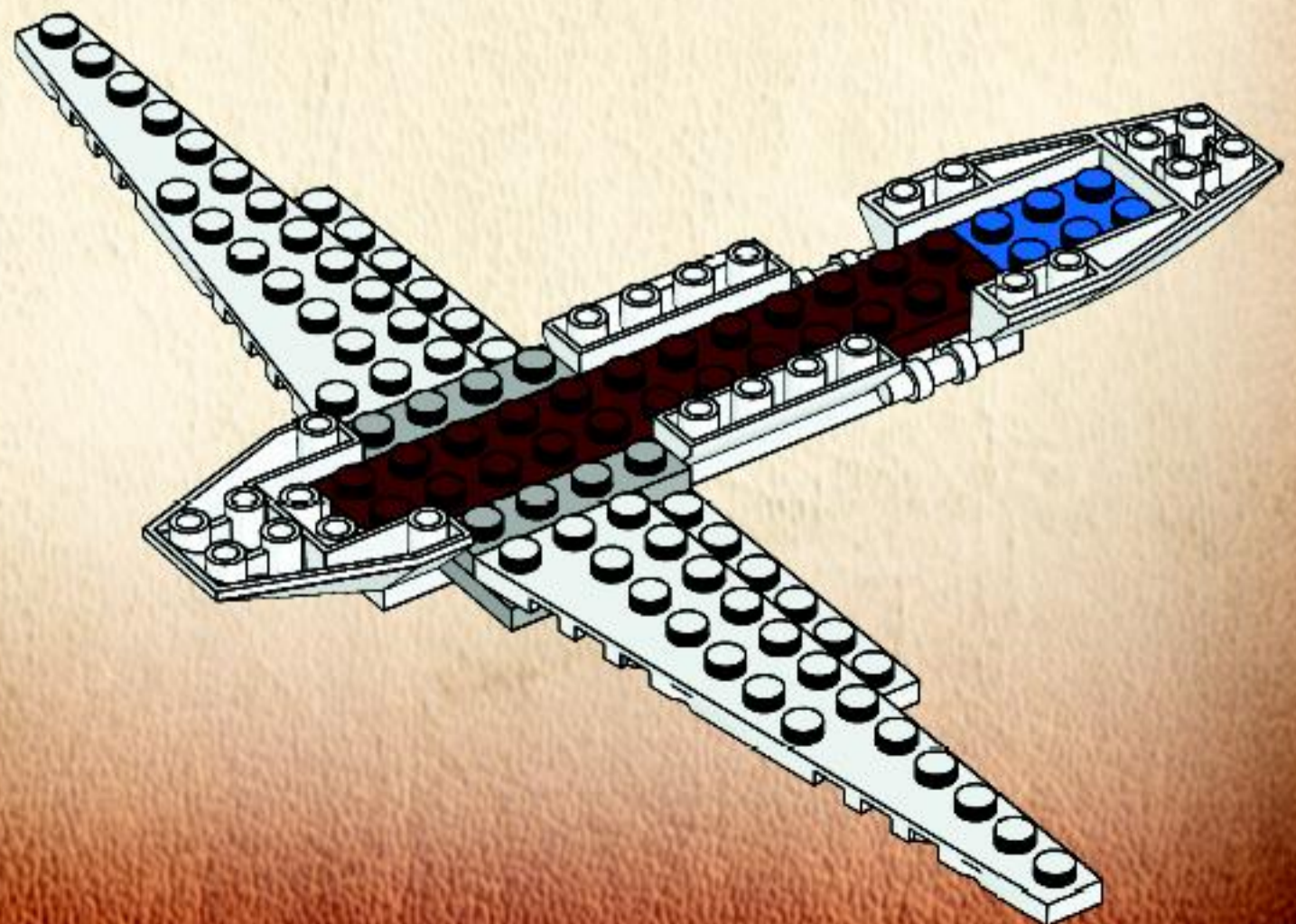

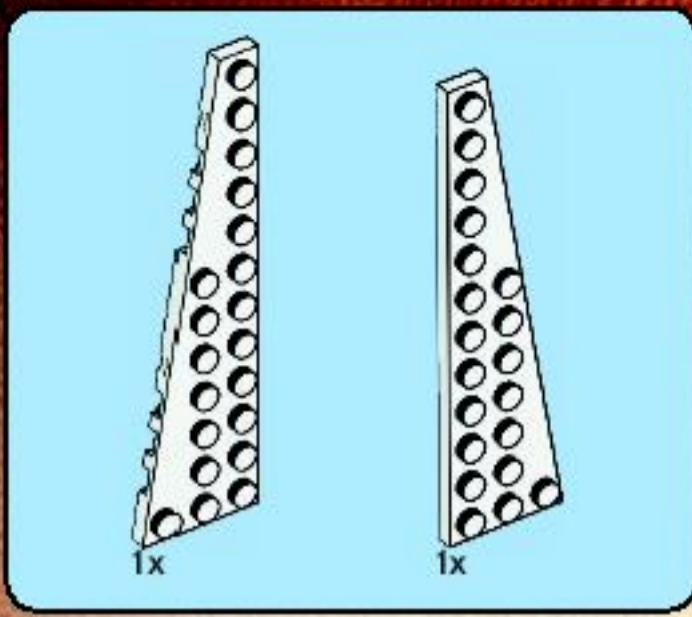

9

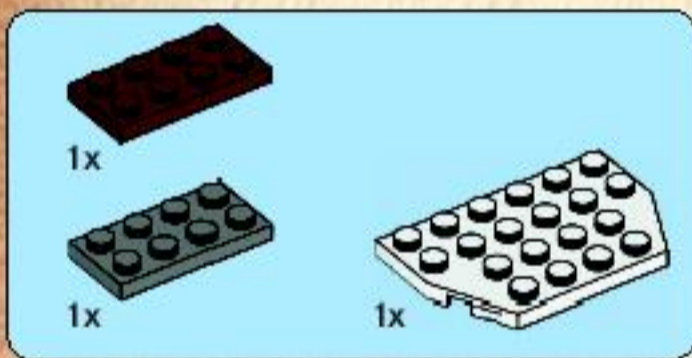
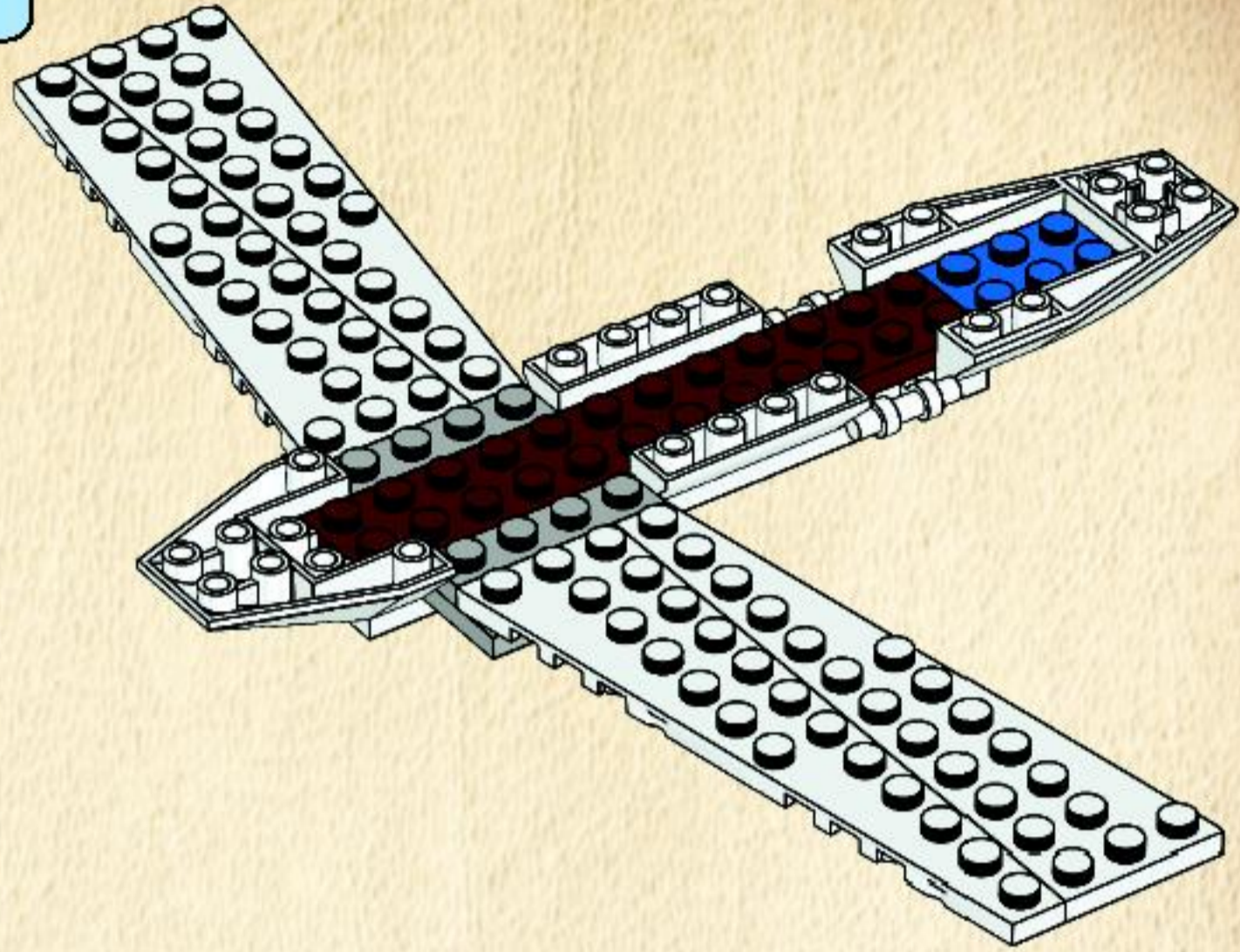

10

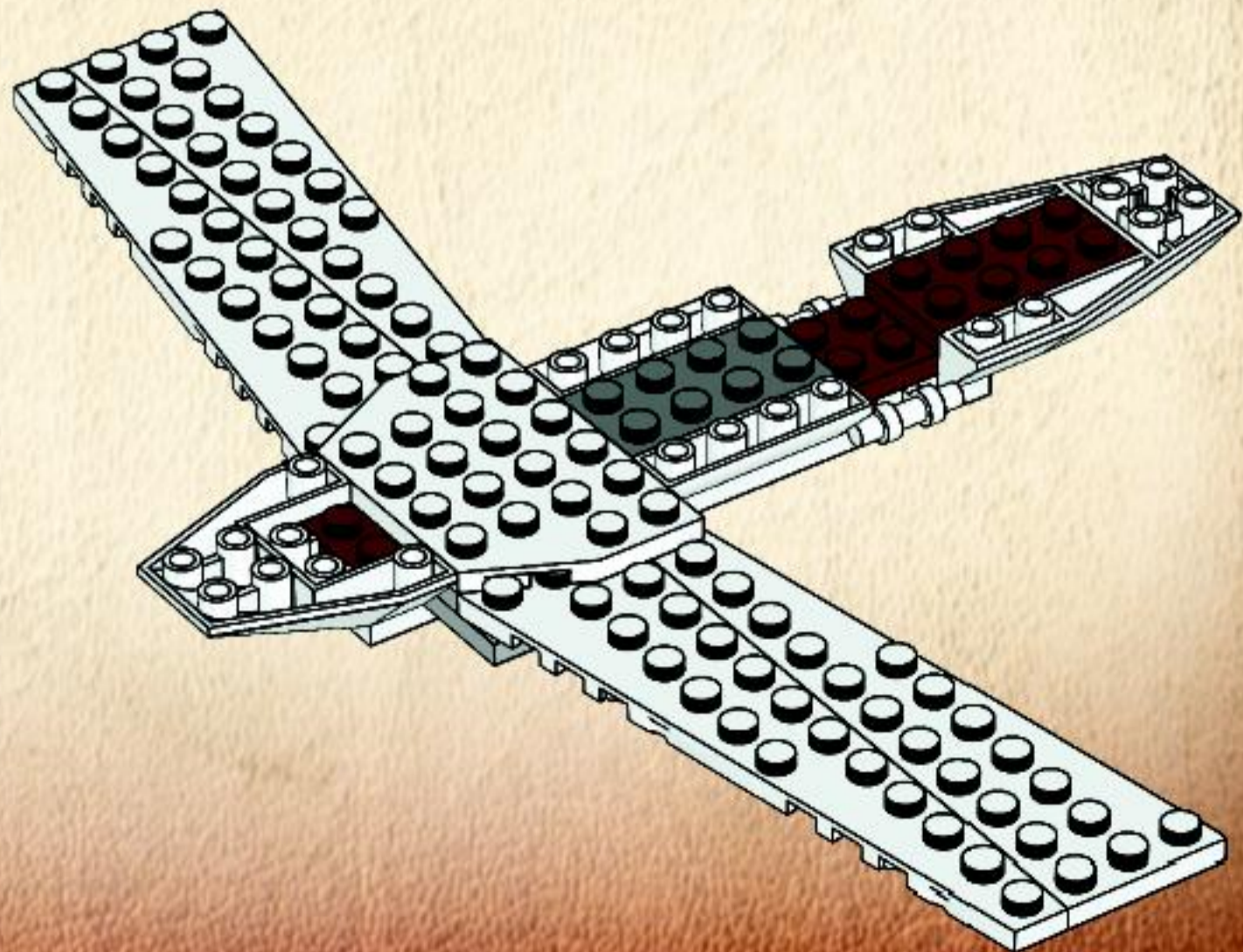



2x



2x

11

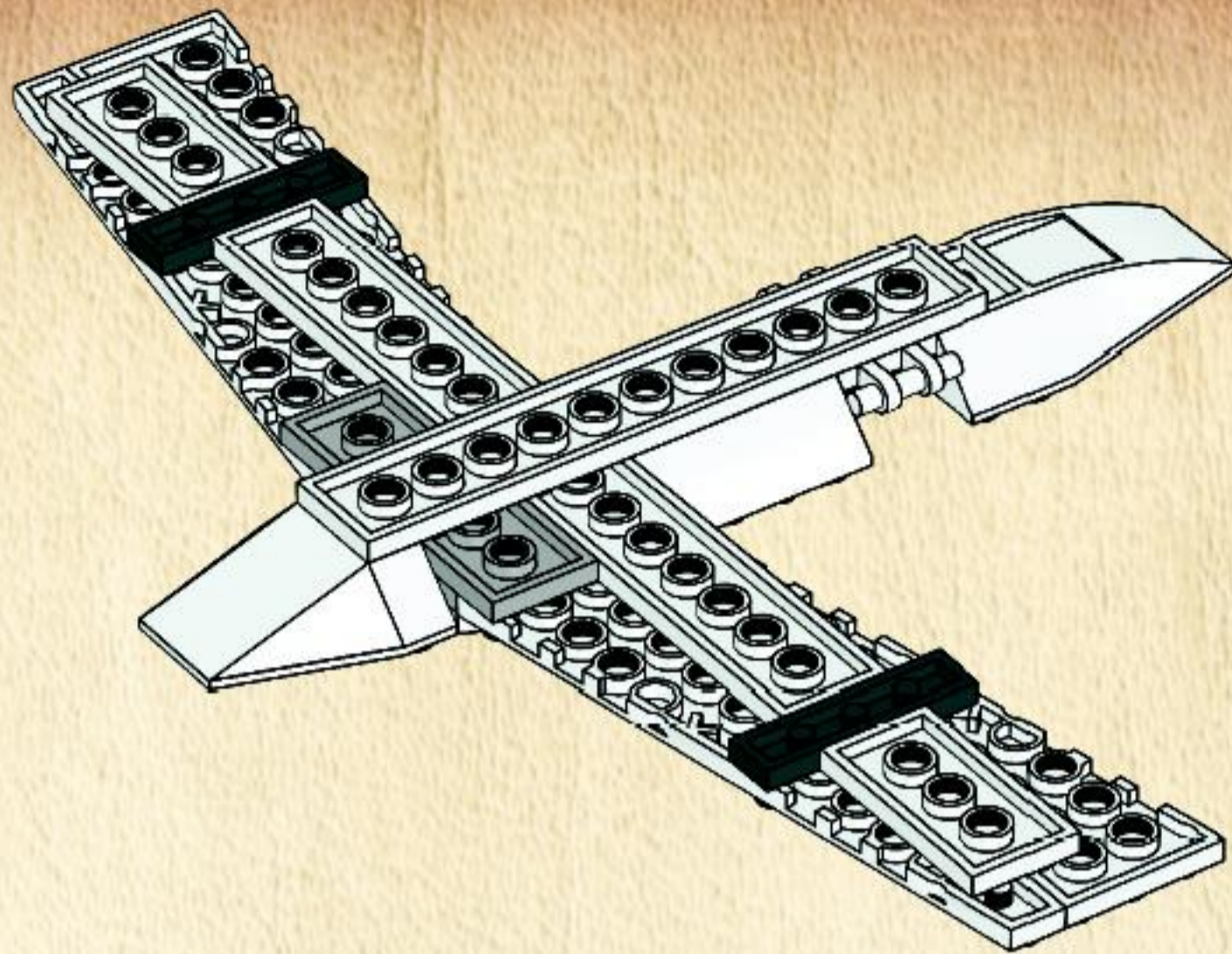

1x



1x



1x

12

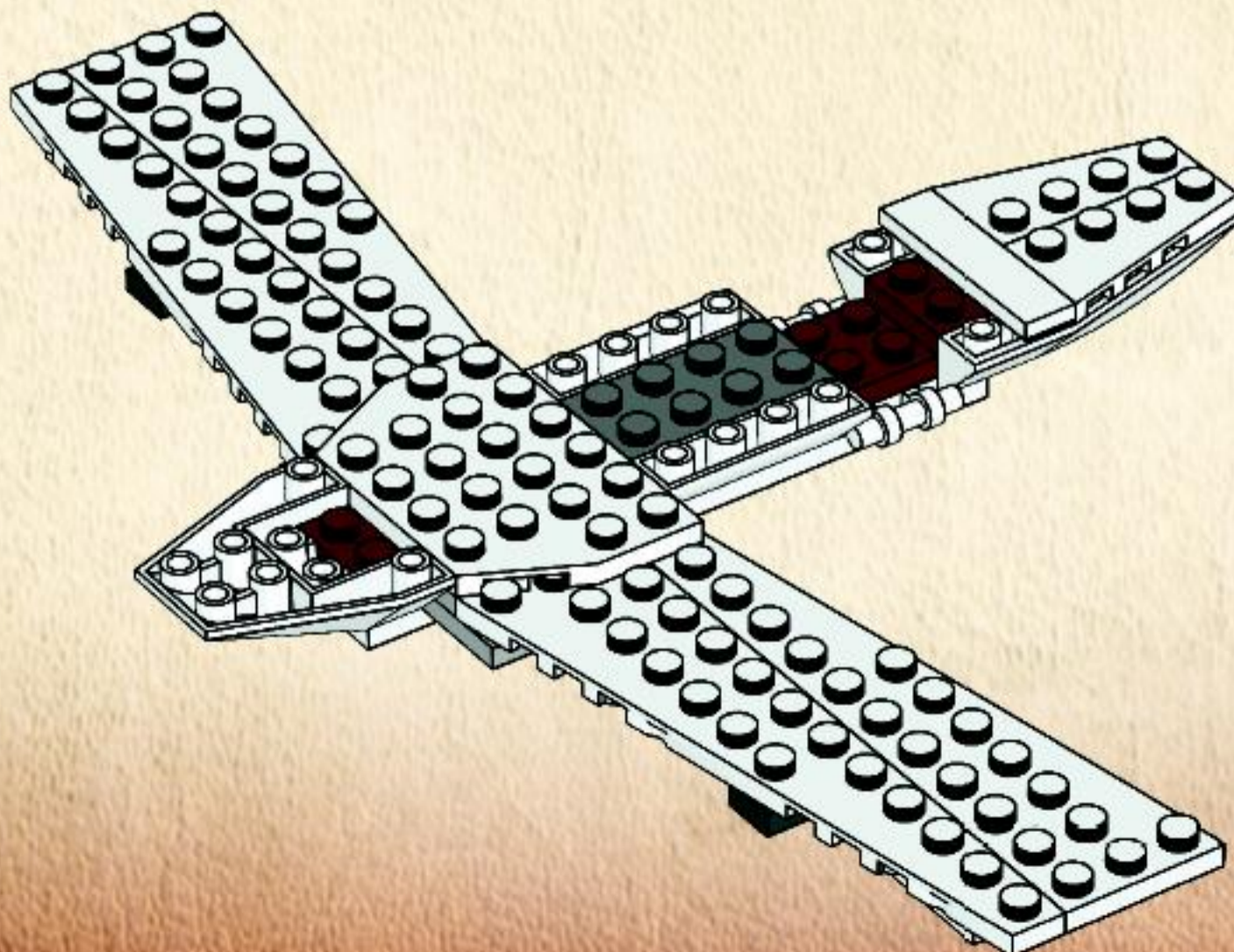



13

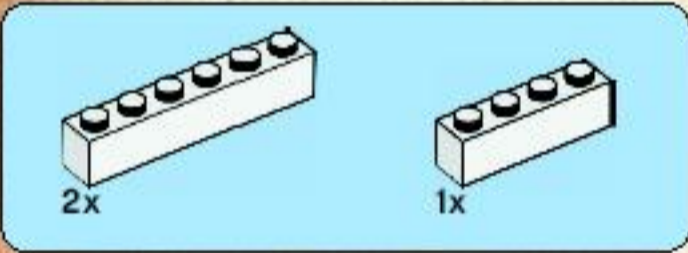
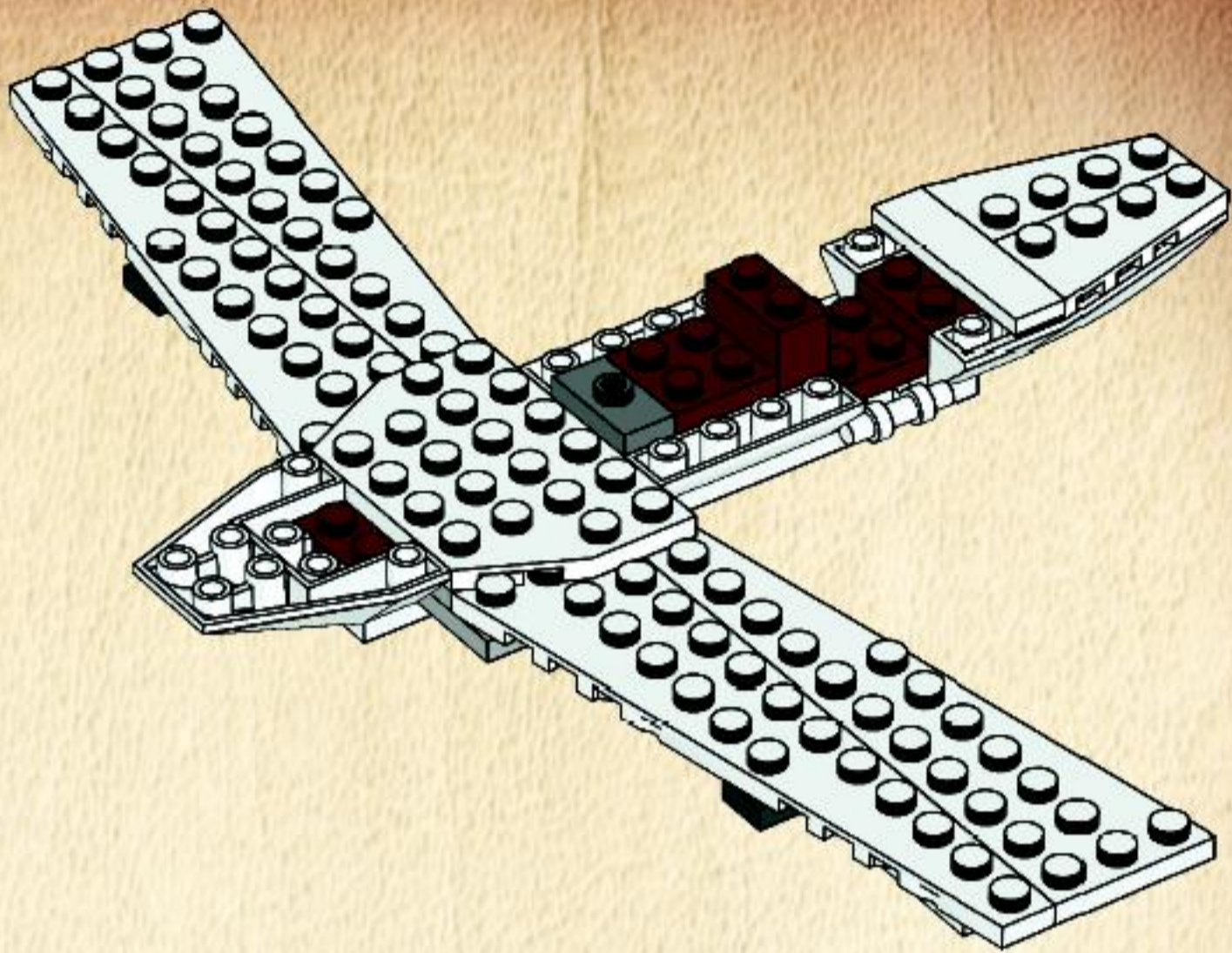

14

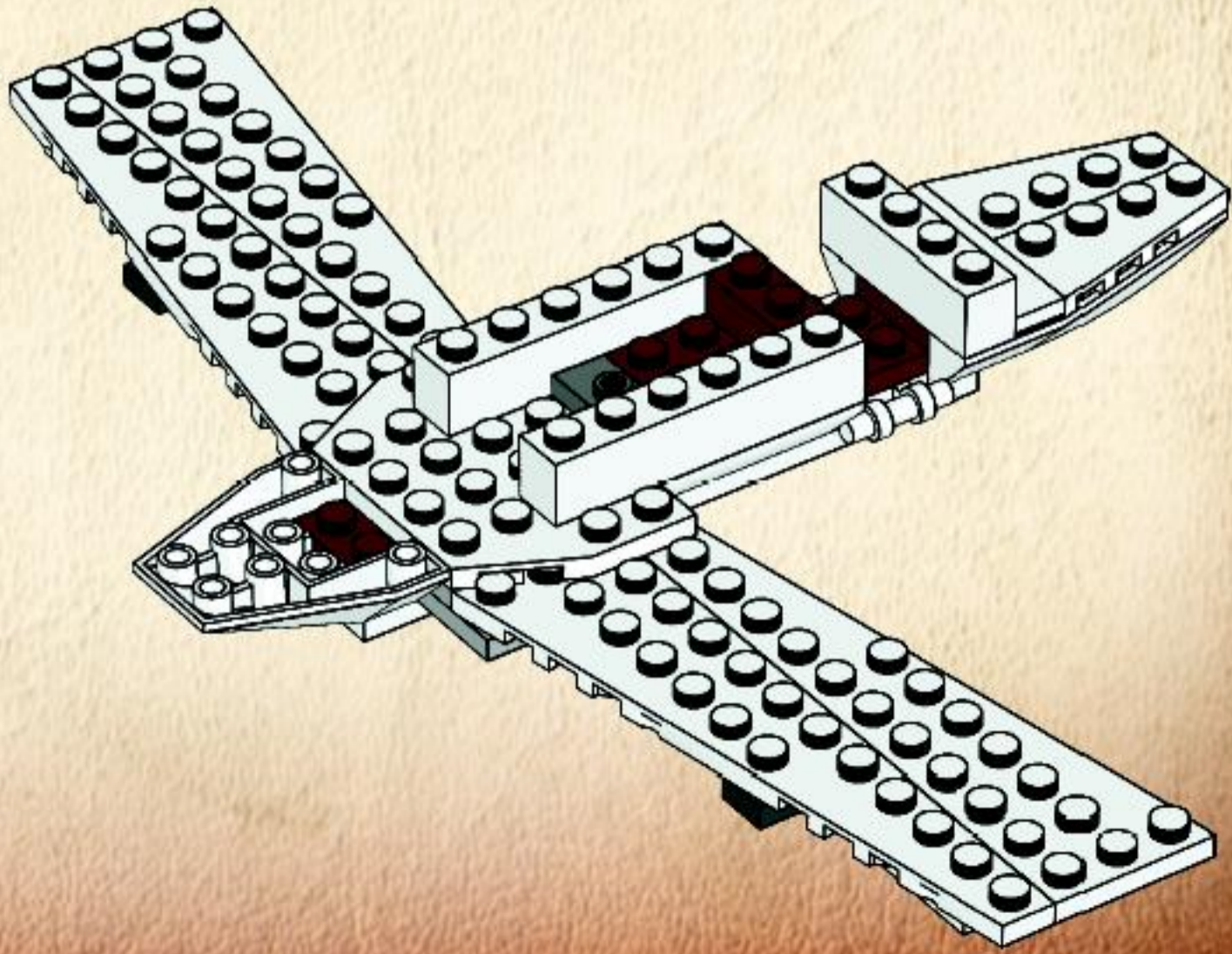

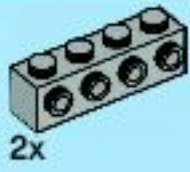

2x

15

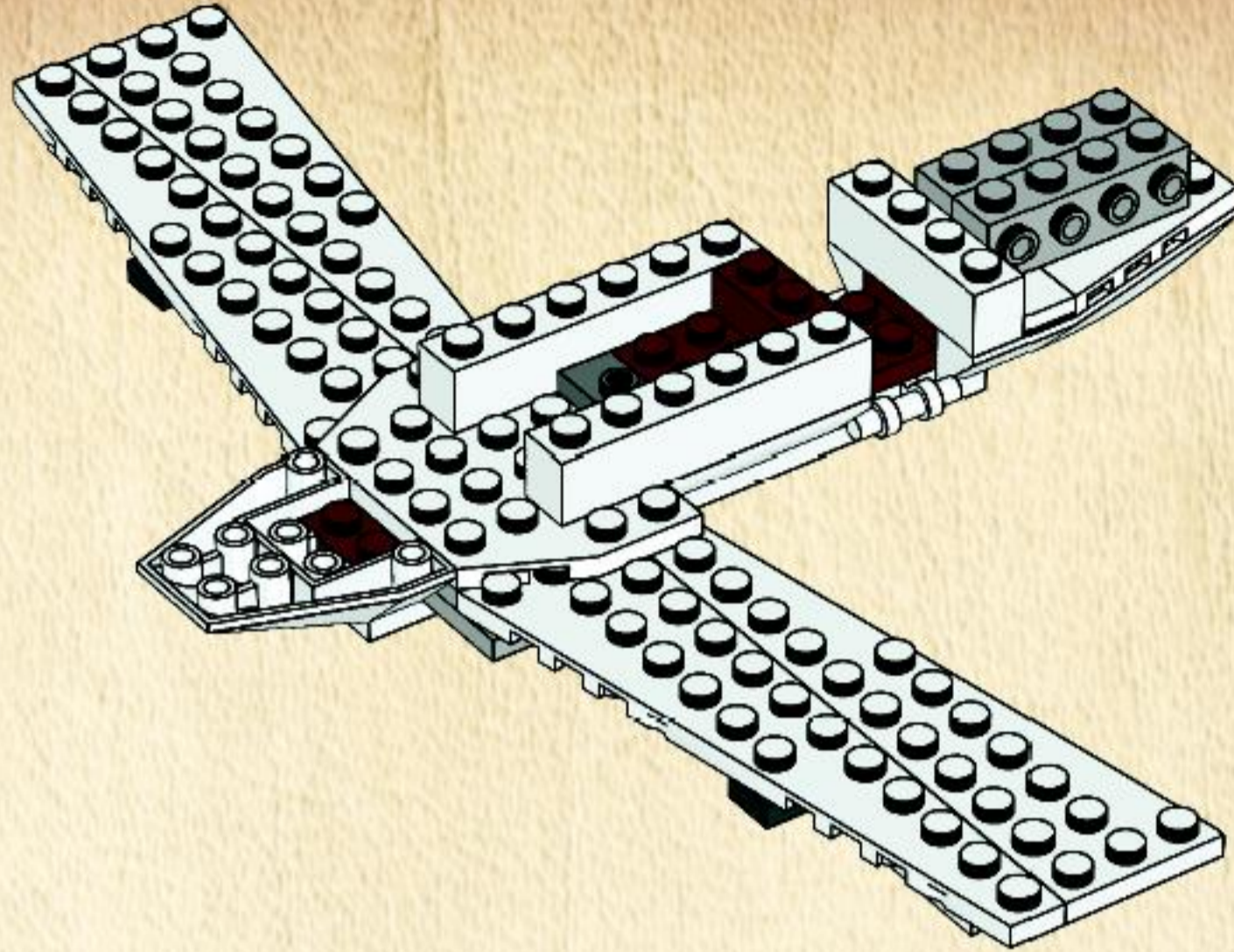

2x



1x

16

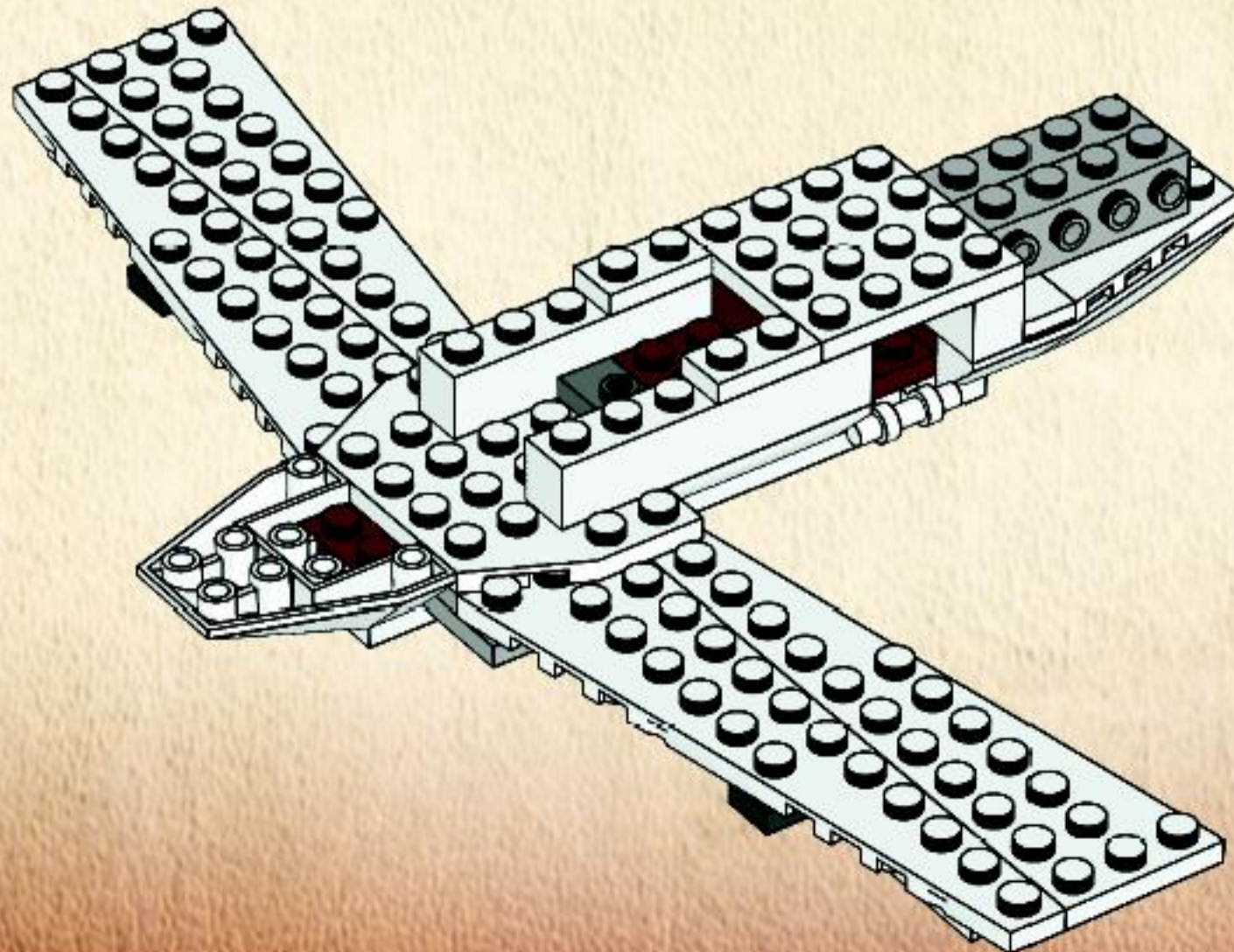



17

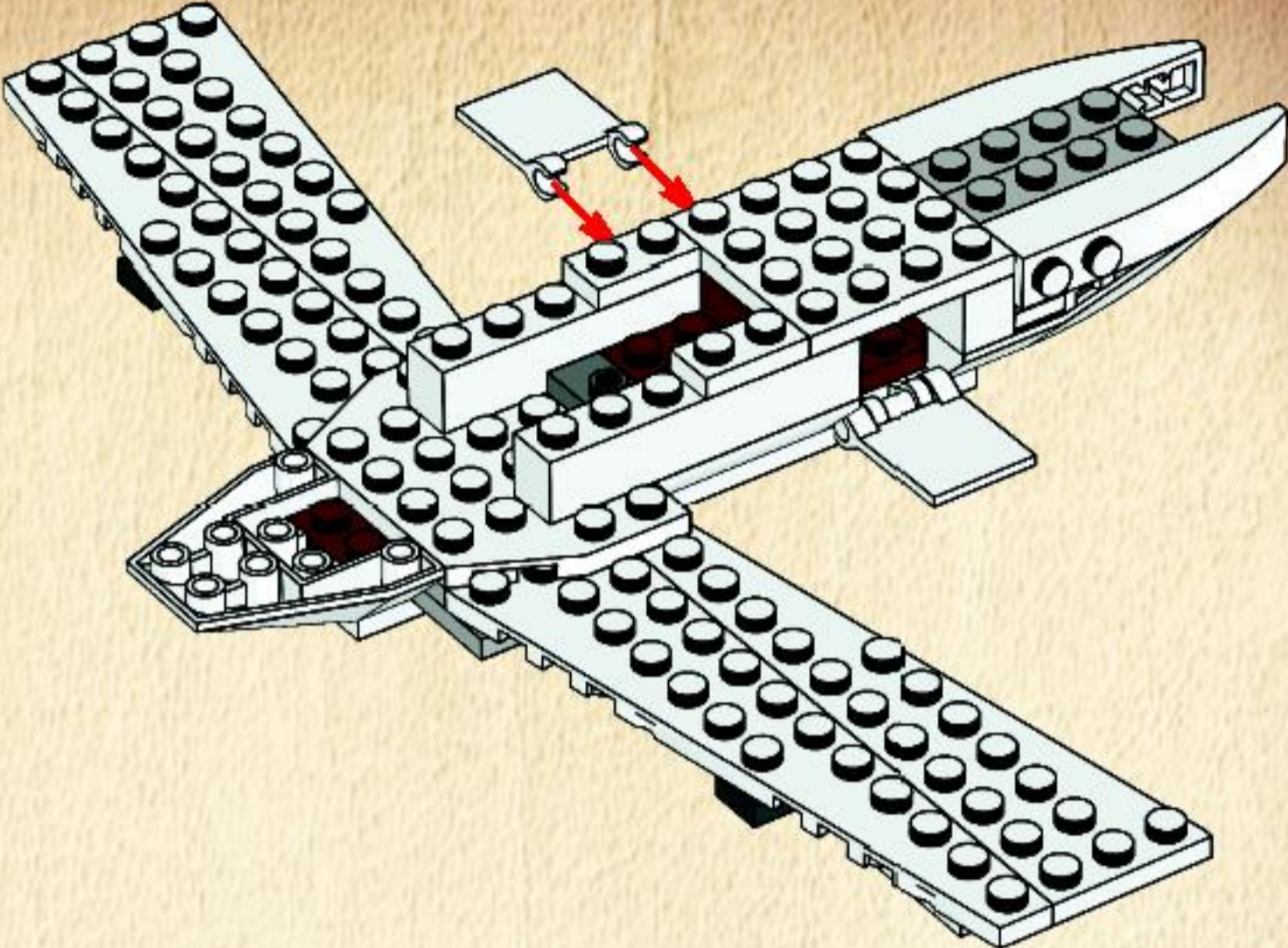

18

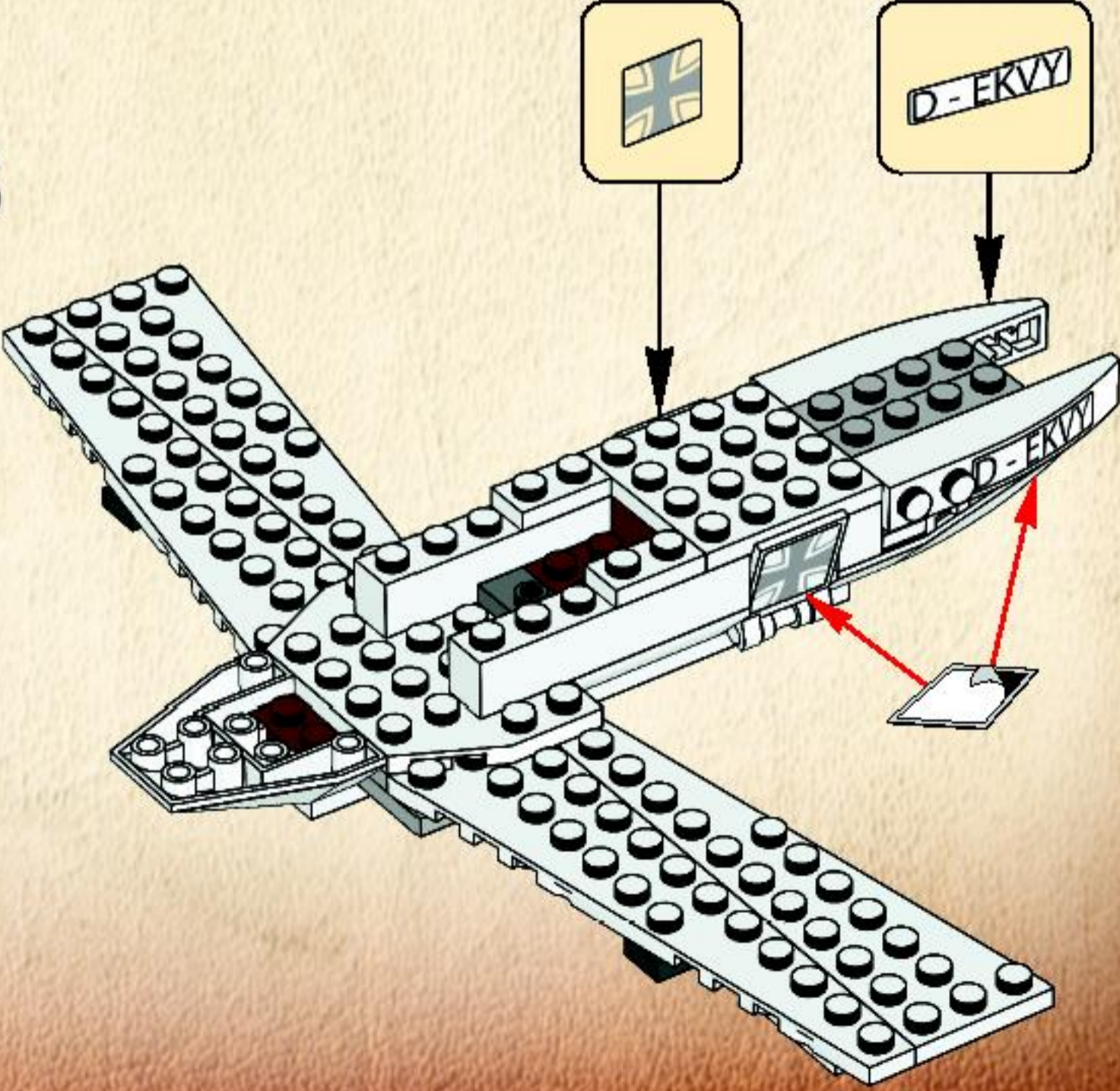

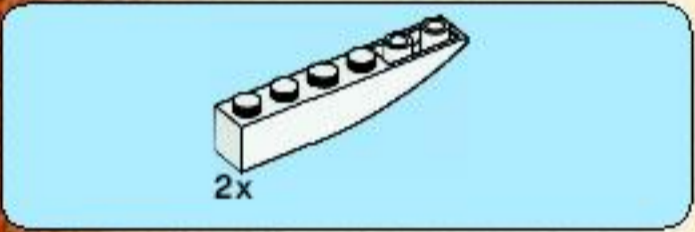
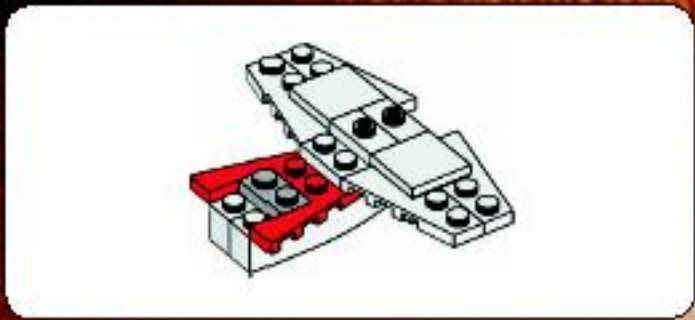

1

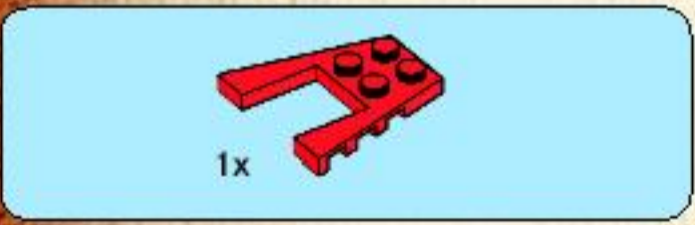
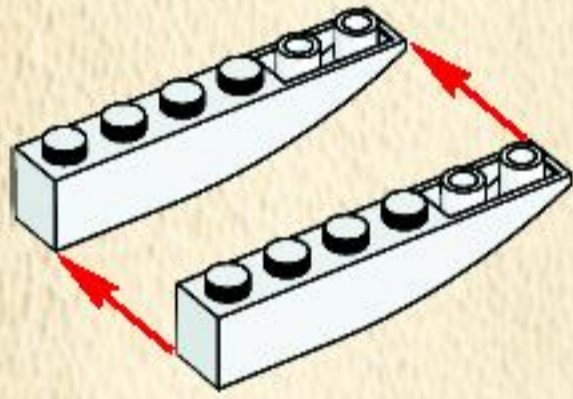

2

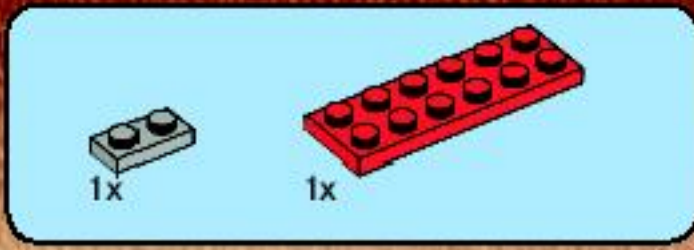
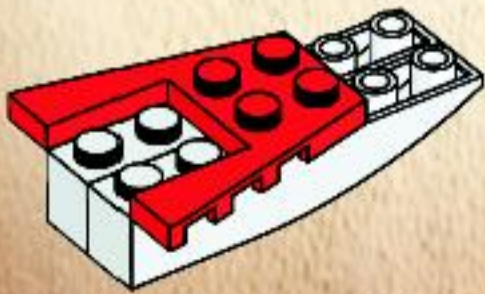

3

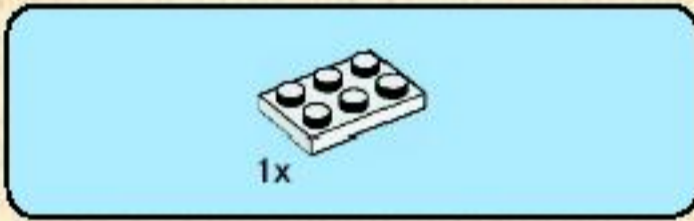
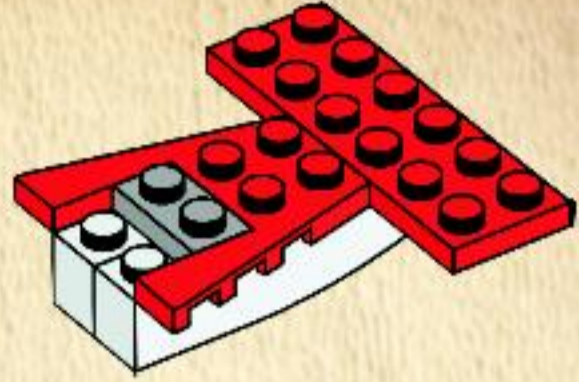

4

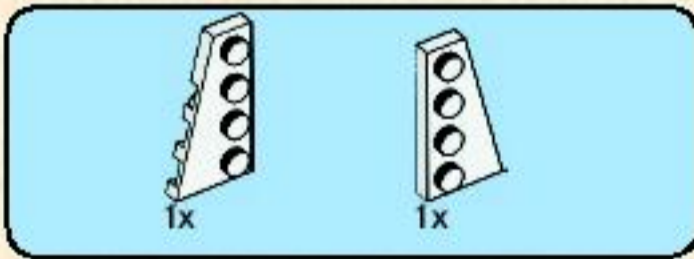
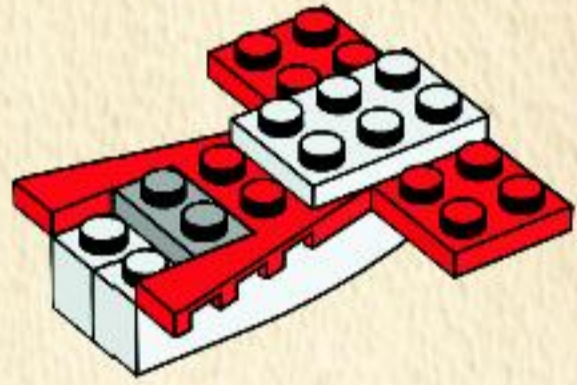

5

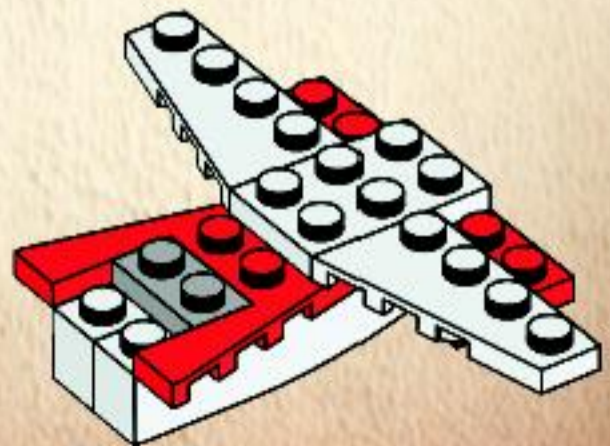

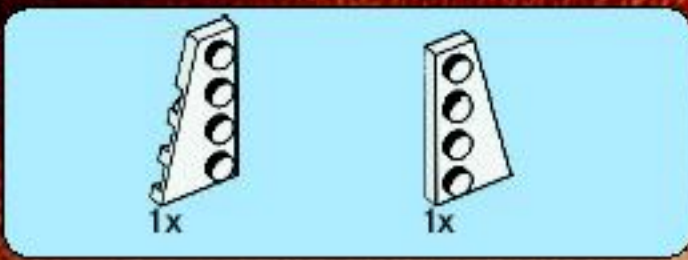

6

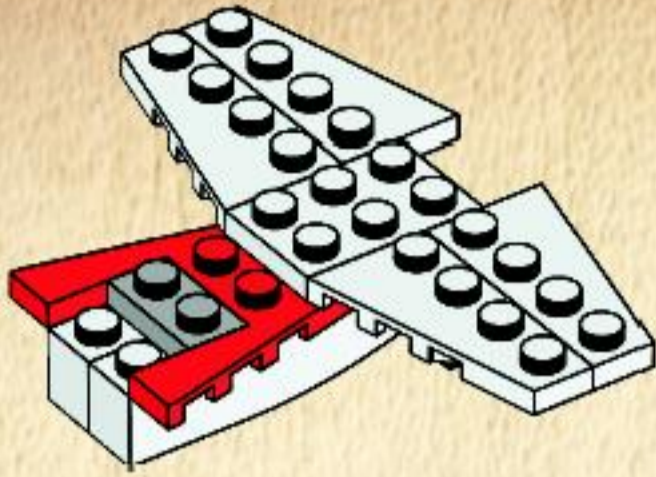

7

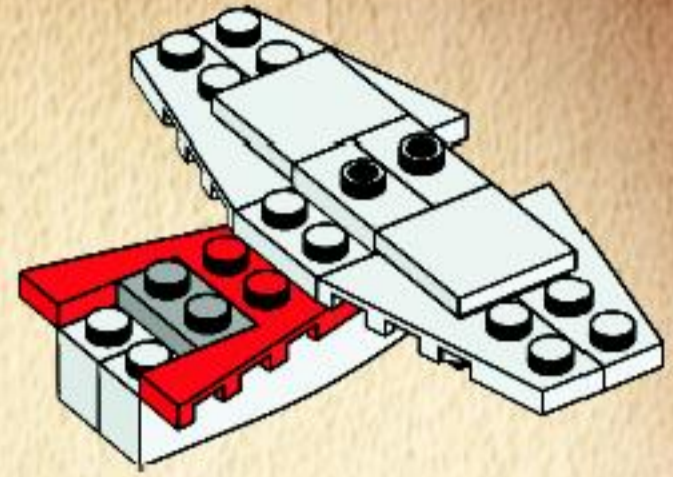

19

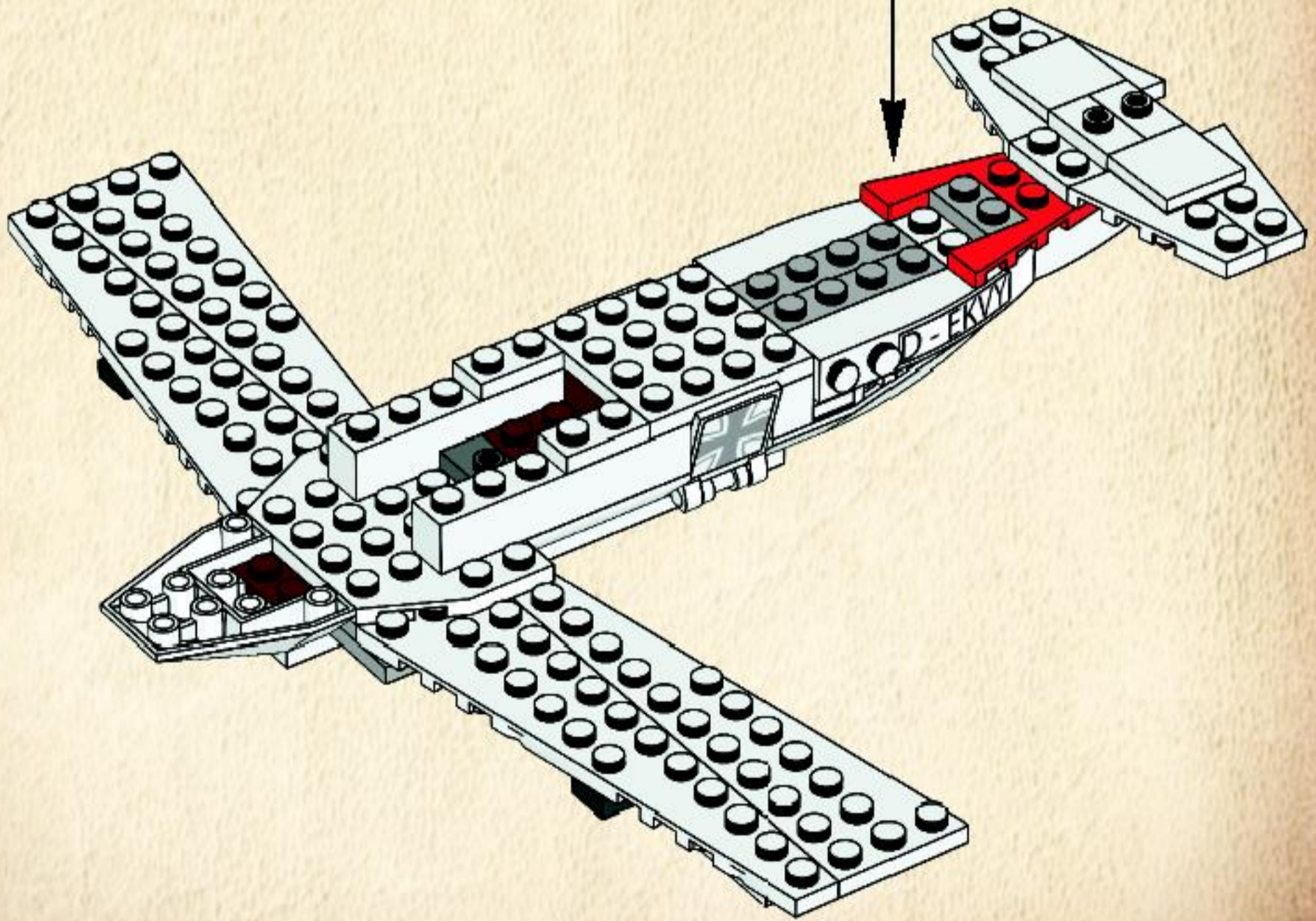

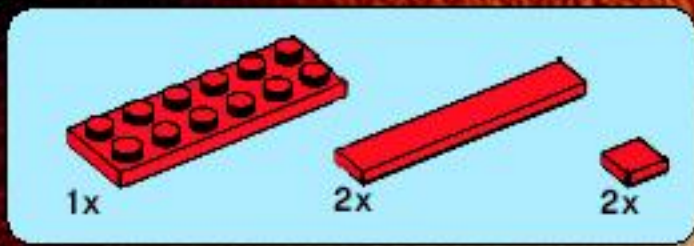

20

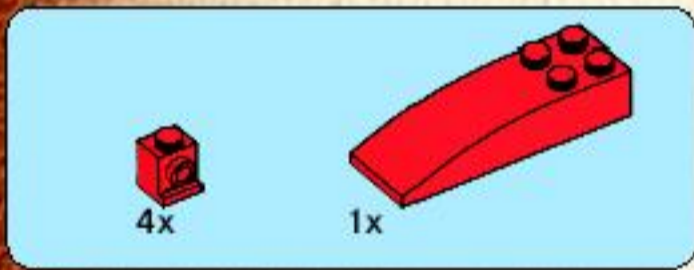
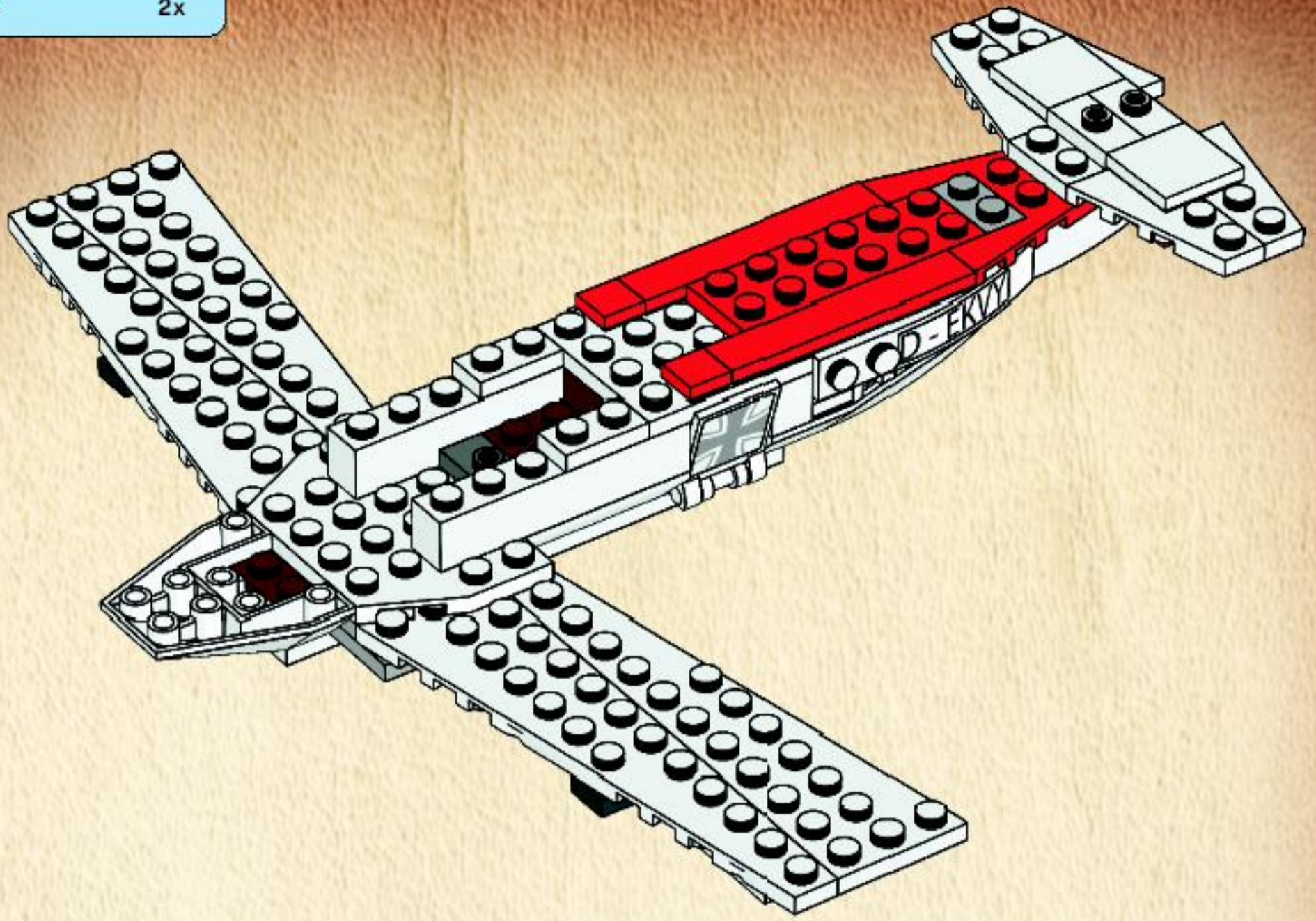

21

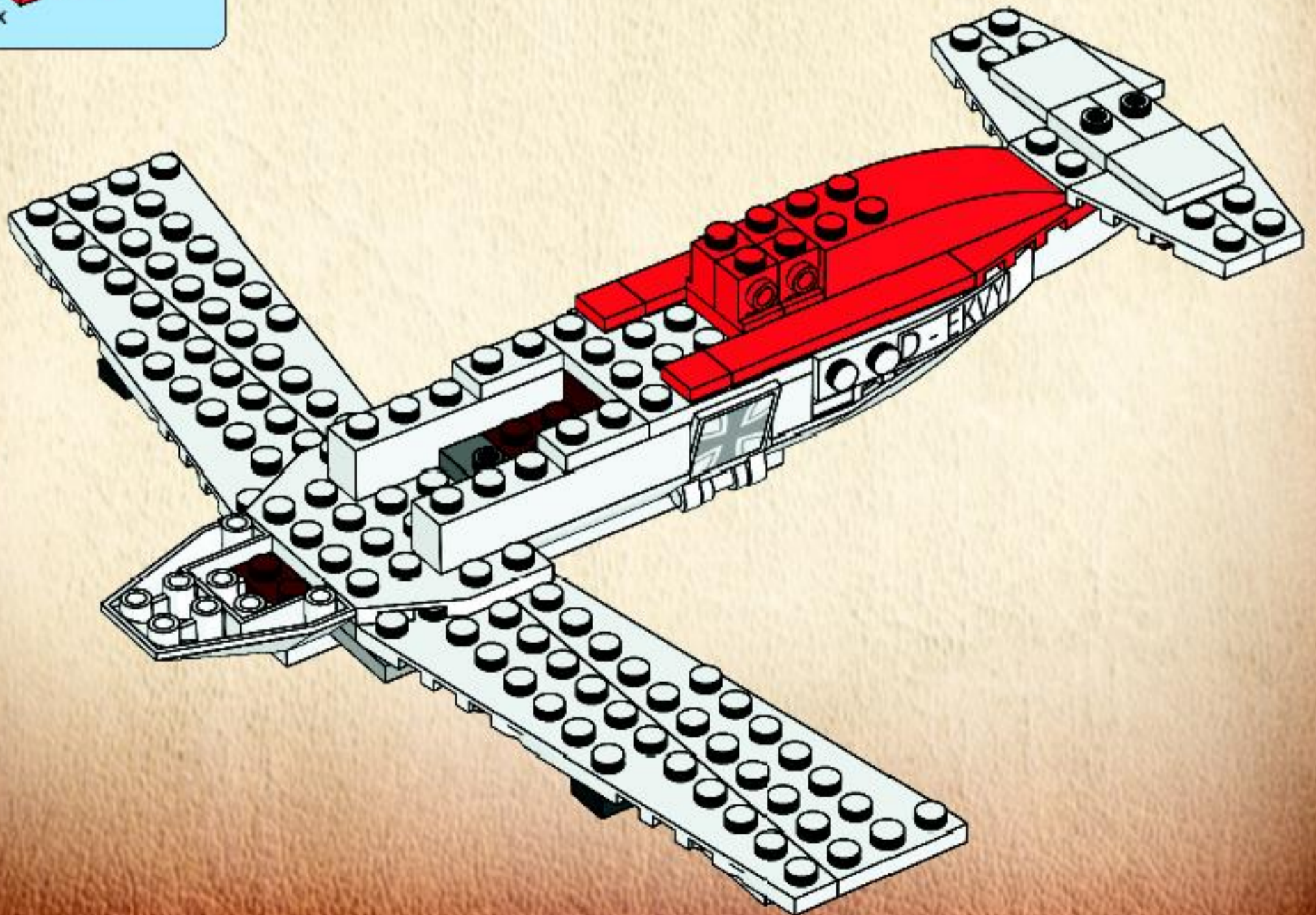



2x



1x

22

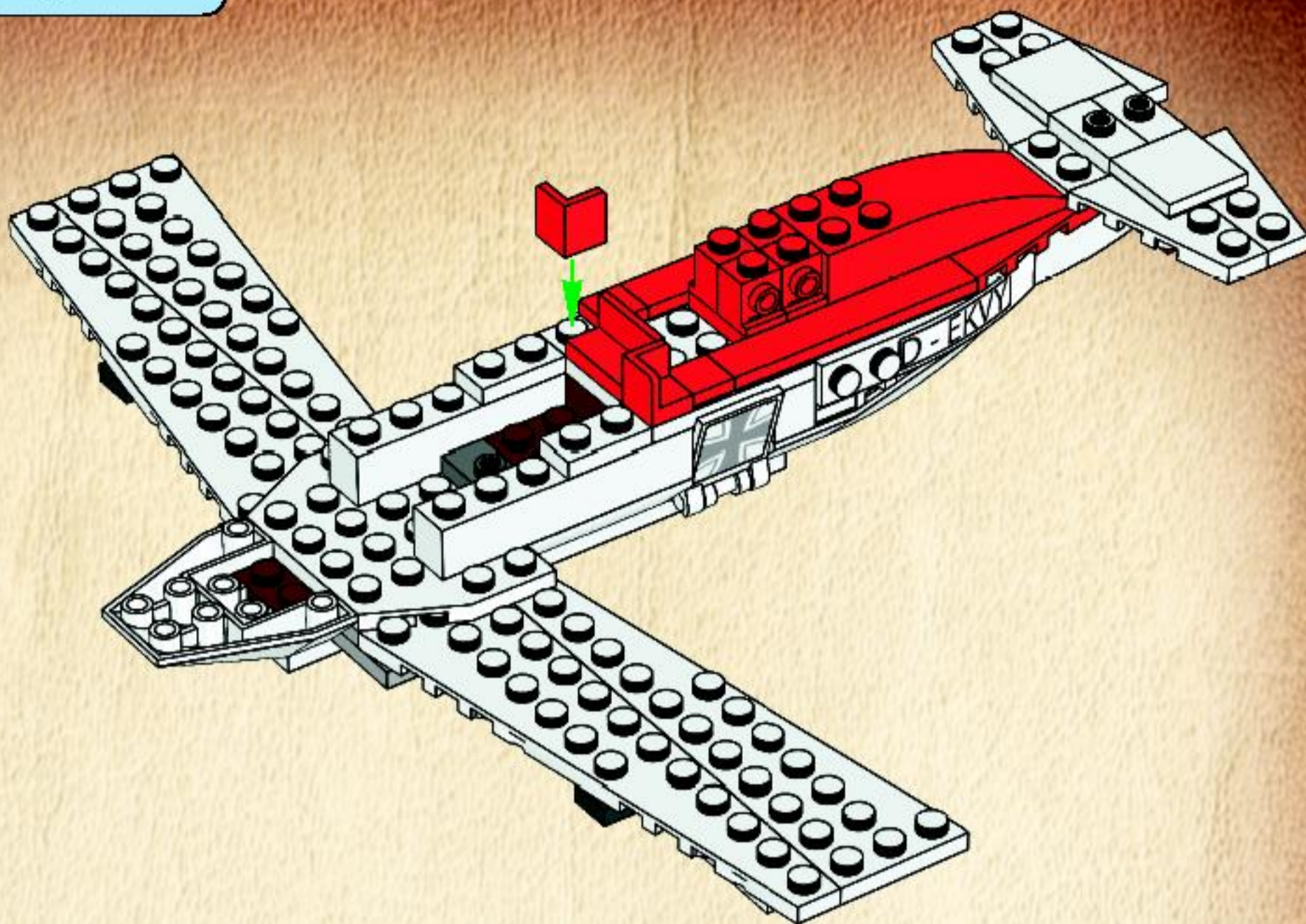

1x



2x

23

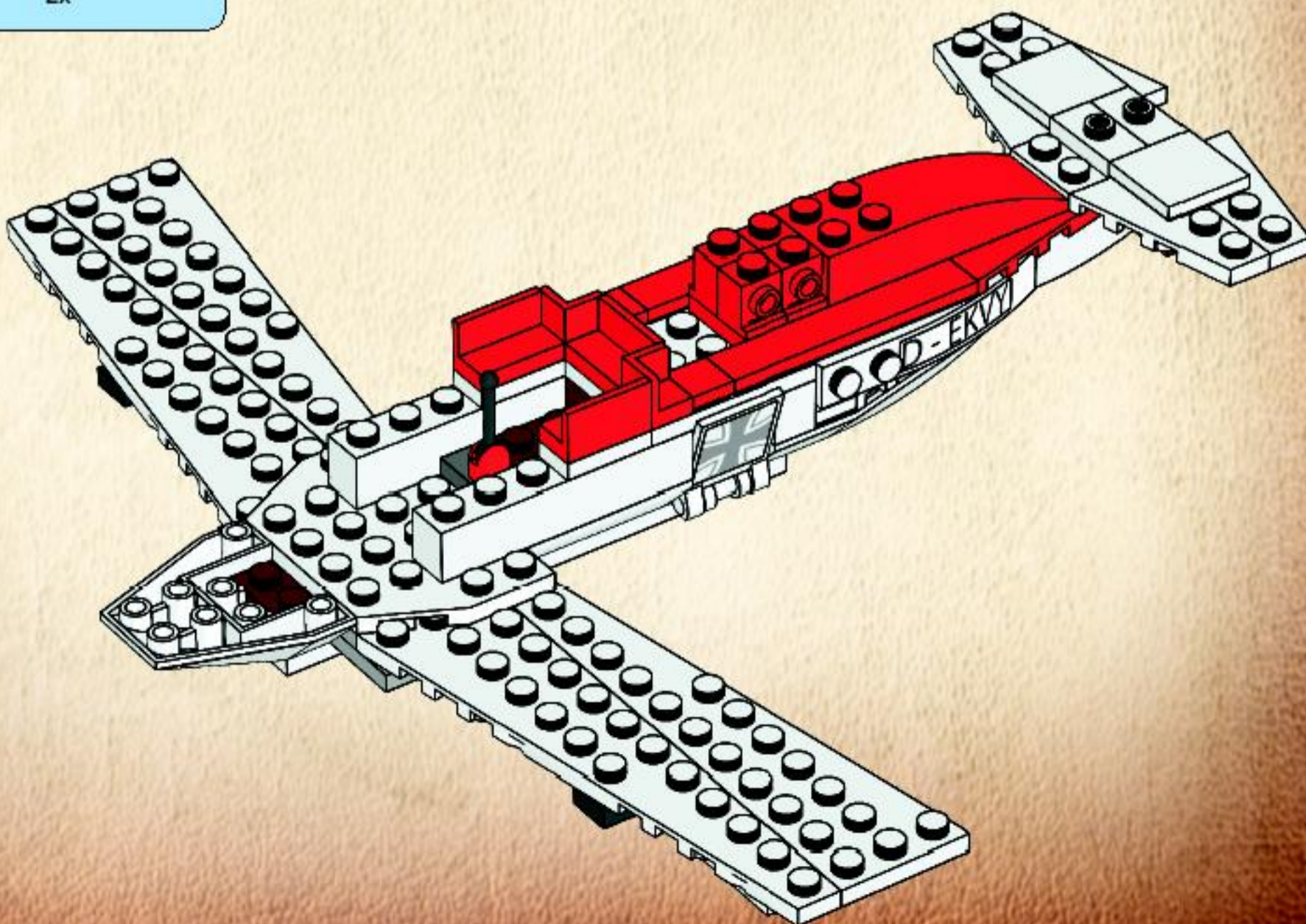



2x



2x

24

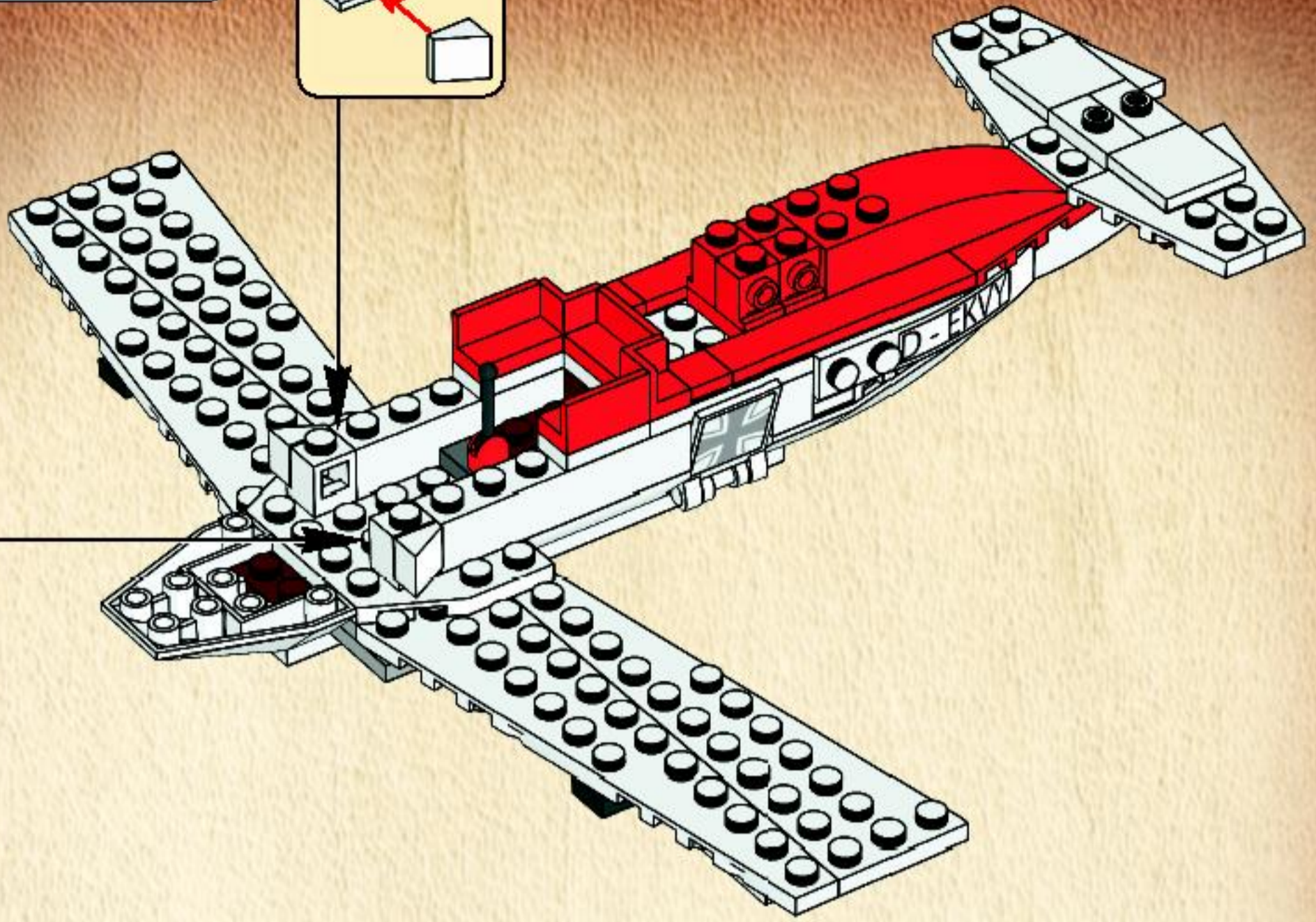
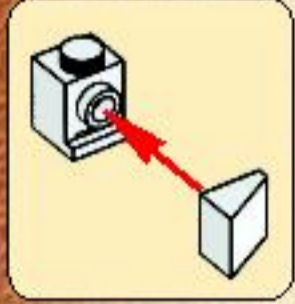
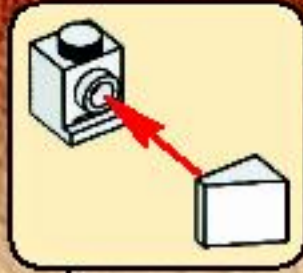

2x



2x

25

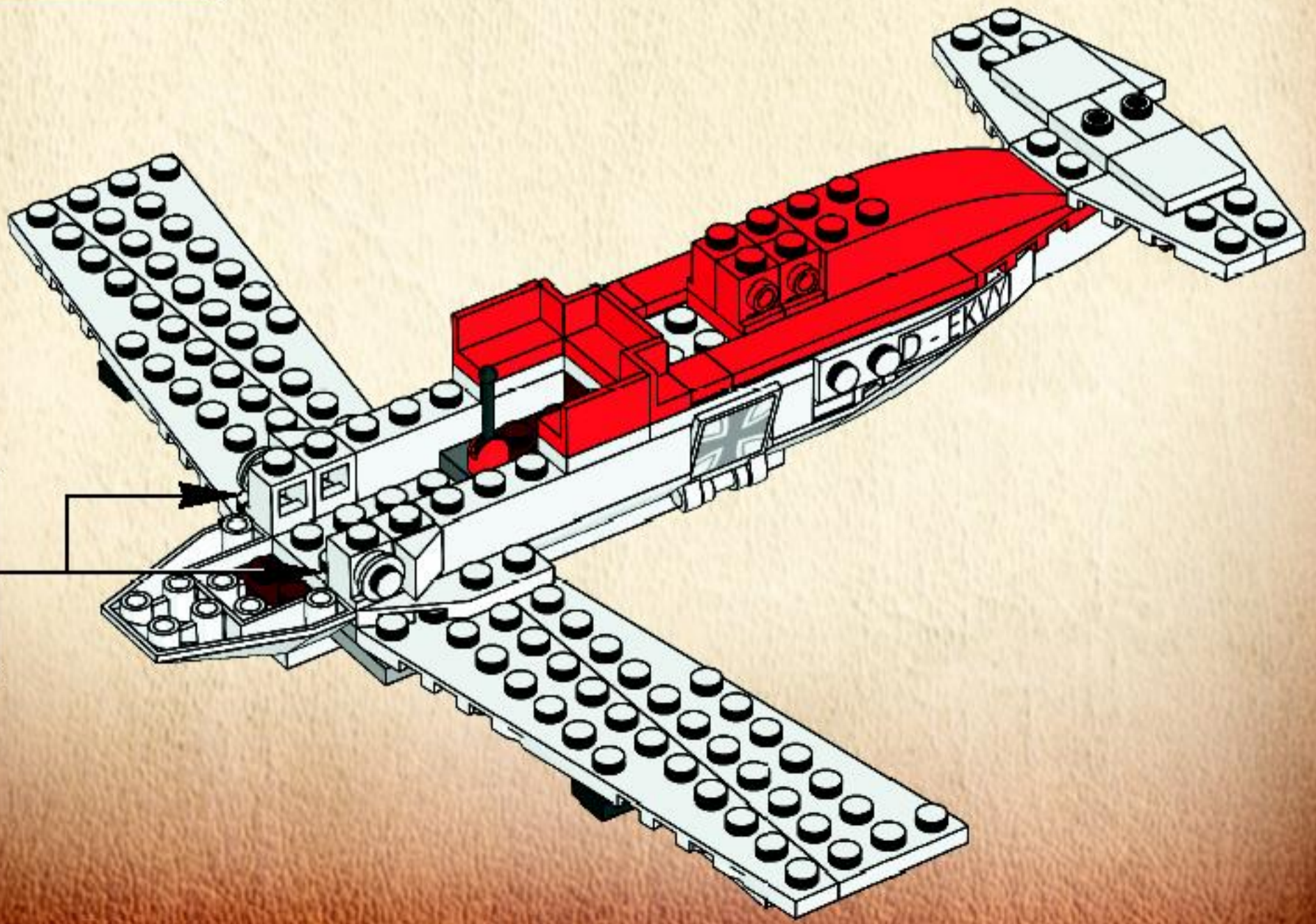
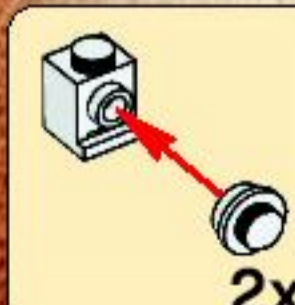

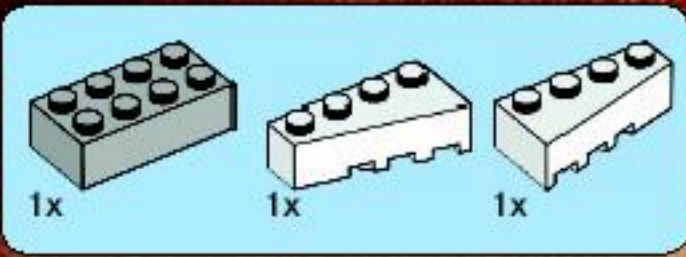

26

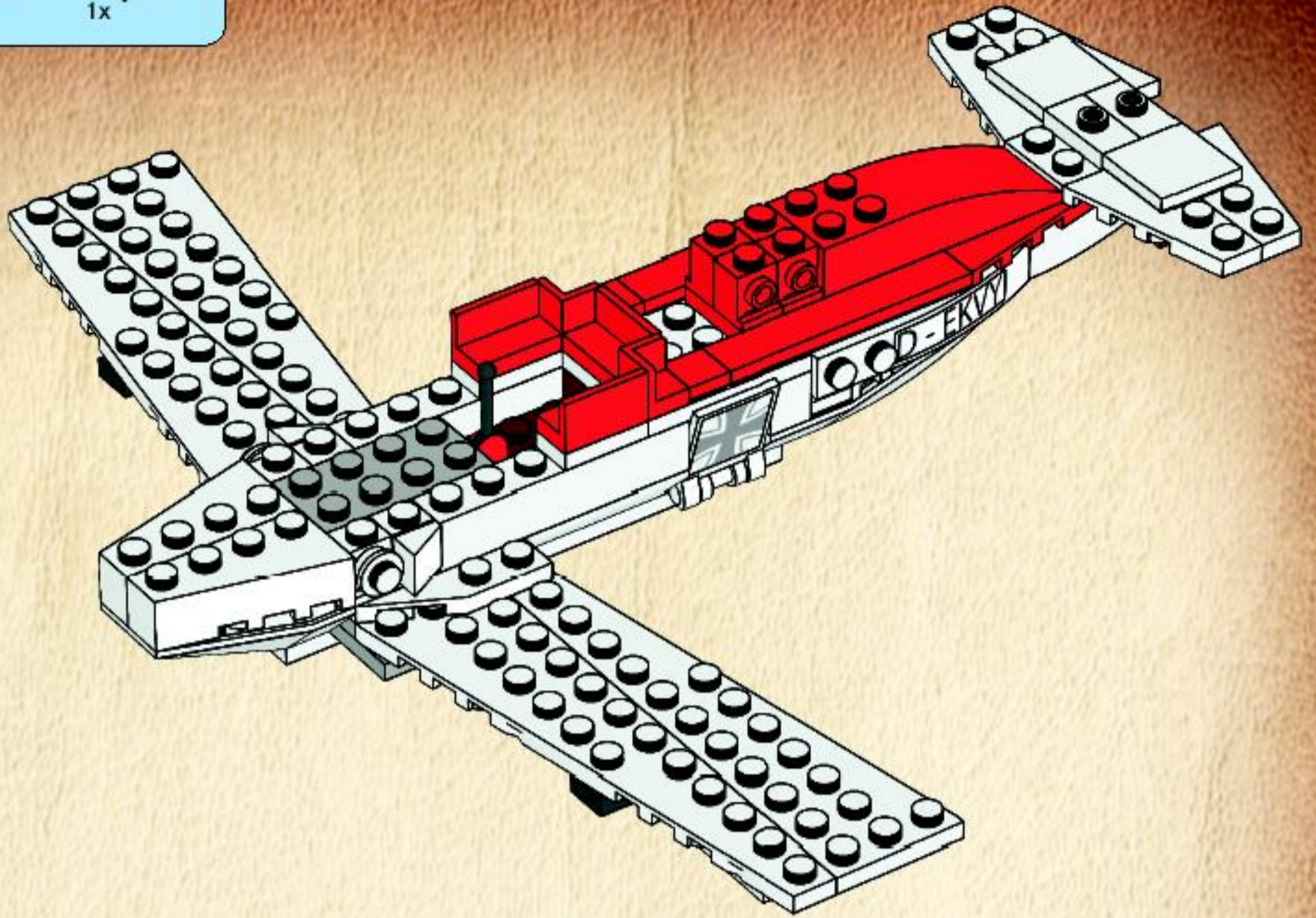

27

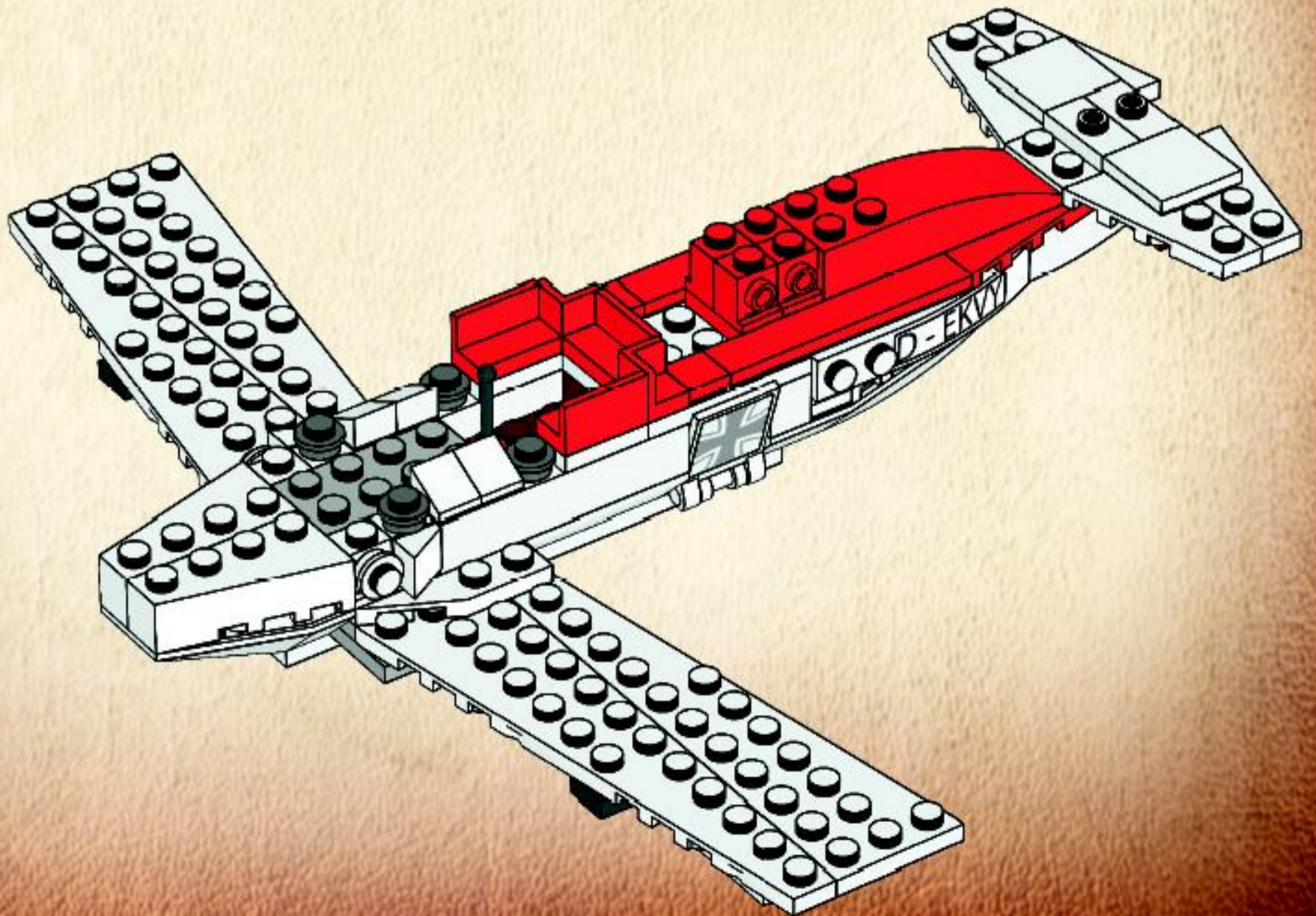

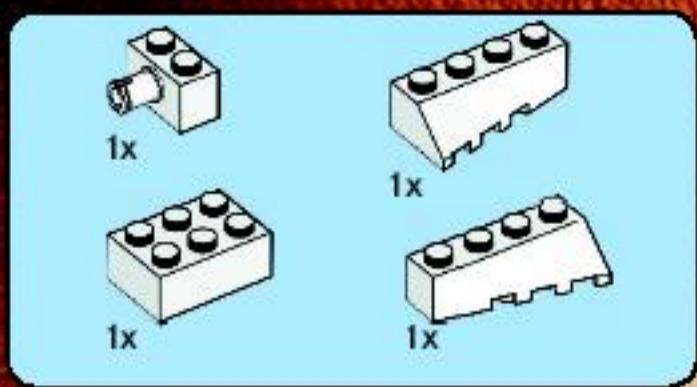

28

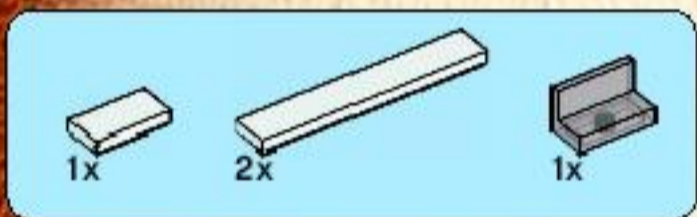
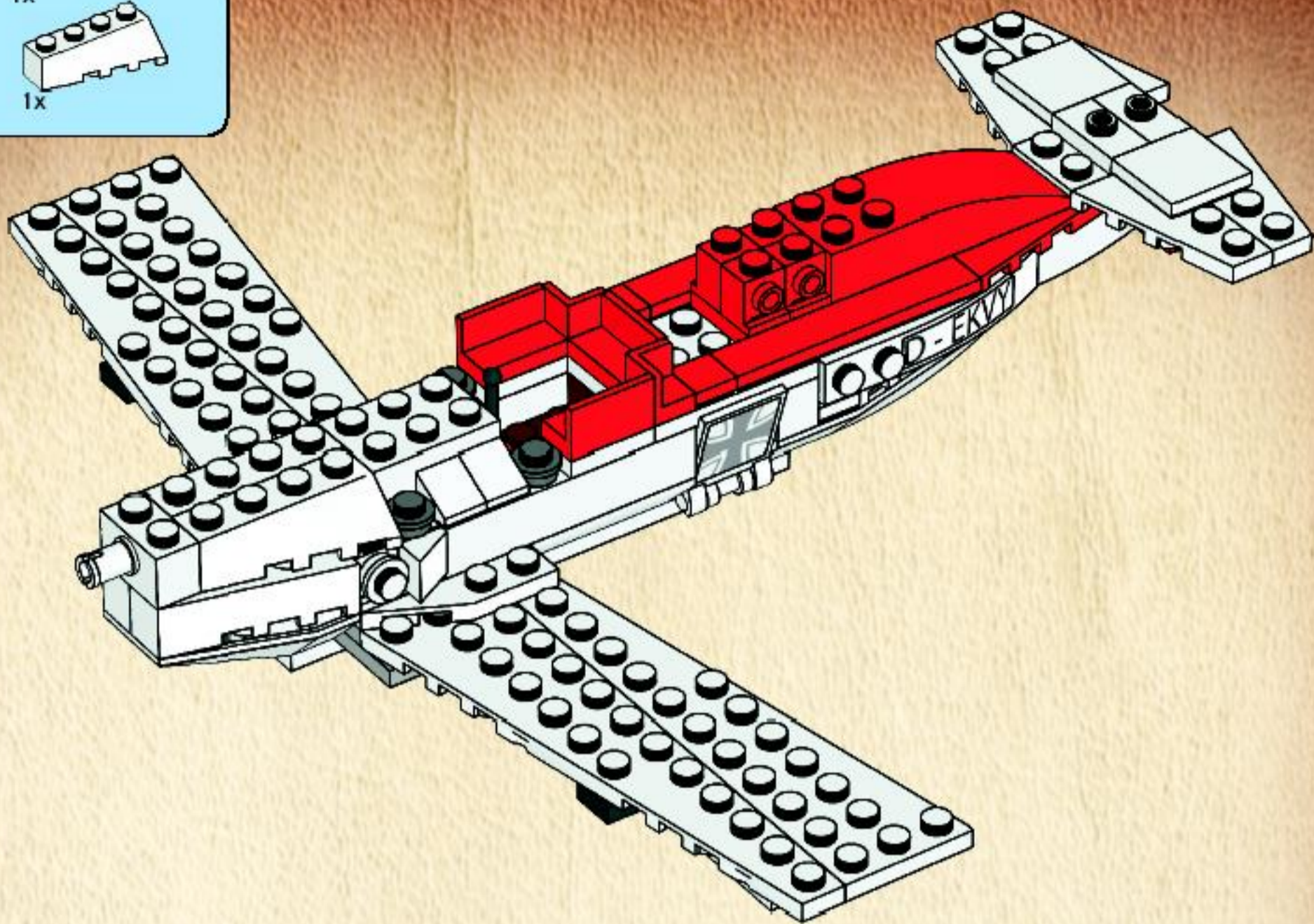

29

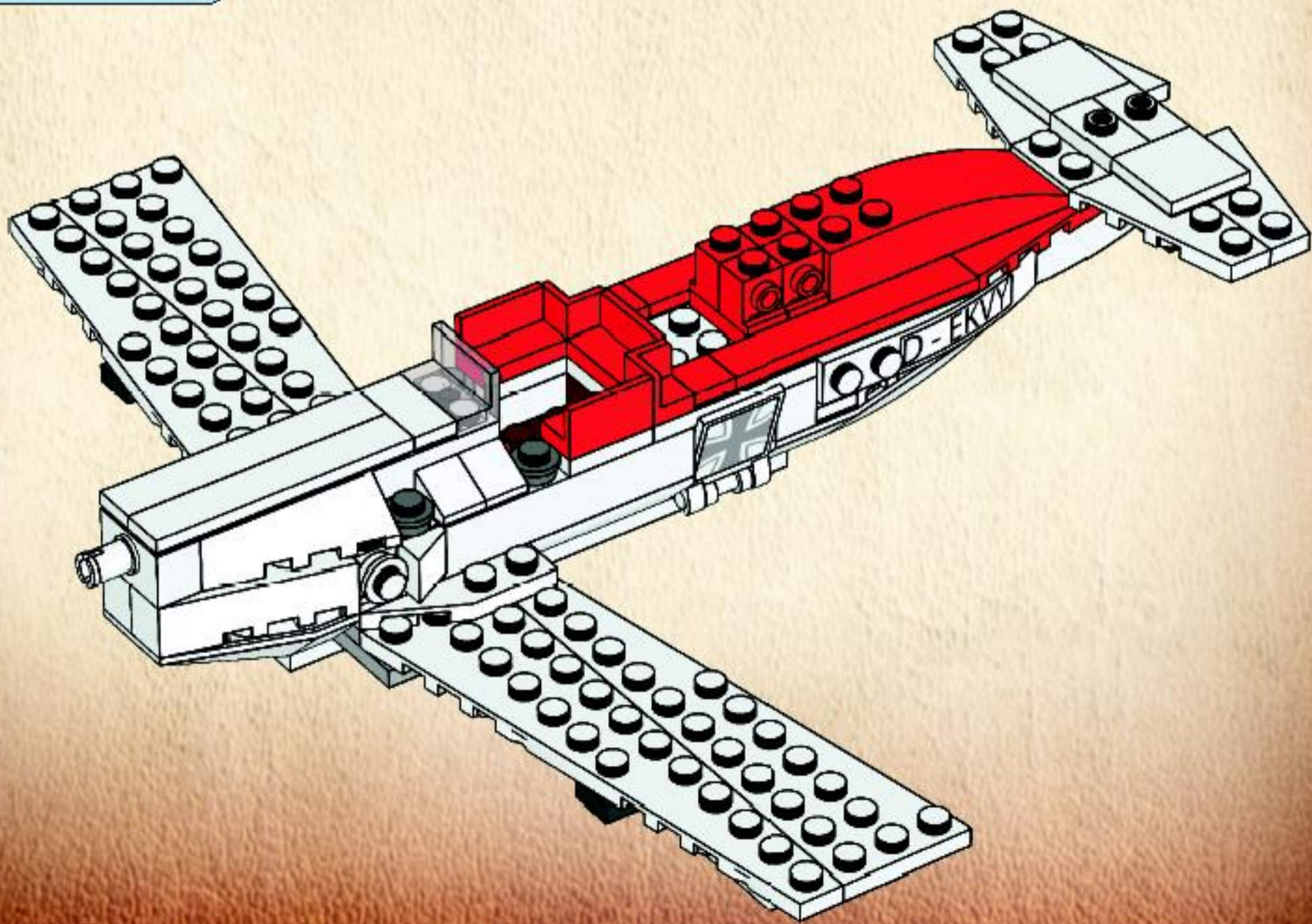

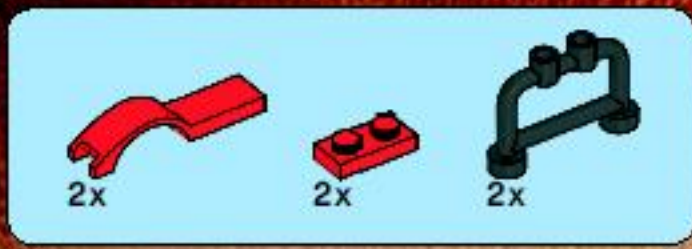

30

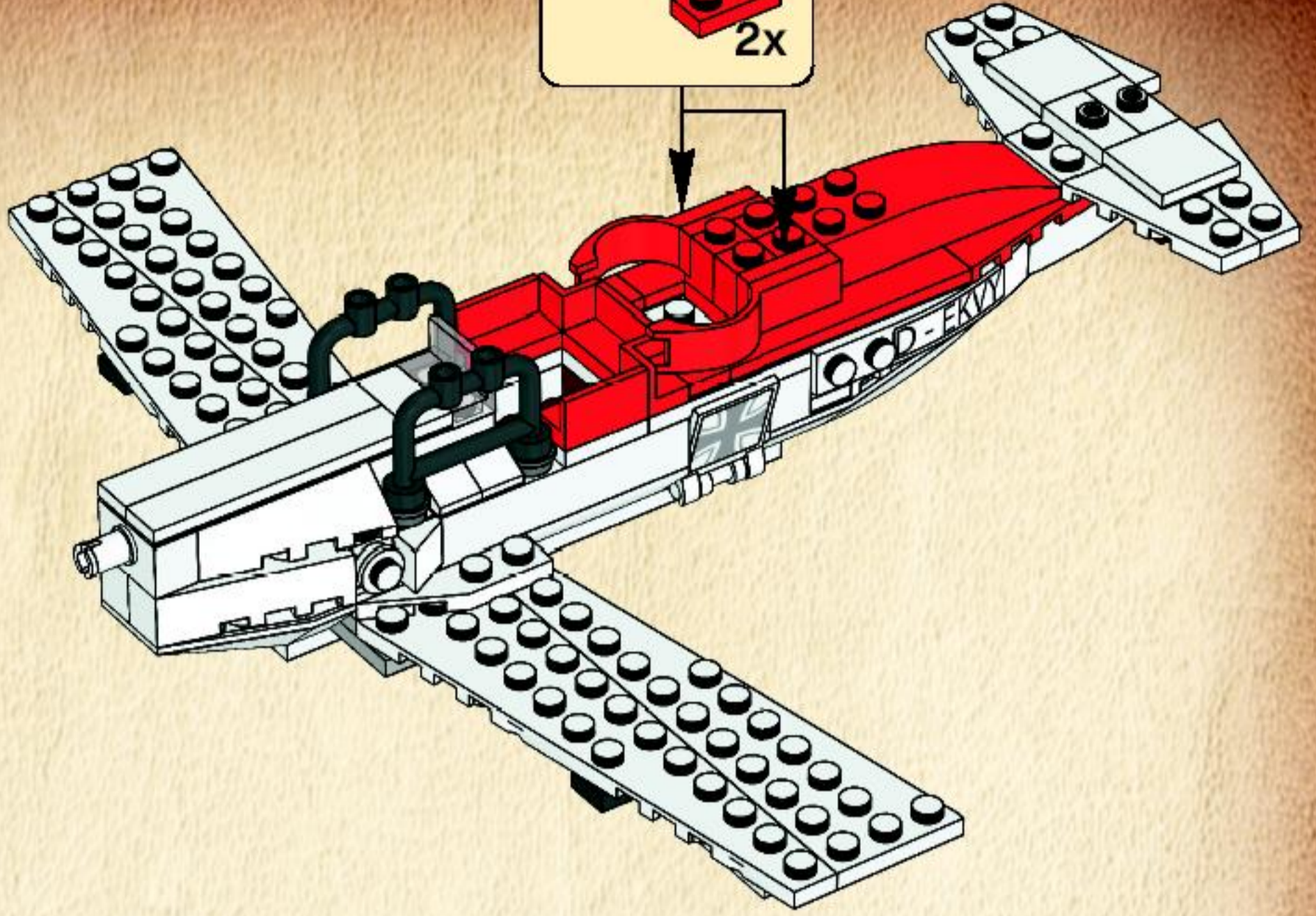
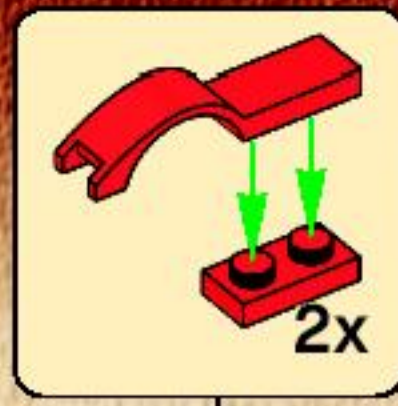

31

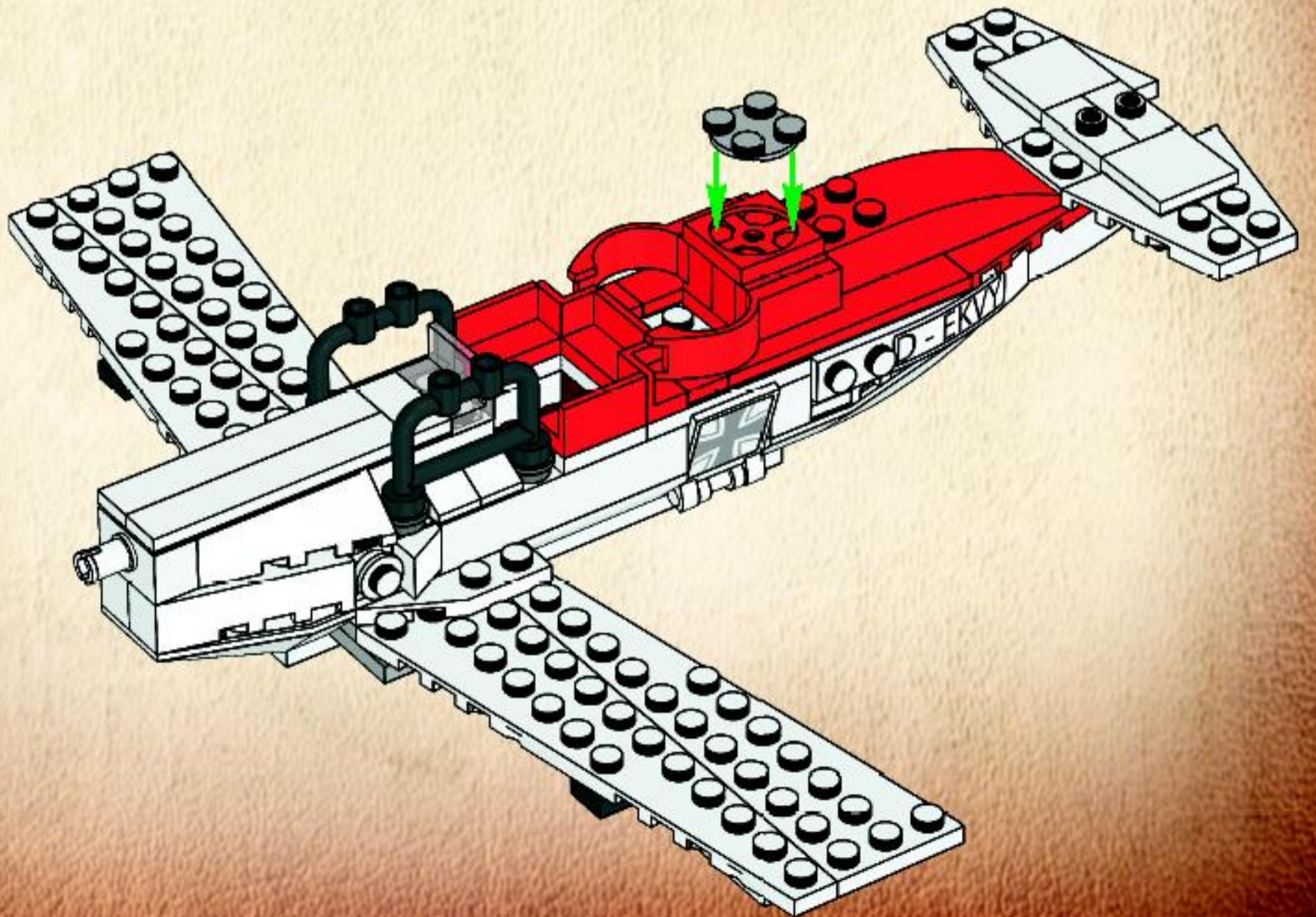



4x

32

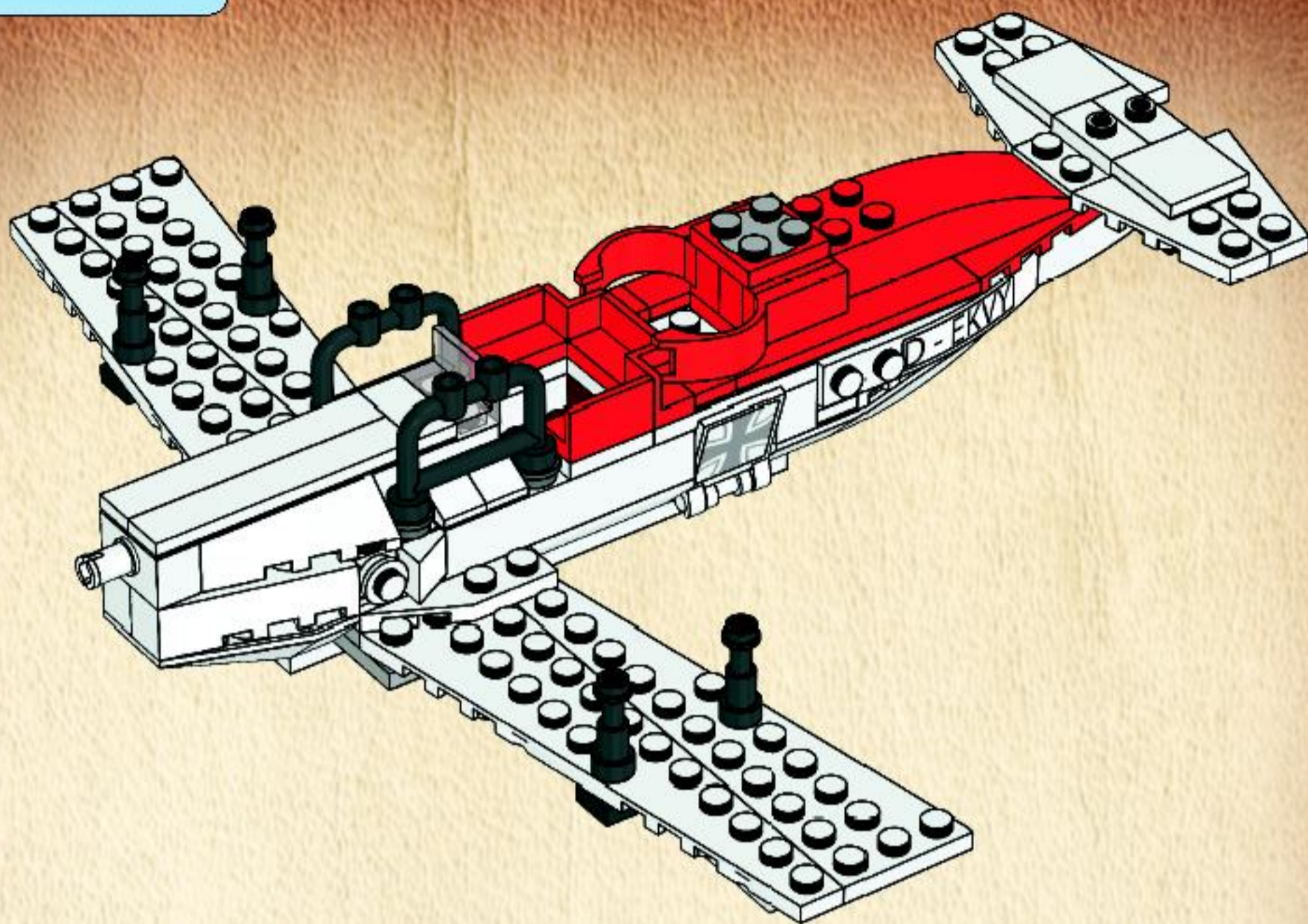

2x

33

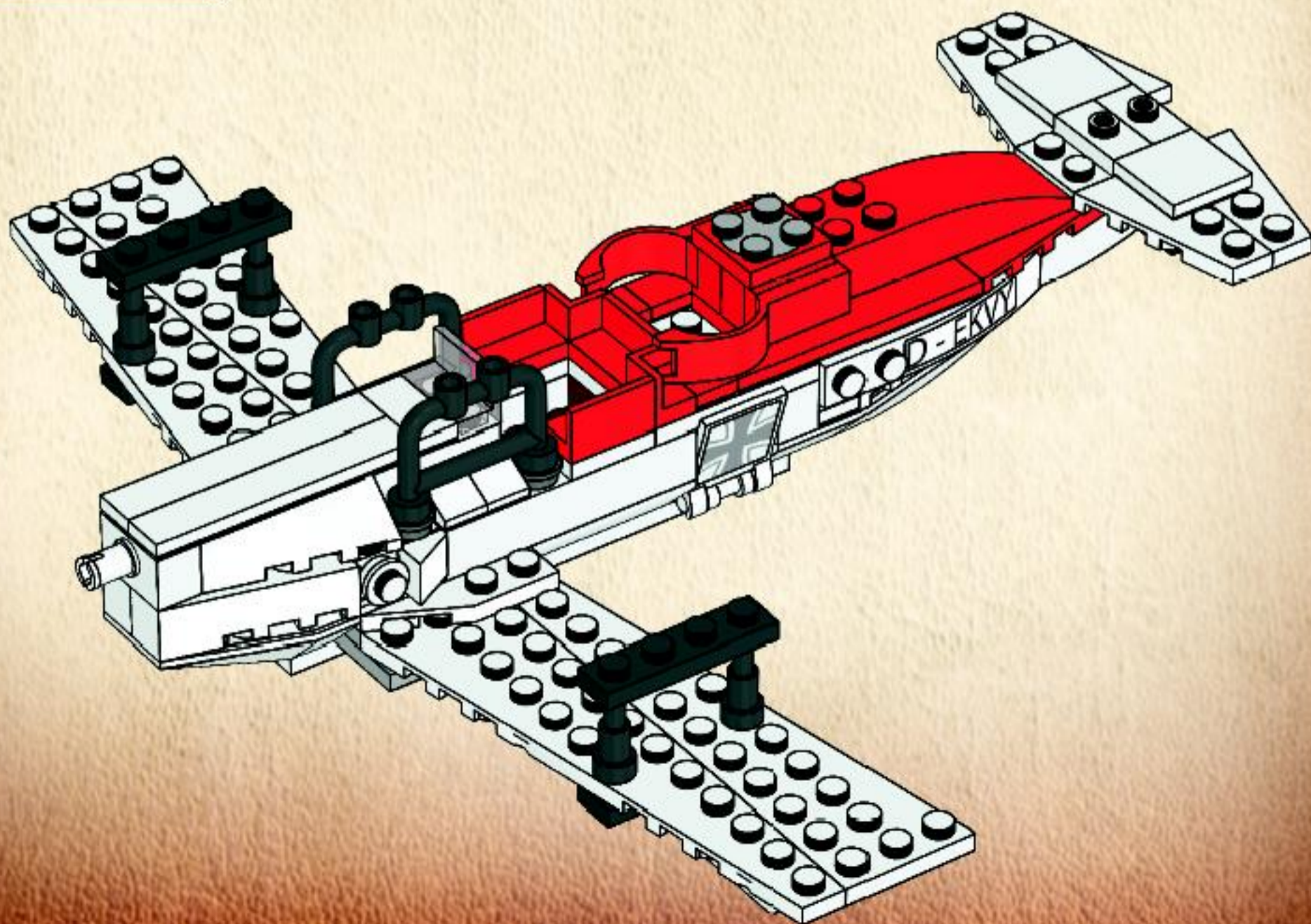



4x

34

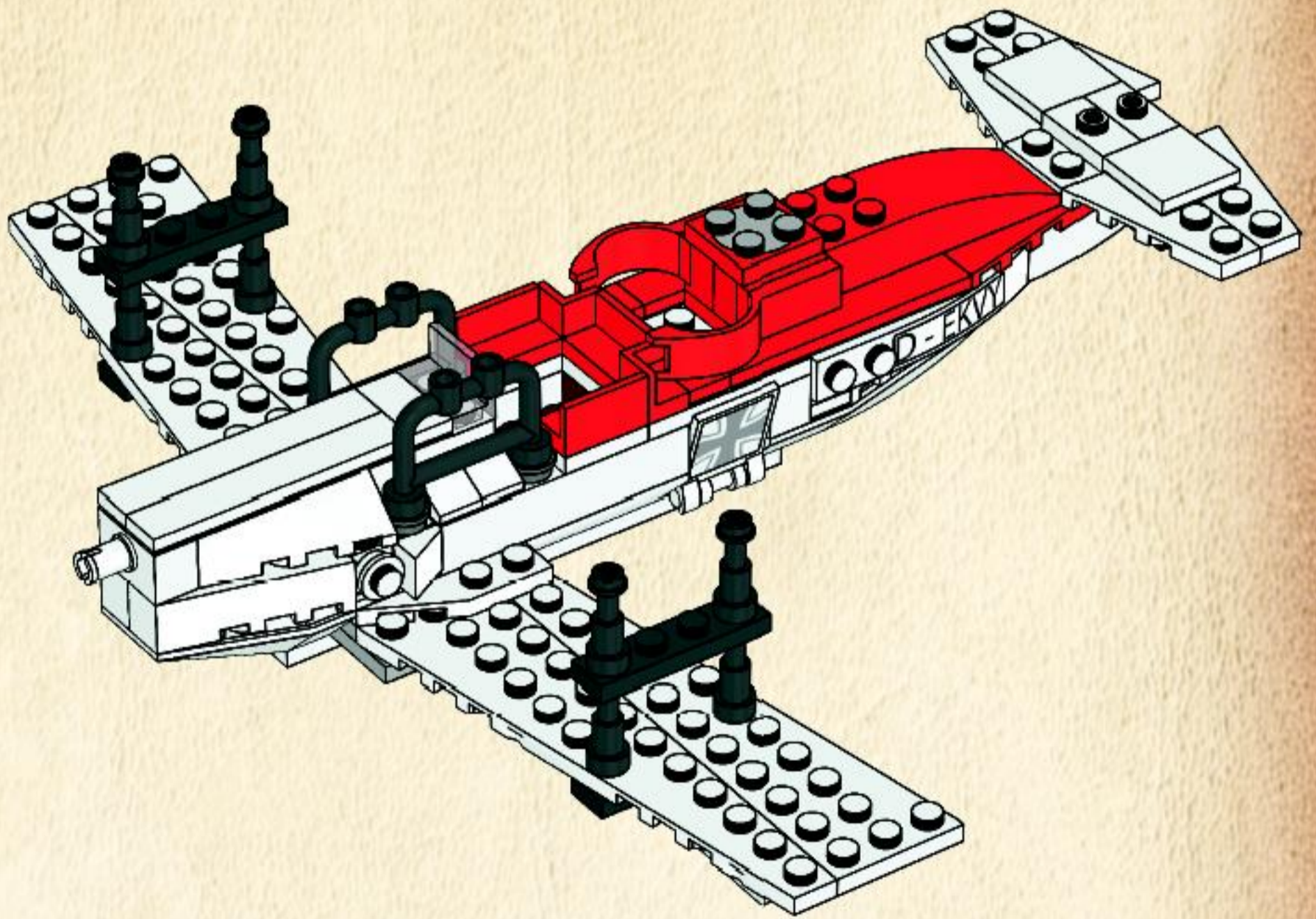

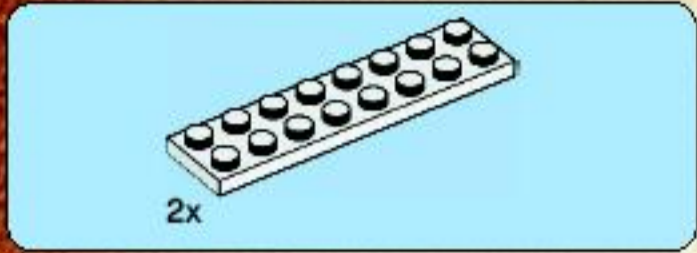
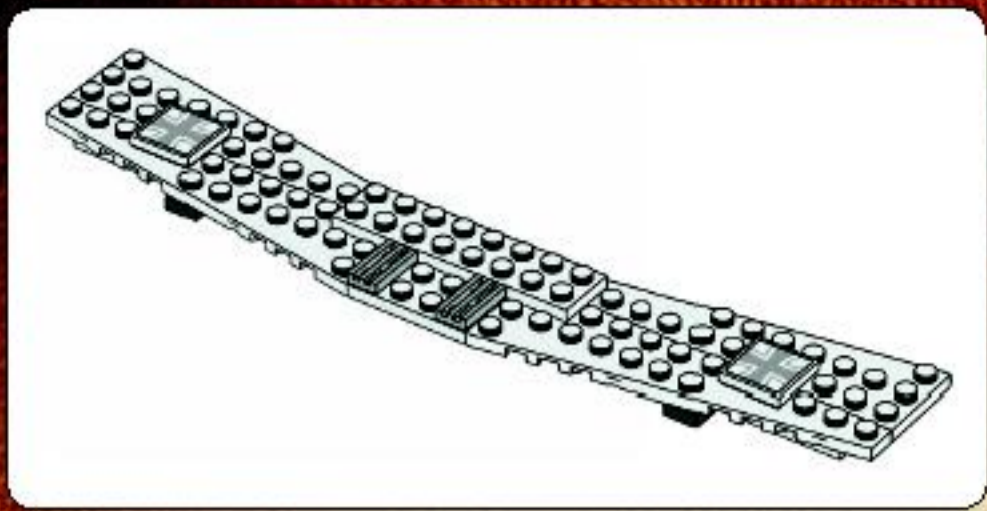

1

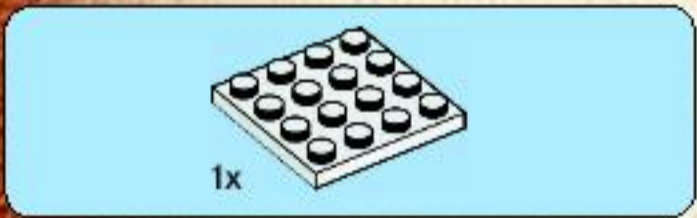
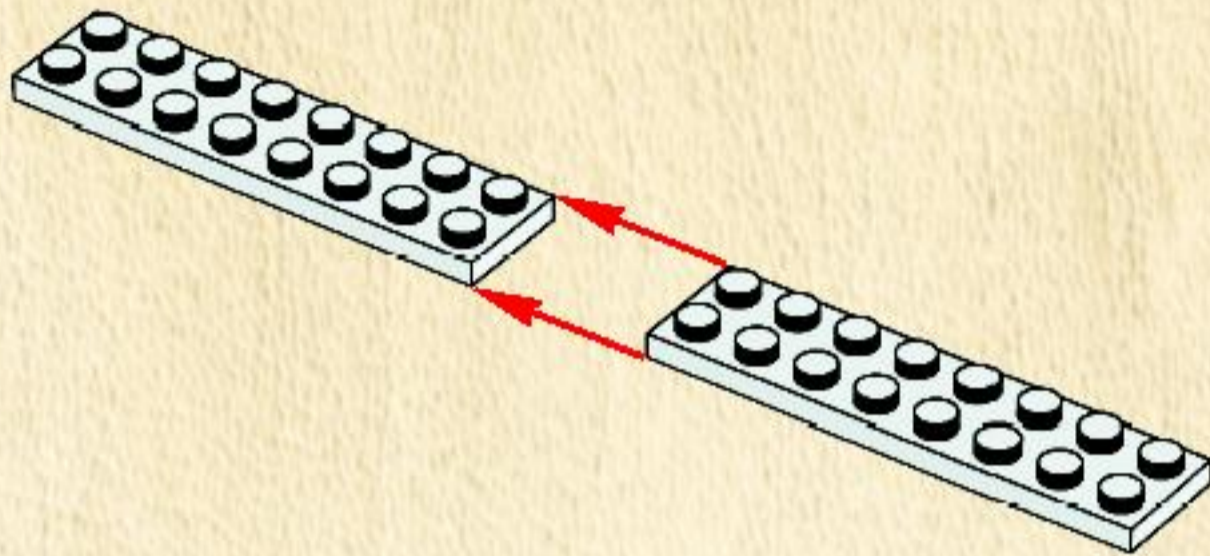

2

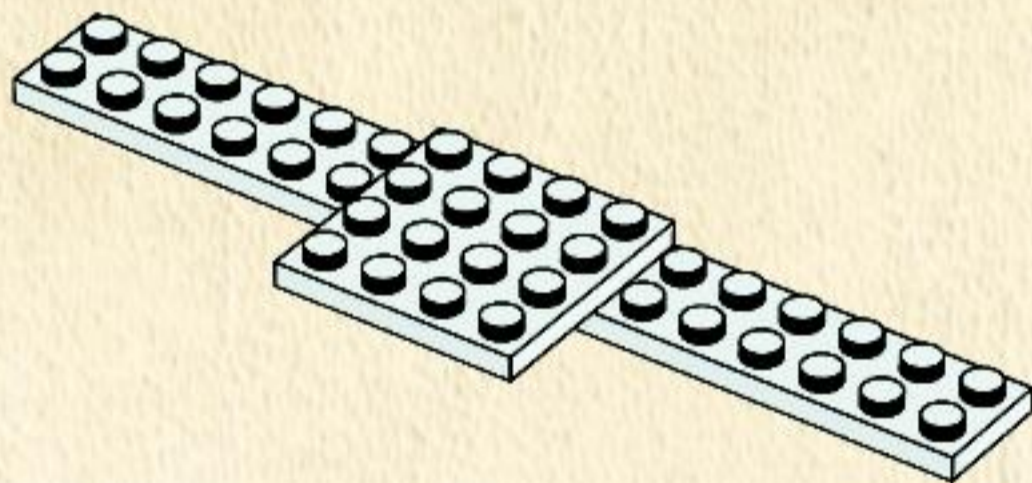

3

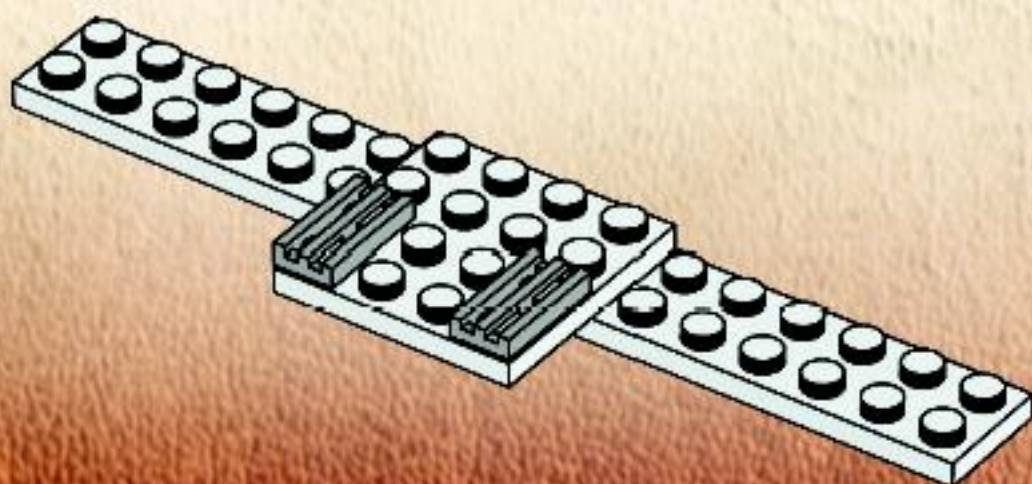

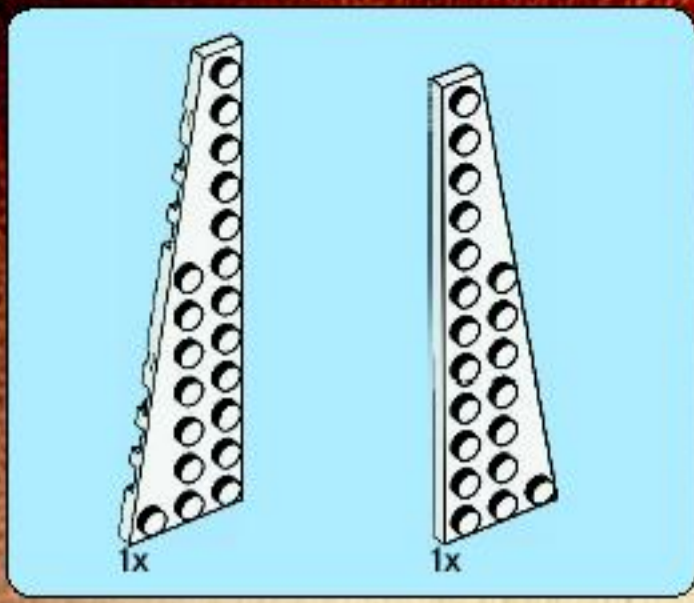

4

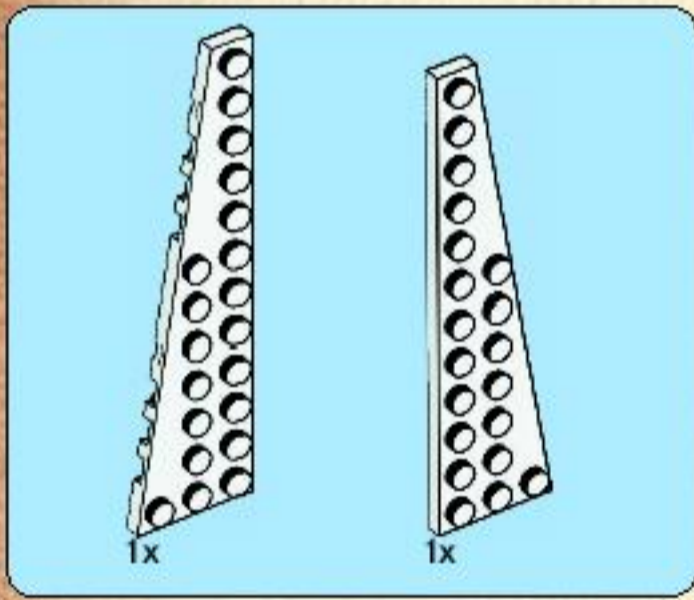
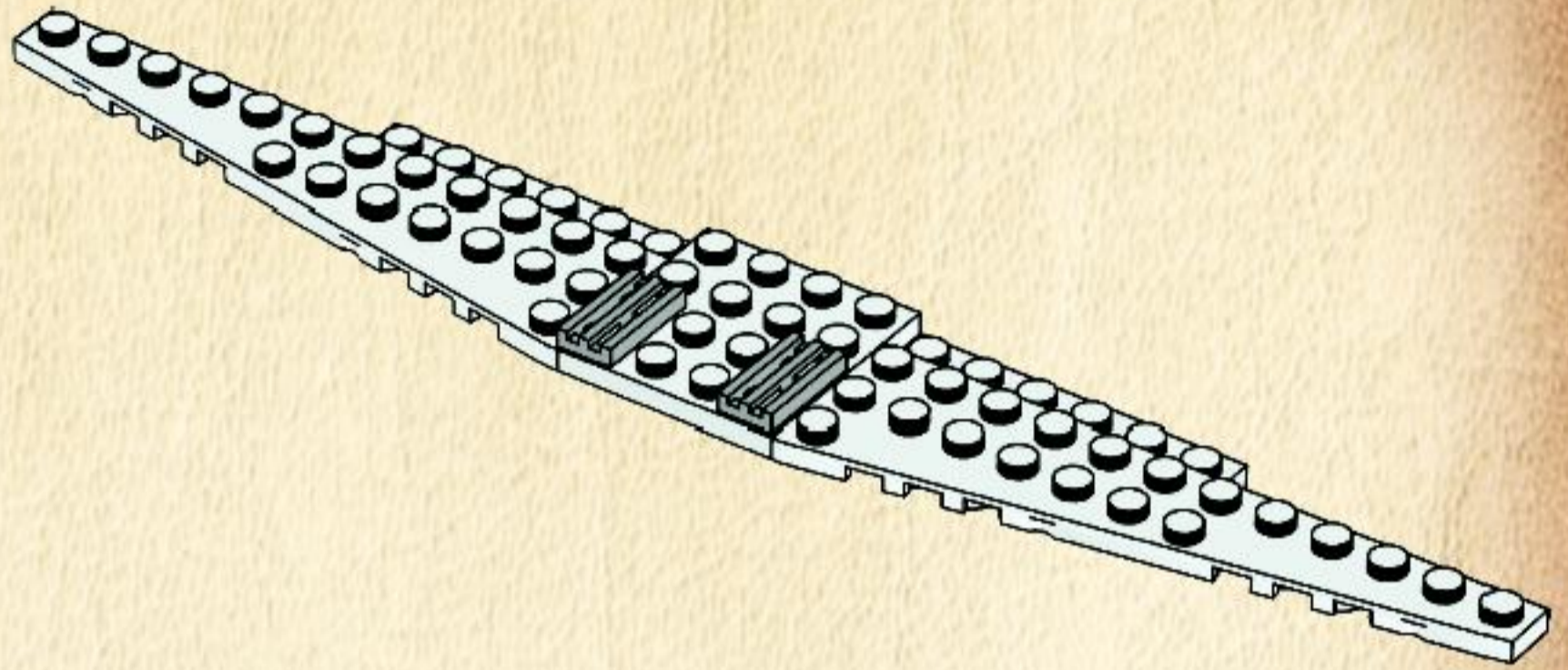

5

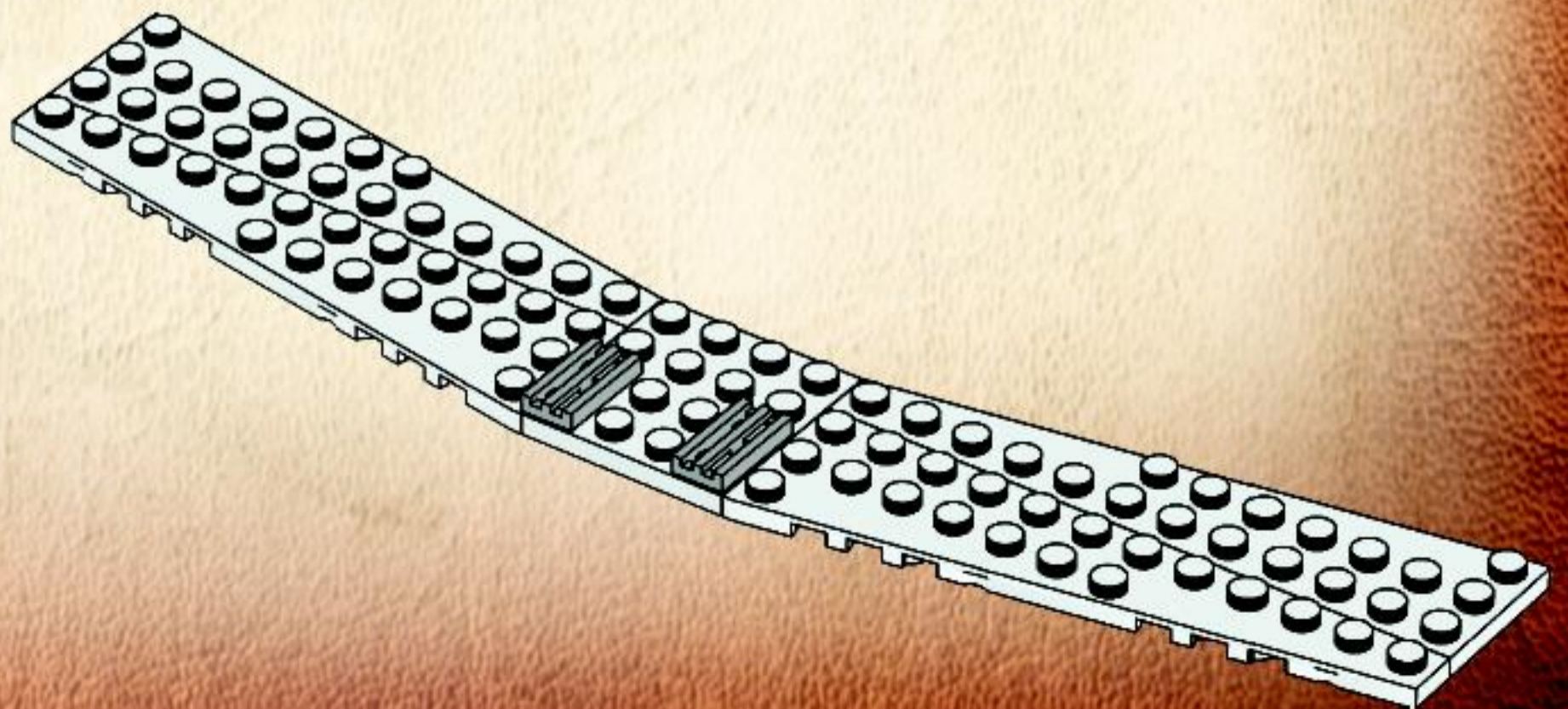



6

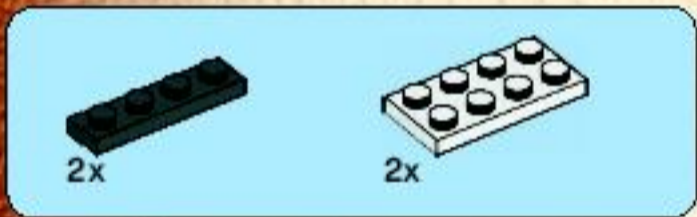
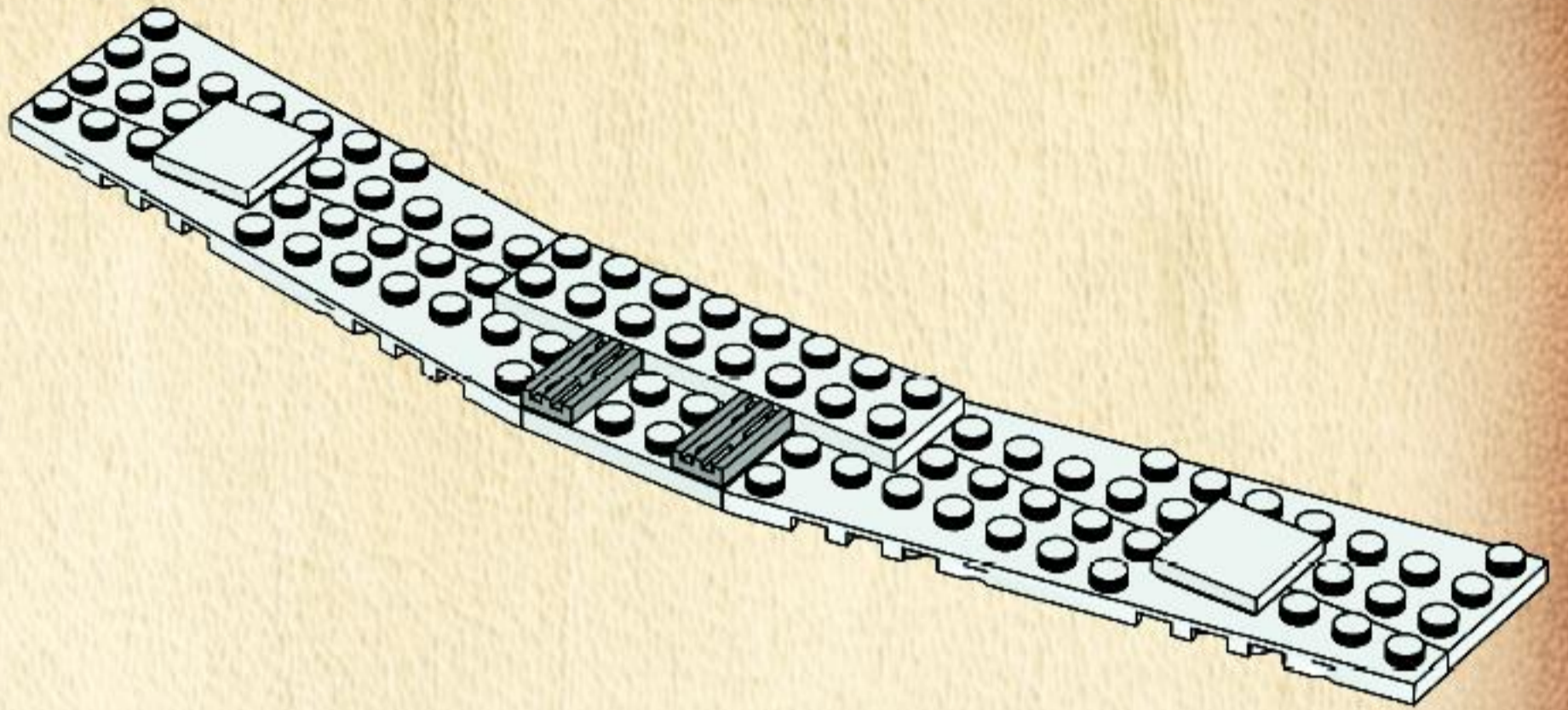

7

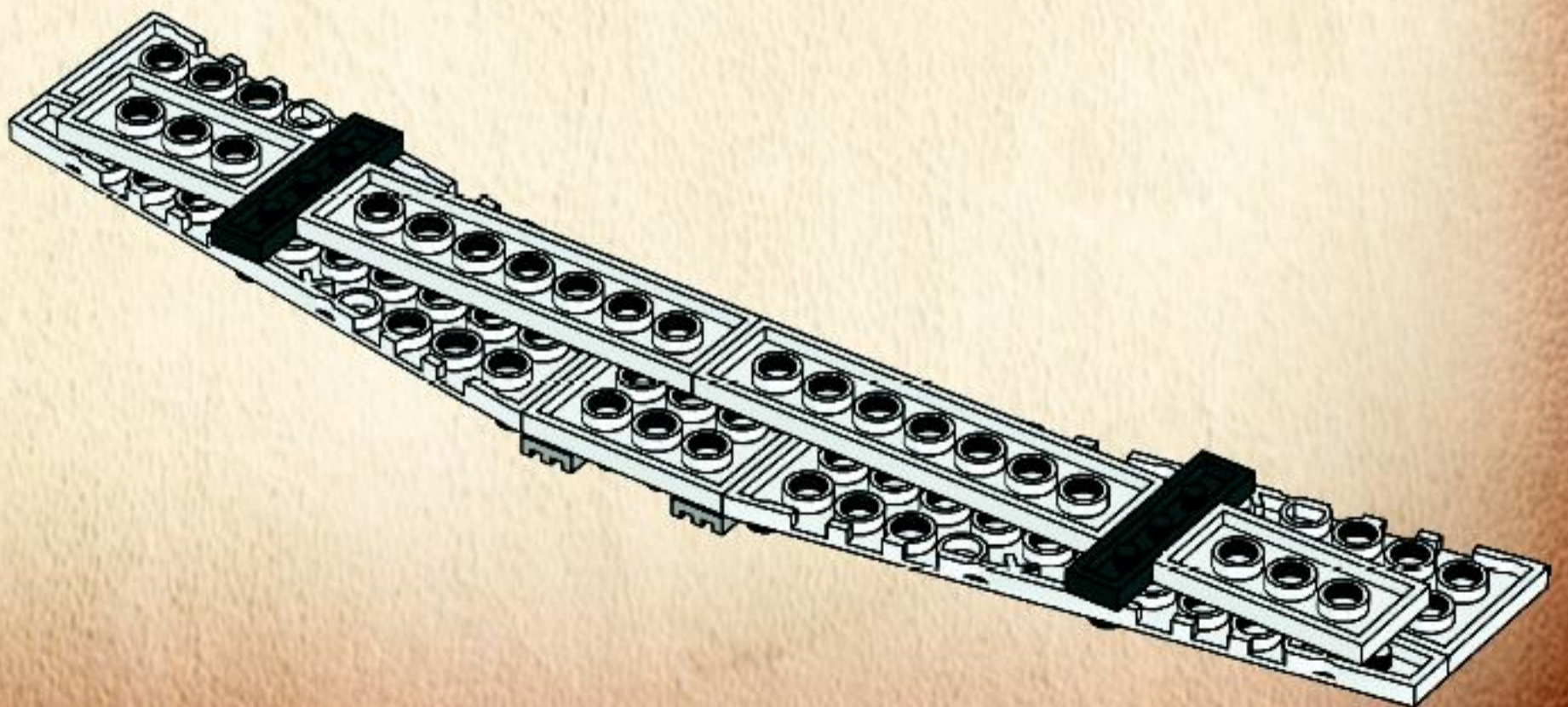

8

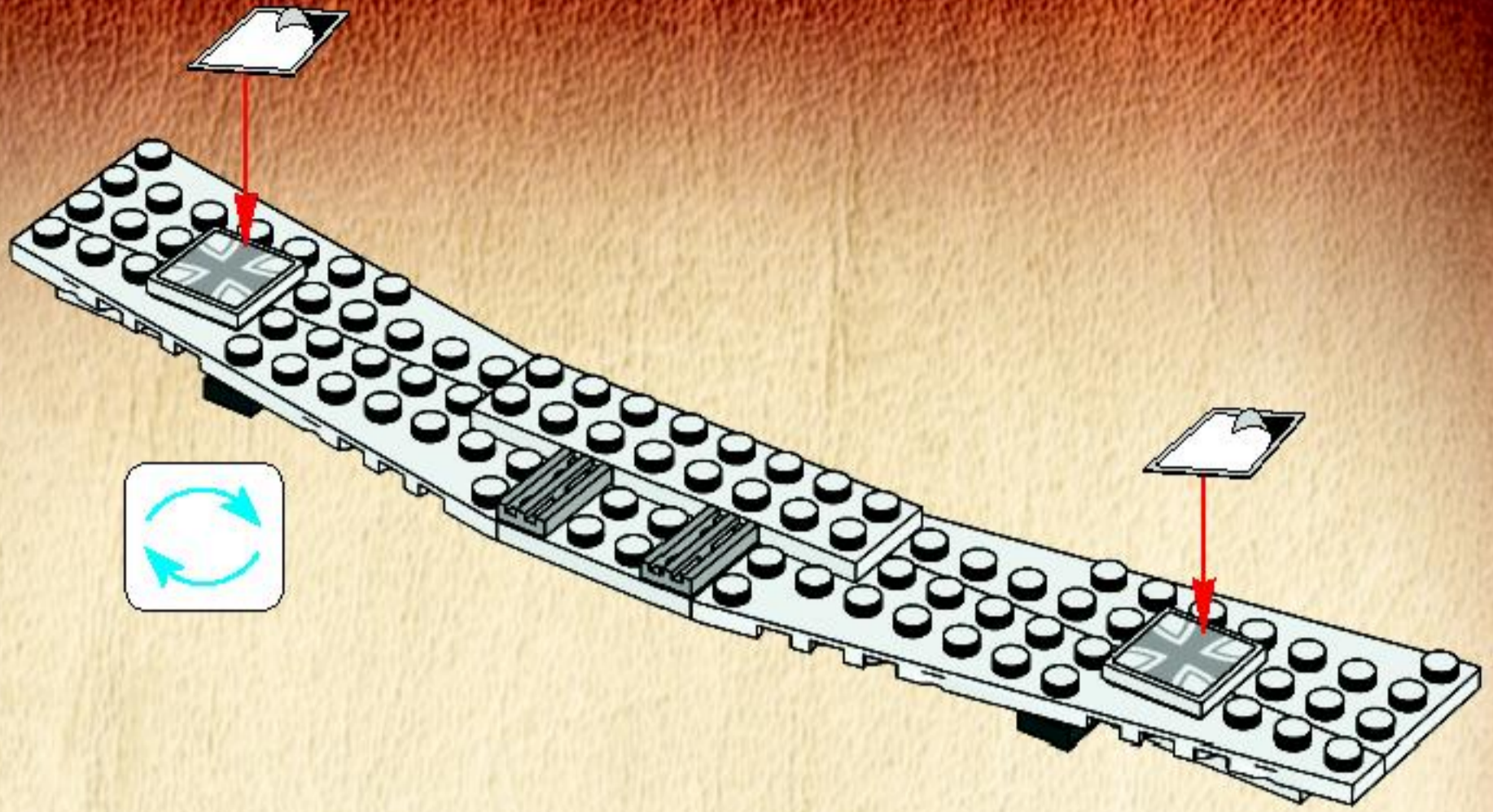

35

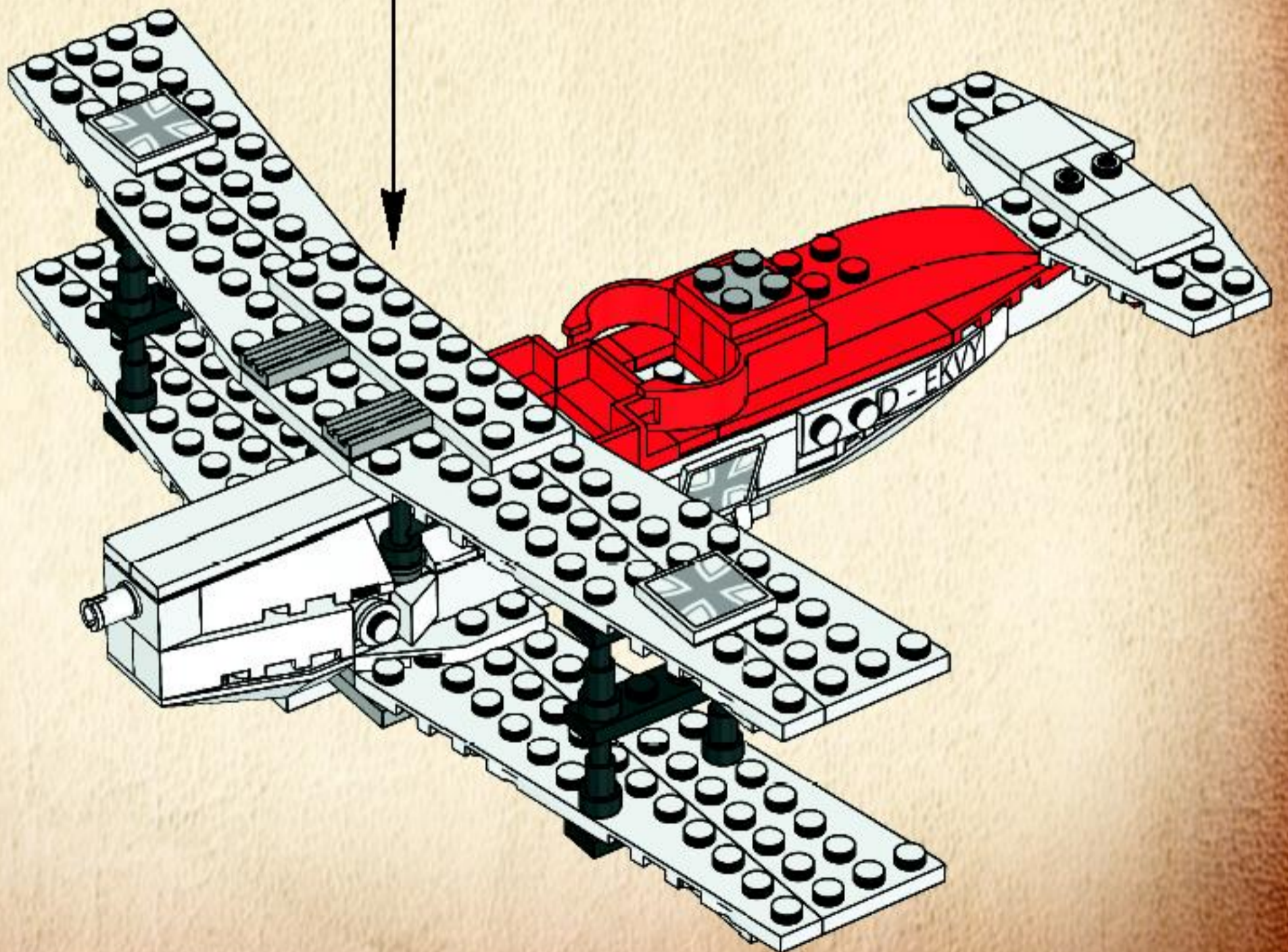

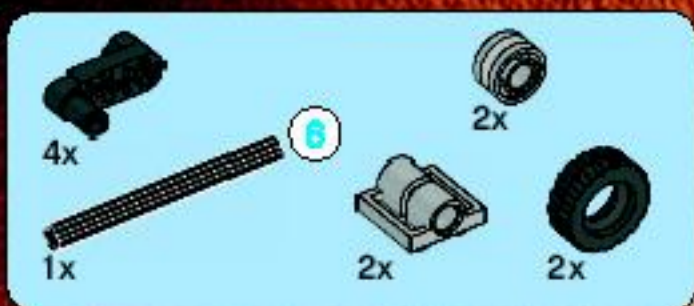

36

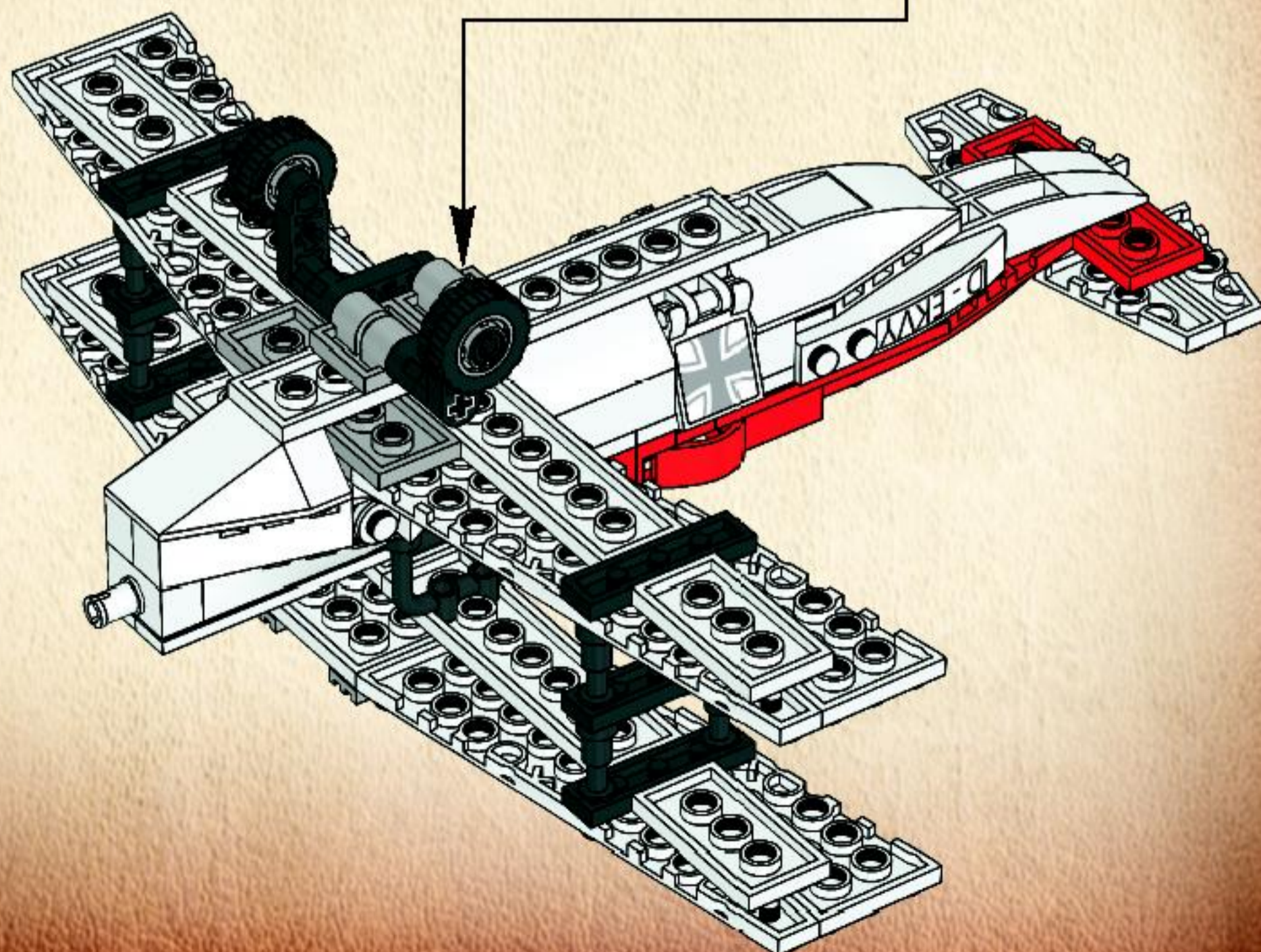
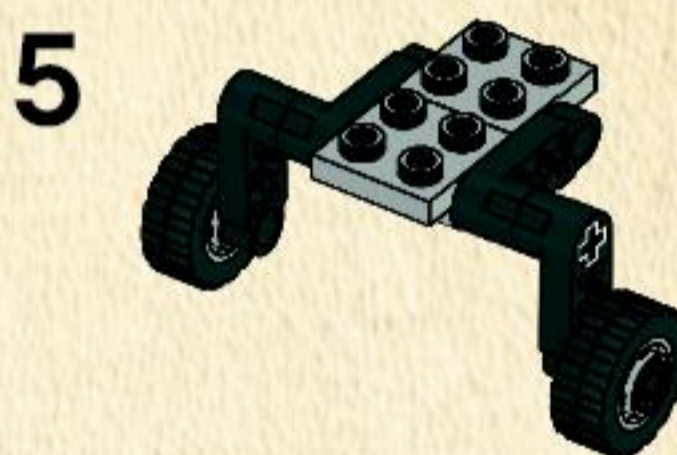
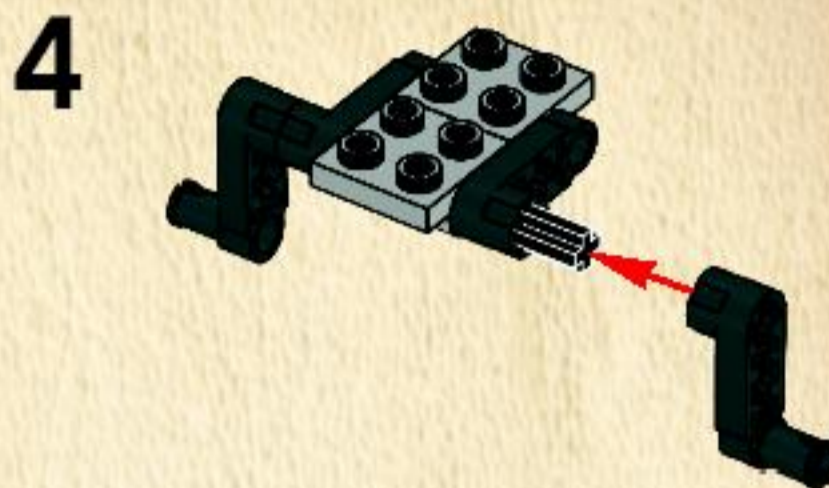
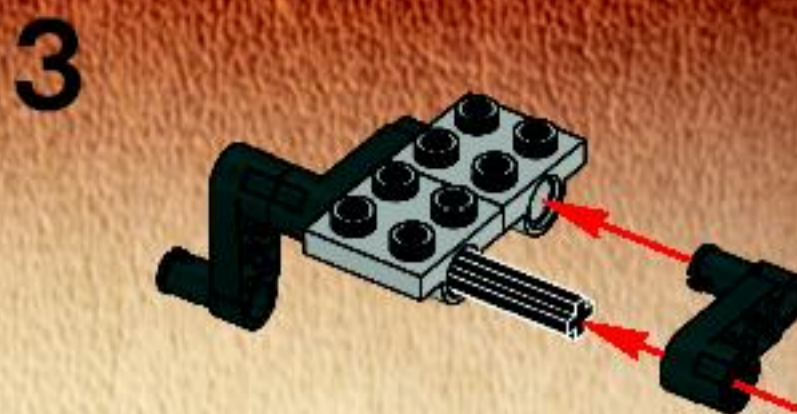
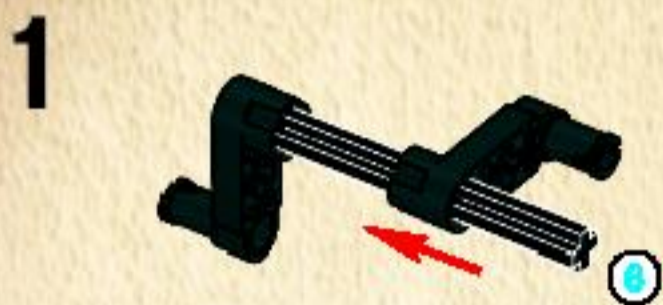



37

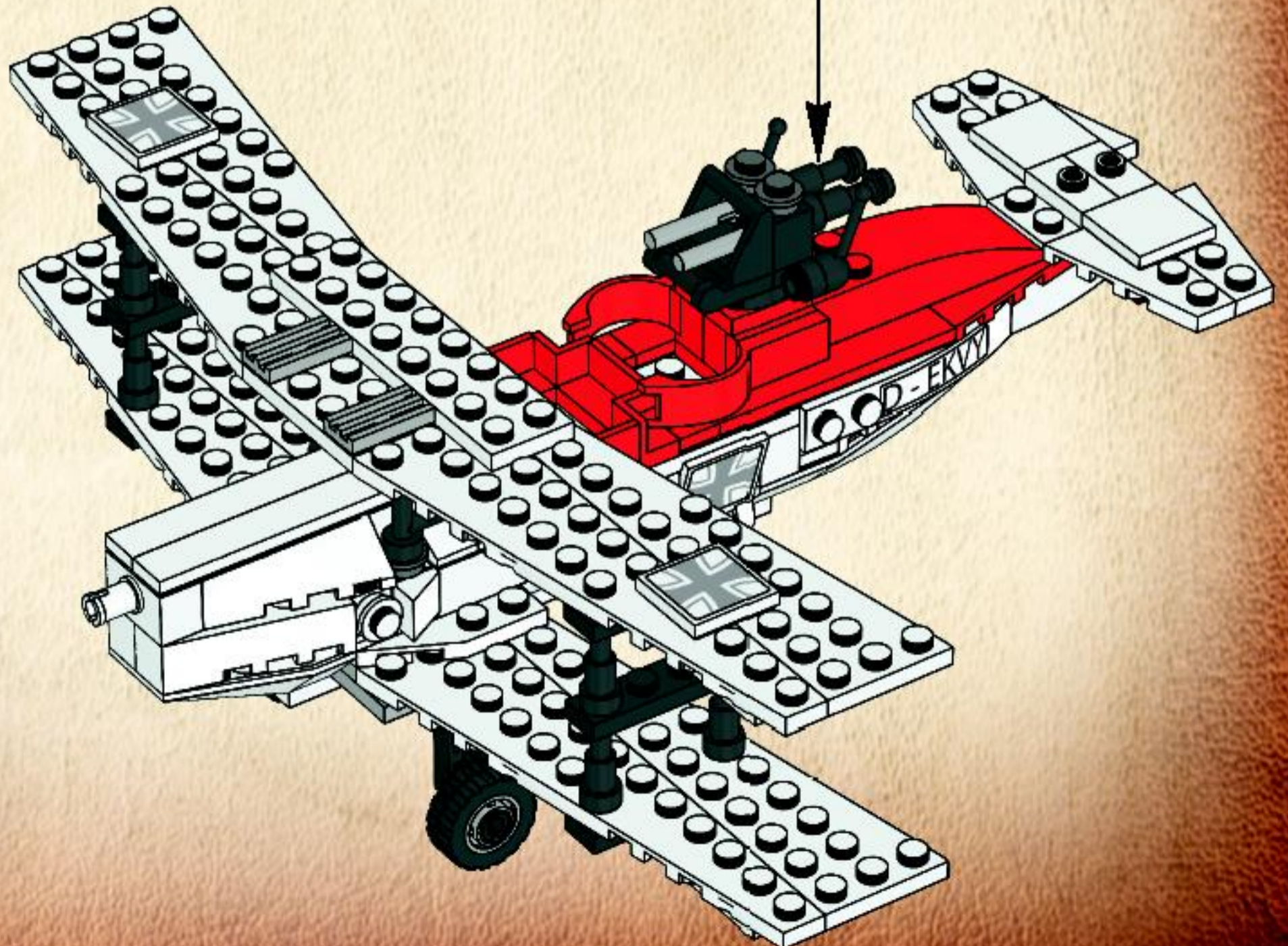
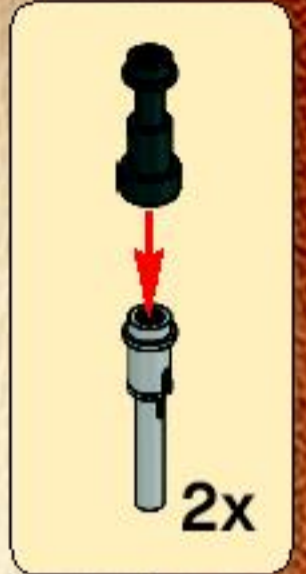
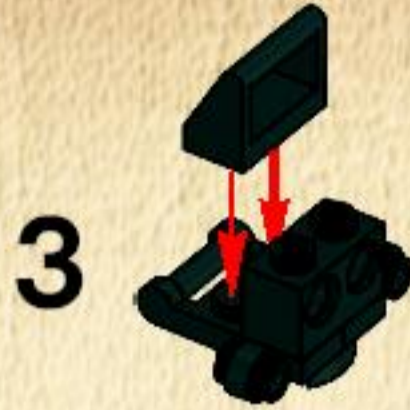

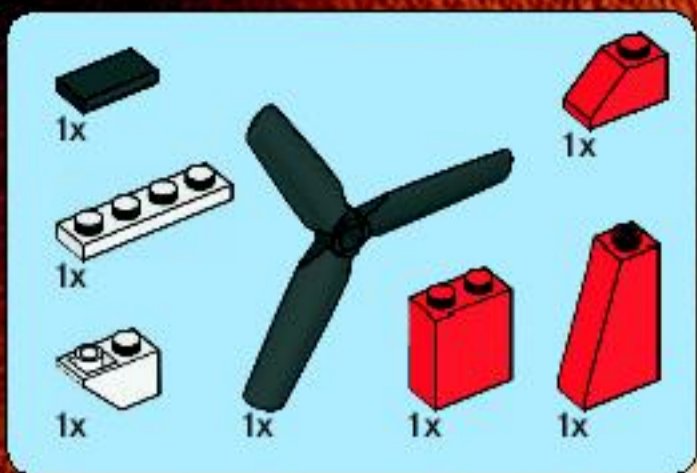

38

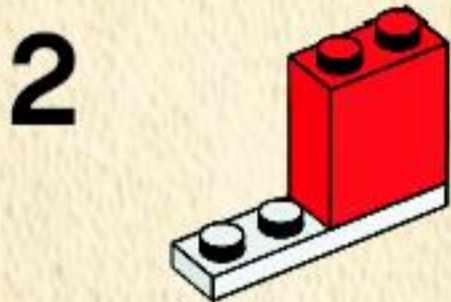
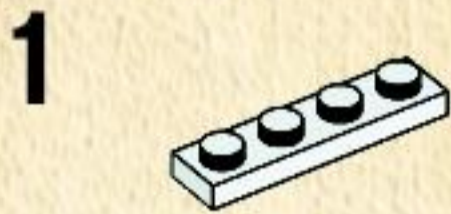

3

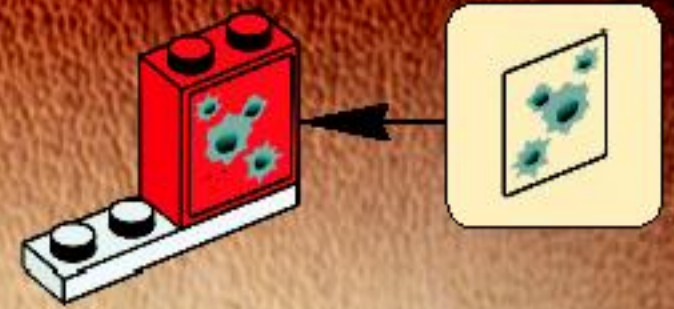

4



5

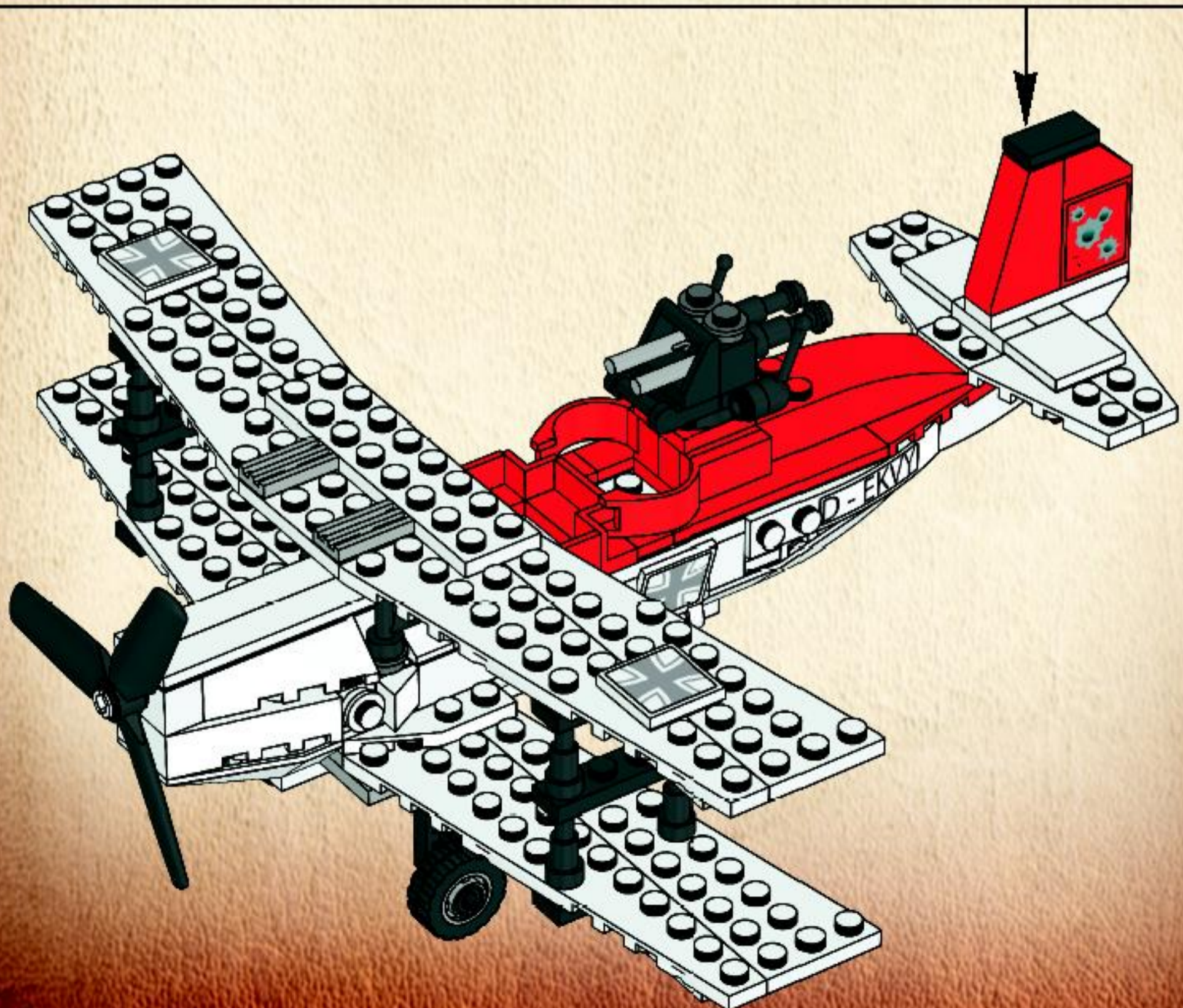



39

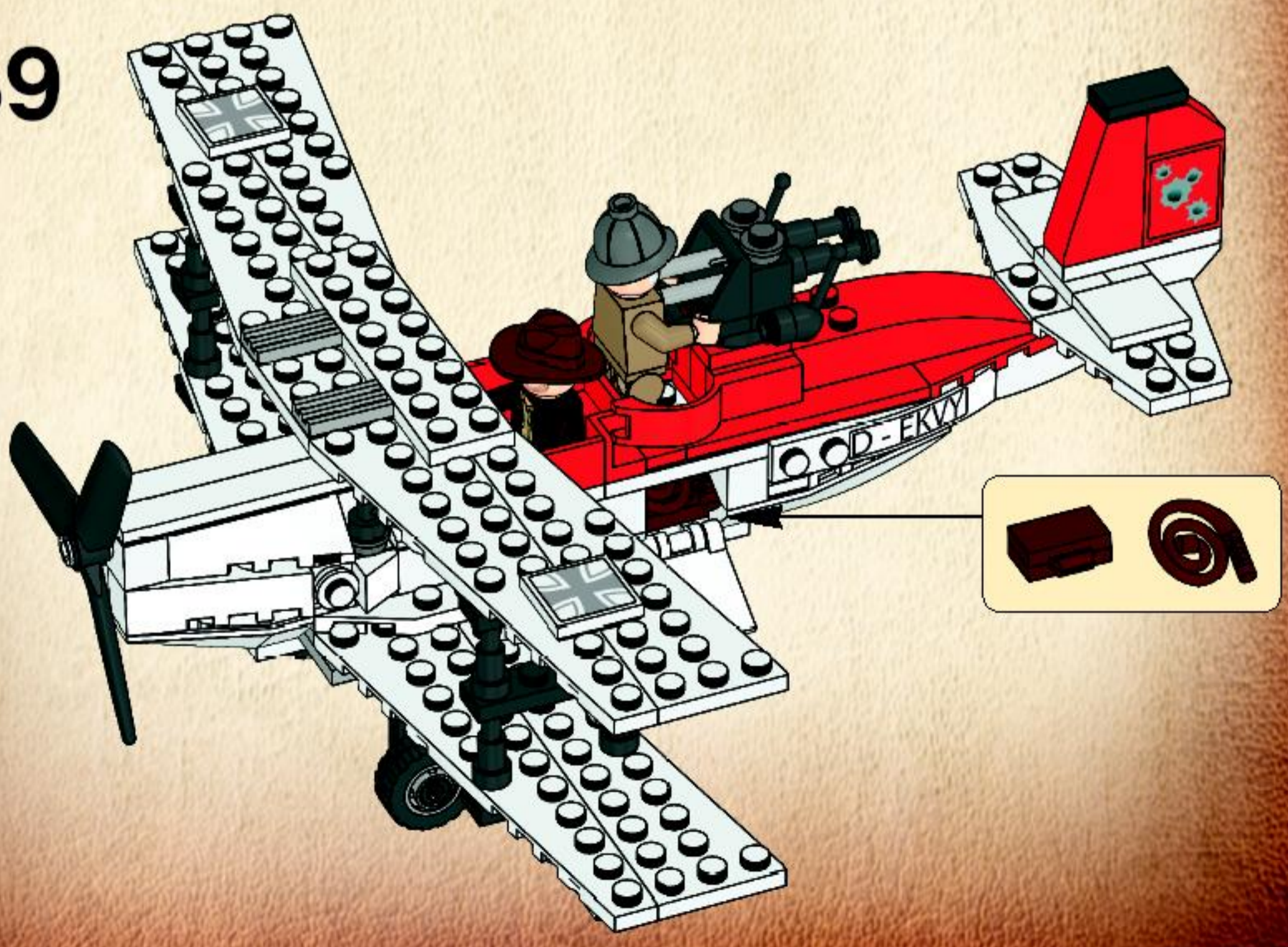

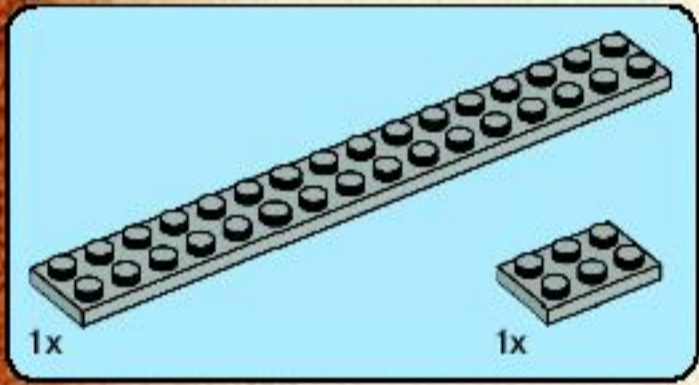
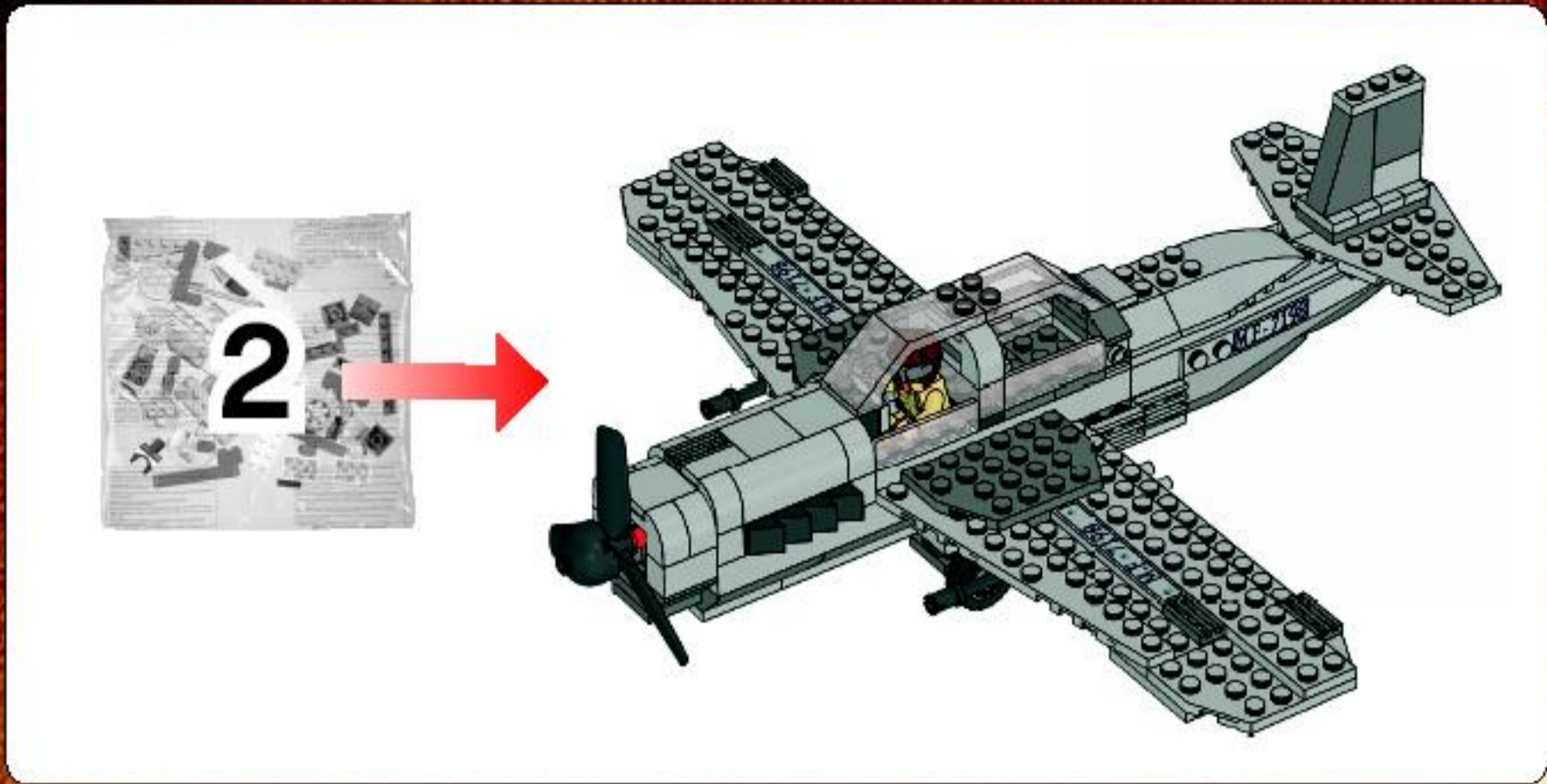

1

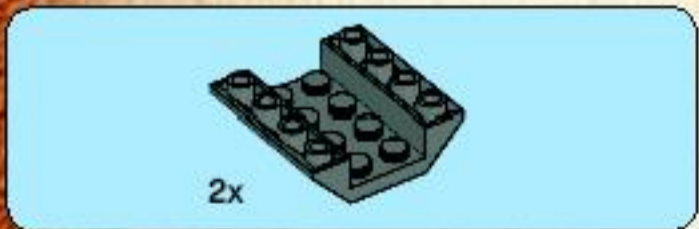
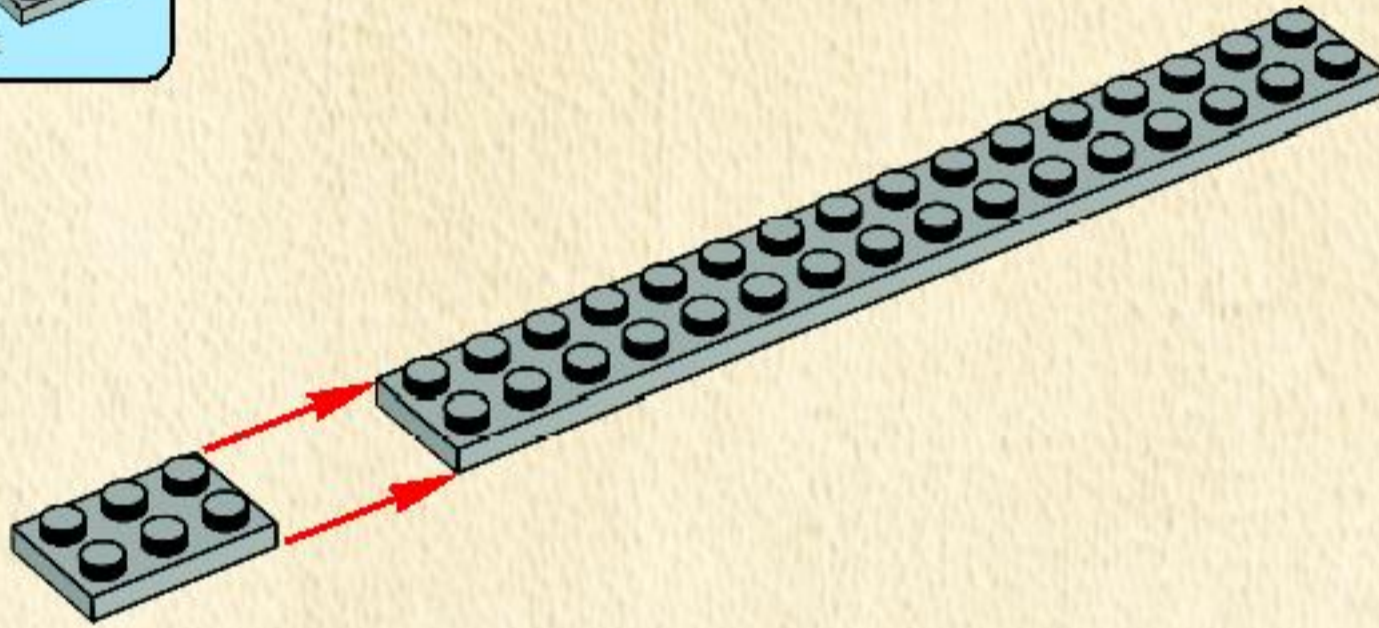

2

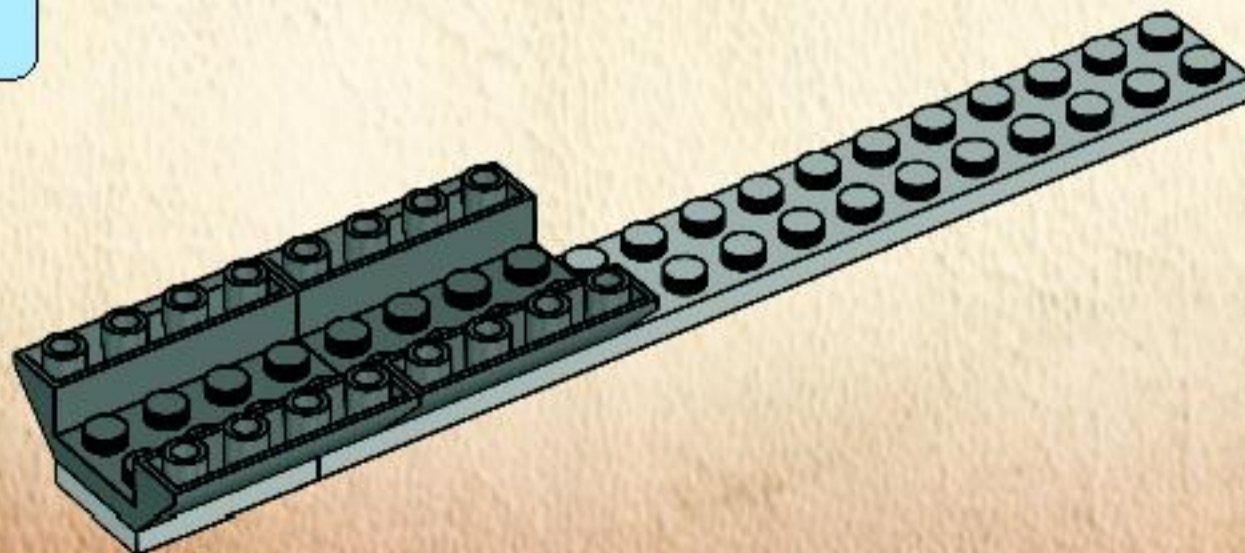

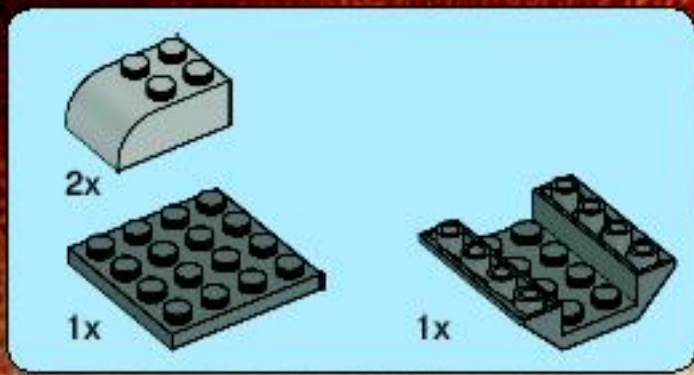

3

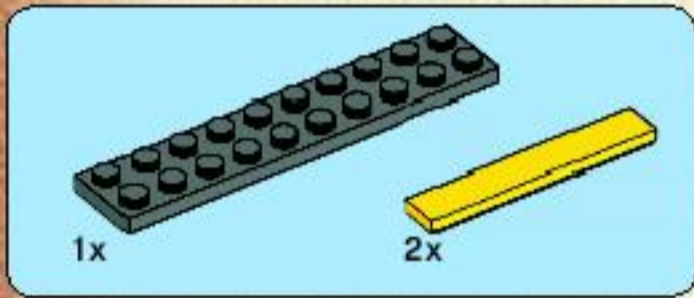
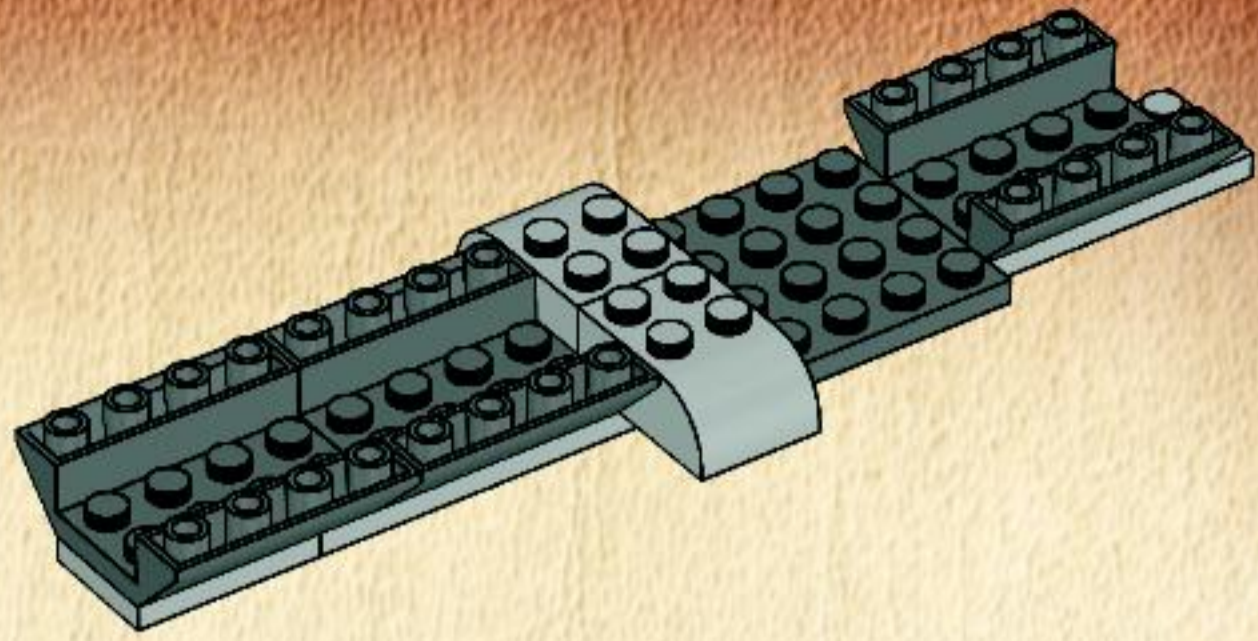

4

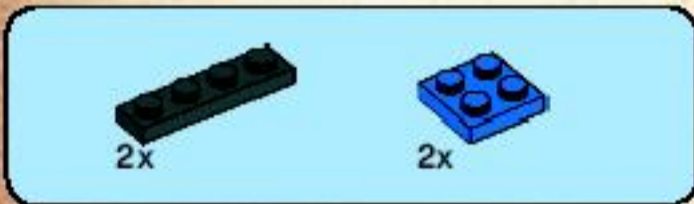
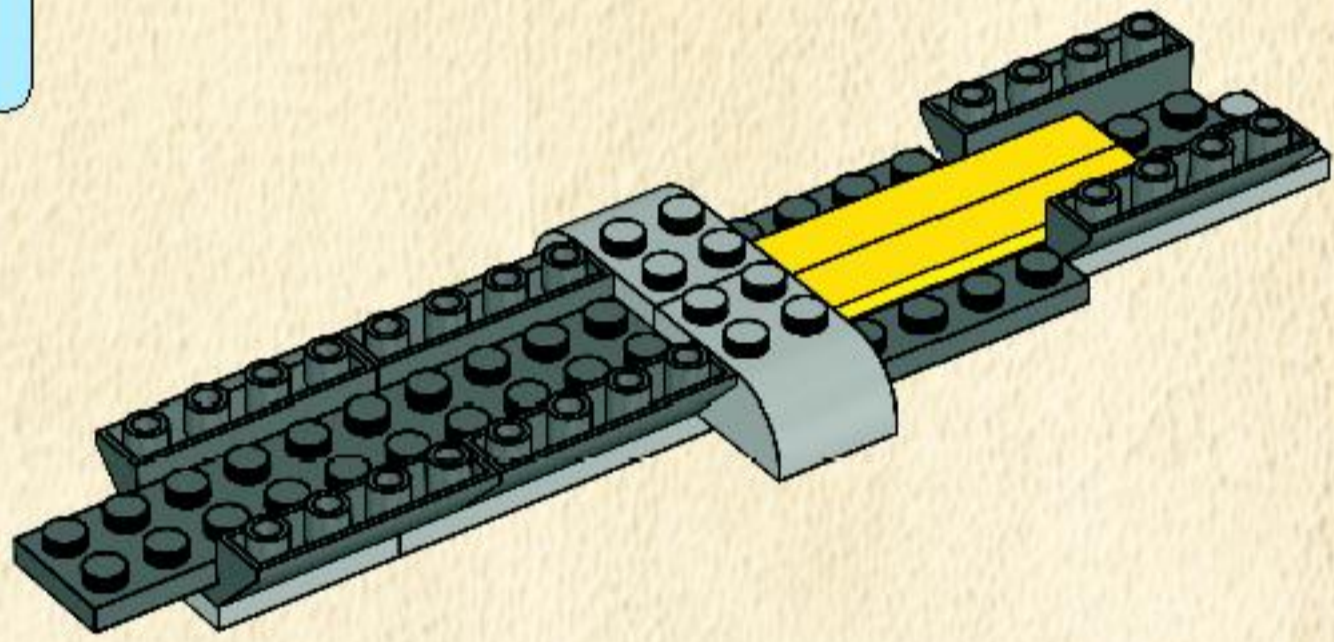

5

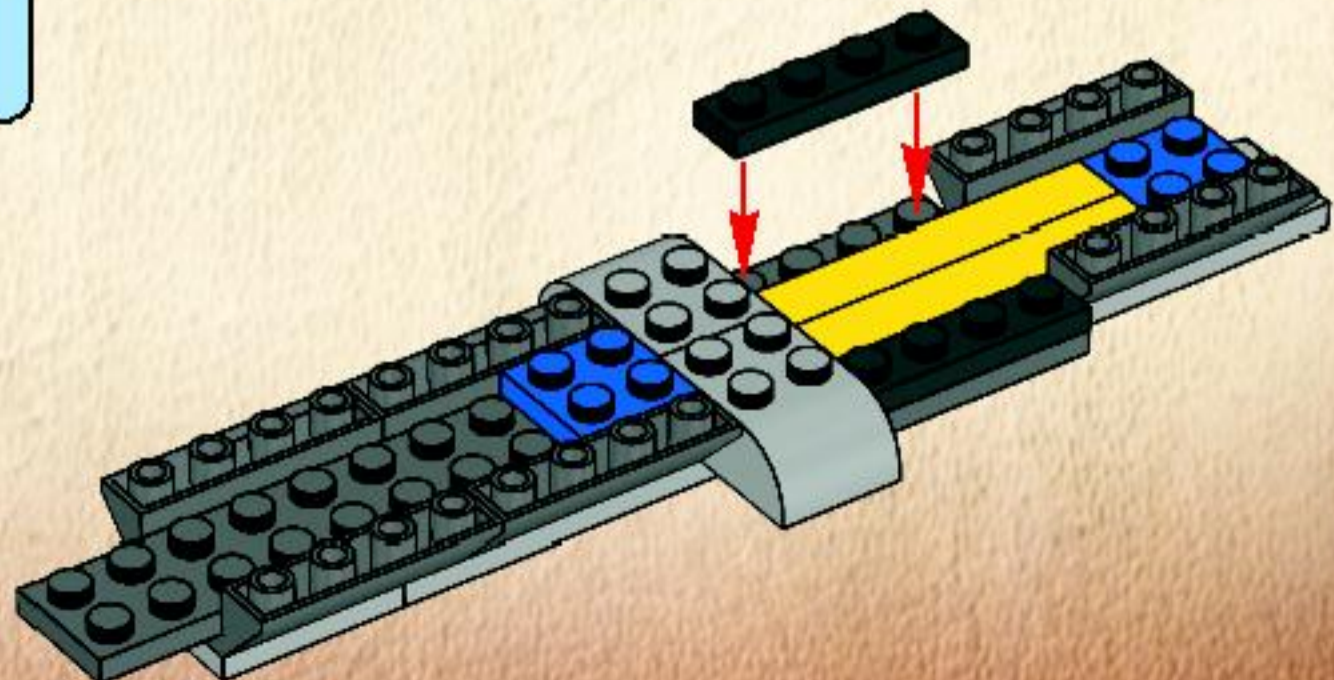



6

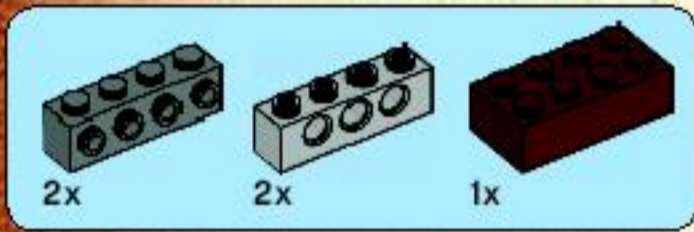
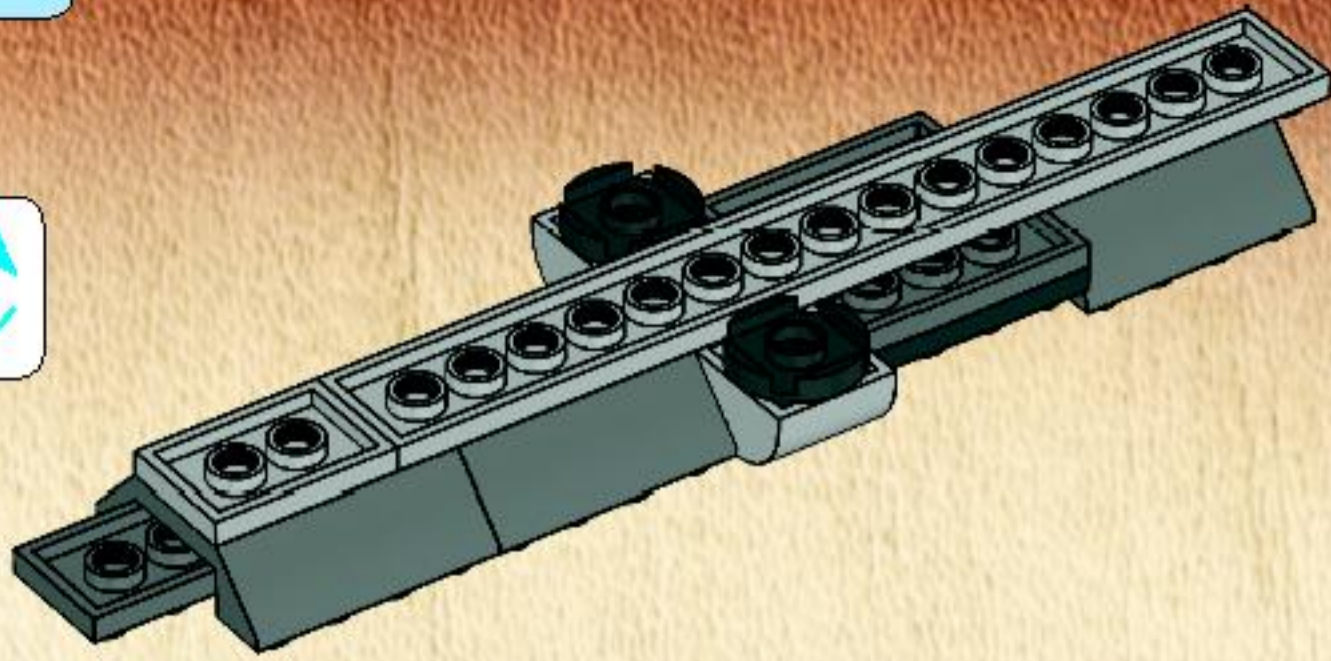

7

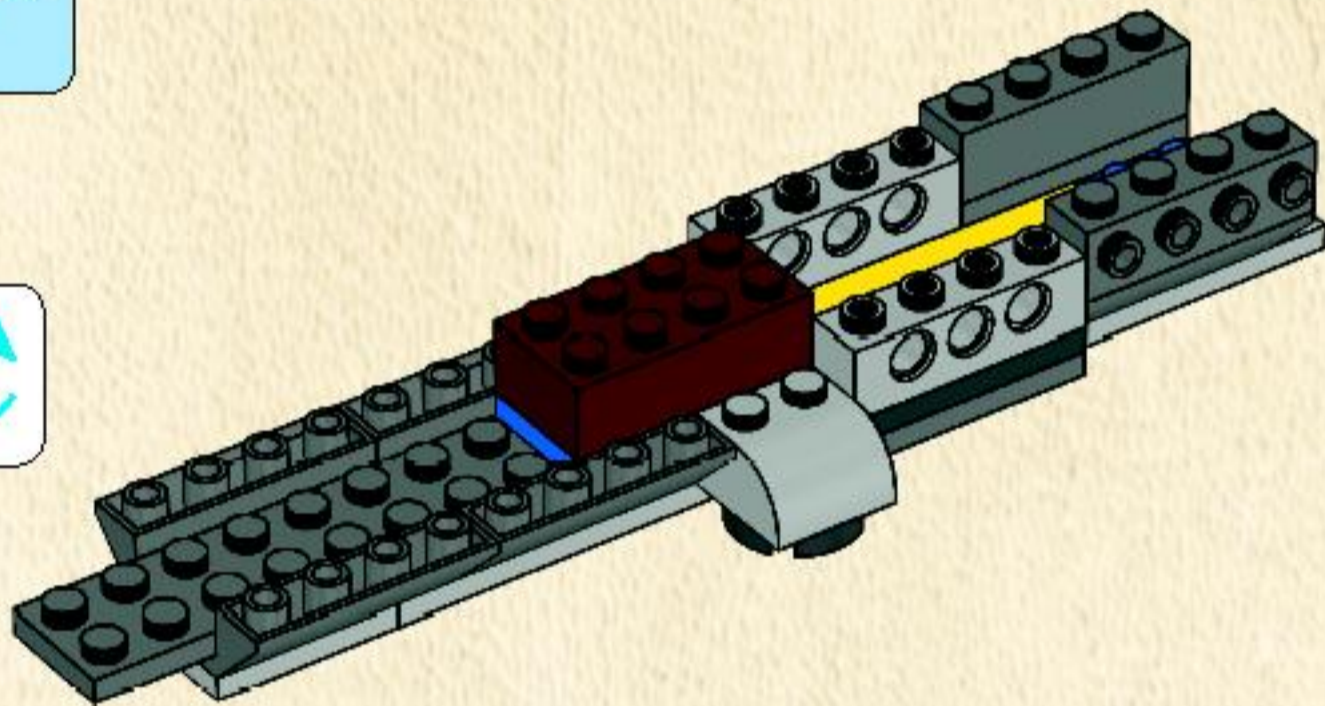

8

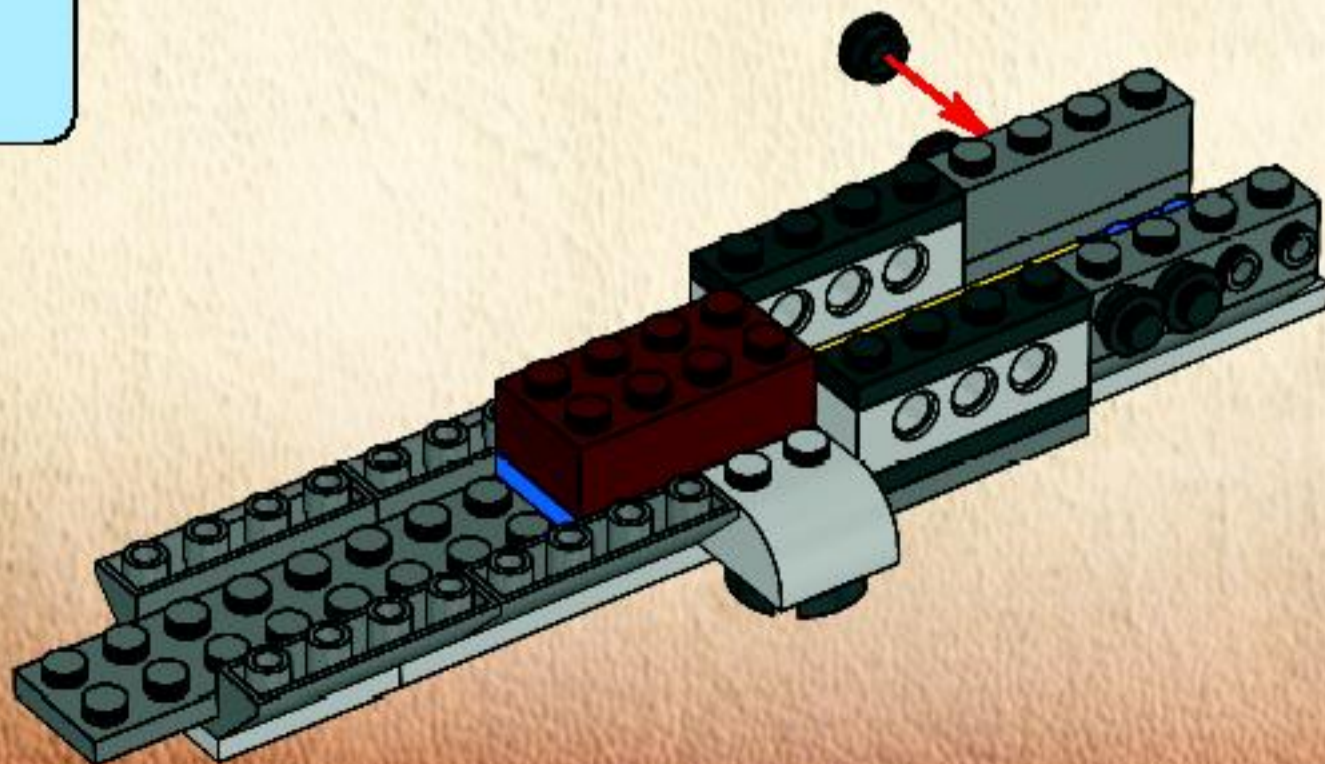



4x

9

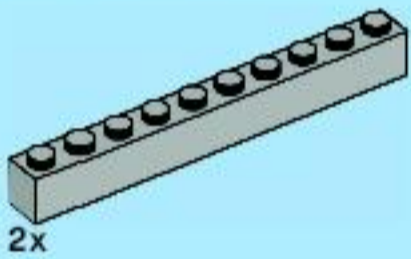
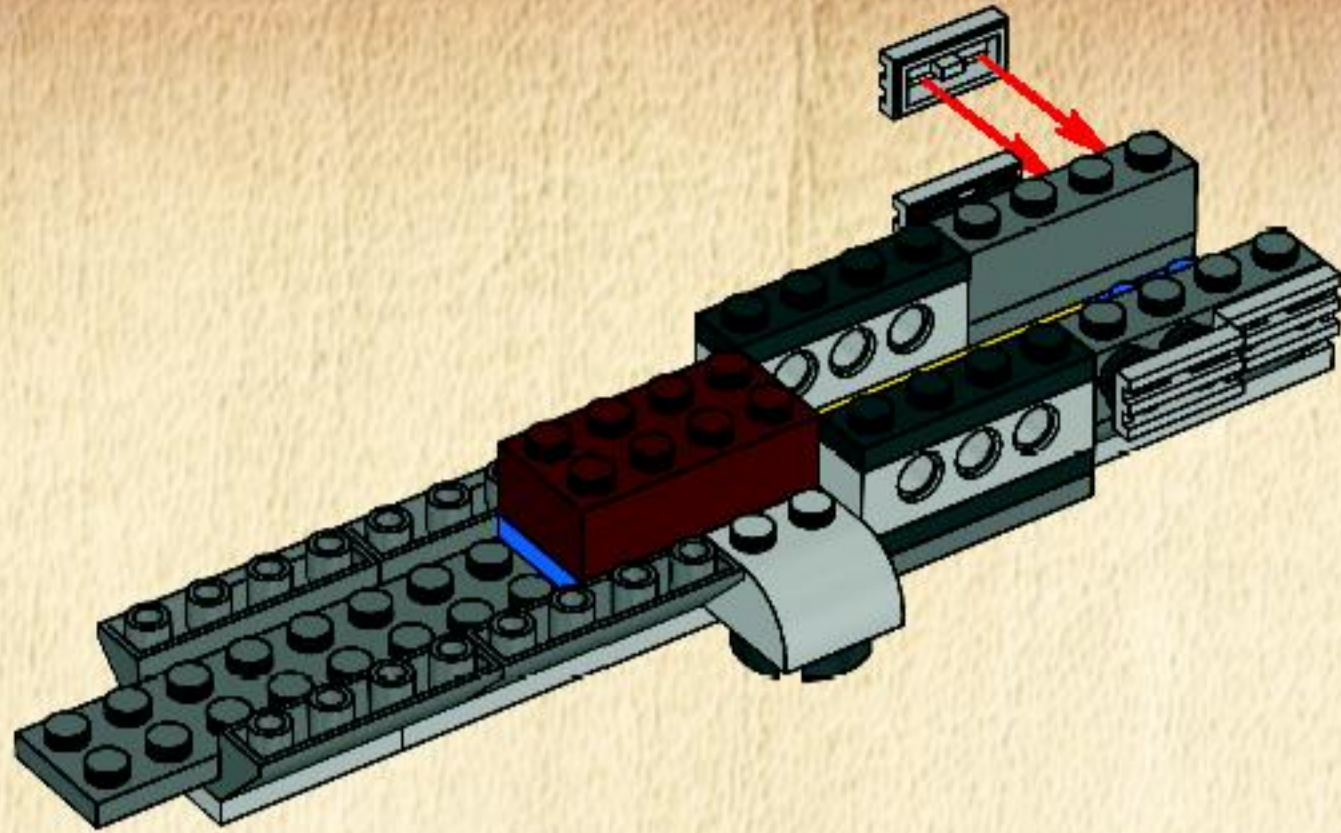

2x

10

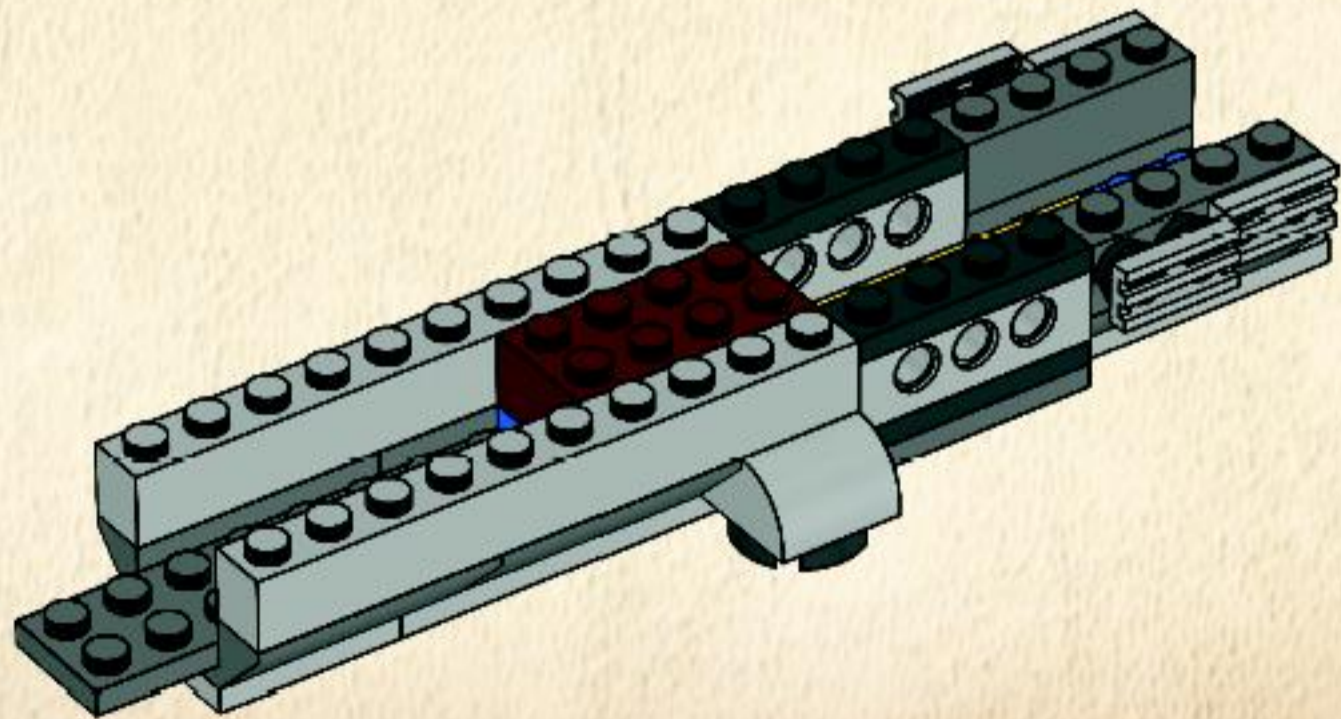

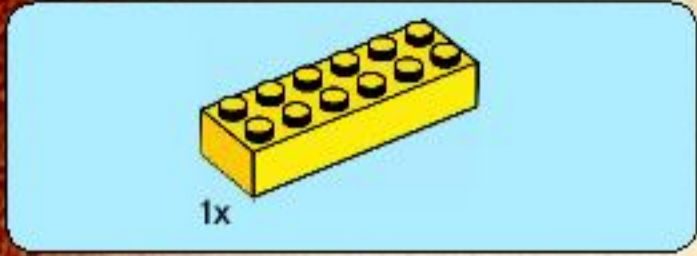
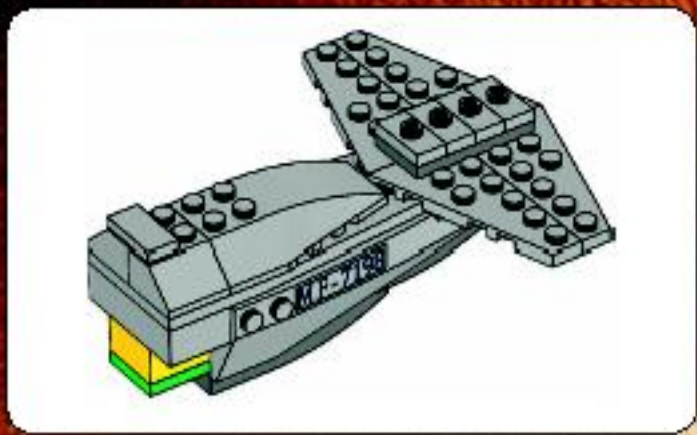

1

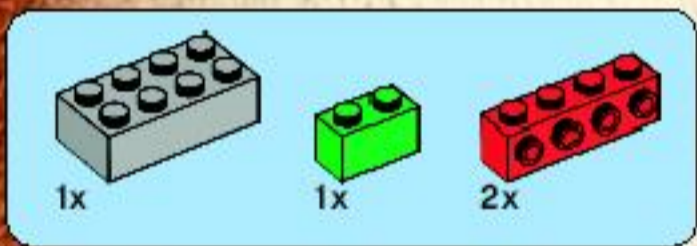
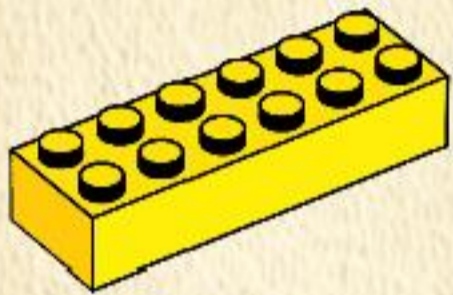

2

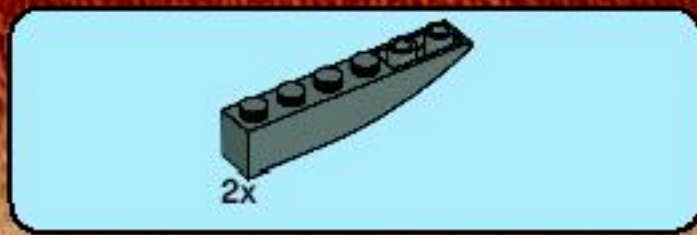
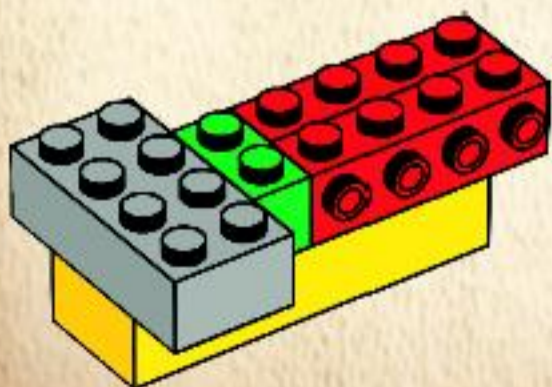

3

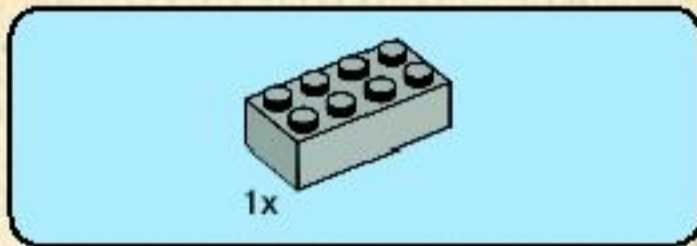
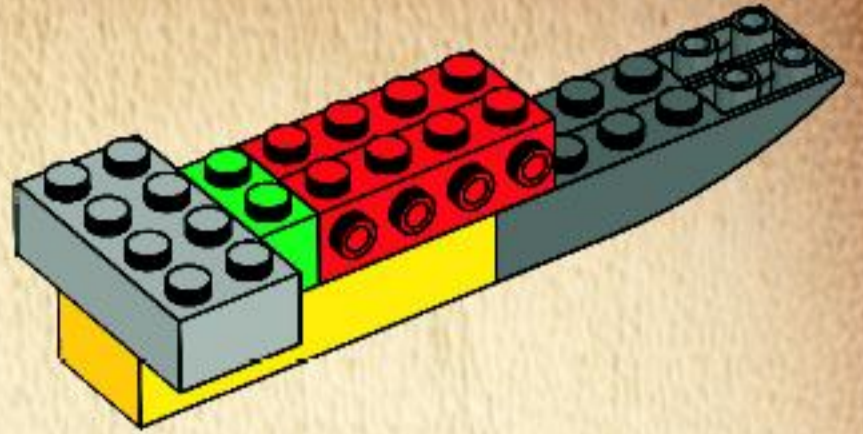

4

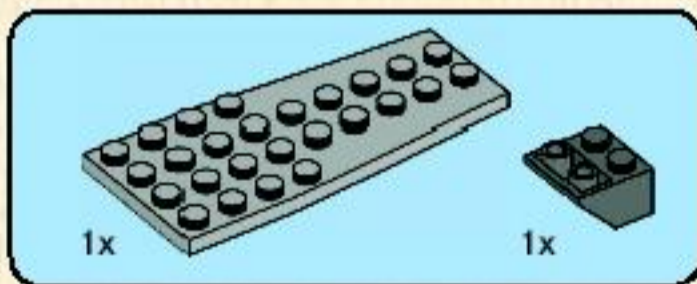
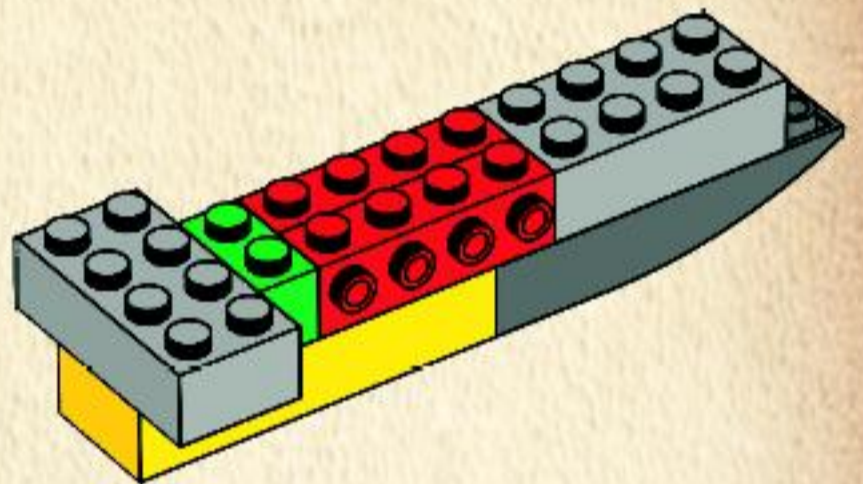

5

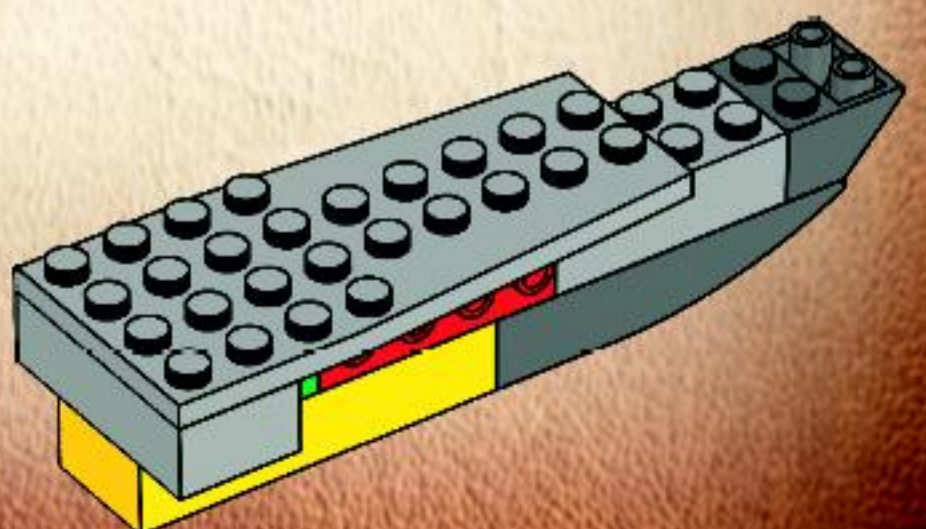



1x

6

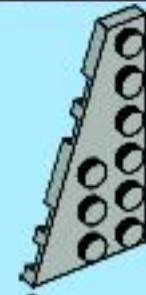
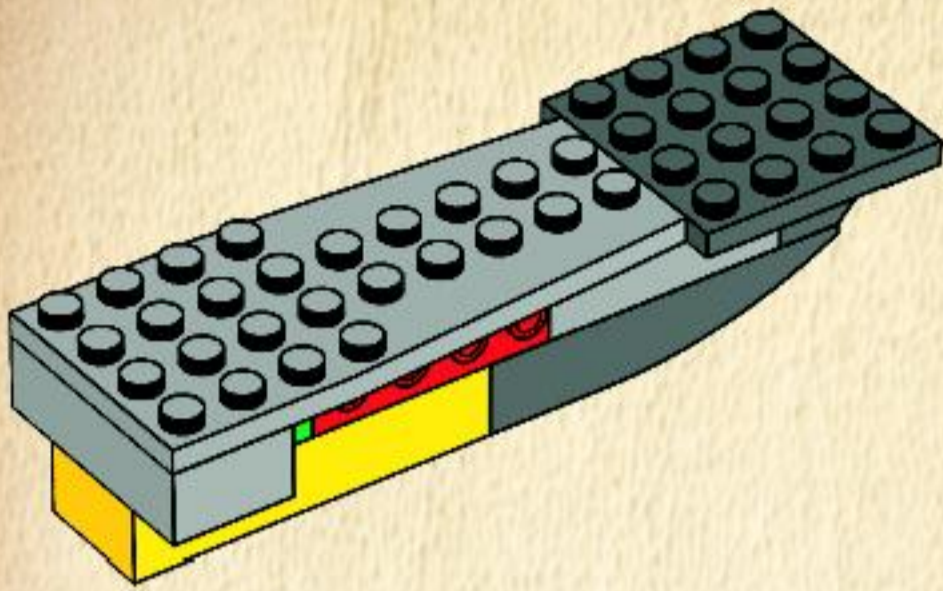

2x

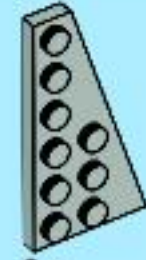

2x

8

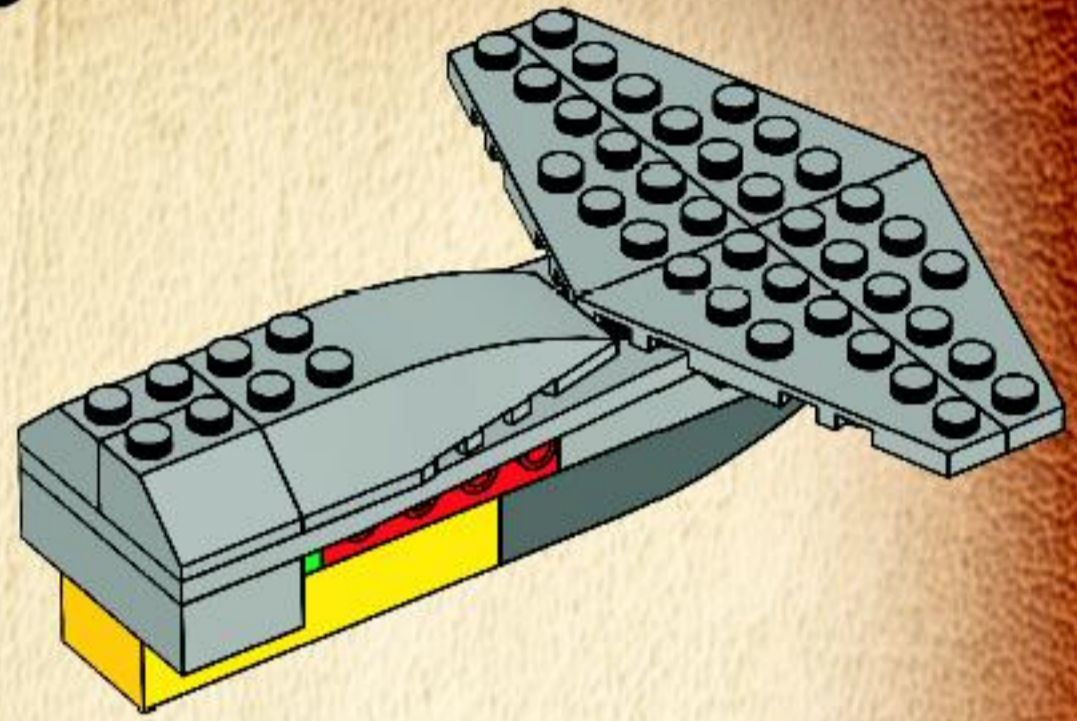

2x



1x

7

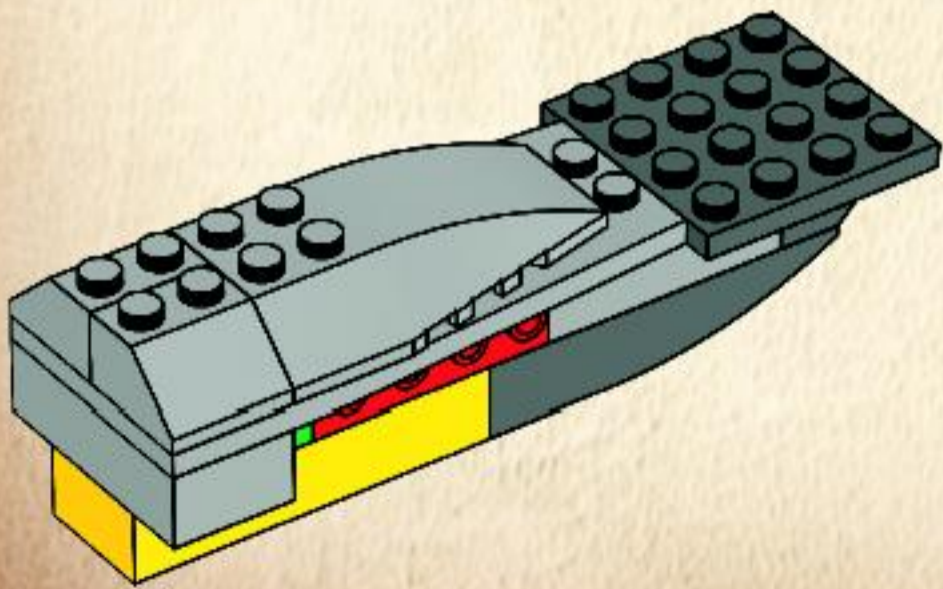

1x



1x

9

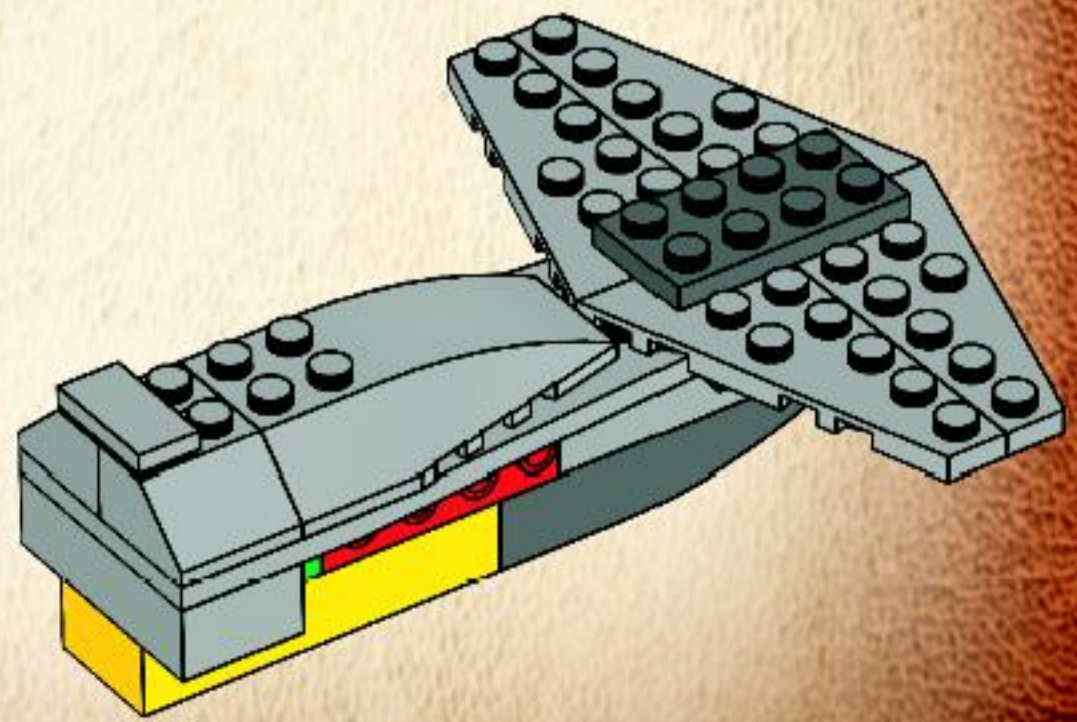



4x

10

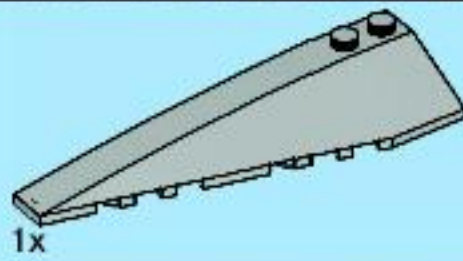
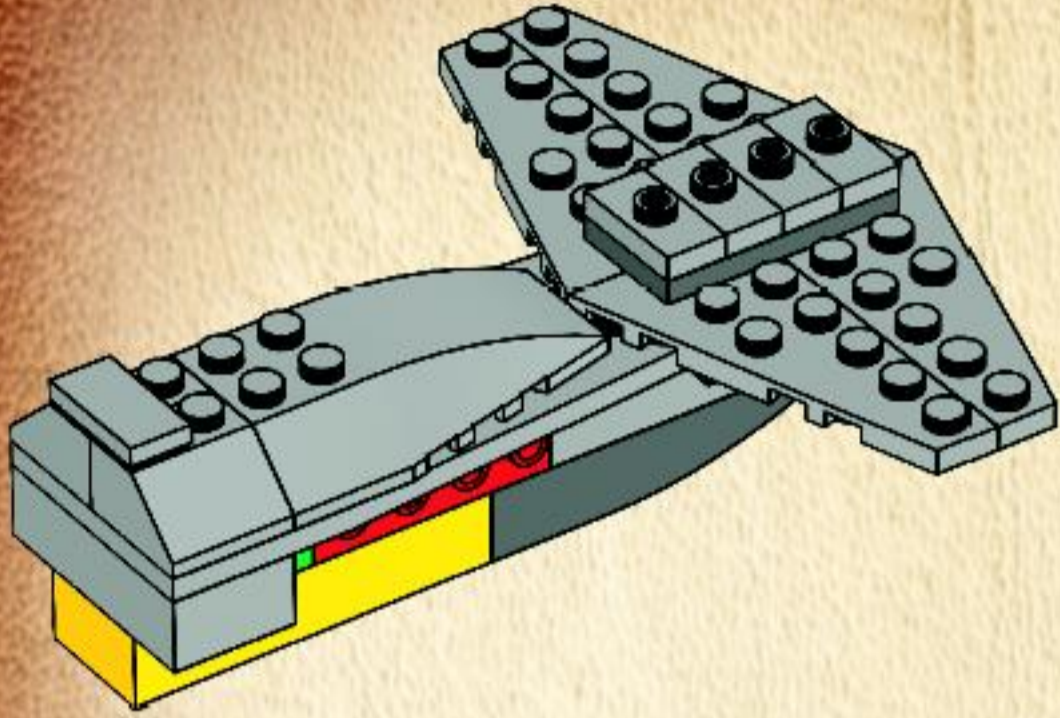

1x

12

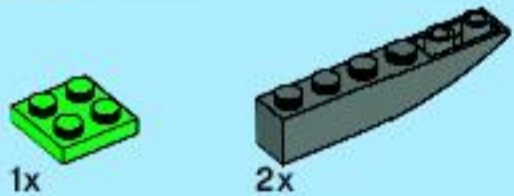
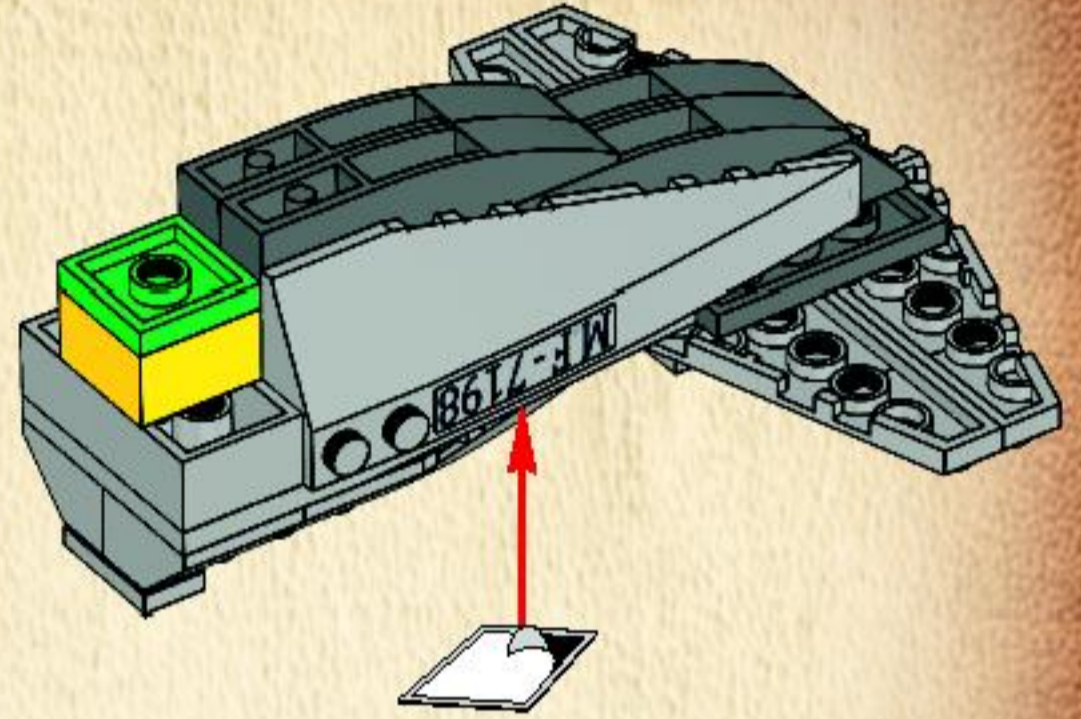

1x

2x

11

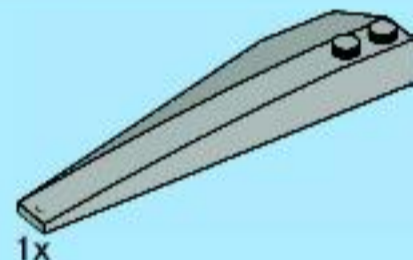
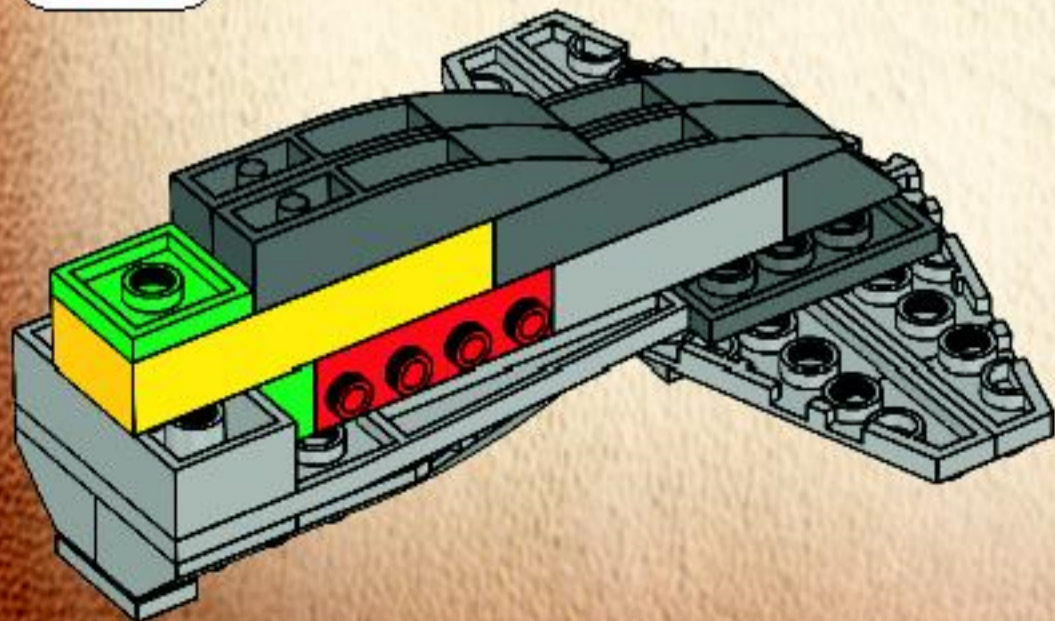

1x

13

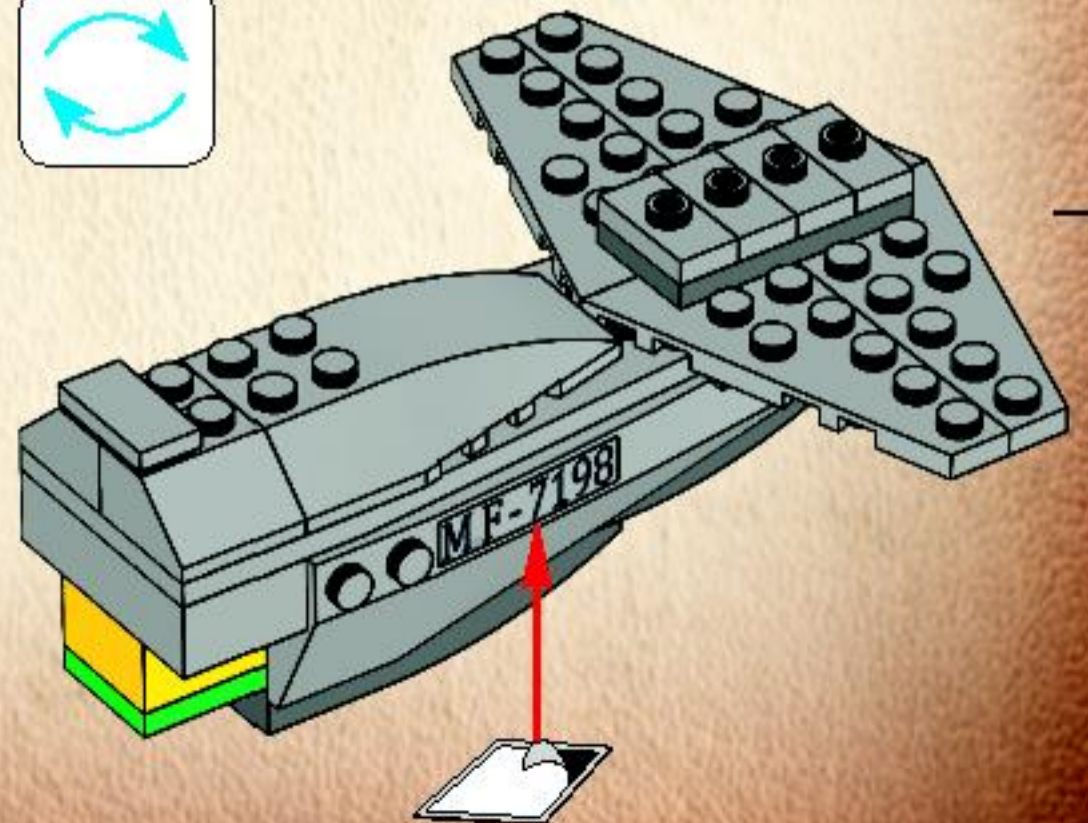

14

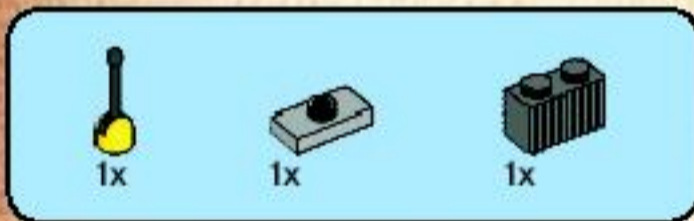
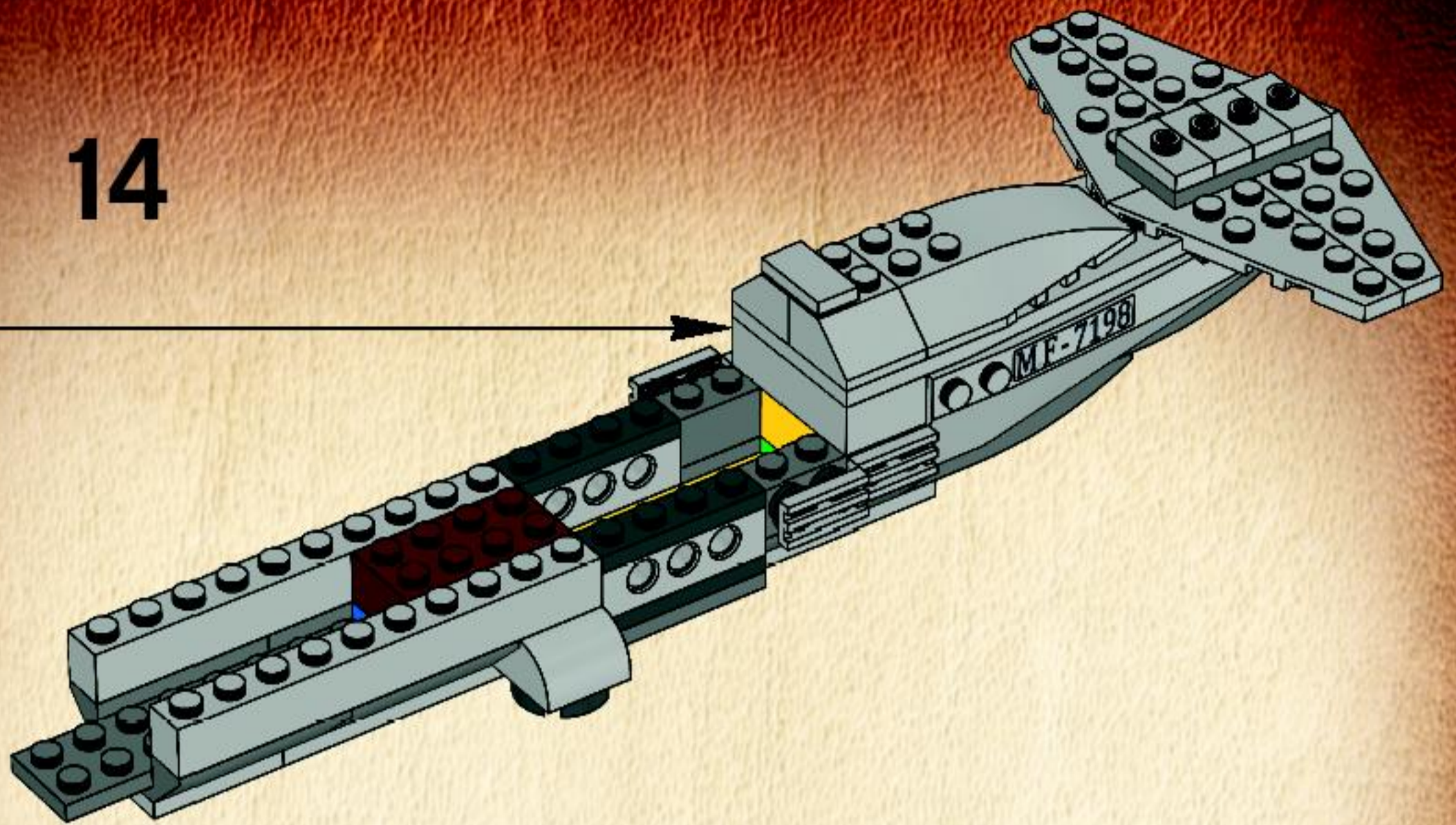

15

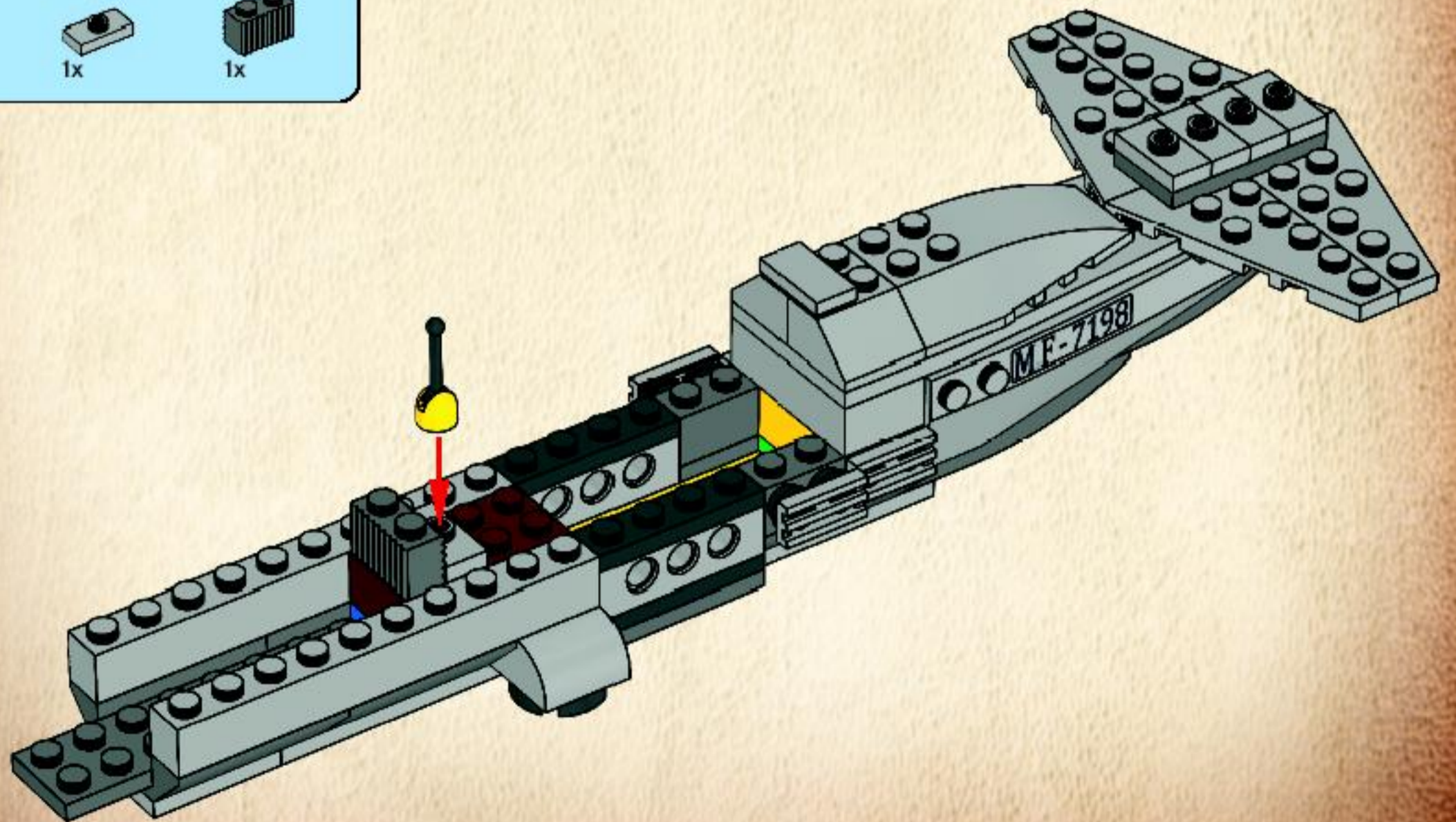

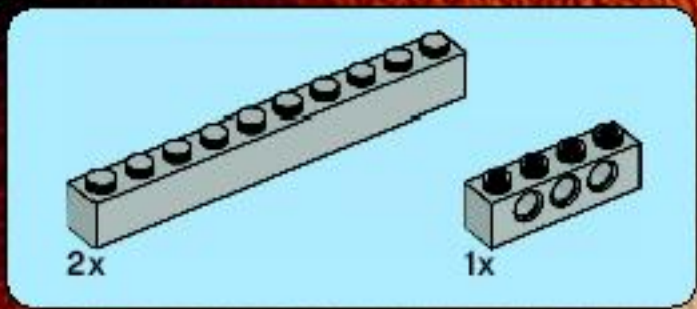

16

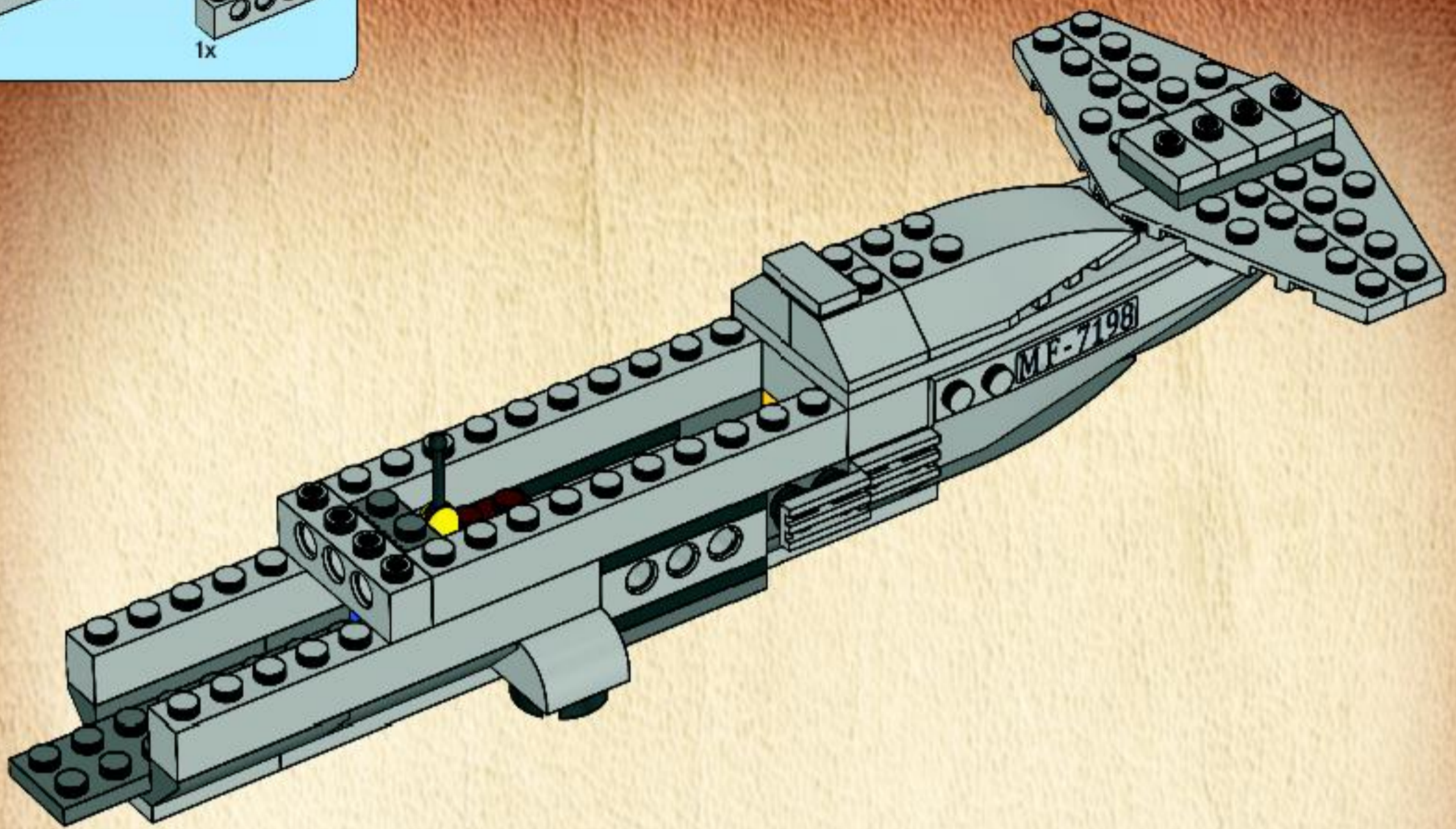

17

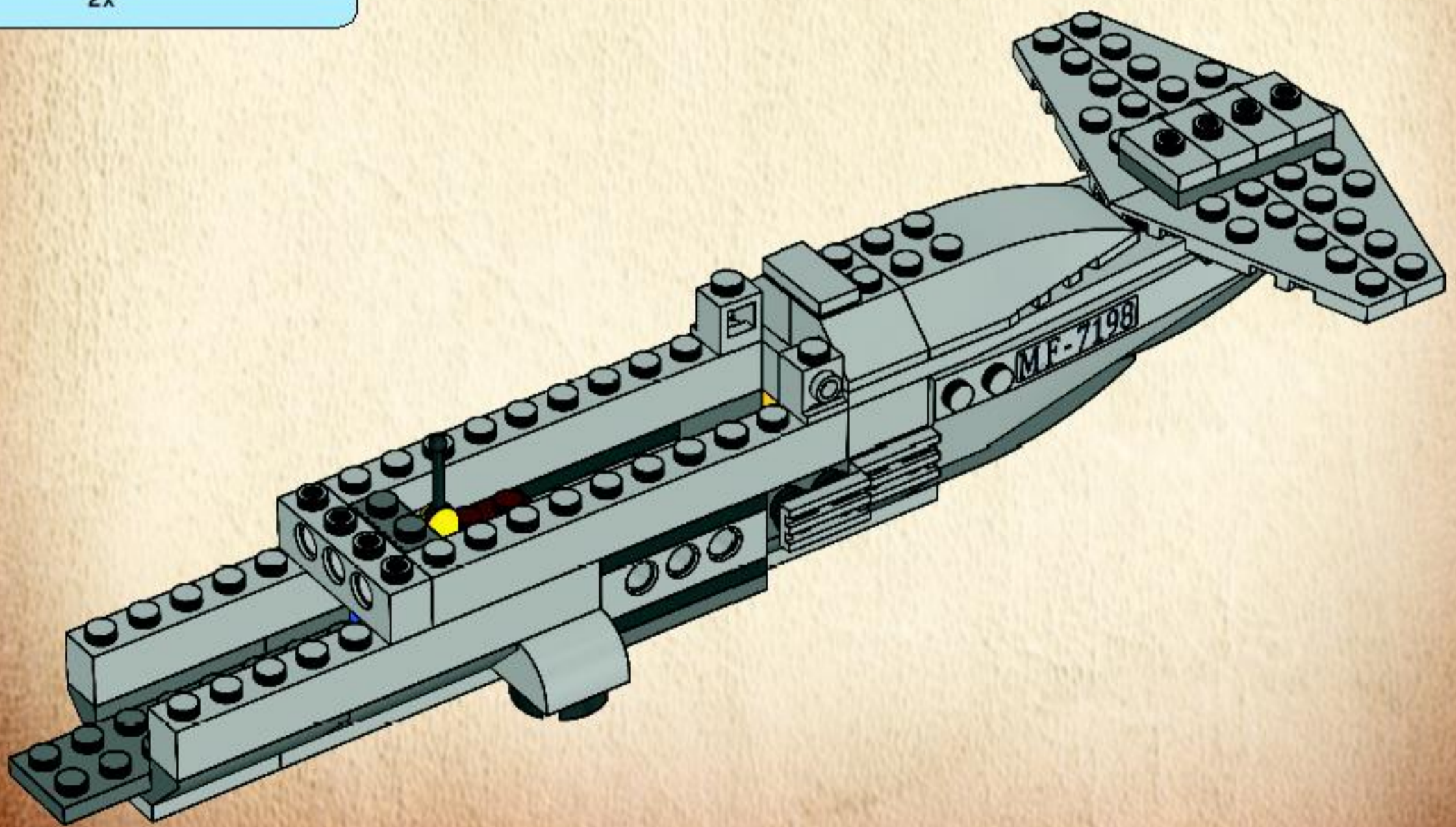

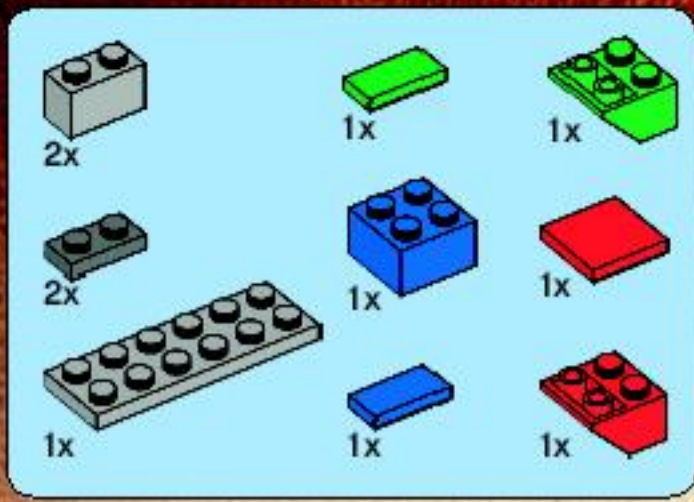

18

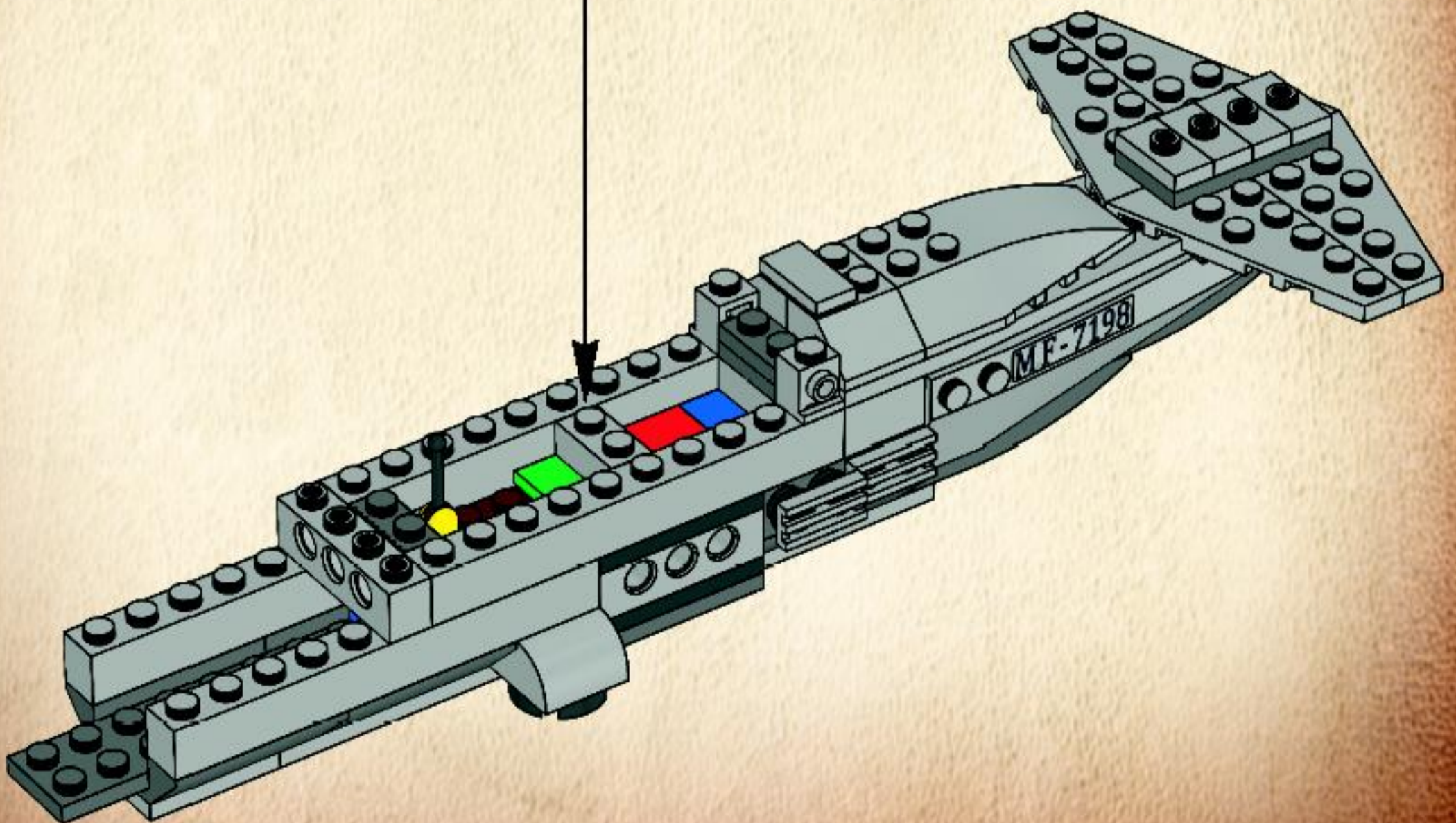
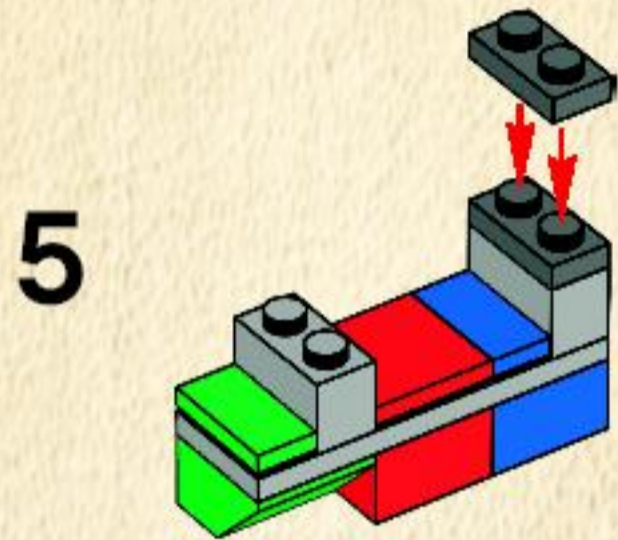
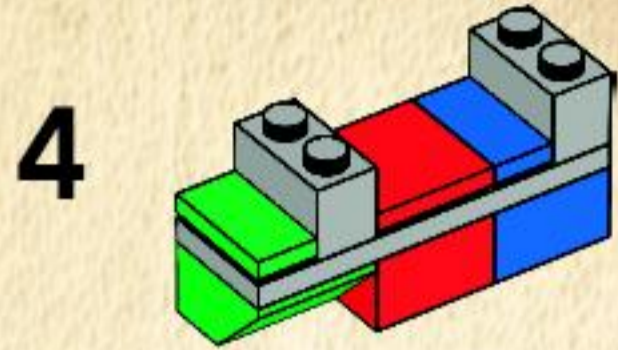
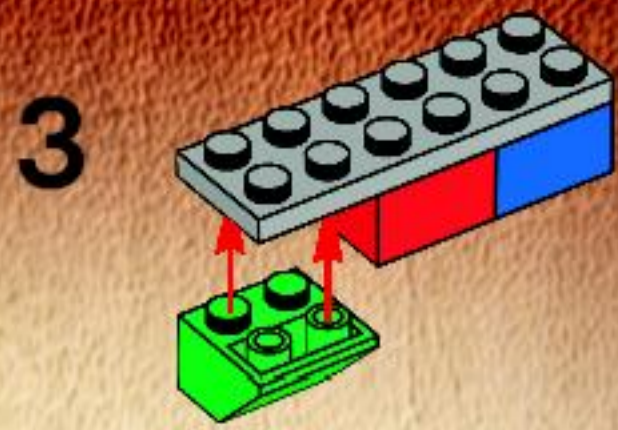
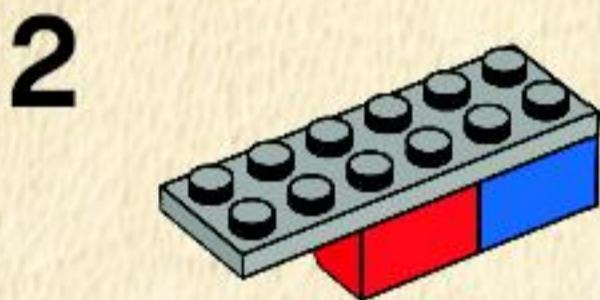
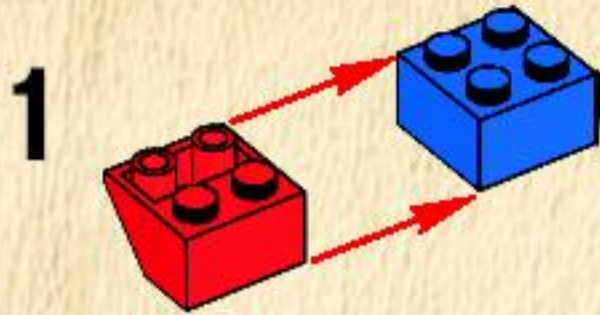



2x



1x

19

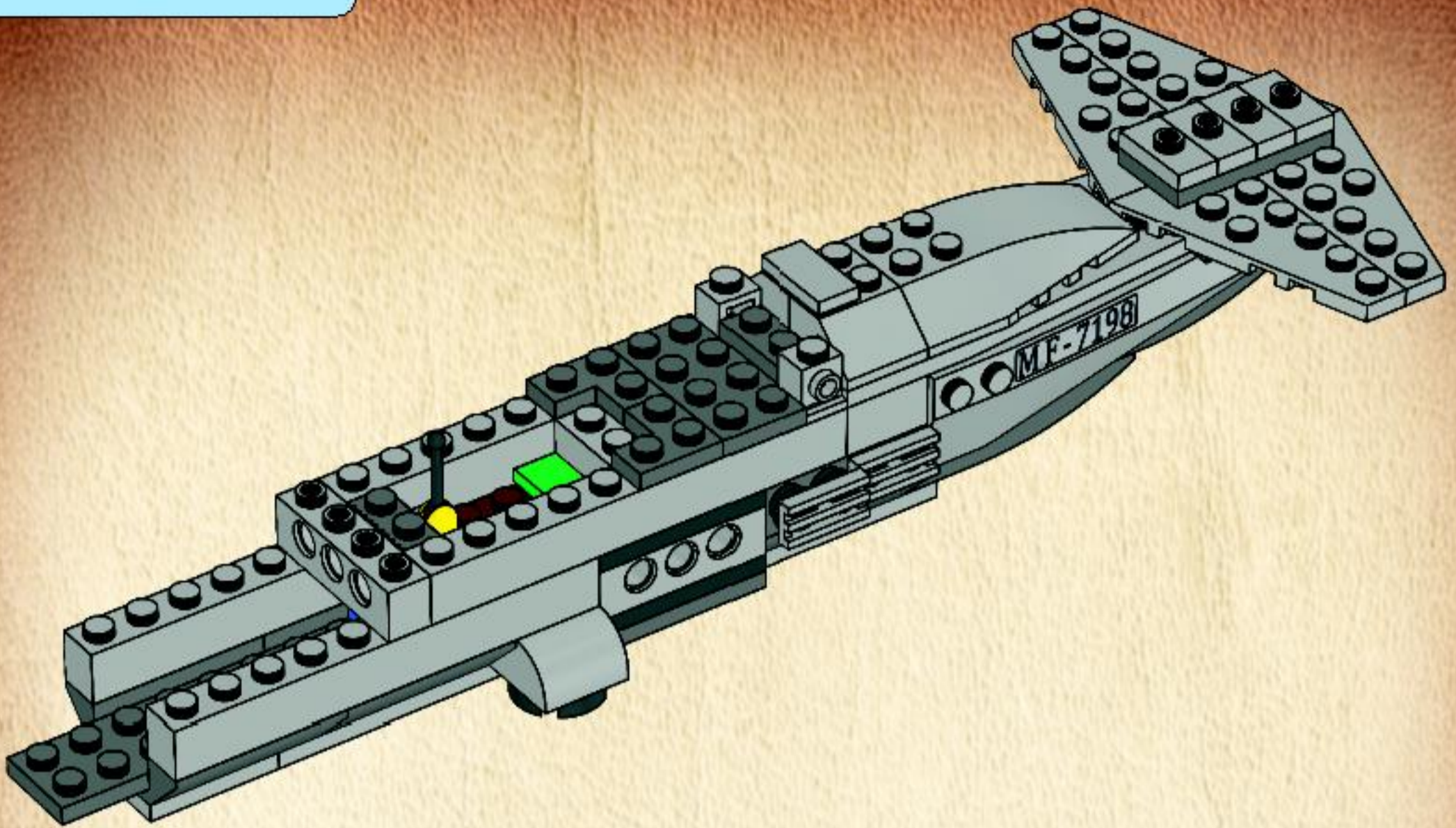

2x



2x

20

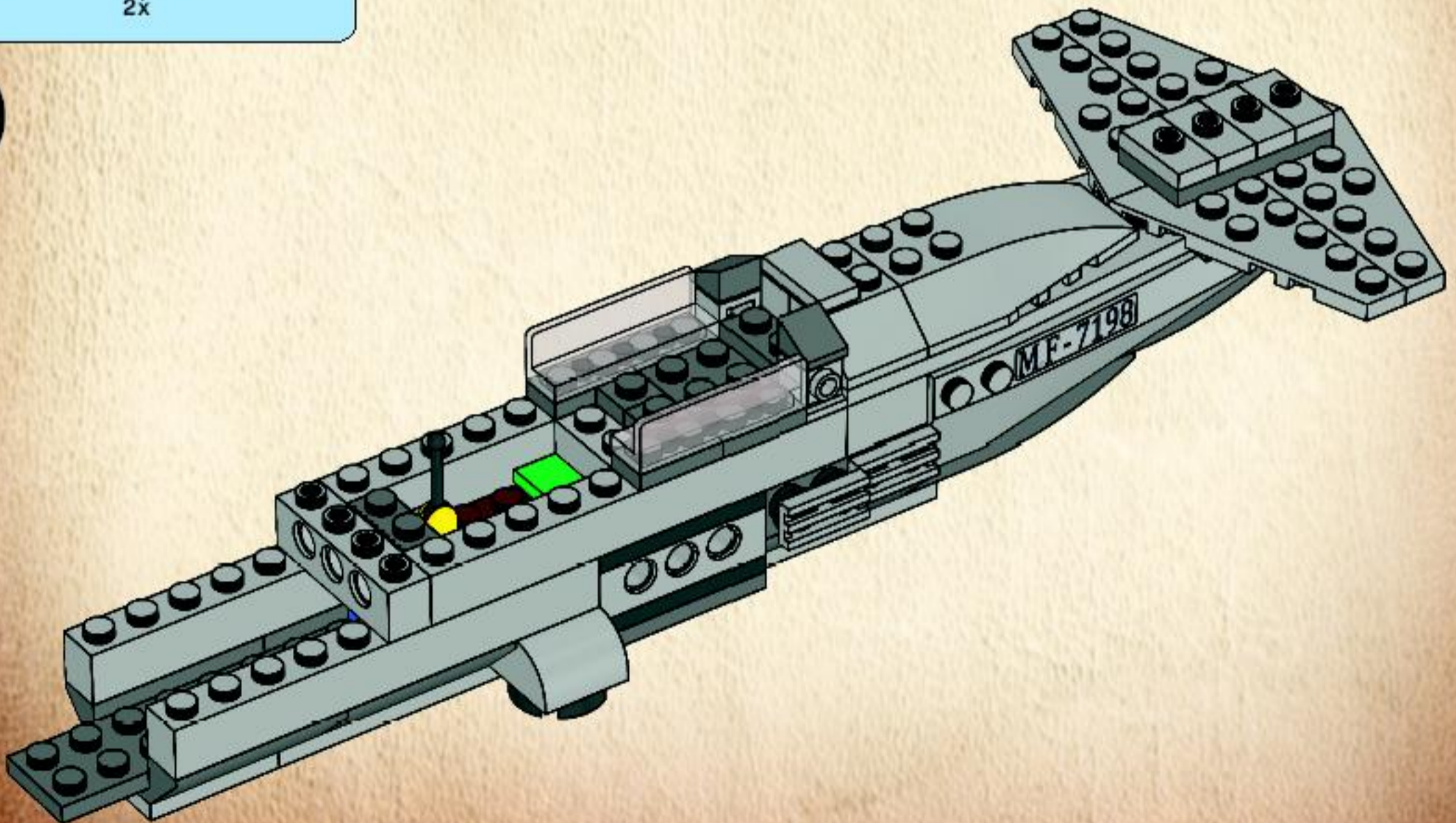



21

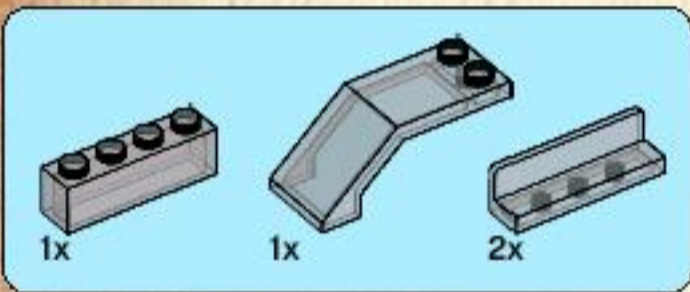
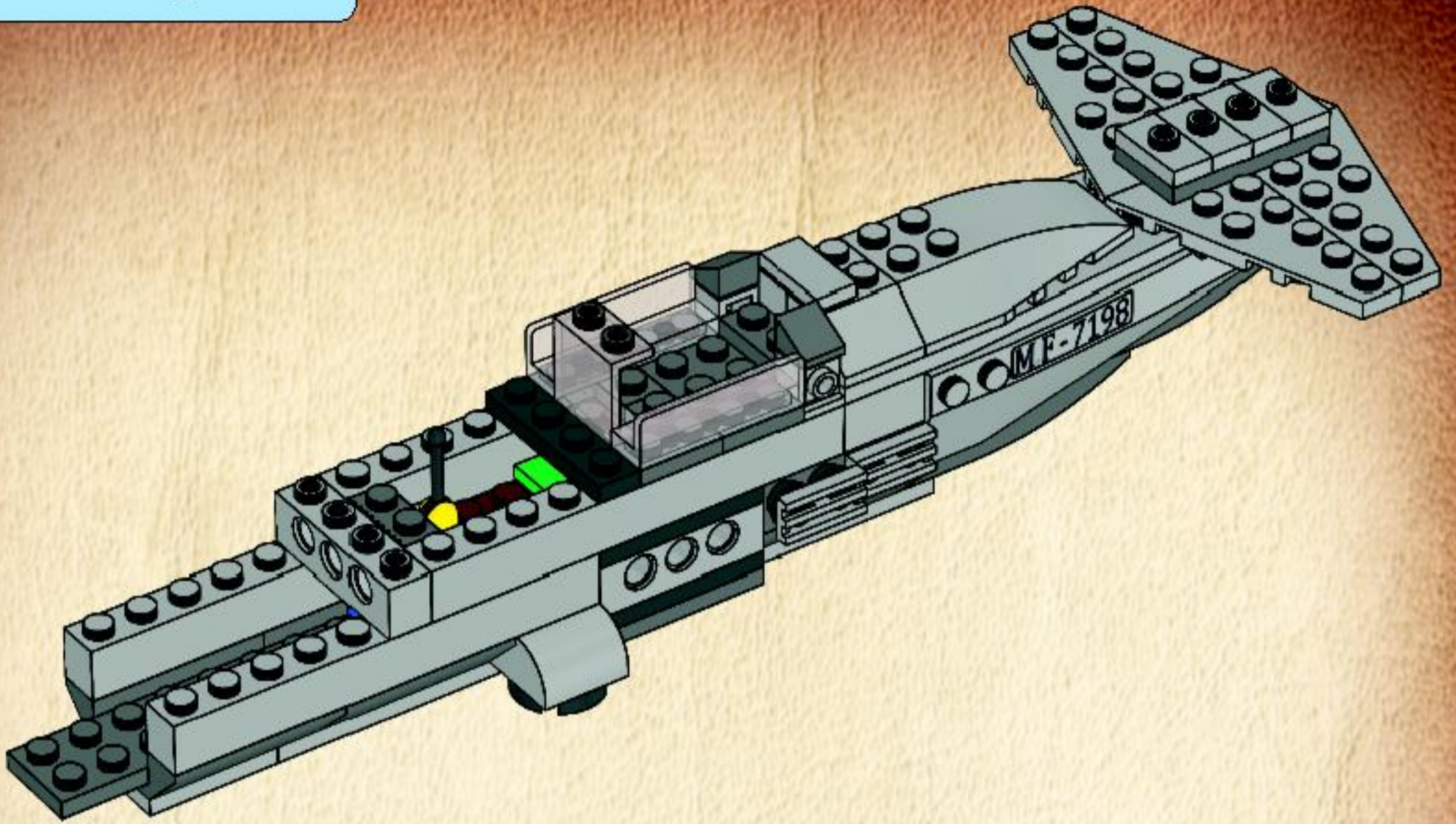

22

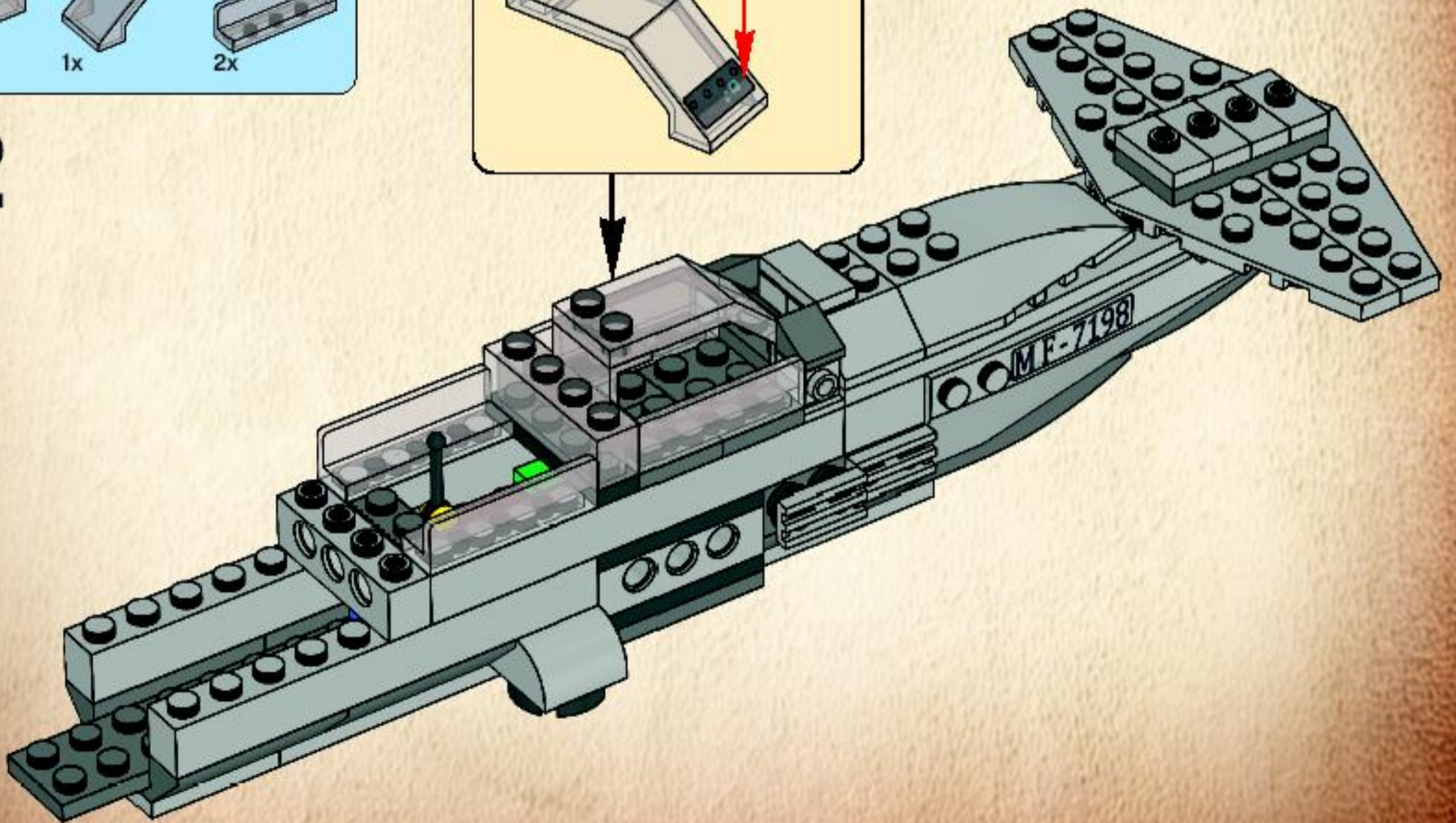
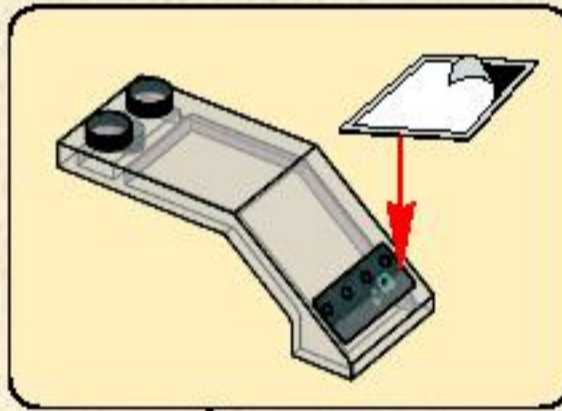

2x 1x

23

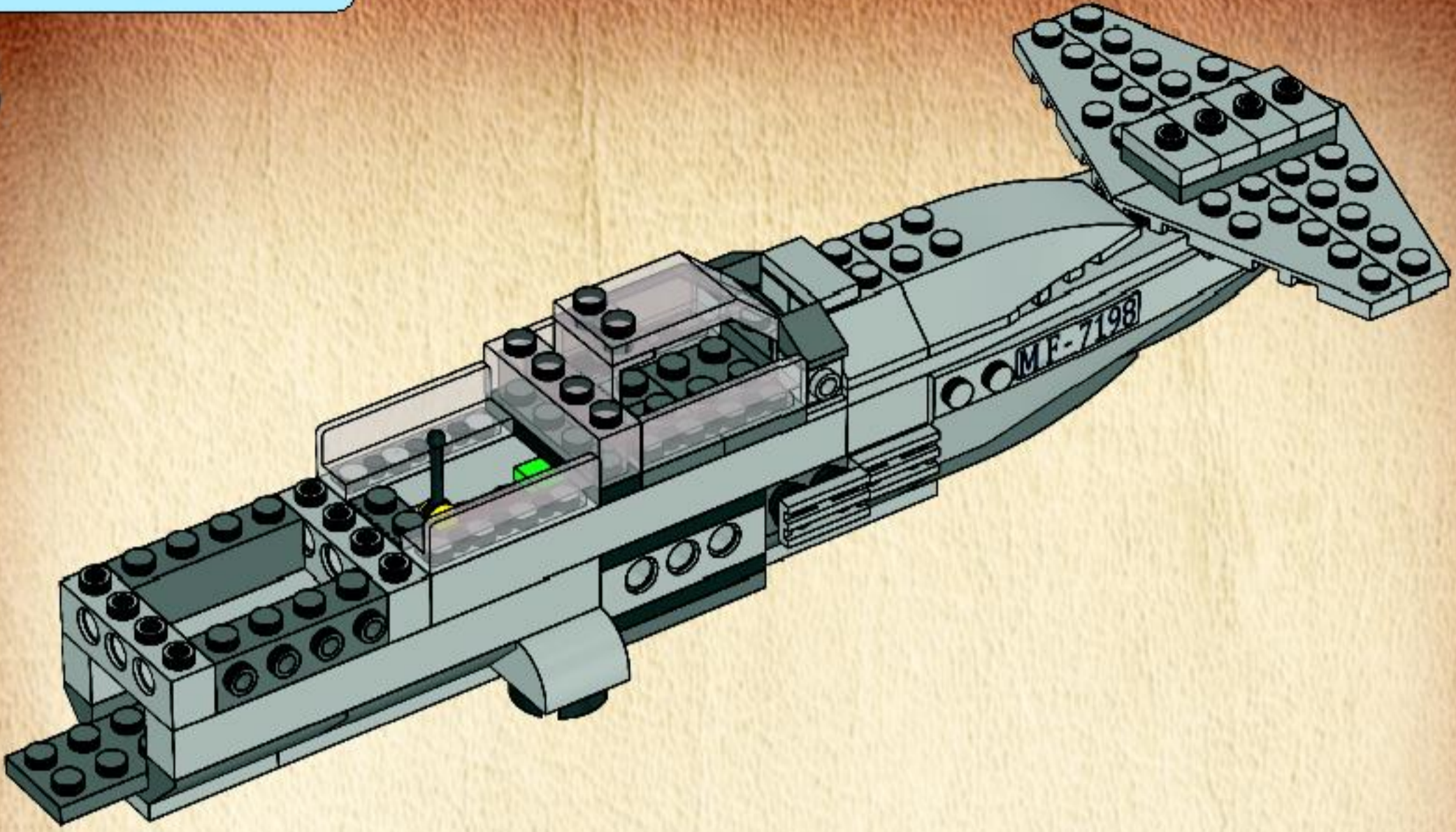

8x

24

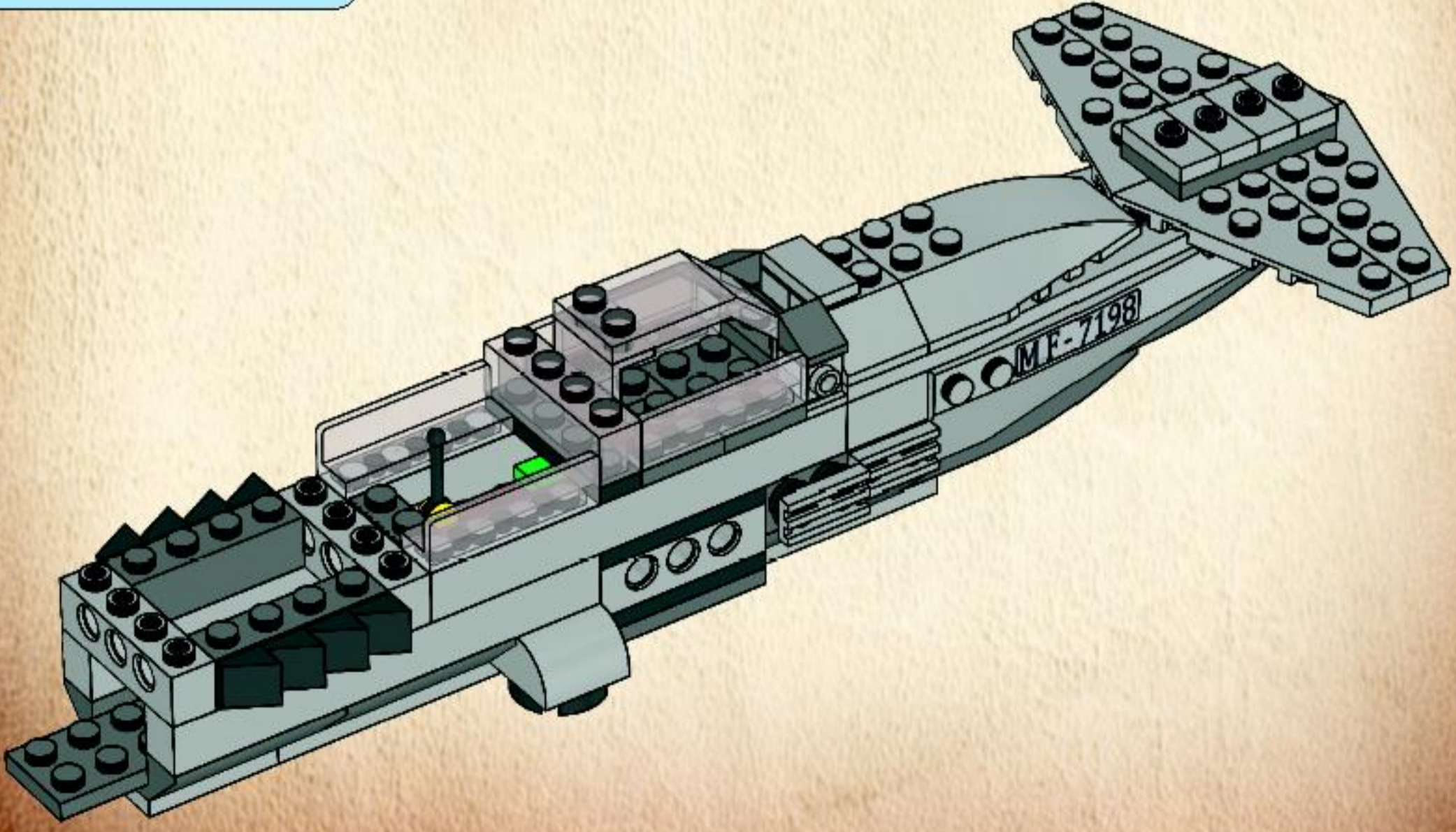

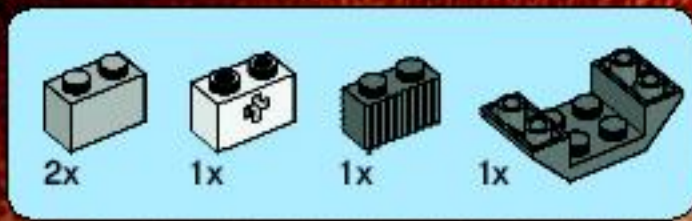

25

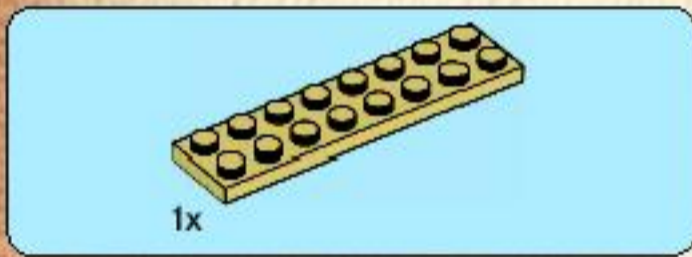
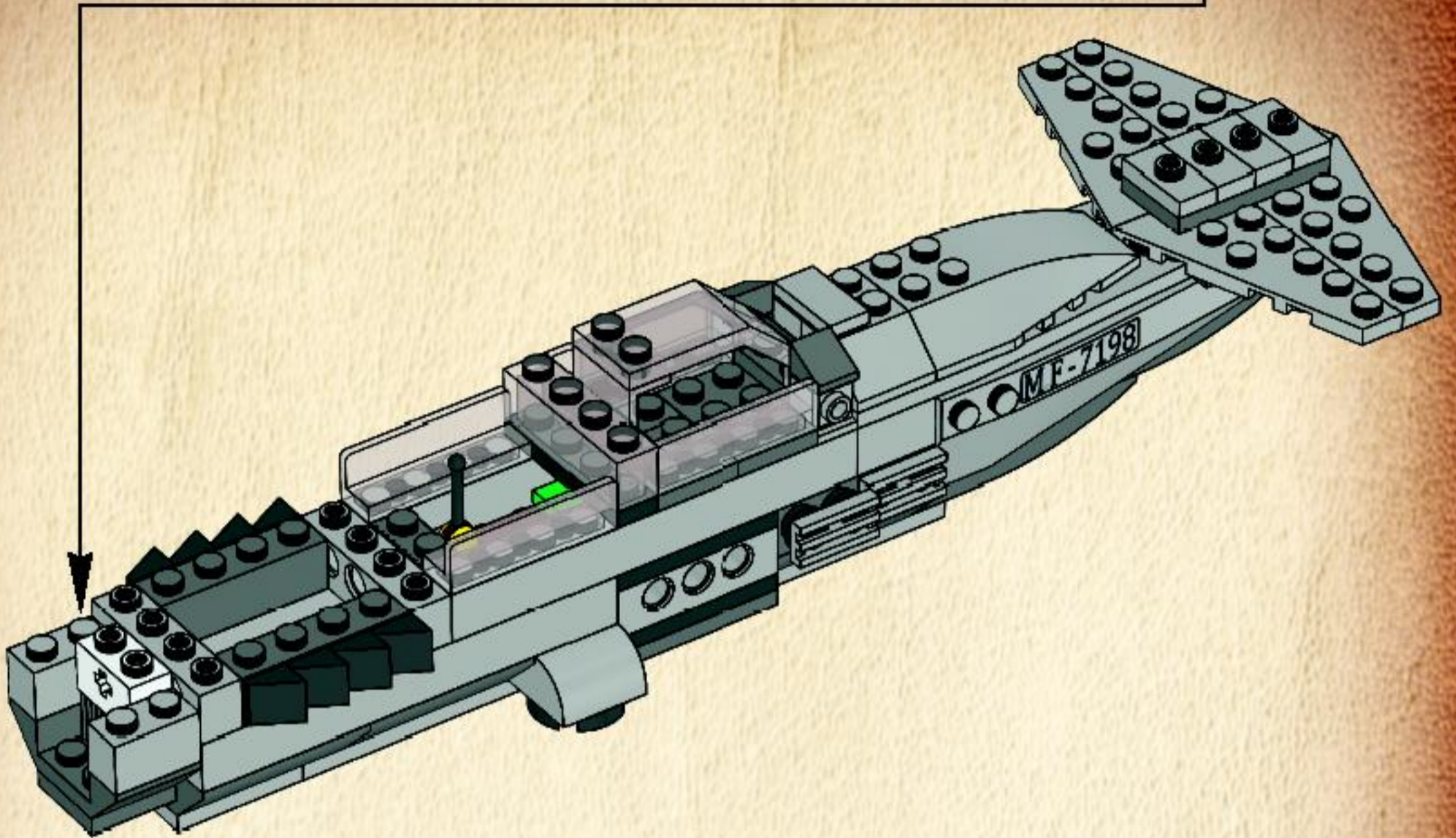

26

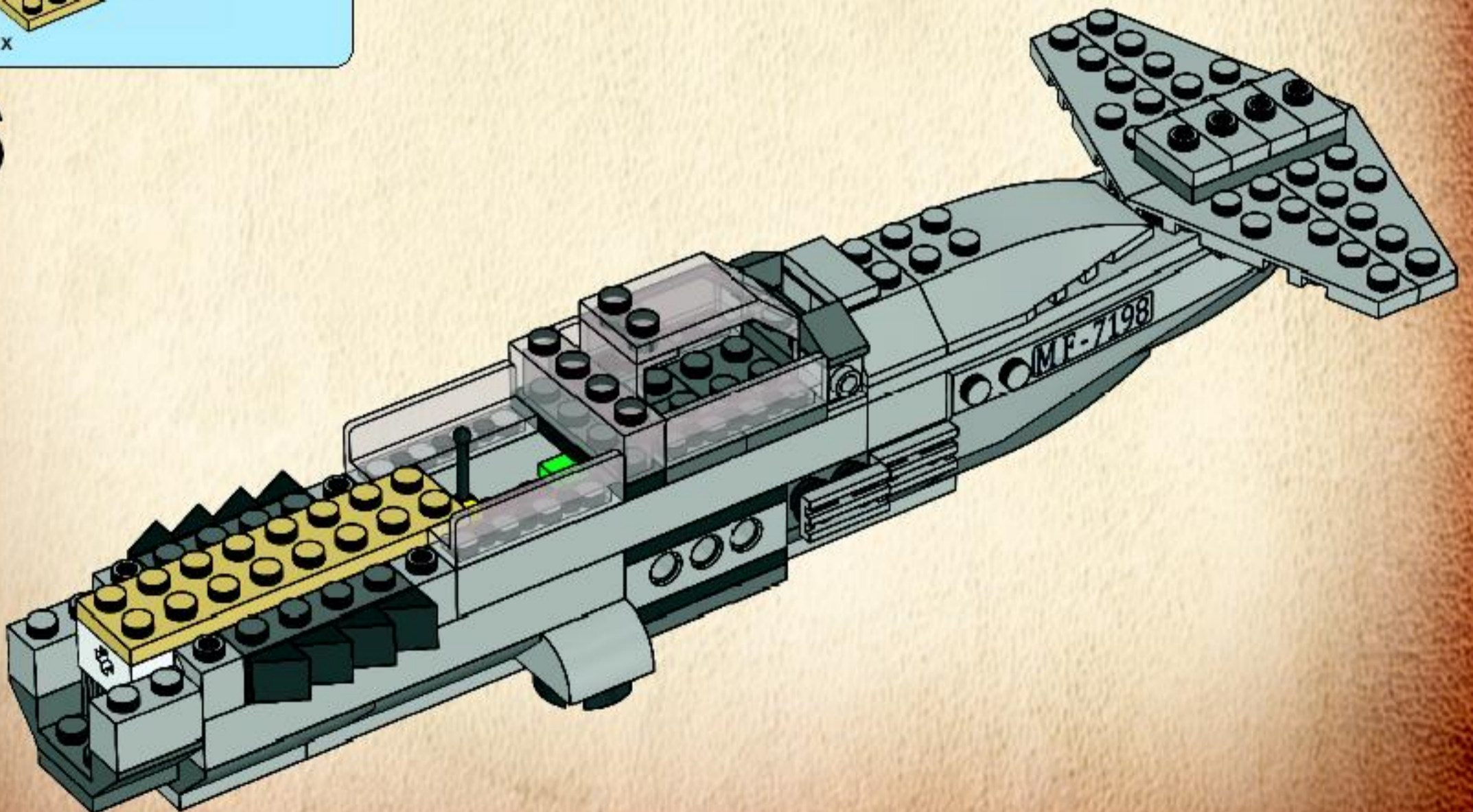



27

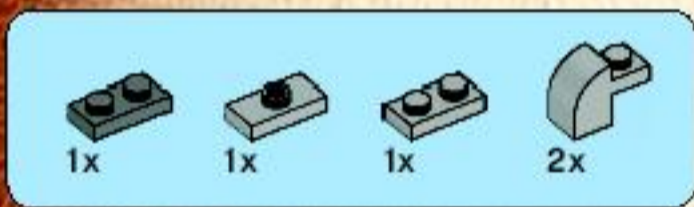
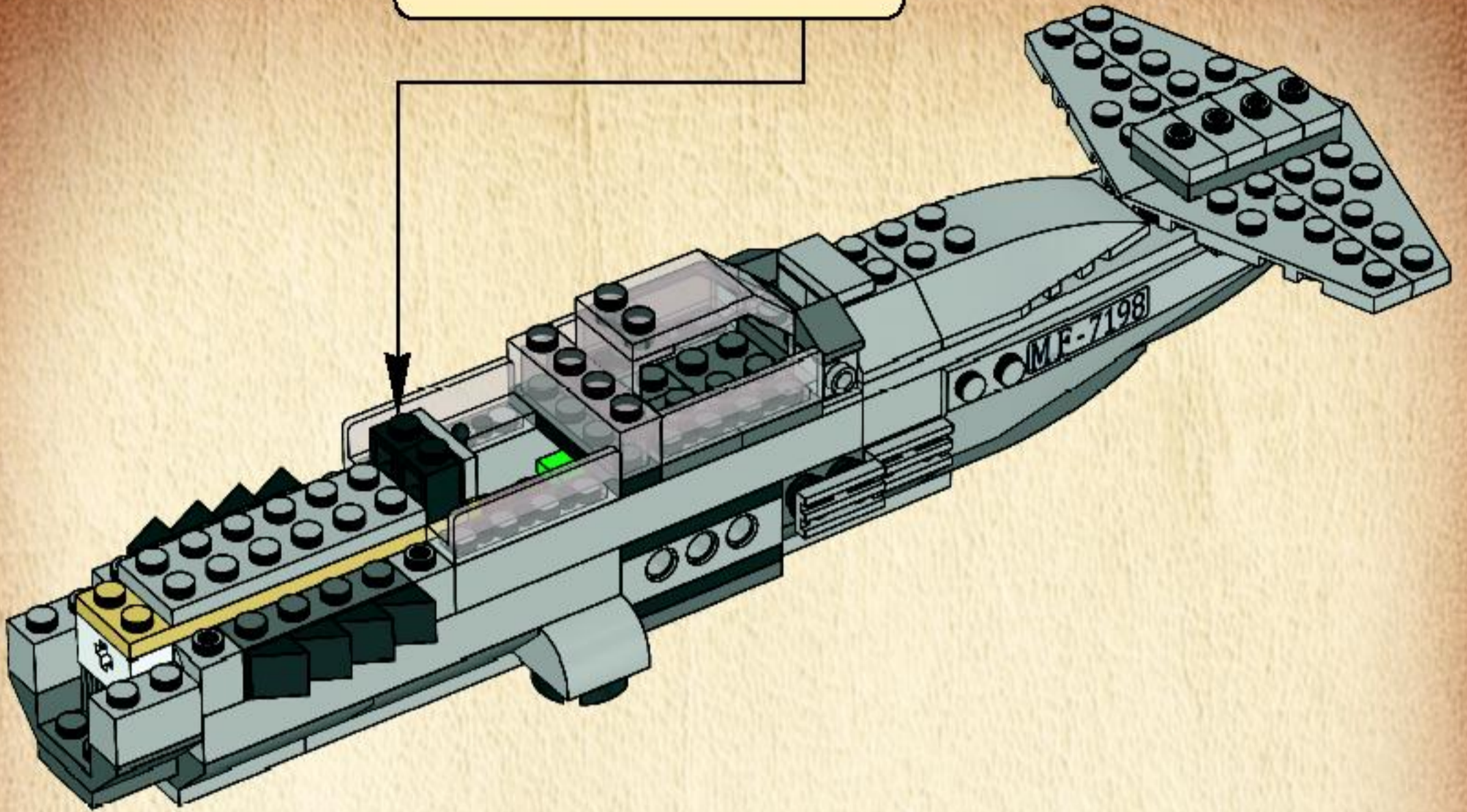
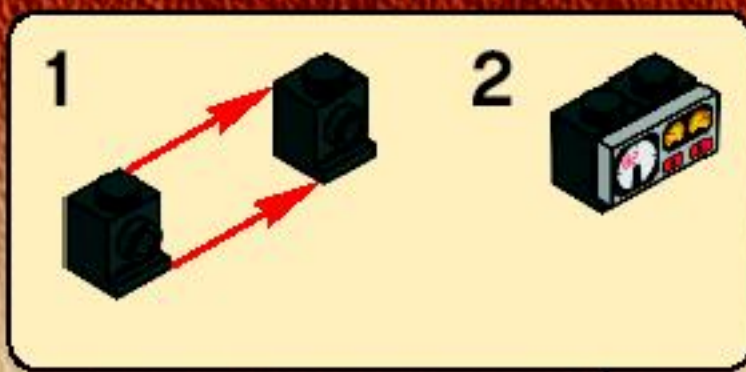

28

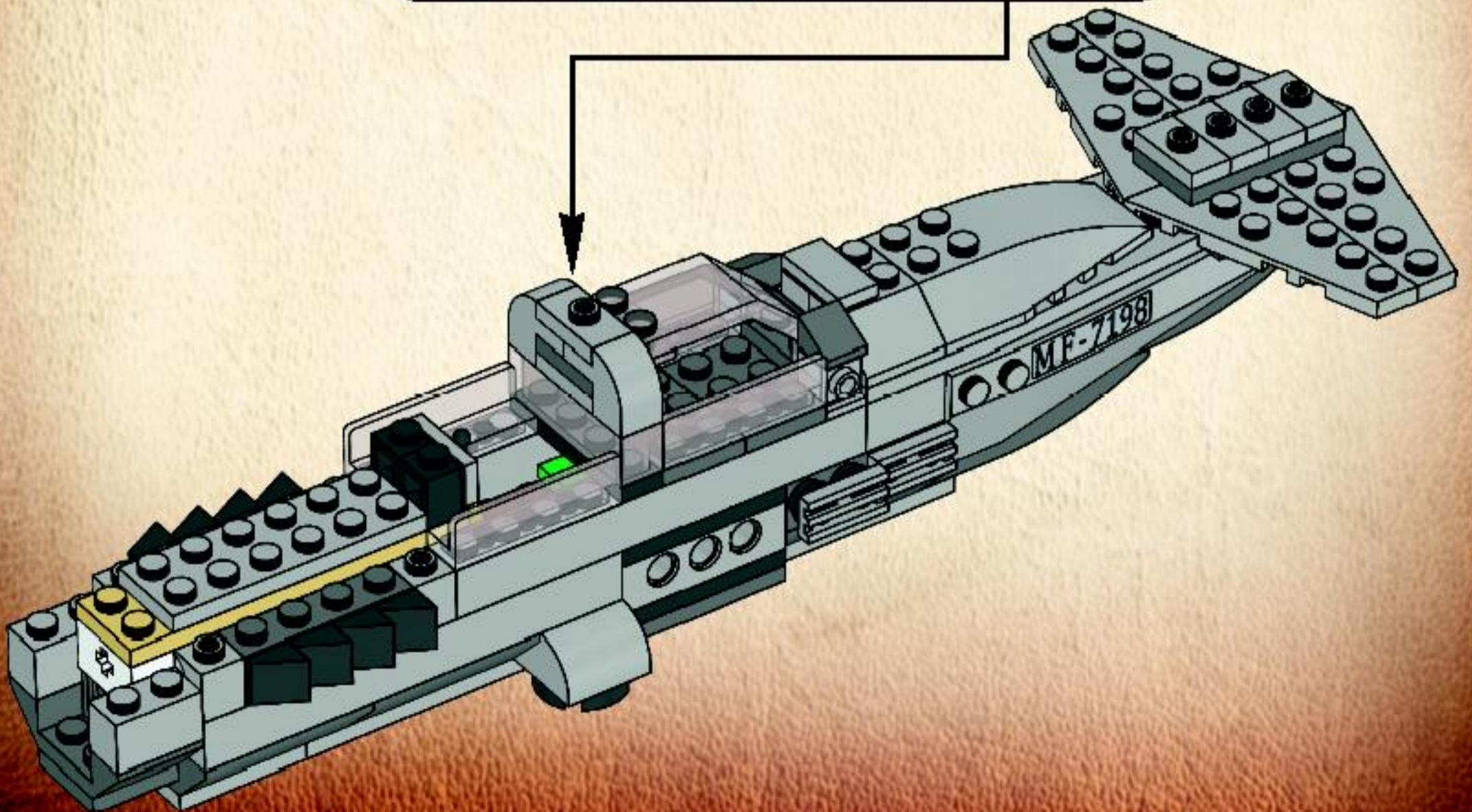
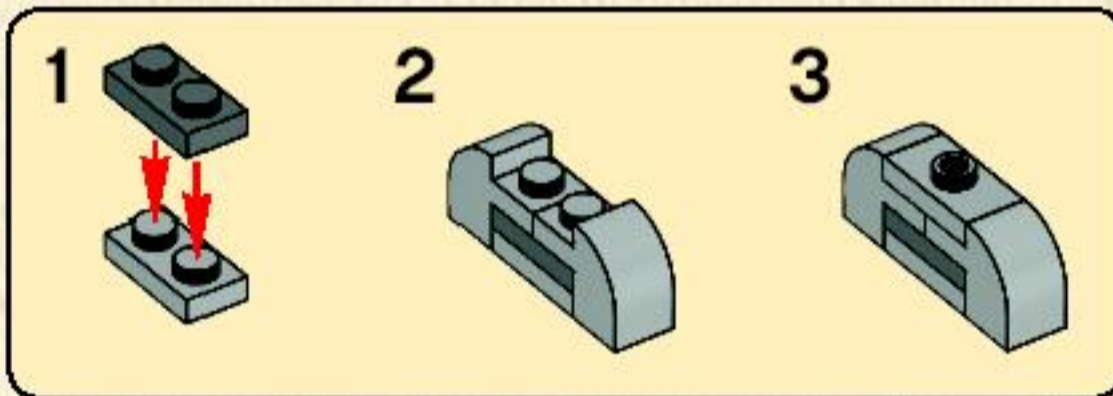

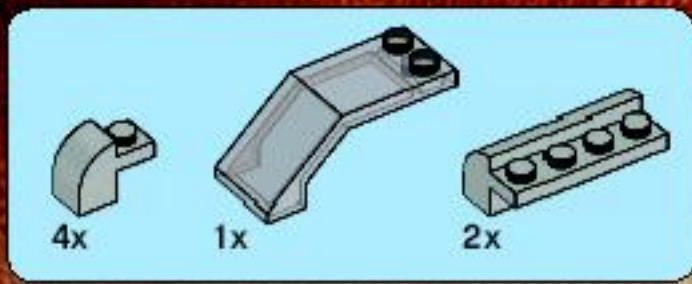

29

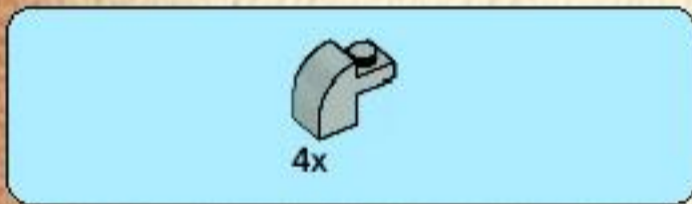
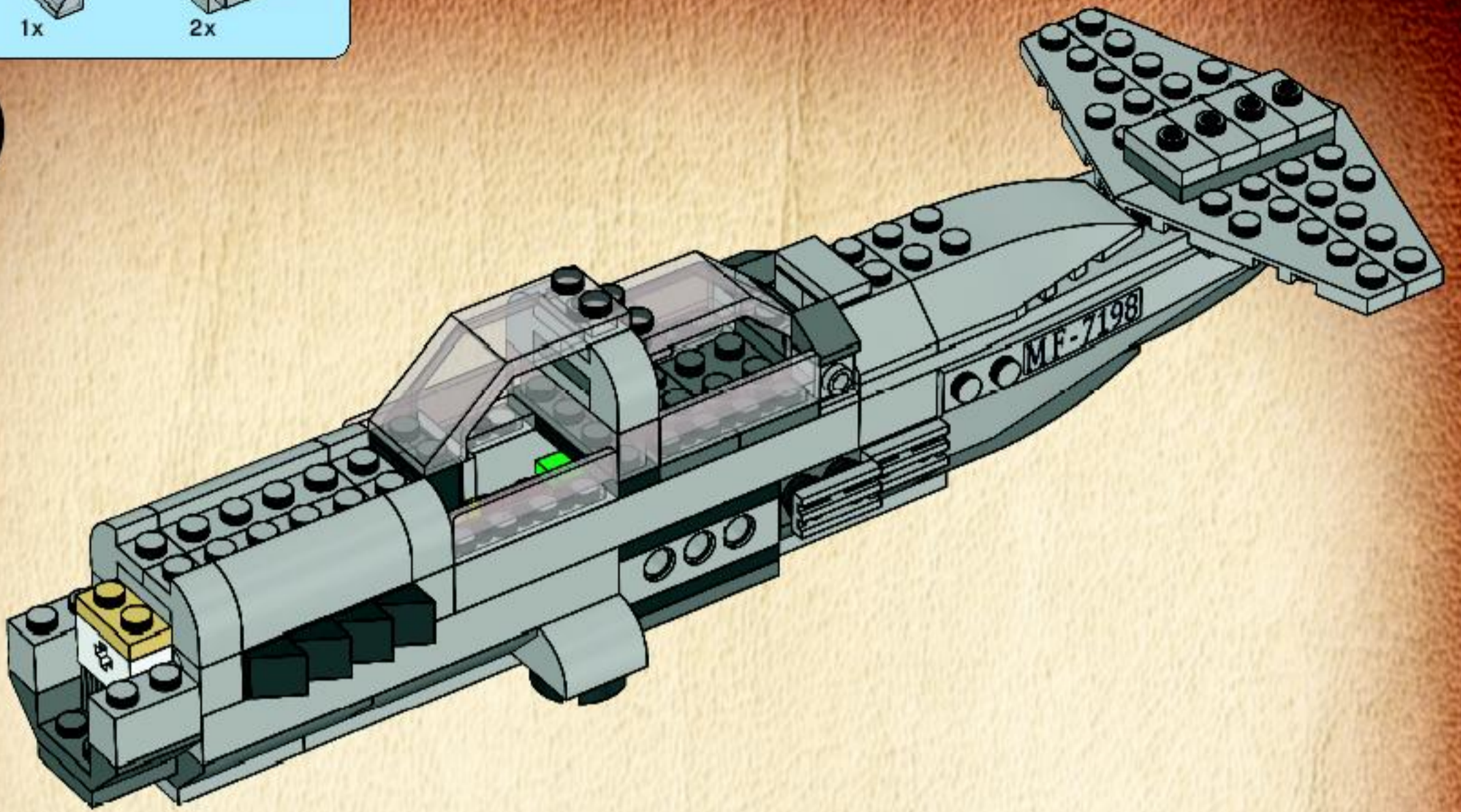

30

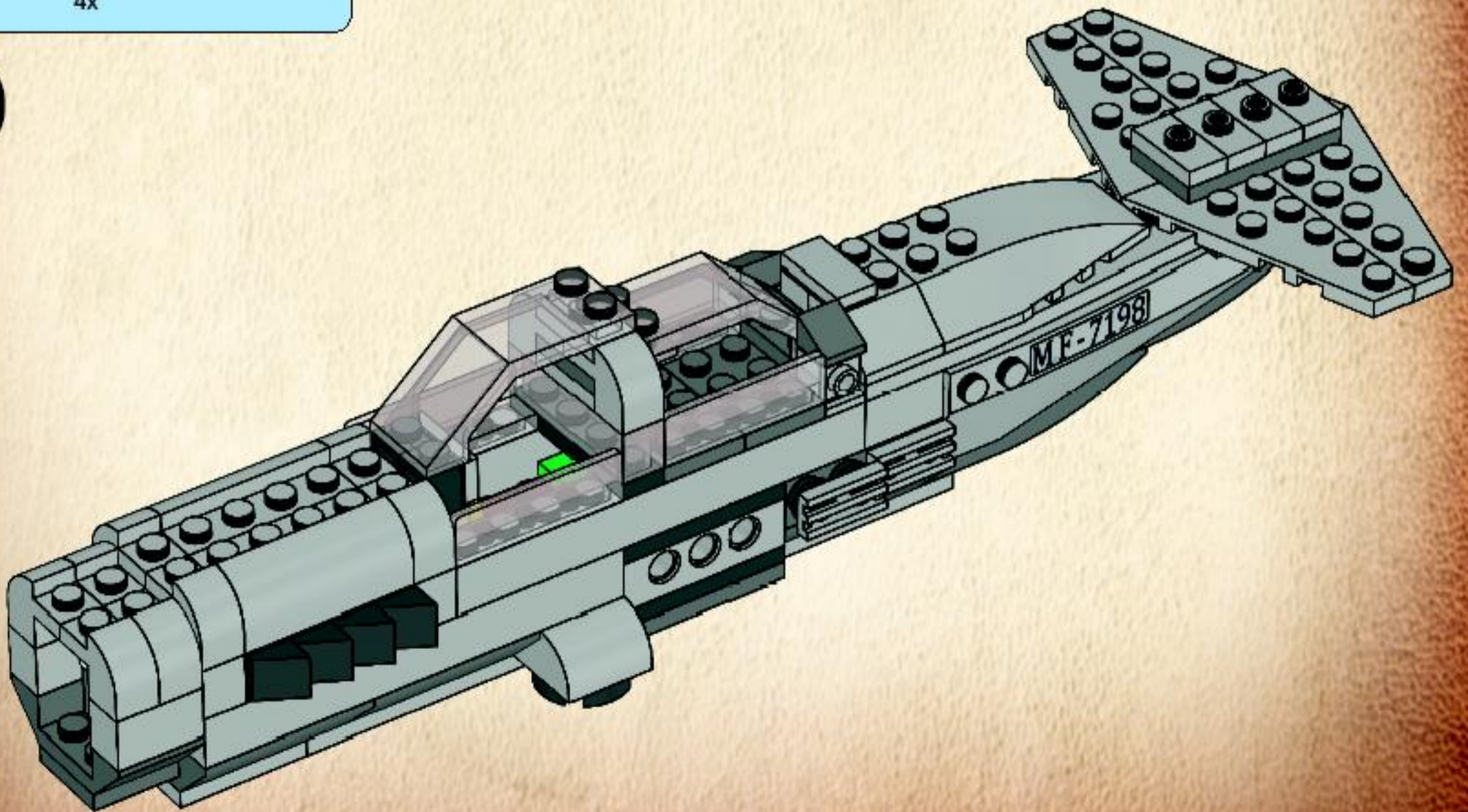



31

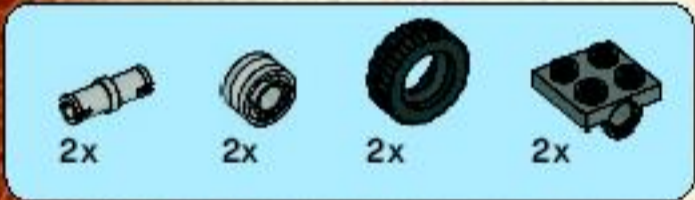
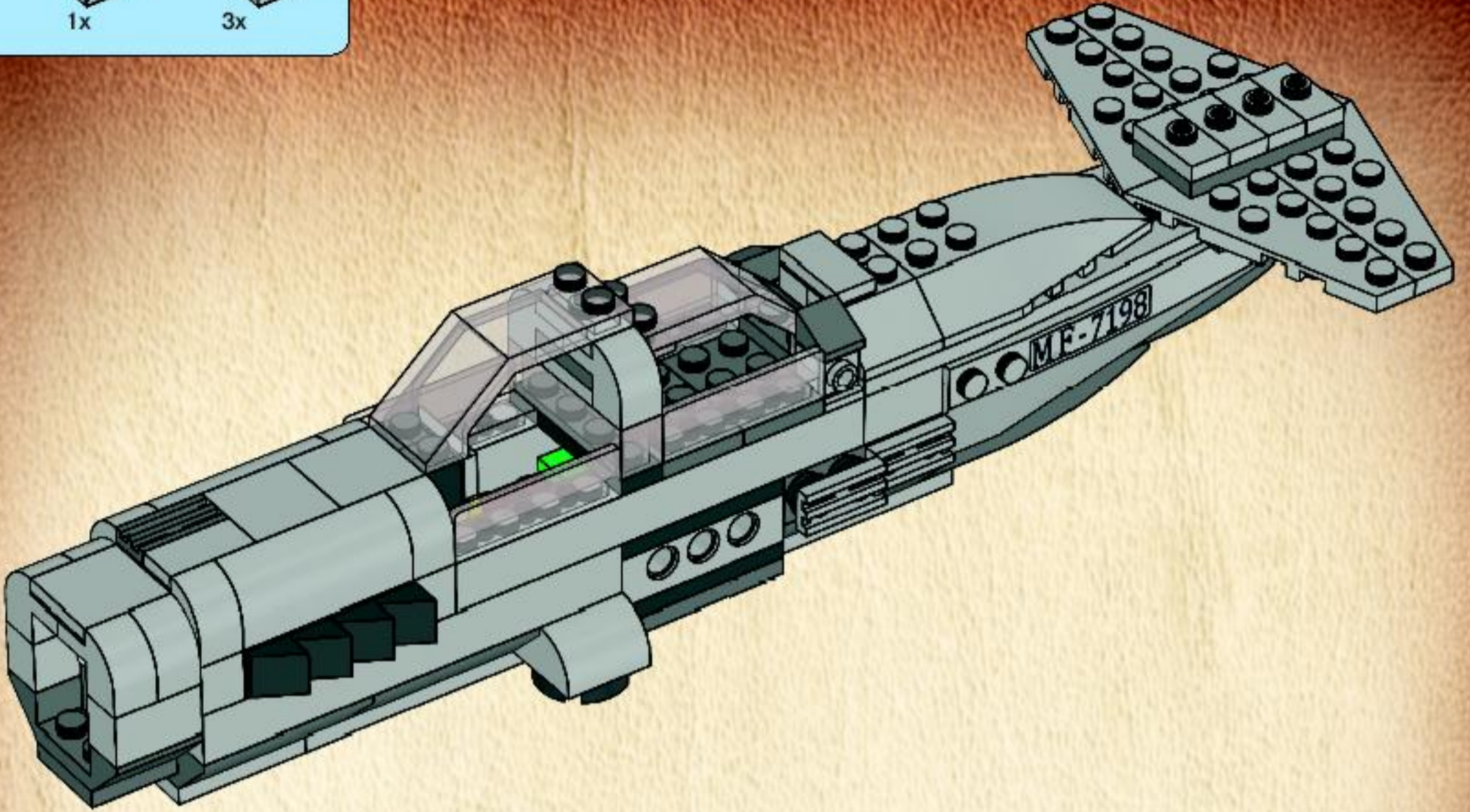

32

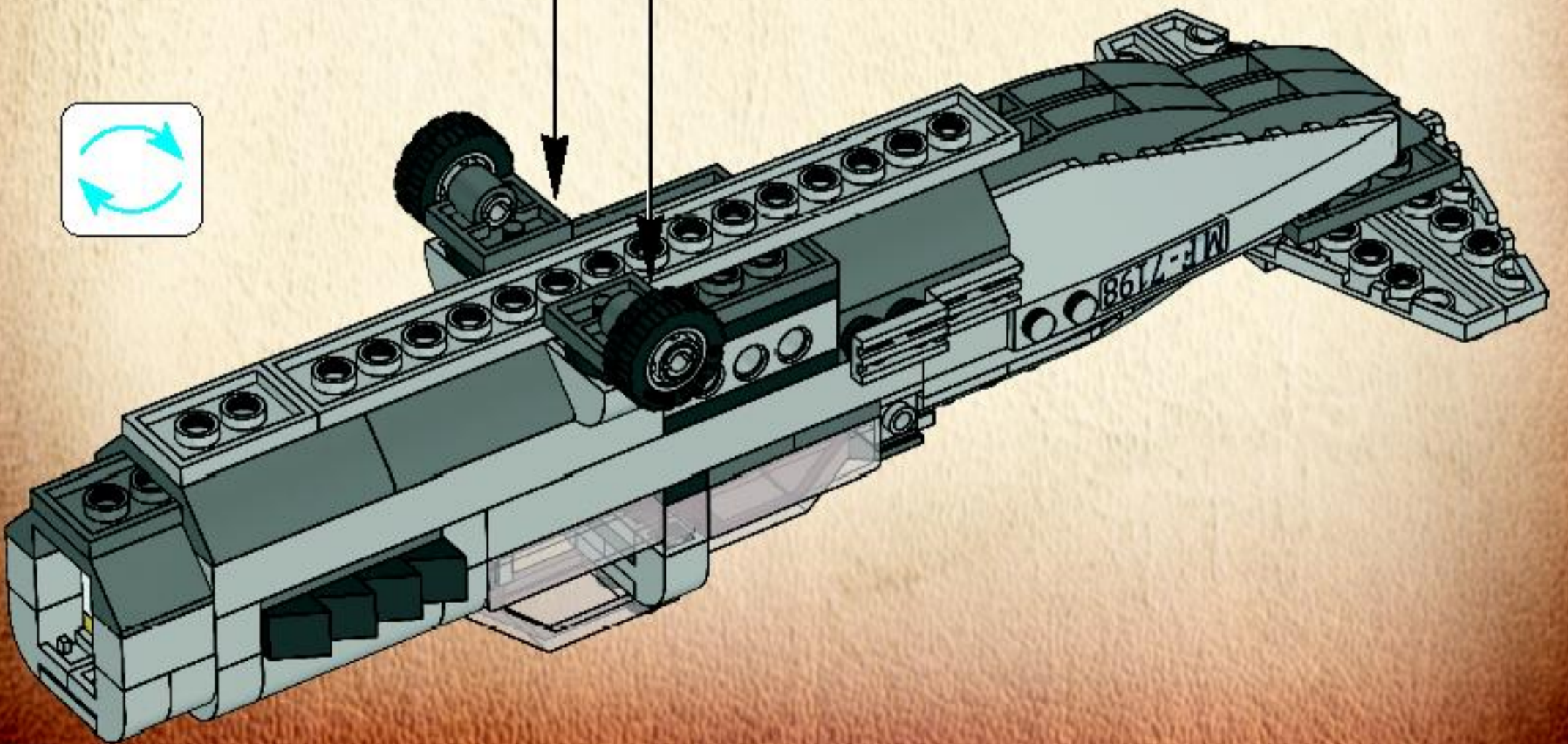
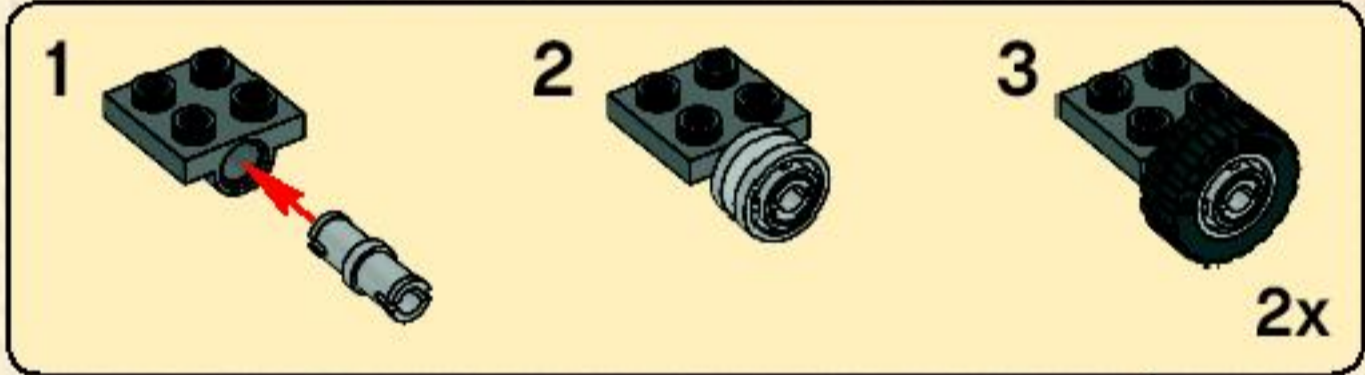

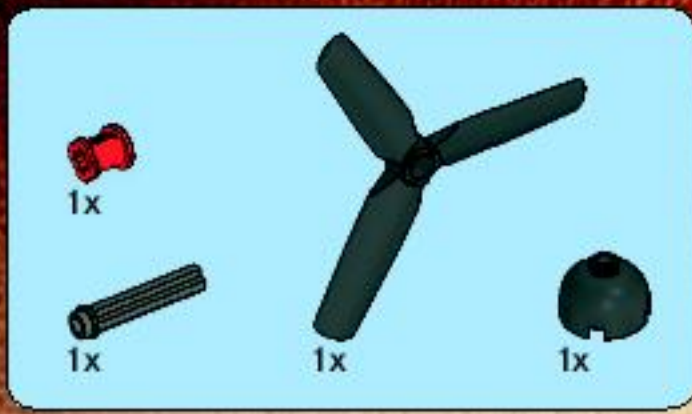

33

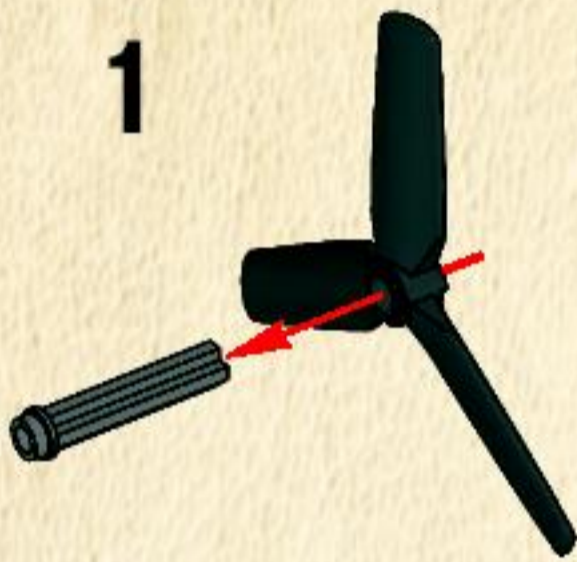

2

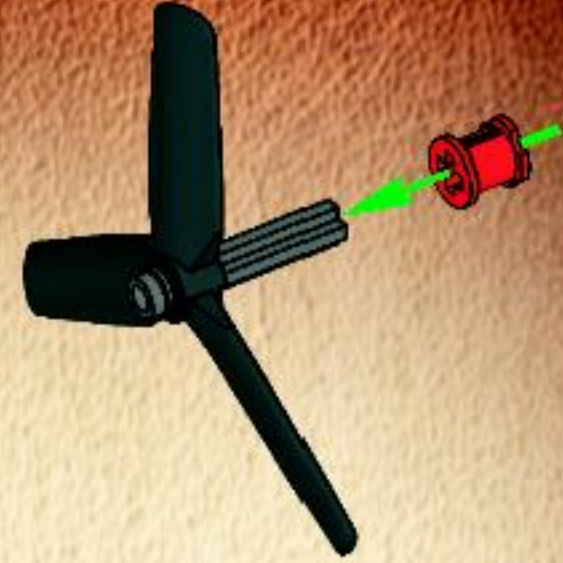

3

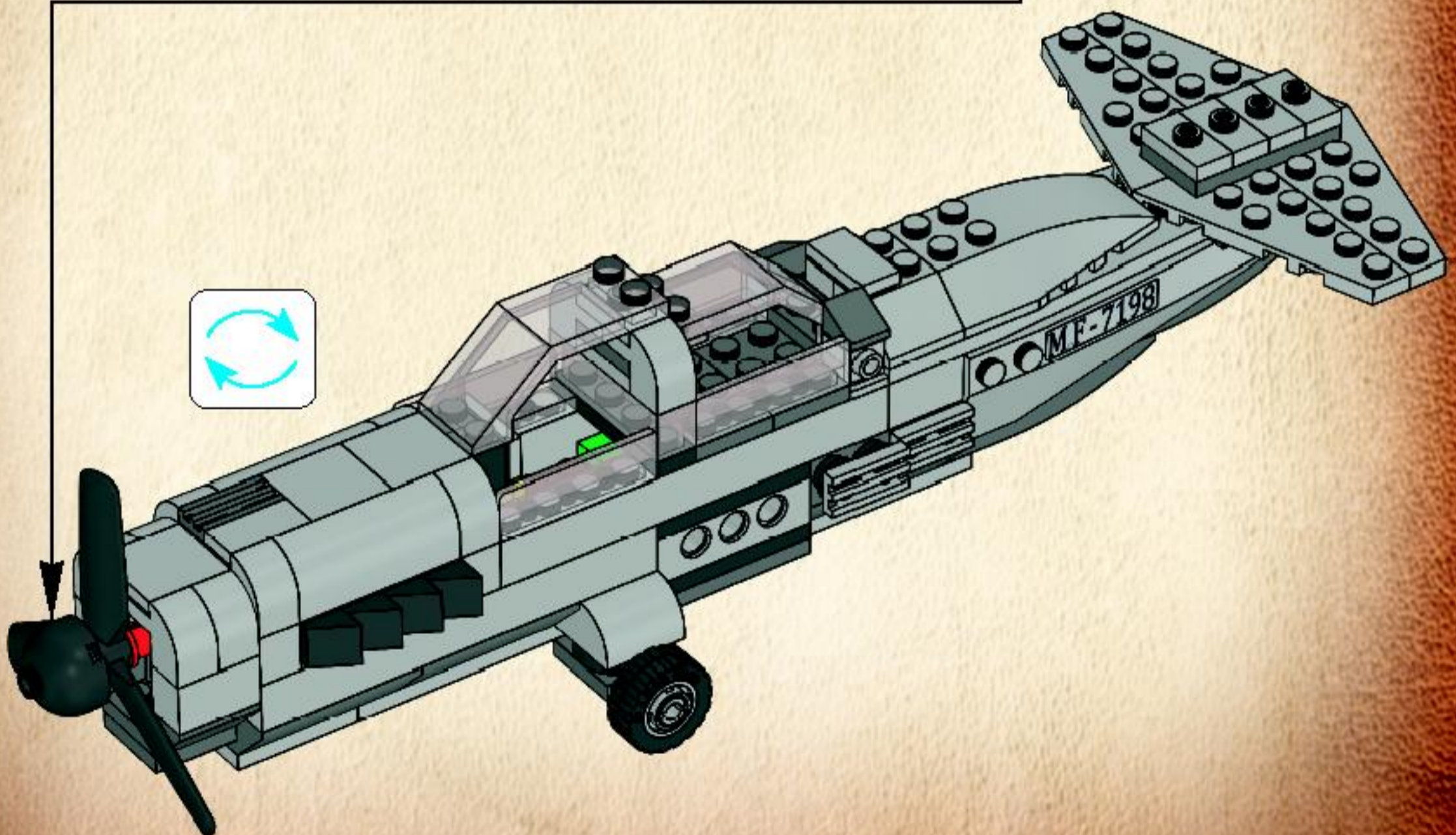

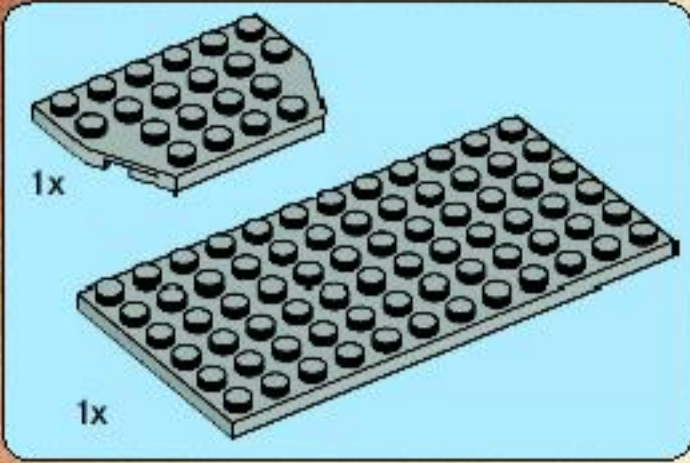

1

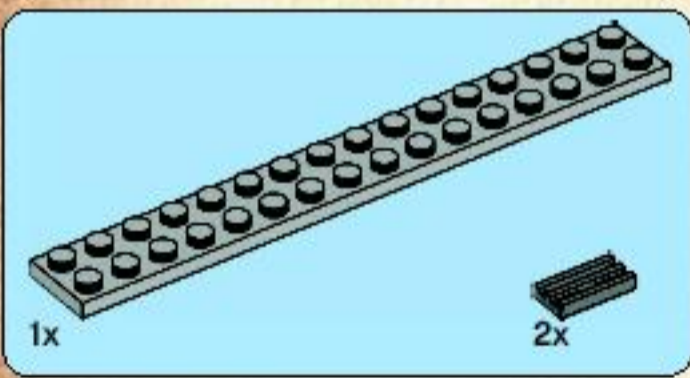
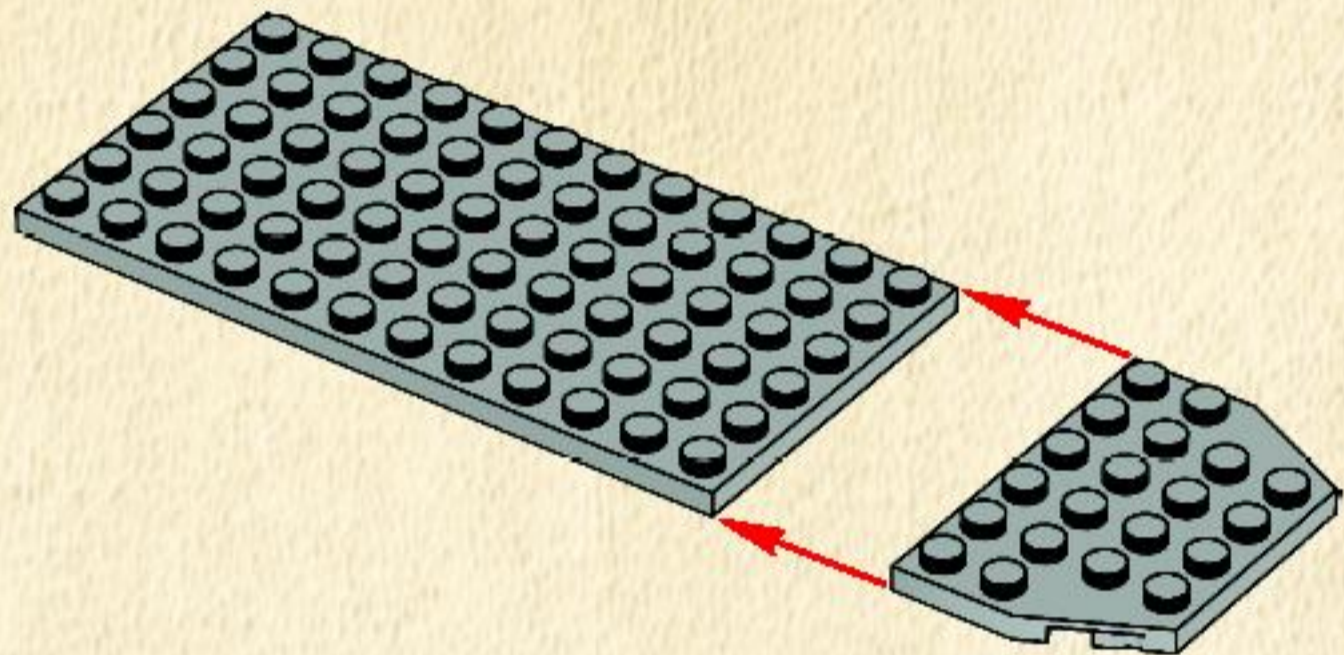

2

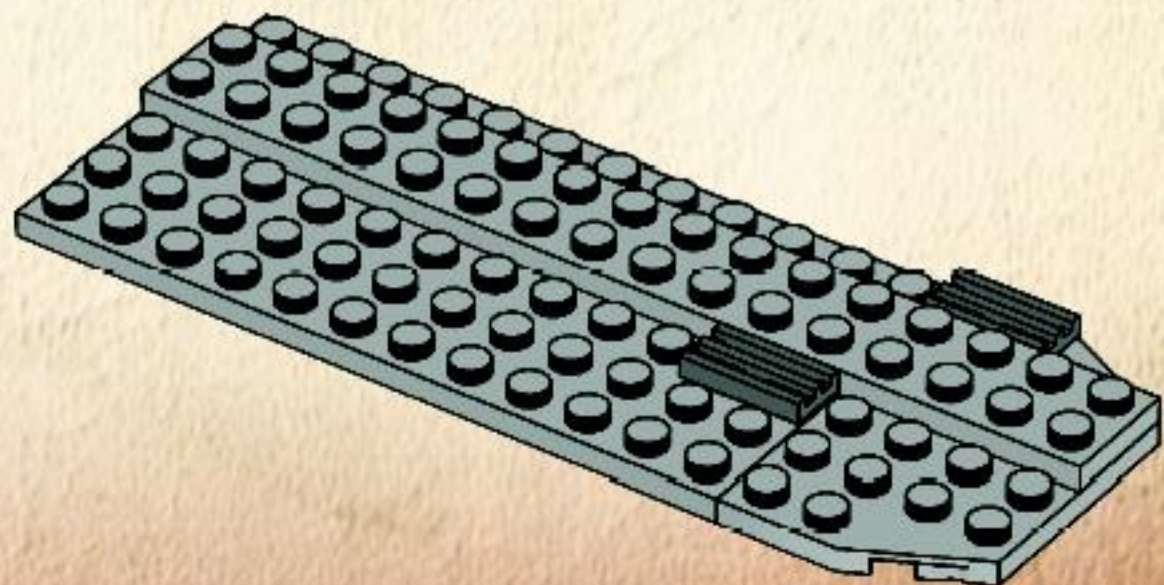

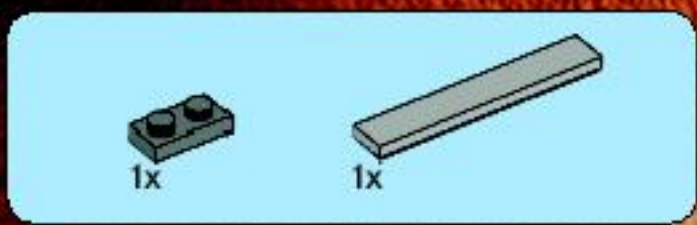

3

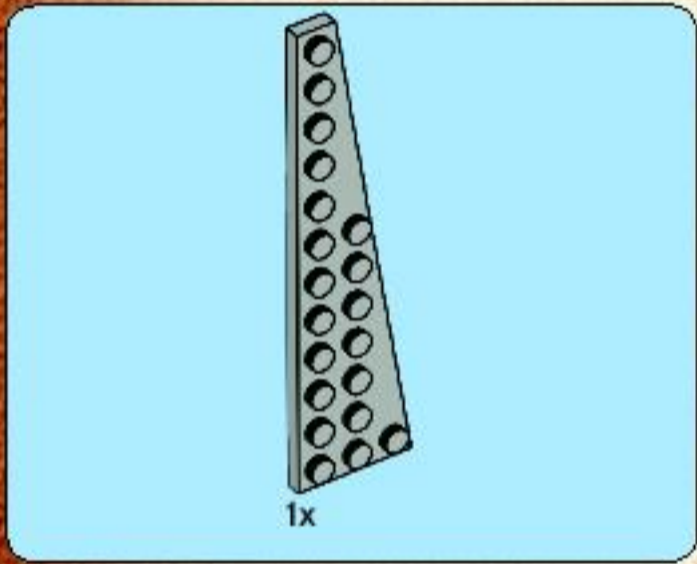
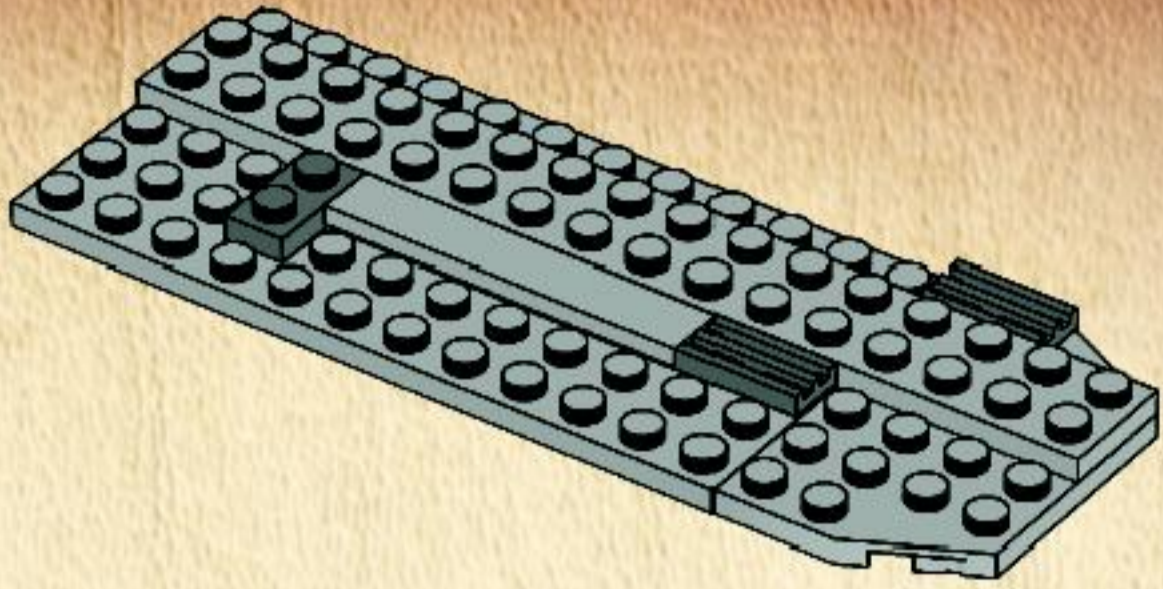

4

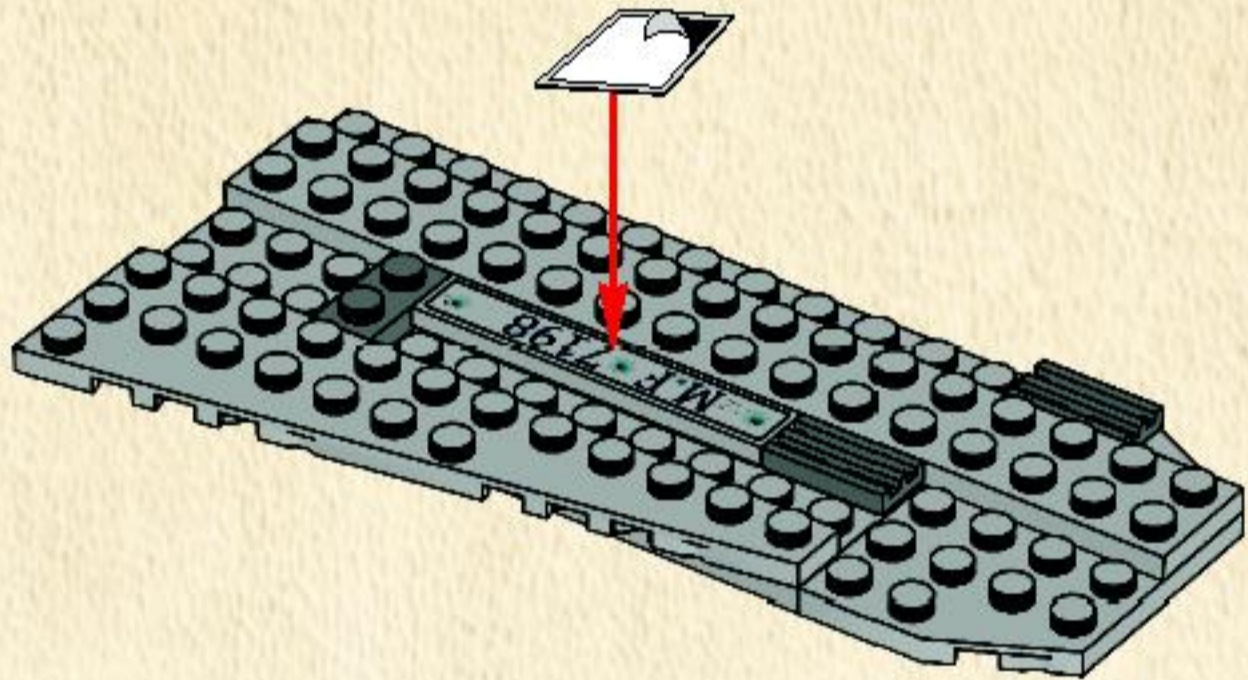

5

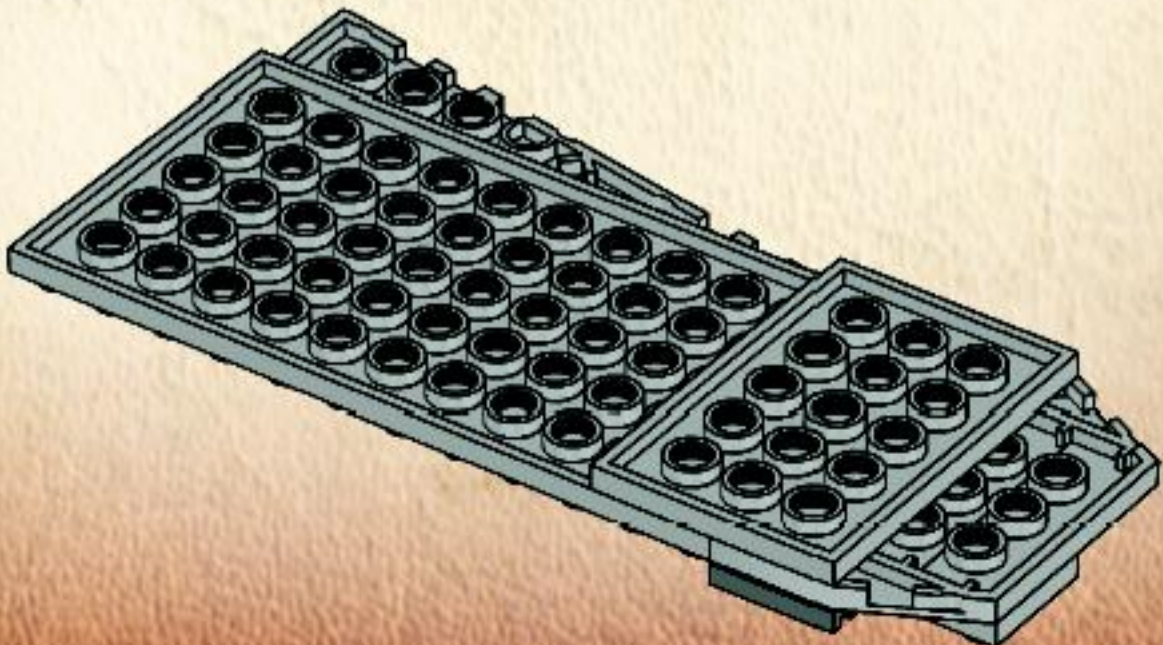



8

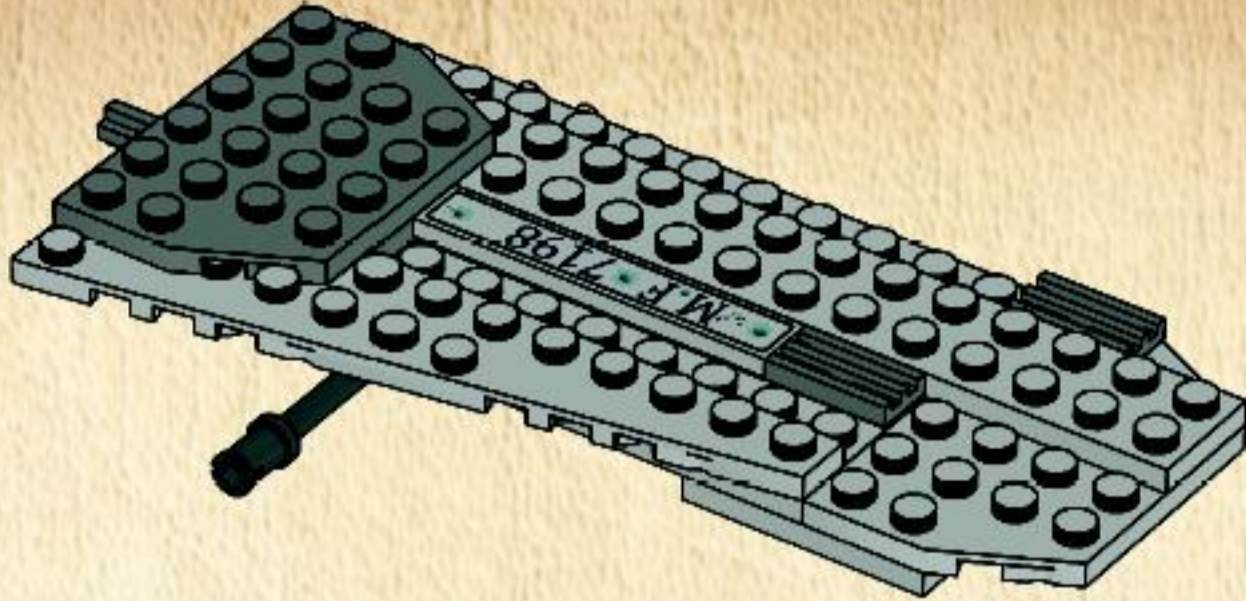

36

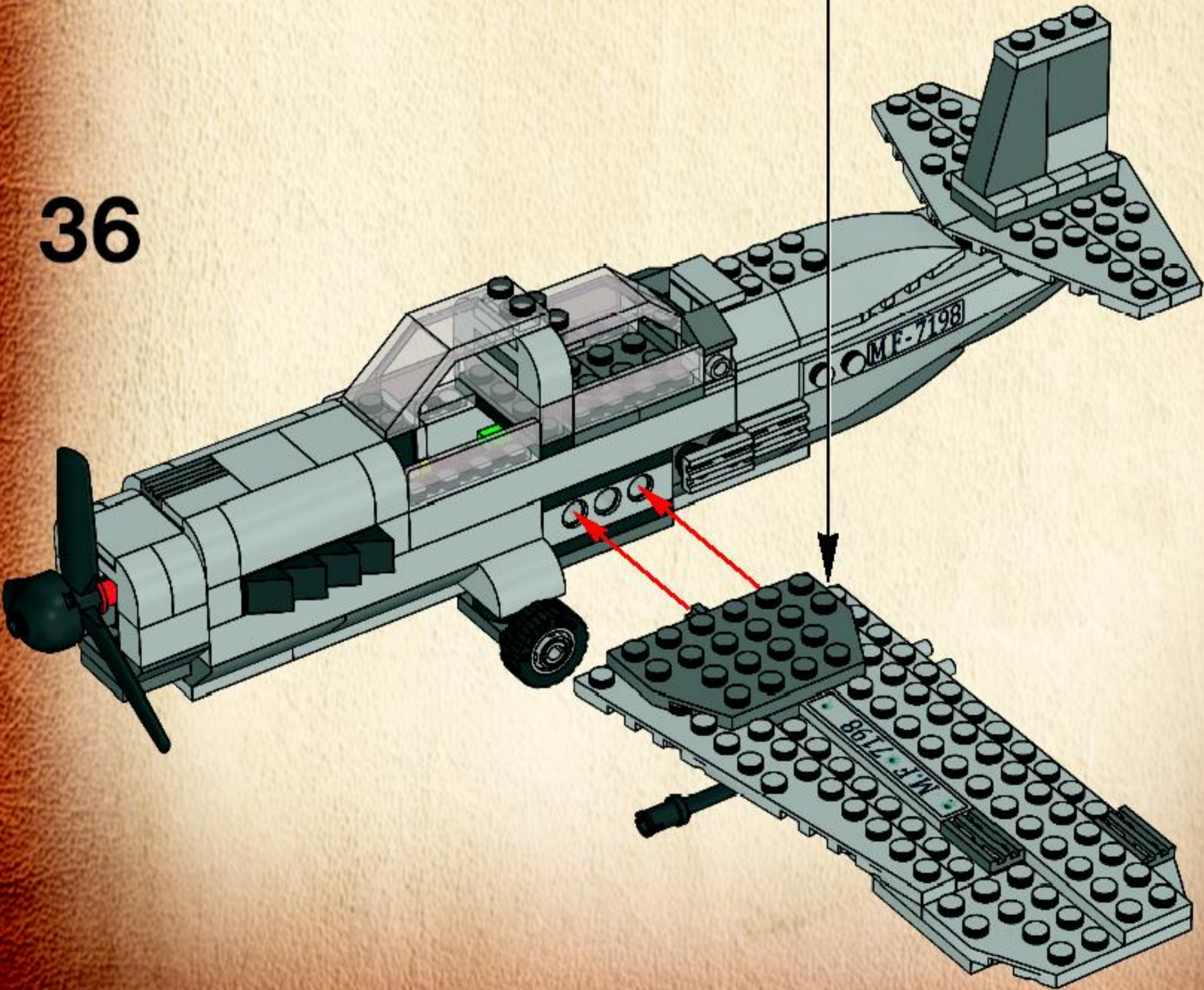

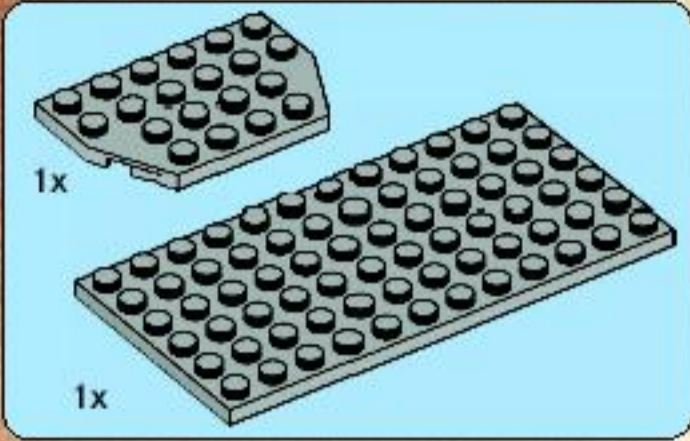
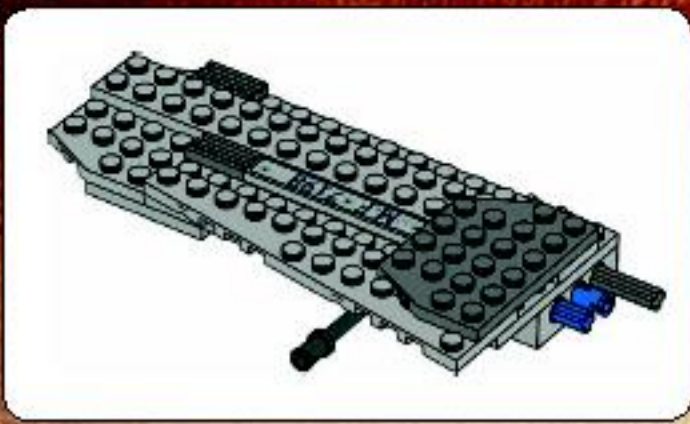

1

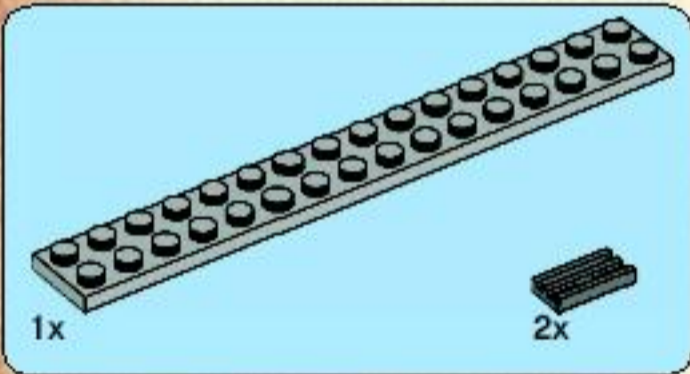
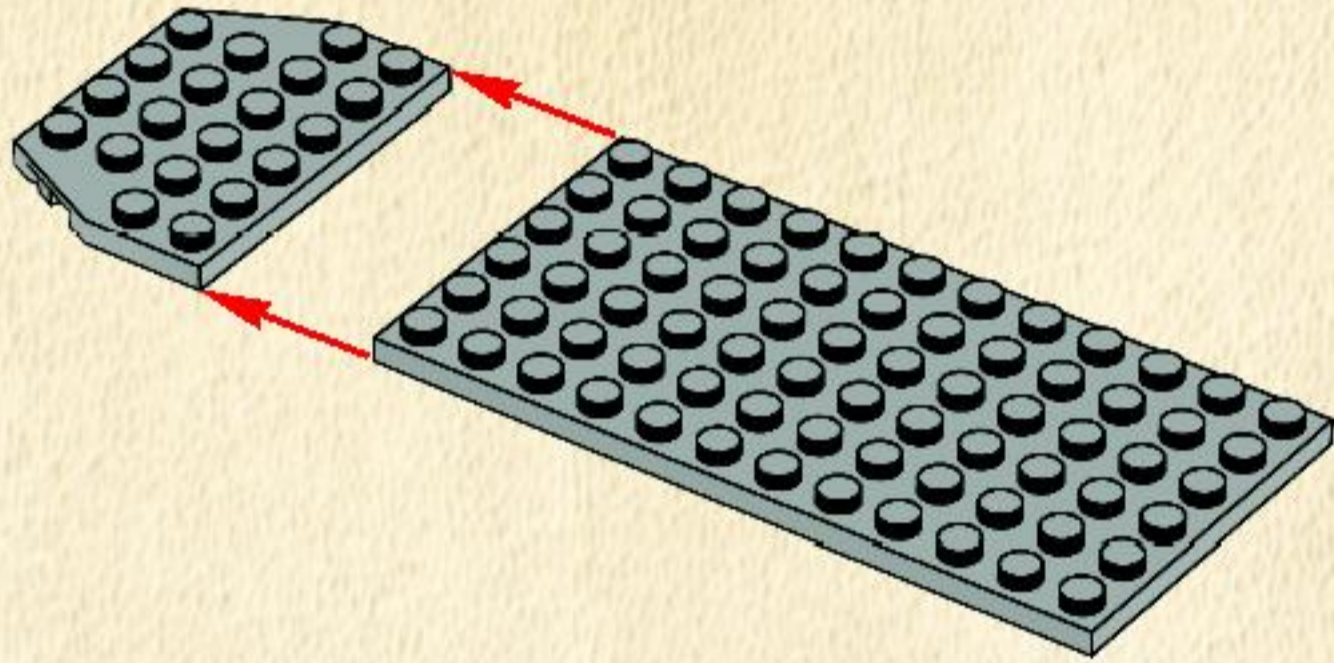

2

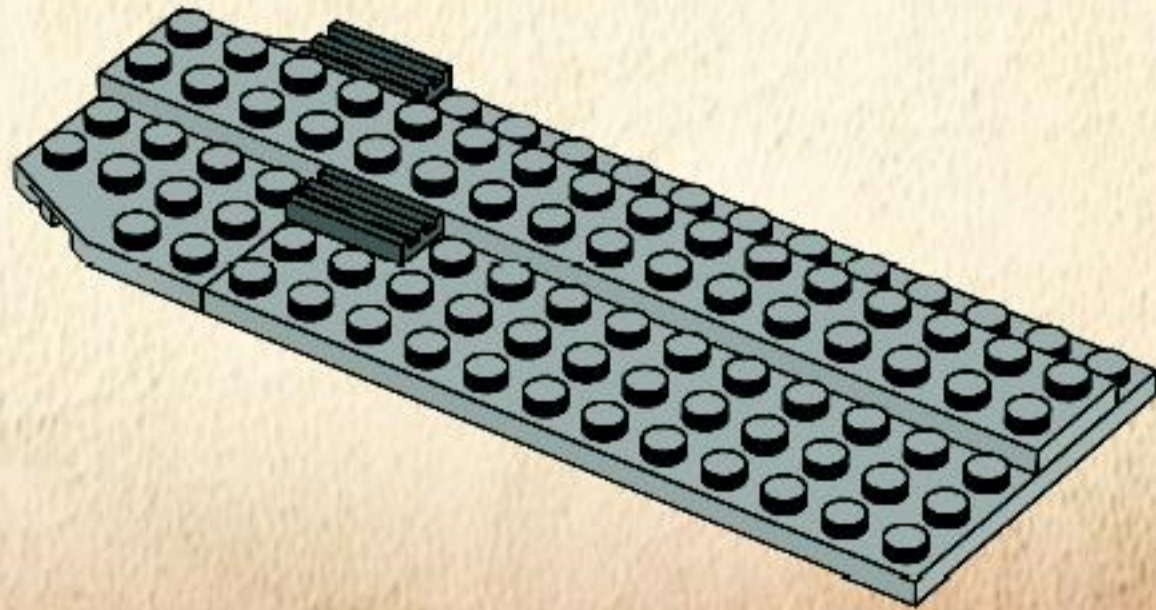

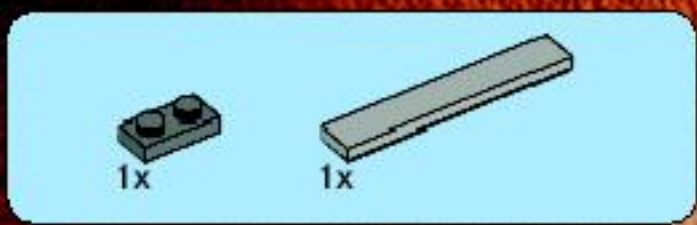

3

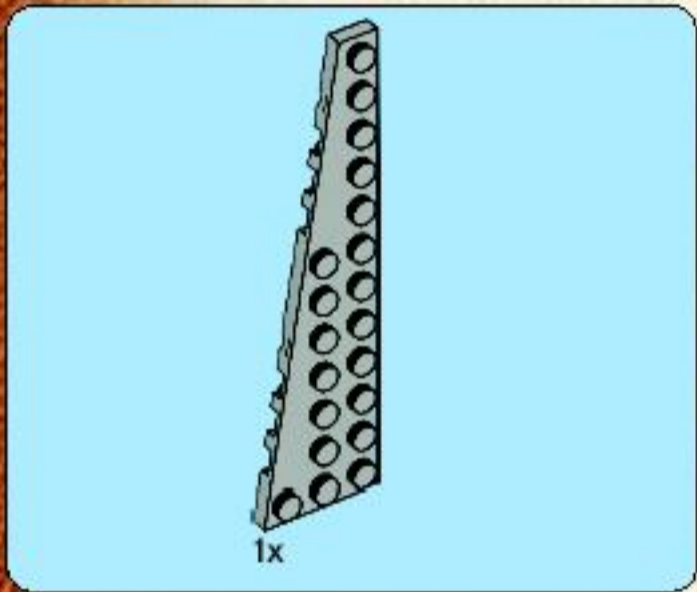
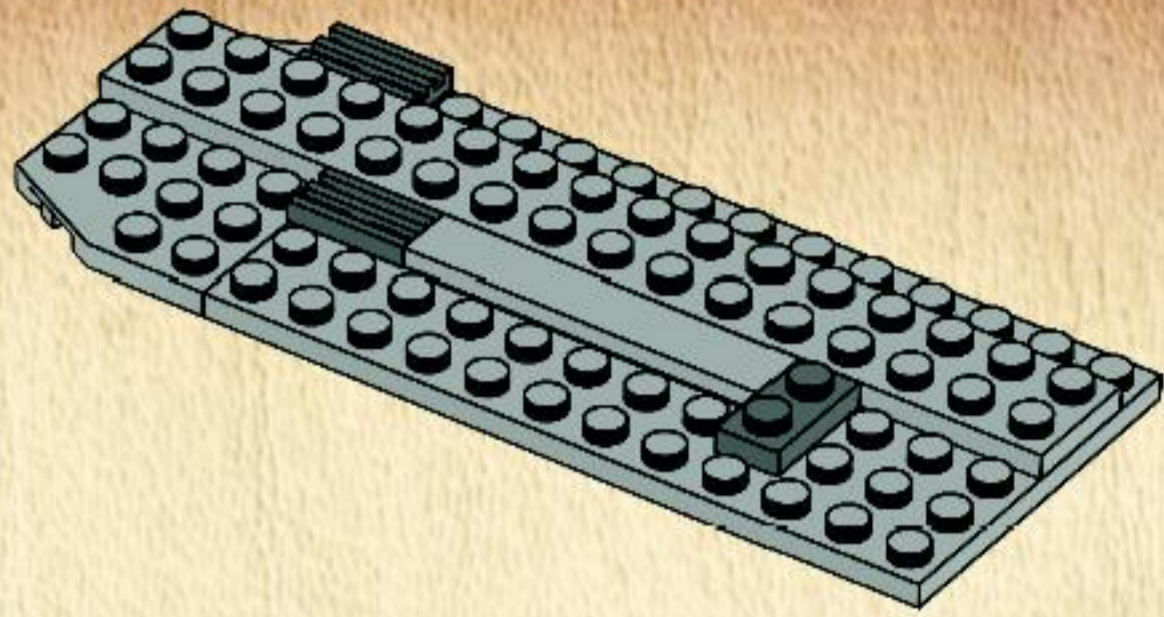

4

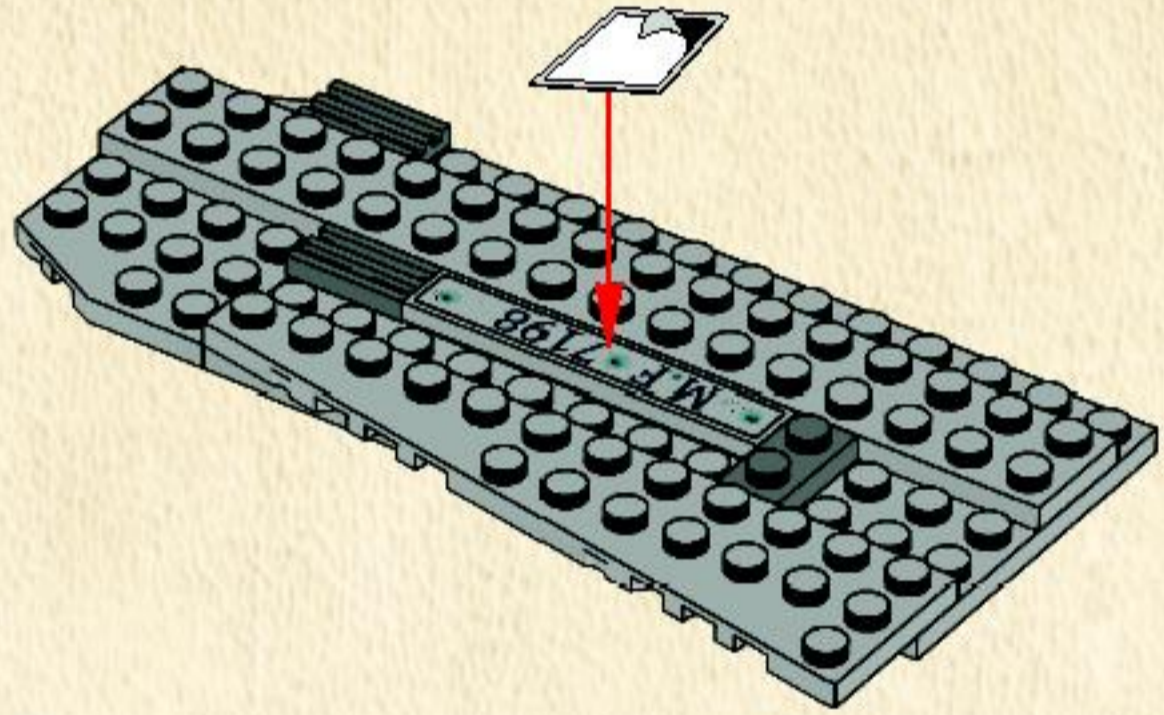

5

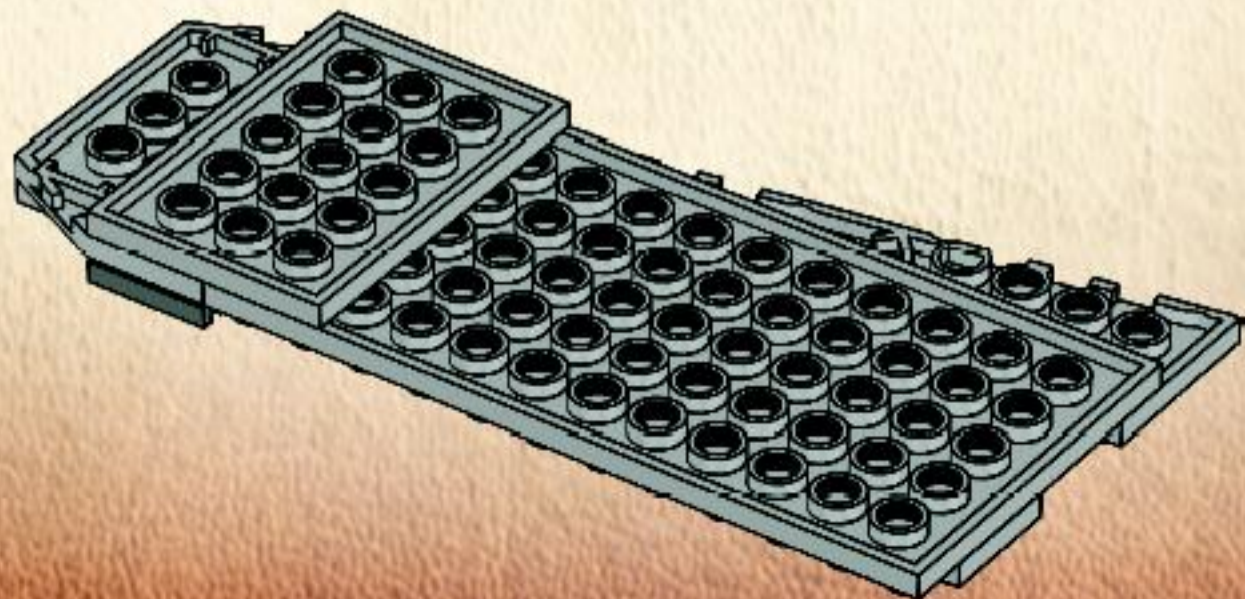

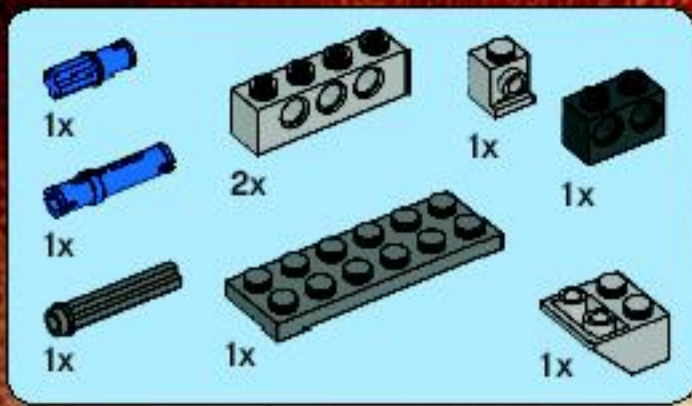

6

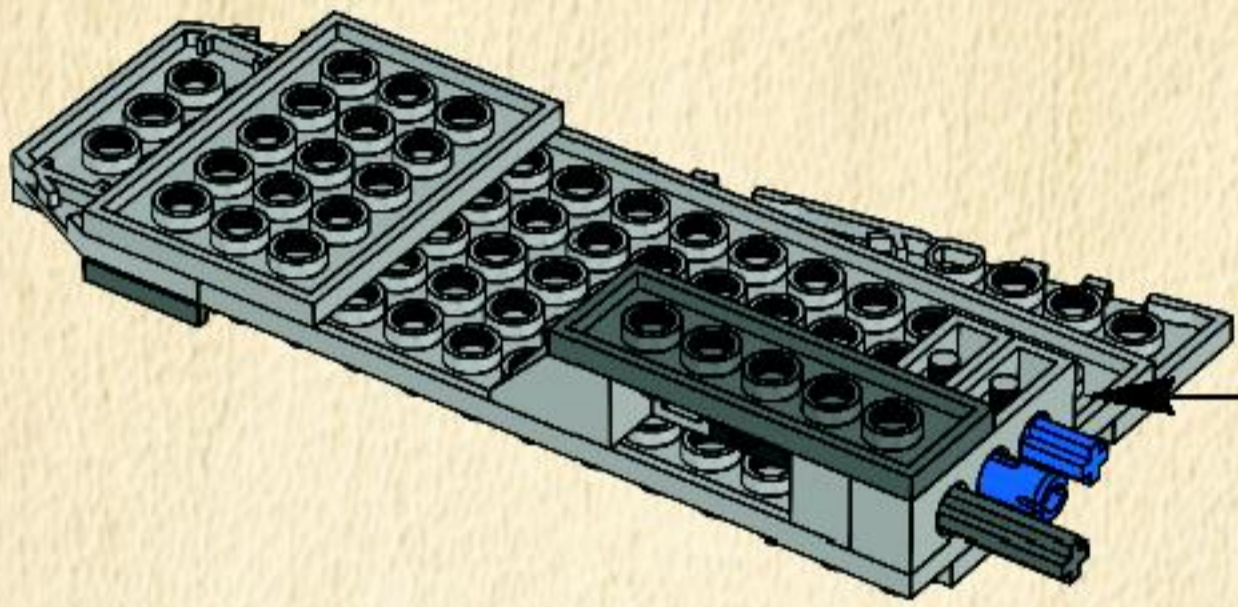
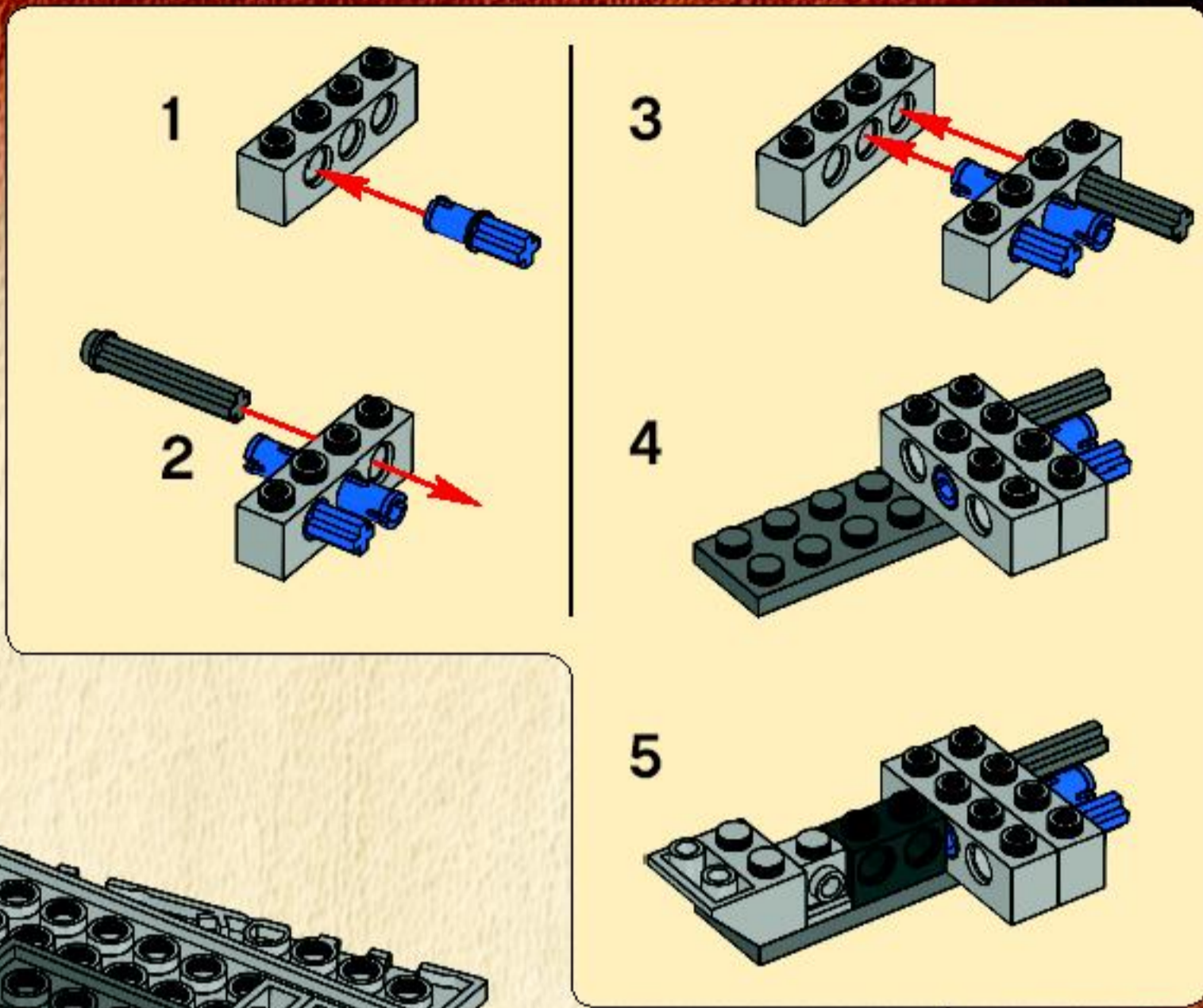

7

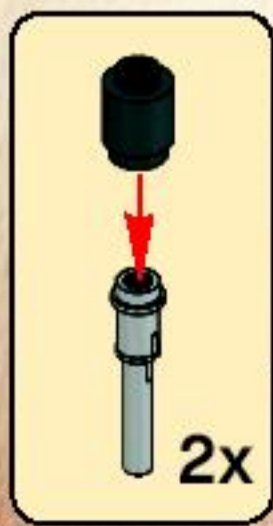
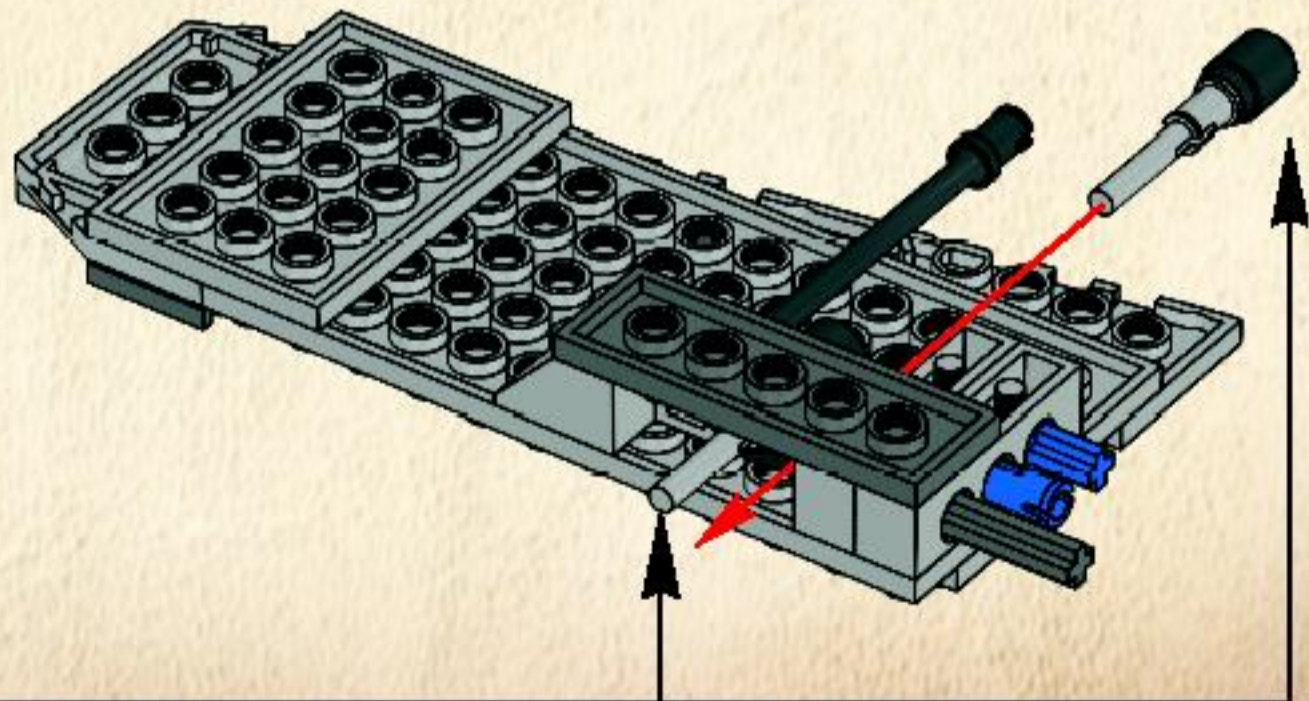



8

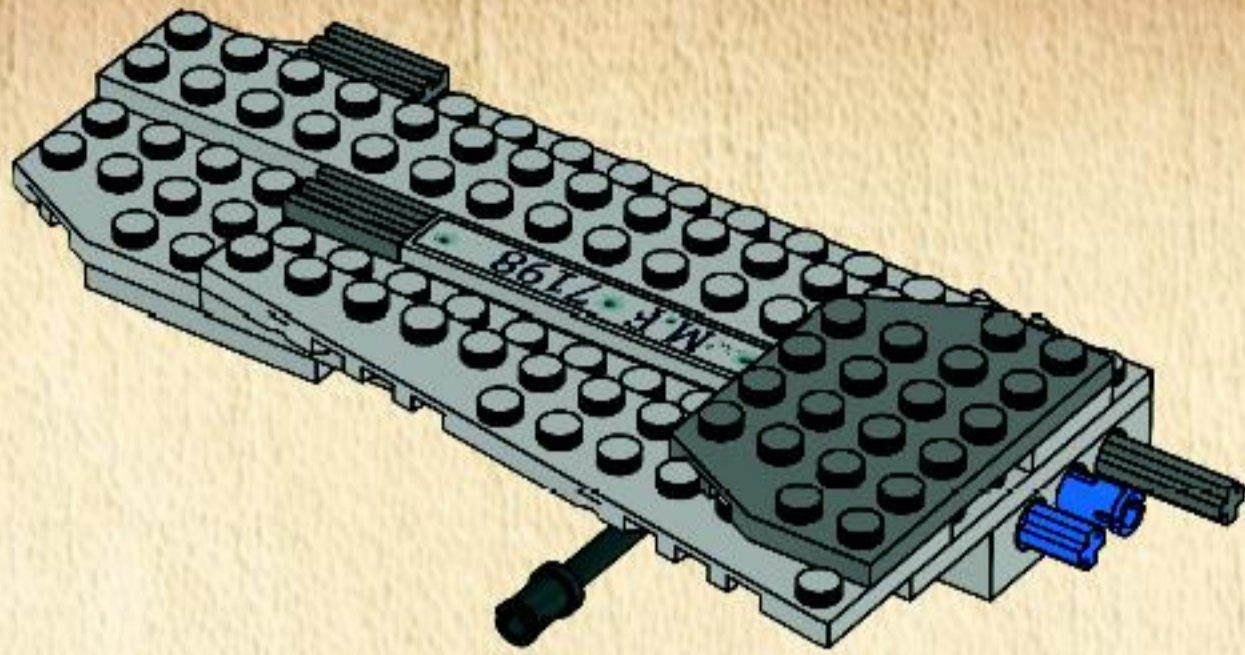

37

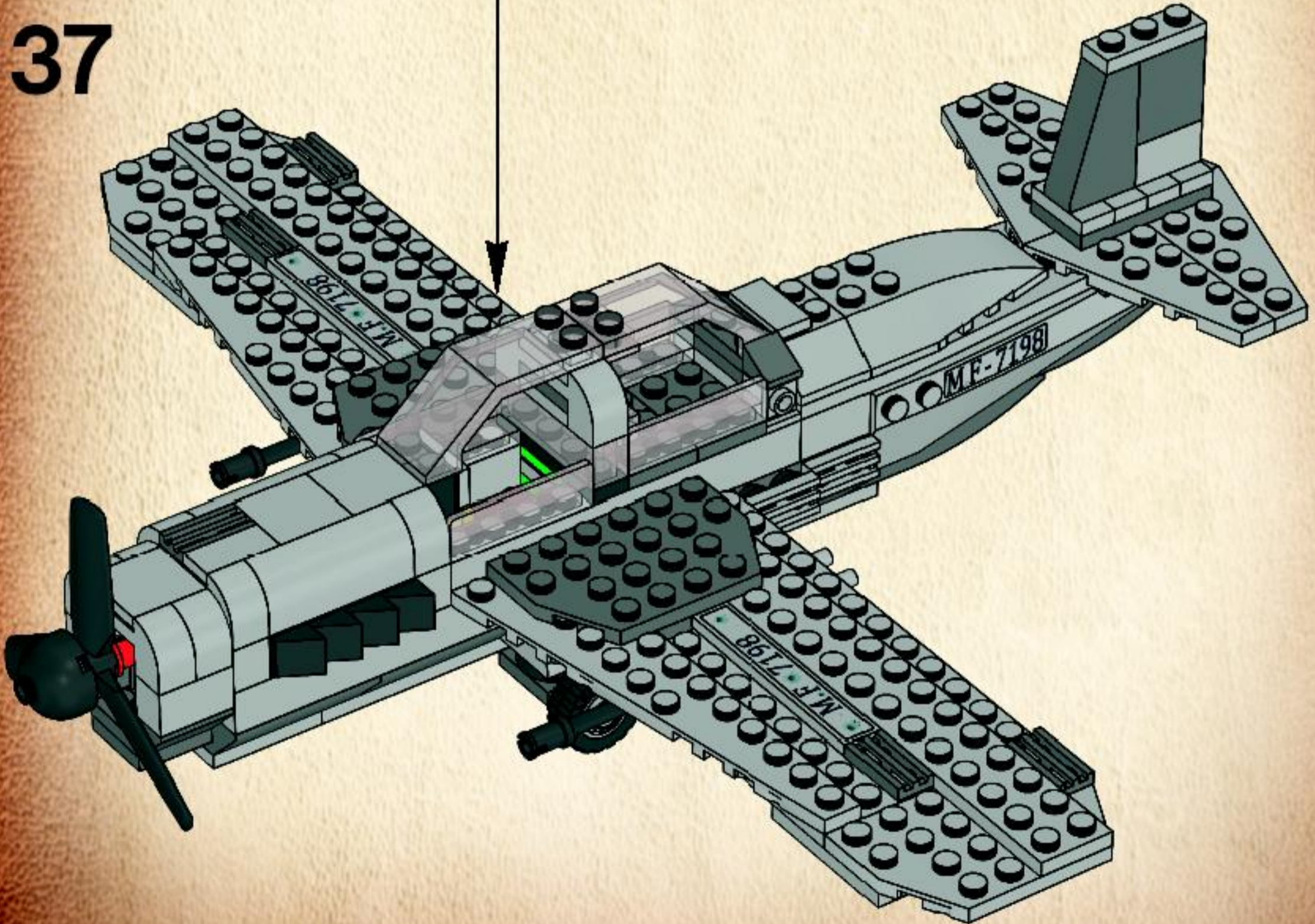

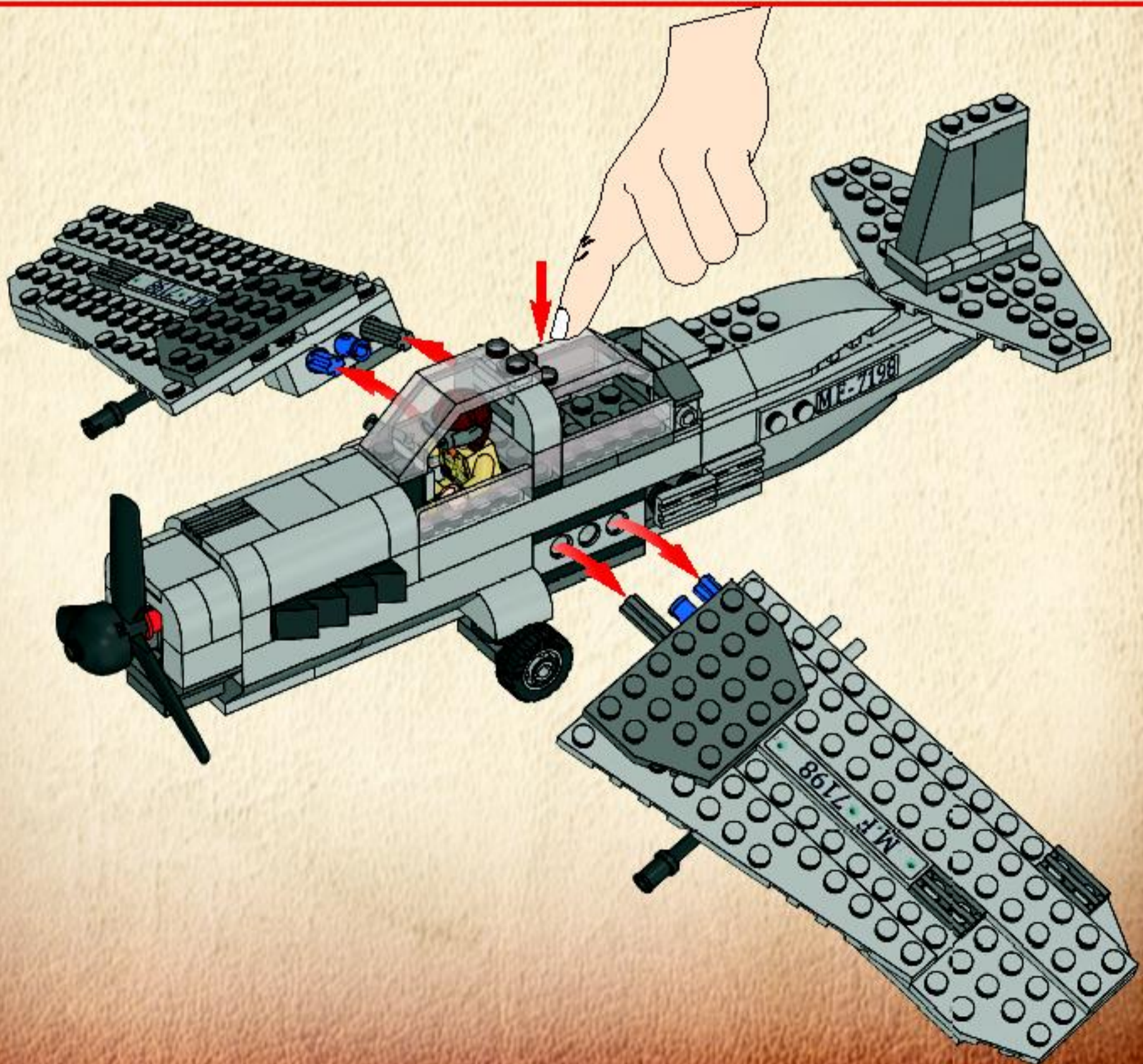
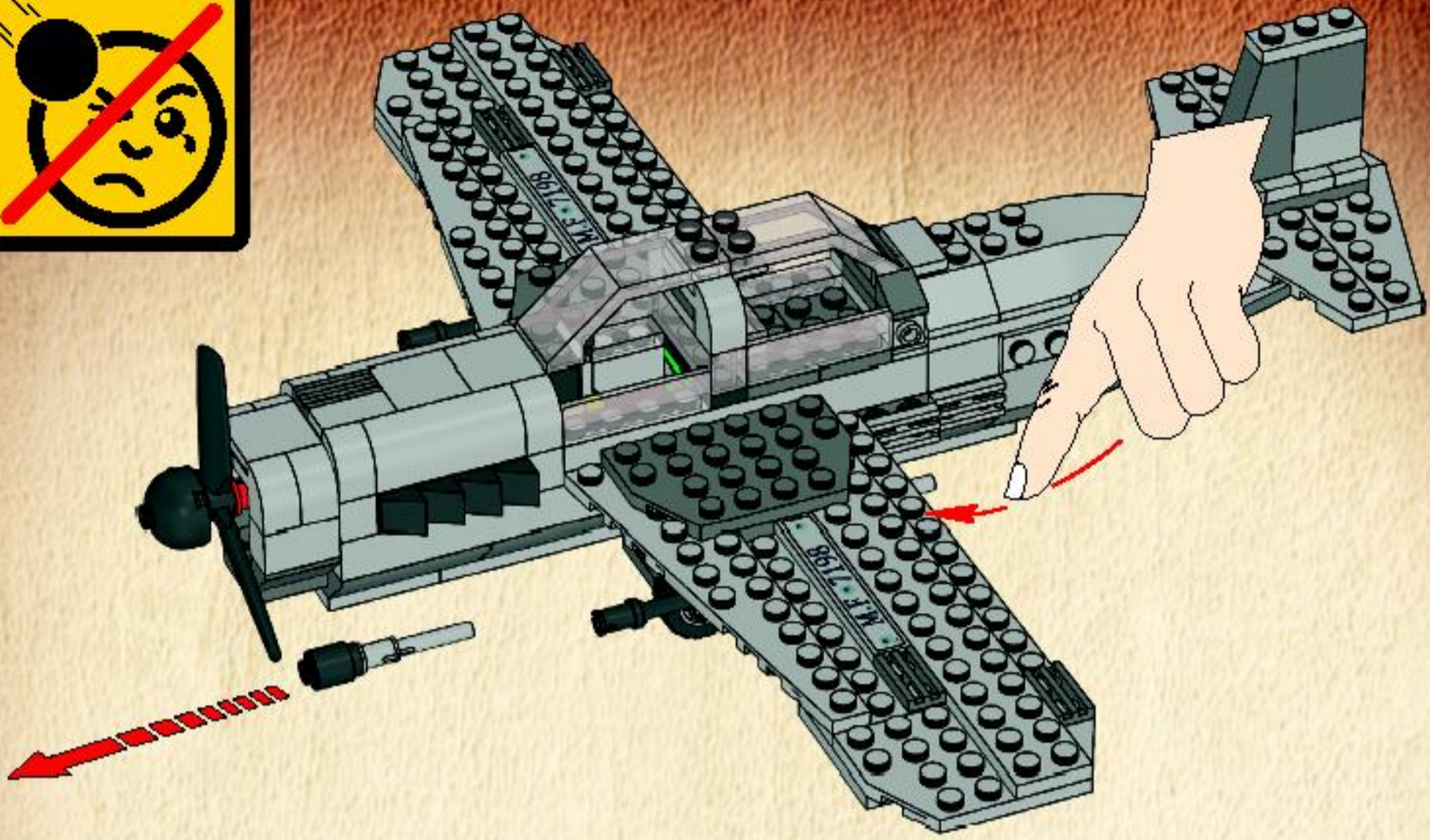





1x
4515290



2x
4209159



1x
4107736



1x
306928



1x
302228



1x
4142717



6x
4520320



1x
4211558



4x
4211476

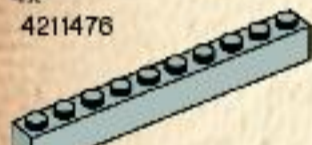

4x
4211521



5x
4211388



2x
4211636

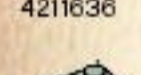

2x
4217918

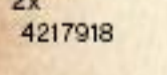

3x
4211385



1x
4180479



10x
4211519



2x
4260409



2x
4211807



2x
4211414



1x
4227776



2x
4211549



3x
4211413



4x
4211758



2x
4282789



2x
4282786



1x
4208988



1x
4209006



6x
4211350



6x
4211451



2x
4211376



1x
4540203



2x
4211398



1x
4211429



2x
4211445



1x
4211396



3x
4211452



3x
4211486



2x
4211725



2x
4211404



2x
4211400



2x
4211410



2x
4211436



8x
4211441



1x
4505088



1x
4505087



1x
4521702



1x
4210978



1x
4221745



4x
4210725



4x
4210779



2x
4210635



3x
4211086



1x
4210645



5x
4211063



1x
4211119



3x
4211065



2x
4211002



1x
4210678



2x
4243831



2x
4521572



2x
4210636



5x
4210631



2x
4211029



2x
4504378



1x
4211000



1x
4211076



3x
4227708



6x
4210633



1x
4522648



2x
4196768

Customer Service
Kundenservice
Service Consommateurs
Servicio Al Consumidor

www.lego.com/service or dial



: 00800 5346 5555

: 1-800-422-5346





7197



60 7196



7199



7195



INDIANA JONES

THE ORIGINAL ADVENTURES



AVAILABLE NOW



Wii



NINTENDO DS

Games for Windows

FREE! GRATIS! GRATUIT!



club
MAGAZINE™

www.LEGOclub.com



00800 5346 5555*

1-866-534-6258 • 1-877-518-5346
US & Canada only Canada seulement

* FreePhone. Mobile charges may apply. * Numéro sans Frais. Des Frais peuvent s'appliquer avec les téléphones cellulaires. * Gebührenfrei. Kosten für Anrufe aus Mobilfunknetzen können anfallen. * Grátis telefoonsnummer vanaf vaste lijn. * Débit est gratuit, mais du ringier Frais téléfon. * Het is gratis, al is du ringier Frais en kost telefon.



VISIT THE WORLD'S BIGGEST LEGO® SHOP! www.LEGOshop.com

YES! I want to join the LEGO® Club FREE! OUI! Je veux m'abonner au Club LEGO® GRATUITEMENT! Ja! Ich möchte Mitglied im kostenlosen LEGO® Club werden. Ja! Ik wil graag GRATIS lid worden van de LEGO® Club. Ja! Jeg ønsker å melde meg inn i LEGO® Club gratis! Ja! Jag vill gå med i LEGO® Club GRATIS!

First name - Prénom
Vorname - Voornaam
Fornavn - Fornavn

Last name - Nom de Famille
Naam - Achternaam
Etternavn - Efternavn

Date of Birth - Date de naissance
Geburtsdag - Geboortedatum
Fødselsdato - Fødselsdato

Boy - Garçon
Junge - Jongen
Gutt - Pojke

Girl - Fille
Mädchen - Meisje
Jente - Flicka

Street - Adresse
Strasse, Hausnr.
Straat, huisnr. - Adress

City - Ville
Ort - Woonplaats
Poststed - Postort

Zip/Postcode - Code Postal
PLZ - Postcode - Postnummer

Country
Pays - Land

Please tick below if you would like to receive other communication from the LEGO Group. **Stavos oimierz recevoir d'autres communications de la part de la compagnie LEGO, veuillez s.v.p. cocher ici.** Als u graag andere informatie van de LEGO Groep wilt ontvangen, kruis dan a.u.b. dit vakje aan. **Ich möchte über Produkte, Angebote, Aktionen und weitere interessante Themen von der LEGO Gruppe informiert werden* (bitte ankreuzen).** Om du vill få annen informasjon från LEGO Gruppen, sätt kryss här. **Hvis du ønsker å motta annen informasjon fra LEGO Gruppen, merker du av her.**

Post - Poste
Per Post

Email - Courriel
Per E-Mail
E-Mail

Ich möchte über Produkte, Angebote, Aktionen und weitere interessante Themen von sonstigen LEGO Partnerunternehmen informiert werden* (bitte ankreuzen). Per Post Per E-Mail

Mail to: / Poster à:
 BG29
LEGO® Club
P.O. Box 1157
Enfield, CT USA
06083-1157

Mail to:
 B109U
LEGO® Club
33 Bath Road
Slough SL1 3UF
United Kingdom

Per Post ont:
 B109C
LEGO® Club
Postfach 14 15
D-36243 Niederrado

Stuur op naar:
 B109N
LEGO® Club
Postbus 40250
3504 AB Utrecht

Send til:
 B109O
LEGO® Club Norge
Postboks 58
1314 Vøyenengo

Skickas till:
 B109S
LEGO® Club Sverige
Ubox 841
202 29 Mölmo

EN The English language version of the magazine can only be mailed to addresses in the US, Canada, the UK, and Republic of Ireland. Club membership is valid for two years and includes free copies of the LEGO Club Magazine. In the US and Canada please allow up to 6 weeks for delivery of your first magazine. In the UK and Republic of Ireland please allow six to 14 weeks for delivery of your first magazine. By signing this form you consent the LEGO Club to use your child's data for LEGO mailings. The data will only be used for LEGO mailings and will not be sold, rented or otherwise disclosed to any company outside the LEGO Company except for disclosure to companies acting as our agents to help us provide services requested by the child. This coupon is valid for one free membership per person, group or organization. Photocopied coupons are accepted. **FR** La version française du magazine peut être postée uniquement au Canada. L'abonnement est valide pour 2 ans et inclut des exemplaires gratuits du Magazine LEGO. Aux É.-U. et au Canada, allowez 6 semaines pour la livraison initiale. En remplissant ce formulaire, vous consentez à ce que LEGO utilise les informations de votre enfant pour des envois postaux de LEGO. L'information sera utilisée uniquement pour des envois postaux par LEGO et ne sera en aucun cas, vendue, louée, échangée ou divulguée à d'autres compagnies autres que la compagnie LEGO, à l'exception des compagnies affiliées qui nous procurent des services auxquels l'enfant en a fait la demande. **DE** Das deutschsprachige LEGO Club Magazine kann nur an Adressen in Deutschland, Österreich und der Schweiz verschickt werden. Die kostenlose Mitgliedschaft beinhaltet die Zusendung des LEGO Club Magazines und endet nach zwei Jahren. Mit der Anmeldung gehen Sie keine Verpflichtungen ein. Es kann bis zu drei Monate dauern, bis das erste Magazin zugestellt wird. Mit Ihrer Unterschrift erklären Sie sich damit einverstanden, dass die Daten Ihres Kindes zum Zwecke einer LEGO Club Mitgliedschaft von der LEGO Gruppe gespeichert und verarbeitet werden. Die Daten werden vertraulich behandelt, nicht an Dritte weitergegeben und nicht veröffentlicht. Externe Dienstleister erhalten Ihre Daten nur, soweit es für die Abwicklung von LEGO Kommunikation erforderlich ist. Wenn Sie von uns nicht mehr kontaktiert werden möchten, können Sie der Verwendung Ihrer Daten für Werbezwecke widersprechen unter: 00800 5346 5555 (Anruf gebührenfrei, Kosten für Anrufe aus Mobilfunknetzen können abweichen). * Die Einwilligungen kann ich jederzeit (insgesamt oder zum Teil) ohne Einfluss auf die LEGO Club Mitgliedschaft bei der LEGO Gruppe widerrufen. **NL** Het LEGO Club Magazine kan alleen worden gestuurd naar adressen in Nederland. Het lidmaatschap is 2 jaar geldig en geeft recht op toezending van het gratis LEGO Club Magazine. Het eerste magazine zal na 12 tot 14 weken toegestuurd worden. Het lidmaatschap kan op ieder moment opgezegd worden. Door dit formulier te tekenen geeft u de LEGO Club toestemming om bovenstaande gegevens te gebruiken voor het toesturen van LEGO mailings. Uw gegevens worden uitsluitend gebruikt voor mailings van LEGO en zullen niet worden verkocht, verhuurd of op welke wijze dan ook verstrekt aan derden buiten de LEGO Groep, uitgezonderd de organisaties die namens ons optreden om de service te verlenen waar uw kind om gevraagd heeft. **NO** Den norske utgaven av magasinet sendes kun til adresser i Norge. Medlemskap i klubben gjelder i 2 år og inkluderer gratisutgaver av LEGO Magazine. Påregnet opp til seks uker leveringstid for første magasin. Ved å undertegne dette skjemaet, gir du ditt samtykke til at LEGO Club kan bruke opplysningene om barnet ditt i LEGO forsendelser. Dataene vil utelukkende bli brukt i LEGO forsendelser og vil ikke bli solgt, utleid eller på annen måte gjøres tilgjengelig for selskaper utenfor LEGO gruppen, unntatt selskaper som er våre agenter og som hjelper oss å tilby tjenestene barnet etterspør. Dette skjemaet gjelder for ett gratis medlemskap per person, gruppe eller organisasjon. **SE** Den svenska versionen av tidningen kan endast skickas till adresser i Sverige. Club-medlemskapet är giltigt i 2 år och innefattar gratis exemplar av LEGO Club Magazine. Vänligen räkna med 6 veckor för leverans av din första tidning. Genom att skicka in det här formuläret godkänner du att LEGO Club använder barnets uppgifter för LEGO utskick. Uppgifterna kommer bara att användas för LEGO utskick och kommer inte att säljas, hyras ut eller vidarebefordras till något företag som inte tillhör LEGO Gruppen, med undantag av företag som agerar som våra ombud för att tillhandahålla tjänster som barnet har begärt. Den här kupongen gäller för ett gratis medlemskap per person, grupp eller organisation.

Parent's signature - Signature d'un parent - Unterschrift Erziehungsberechtigter
Tildelingunderskrift - Førelses/Forentets underskrift - Forældres/Förmyndares underskrift

Date
Datum
Dato

WIN LEGO® PRODUCTS

Fill out a survey and you might WIN a cool LEGO product!
NO PURCHASE NECESSARY

Open to all residents where not prohibited

Go to www.acnielsen.aim.dk/LEGO to fill out a survey for a chance to win a LEGO product.

WIN LEGO® PRODUCTEN

Vul een enquêteformulier in en maak kans op een cool LEGO® product!

Kopen niet nodig

Iedereen uit landen waar geen enquêteverbod geldt mag deelnemen.

Ga naar www.acnielsen.aim.dk/LEGO, vul een enquêteformulier in en maak kans op een LEGO product.

GEWINNE LEGO® PRODUKTE

Nimm an der Umfrage teil und GEWINNE ein tolles LEGO® Produkt!

Die Teilnahme am Gewinnspiel führt zu keinerlei

Kaufverpflichtungen

Teilnahme in allen nicht ausgeschlossenen Ländern möglich

Wir verlosen unter allen Teilnehmern der Umfrage auf

www.acnielsen.aim.dk/LEGO LEGO Produkte.

GAGNE DES PRODUITS LEGO®

Réponds à un questionnaire et tu pourras GAGNER un produit LEGO® très cool !

Aucune obligation d'achat.

Ouvert à tous les résidents des pays autorisés.

Visite www.acnielsen.aim.dk/LEGO pour répondre à un

questionnaire et avoir une chance de gagner un produit LEGO.

レゴ®製品を「当てよう」

アンケートに記入して、かっこいいレゴ®製品を当てよう！

お買い上げの必要はありません。

禁止されていない限り、すべての皆様にご利用いただけます。

www.acnielsen.aim.dk/LEGOにアクセスして、アンケートにご記入ください。当選者にはレゴ製品を差し上げます。

www.nielsen.com/LEGO



©2009 The LEGO Group. 4561 826