



PHARAOH'S QUEST



7327



1

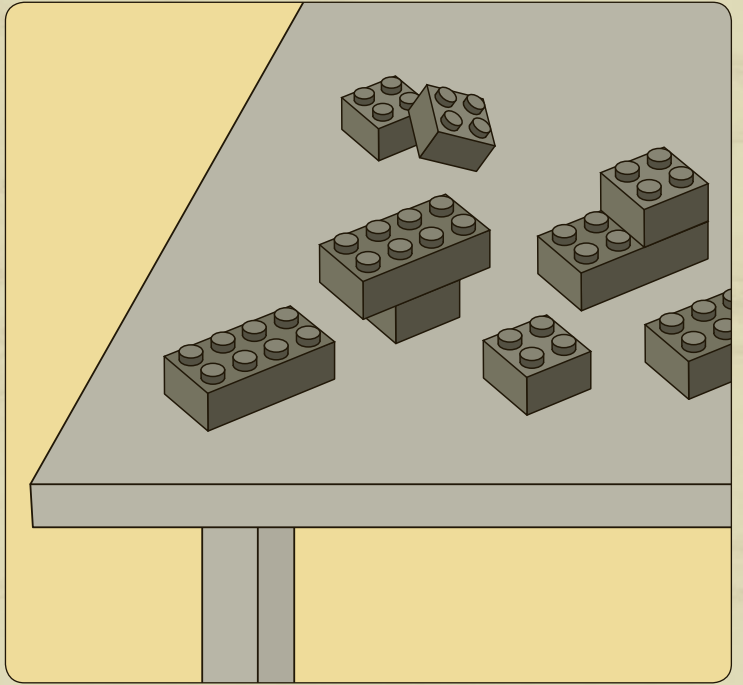
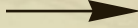
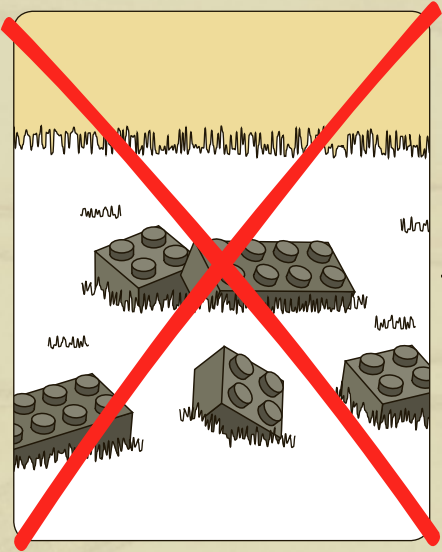

2

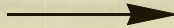



1



3

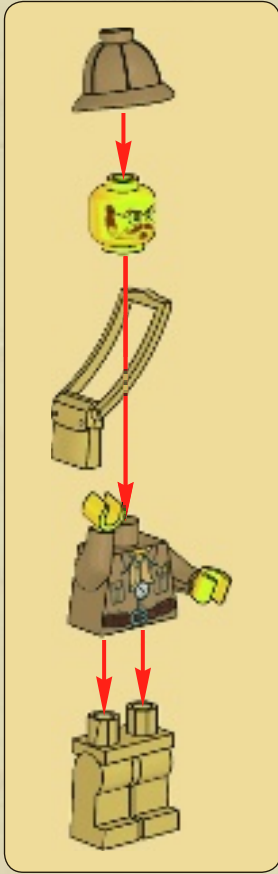

4

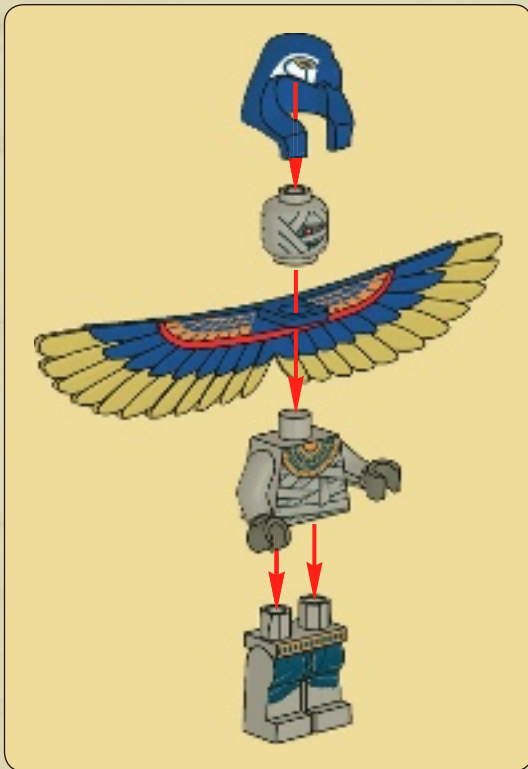

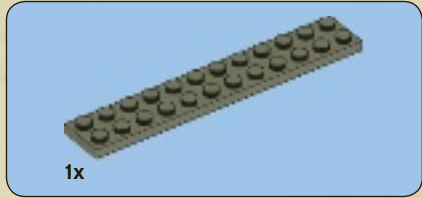

1x

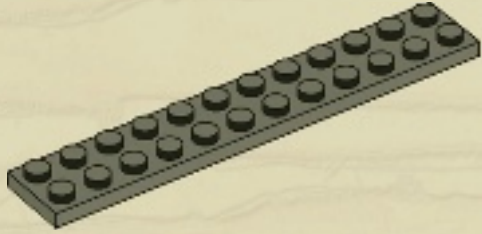

1

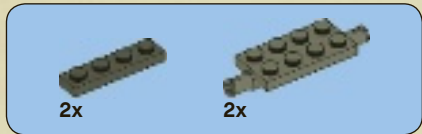

2x

2x

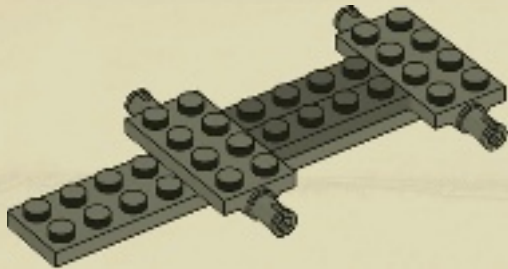

2

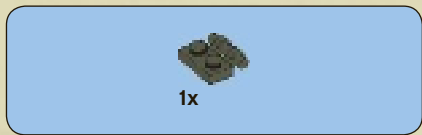

1x

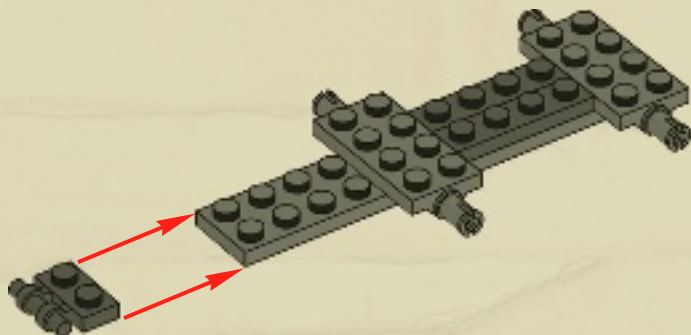

3



4

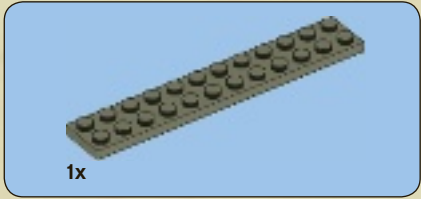
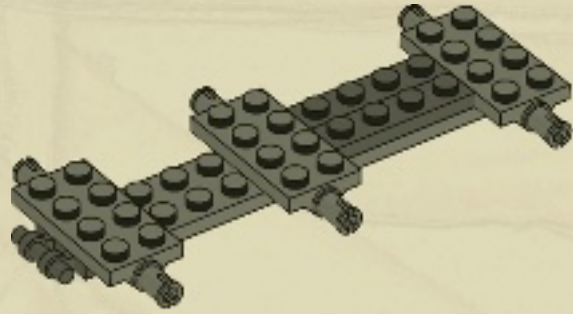

5

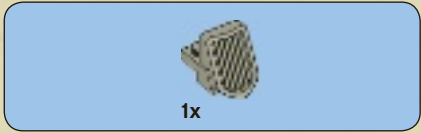
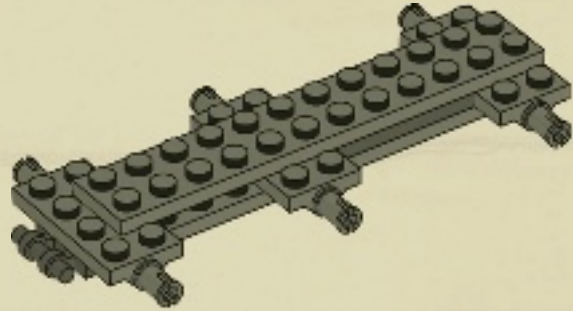

6

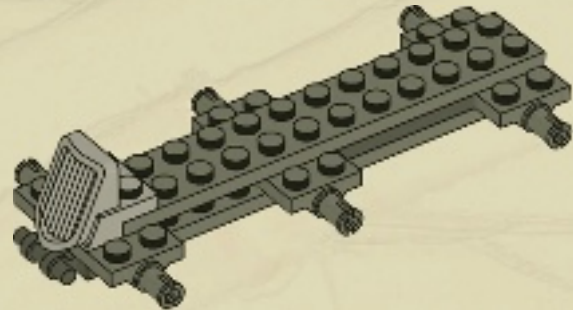



4x

7

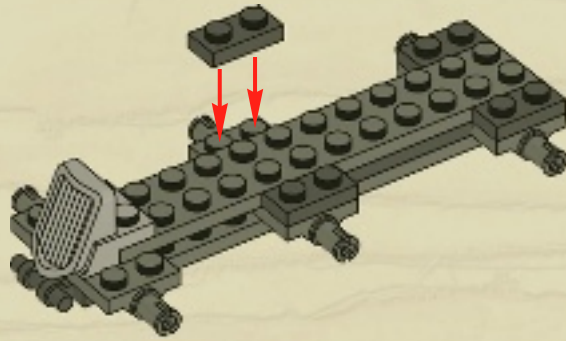

1x



2x



2x

8

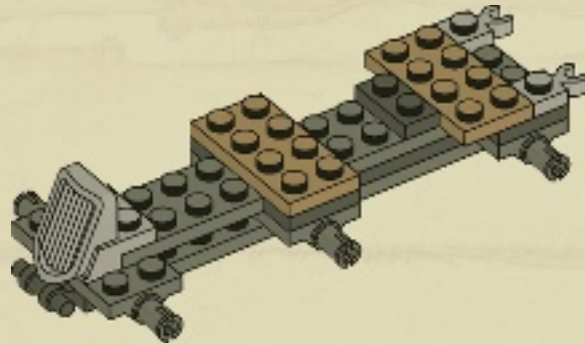

2x



2x

9

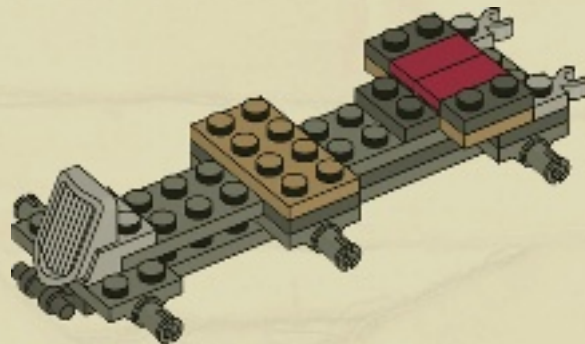



1x



2x

10

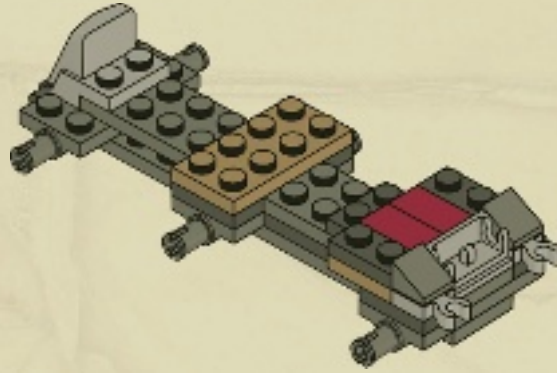

4x

11



2x

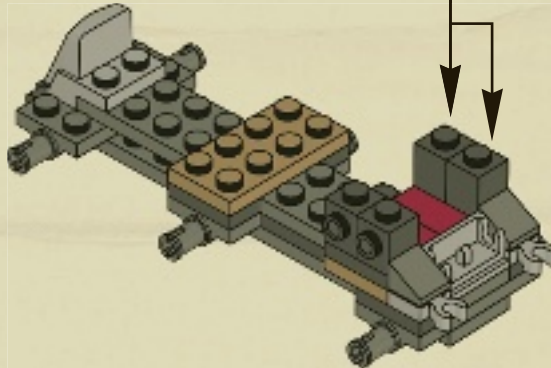

1x

12

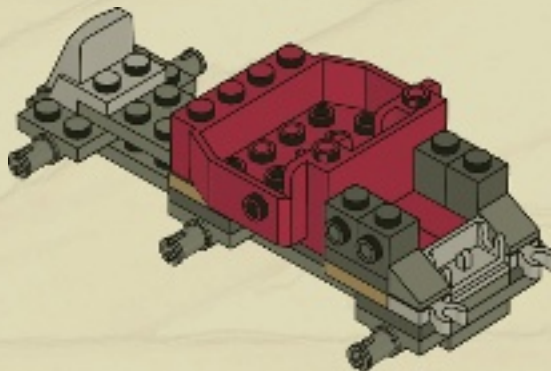



13

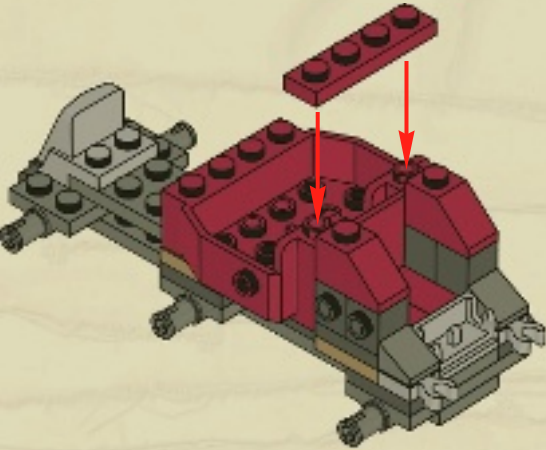

14

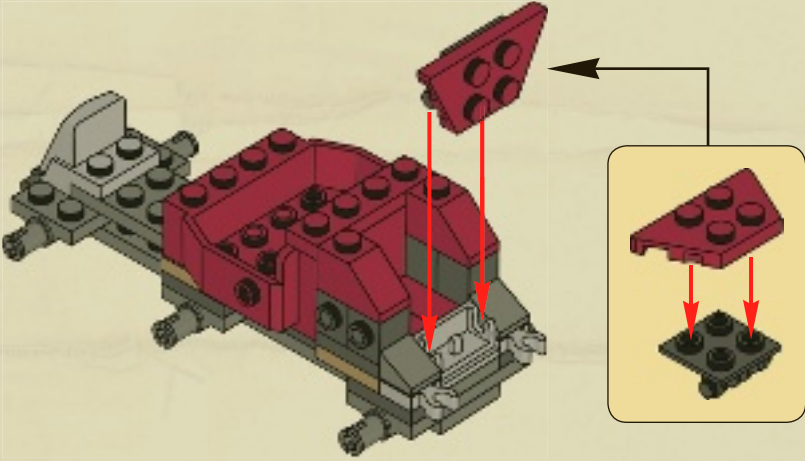

15

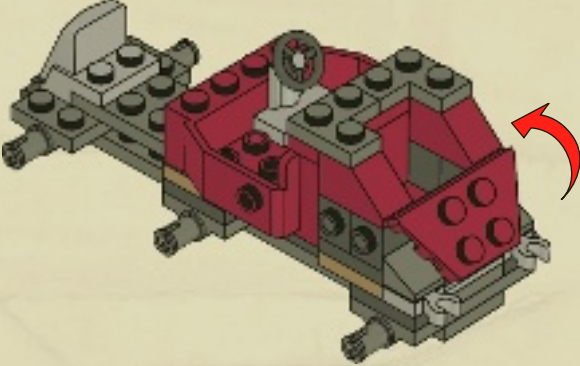



3x

16

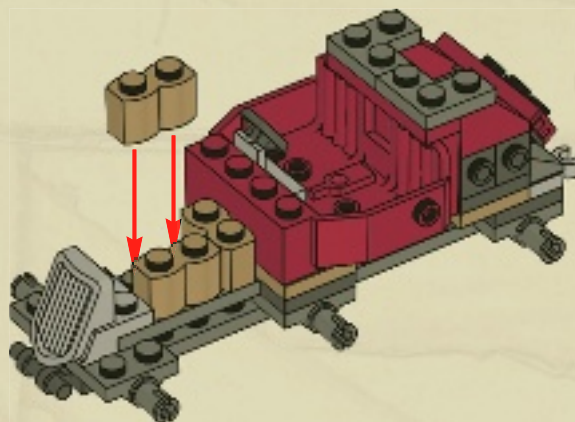

2x

17

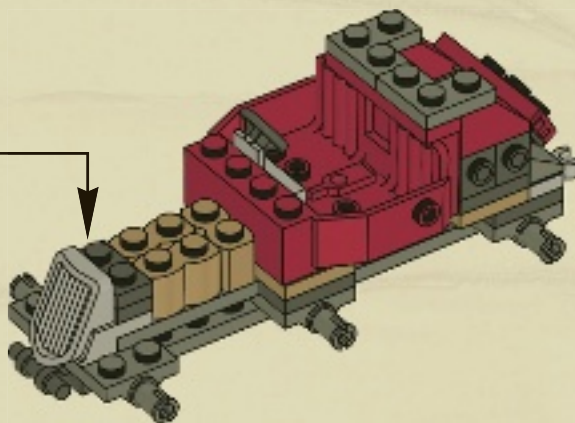
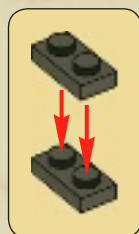

2x



2x

18

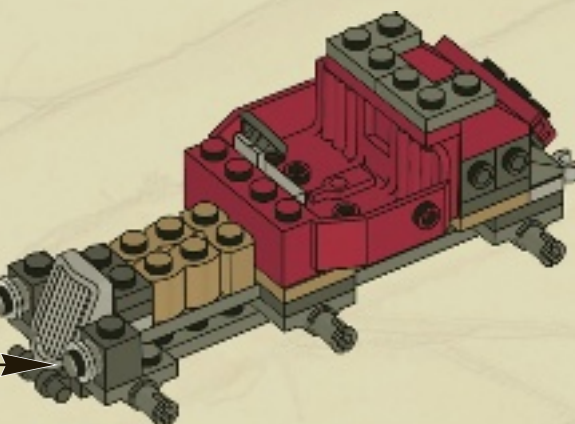
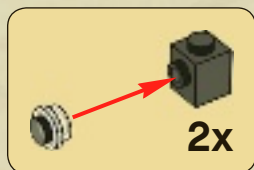

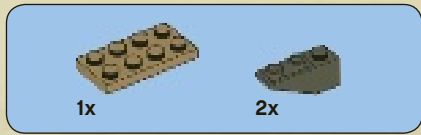

19

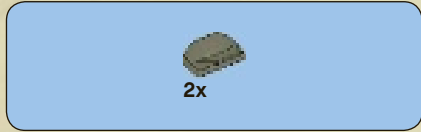
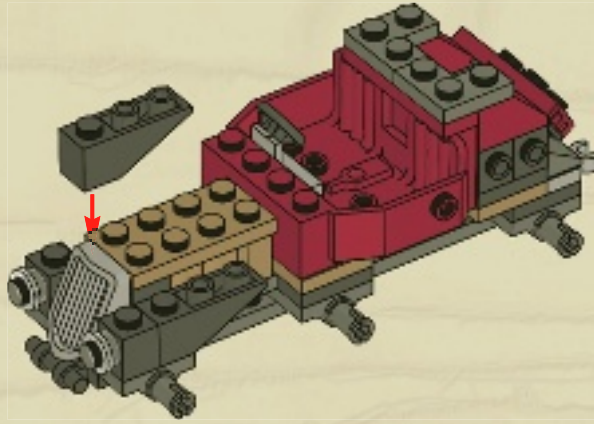

20

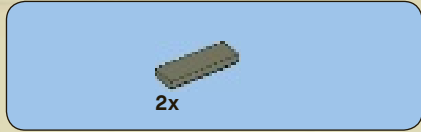
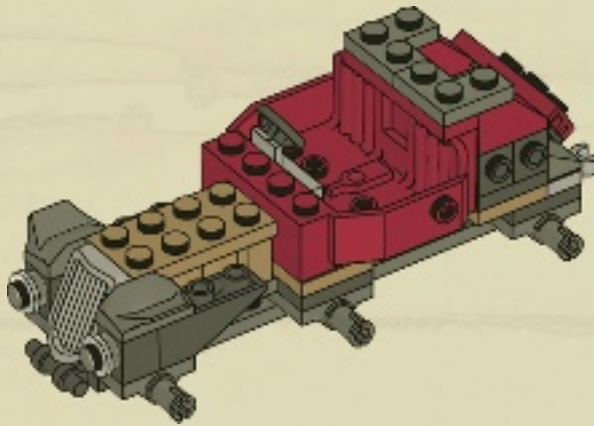

21

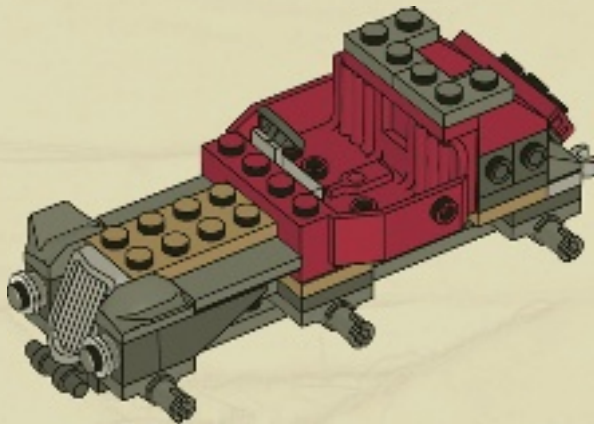



2x



1x

22

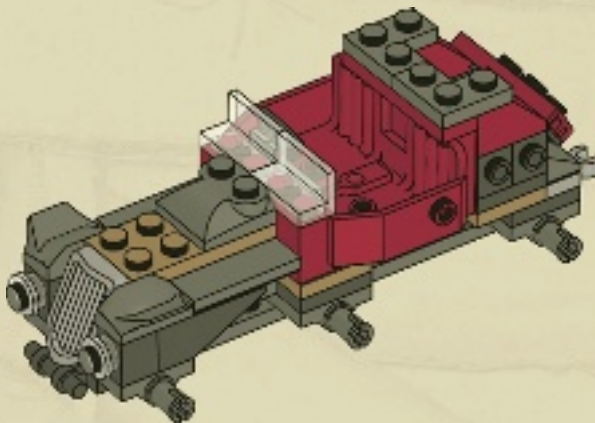

1x

23

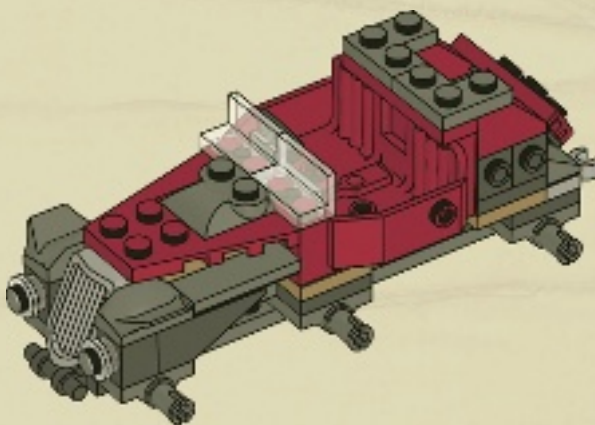

4x



2x



2x

24

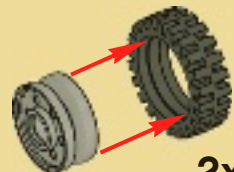
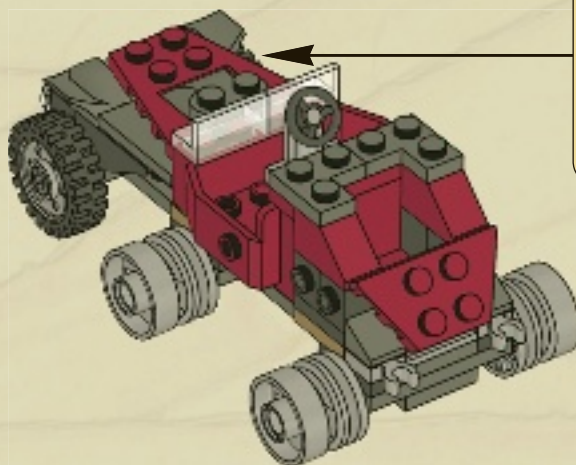

2x

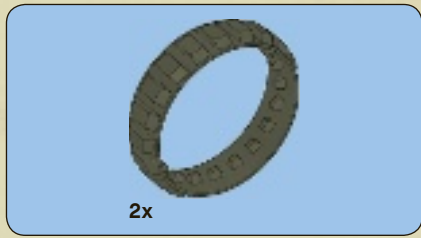

25

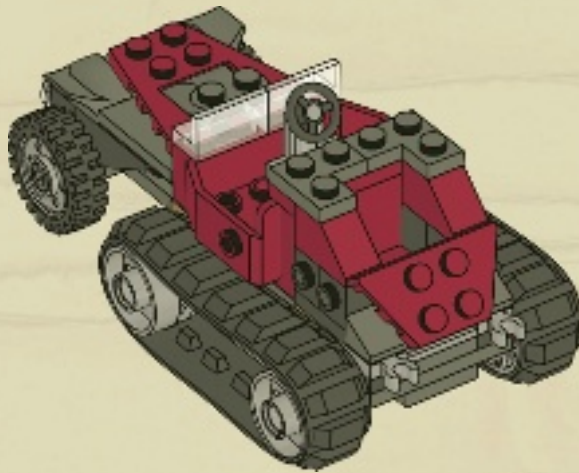

26

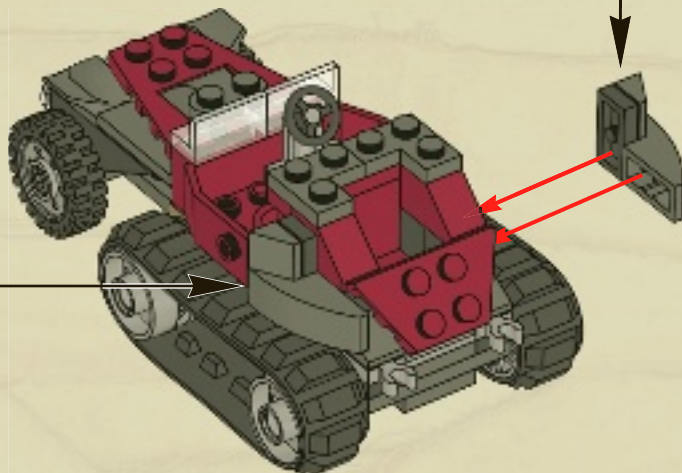
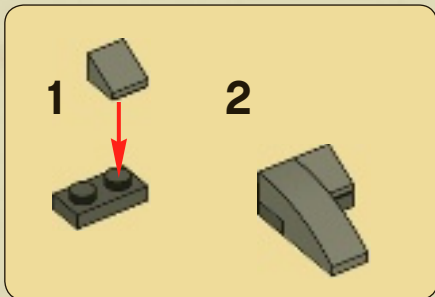
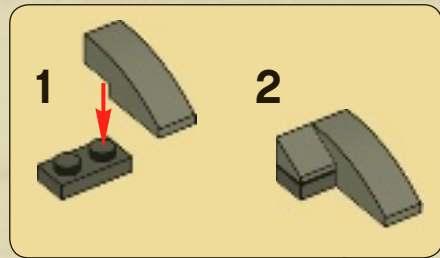



27

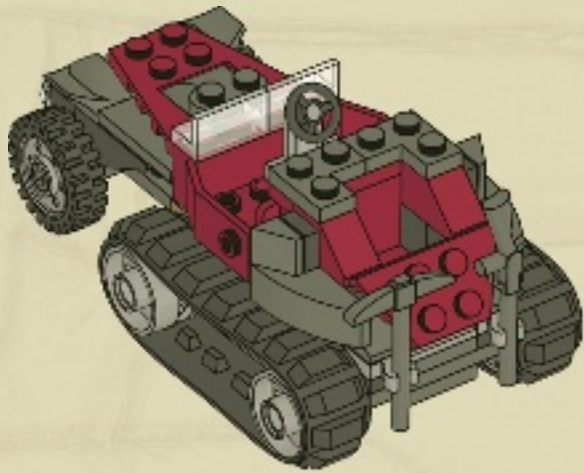

28

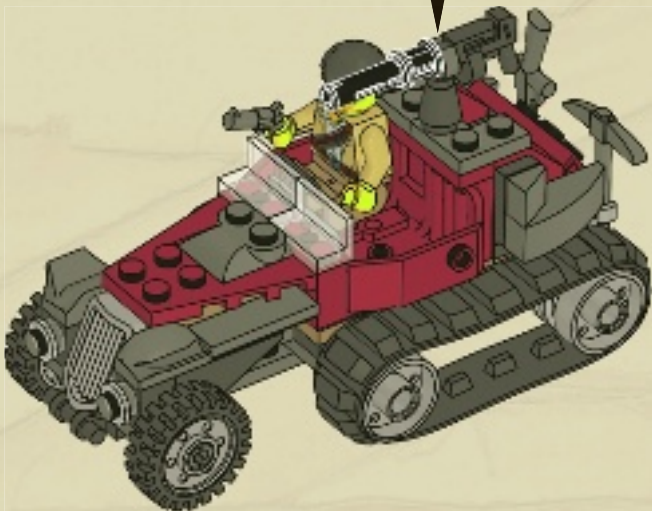

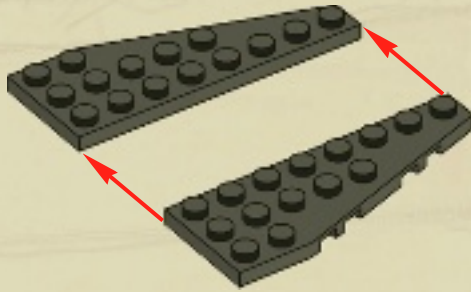
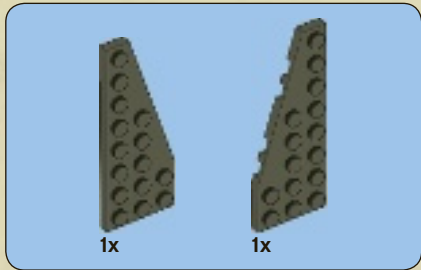
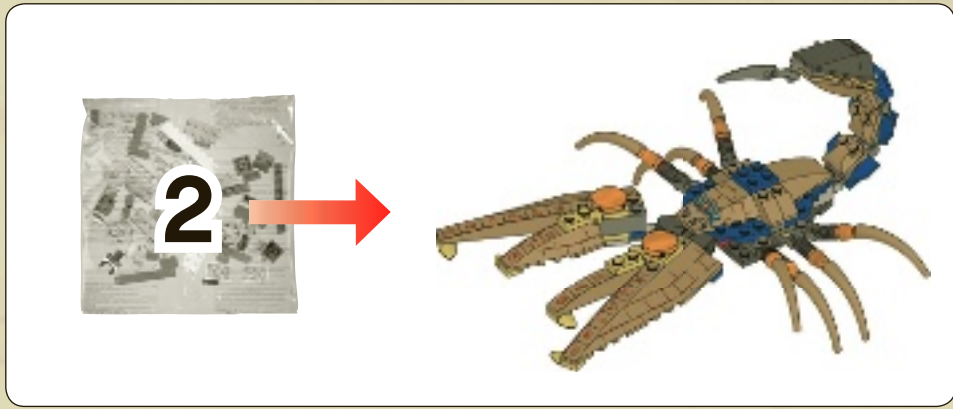

1

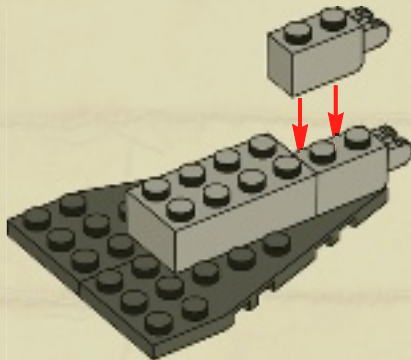

2

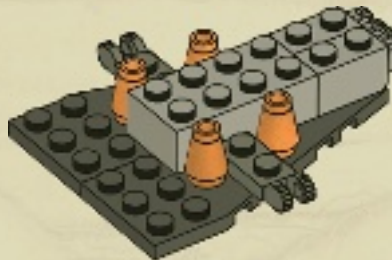
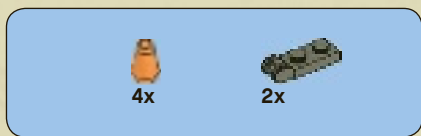

3



4

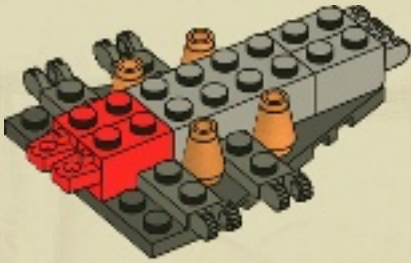

5

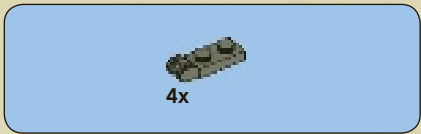
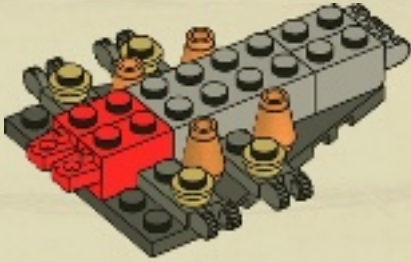

6

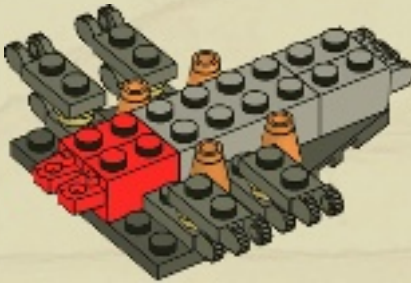



7

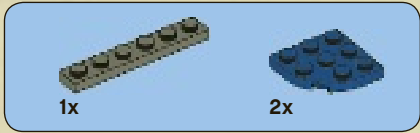
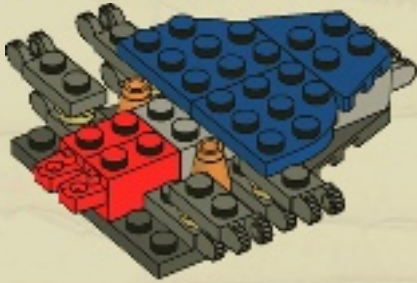

8

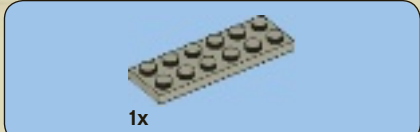
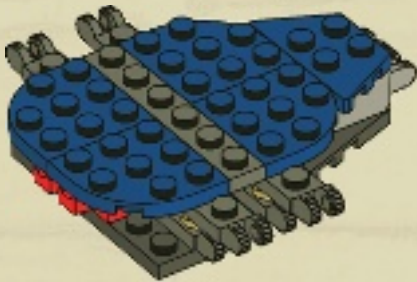

9

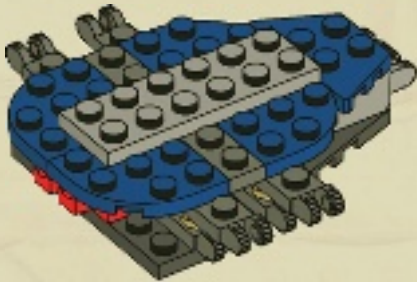



10

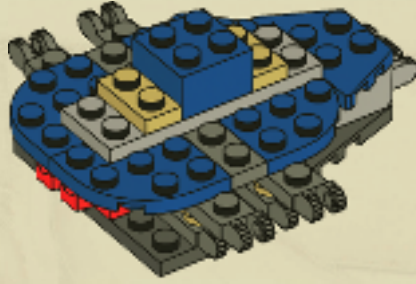

11

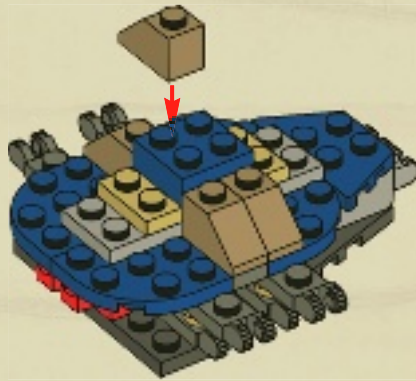

12

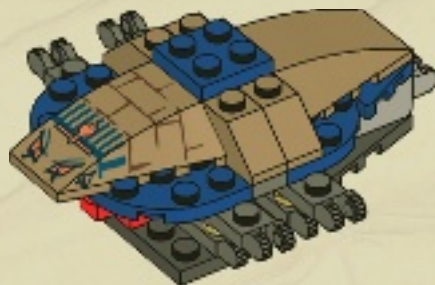

13

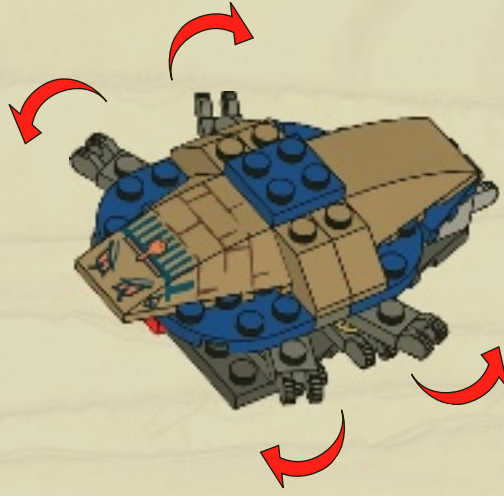

14

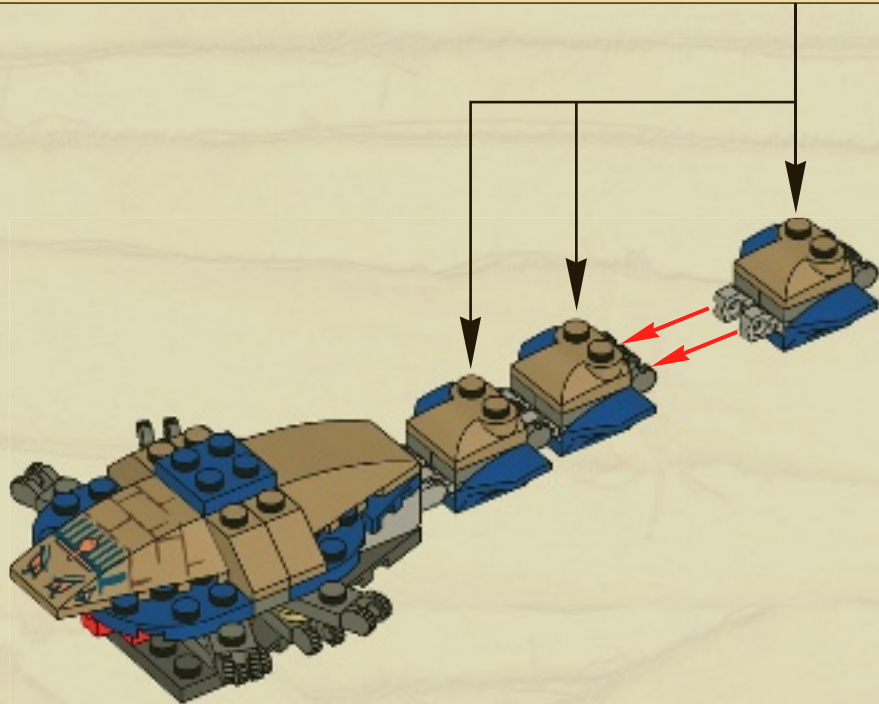
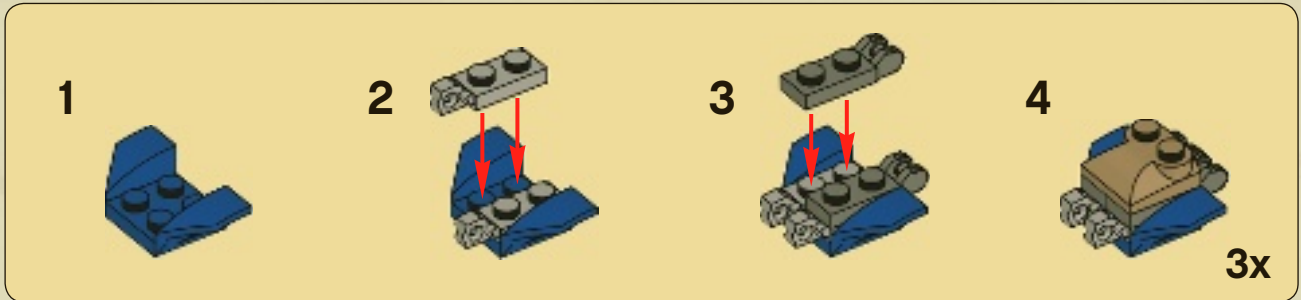

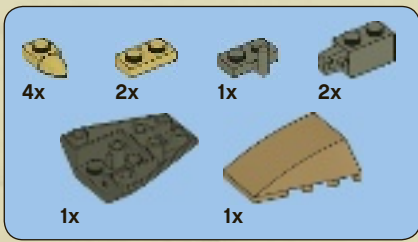

15

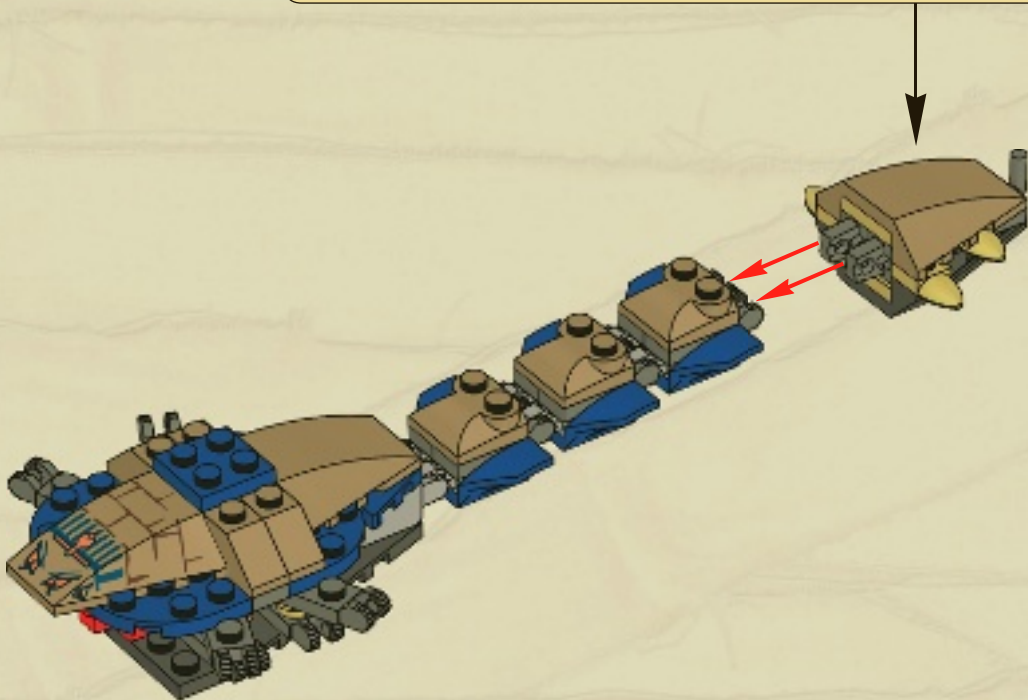
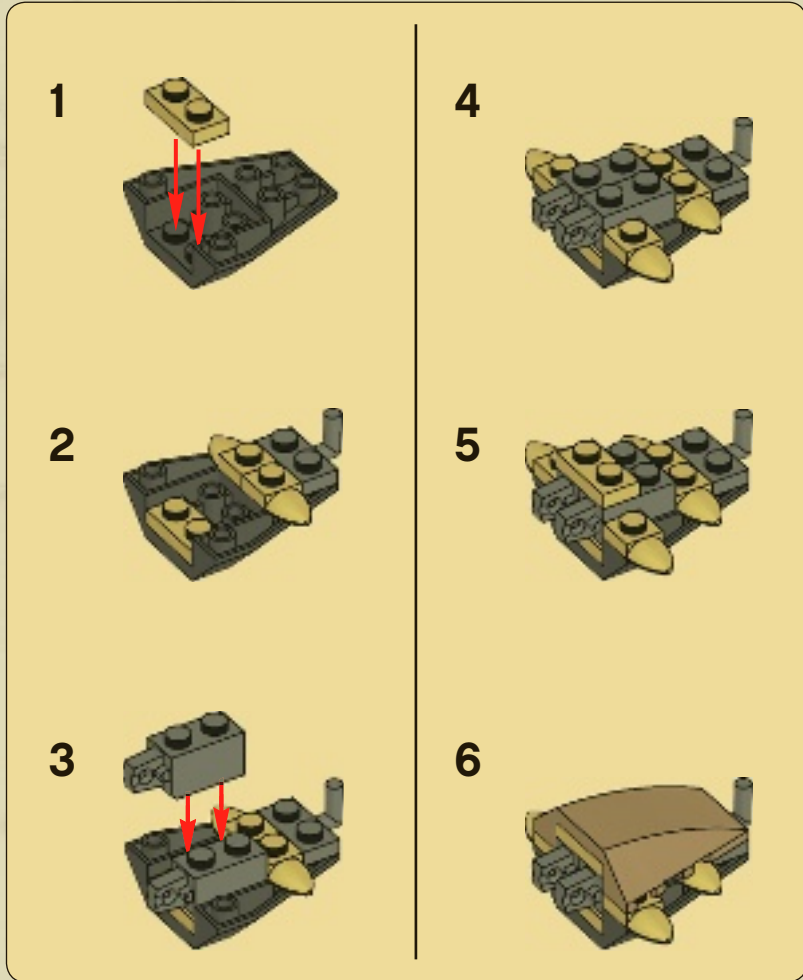



16

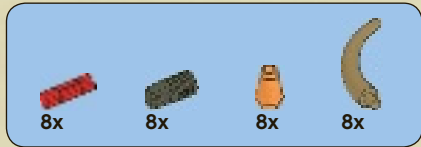
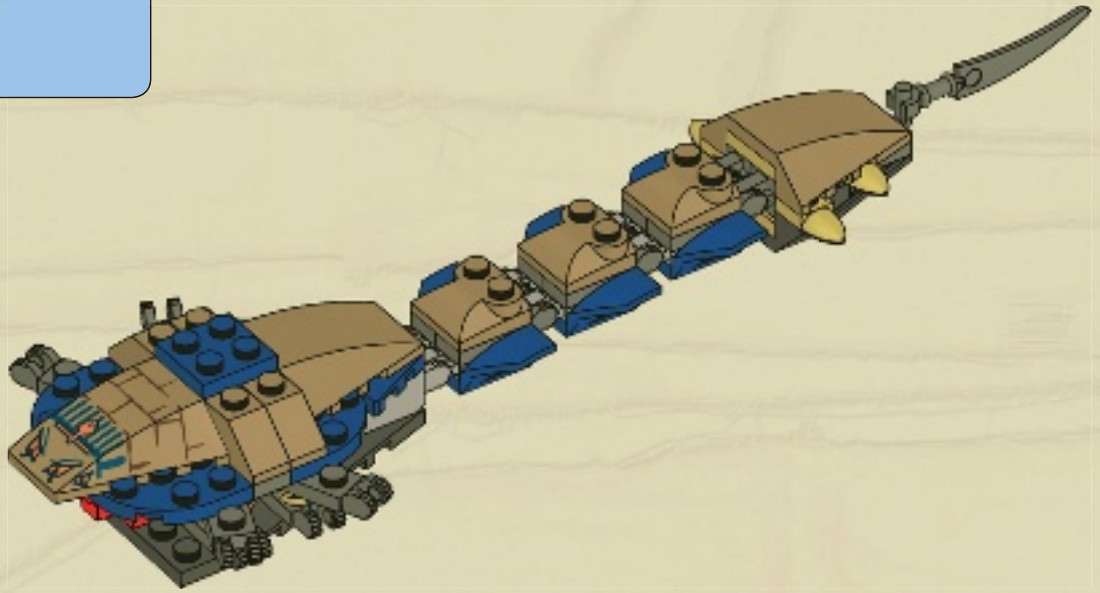

17

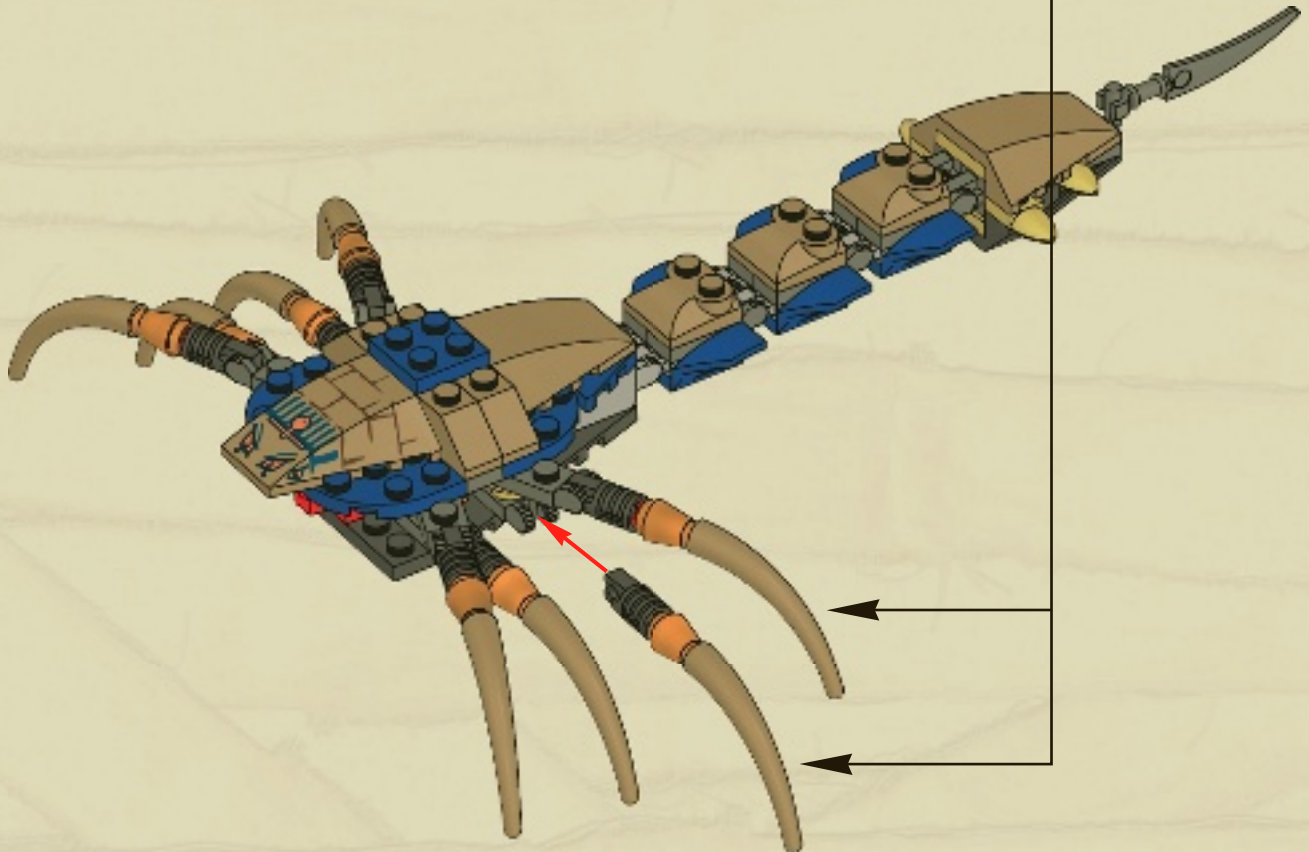



18

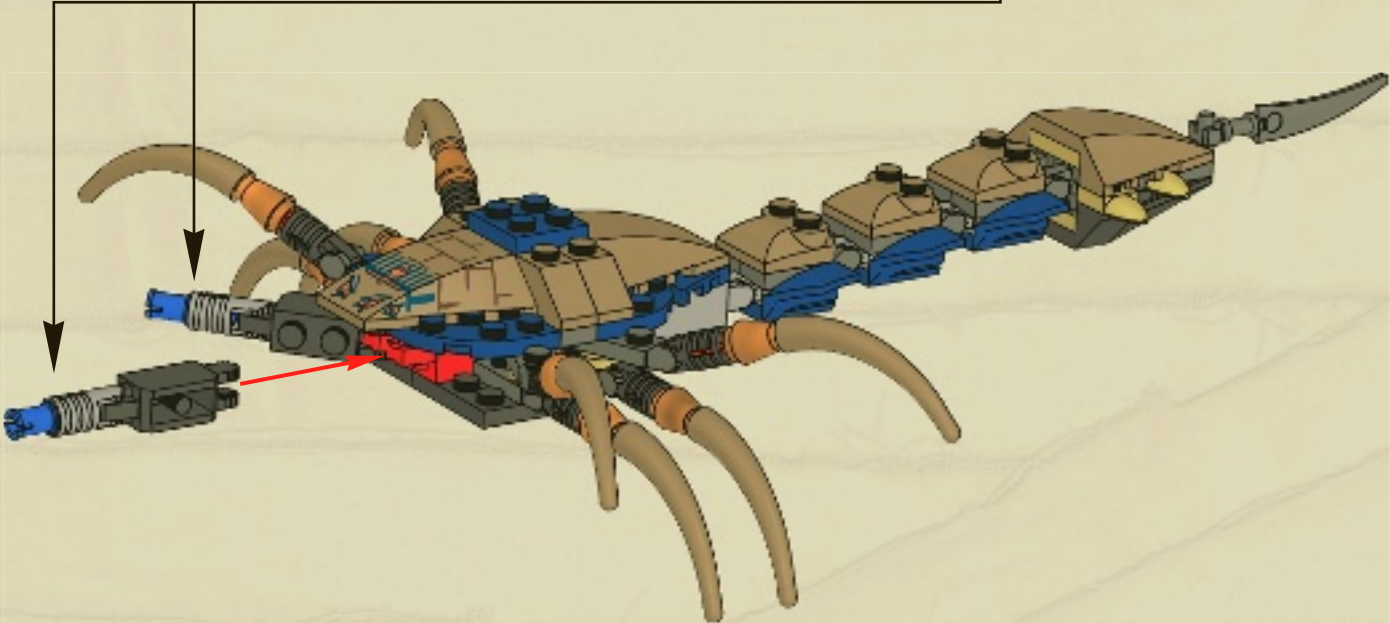

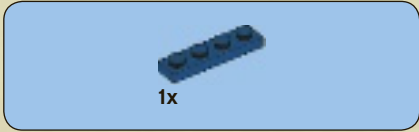
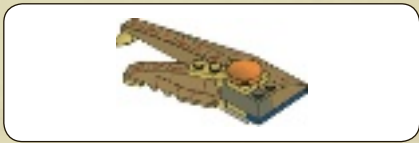

1

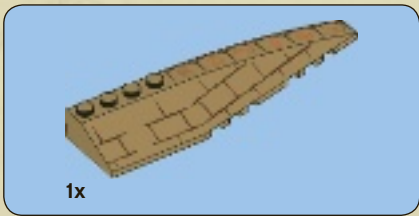

2

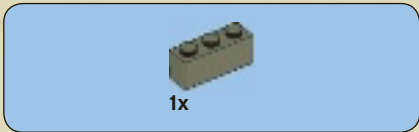
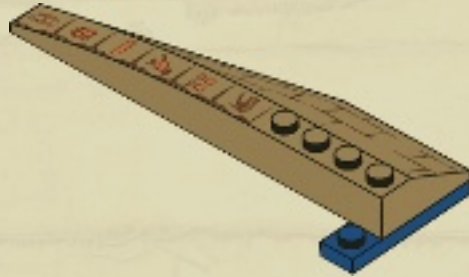

3

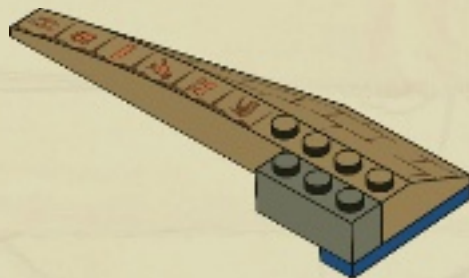

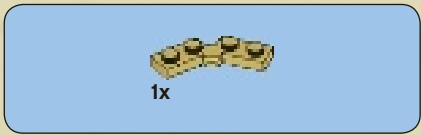

4

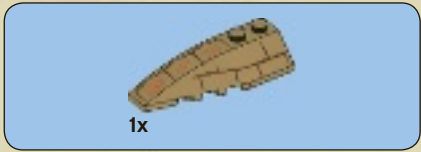
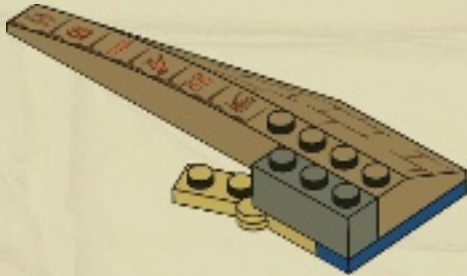

5

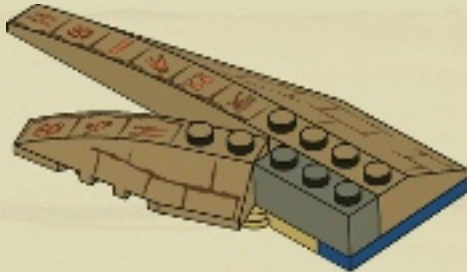

6

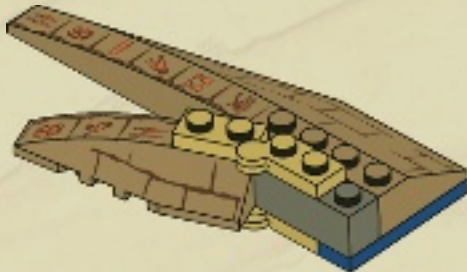



1x

7

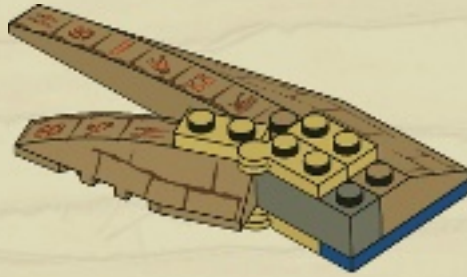

1x

8

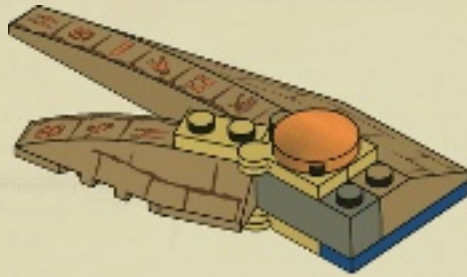

3x



1x

9

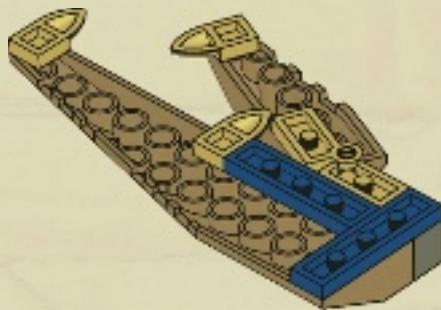
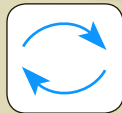



10

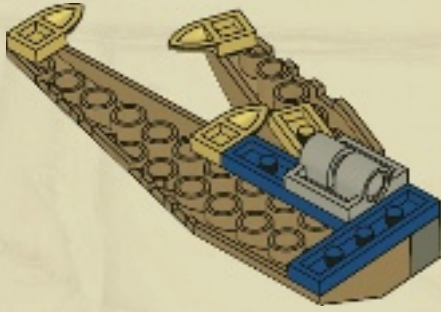

11

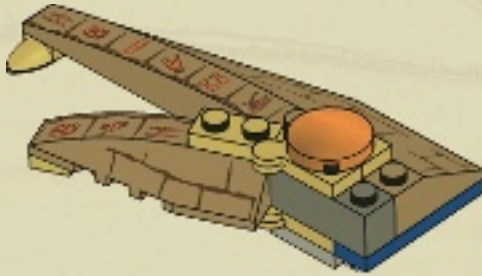

19

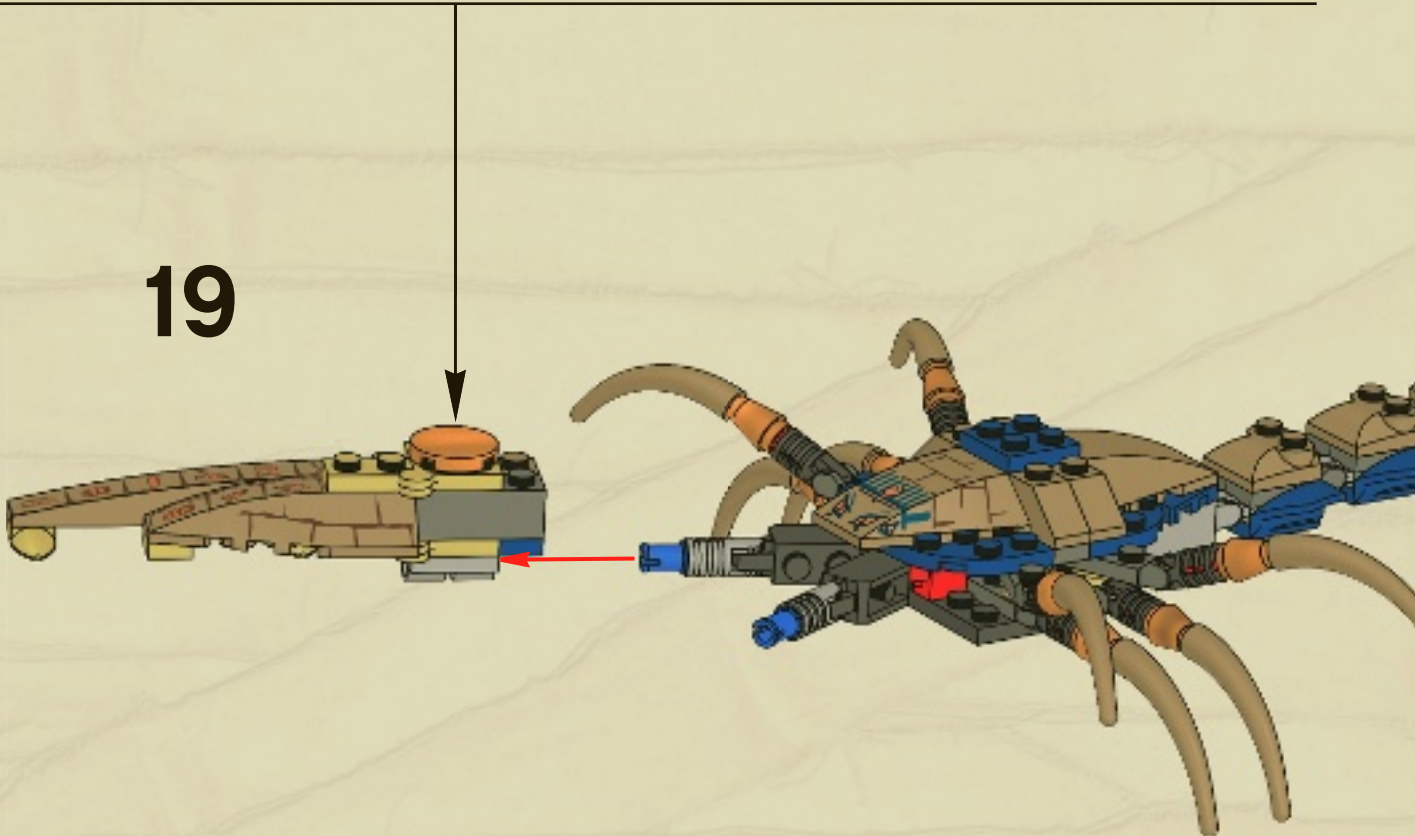

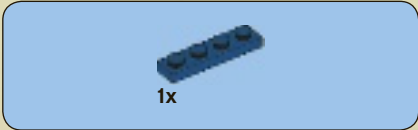

1

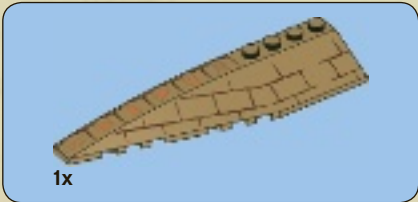

2

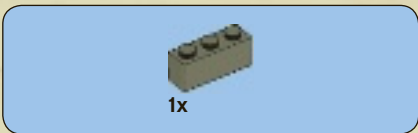
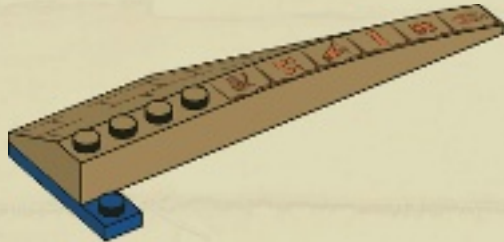

3

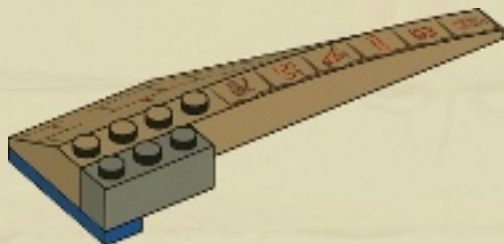

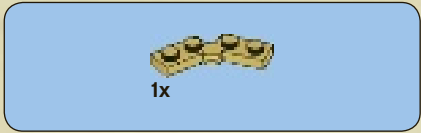

4

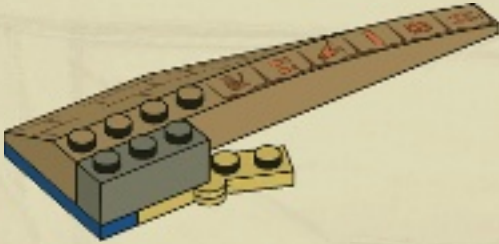

5

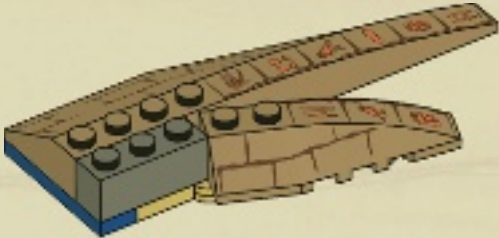

6

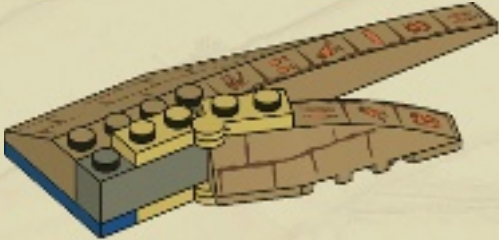



1x

7

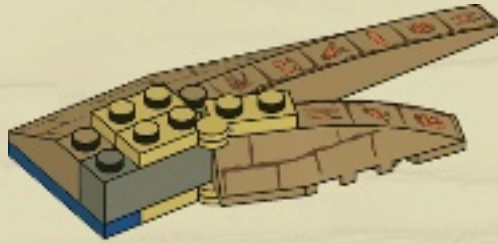

1x

8

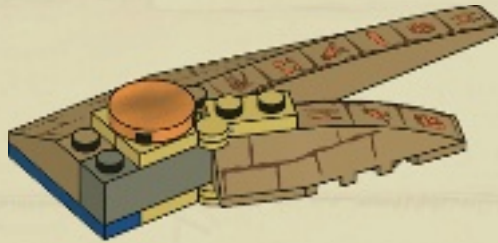

3x



1x

9

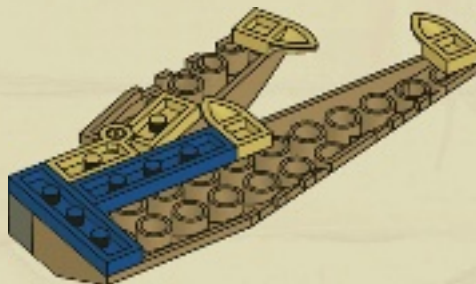



10

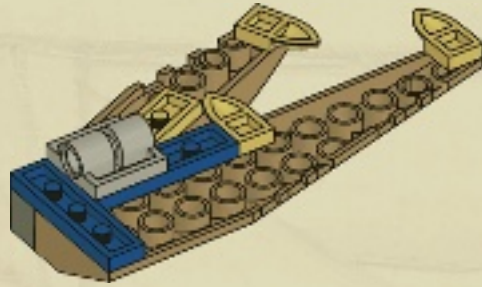

11

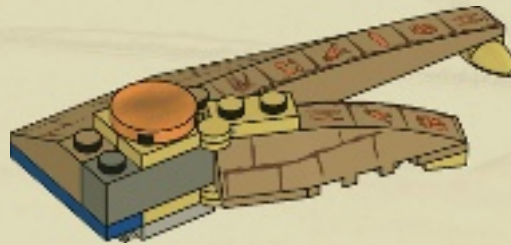

20

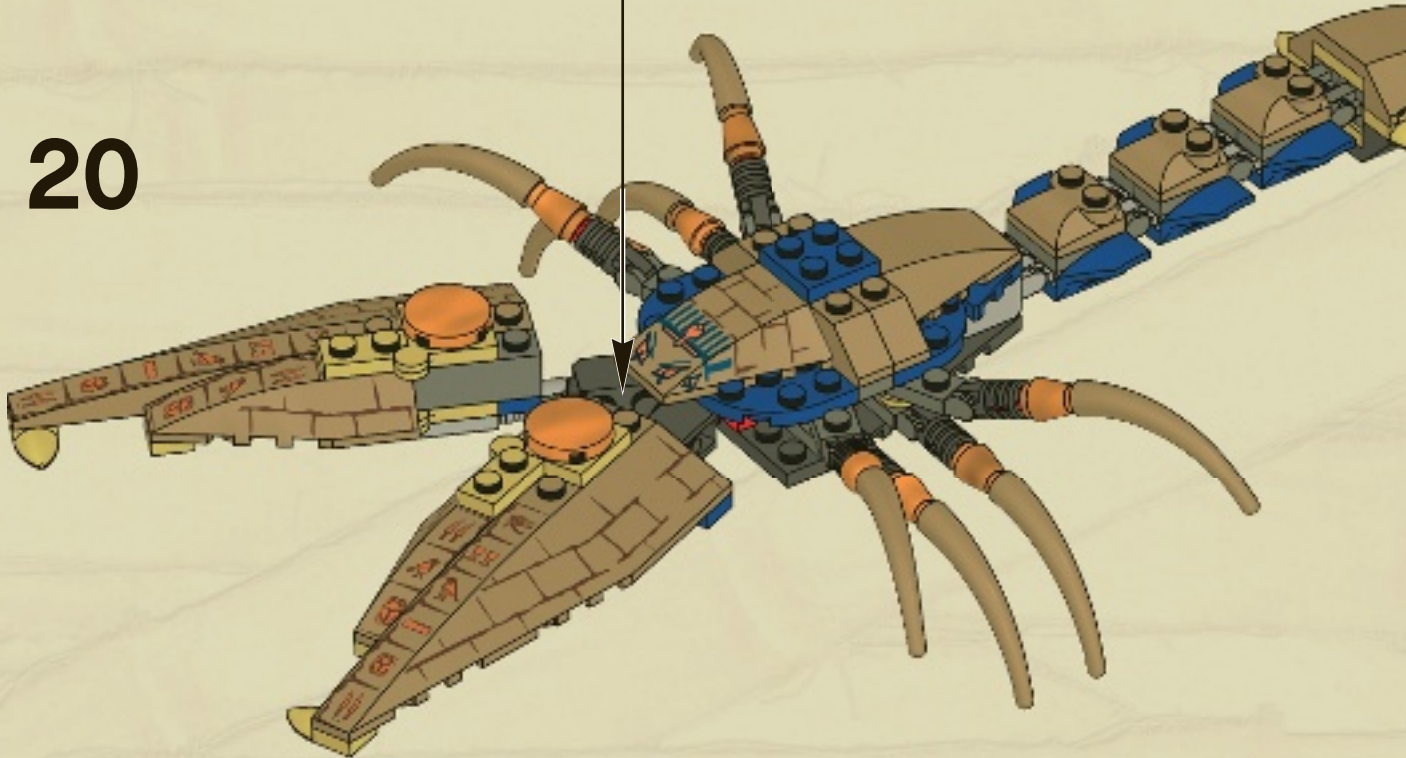

21

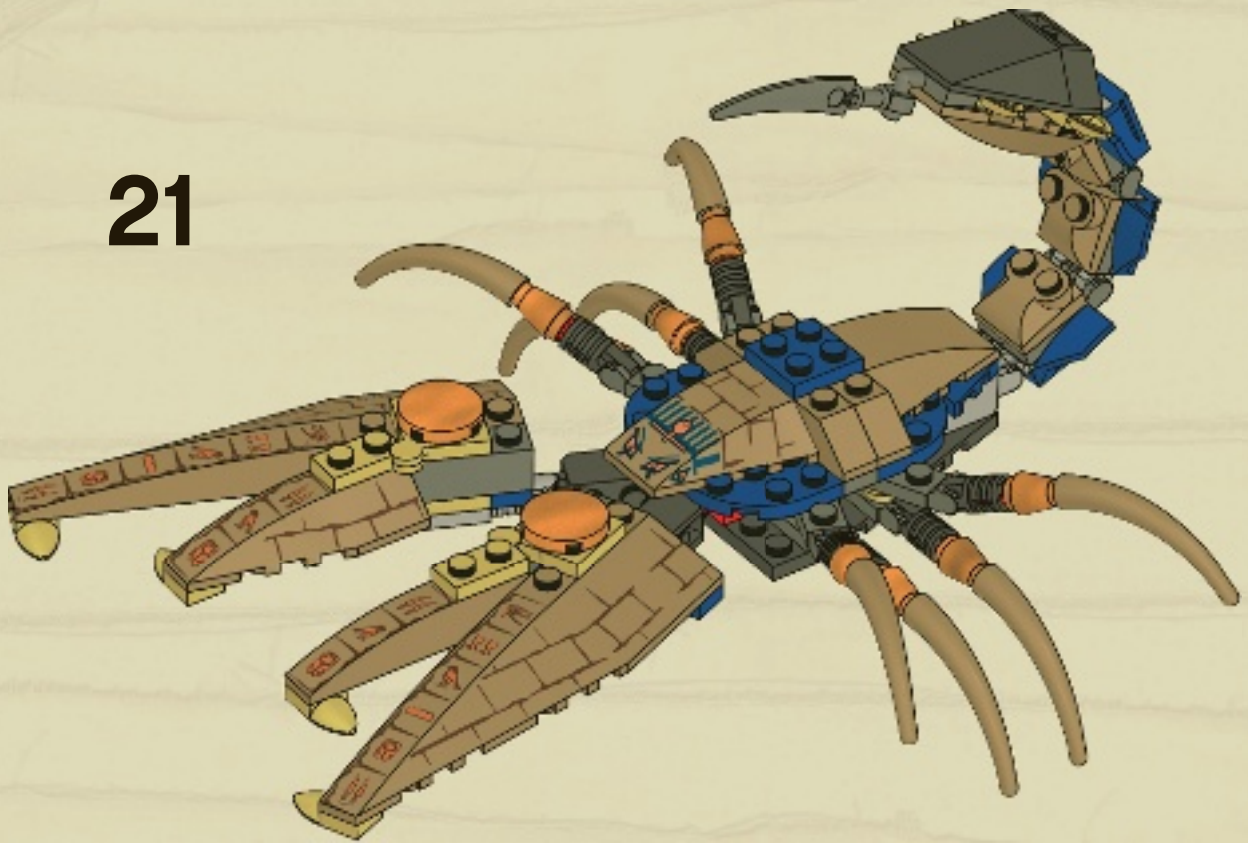

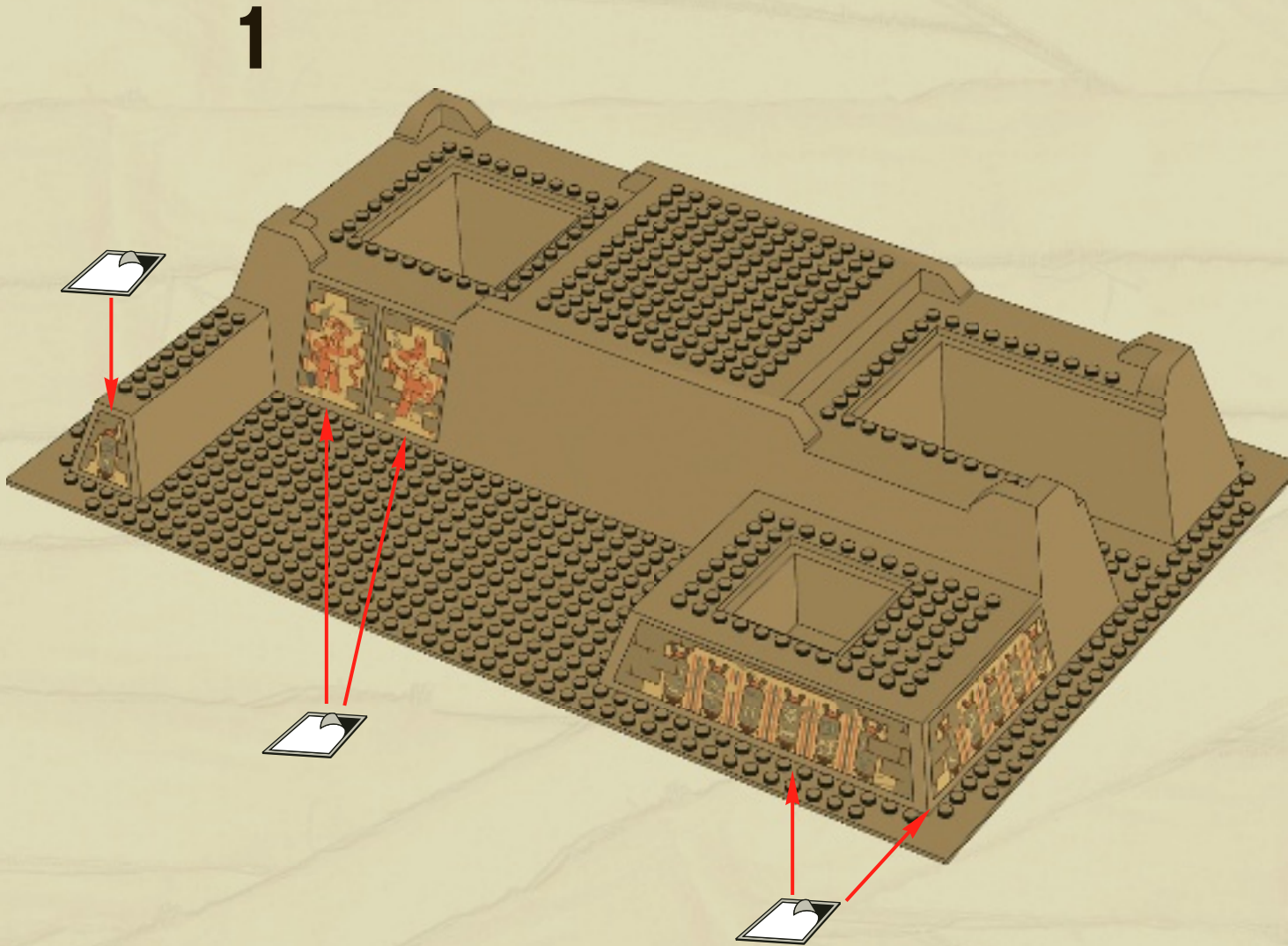
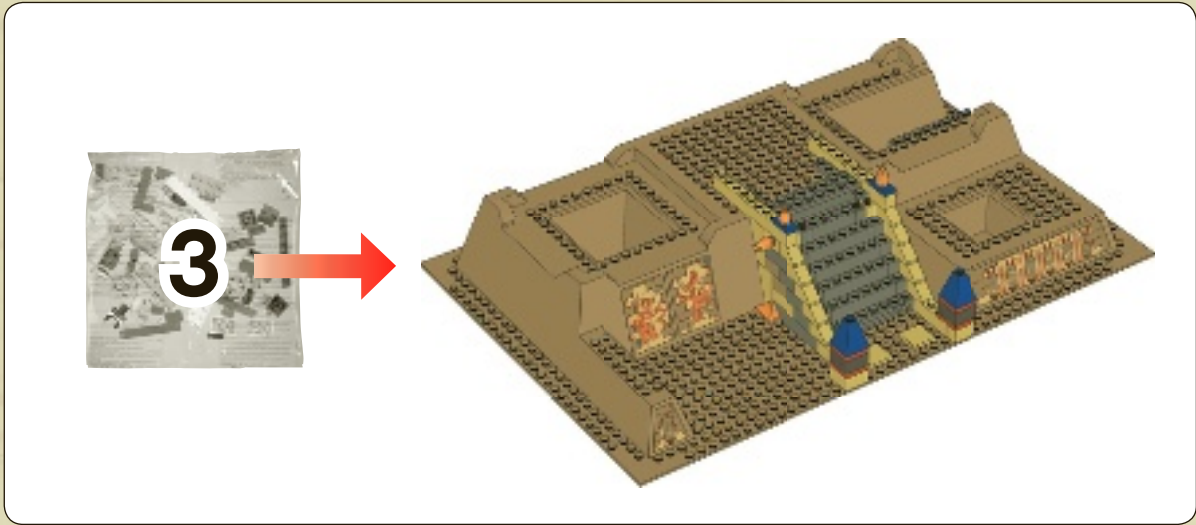

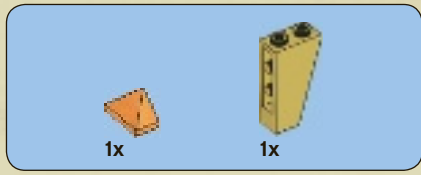

2

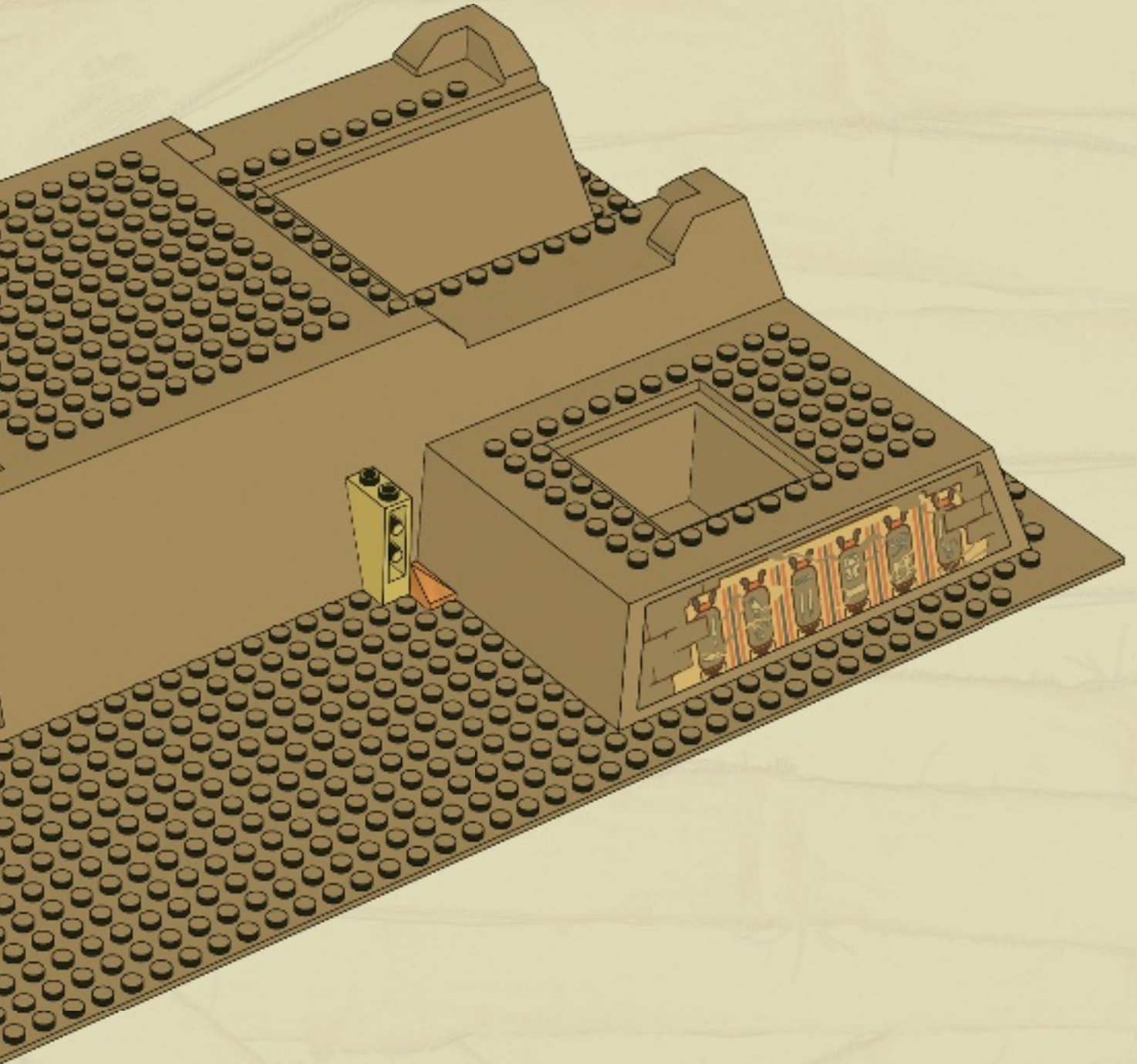

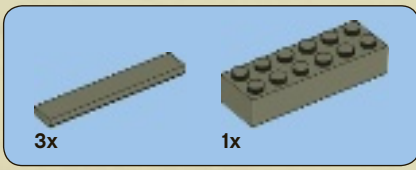

3

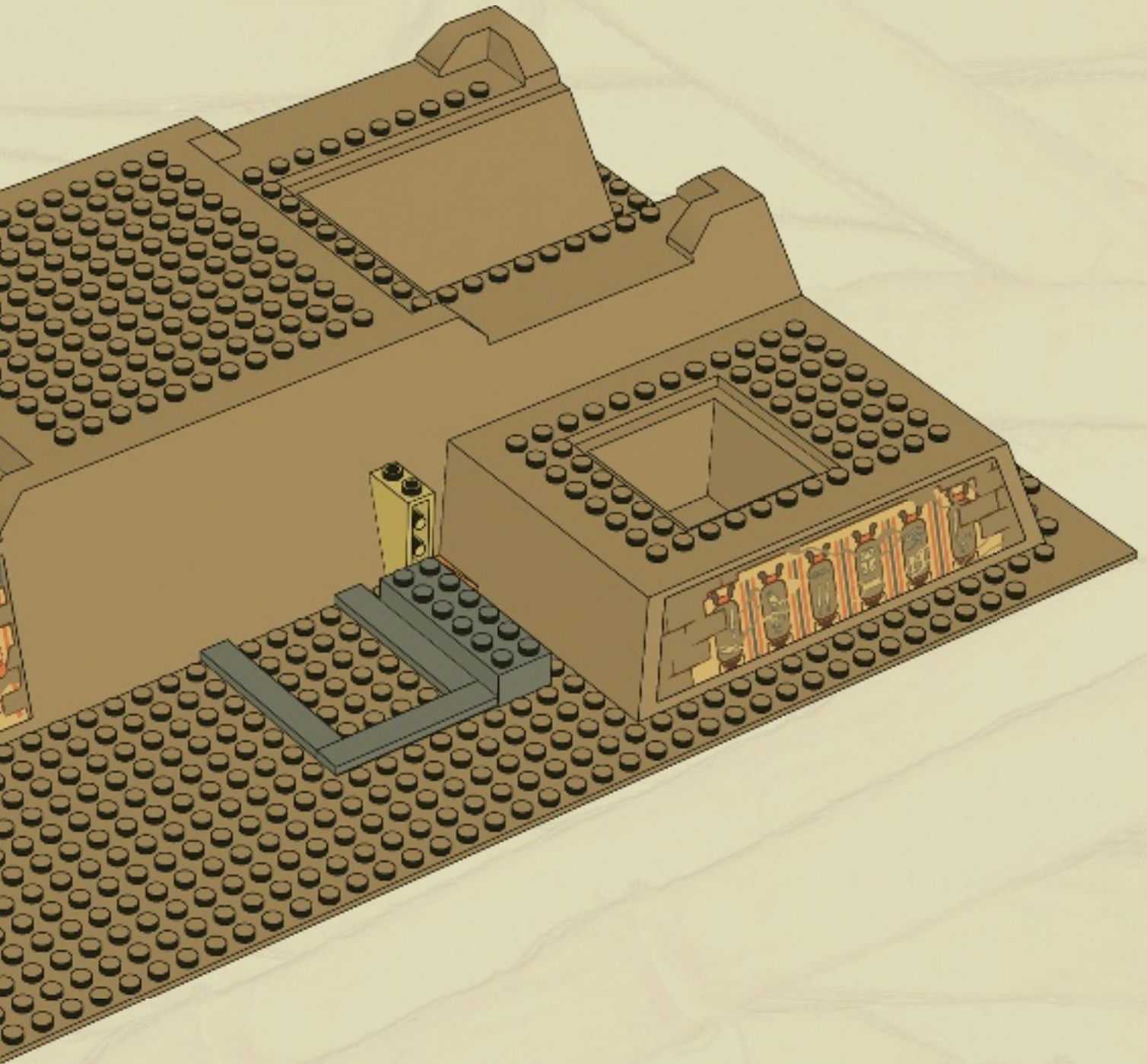

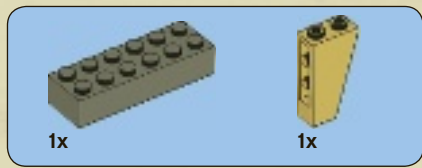

4

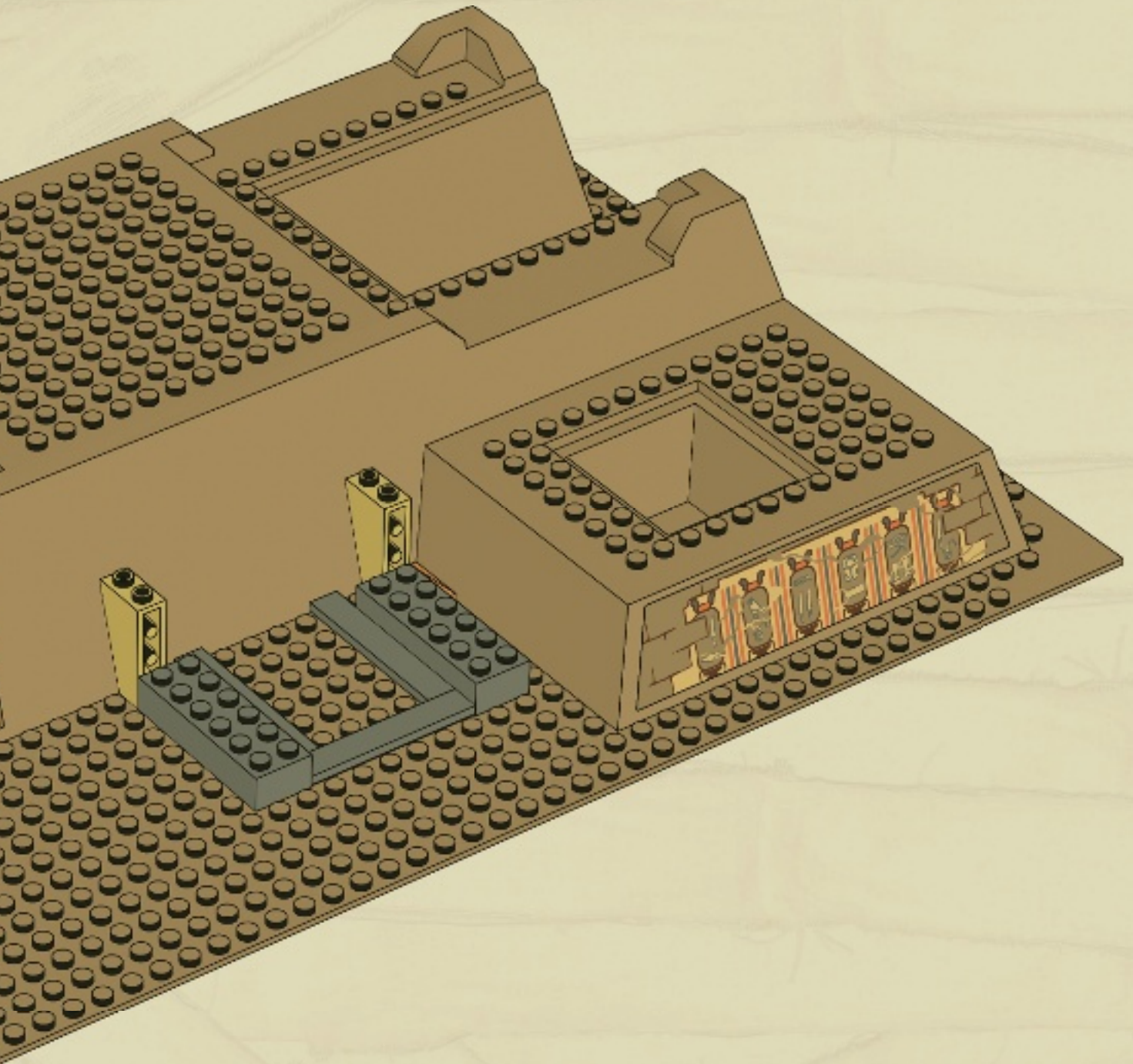

1x



5

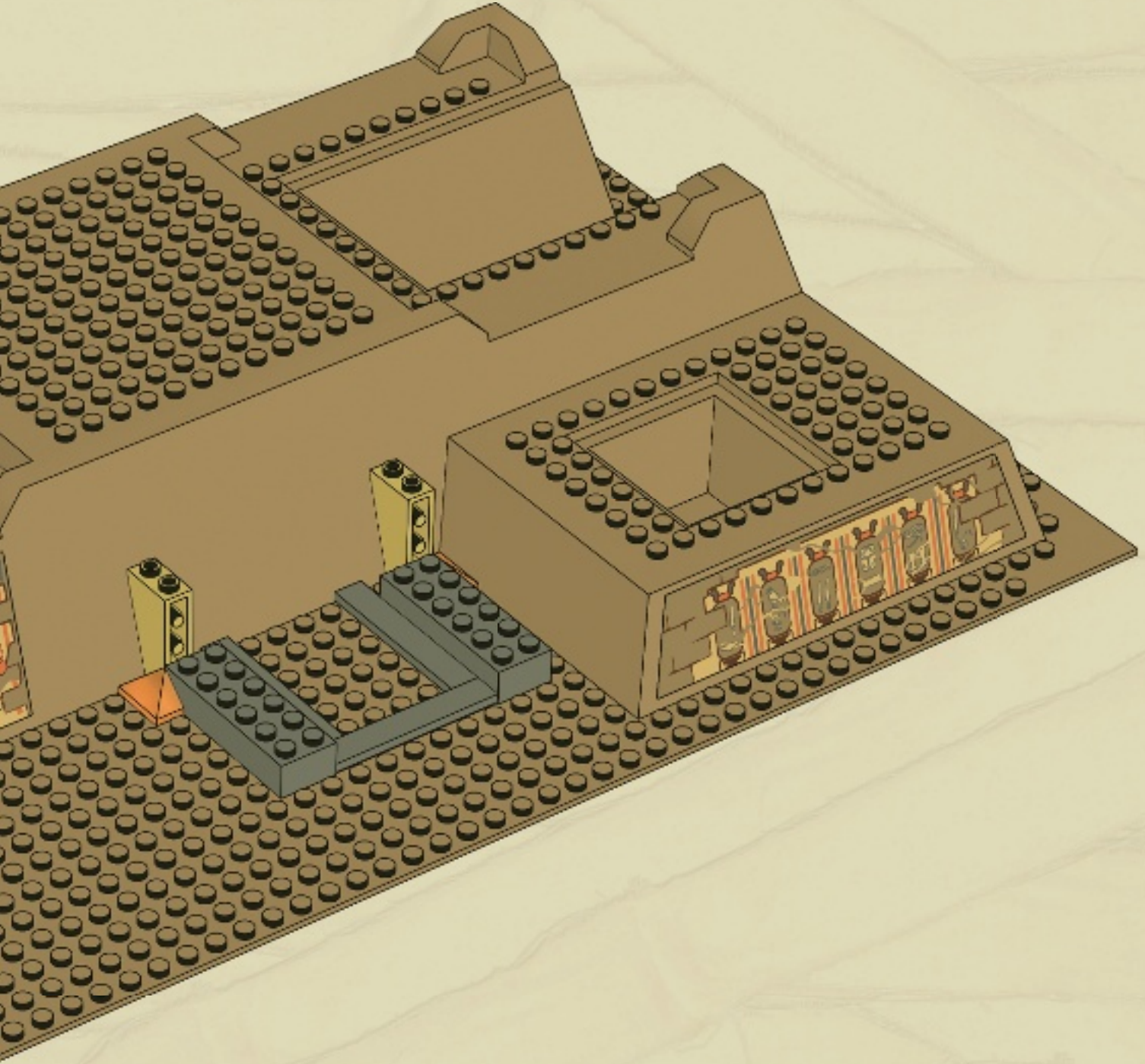



6

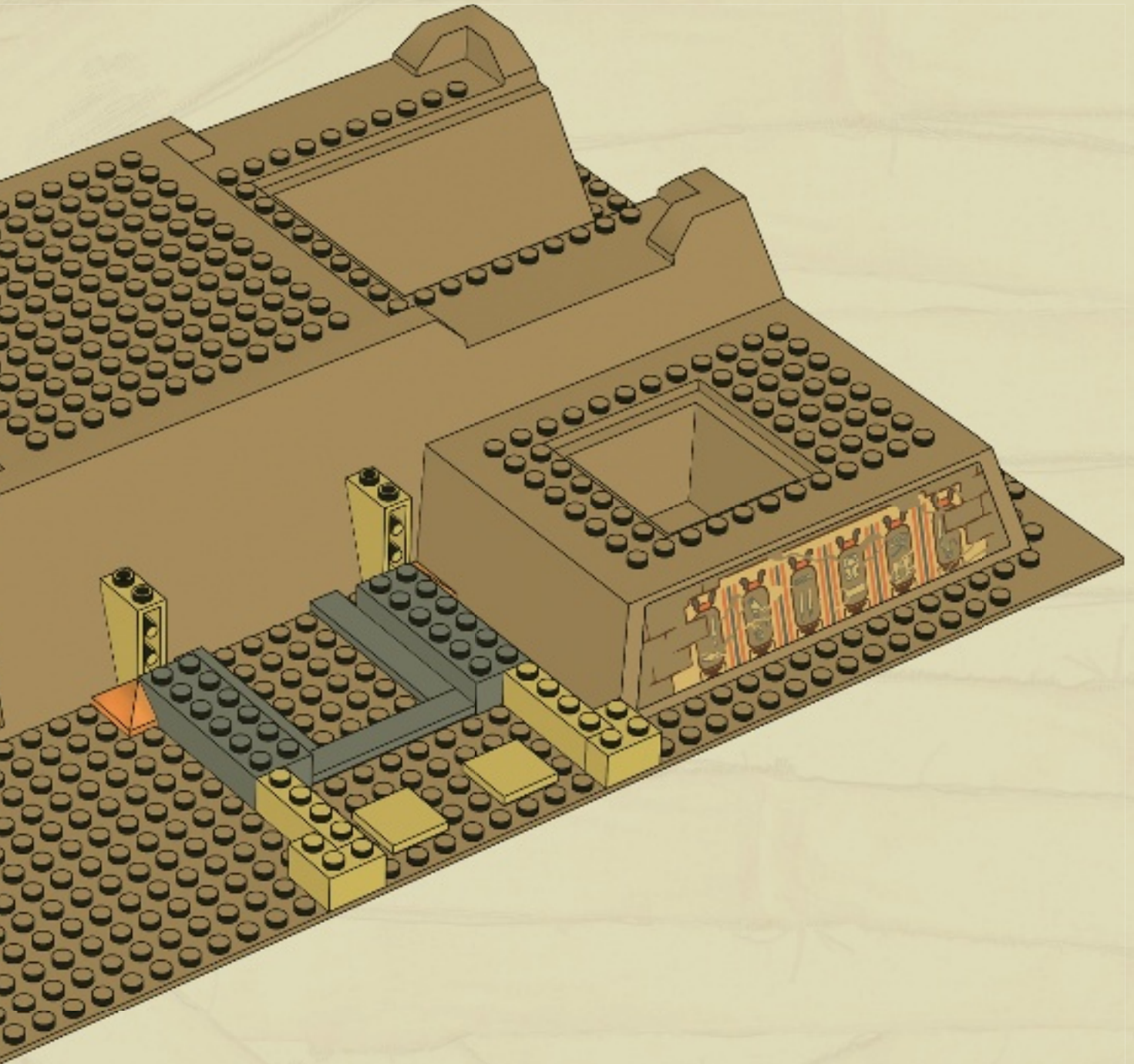

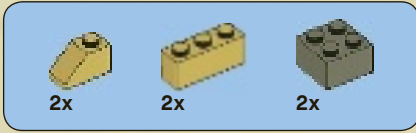

7

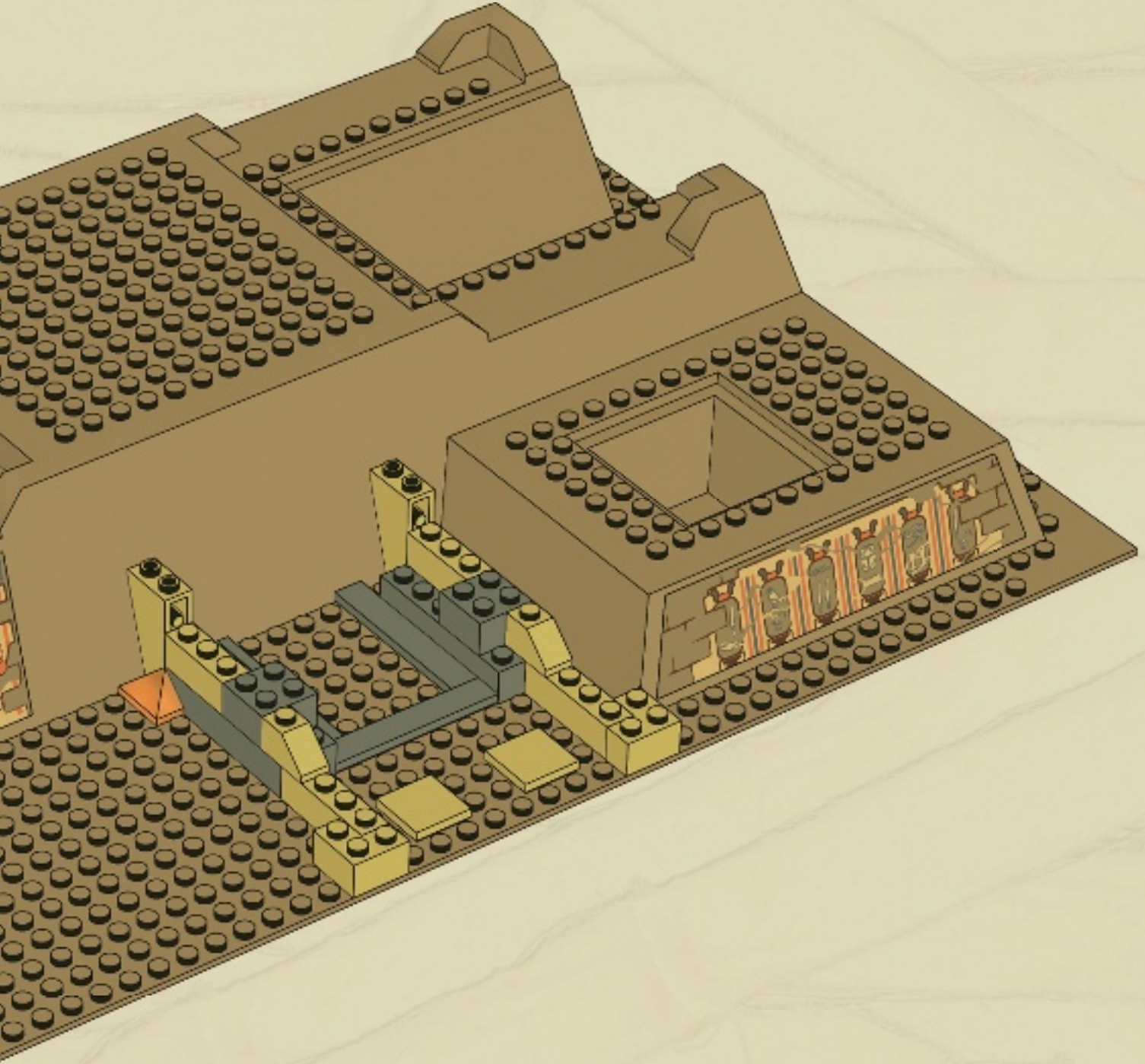

2x 2x 2x

8

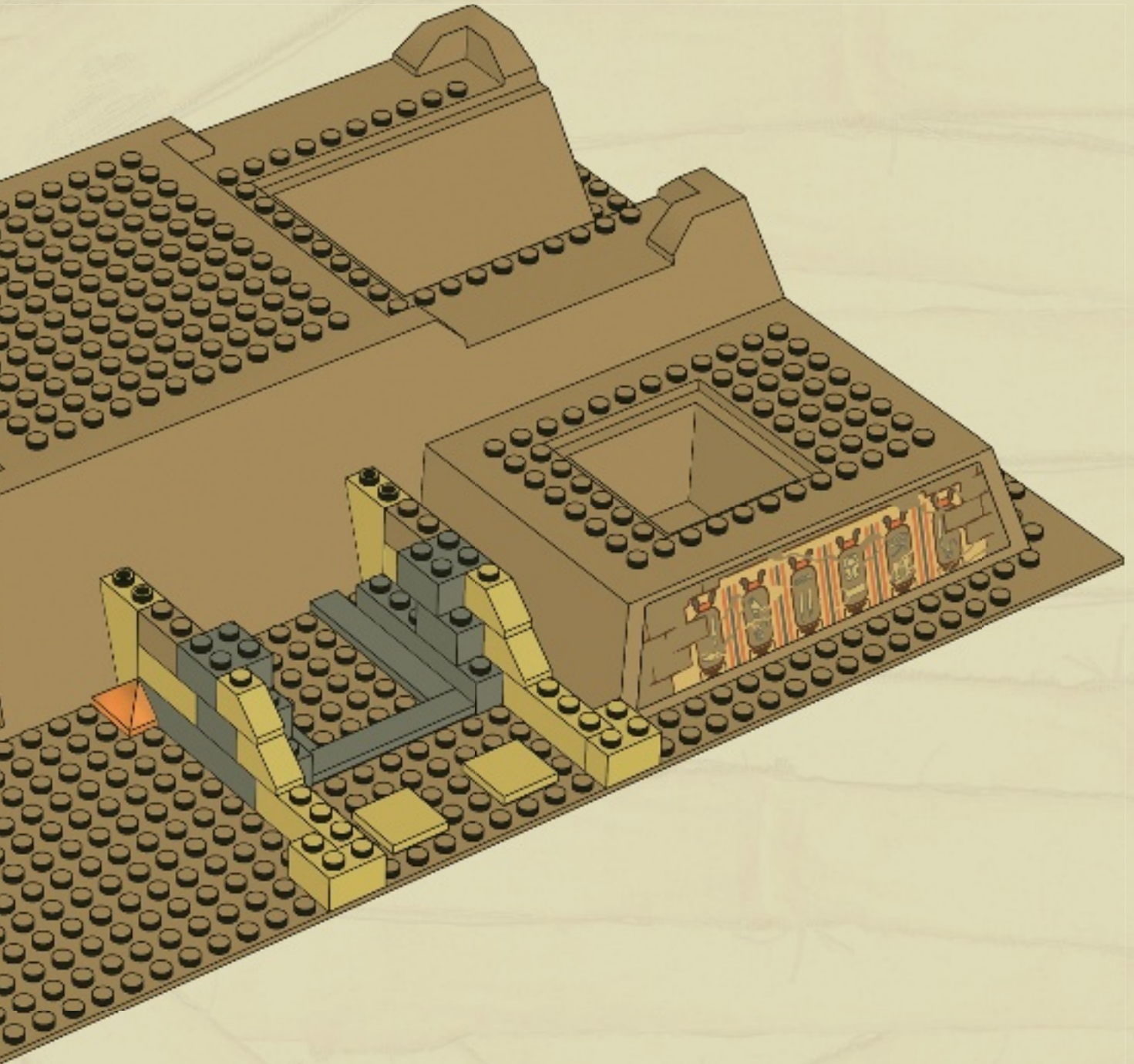



9

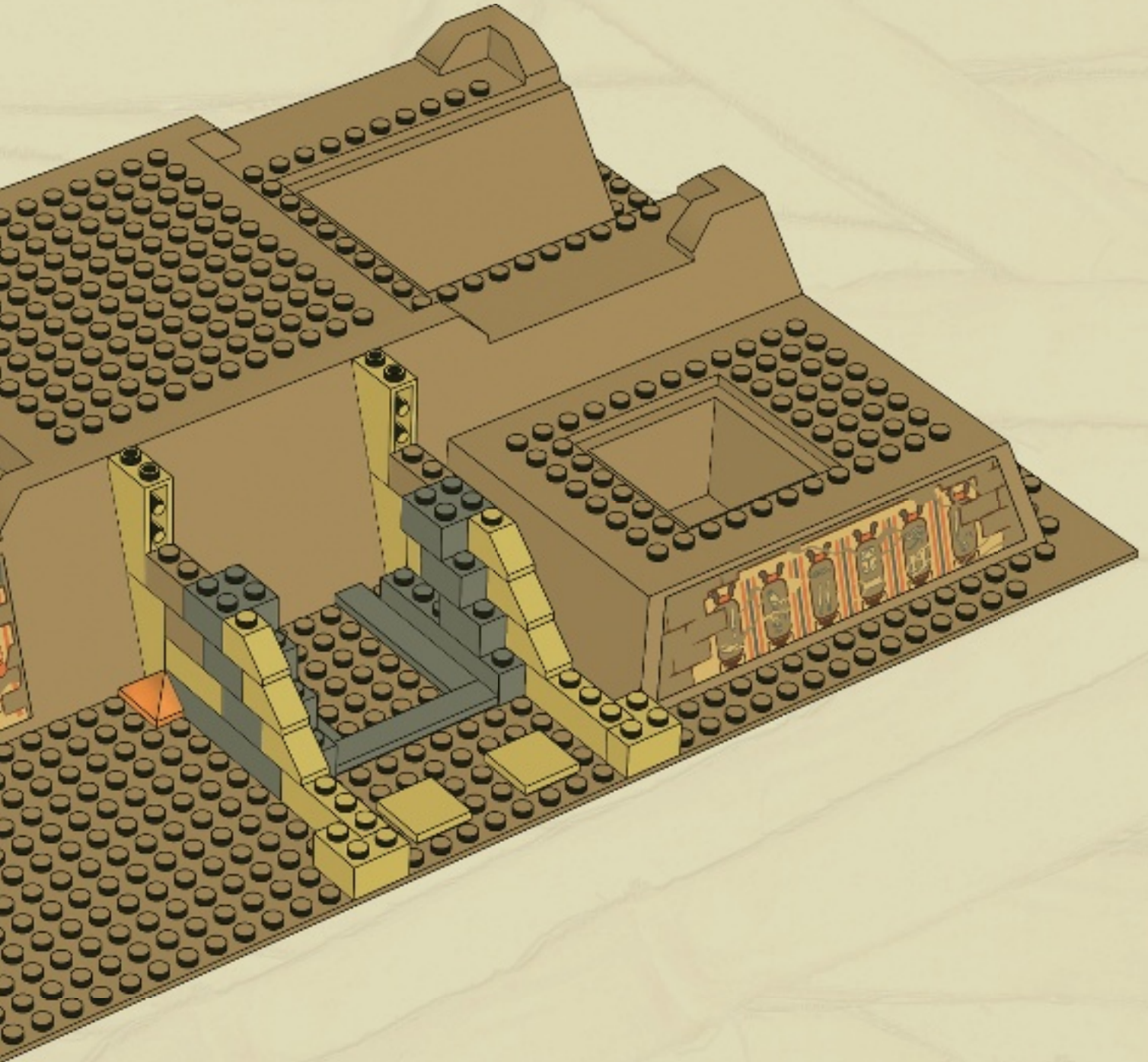

2x  2x 

10

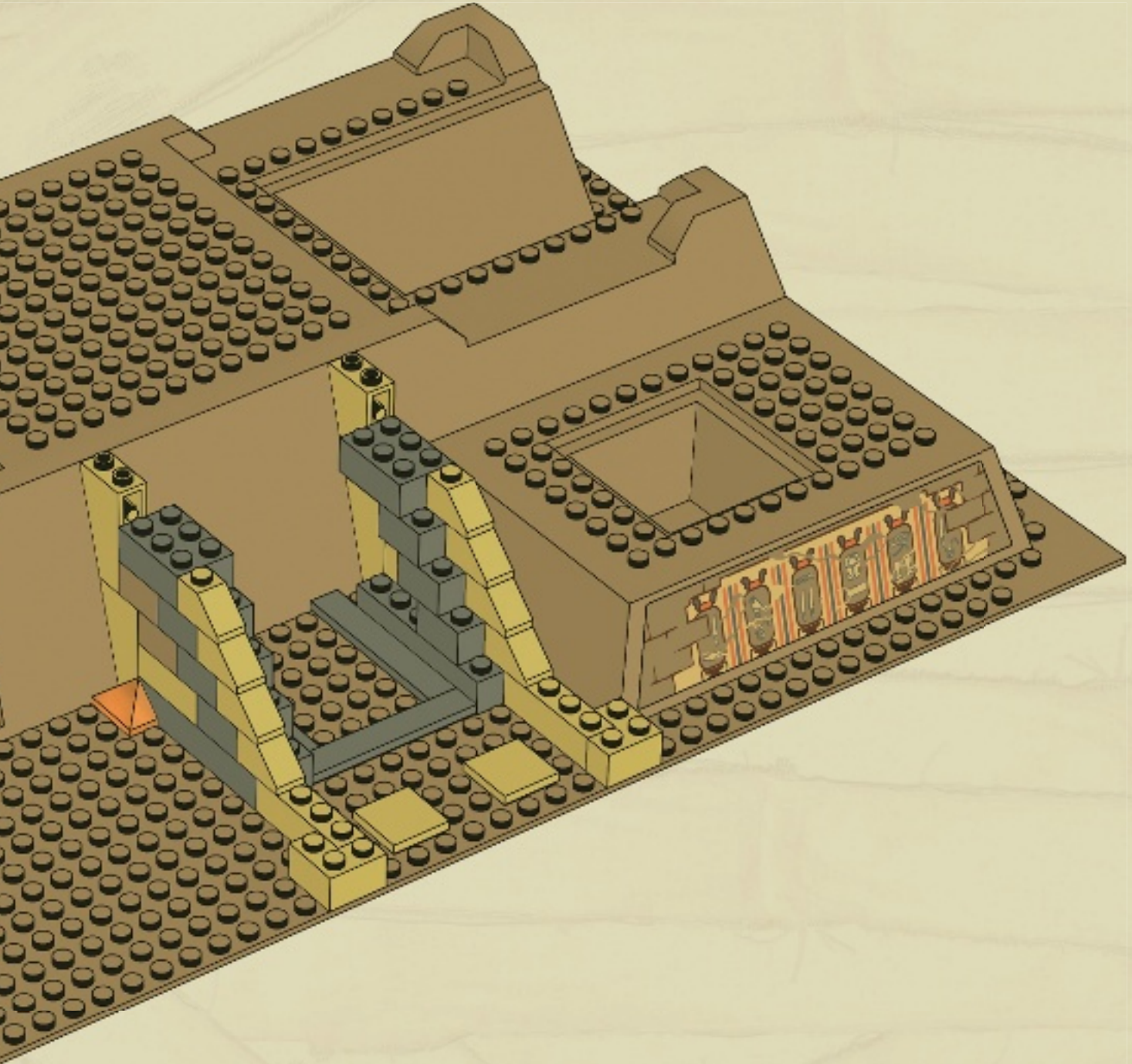



2x



4x

11



4x

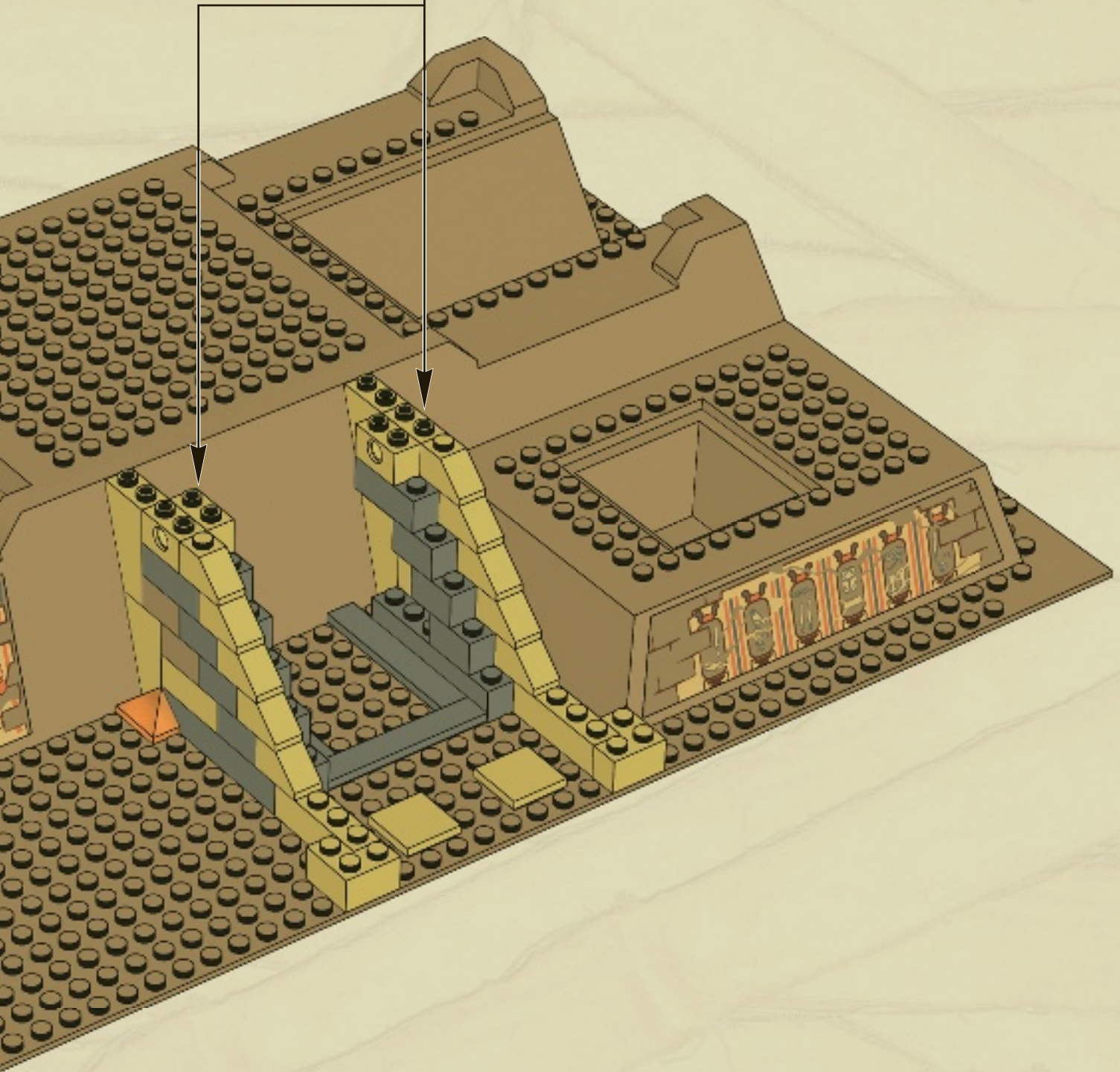

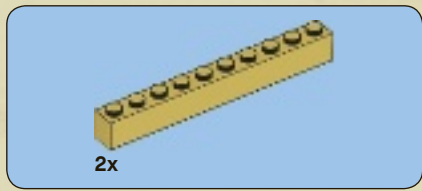

12

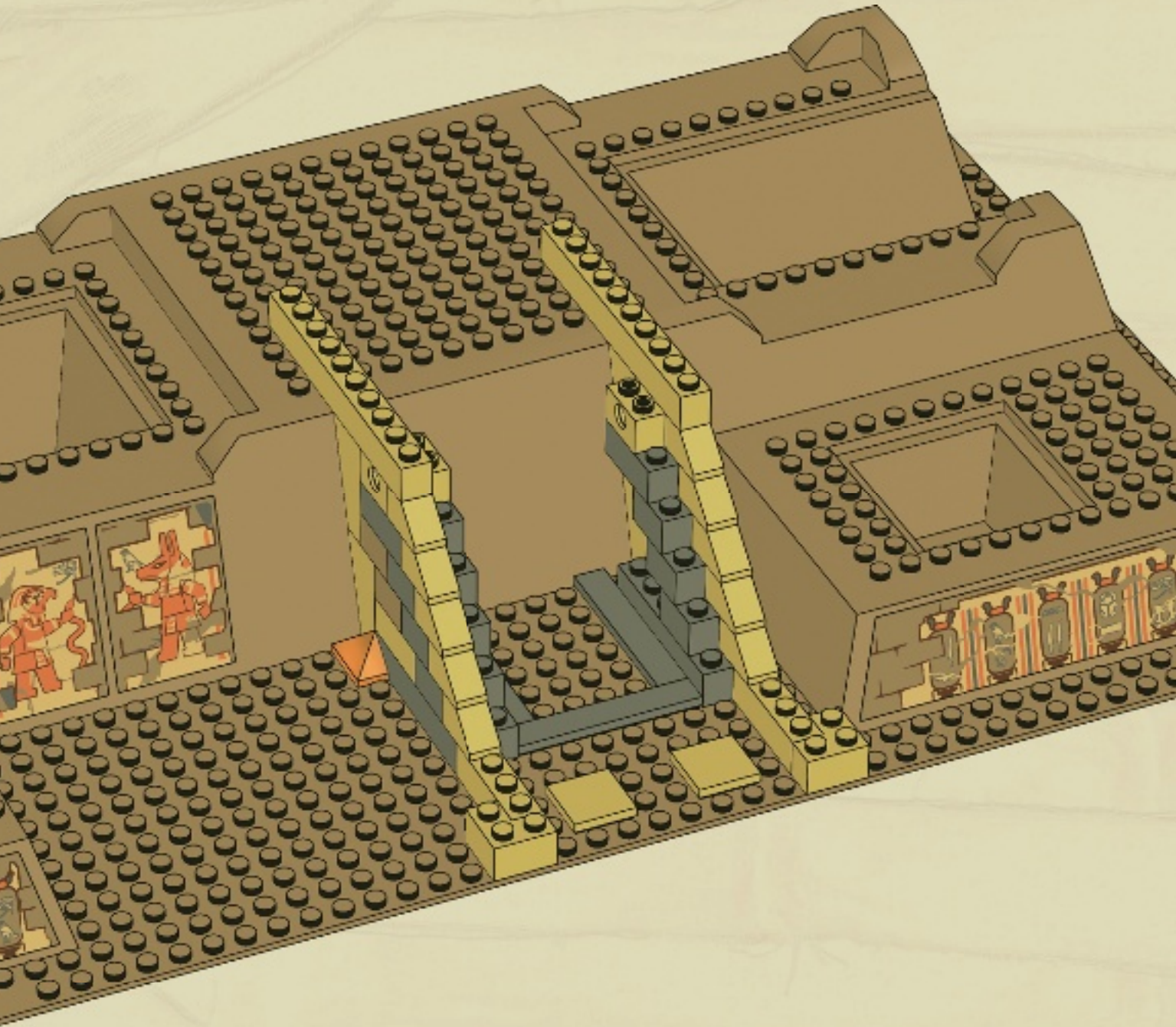

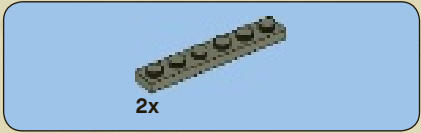

13

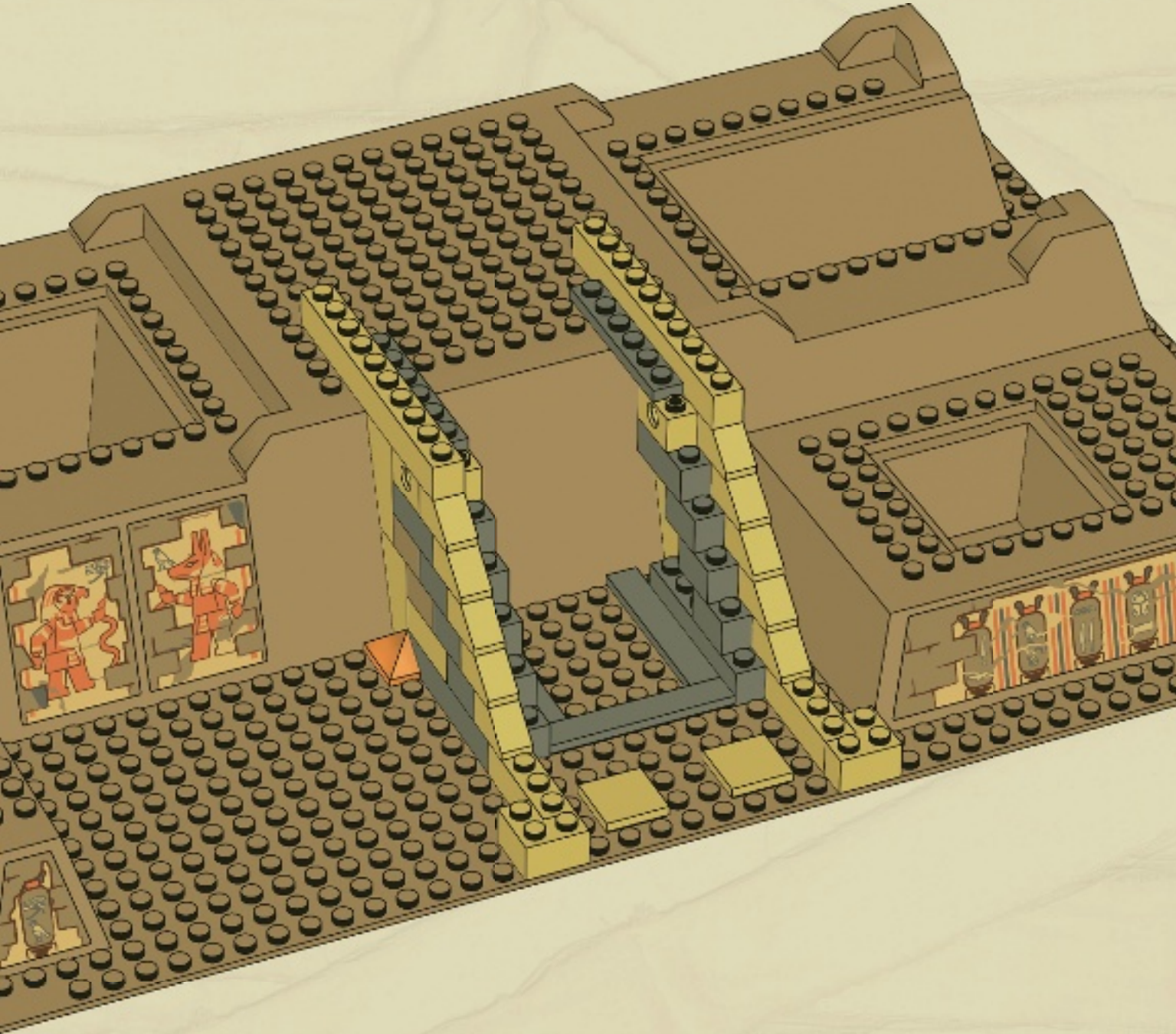



1

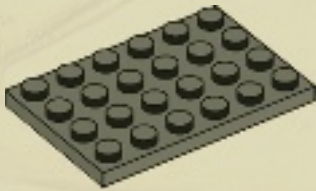

2

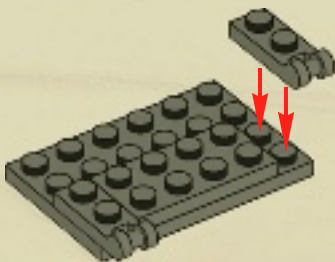

3

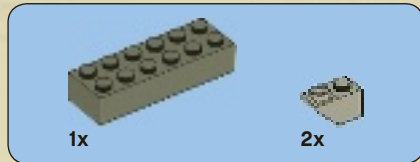
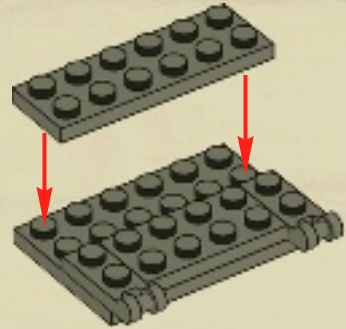

4

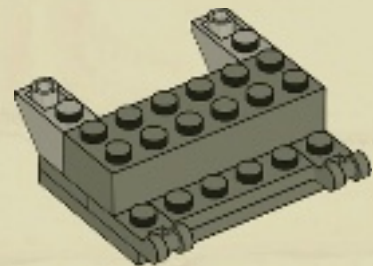

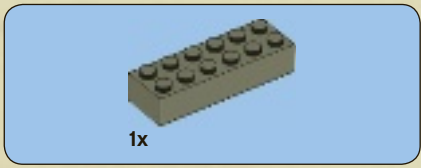

5

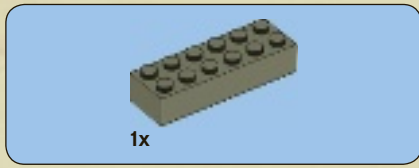
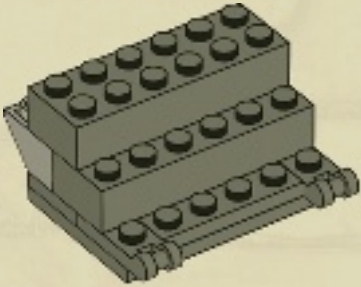

7

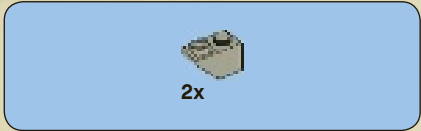
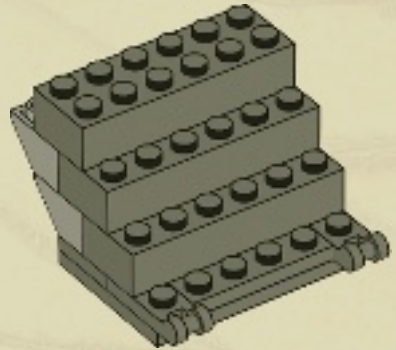

6

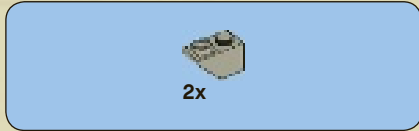
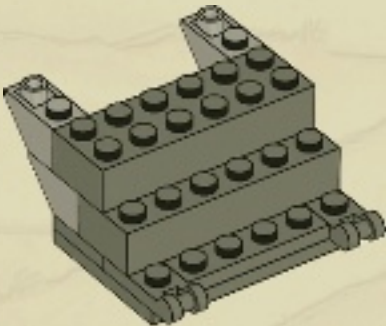

8

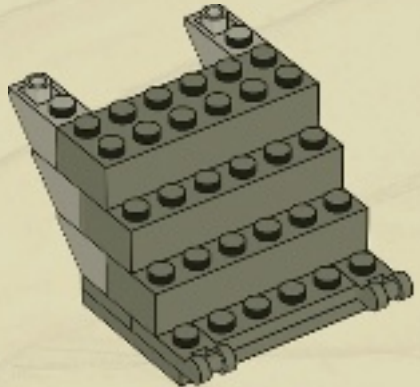

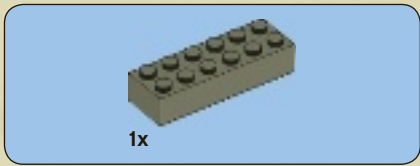

9

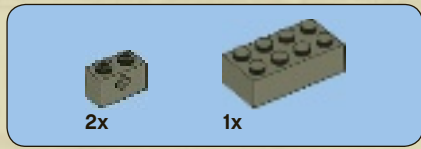
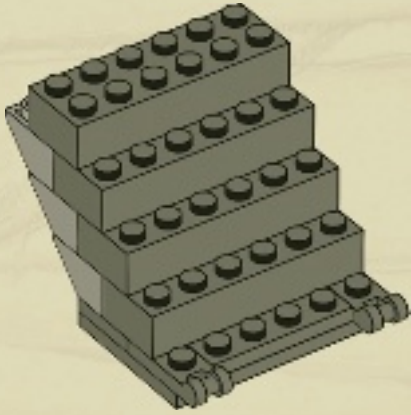

11

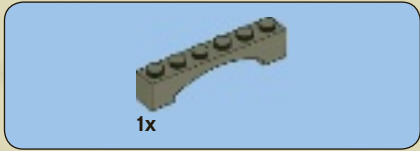
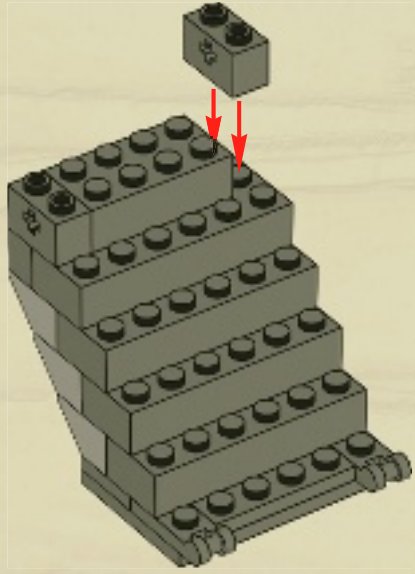

10

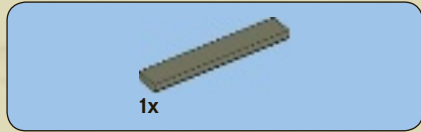
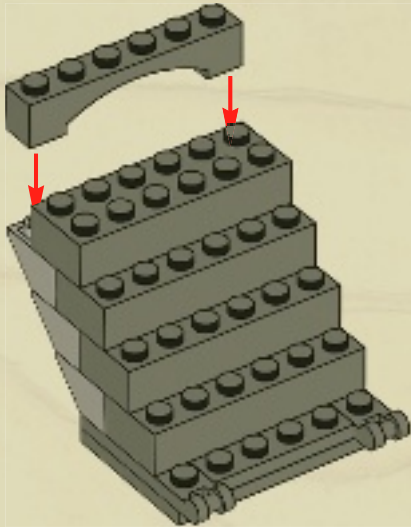

12

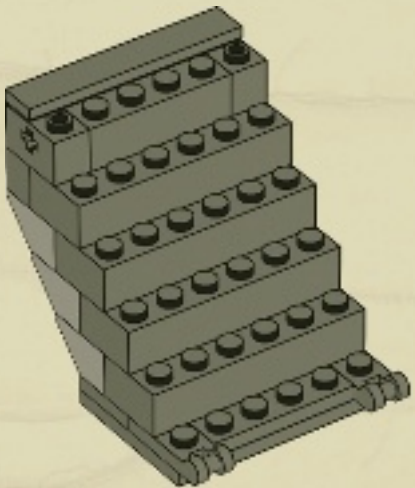



14

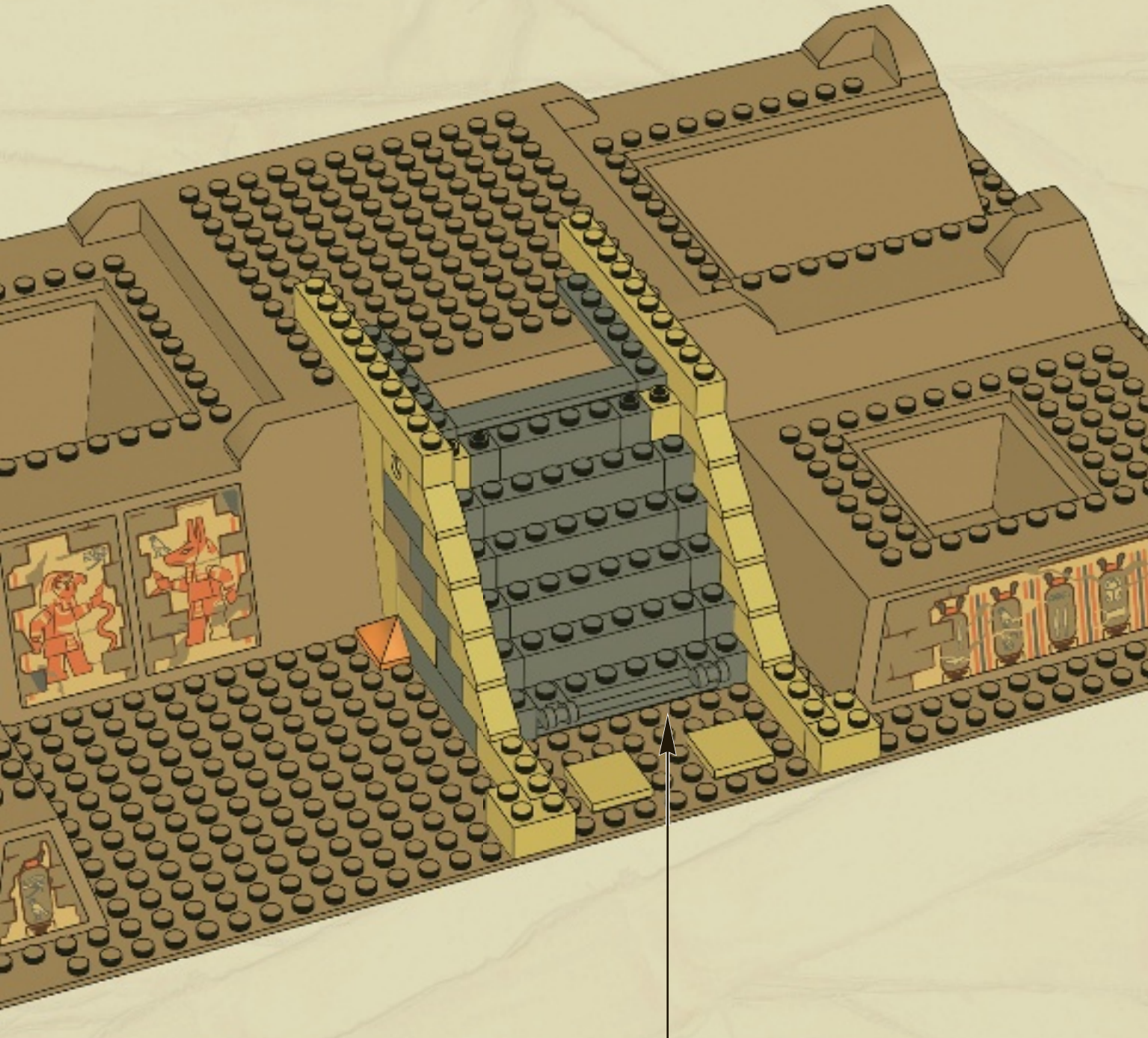

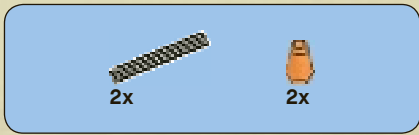

15

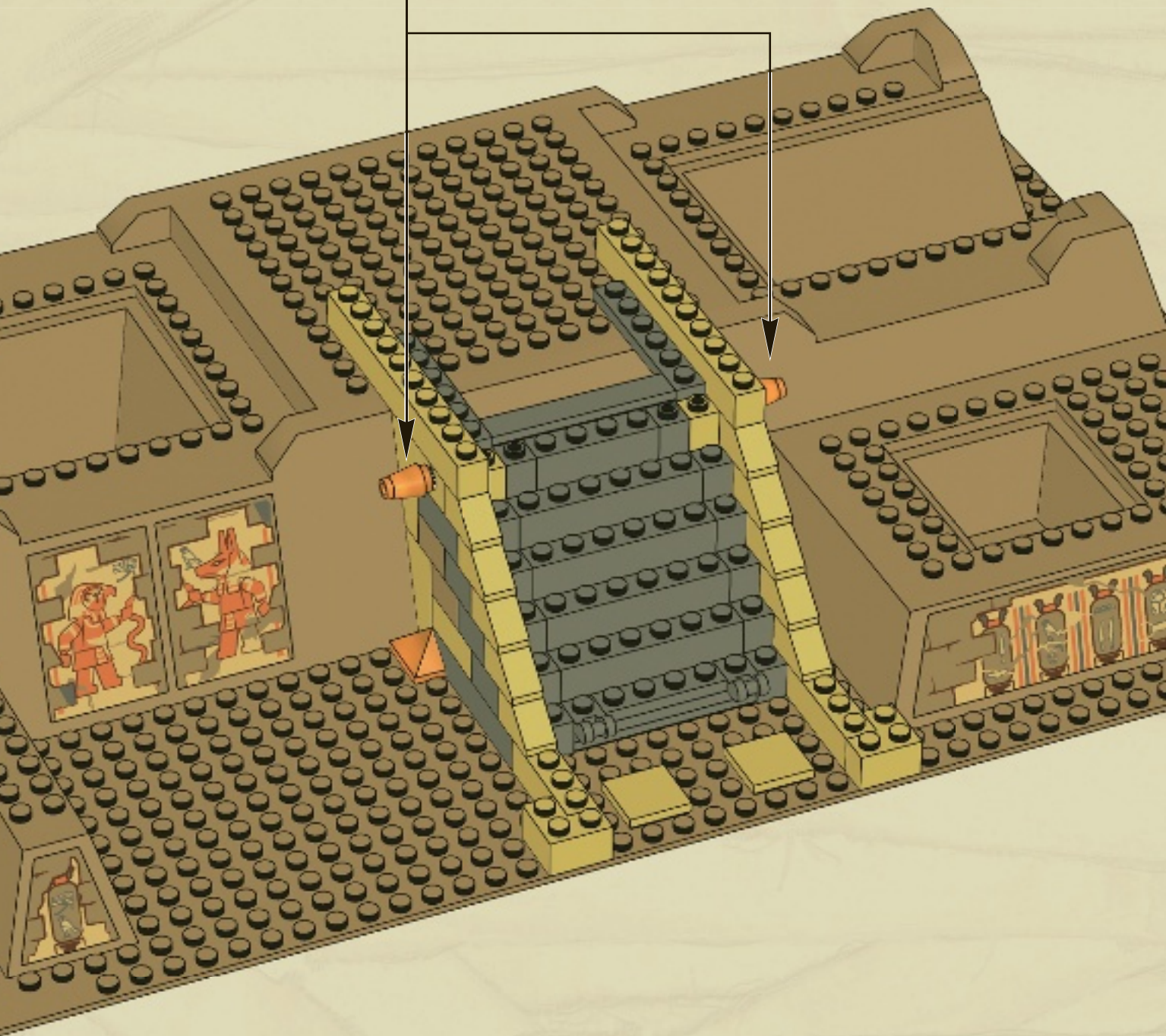
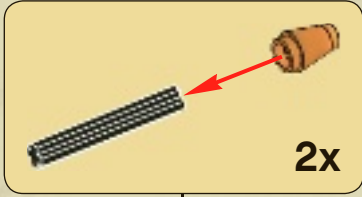
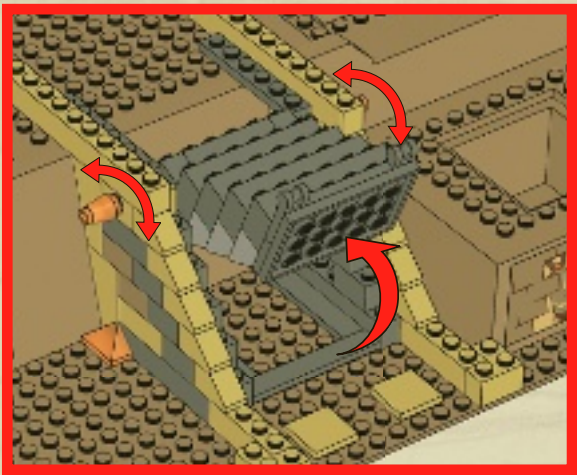

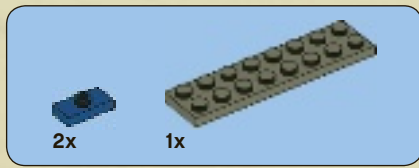

16

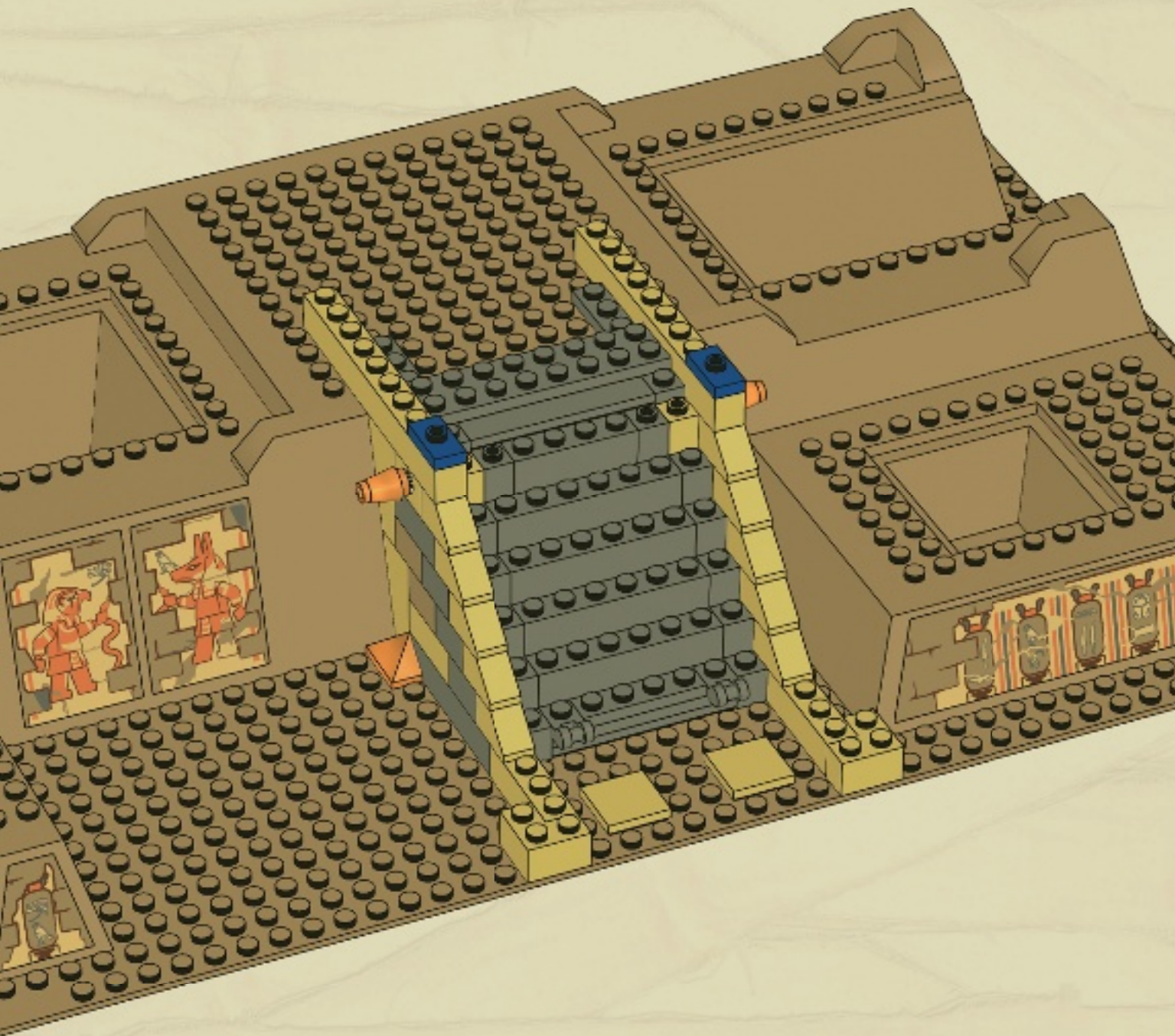



17

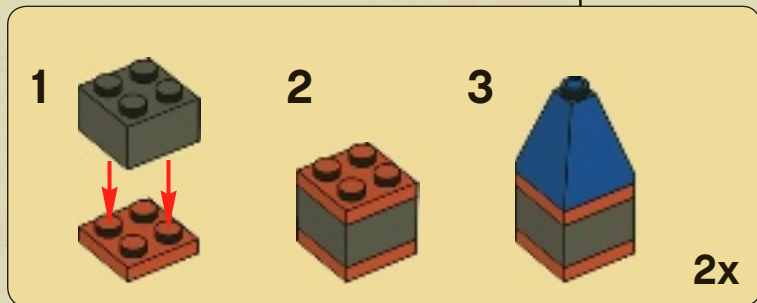
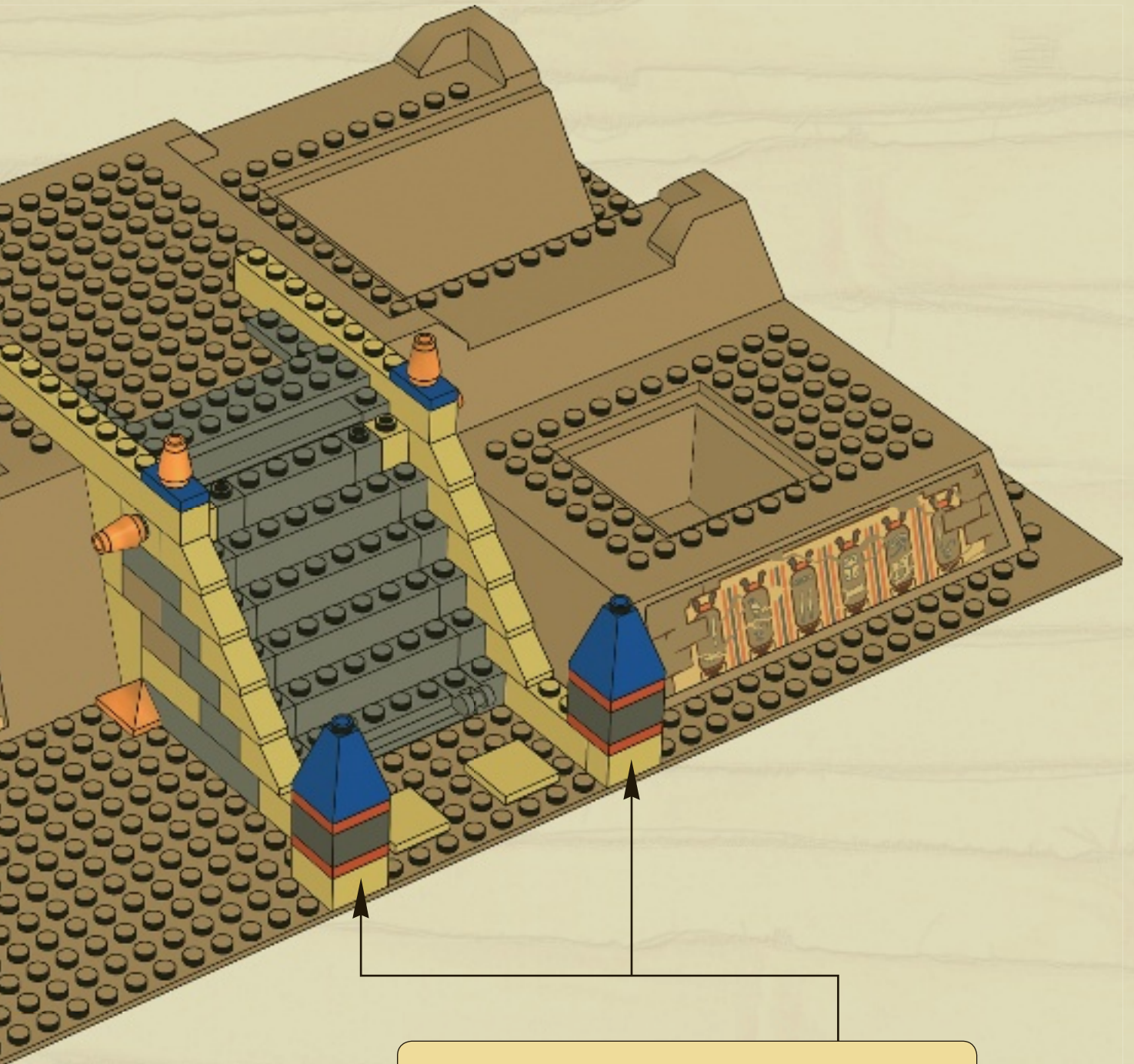

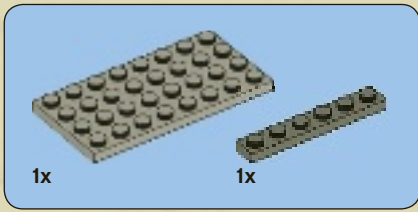

18

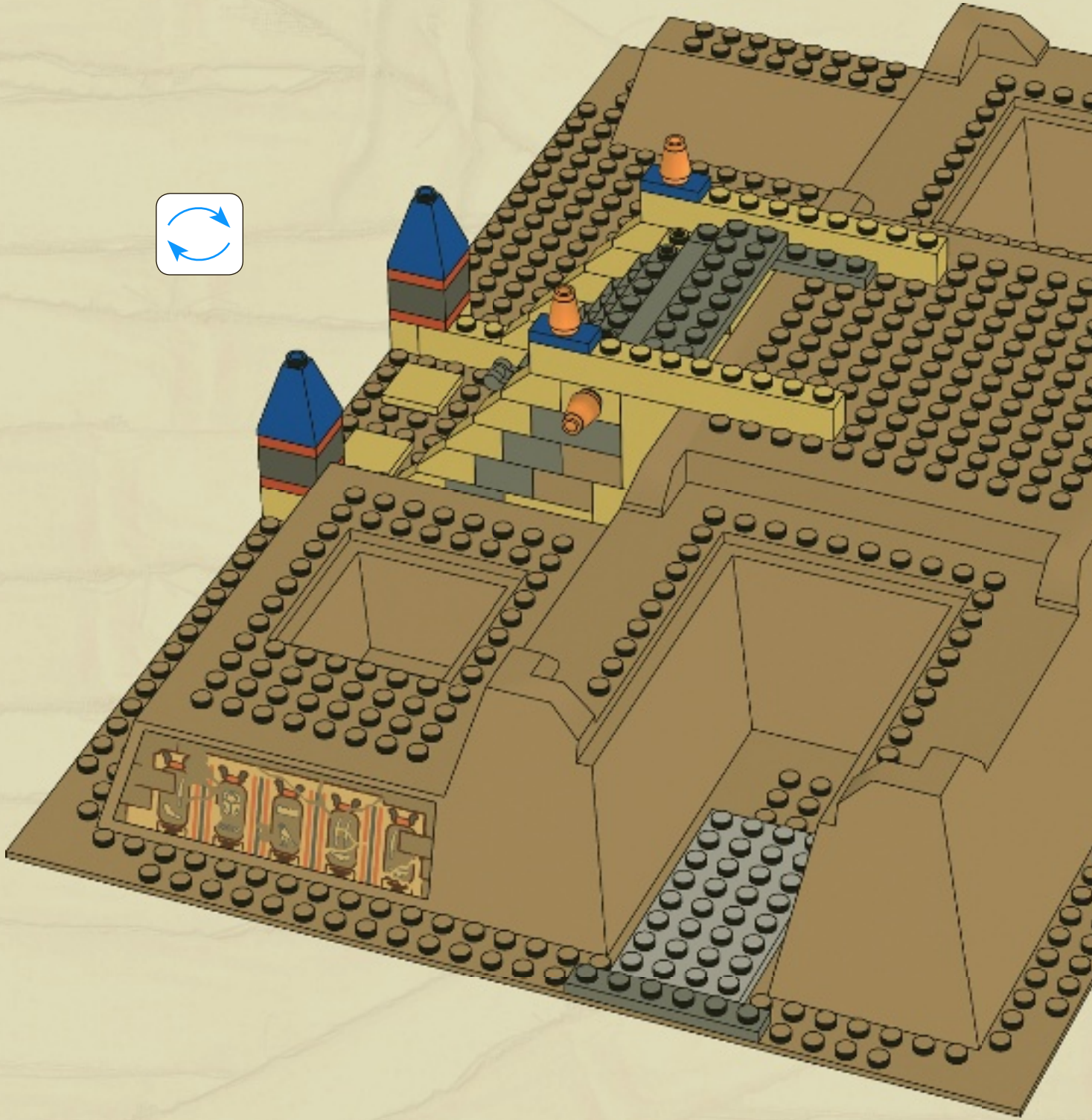

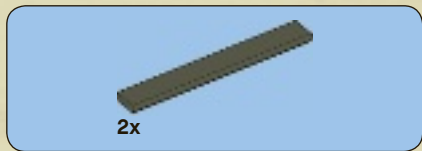

19

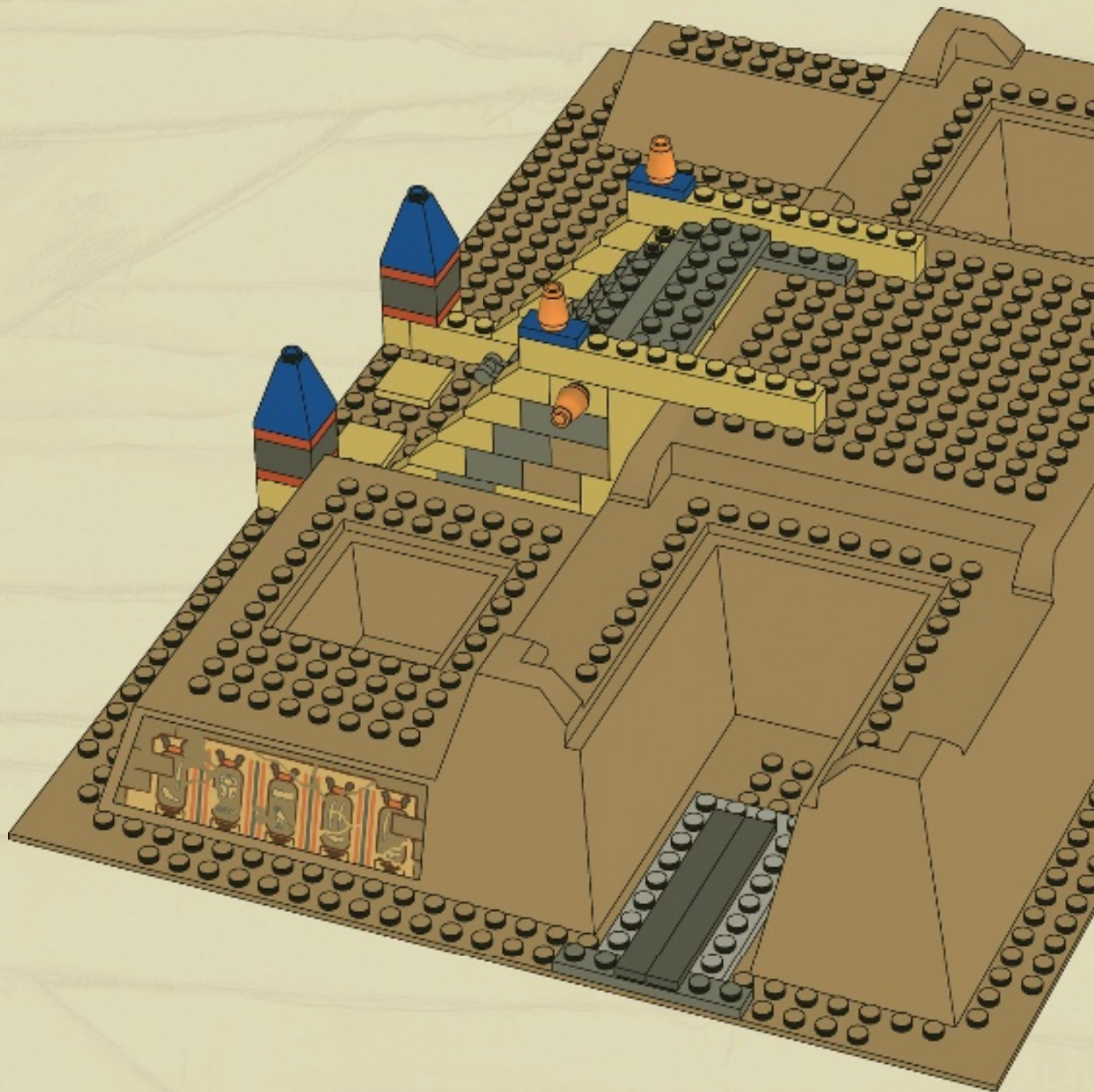

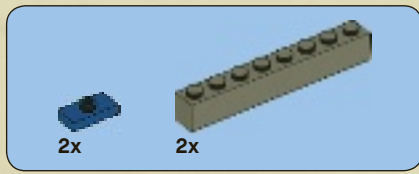

20

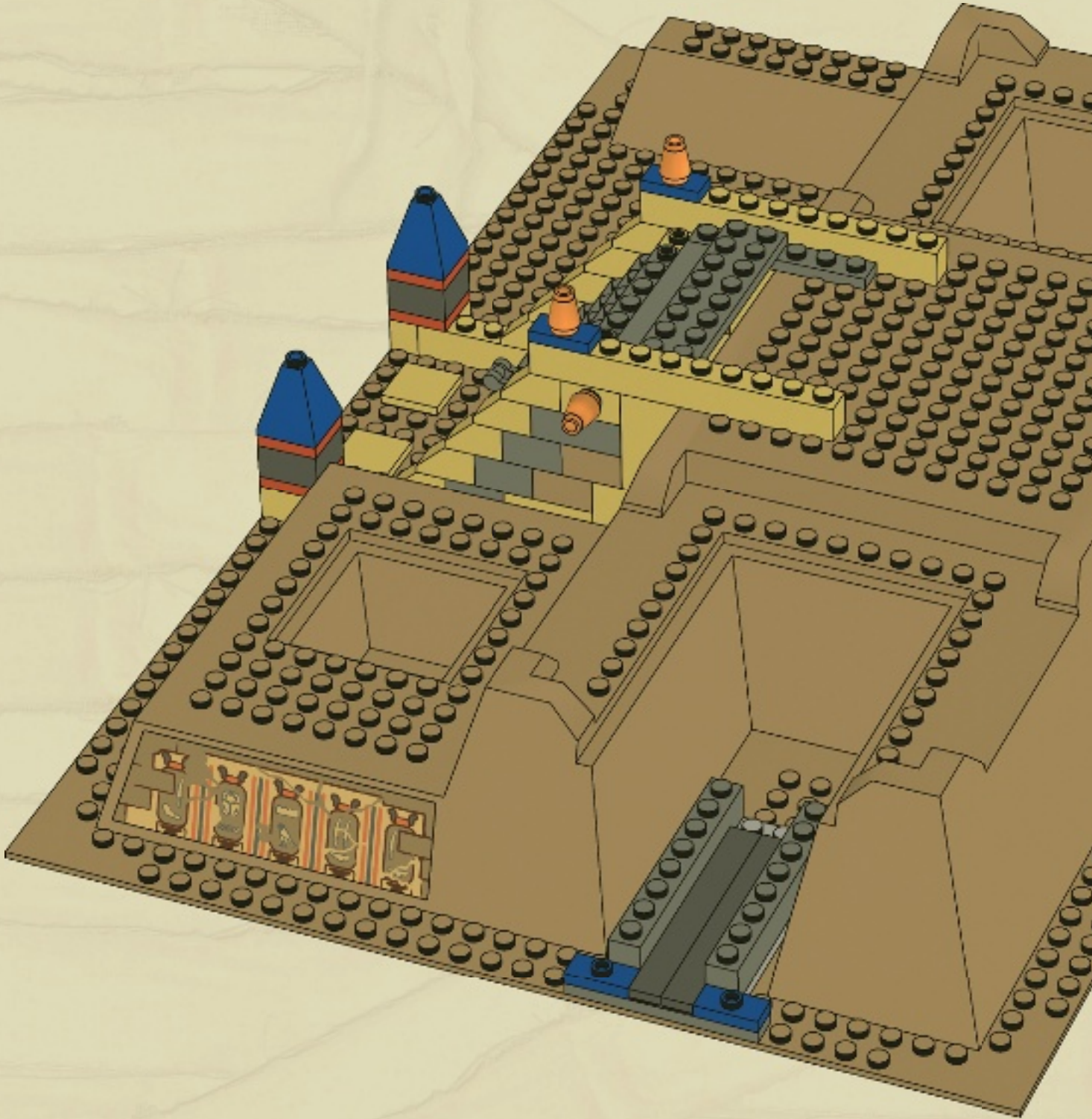

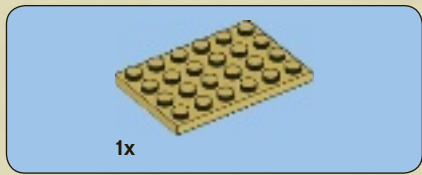
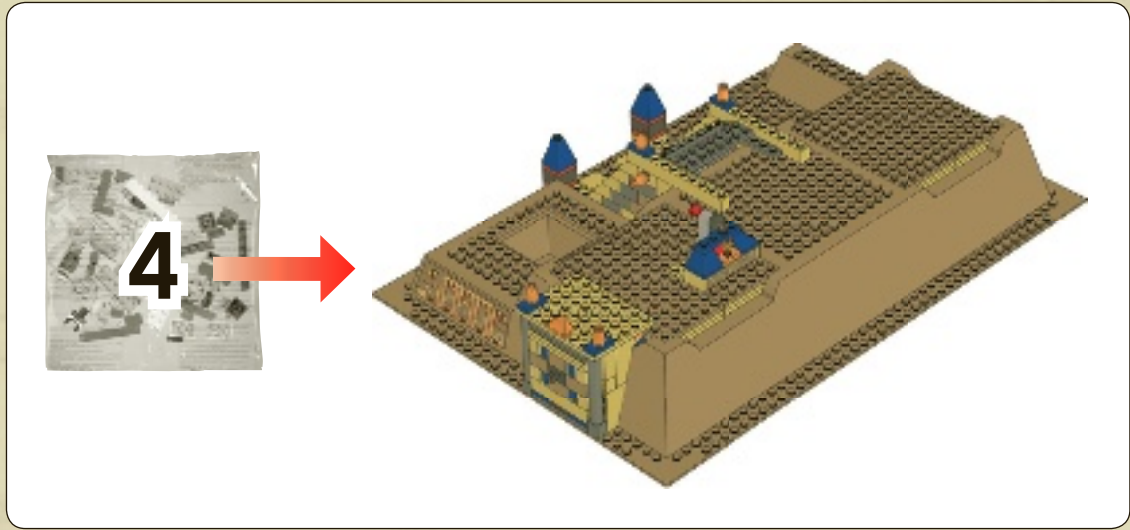

1

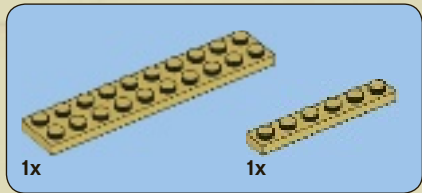

2

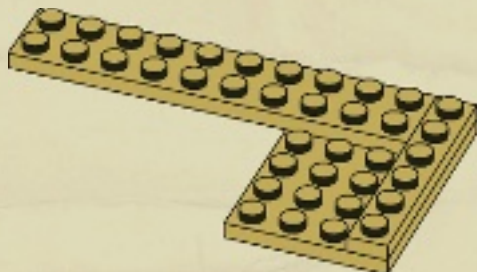

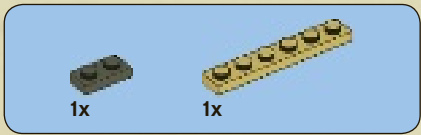

3

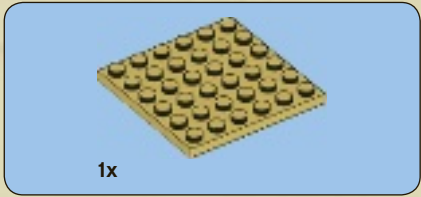
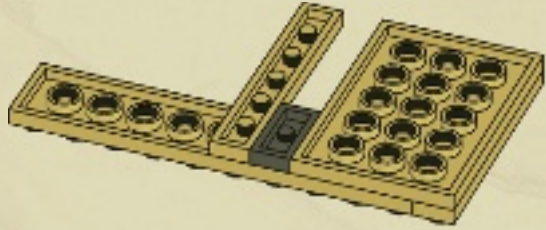

4

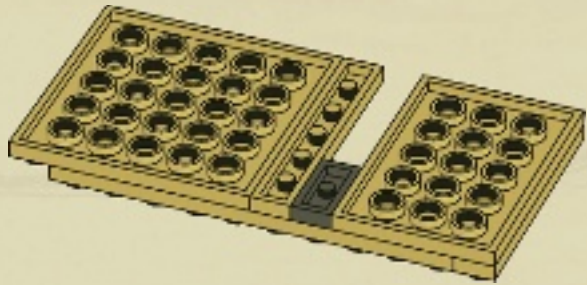

5

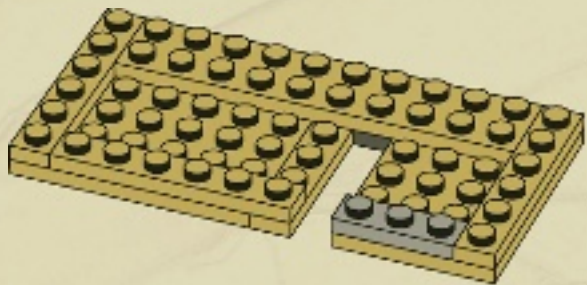

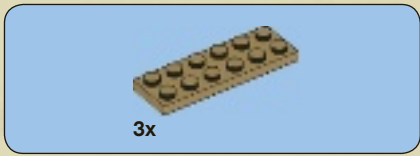

6

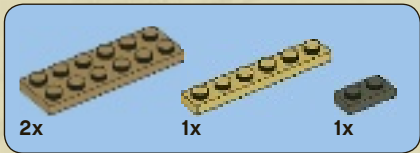
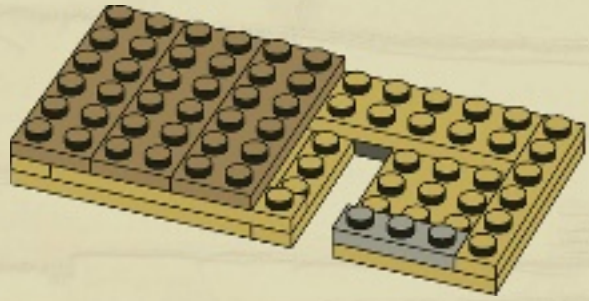

7

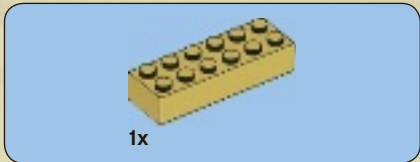
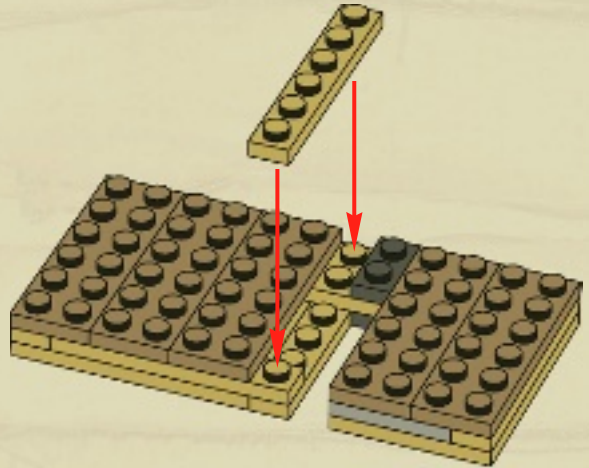

8

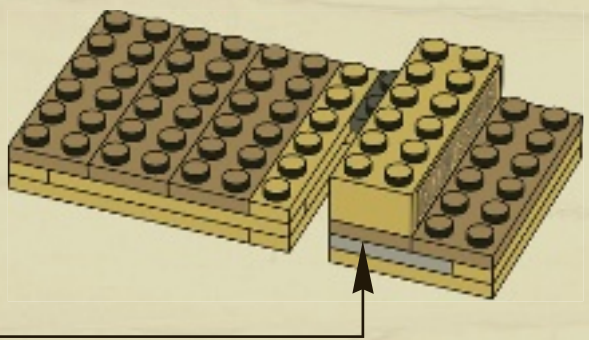
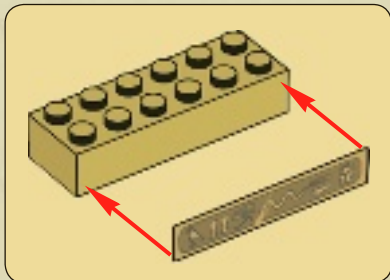



9

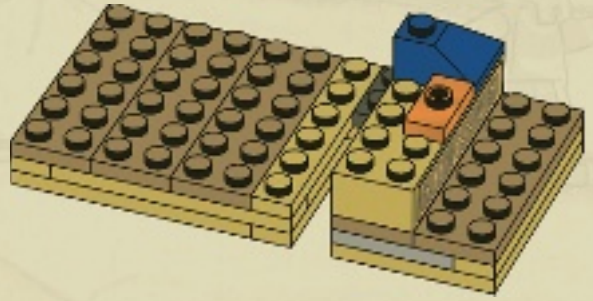

21

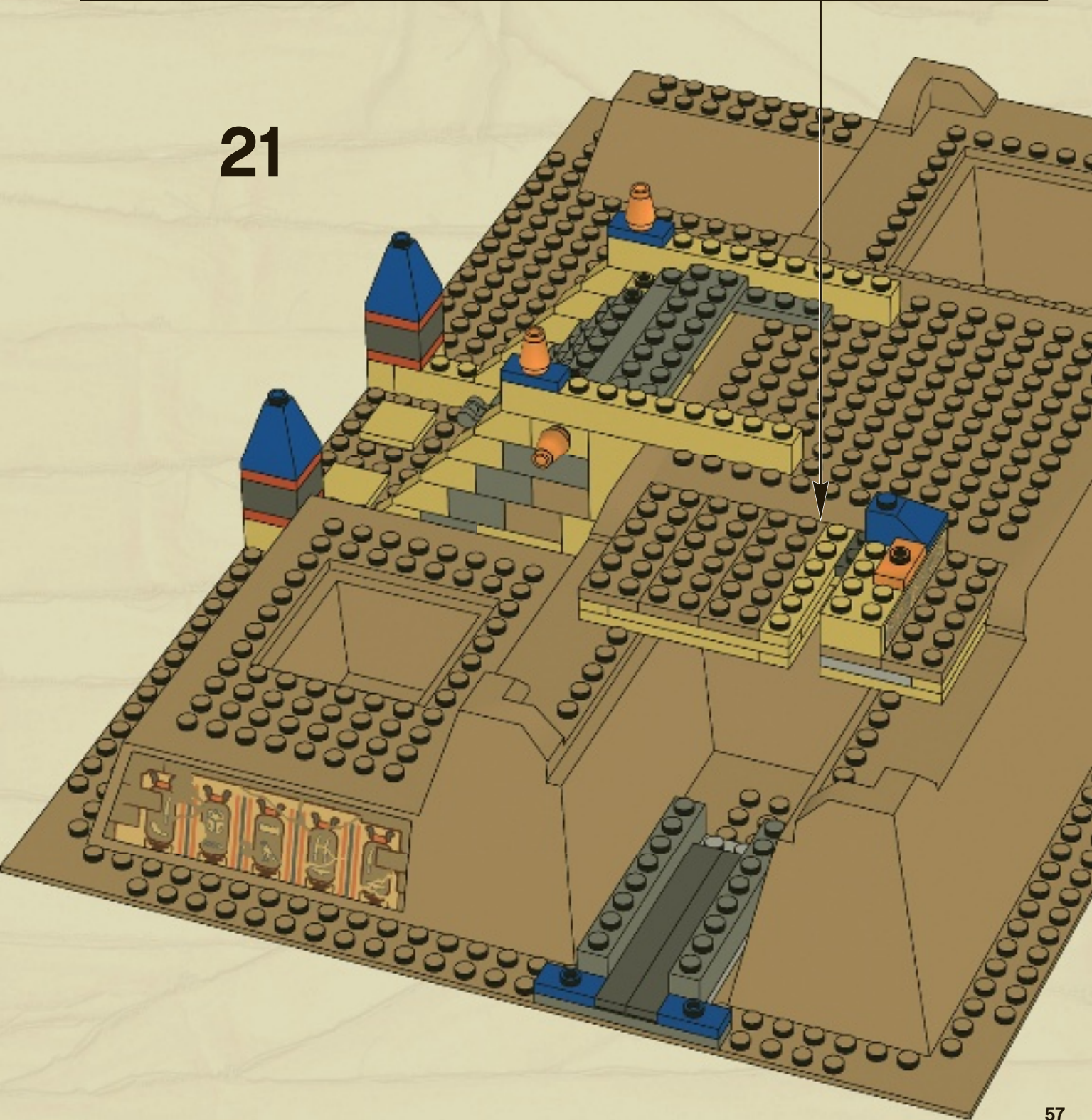



22

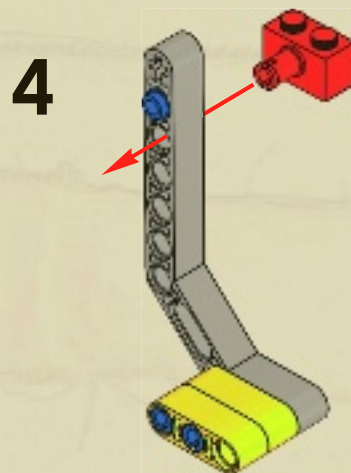
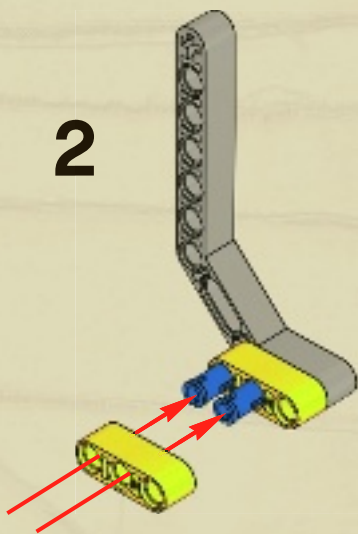
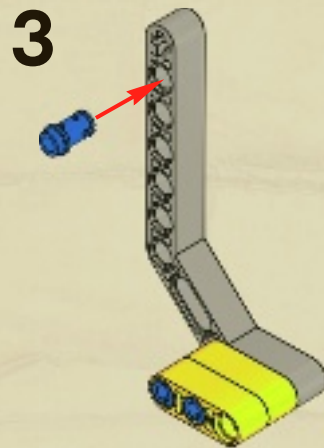
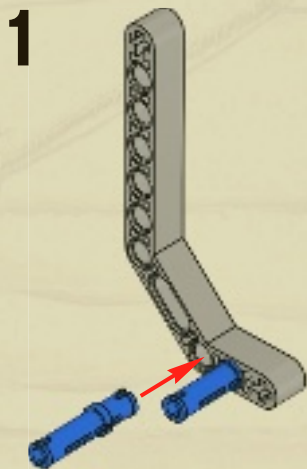

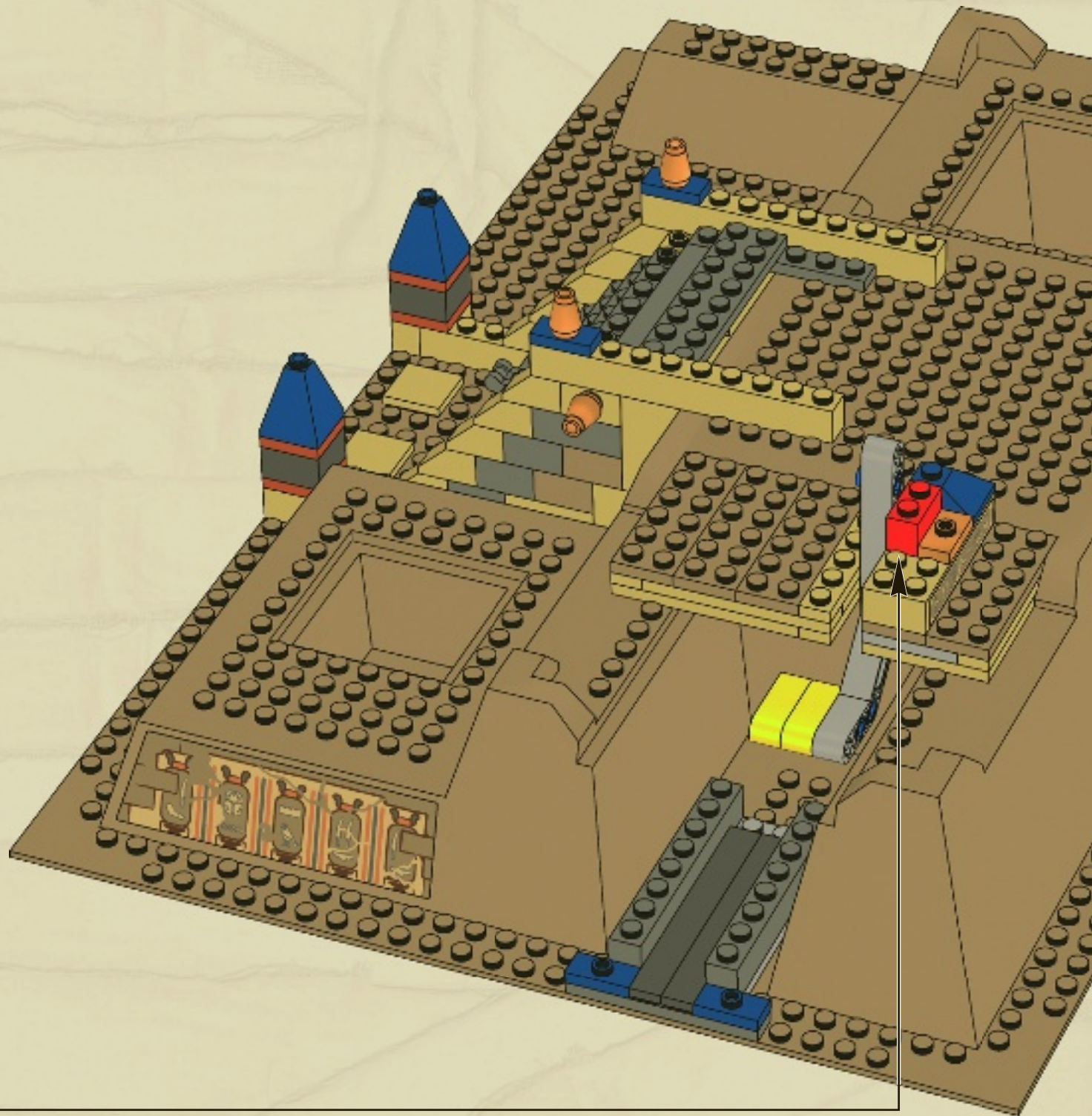



1x

23

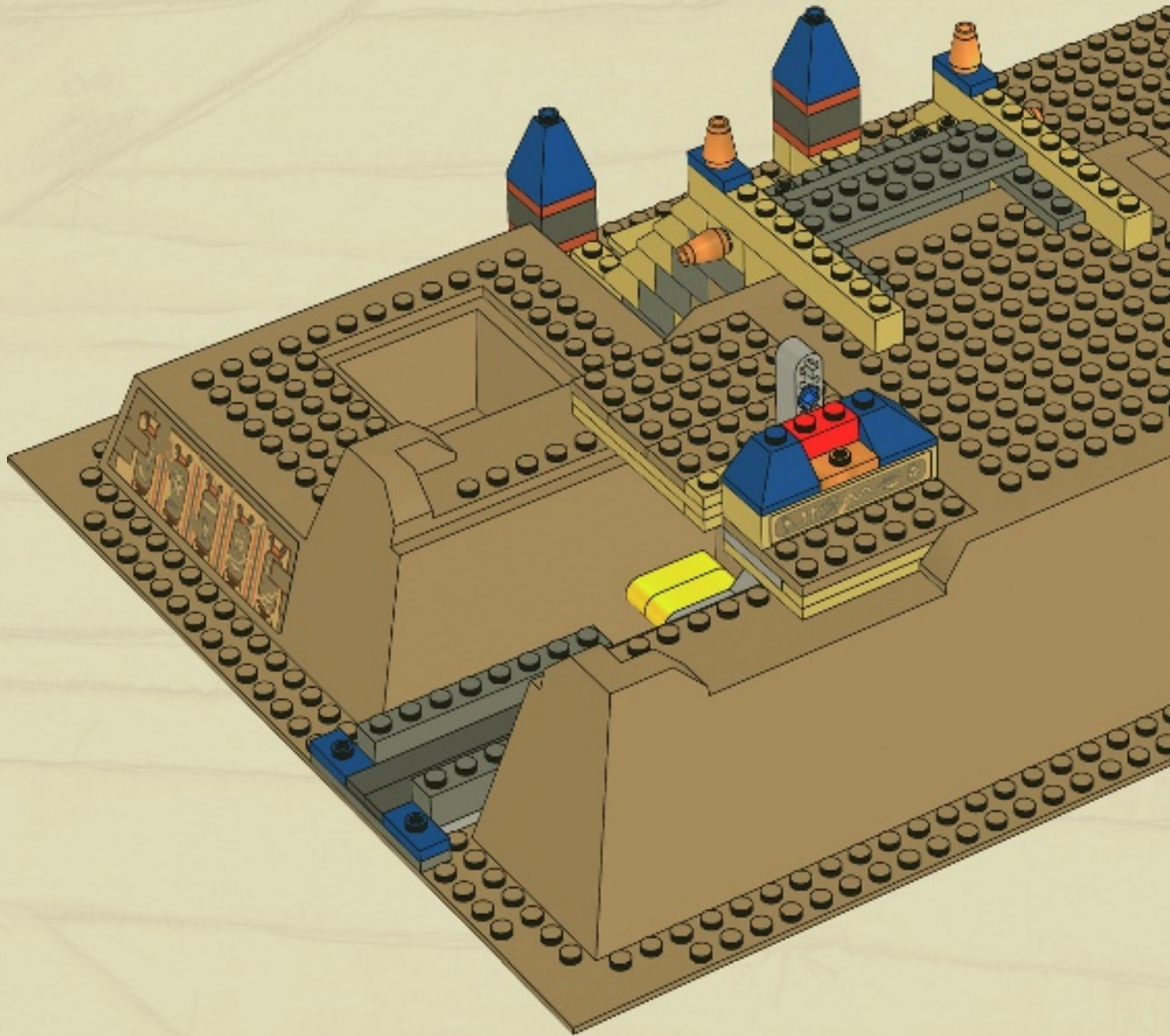



1x



1x

24

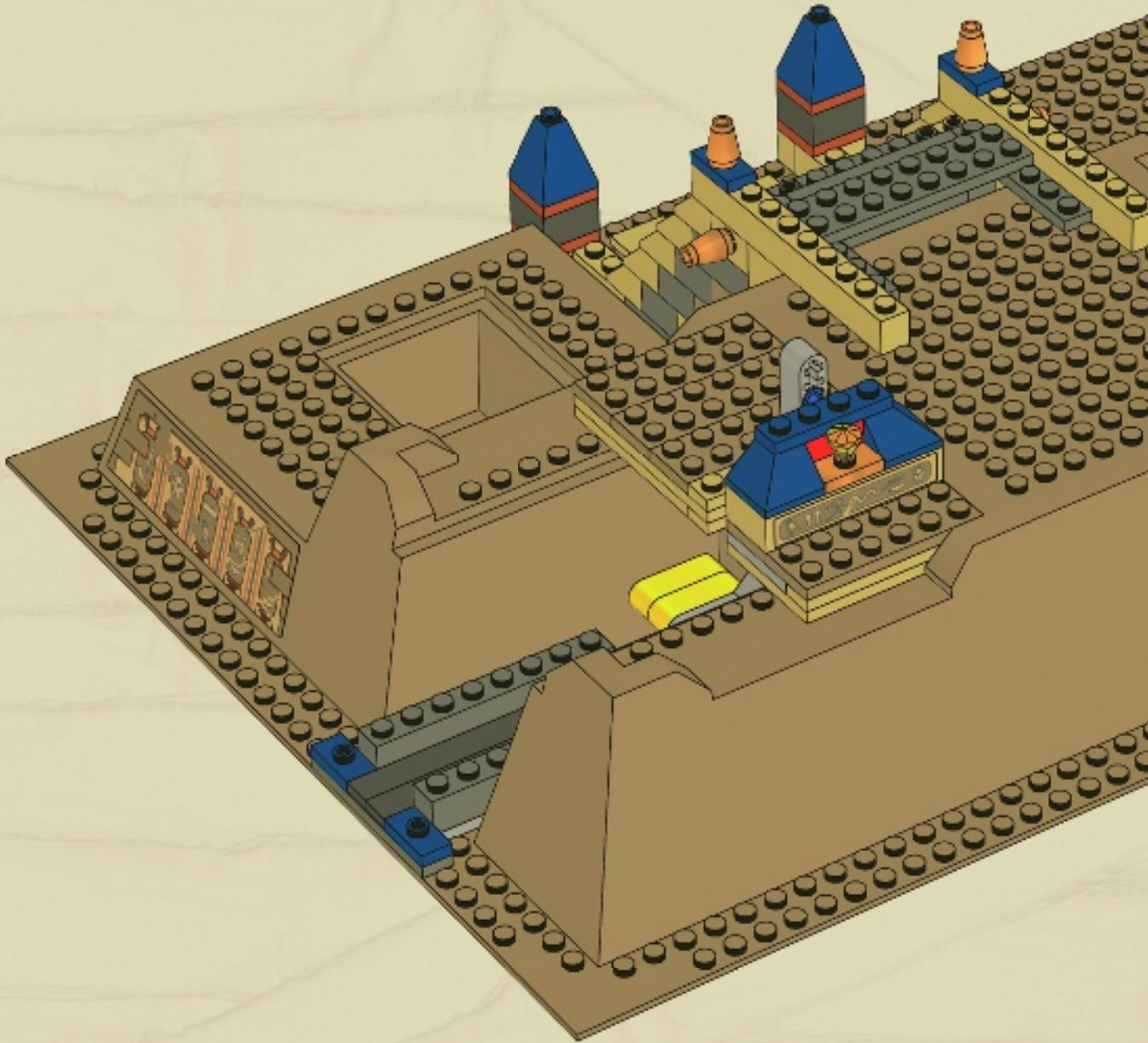

1x  1x 

25

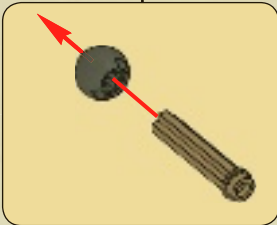
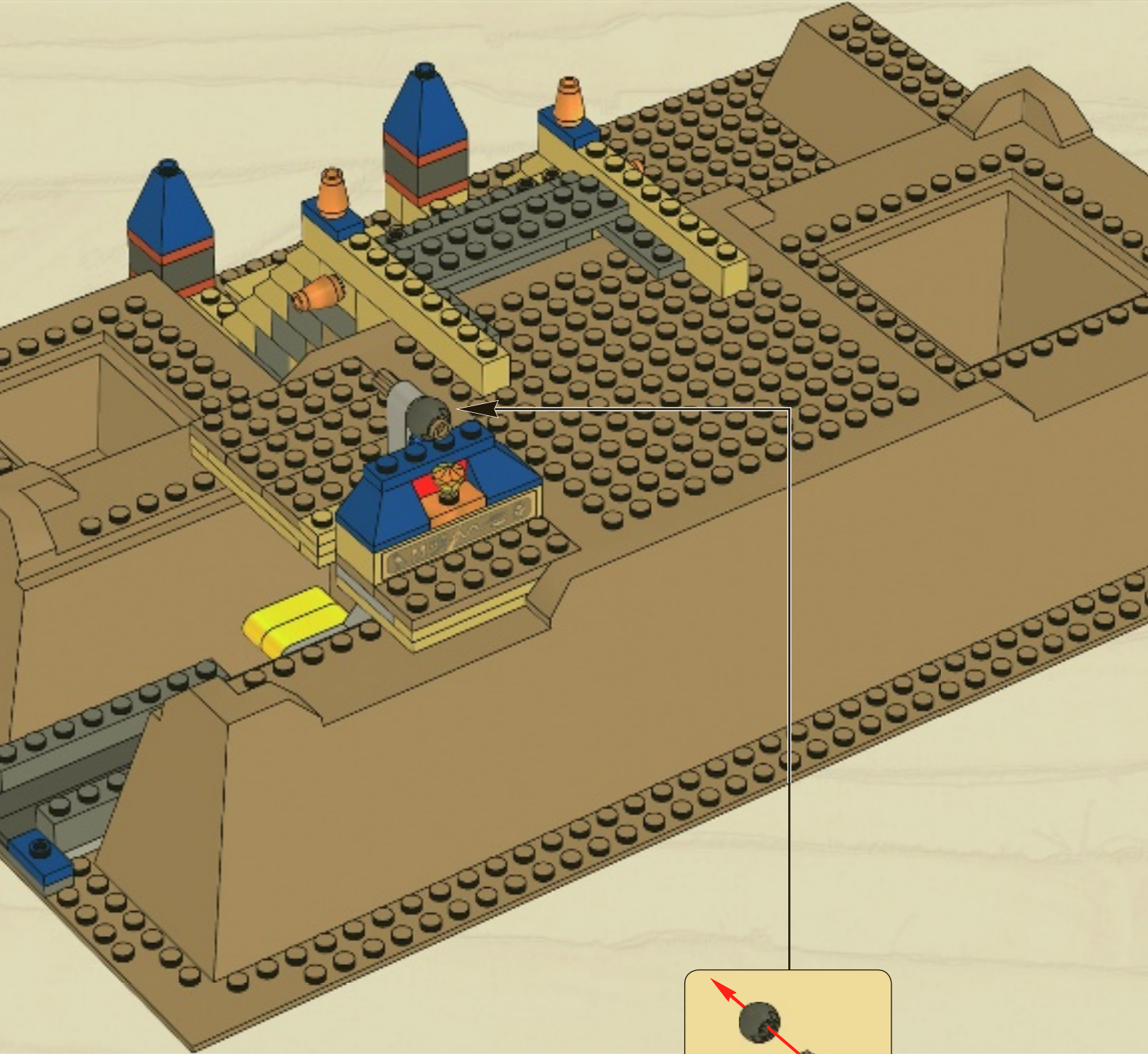

1x

26

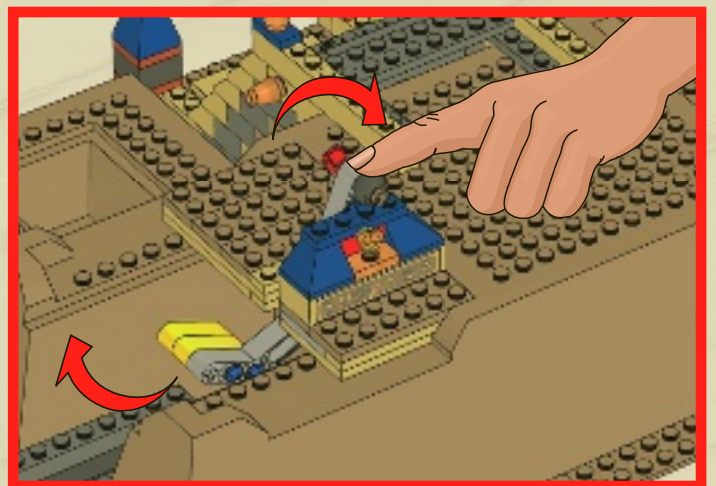
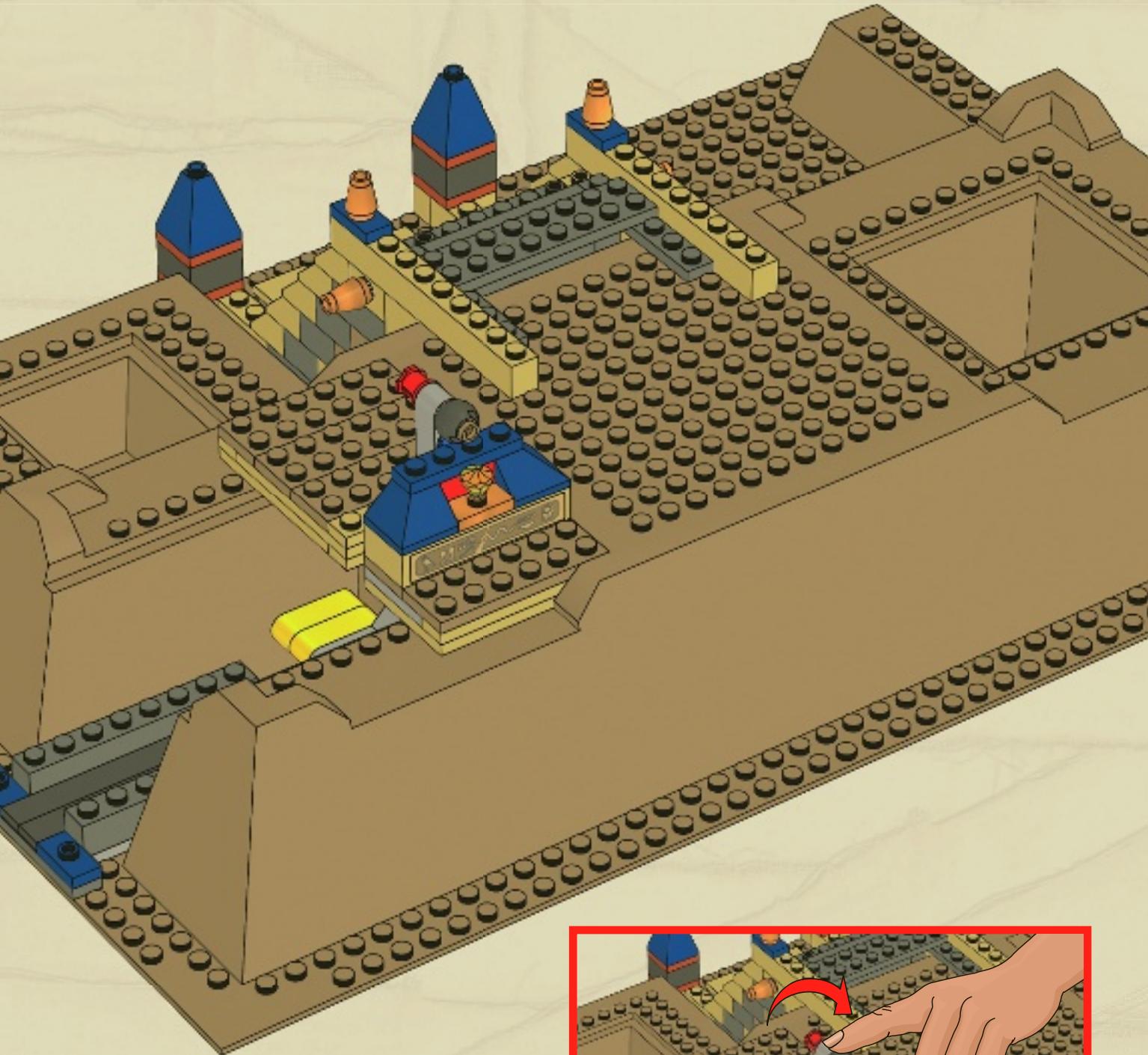

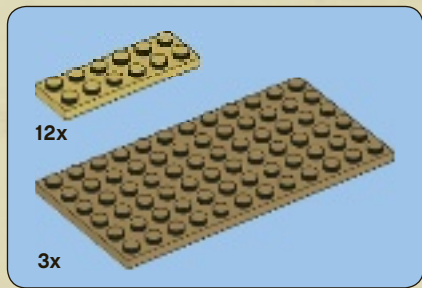

27

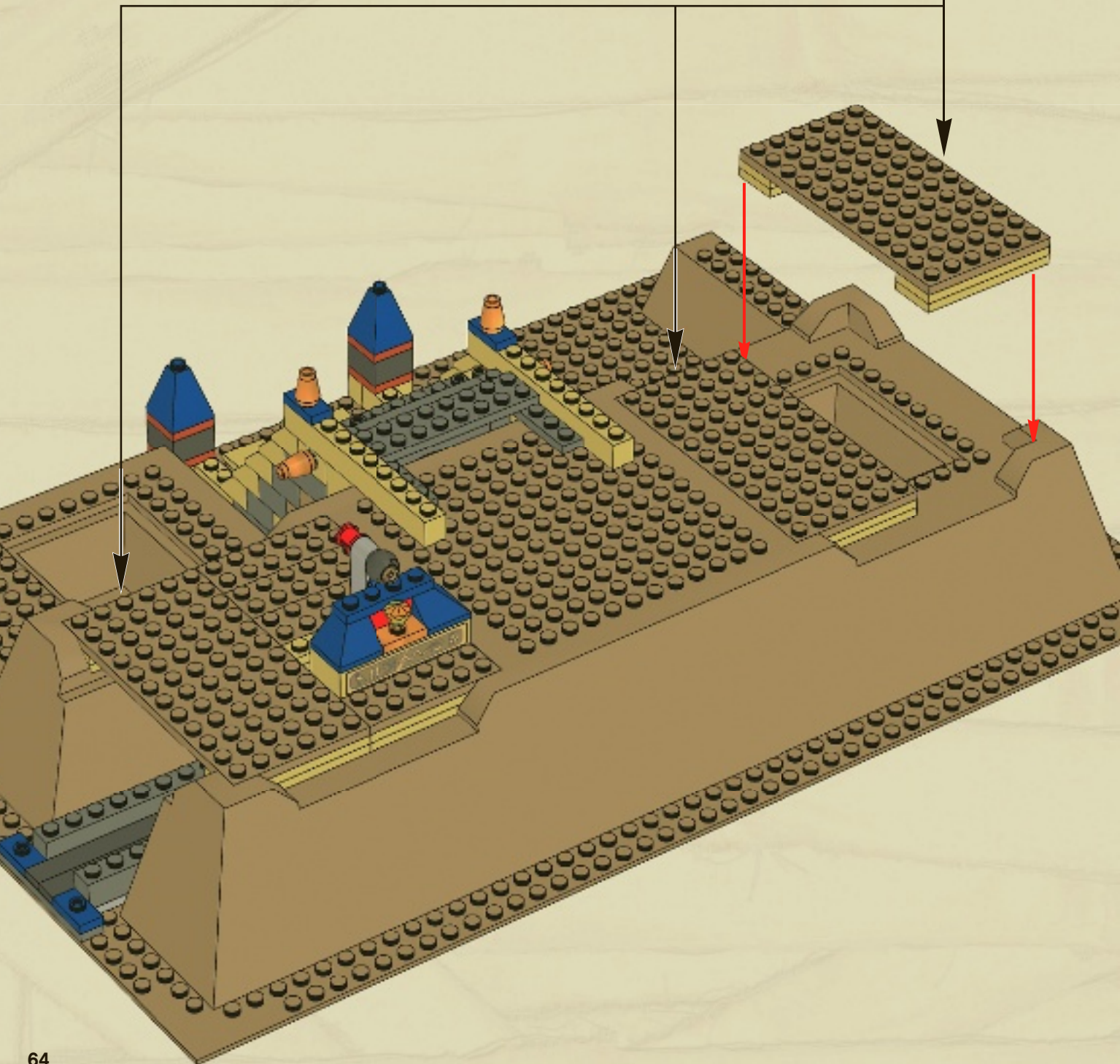
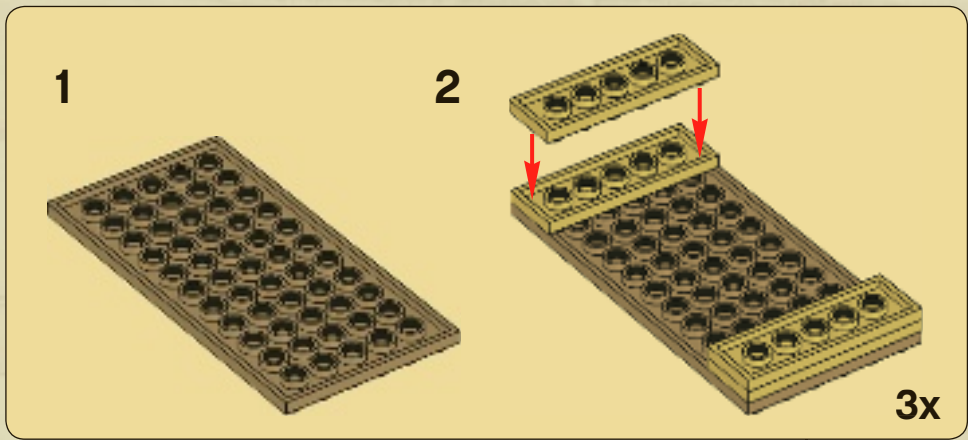



2x

28

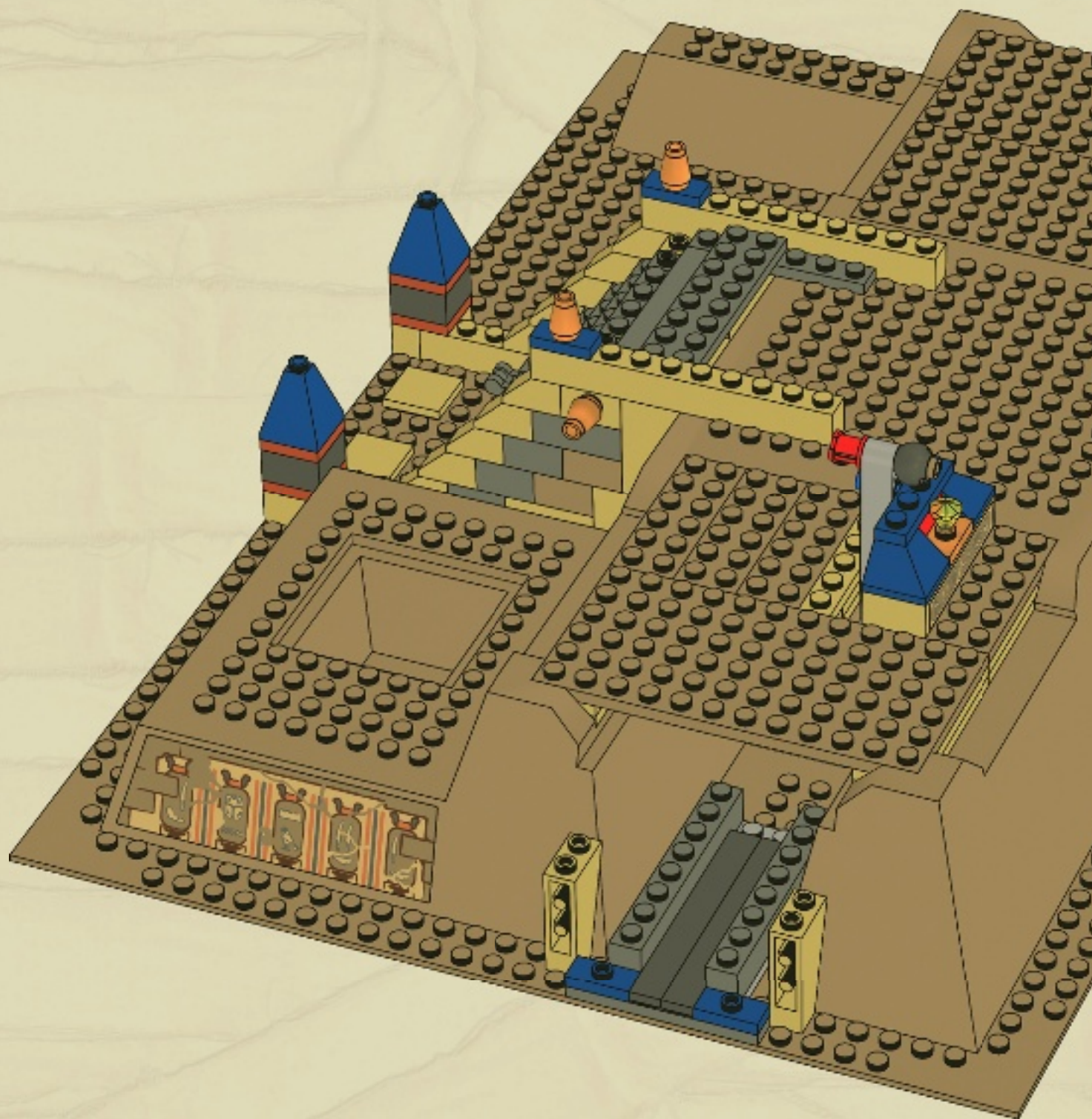

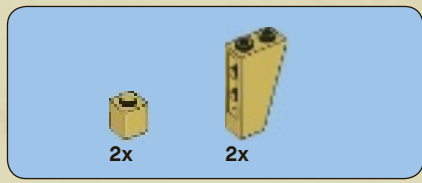

29

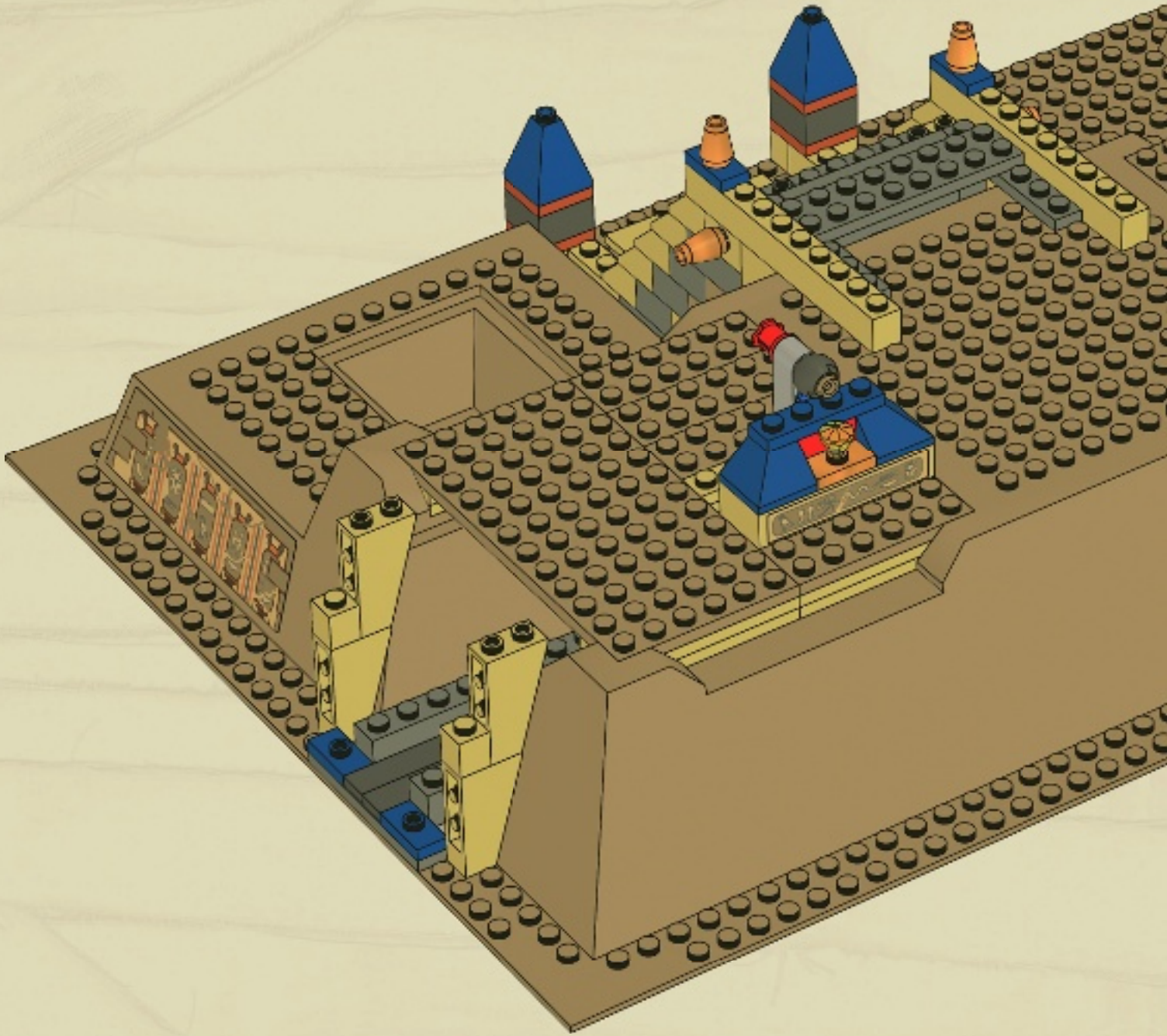

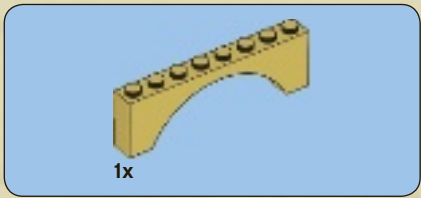

30

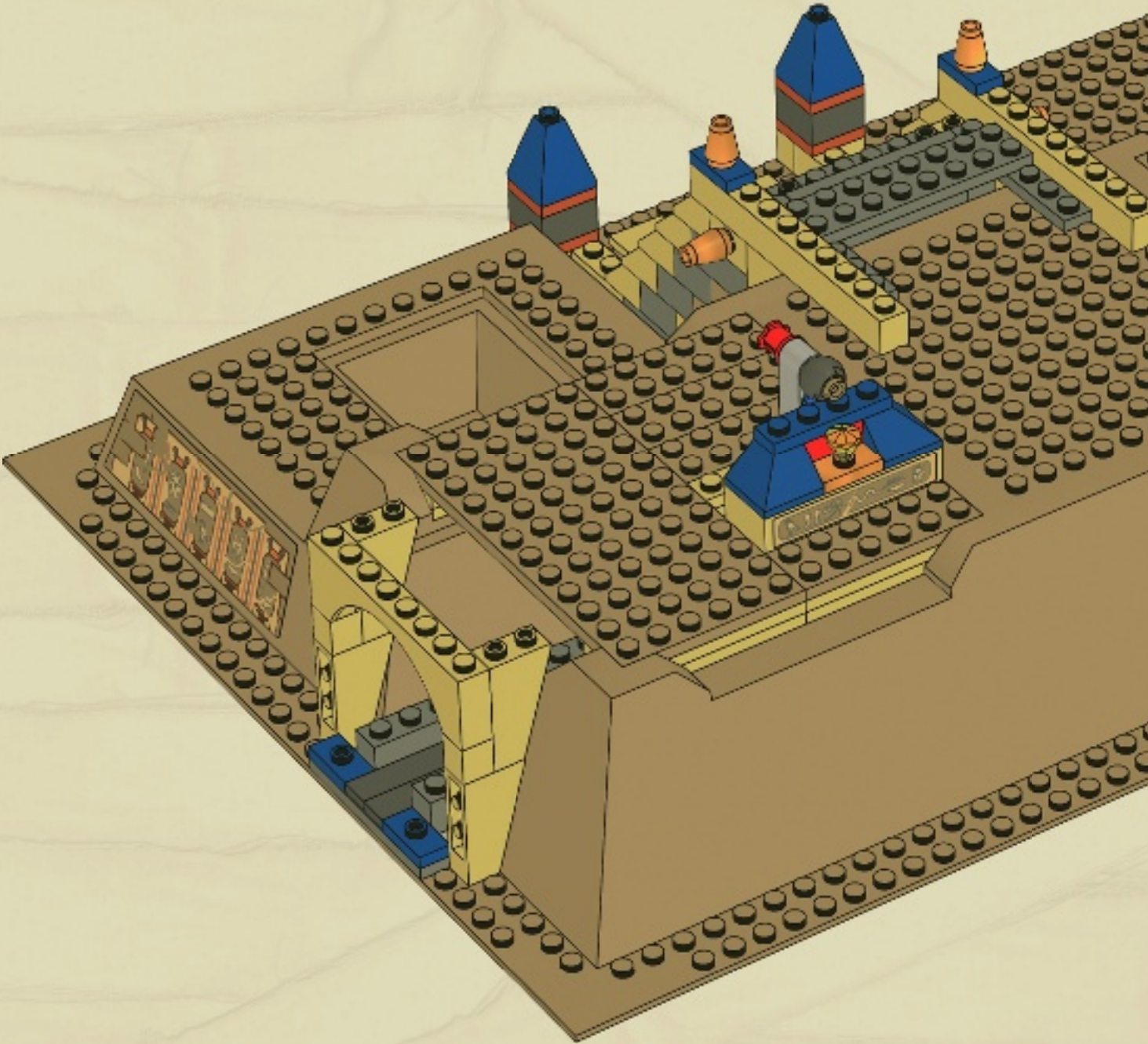

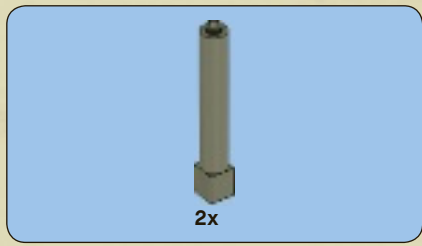

31

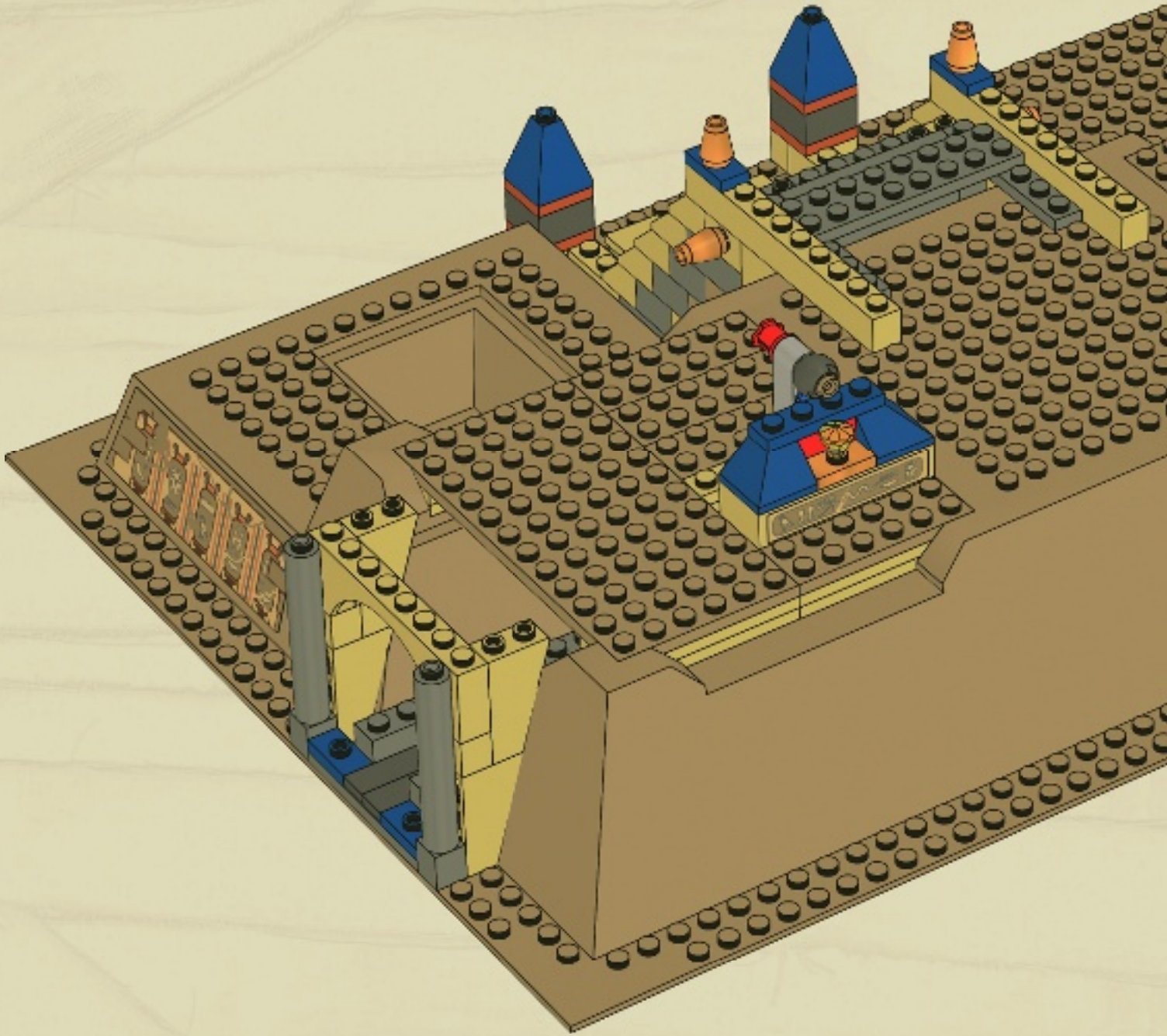

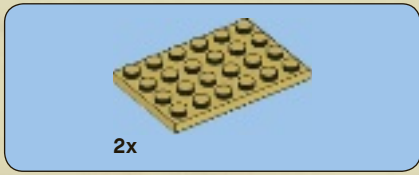

32

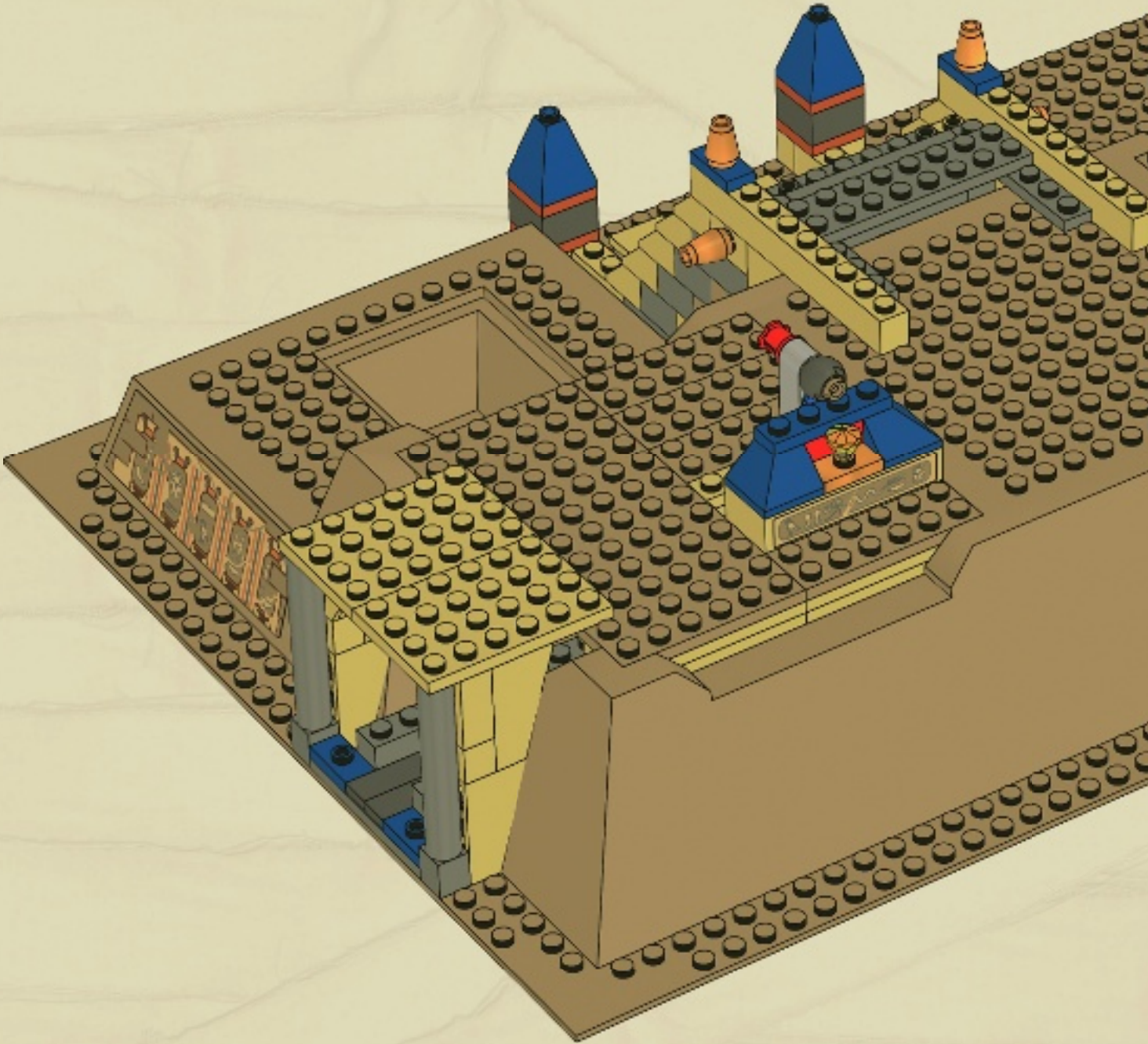

2x 1x 2x

33

2x

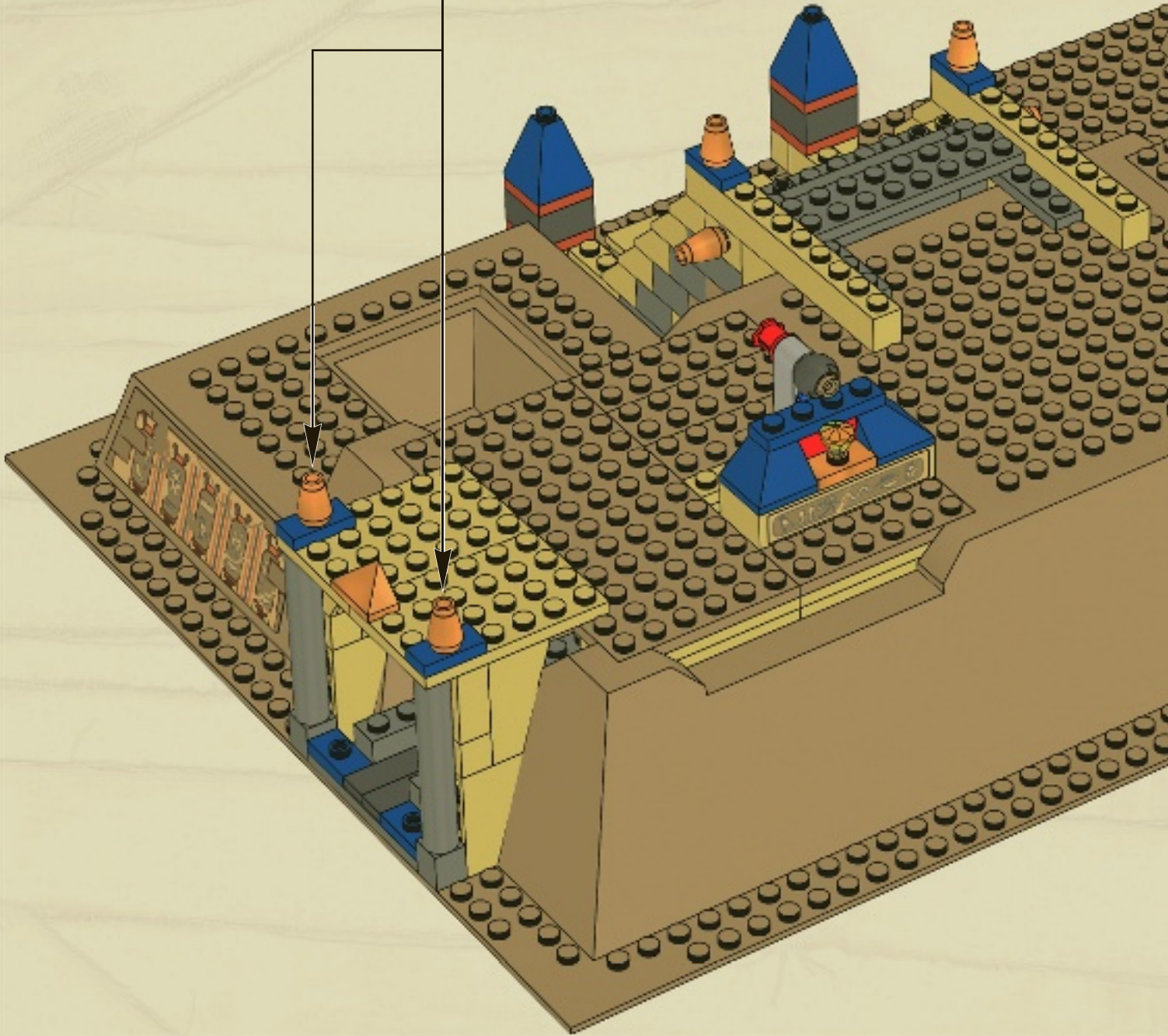

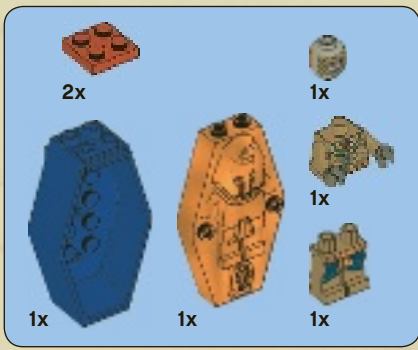

34

1

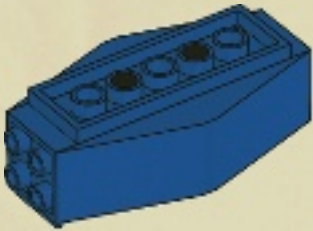

2

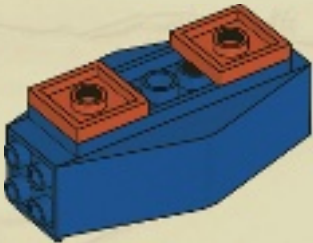

3

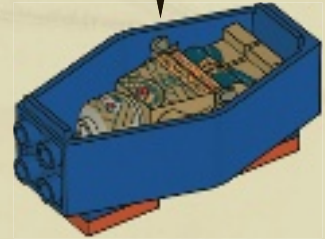
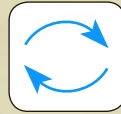

4

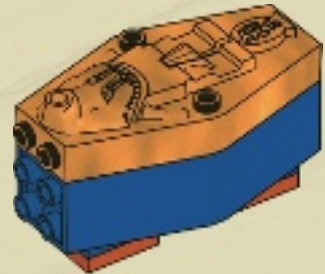

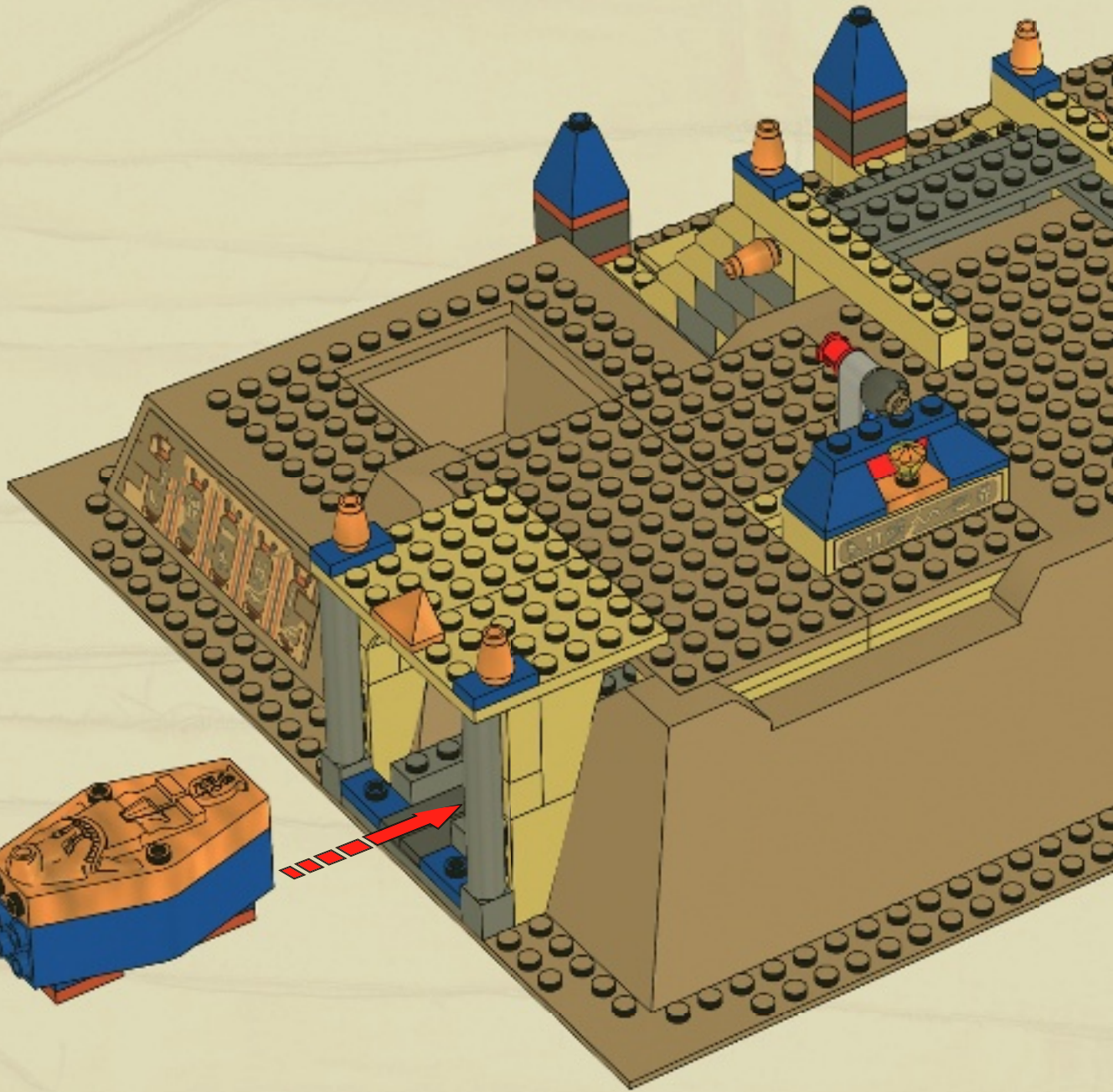



3

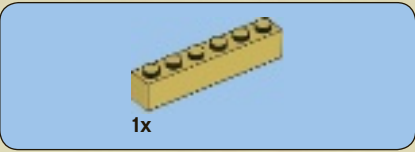
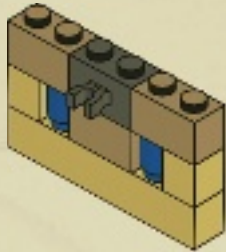

1

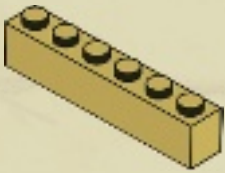

4

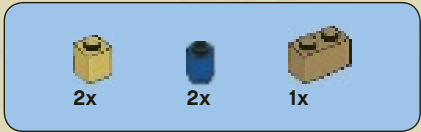
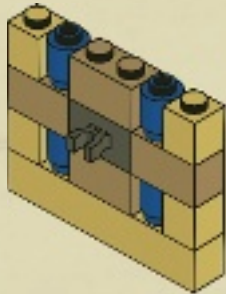

2

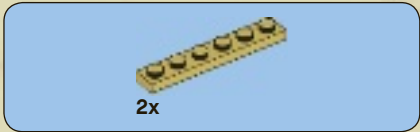
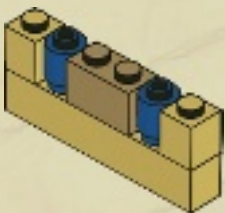

5

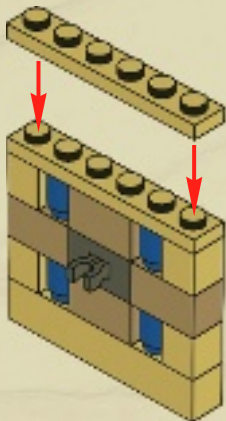

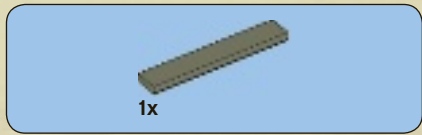

6

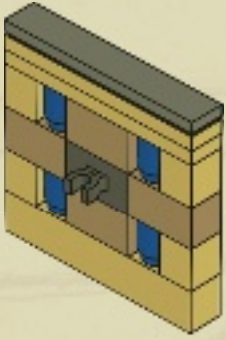

35

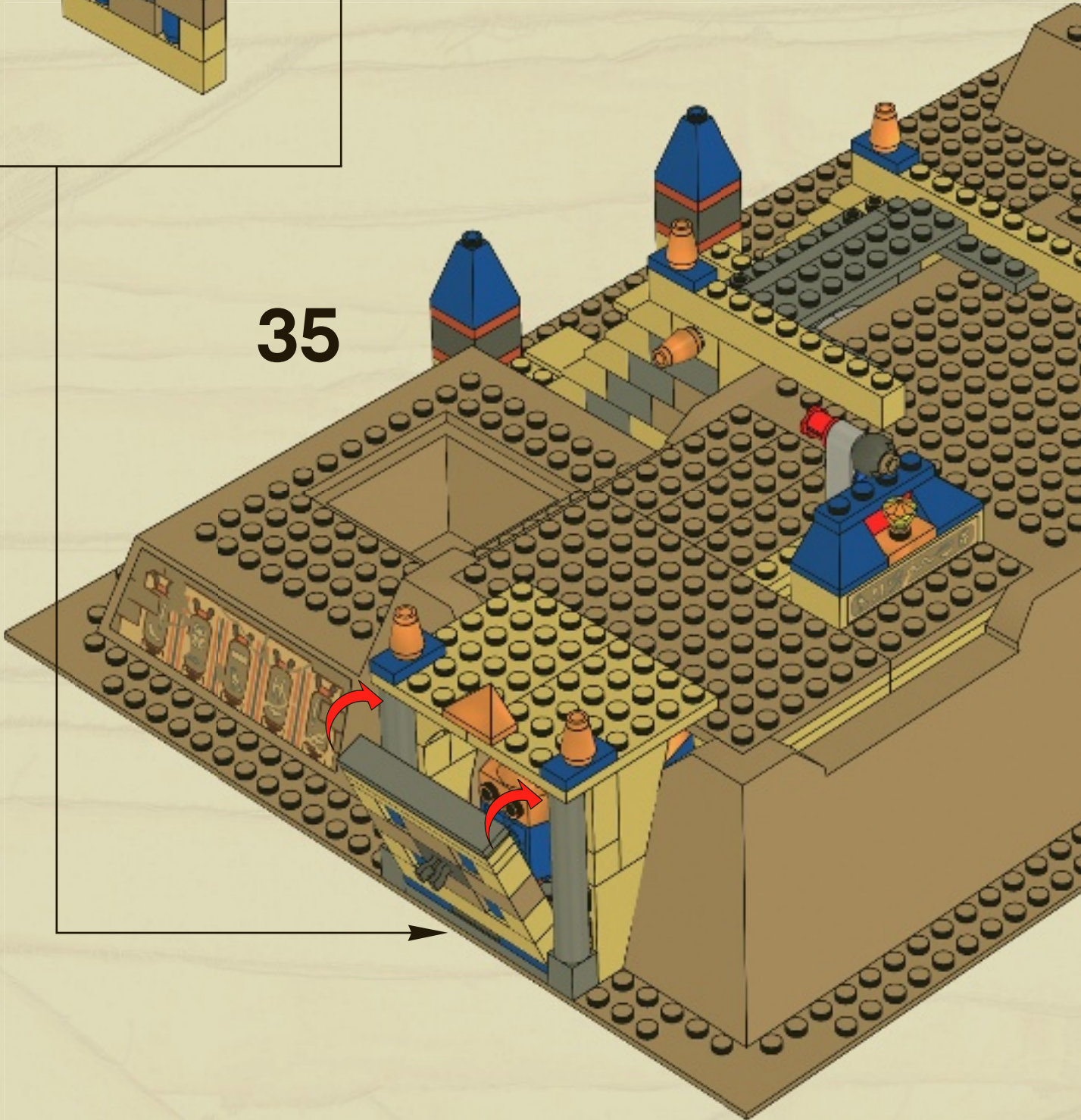

1

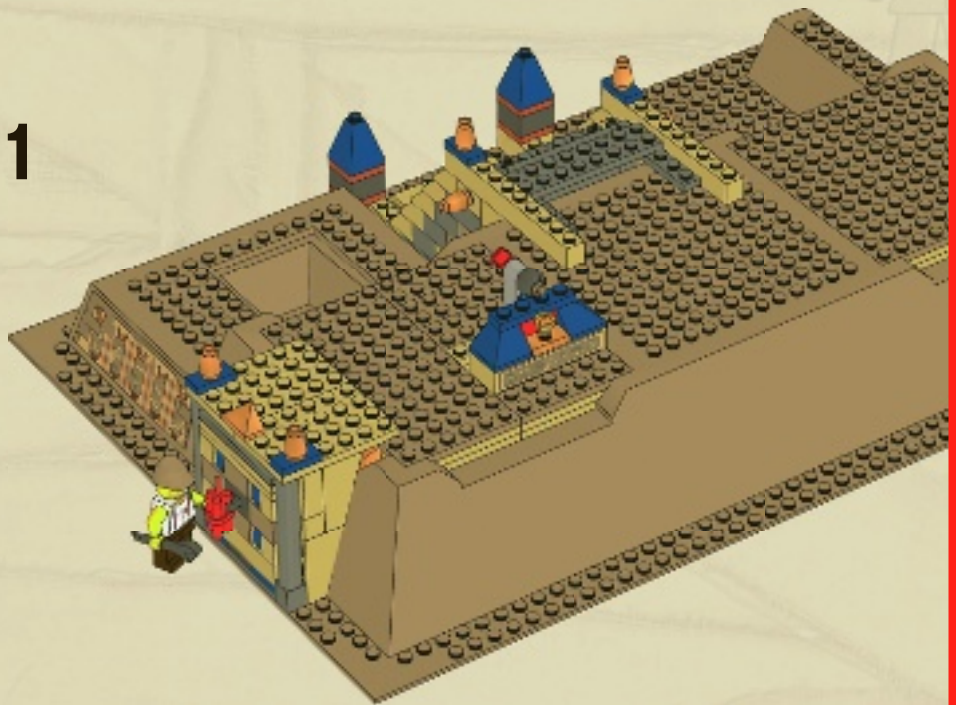

2

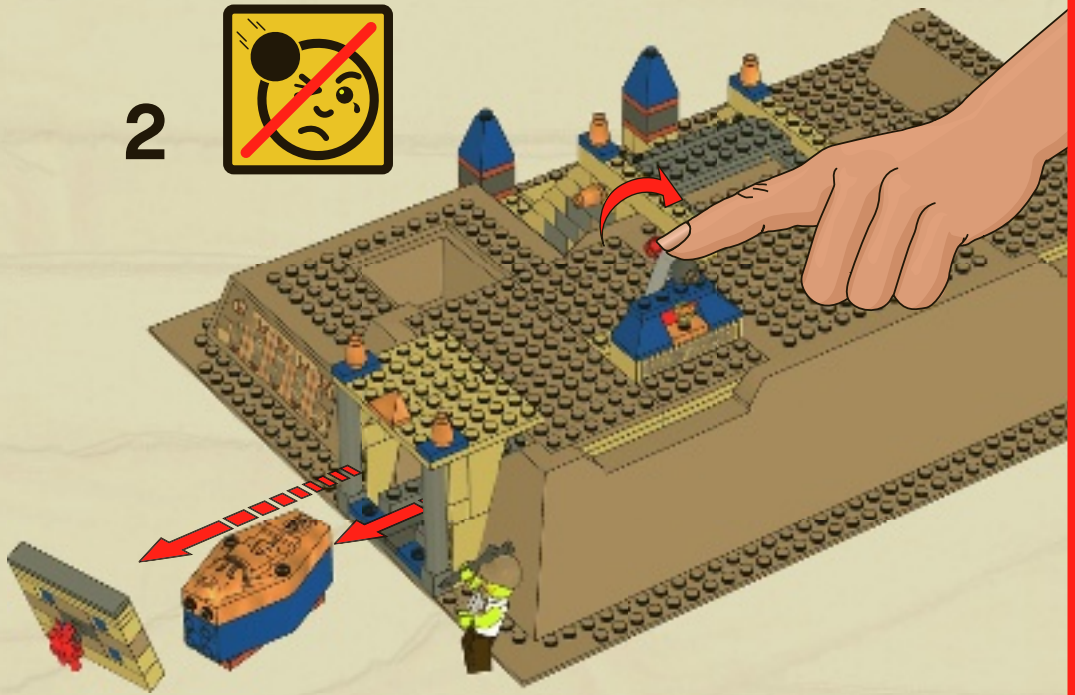



PHARAOH'S QUEST

