

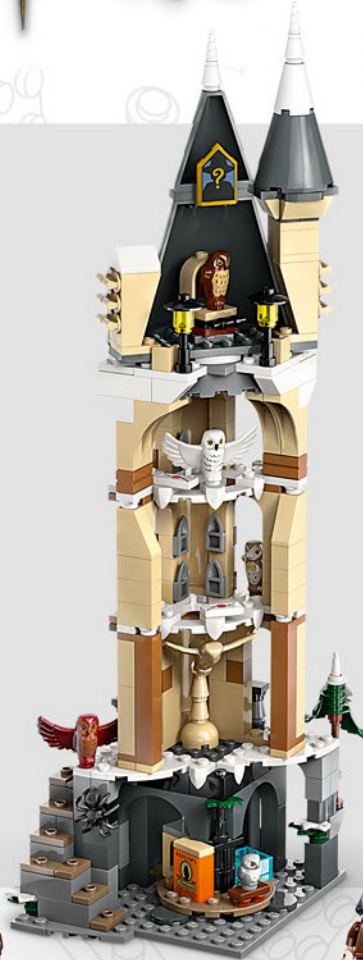

Harry Potter



76430



LEGO® Builder



Get excited about our new packaging!

We're switching from plastic to paper-based packaging. That's why you might find a mix of paper and plastic in our boxes!

Nos nouveaux emballages vous emballeront !

Nous passons des emballages en plastique aux emballages à base de papier. C'est pourquoi vous pourriez trouver un mélange de papier et de plastique dans nos boîtes !

¡Te presentamos nuestros nuevos empaques!

Estamos sustituyendo las bolsas de plástico por bolsas con base de papel. ¡Por eso, puedes encontrar una mezcla de papel y de plástico en nuestras cajas!

[LEGO.com/sustainable-packaging](https://www.lego.com/sustainable-packaging)

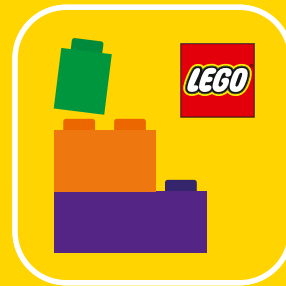

🔍 LEGO® Builder

BUILDER



Apple and the Apple logo are trademarks of Apple Inc., registered in the U.S. and other countries and regions. App Store is a service mark of Apple Inc. Google Play and the Google Play logo are trademarks of Google LLC. Tencent and the Tencent logo are trademarks of Tencent Inc.

🔍 LEGO.com/devicecheck

EN Ask parents' permission before going online | DE Eltern um Erlaubnis bitten, bevor du online gehst | FR Demande l'autorisation d'un parent avant d'aller en ligne | IT Chiedi il permesso ai tuoi genitori prima di andare online | ES Pídeles permiso a tus papás antes de conectarte a Internet | PT Pede autorização aos pais antes de acederes online | ZH 上网前应先征得父母的同意 | PL Poproś rodziców o zgodę, zanim wejdiesz do Internetu | CS Než půjdeš na internet, požádej rodiče o svolení | SK Skôr než pôjdeš na internet, vypýtaj si povolenie od rodičov | HU Kérj szülői engedélyt, mielőtt online csatlakoznál! | RO Cere permisiunea părinților înainte de a te conecta online | BG Поискайте разрешение от родител, преди да влезете онлайн | LV Pirms došanās tiešsaistē palūdz atļauju vecākiem | ET Enne Interneti kasutamist küsi vanematelt luba | LT Prieš prisijungdami prie interneto, atsklauskite tėvų

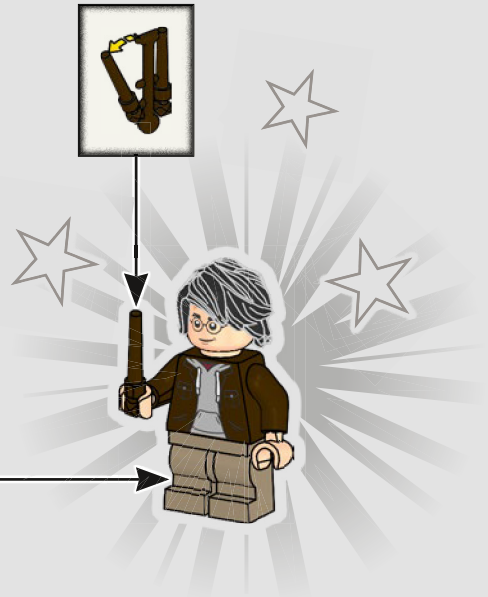
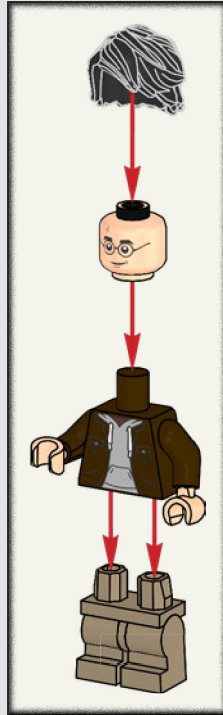

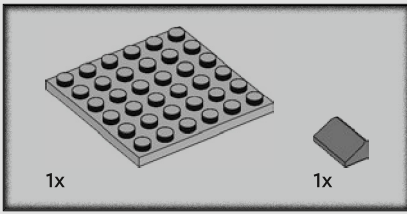

1

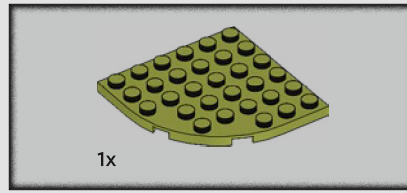
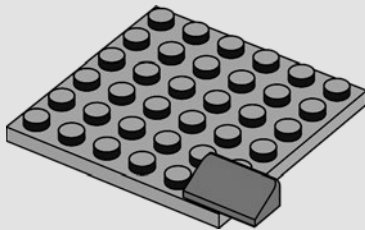

2

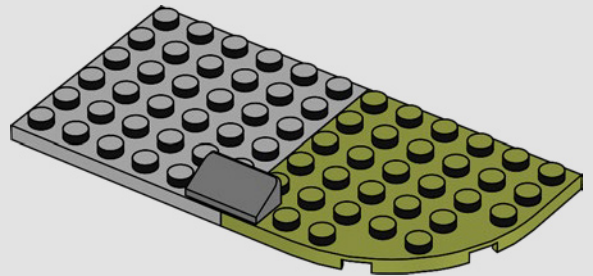

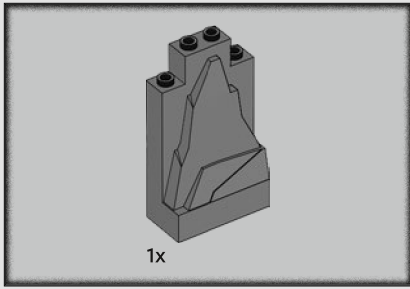

3

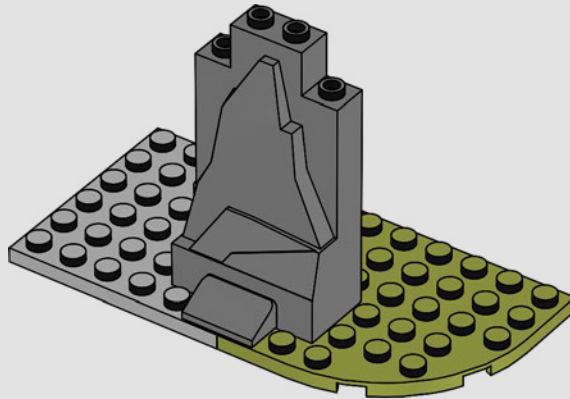

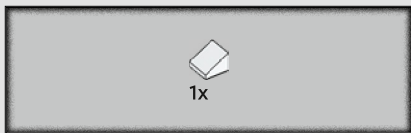

4

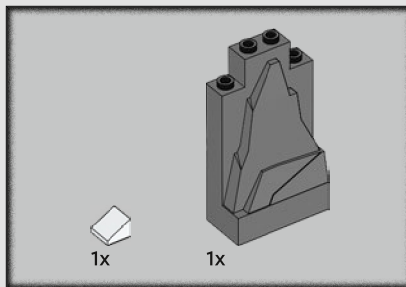
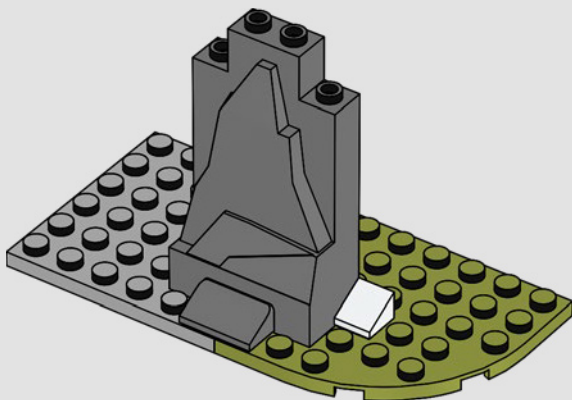

5

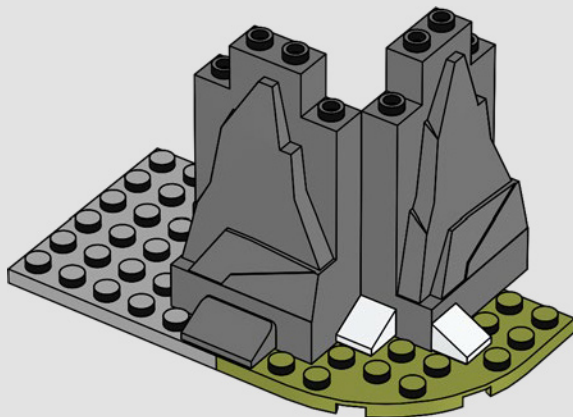

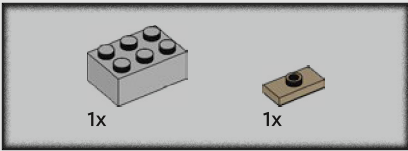

6

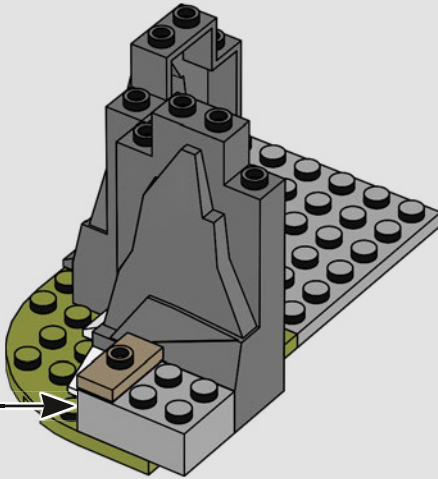
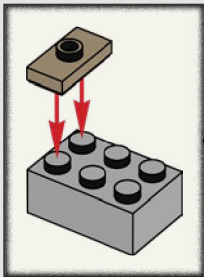

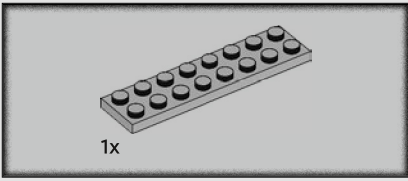

7

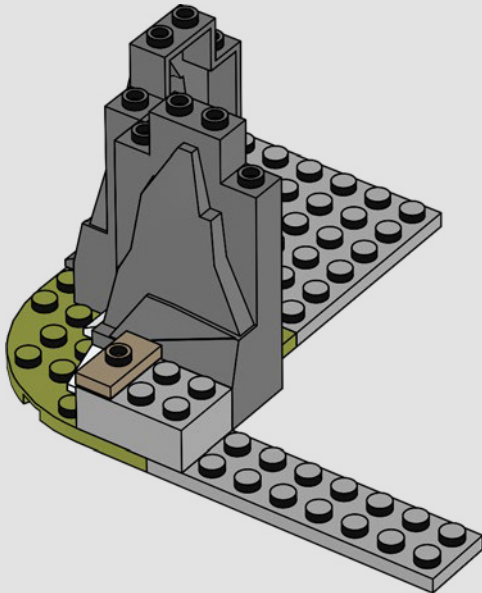

8

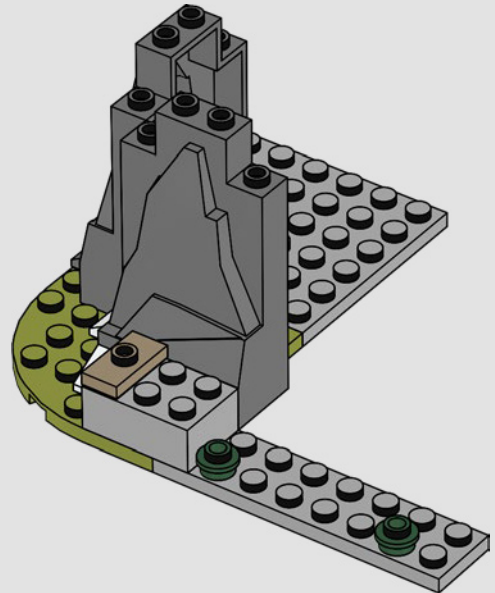

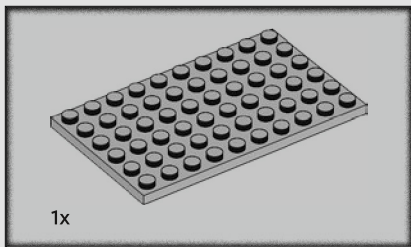

9

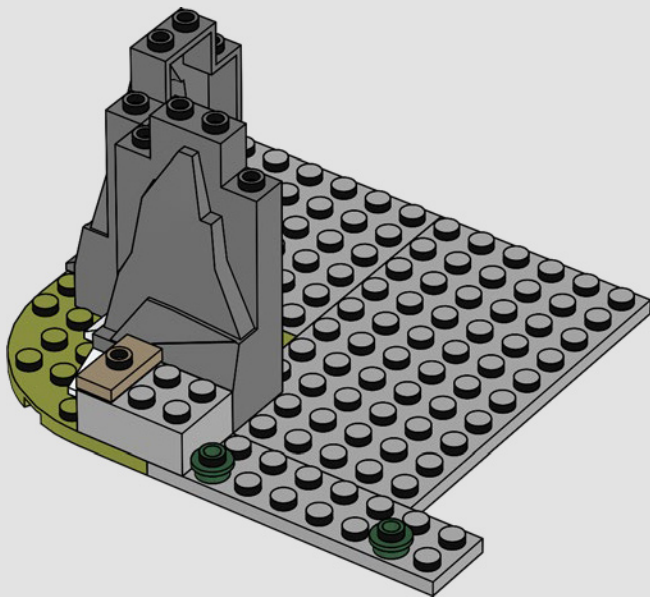

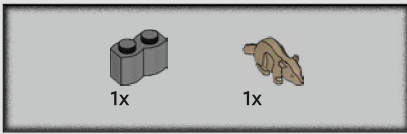

10

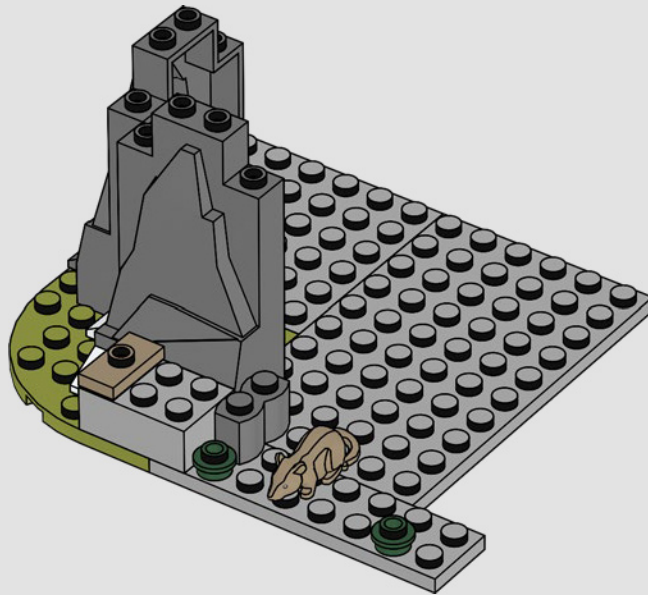

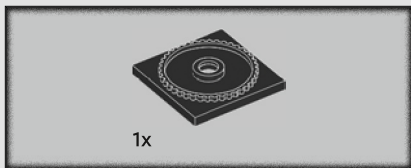

11



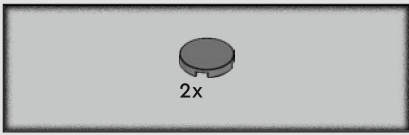

12



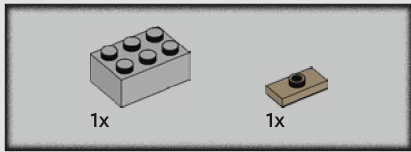

13

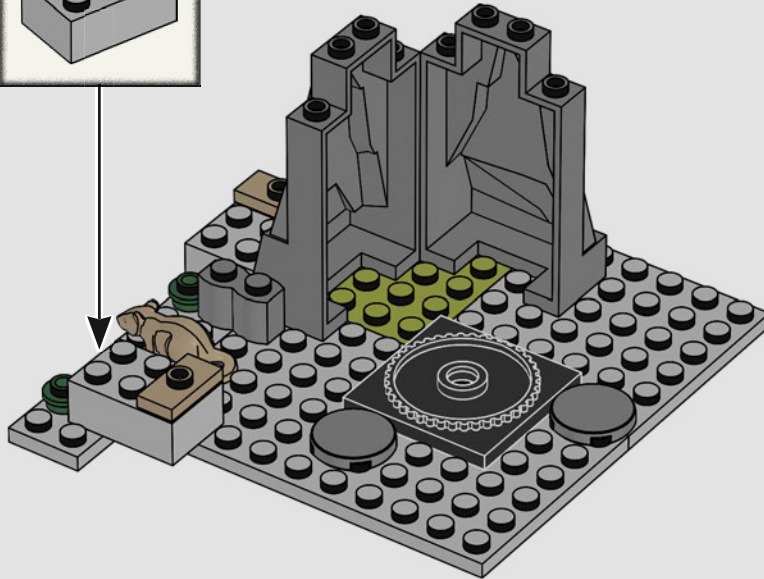
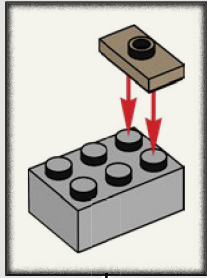

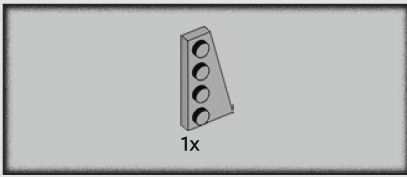

14

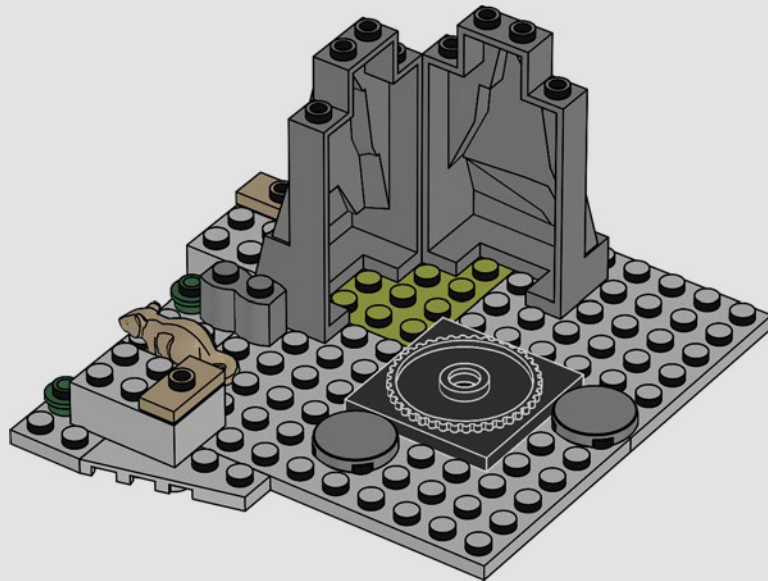

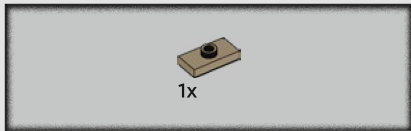

15

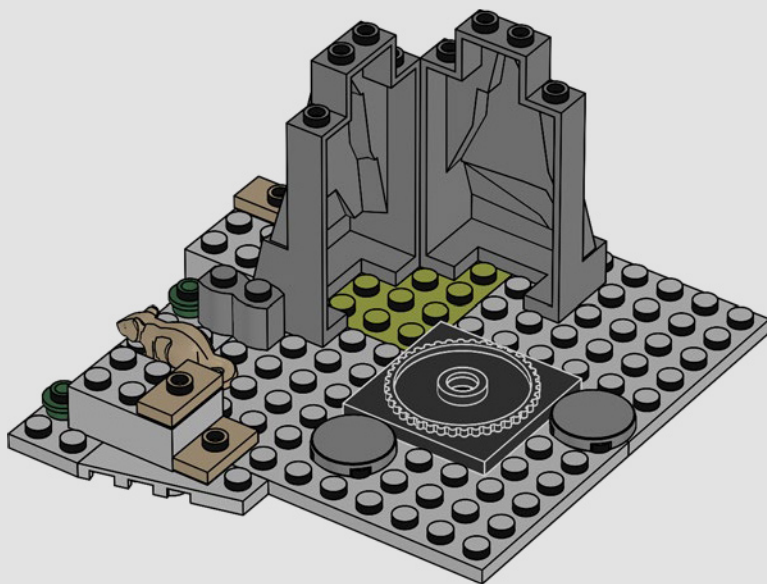

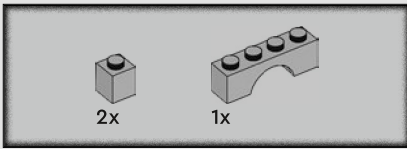

16

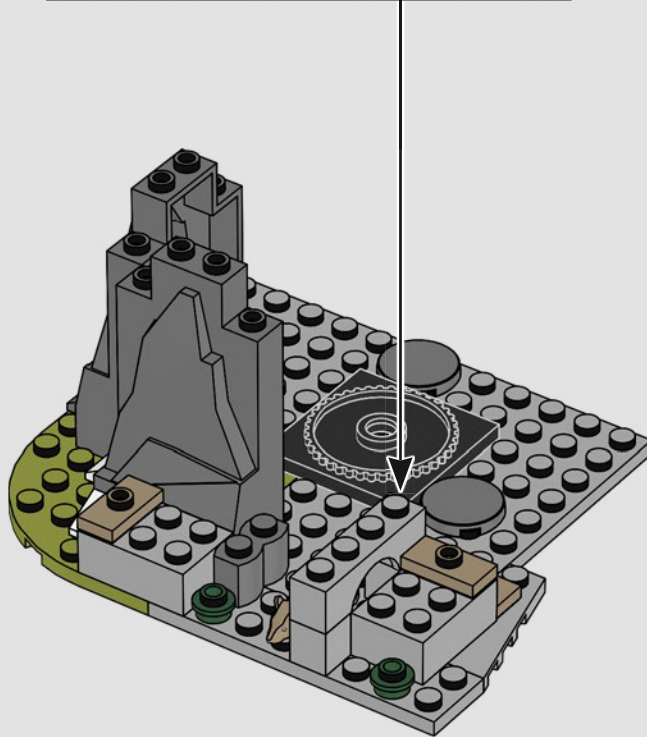
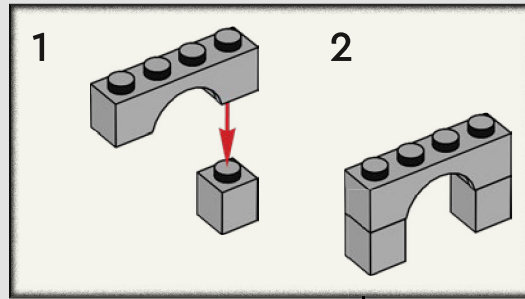



17

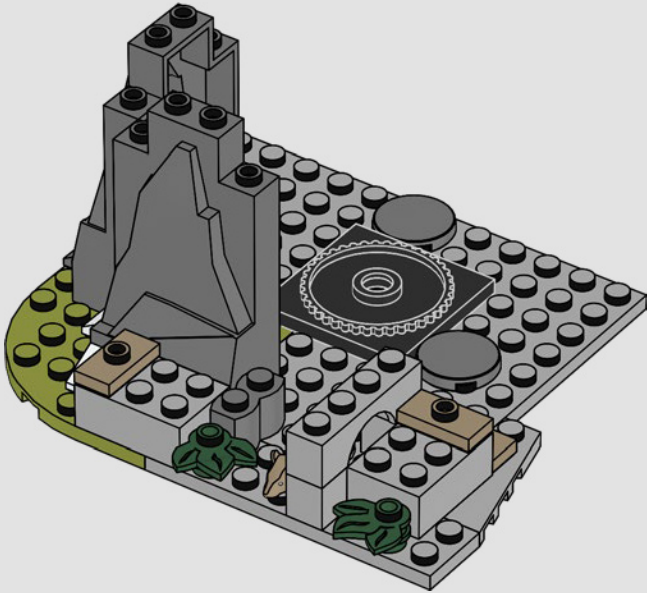



2x

18

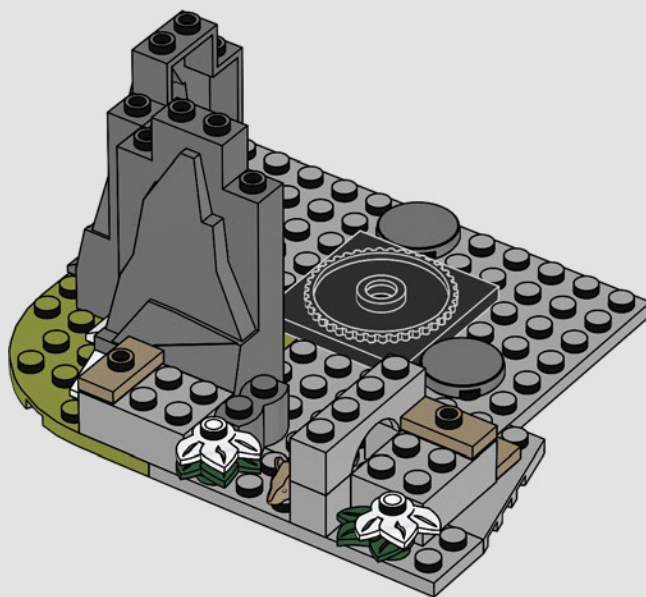

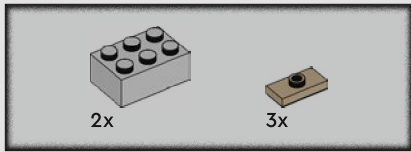

19

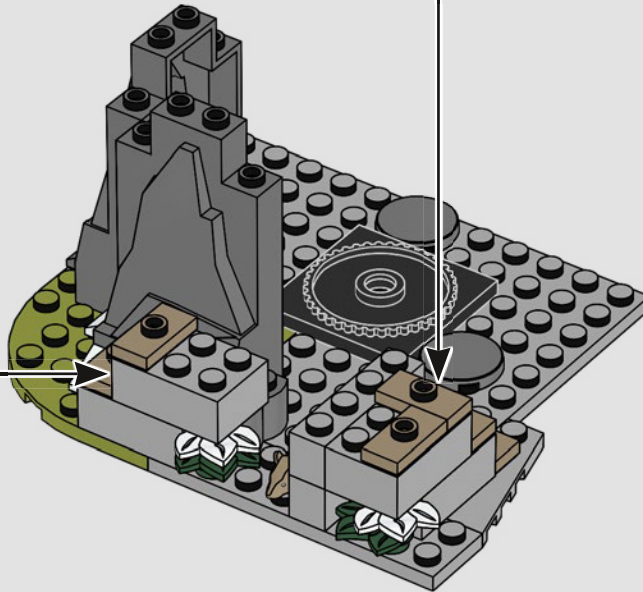
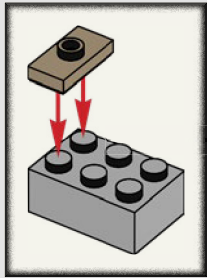
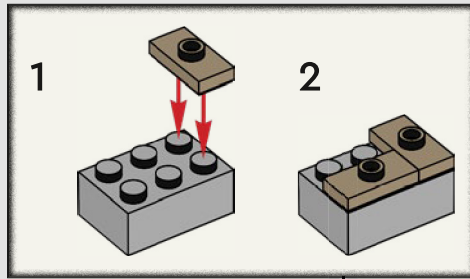

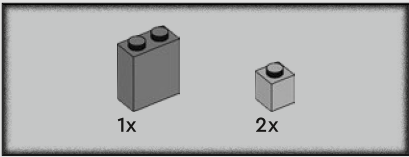

20

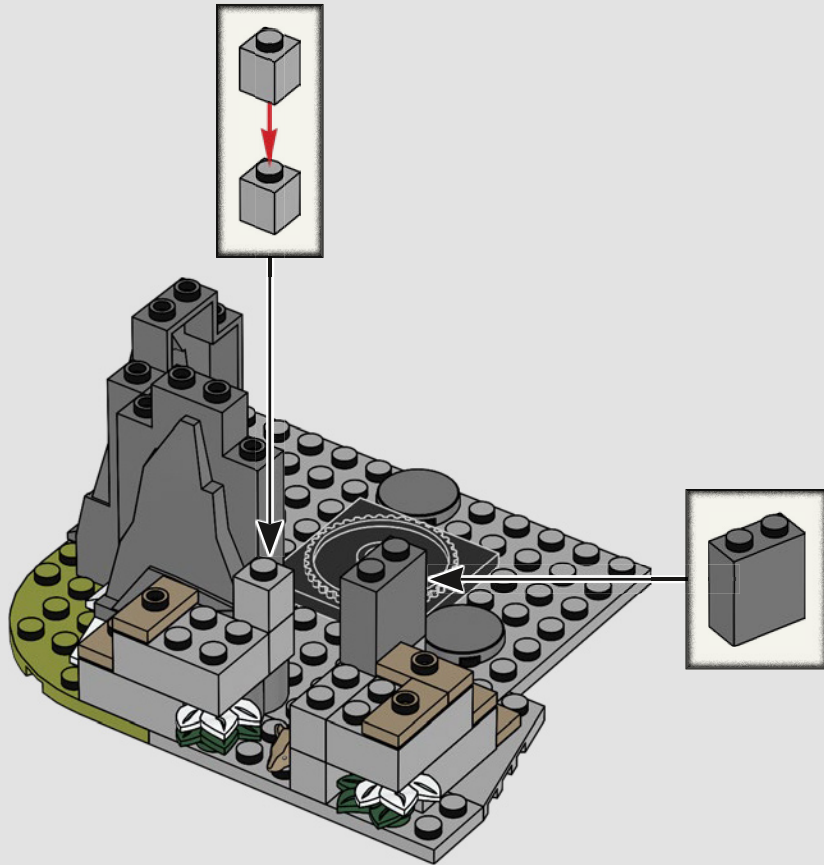

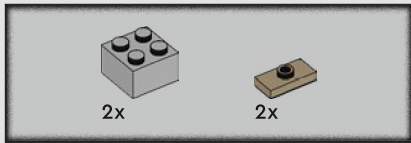

21

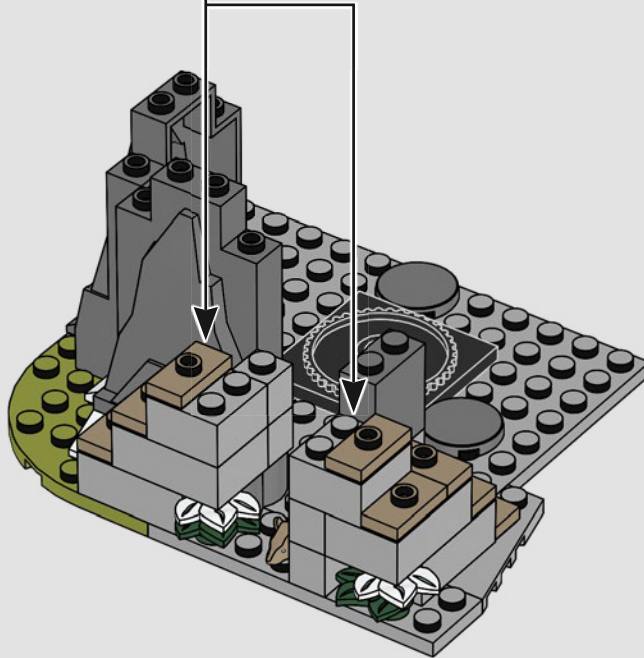
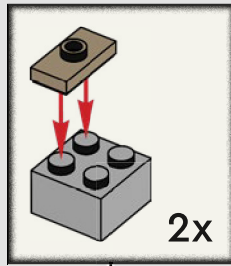

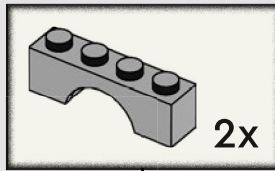
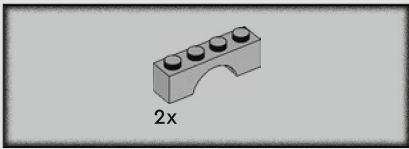

22

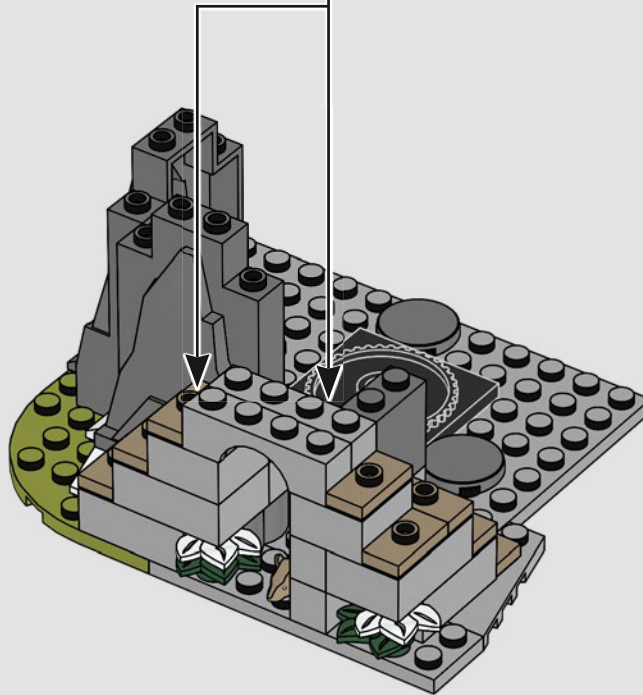

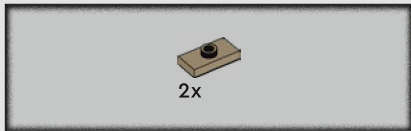

23

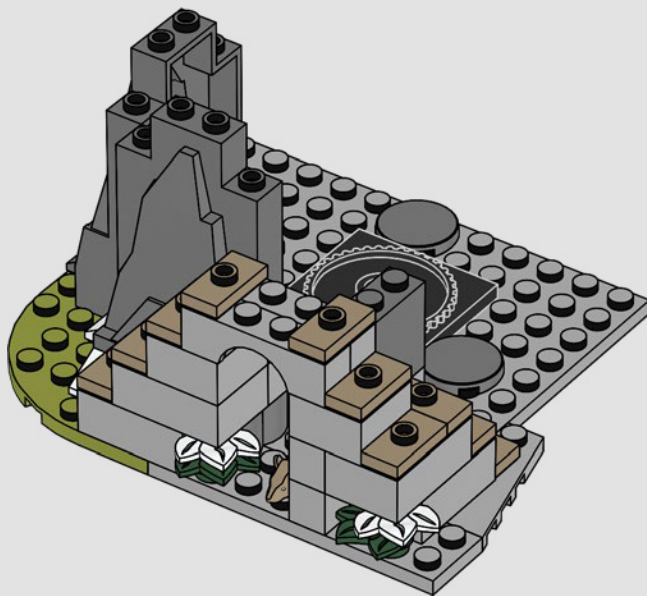

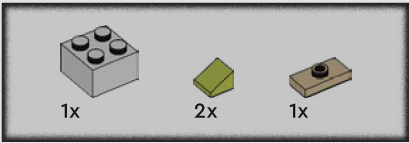

24

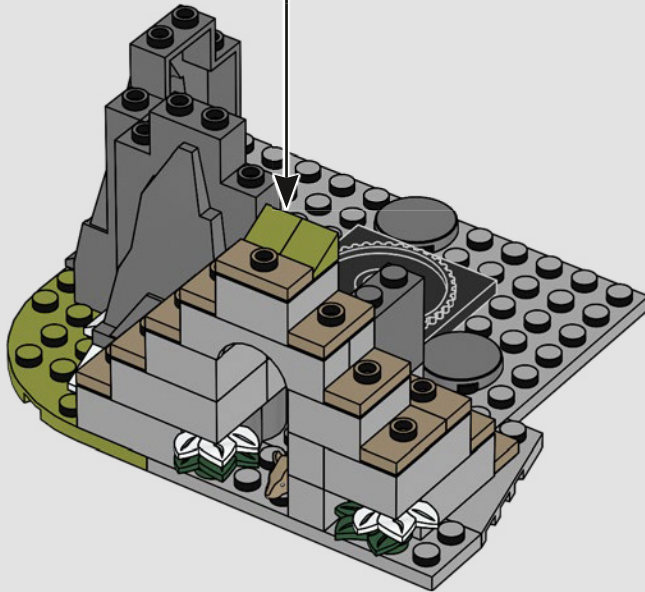
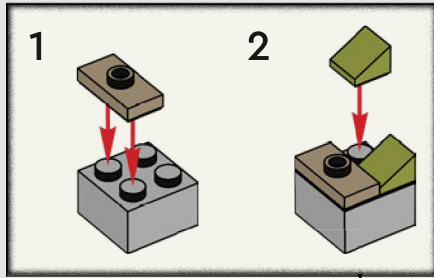

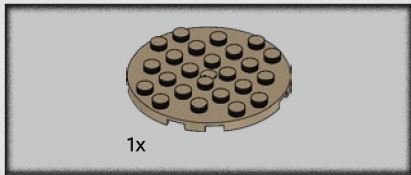

25

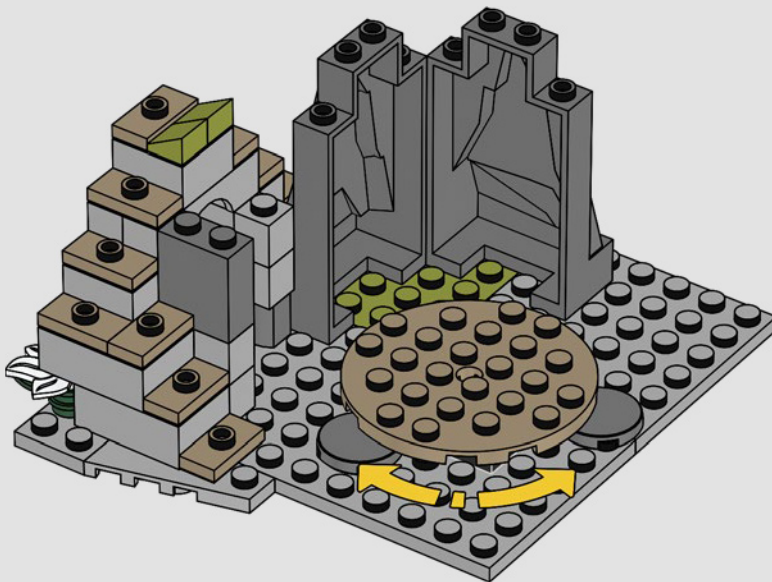

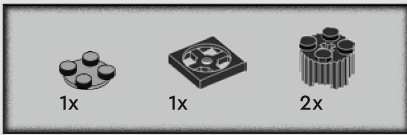

26

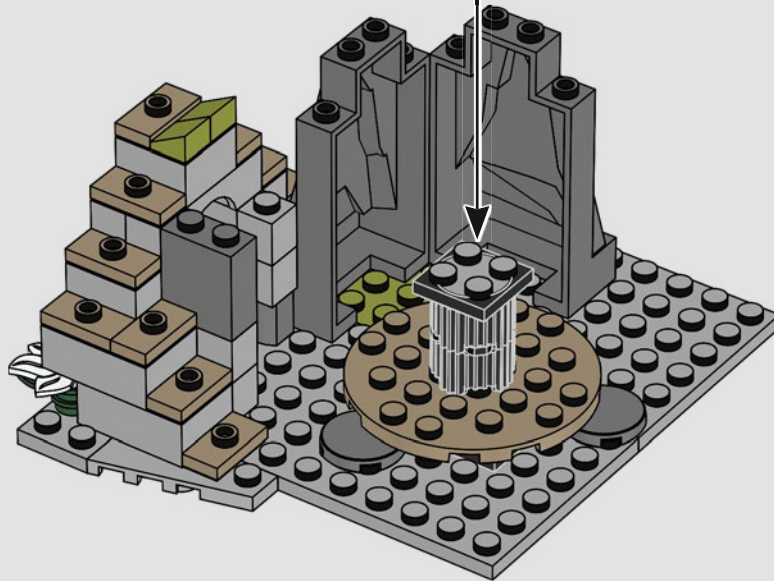
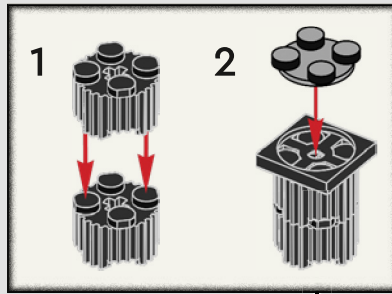

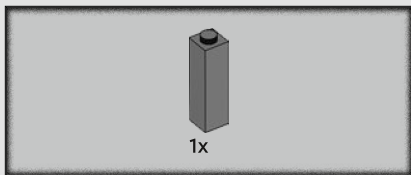

27

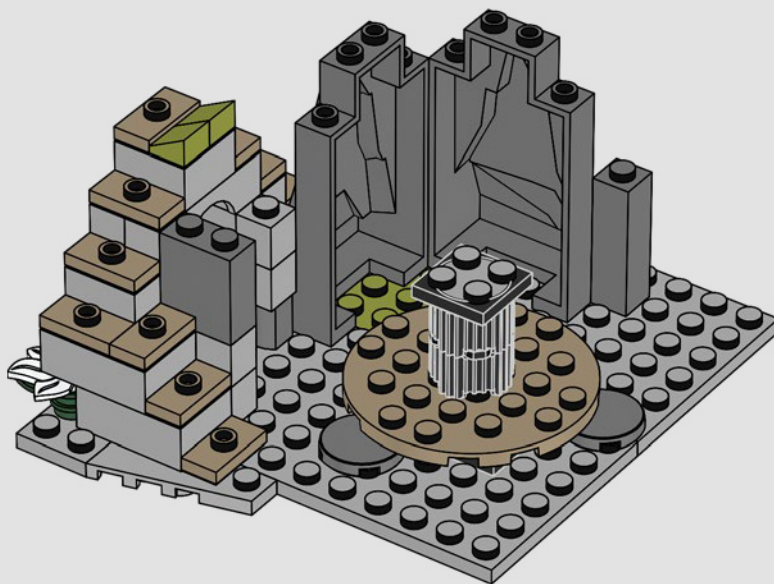

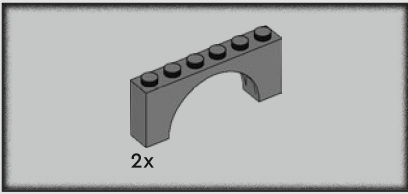

28

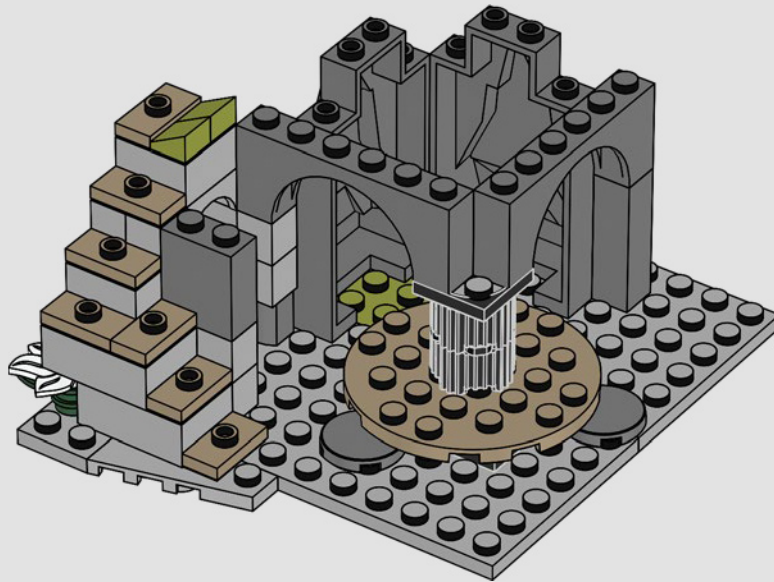



29

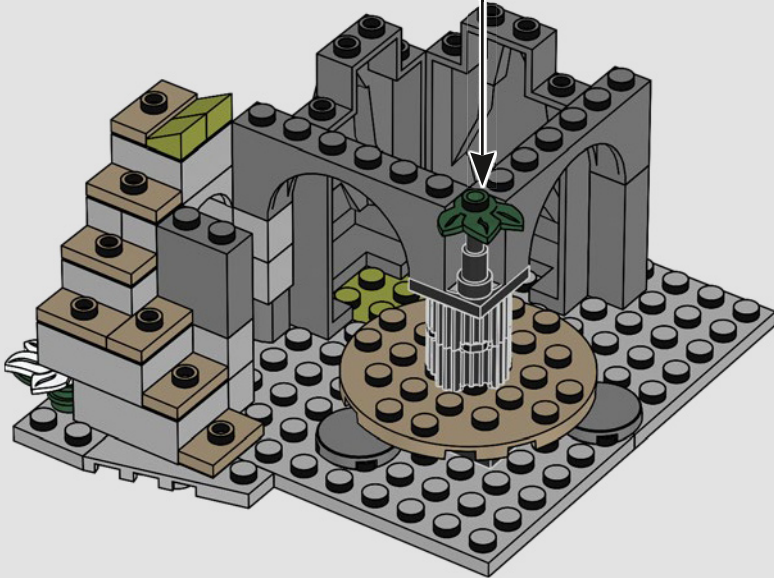
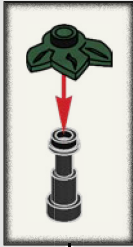

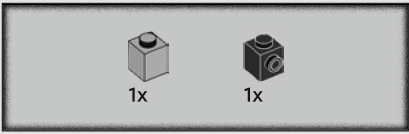

30

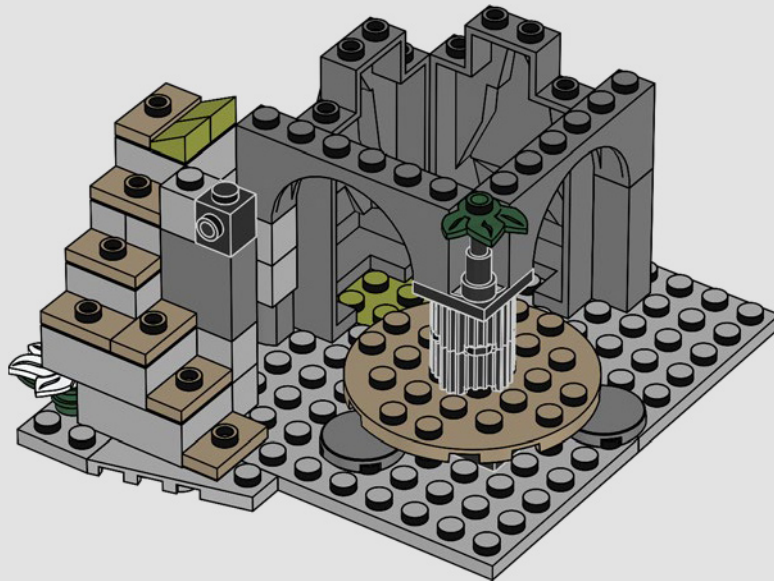

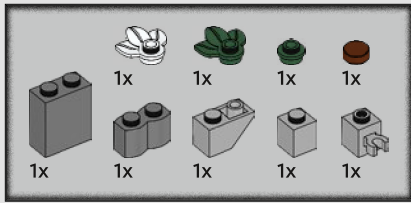

31

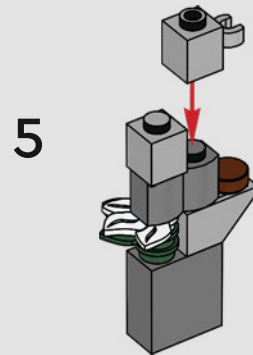
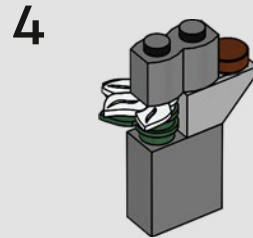
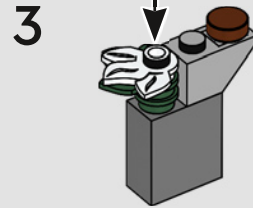
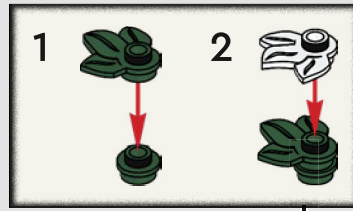
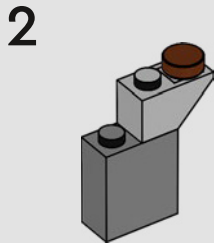
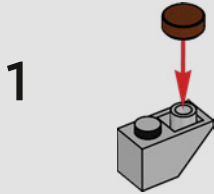

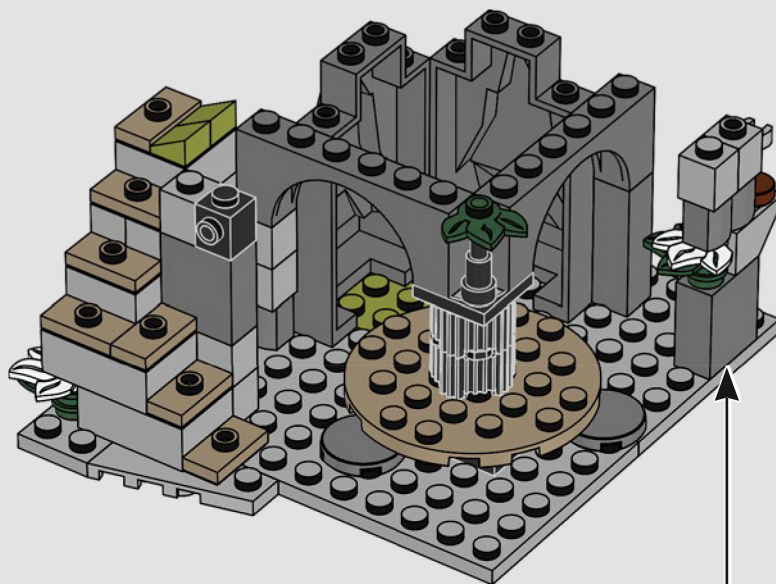

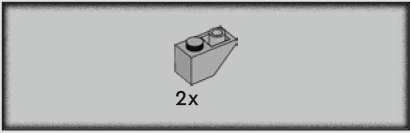

32

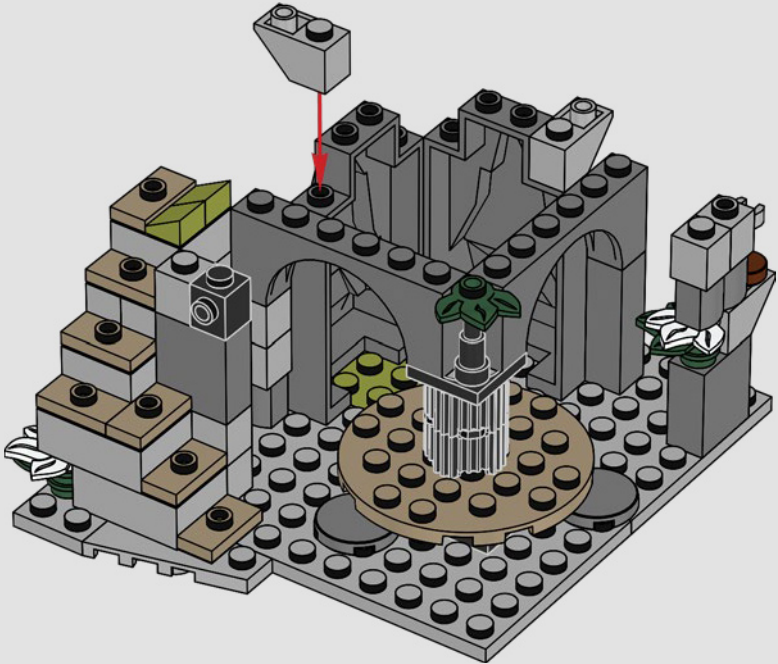

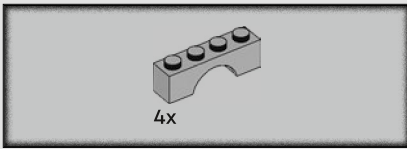

33

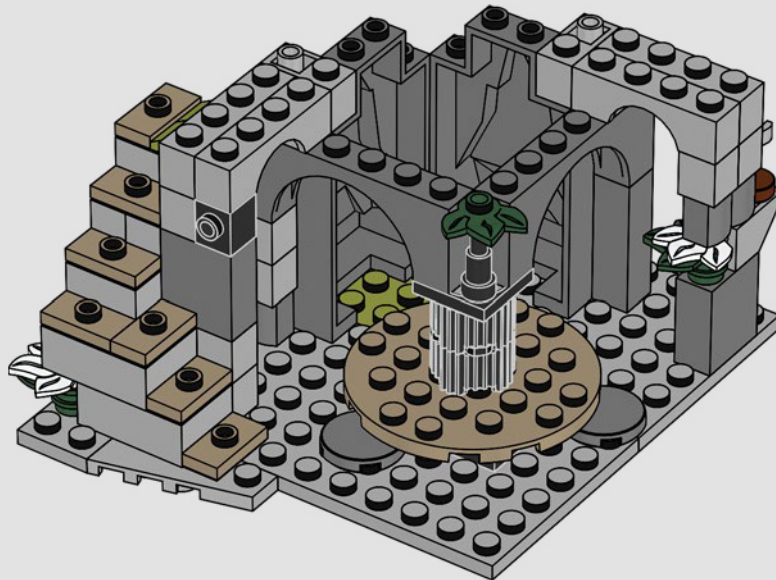

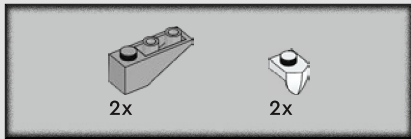

34

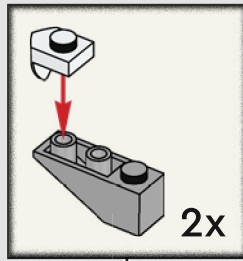

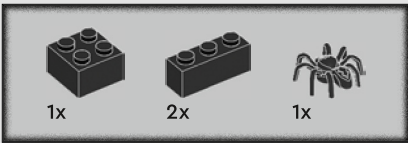

35

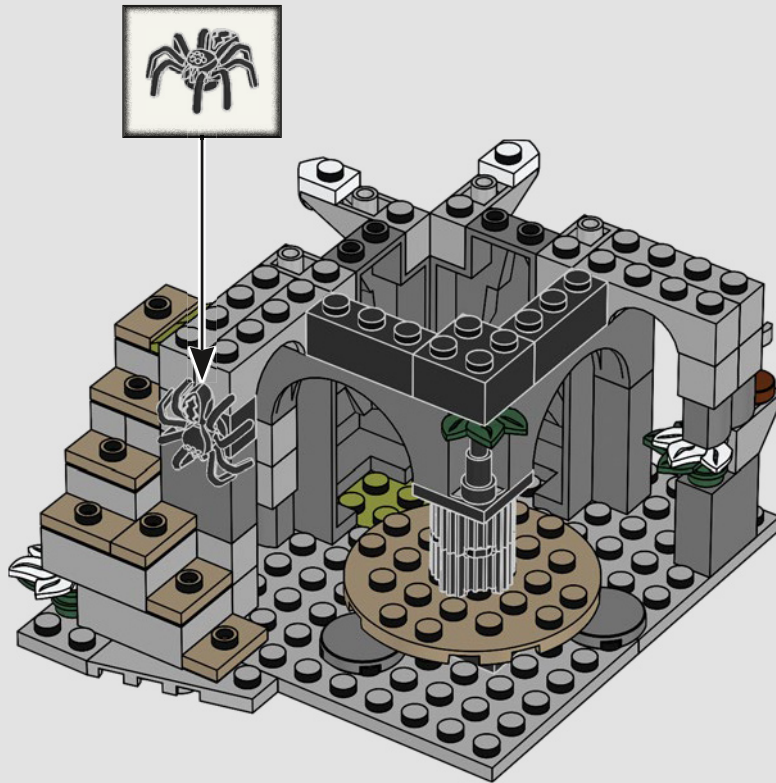

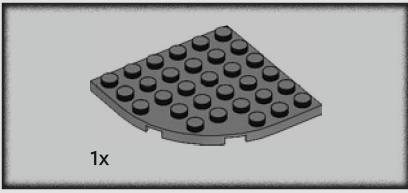

36



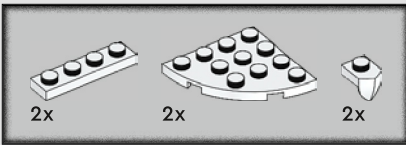

37

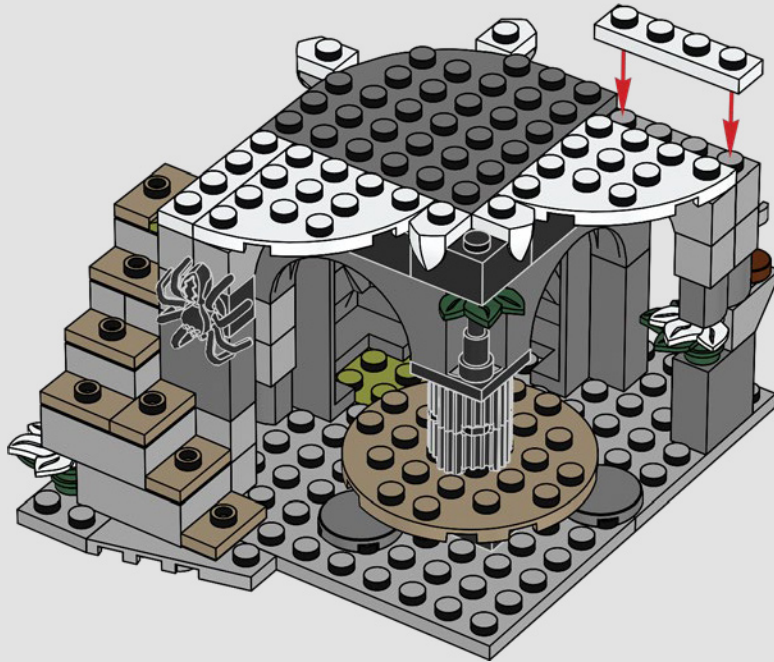

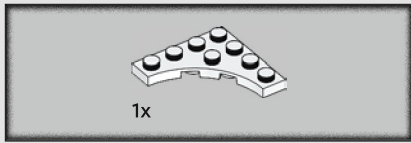

38

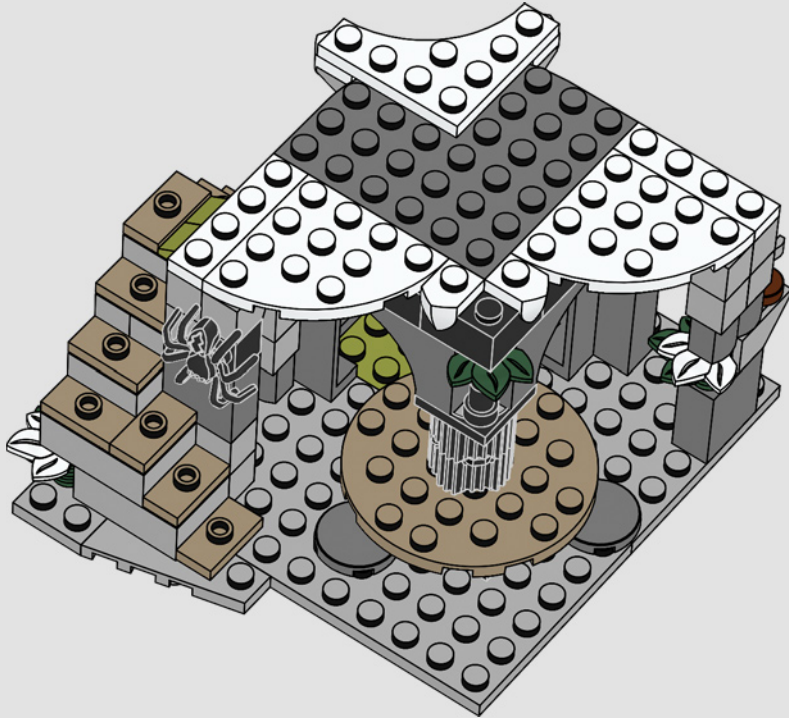

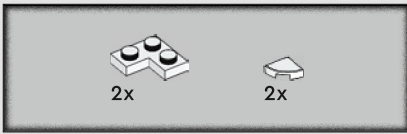

39

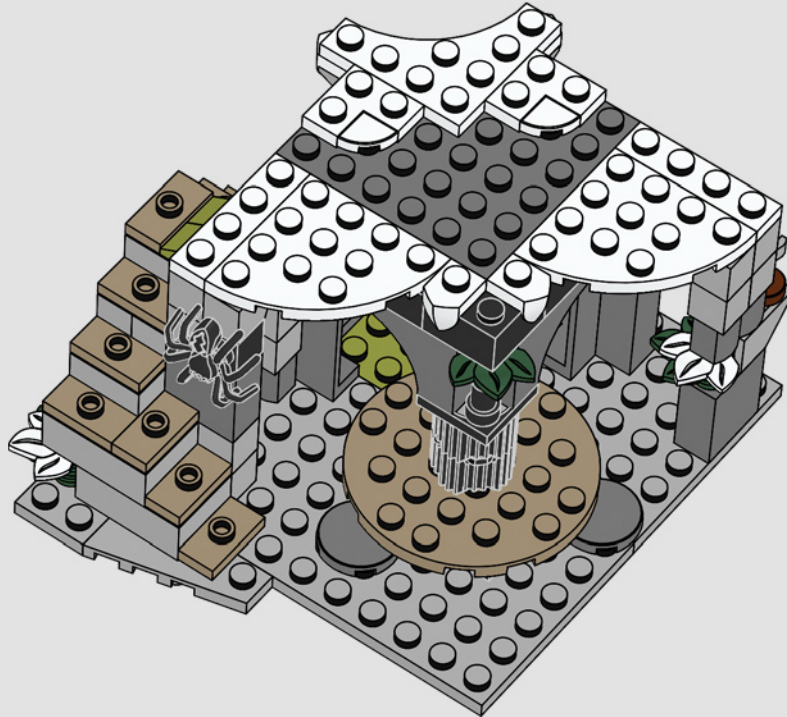



40

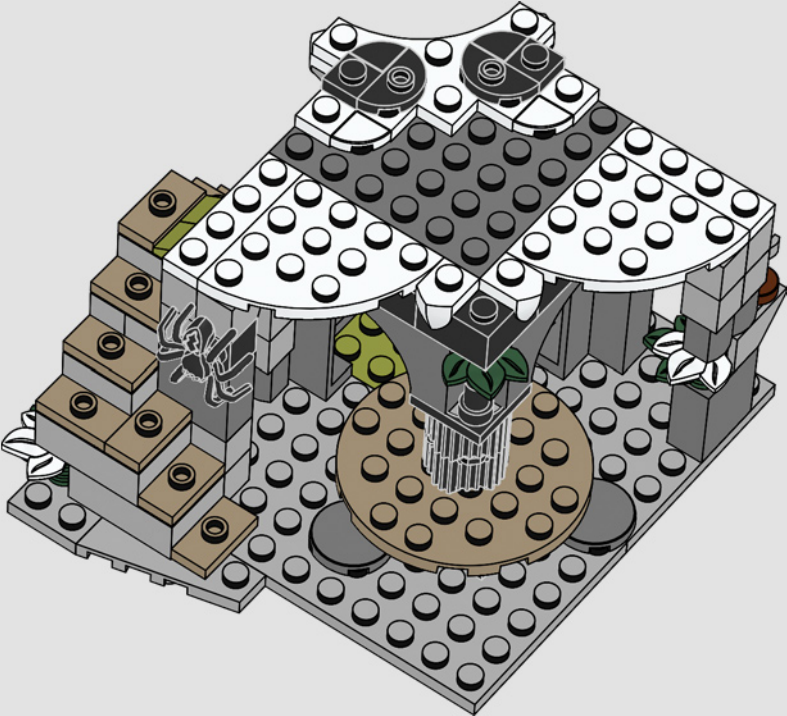



2x



1x

41

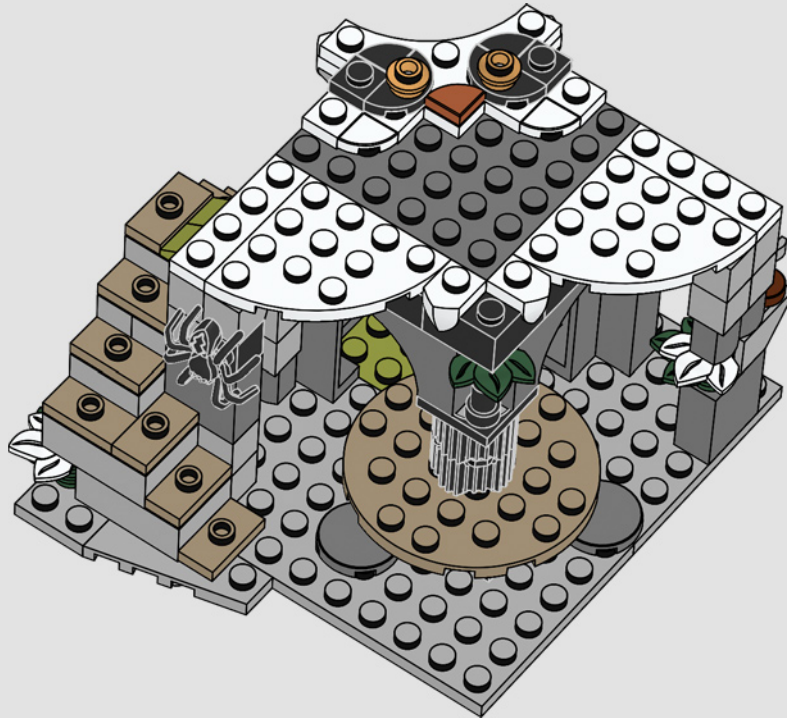



1

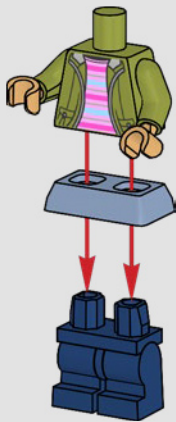

2

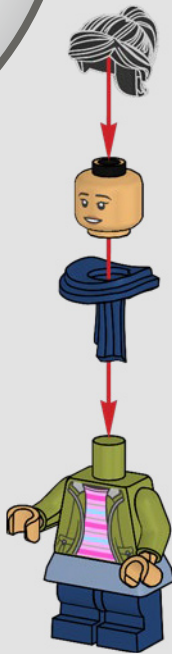

3



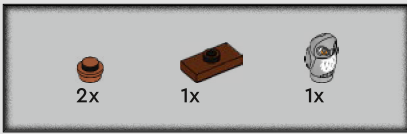

42

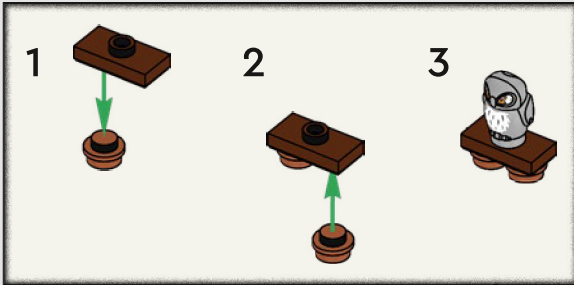



2x

43

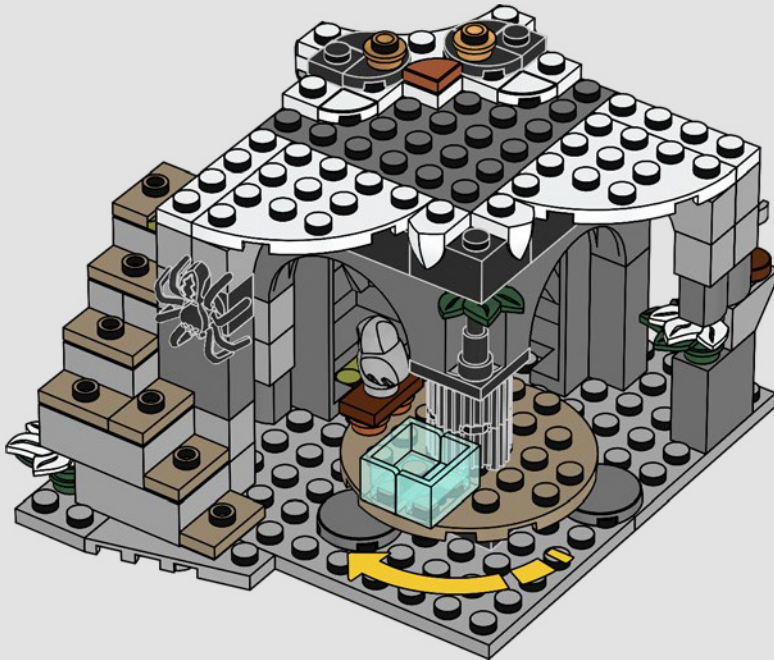

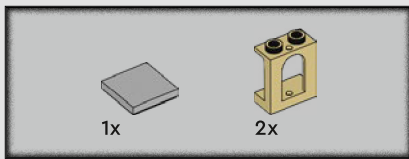

44

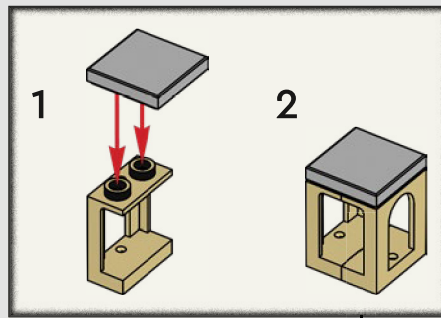

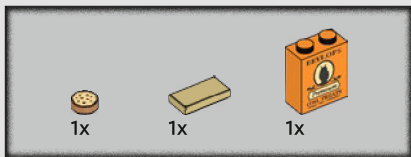

45



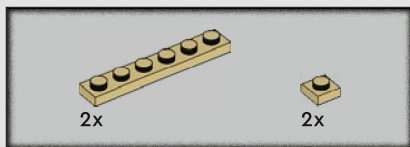

46

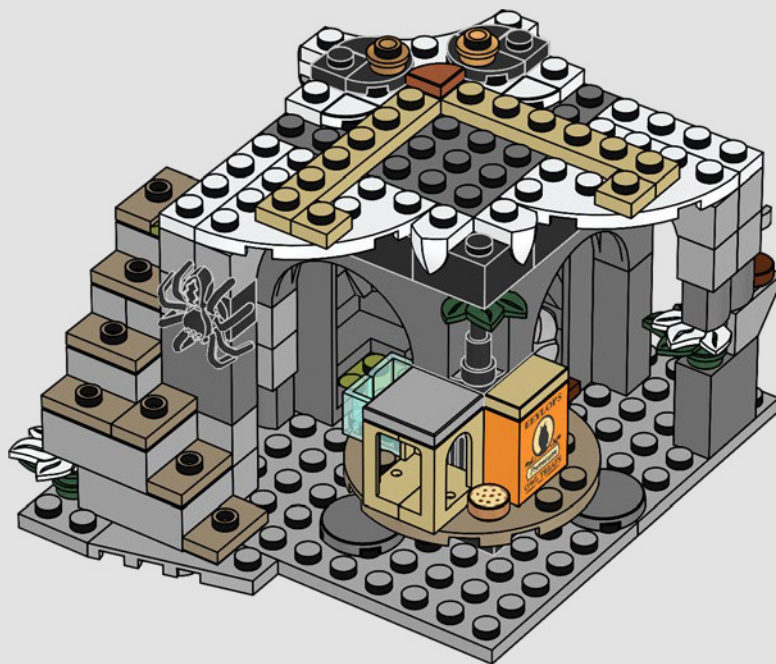



2x



2x

47

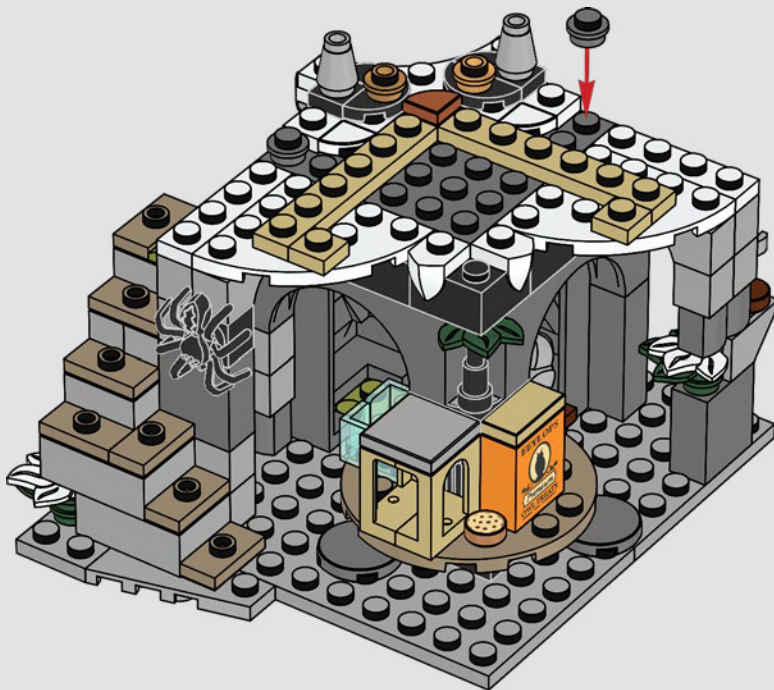

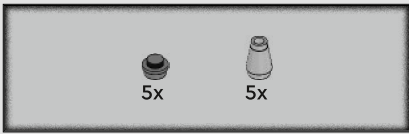

48

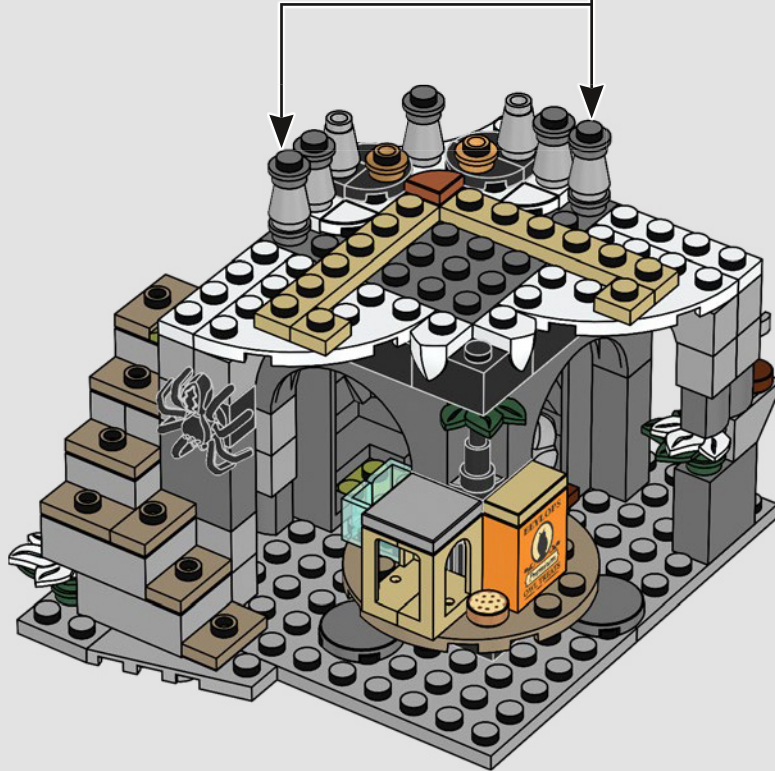
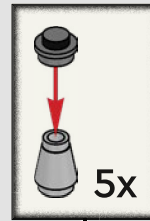

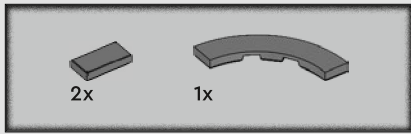

49

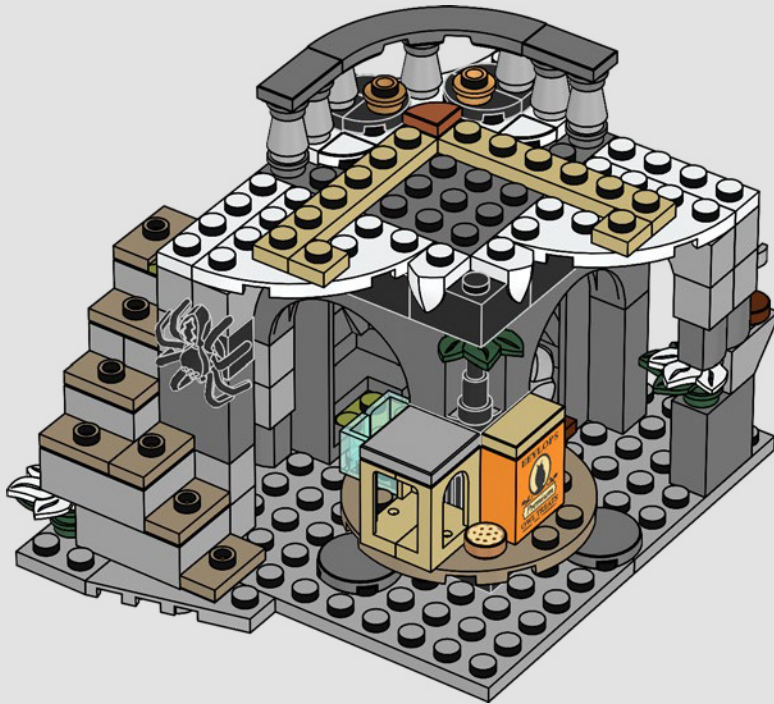

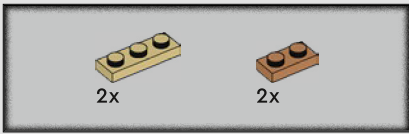

50

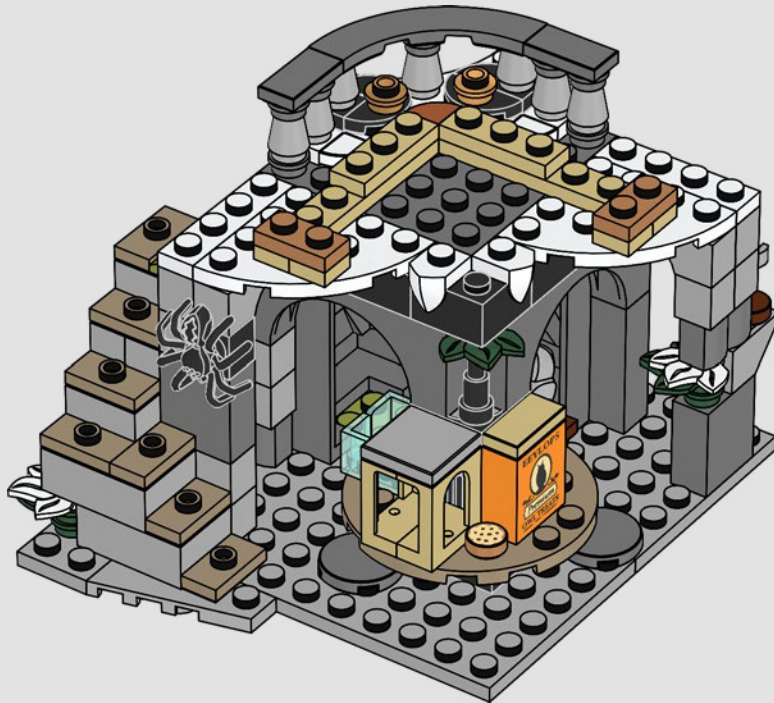



51

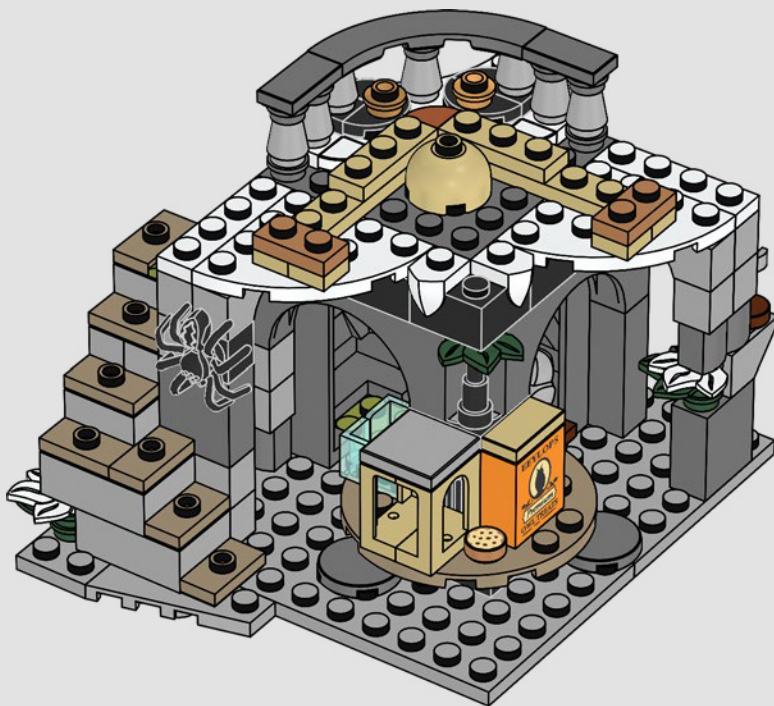

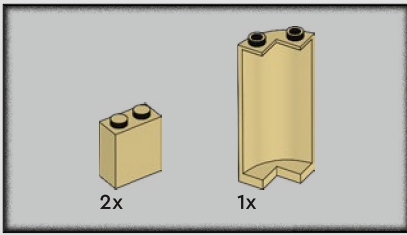

52

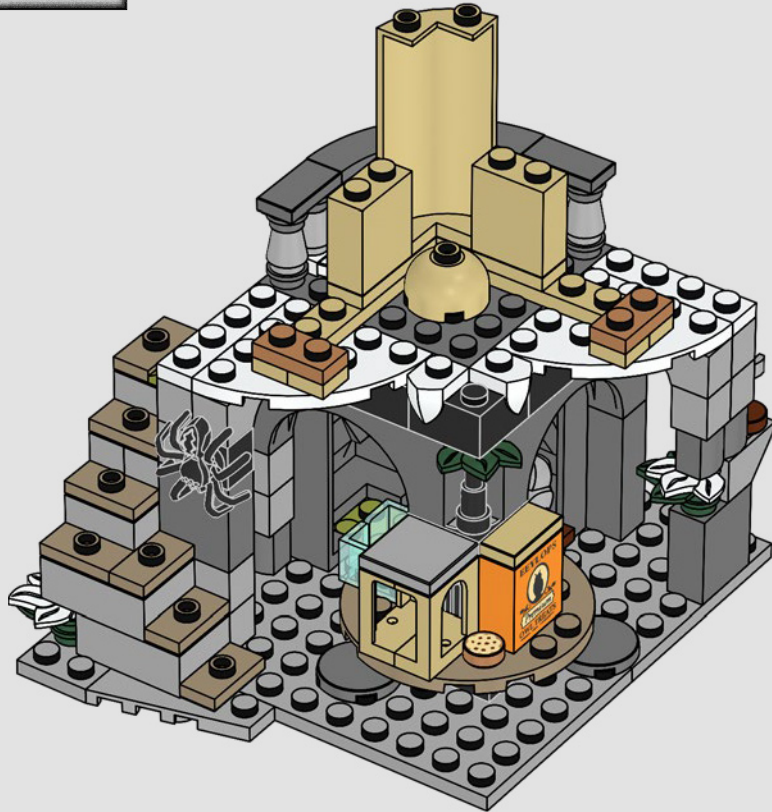



2x

53

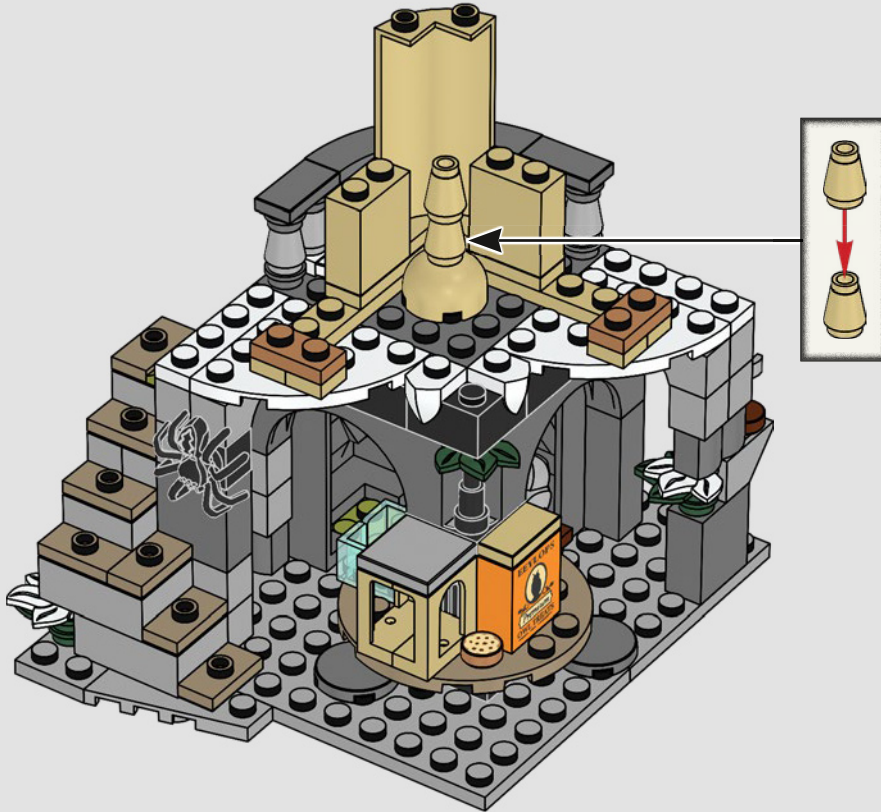

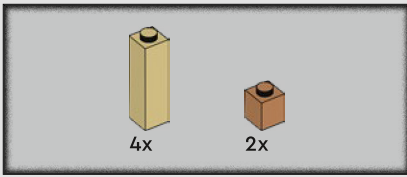

54

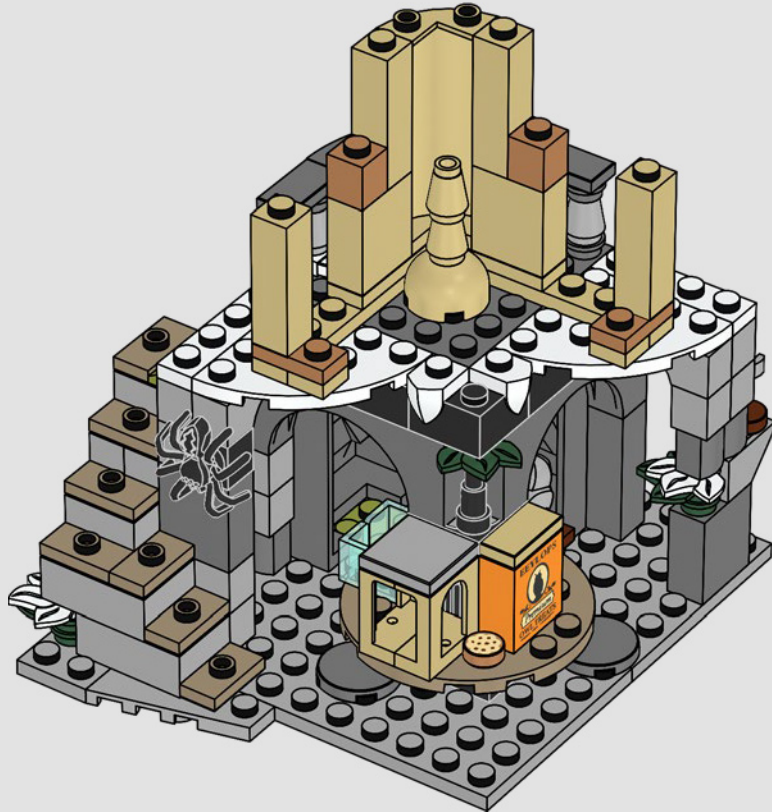

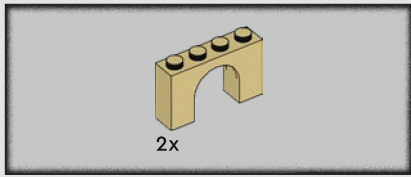

55

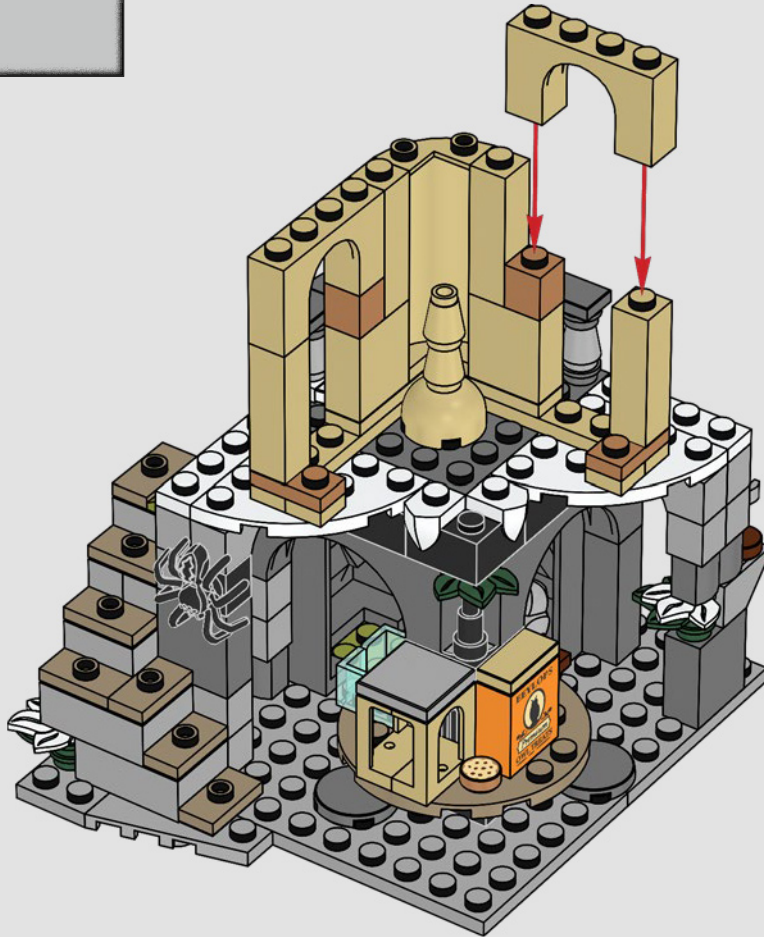

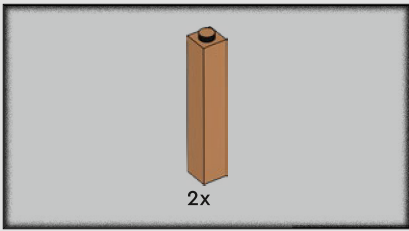

56

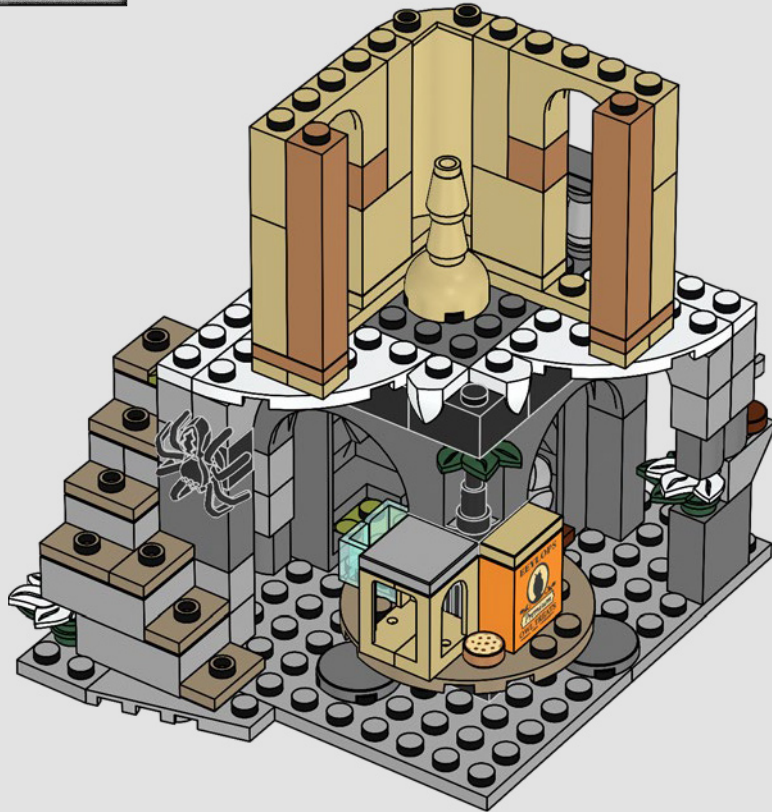

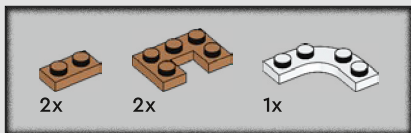

57

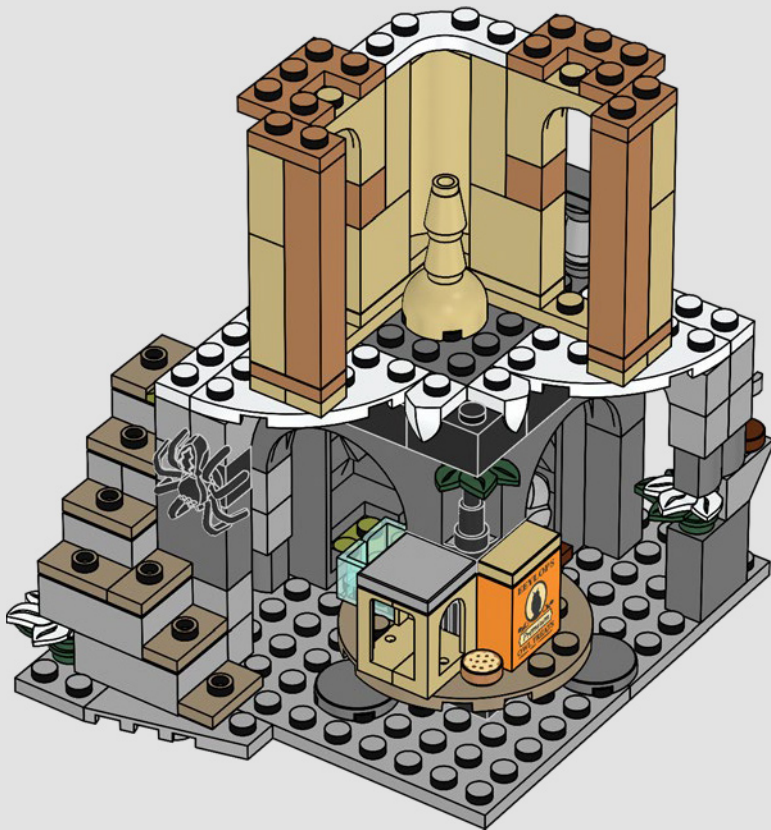

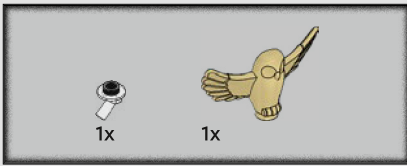

58

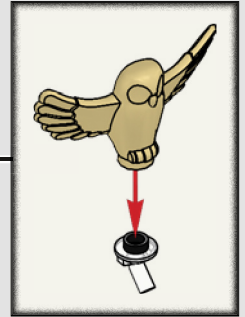
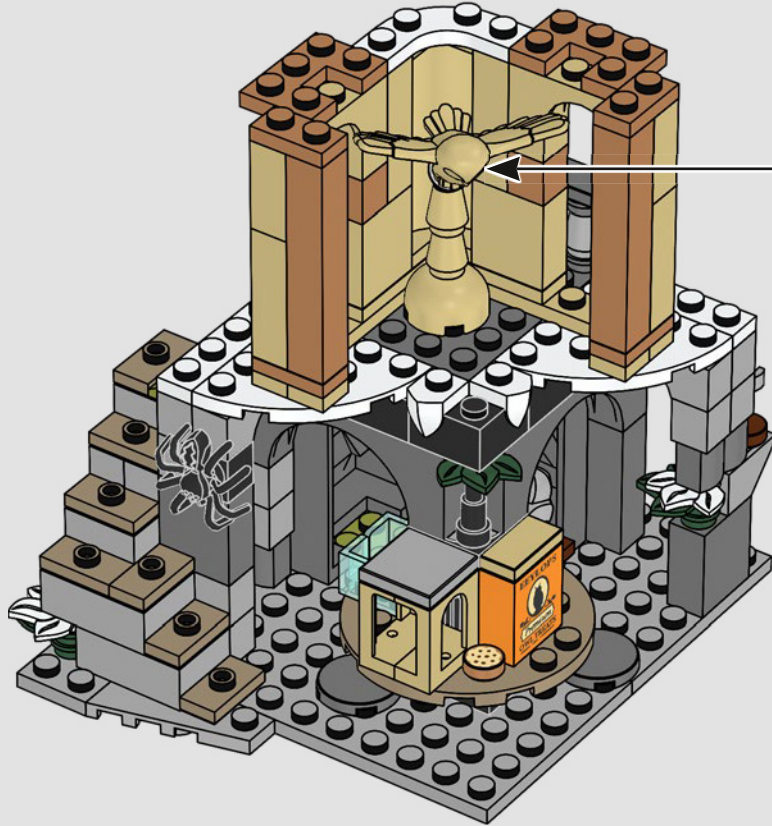

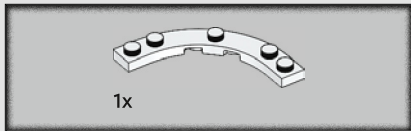

59

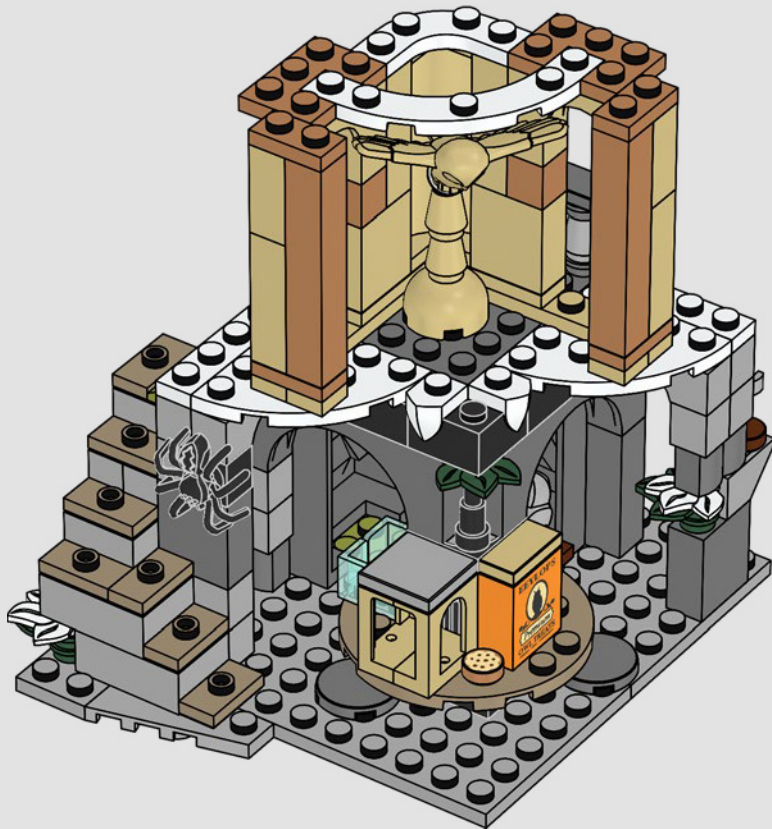

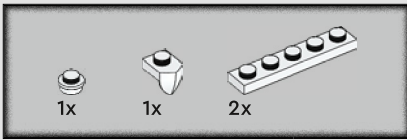

60

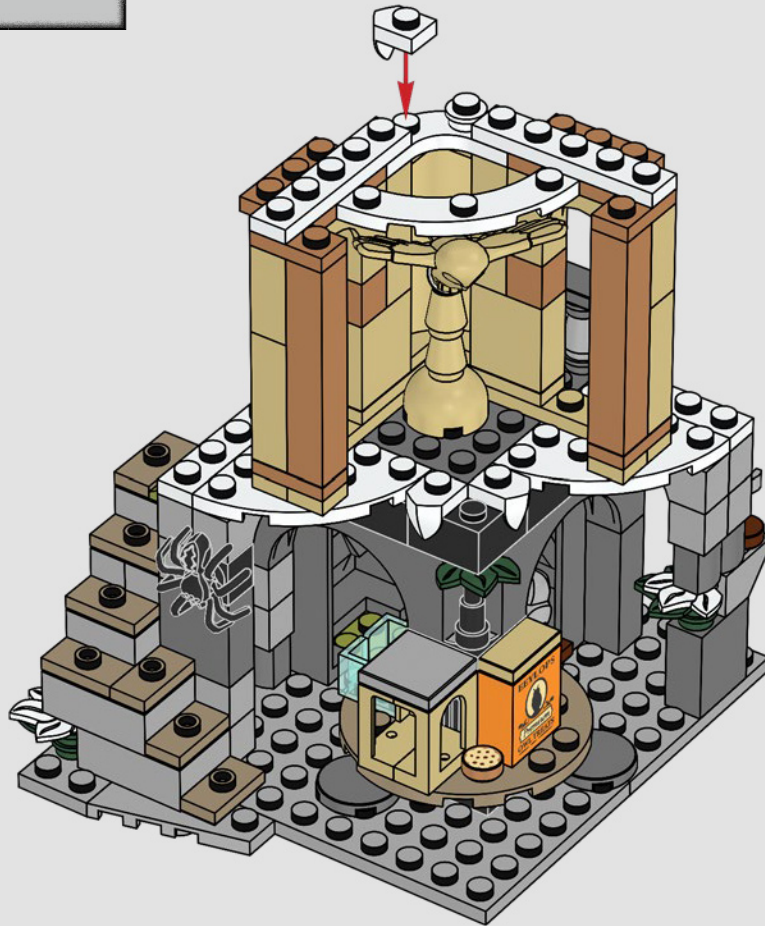

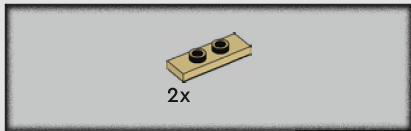

61

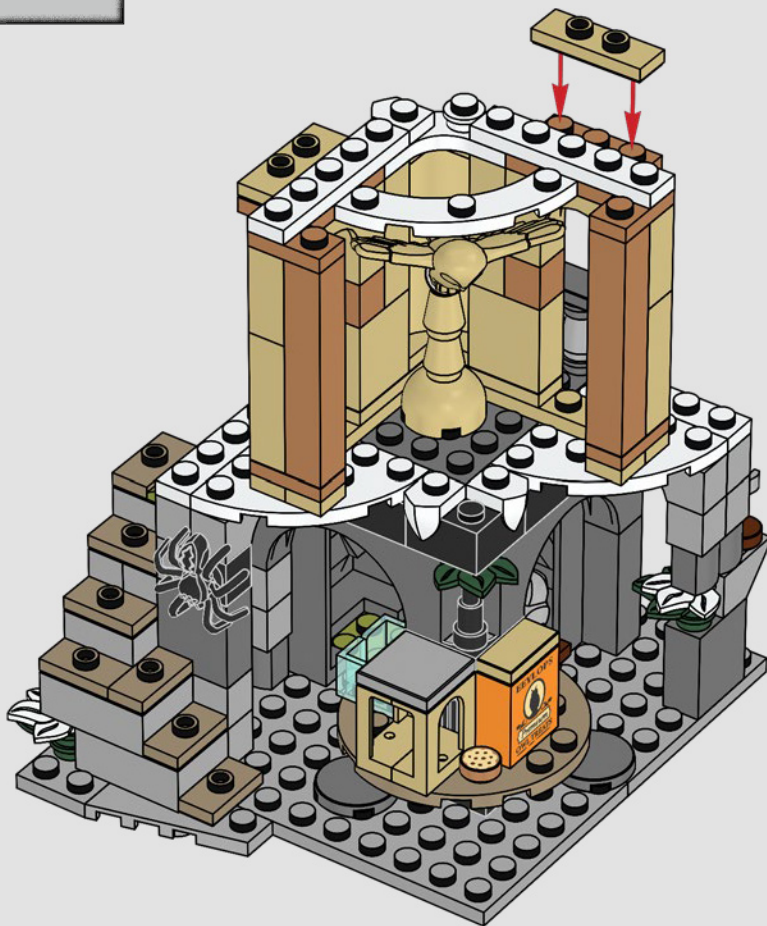

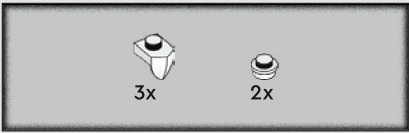

62

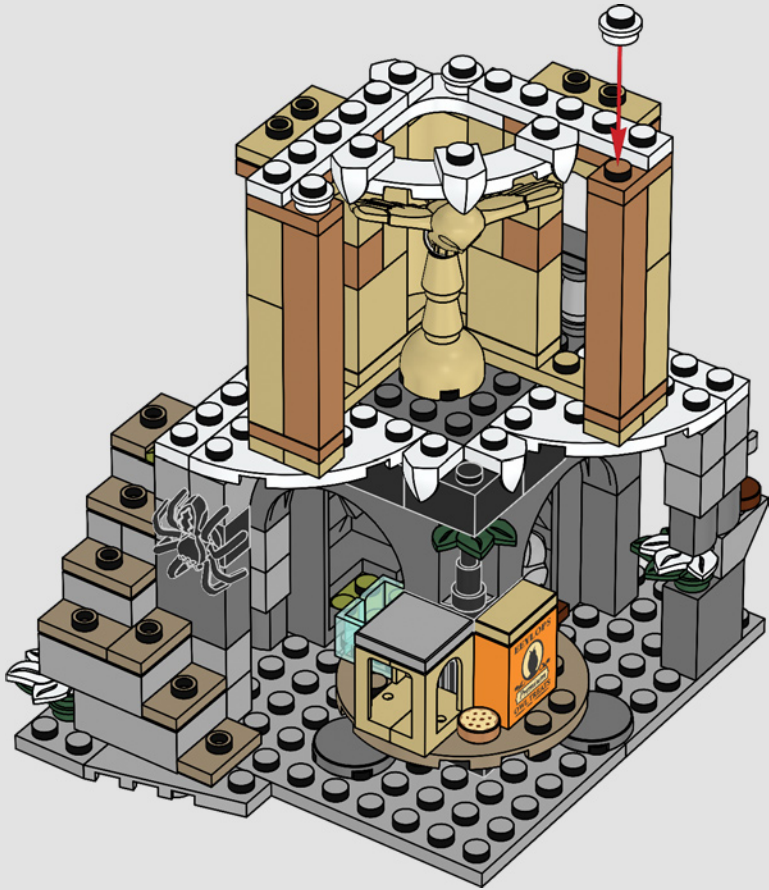

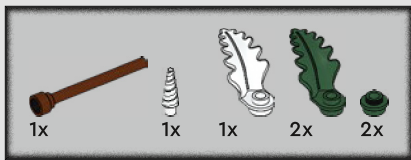

63

1



2



3



4



5



6



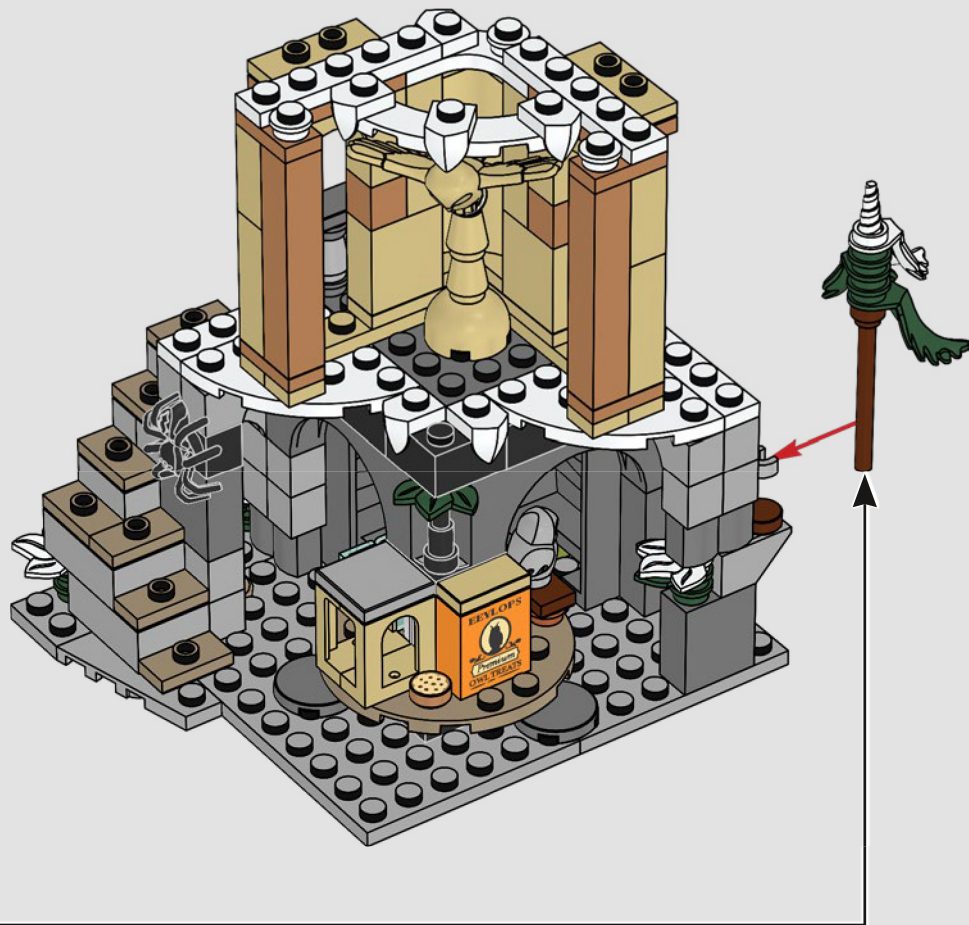

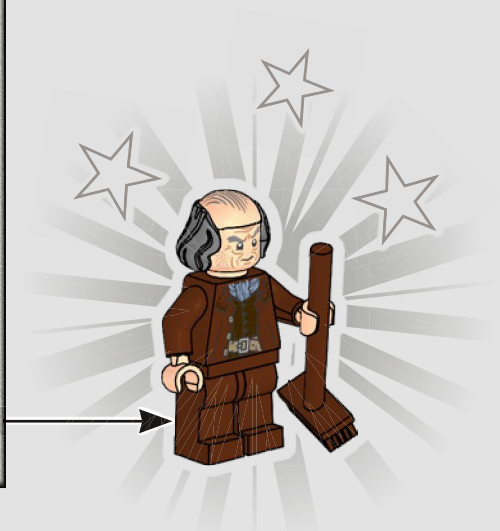
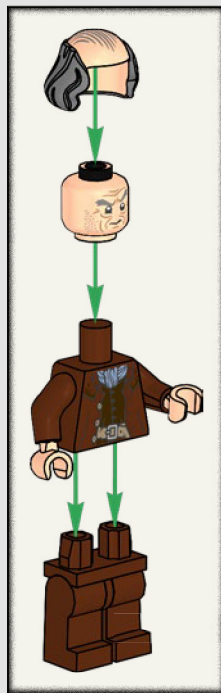

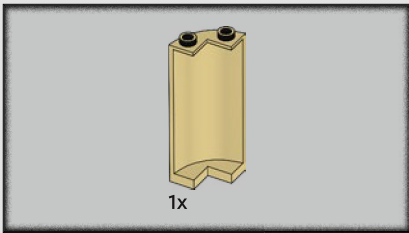

64

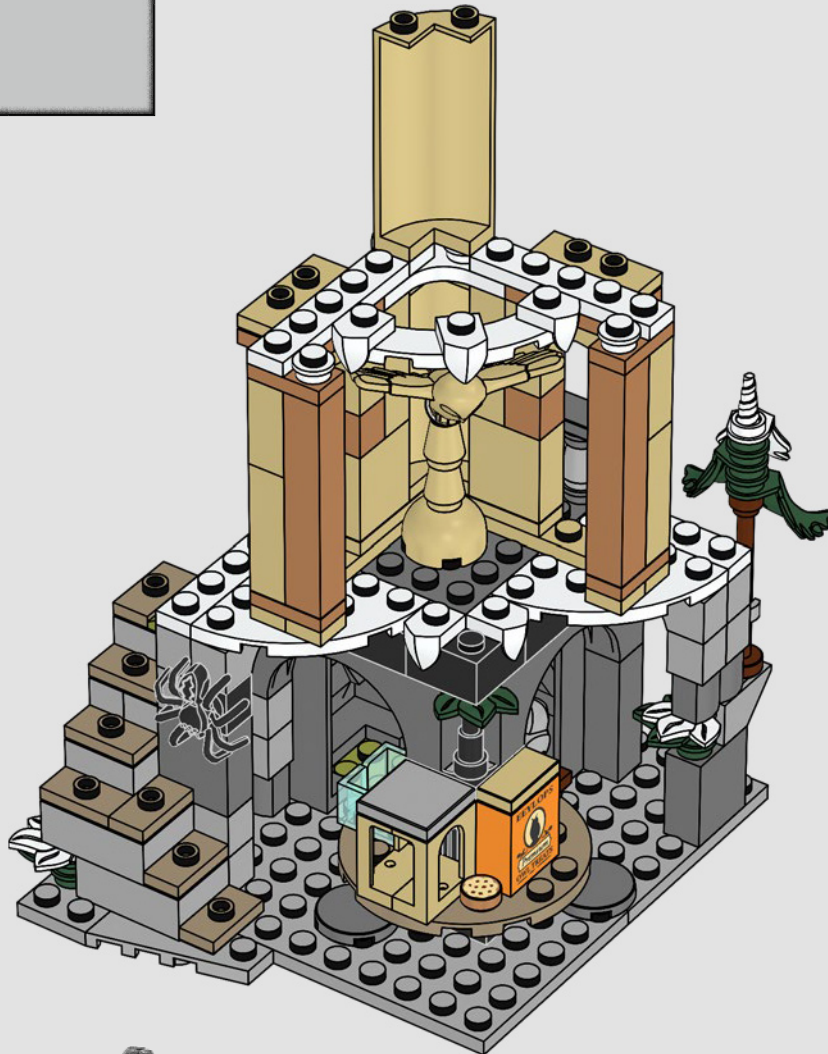

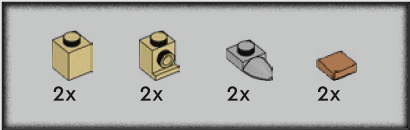

65

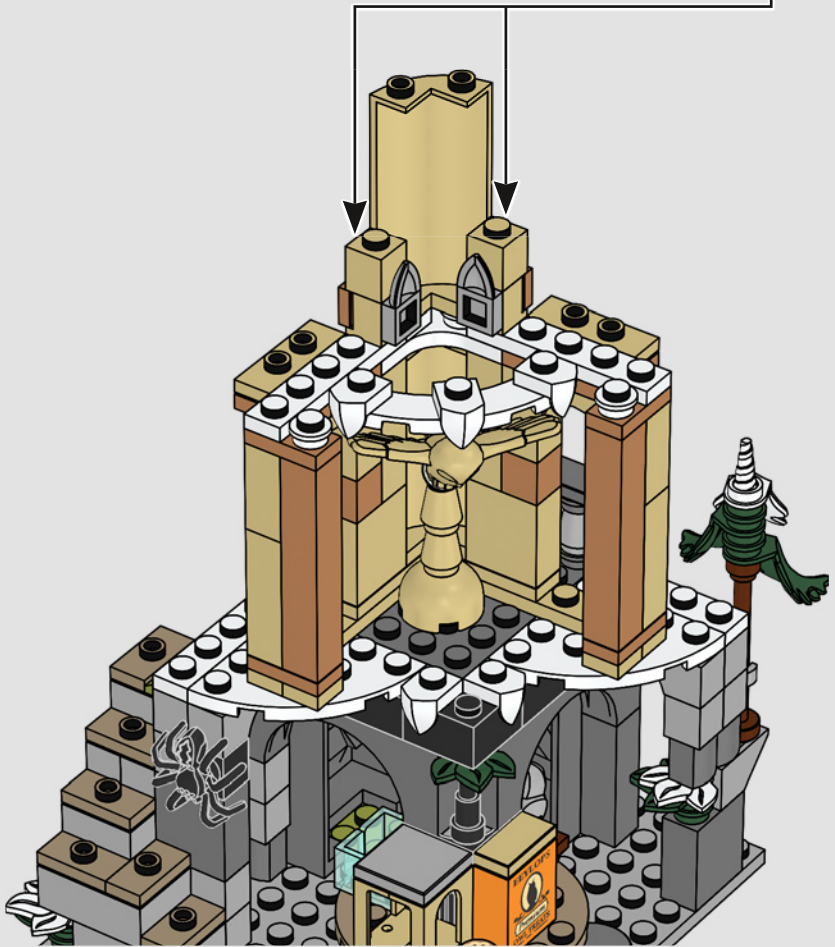
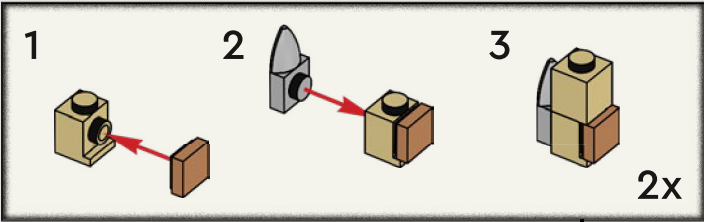

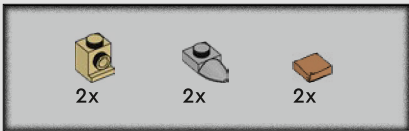

66

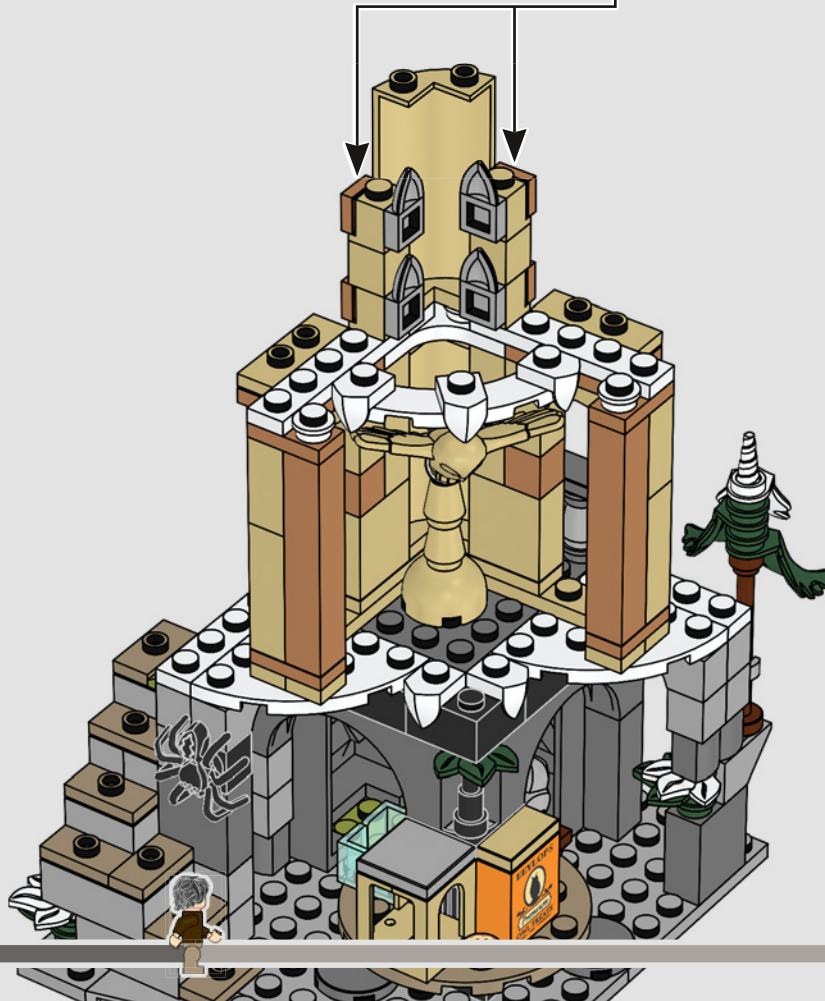
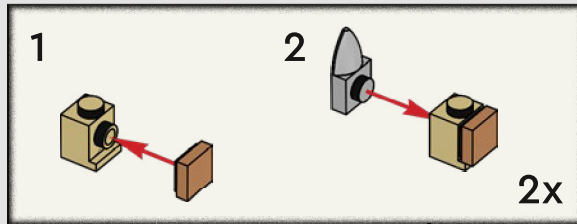



6x

67

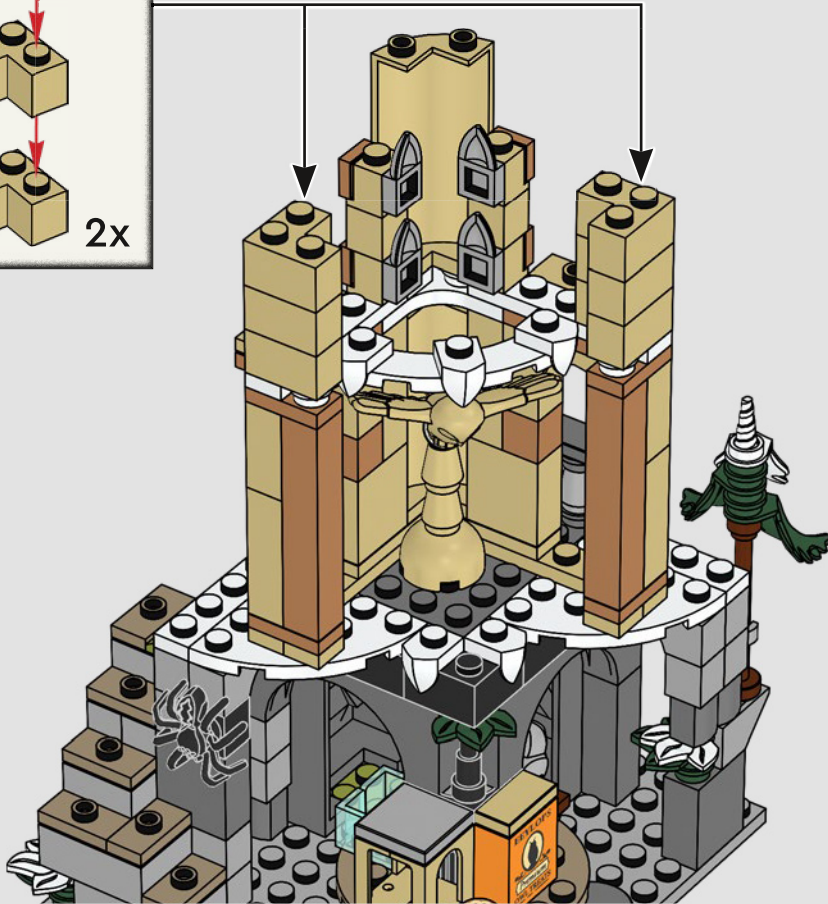
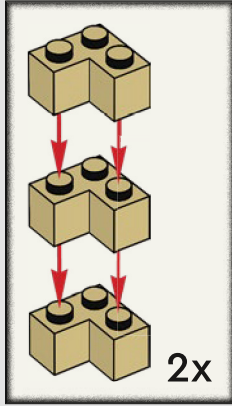

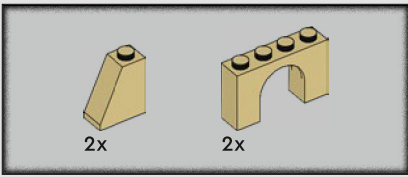

68

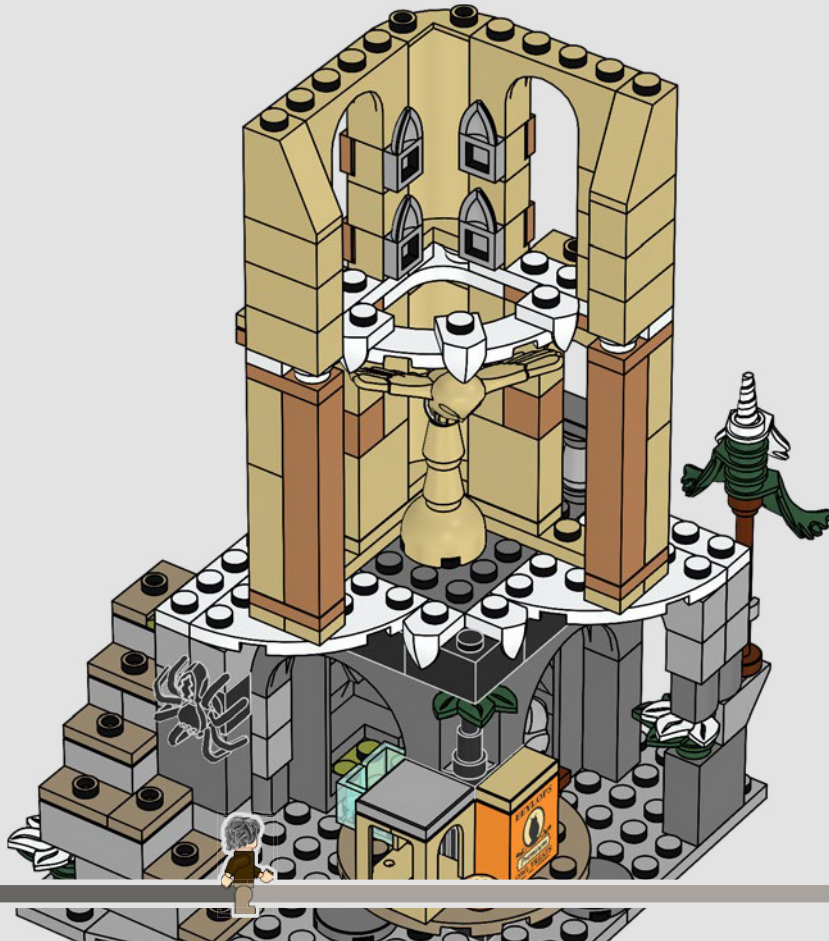

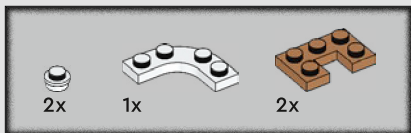

69



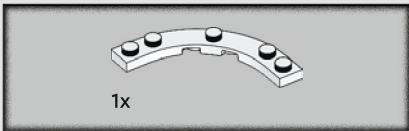

70

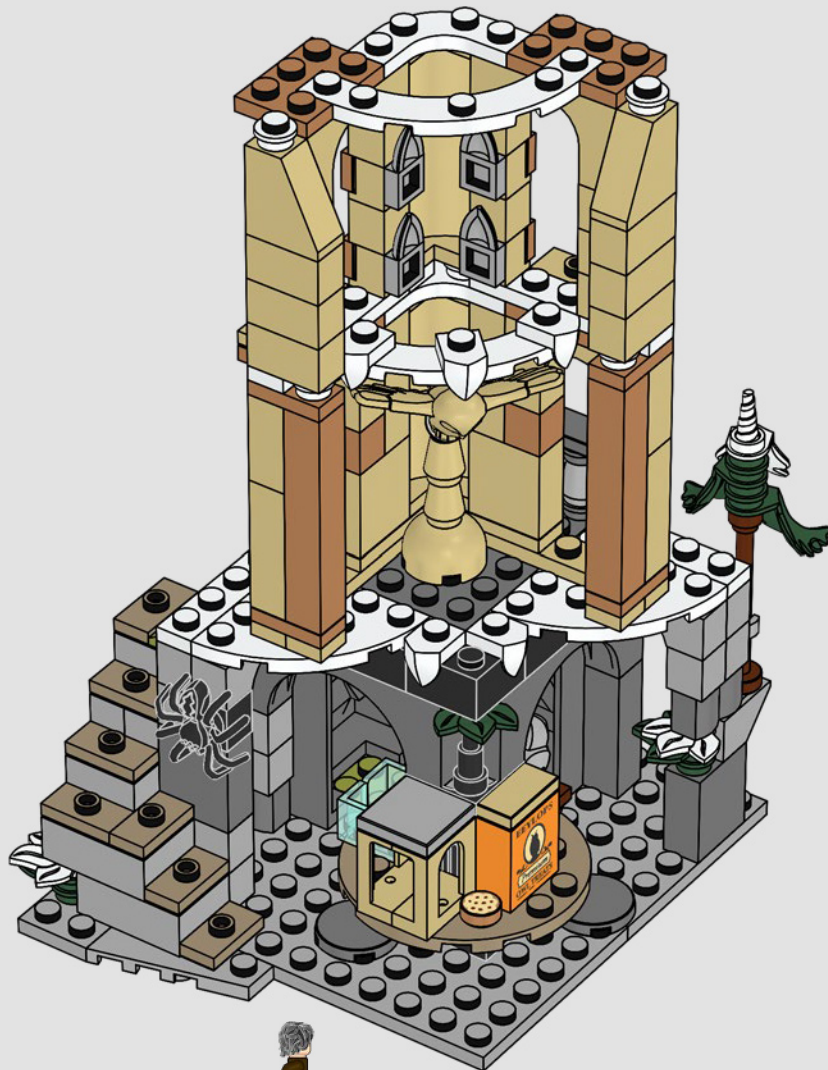

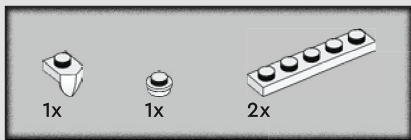

71

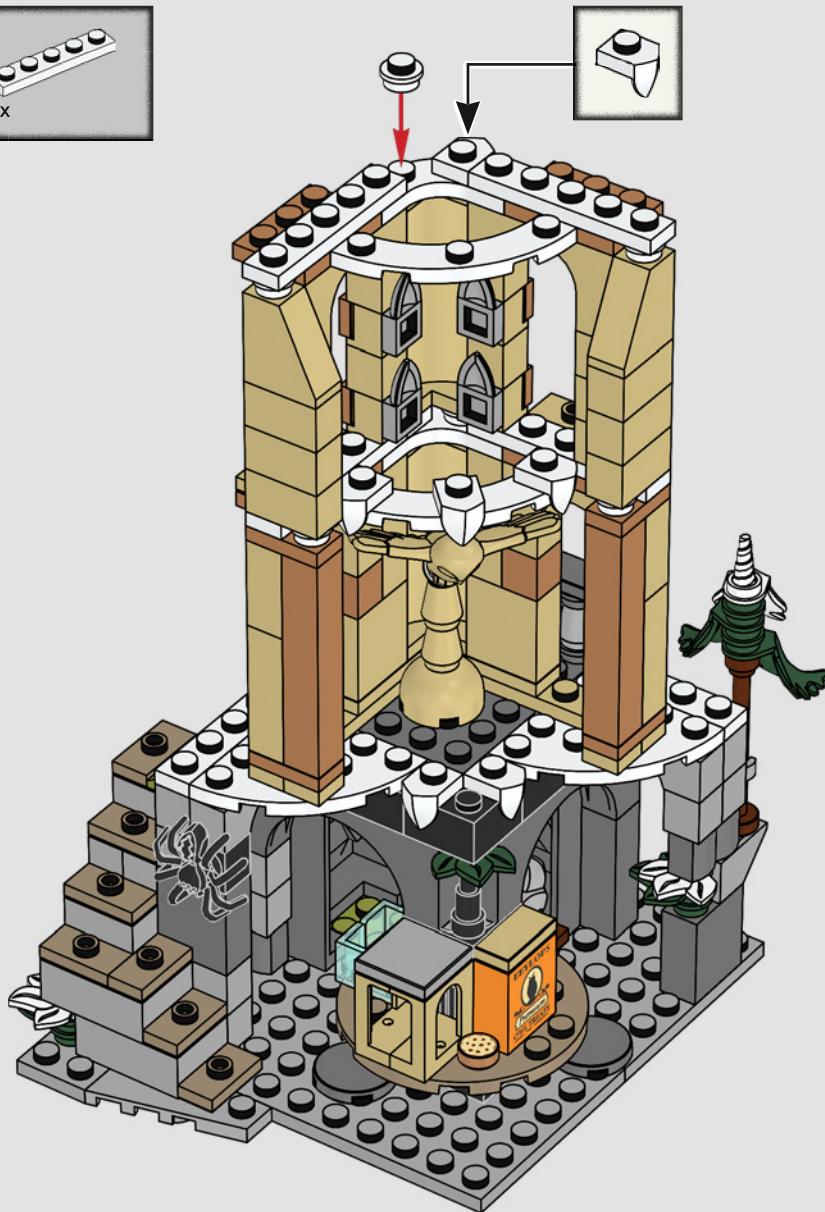

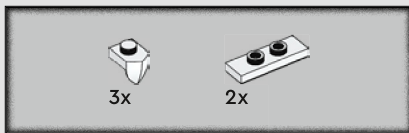

72

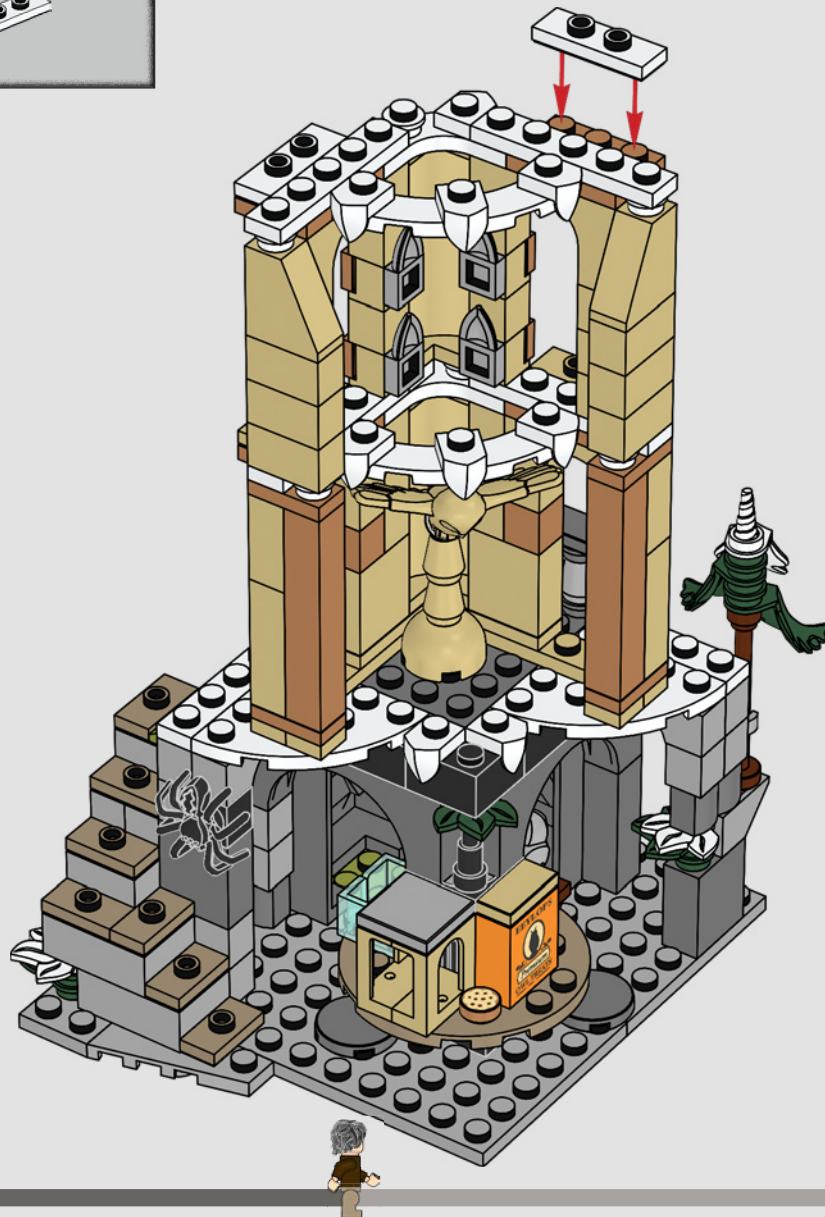

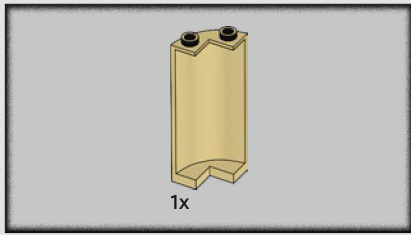

73

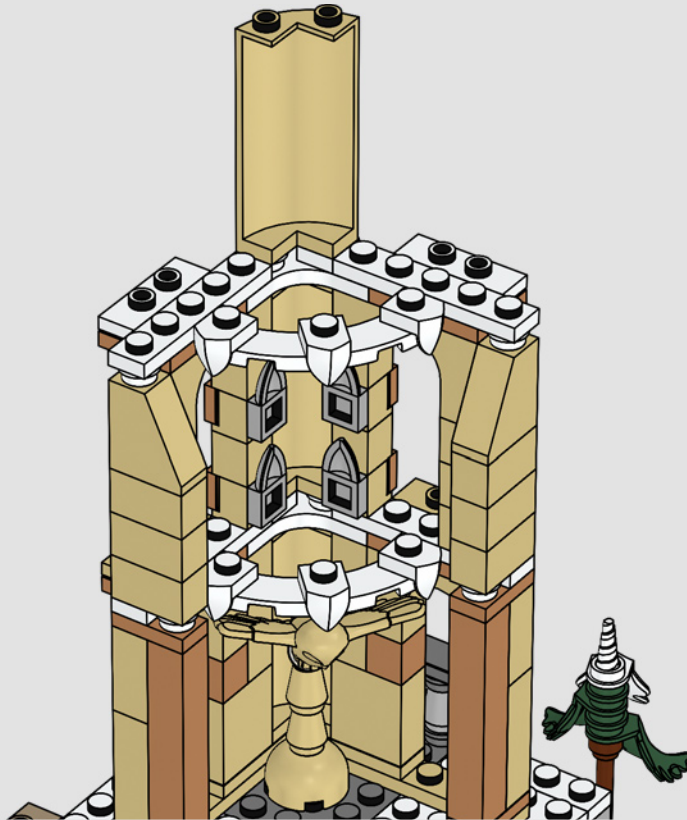

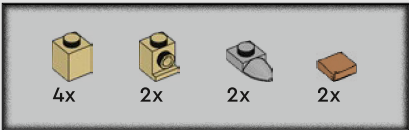

74

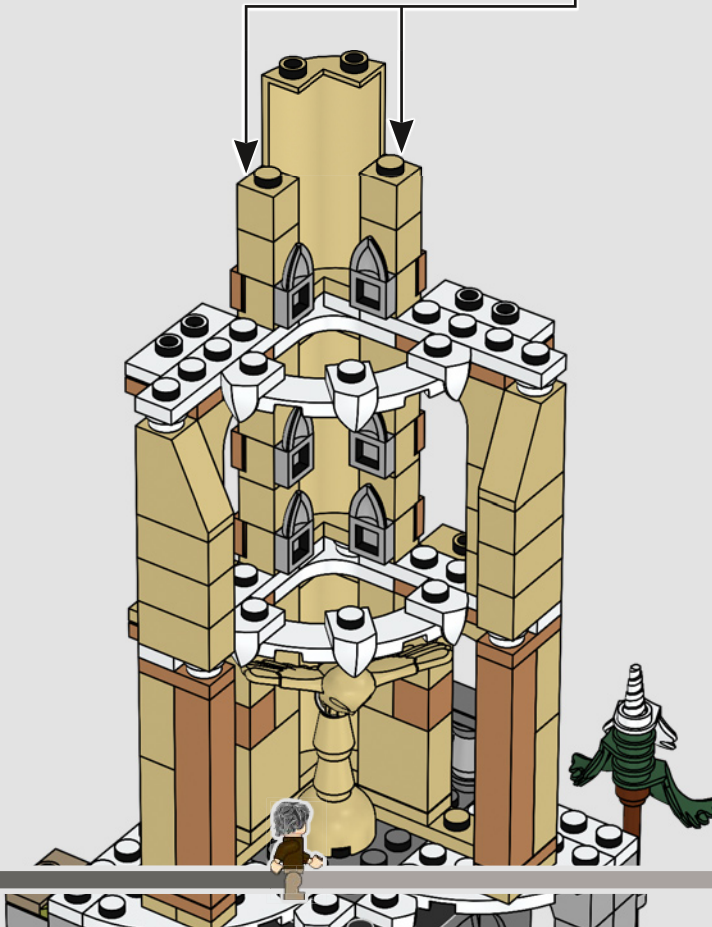
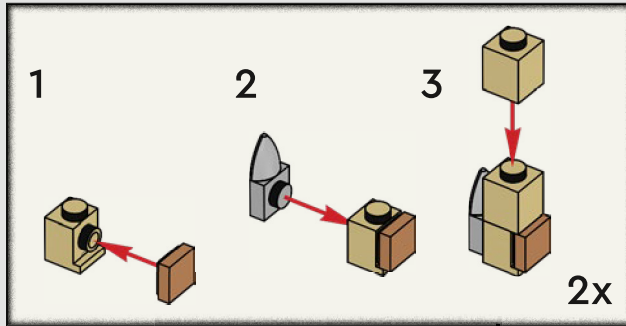



2x

75

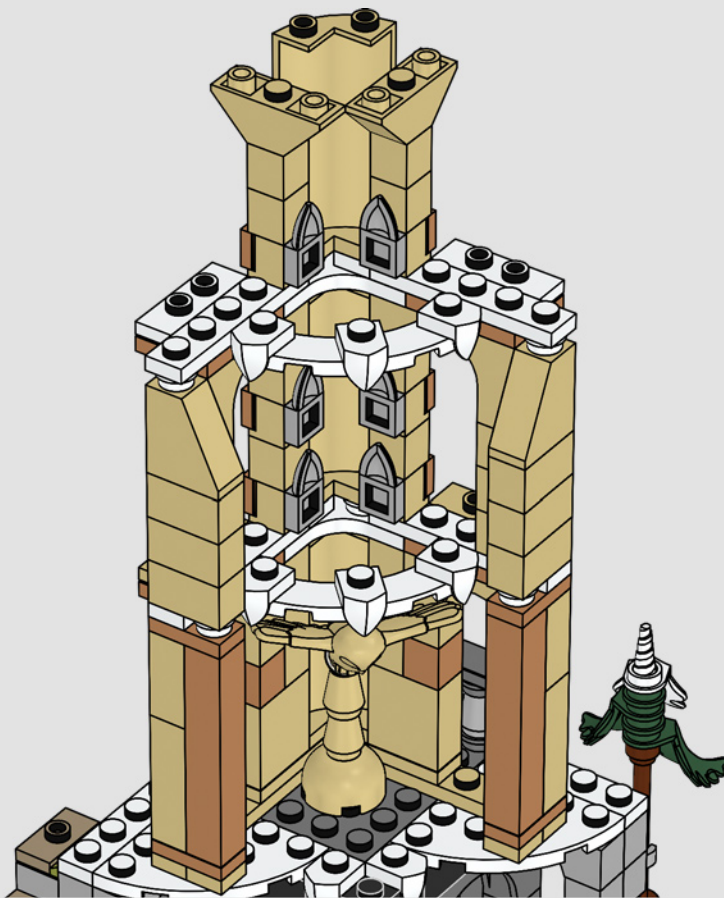

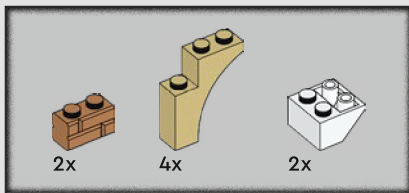

76

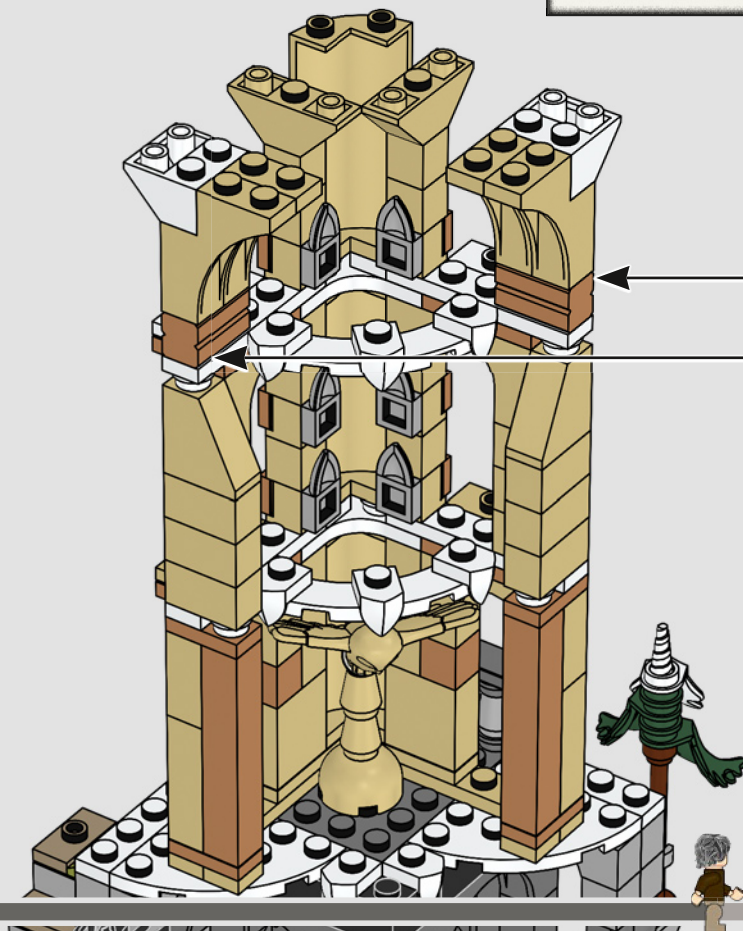
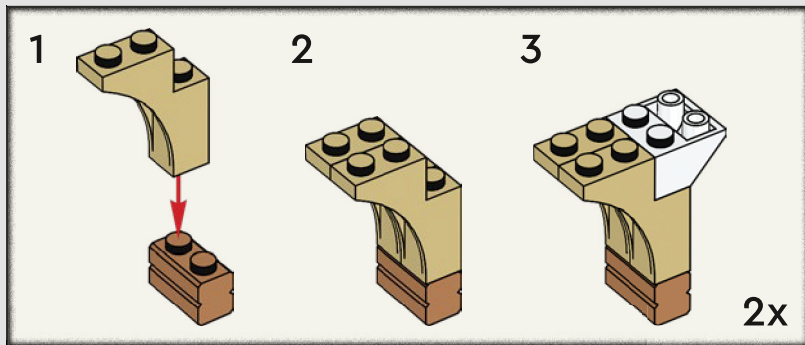

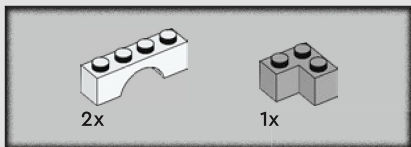

77

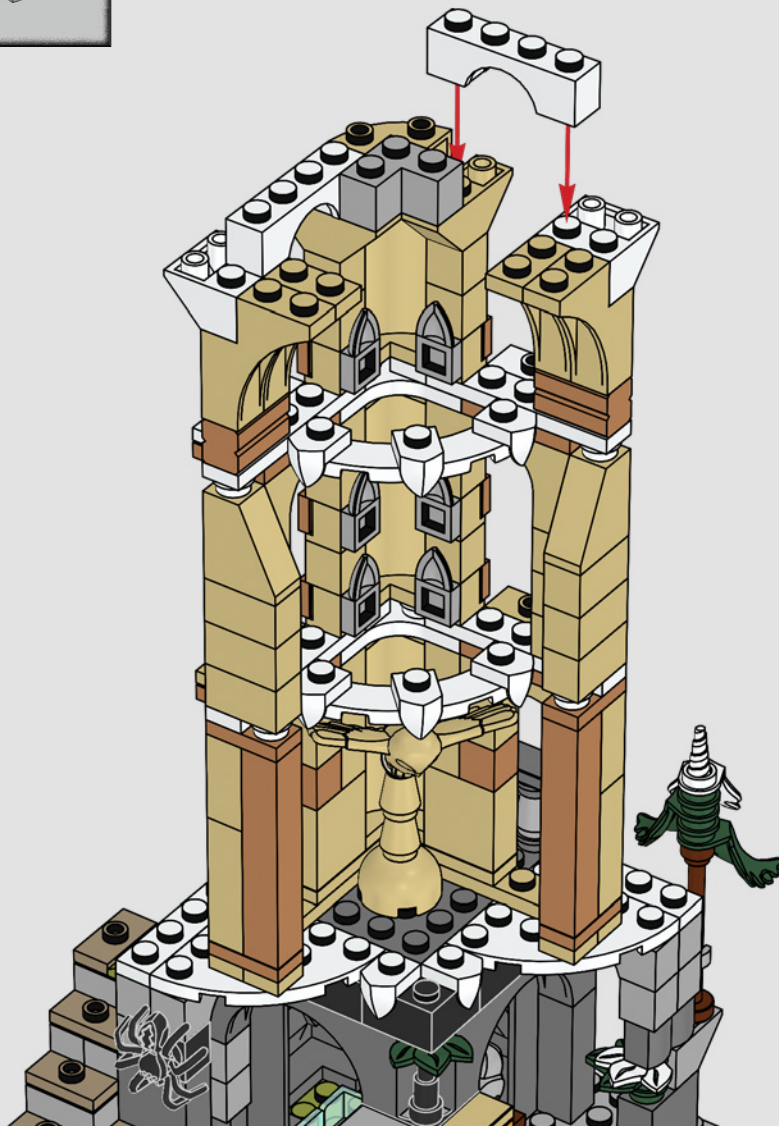

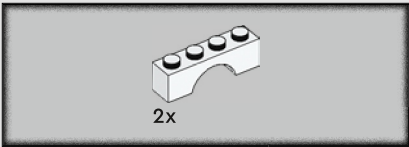

78

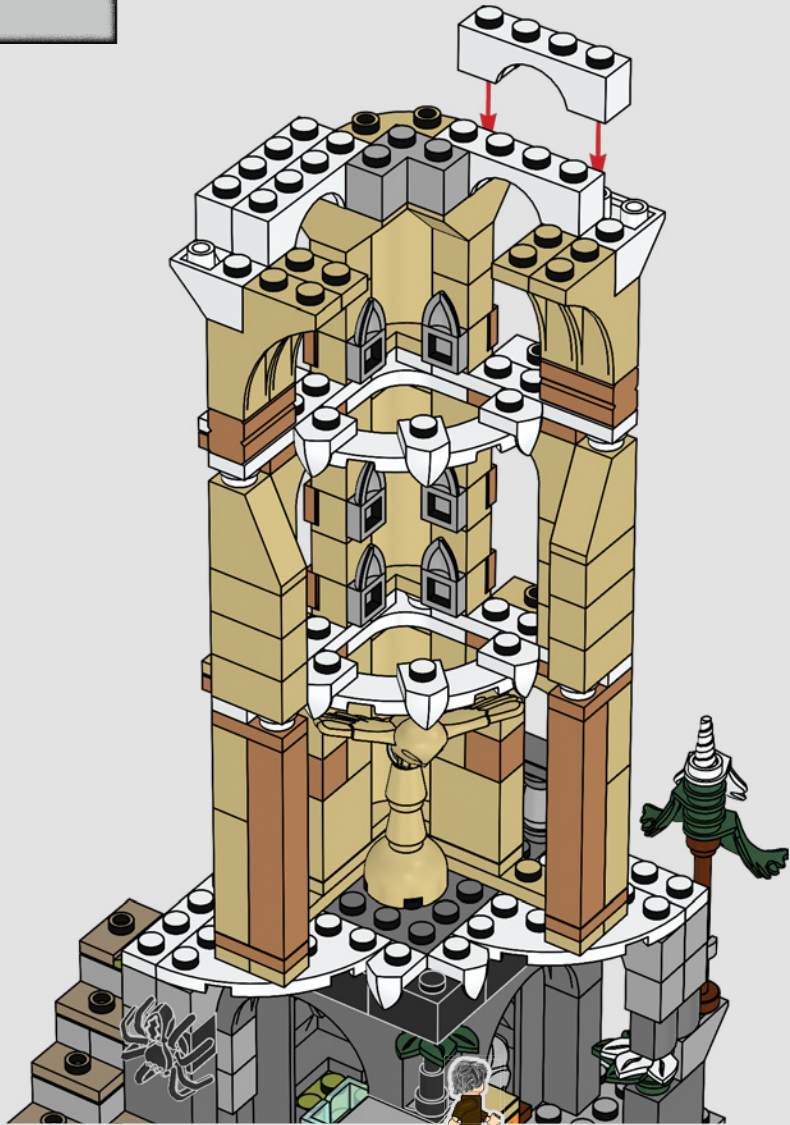

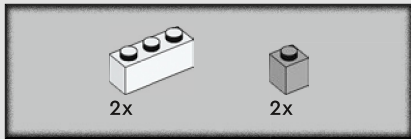

79

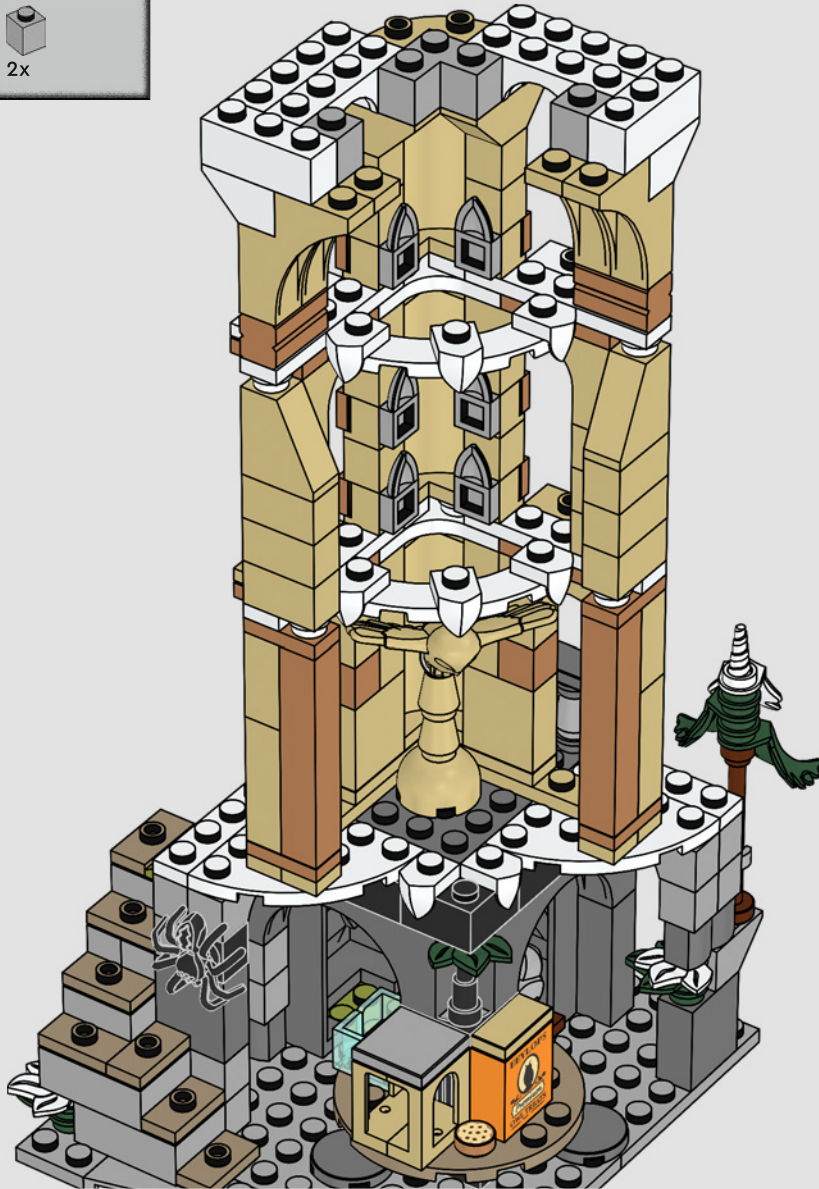

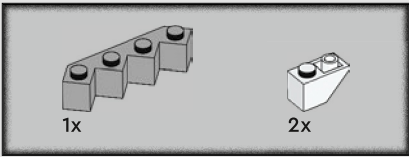

80

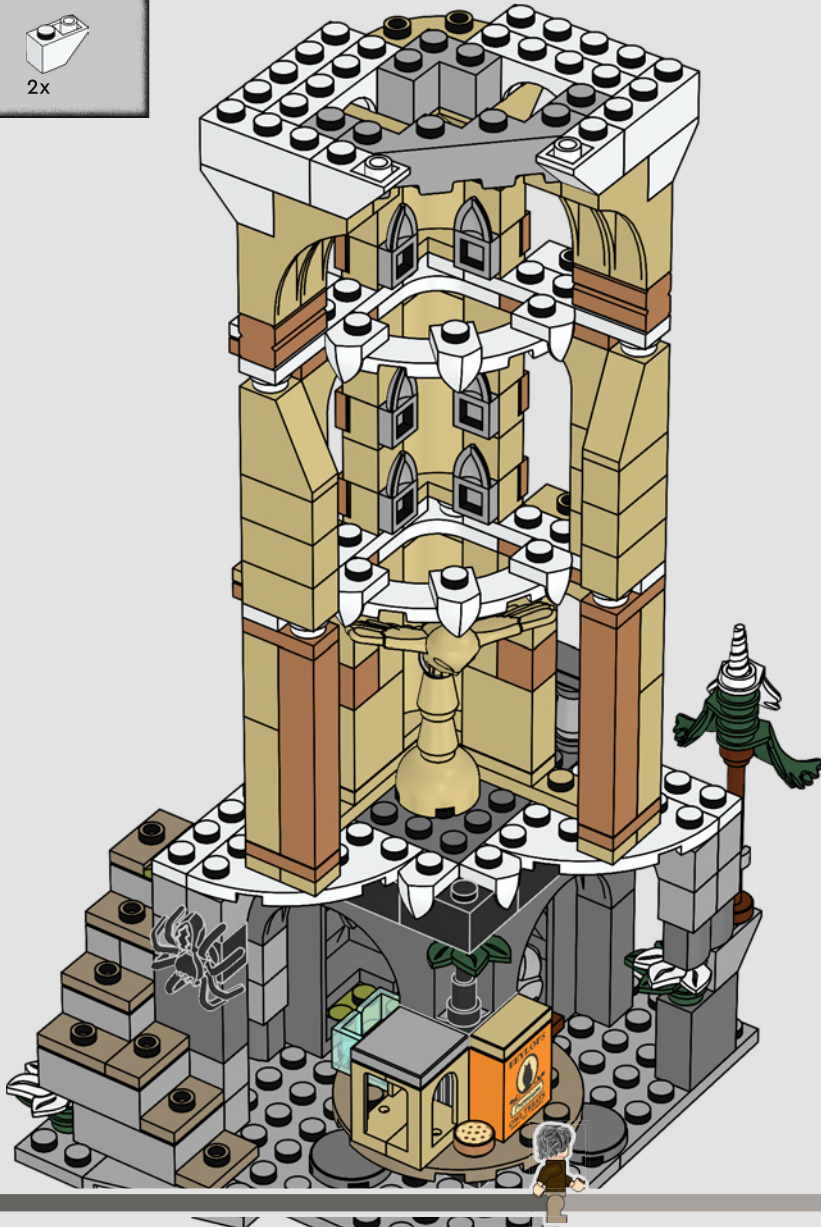

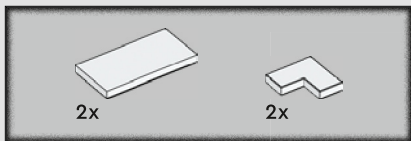

81

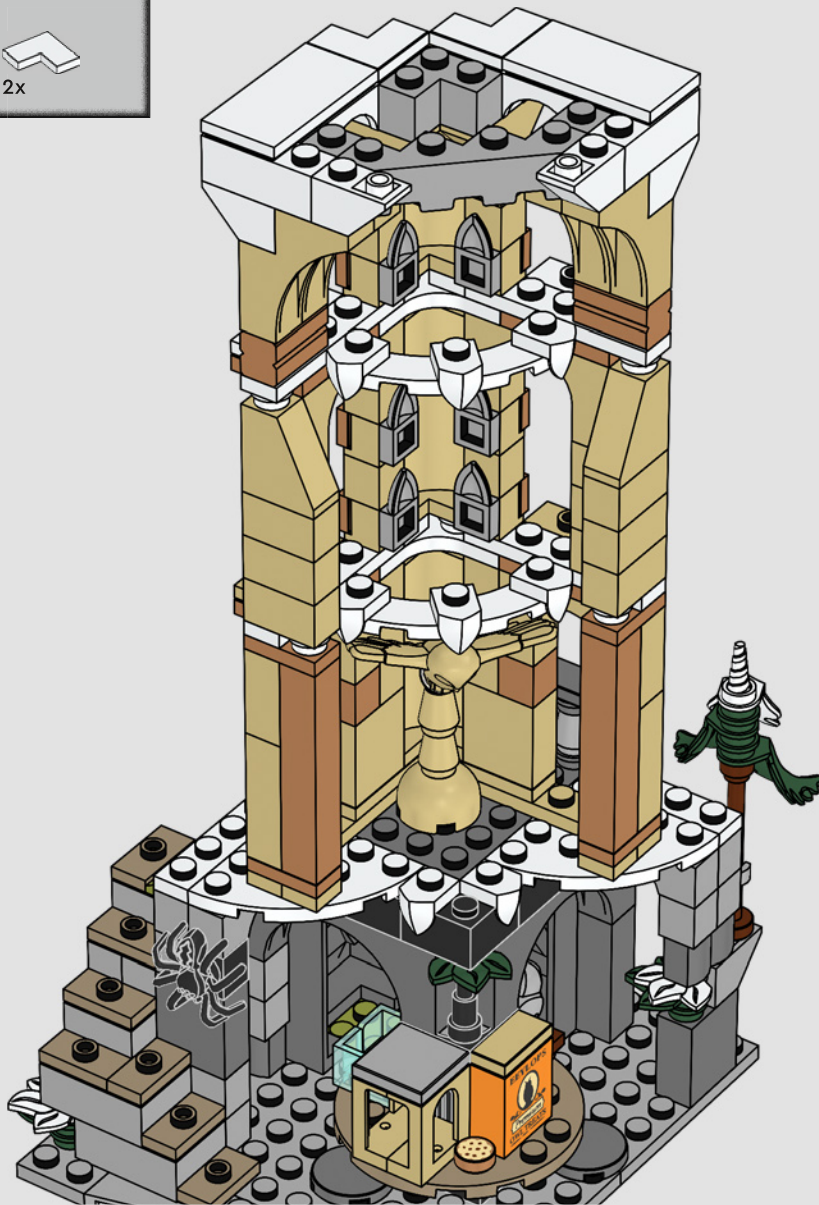

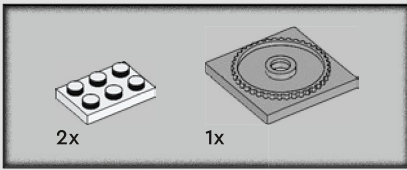

82

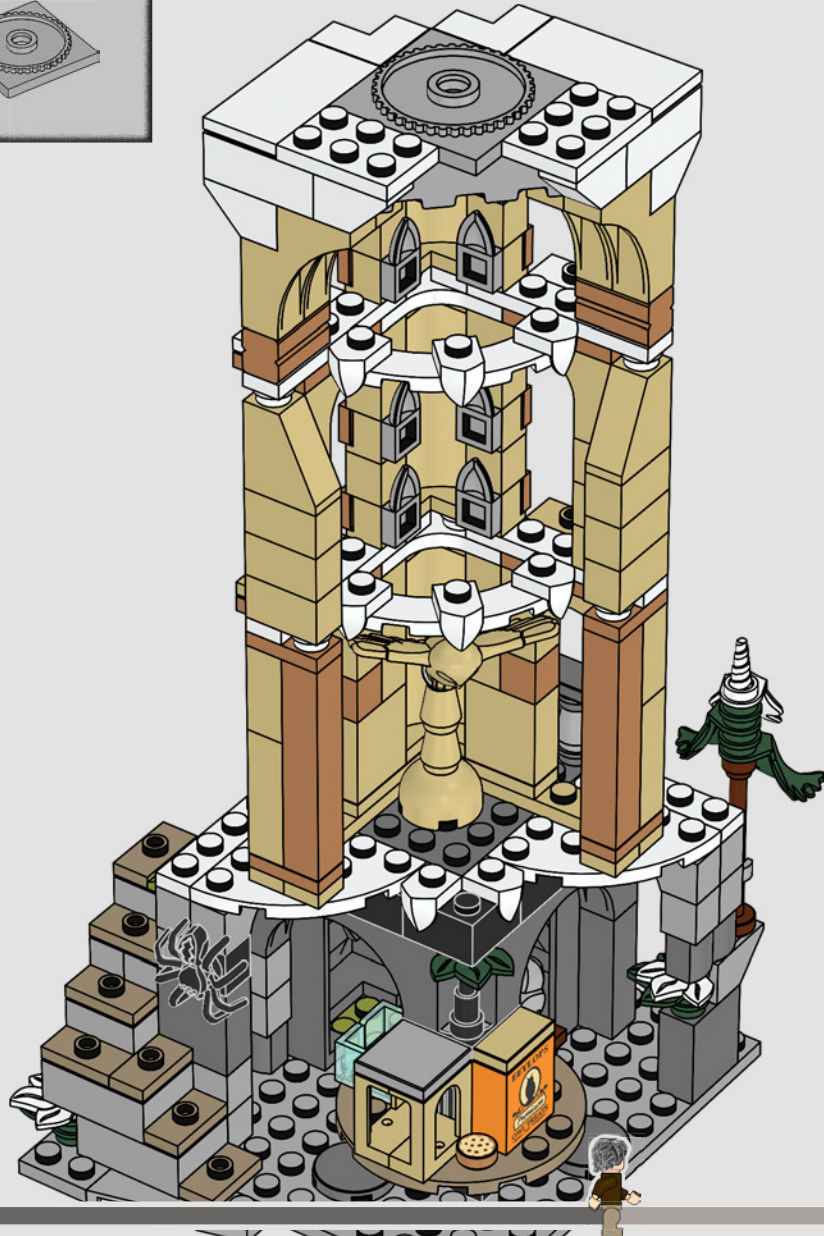



2x

83

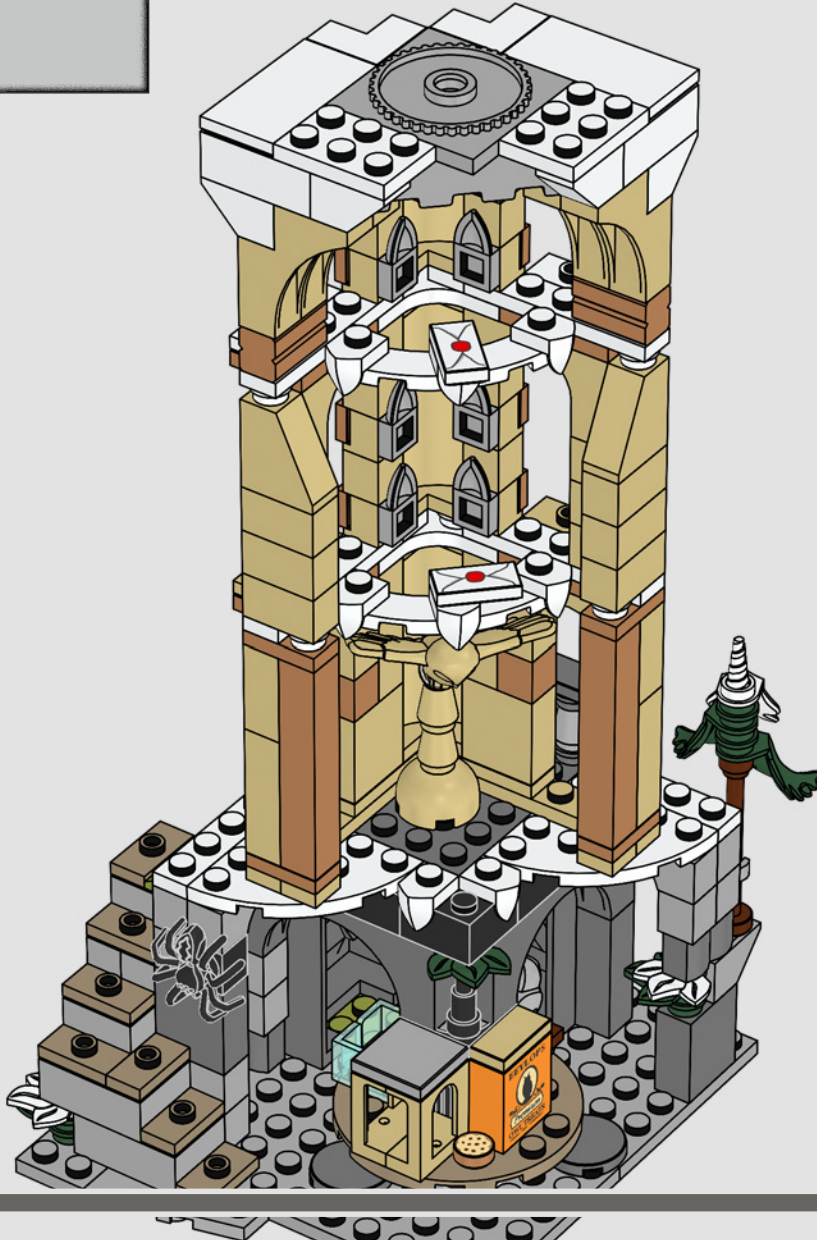



84

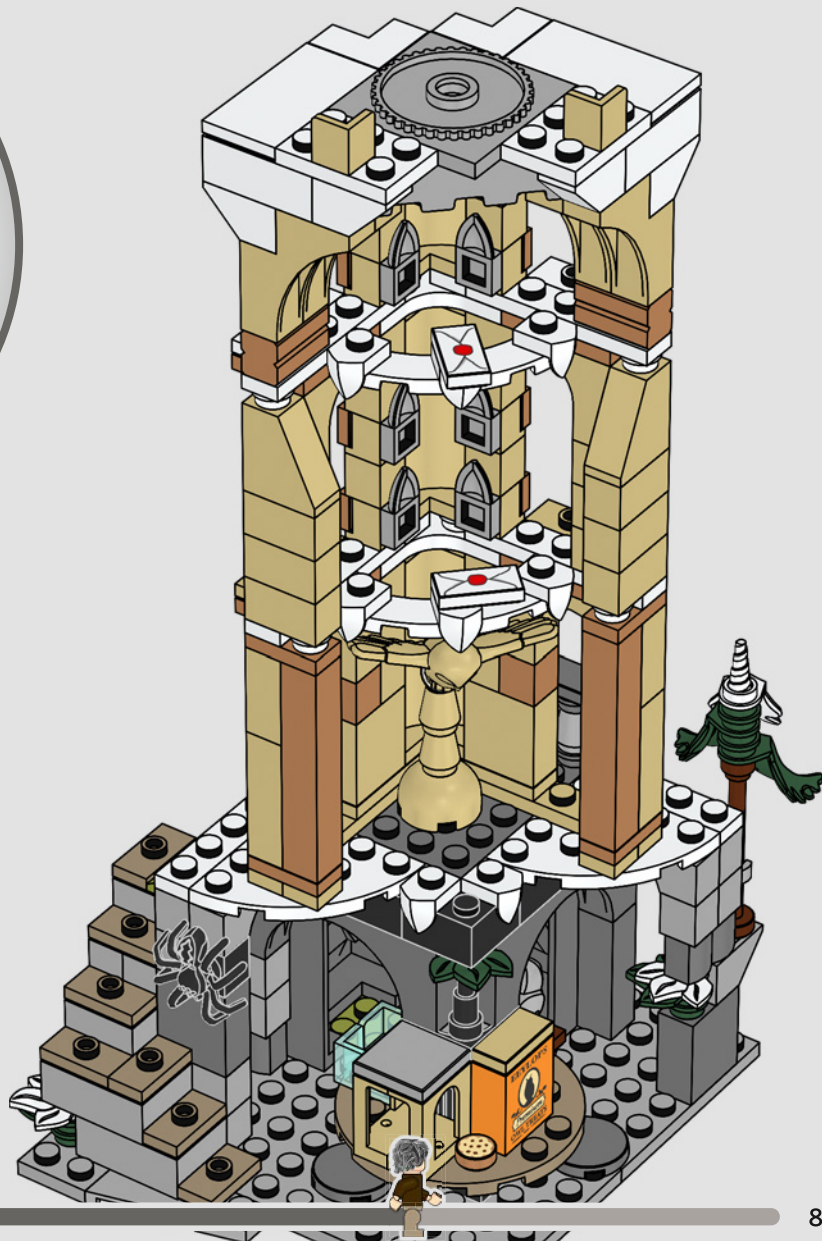

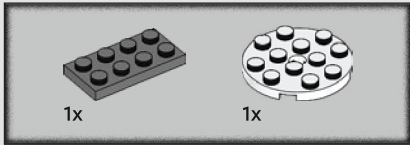
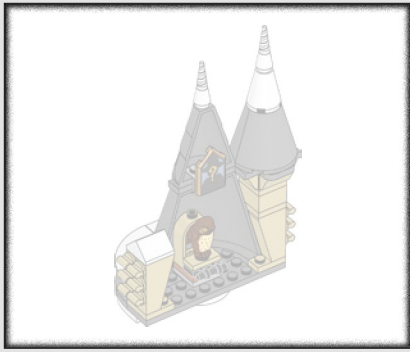

85

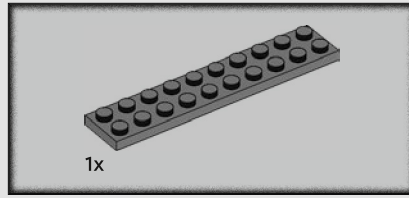

86

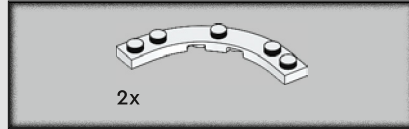
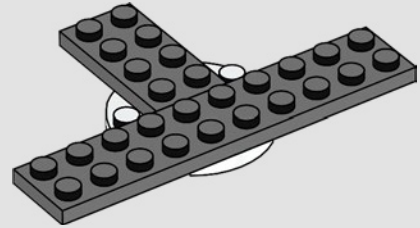

87

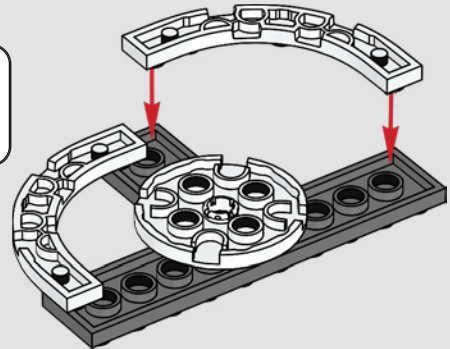

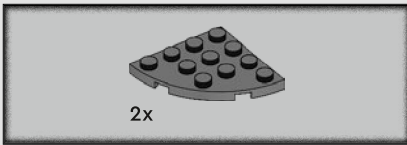

88

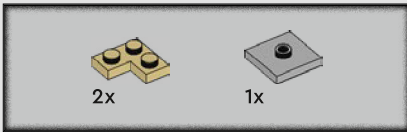
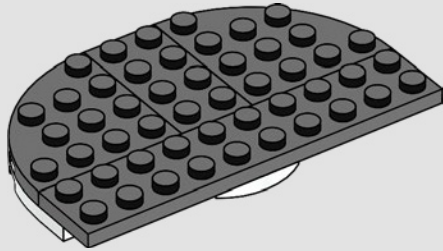

89

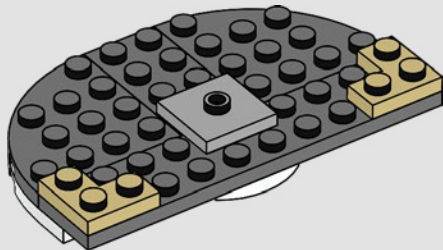

90

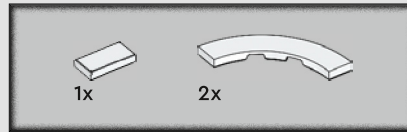
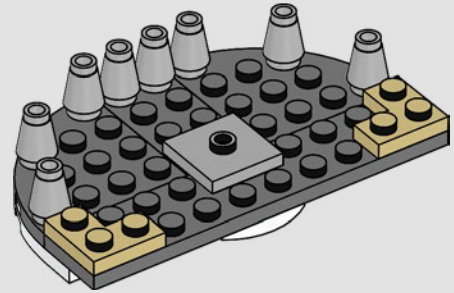

91

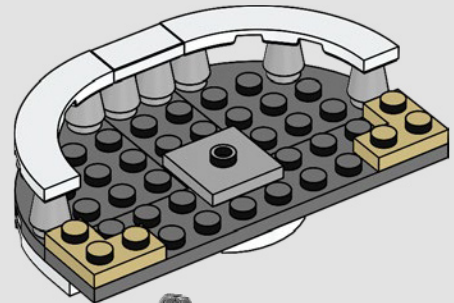

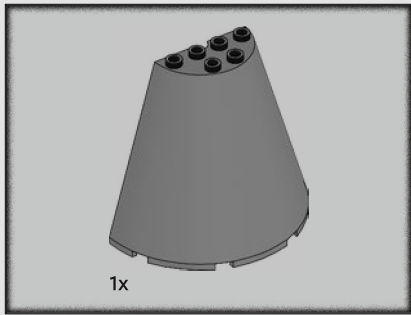

92

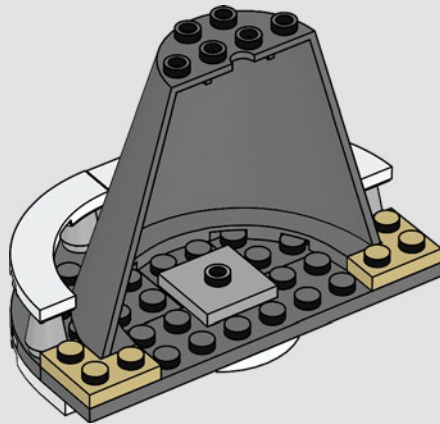

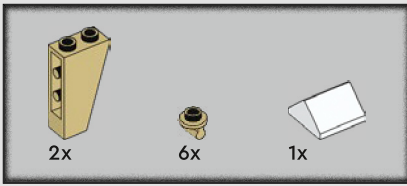

93

1

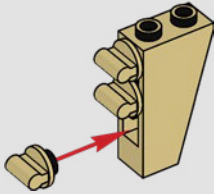

2

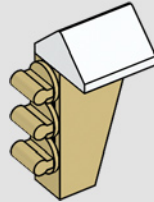

3

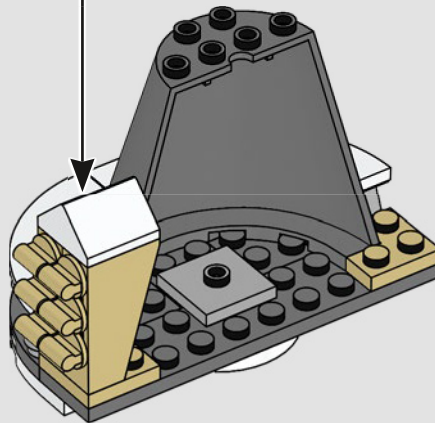
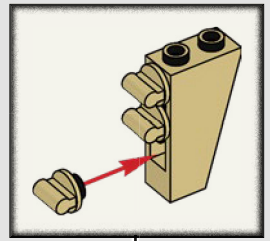
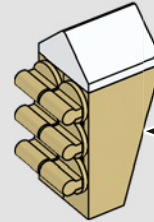

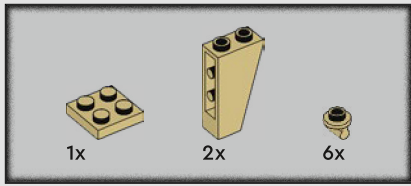

94

1

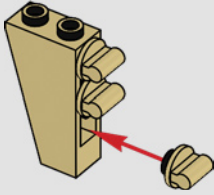

2

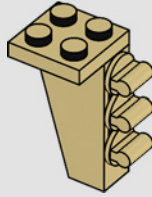

3

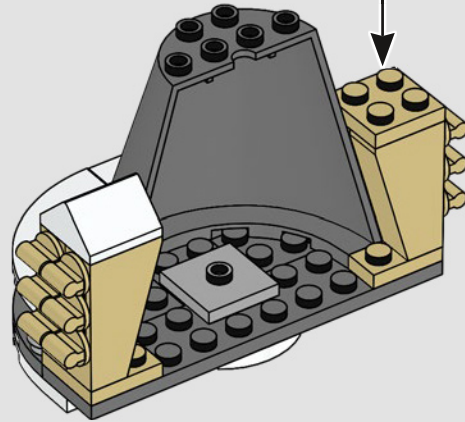
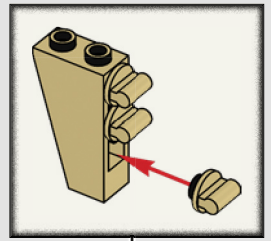
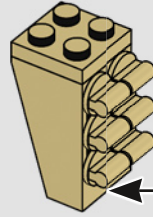

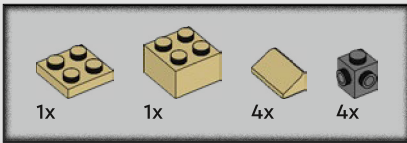

95

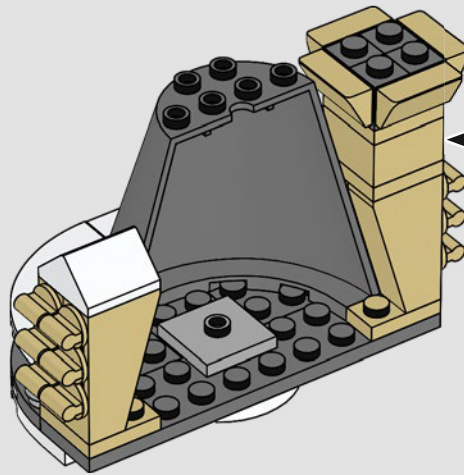
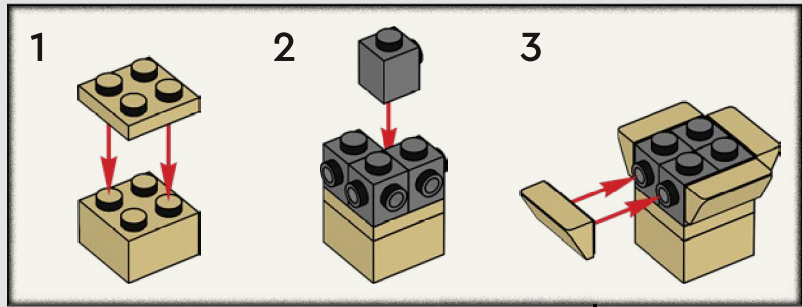

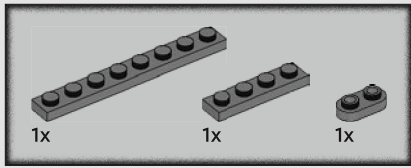

96

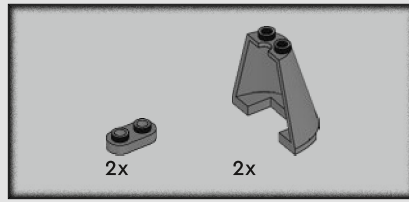
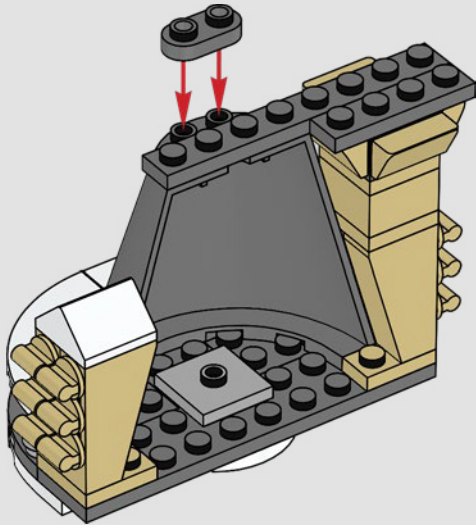

97

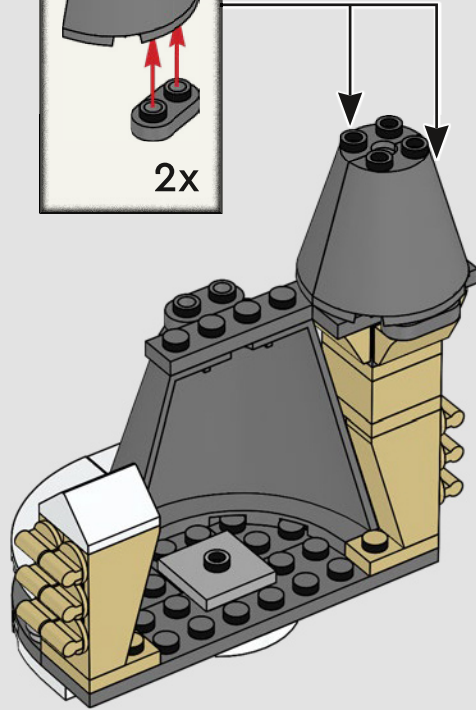
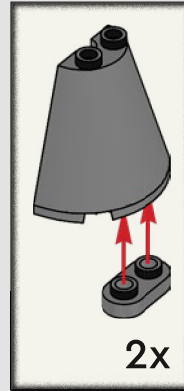

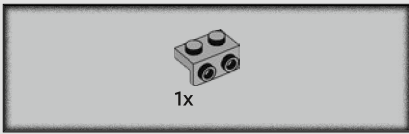

98

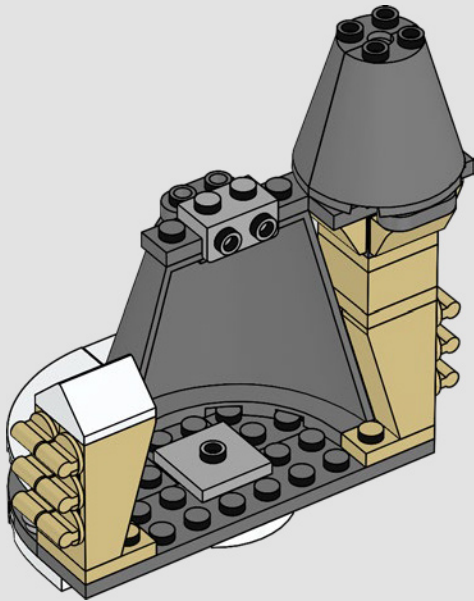

99

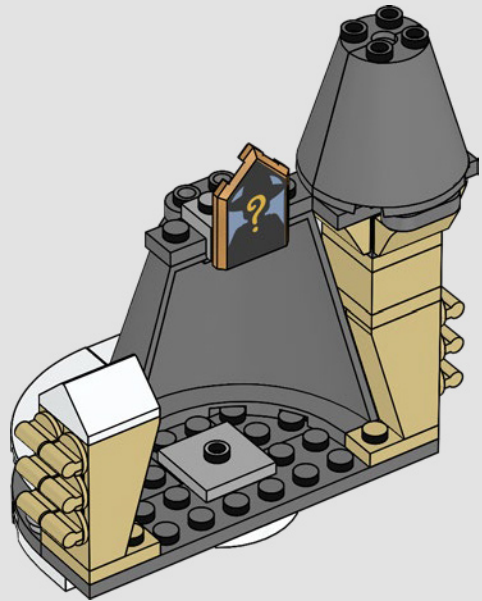

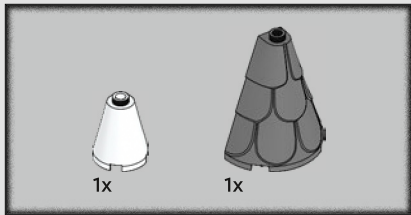

100

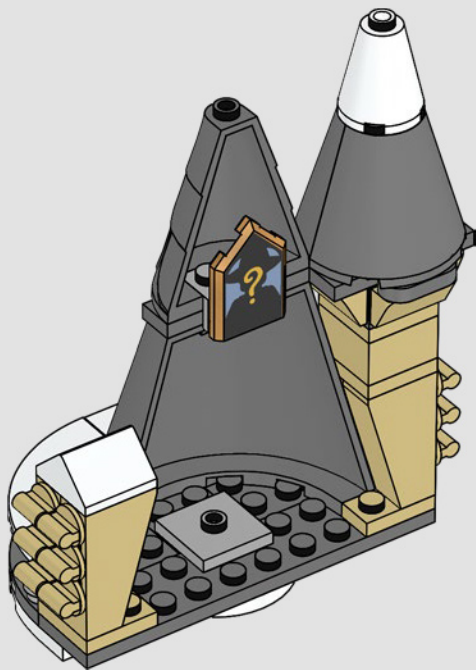

101

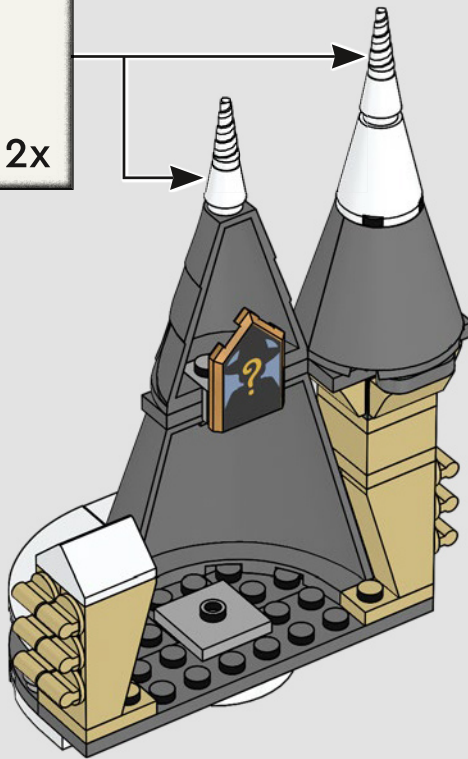
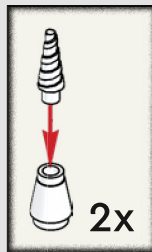

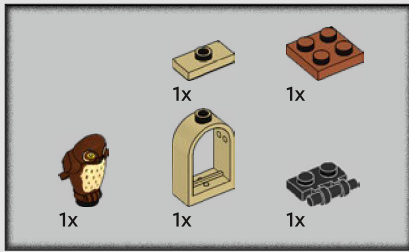

102

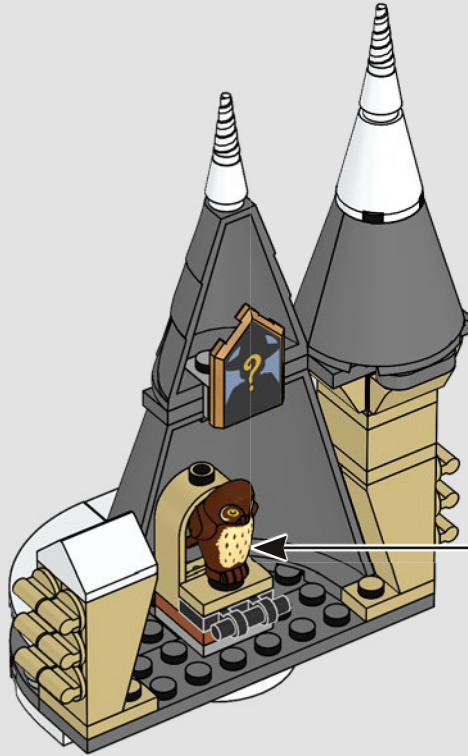
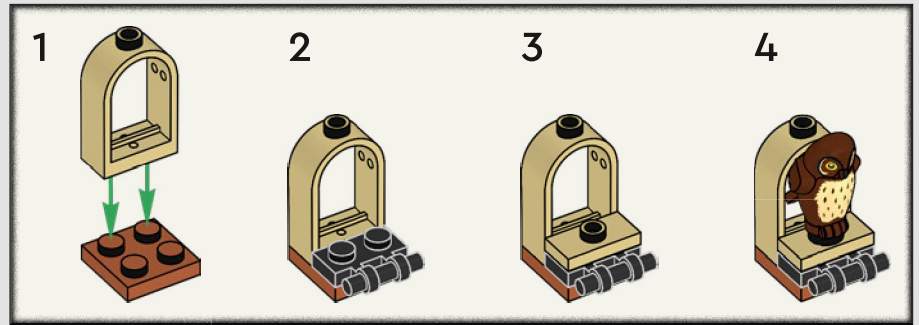

103

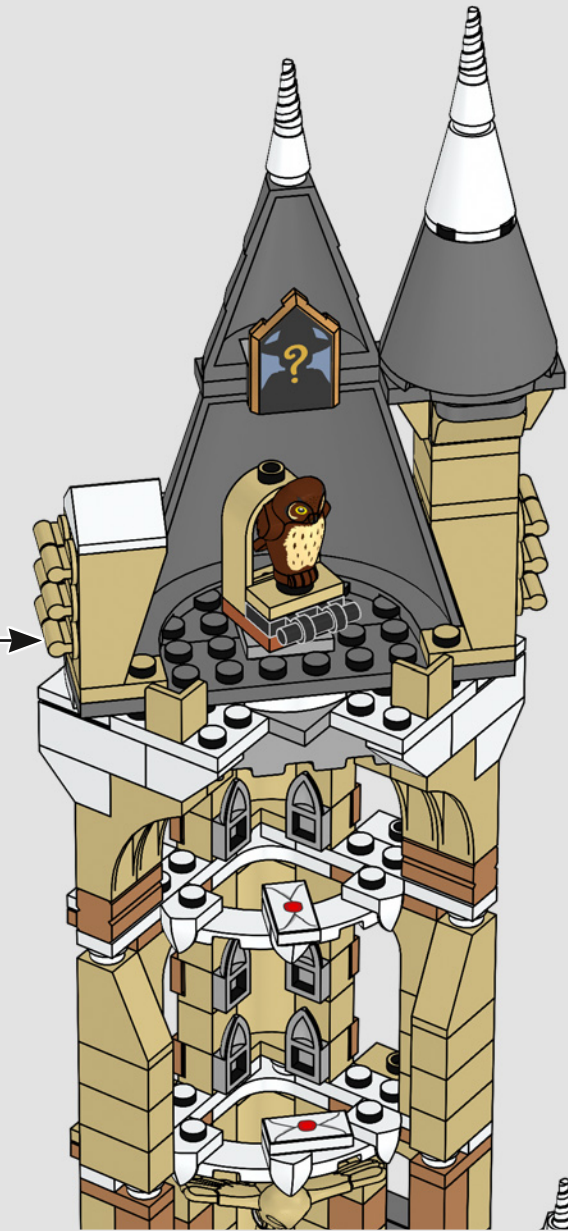



104

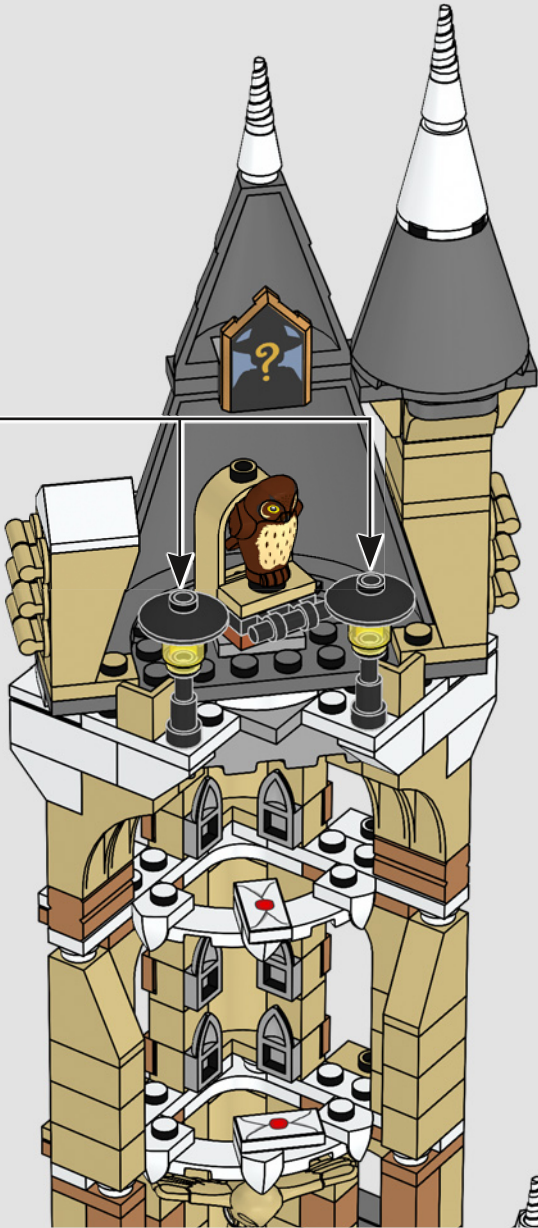
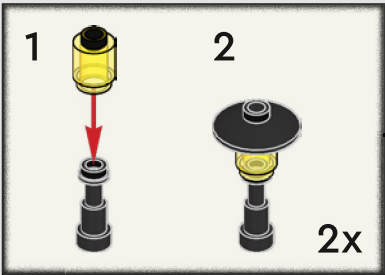

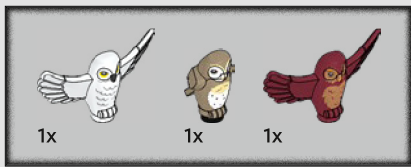

105

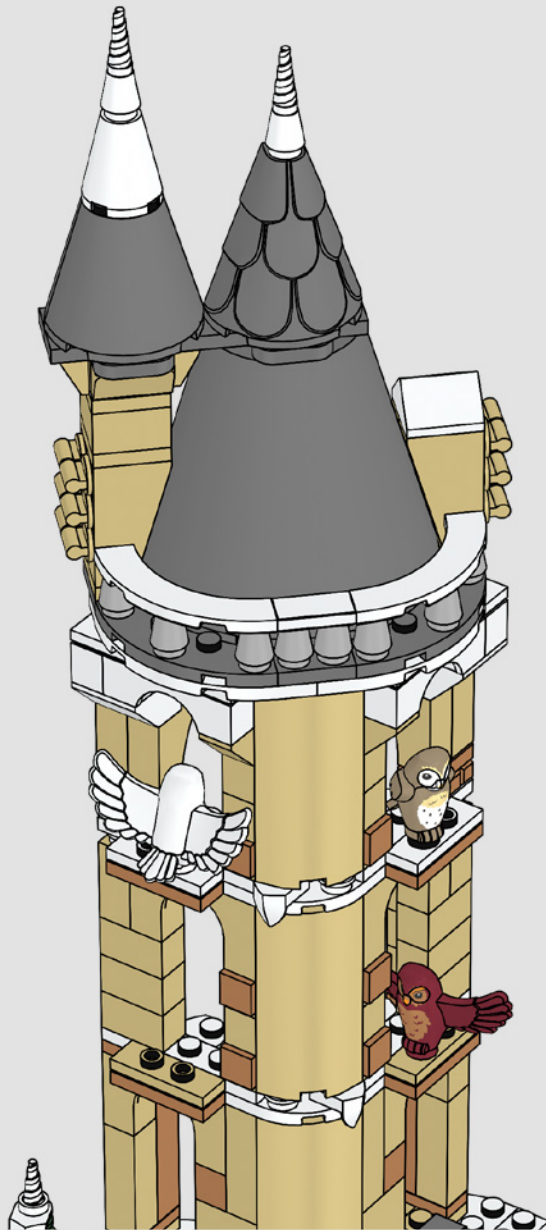





Harry Potter



Construisez
**LE CHÂTEAU
DE POUDLARD**
le plus détaillé

76426

Build the most detailed
**HOGWARTS™
CASTLE**

Construye
**EL CASTILLO
DE HOGWARTS™**
más detallado



76430

Each set sold separately and available for different periods of time

Les ensembles sont vendus séparément et à des périodes différentes.

Cada set se vende por separado y está disponible durante un cierto período de tiempo.

Collect all 14 Portraits

Portrait tiles are packed randomly
in the sets.

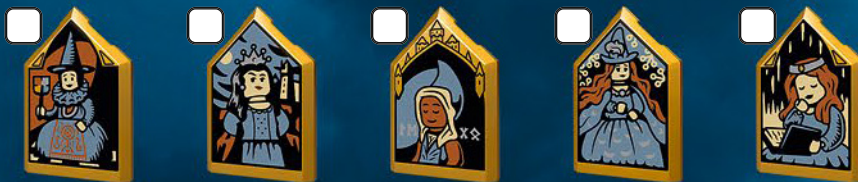

Collectionnez les 14 portraits

Les tuiles de portraits sont emballées au
hasard dans les ensembles.

Colecciona los 14 retratos

Las cubiertas con retratos se incluyen en
los sets de forma aleatoria.



 3x 6192793	 2x 6366391	 2x 4178429	 2x 4612603	 1x 6092587	 1x 6435972	 1x 6467915
 6x 614101	 1x 6371464	 4x 6399559	 2x 4159553	 1x 4114026	 1x 6399008	 1x 6270032
 2x 4518400	 2x 6195371	 2x 6457244	 6x 4118793	 6x 4124455	 1x 6265371	 1x 6481084
 2x 4504369	 2x 362201	 1x 6287854	 6x 4113915	 2x 4114077	 1x 6236686	 1x 6480305
 2x 6172366	 2x 302101	 2x 6057986	 4x 6057517	 2x 4114084	 2x 6315782	 1x 6284586
 12x 6046905	 2x 371001	 6x 6177146	 2x 4626200	 1x 4114306	 1x 6228968	 1x 6270028
 3x 6382783	 4x 365901	 2x 6339311	 4x 6030731	 2x 4121921	 1x 4615606	 1x 4596335
 1x 6044601	 1x 4515347	 2x 4656783	 1x 4623514	 2x 6211966	 1x 6353937	 1x 4211157
 1x 6439714	 2x 6339103	 4x 6218360	 4x 6030731	 2x 6404700	 1x 6265367	 1x 4221886
 2x 366501	 1x 6299912	 4x 6336665	 2x 4642933	 4x 6058093	 1x 6226594	 1x 6092590
 2x 6299836	 2x 4560178	 4x 6336665	 2x 4159279	 4x 6031057	 11x 6092591	 1x 6401304
 1x 306901	 4x 6350399	 12x 6472548	 2x 4159279	 4x 6031057	 1x 6166127	 1x 4538252
 2x 242001	 1x 6254335	 2x 4529237	 3x 6318113	 1x 6472549		
 2x 6058329		 4x 4624086		 2x 4124067		

15x
4529241

1x
6467916

8x
4211389

6x
6213644

1x
6345426

1x
4211732

1x
4540203

3x
4211437

1x
4654582

1x
4211413

3x
4211387

1x
4211349

1x
6126082

2x
4211489

4x
4211386

7x
4211435

1x
6039346

1x
6045718

1x
4211406

1x
4211474

1x
4211405

1x
4558954

2x
6172383

2x
302426

1x
6402958

2x
6438919

1x
6365482

2x
6024730

2x
474026

3x
4538456

1x
6234806

1x
4140588

1x
368026

1x
300326

2x
362226

1x
4517986

7x
4210633

1x
6396489

4x
6332045

3x
6221607

1x
4567887

2x
6056296

2x
4211095

2x
4210978

2x
4211052

1x
4211001

1x
4211065

1x
6458171

2x
6106191



1x
6232139



1x
4500517



1x
4210678



1x
4210998



2x
6235153



1x
6230280



2x
4222042

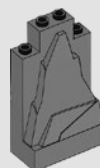

2x
4513326

1x
6285587

2x
6238674

5x
6230571

4x
6400754

2x
6447541

1x
6481813

2x
6002841

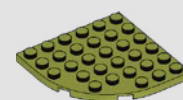

1x
6218088

2x
6248908

2x
6190252

1x
6478297

1x
6482585

1x
6263969

1x
6482586



 [LEGO.com/service](https://www.LEGO.com/service)

YOU COULD **WIN**



Scan this QR code or go to **LEGO.COM/PRODUCTFEEDBACK** and give us your short feedback about this LEGO® set for a chance to win a cool LEGO prize.

Terms and Conditions apply*

EN: YOU COULD WIN. Terms and Conditions apply* **DE: Du könntest GEWINNEN.** Es gelten die Teilnahmebedingungen* **FR: Tu pourrais GAGNER.** Des conditions s'appliquent* **IT: Potresti VINCERE tu.** Termini e condizioni sono applicabili* **ES: Puedes GANAR.** Aplican términos y condiciones* **PT: Poderá GANHAR.** Aplicam-se termos e condições* **ZH: 轻松获奖. 条款和条件适用*** **PL: Szansa na WYGRANĄ.** Obowiązują warunki korzystania* **CS: Máte šanci VYHRÁT.** Platí všeobecné smluvní podmínky* **SK: Máte šancu VYHRAŤ.** Platia všeobecné zmluvné podmienky* **HU: TE IS NYERHETSZ.** Felhasználási feltételek érvényesek* **RO: Ai putea CÂȘTIGA.** Se aplică termeni și condiții* **BG: Можете да СПЕЧЕЛИТЕ.** Има определени правила и условия* **LV: Tu vari LAIMĒT.** Ir spēkā noteikumi un nosacījumi.* **ET: Sul on võimalus VÕITA.** Kehtivad tingimused* **LT: Jūs galite LAIMĖTI.** Taikomos sąlygos*

*[LEGO.com/productfeedback-terms](https://www.lego.com/productfeedback-terms)

LEGO and the LEGO logo are trademarks of the/son des marques de commerce du/son marcas registradas de LEGO Group. ©2024 The LEGO Group.

WIZARDING WORLD and all related trademarks, characters, names, and indicia are © & ™ Warner Bros. Entertainment Inc. Publishing Rights © JKR. (s24)