



# STAR WARS

TM



7959



1

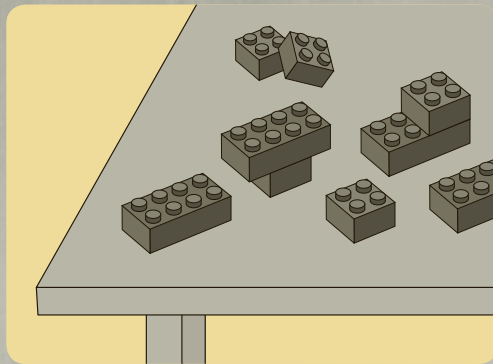
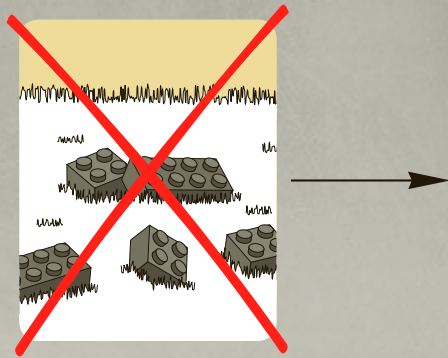

2

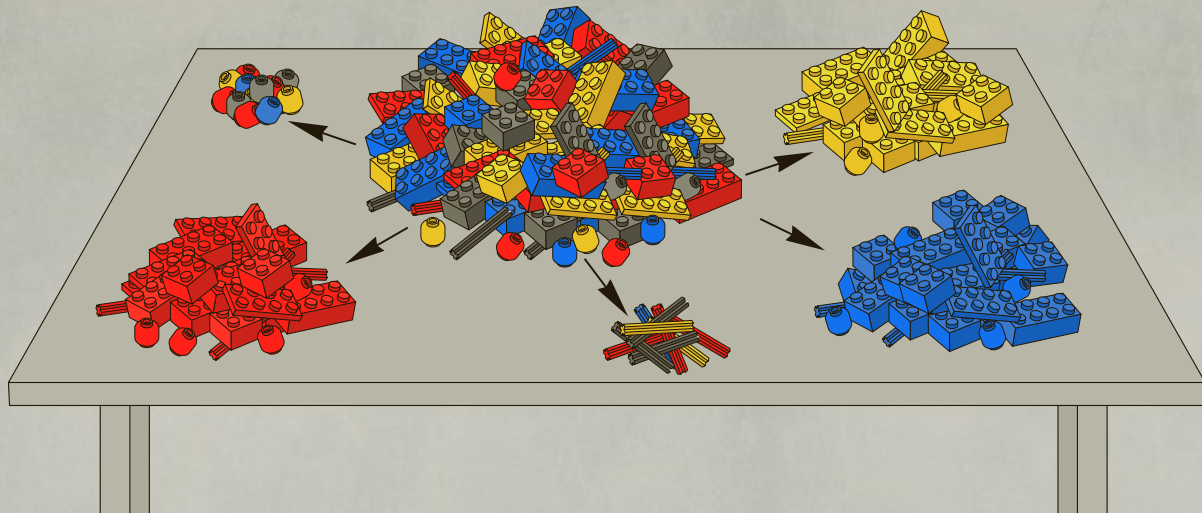

3

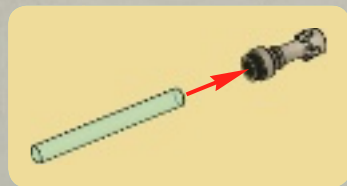
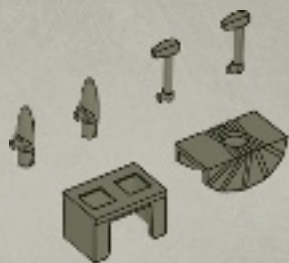
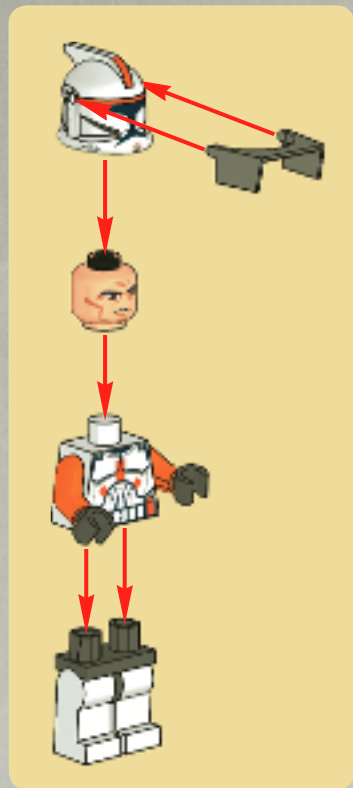



1

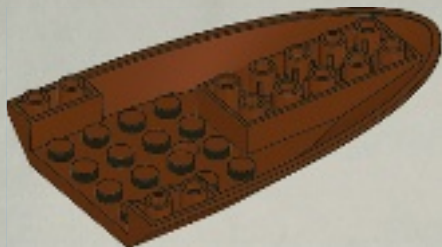

4



2

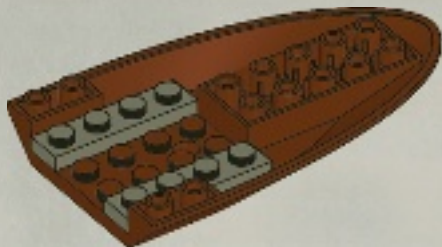



2x

3

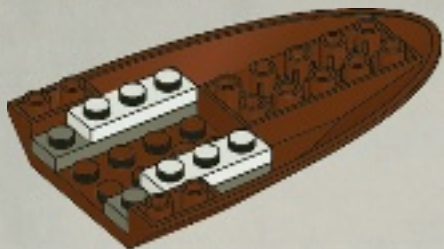

1x



1x



1x

4

1

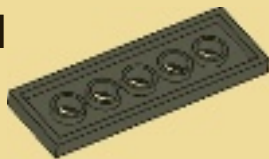

2

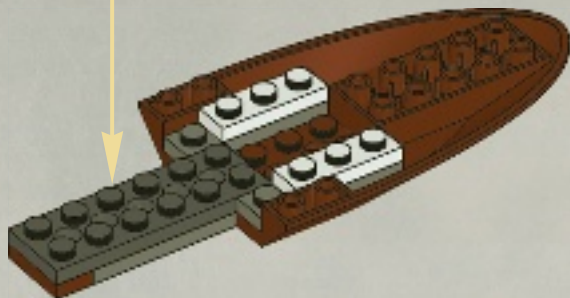
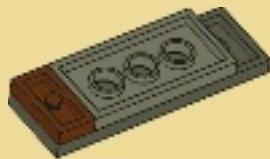



2x

5

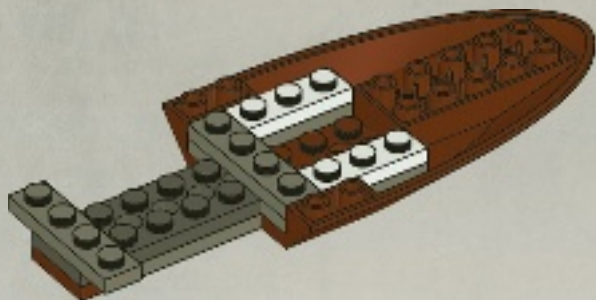

1x



2x

6

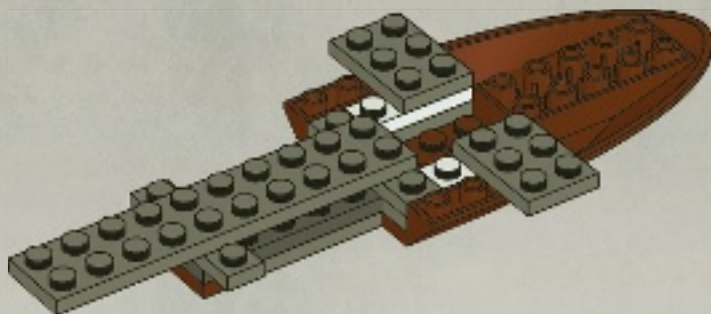



2x

7

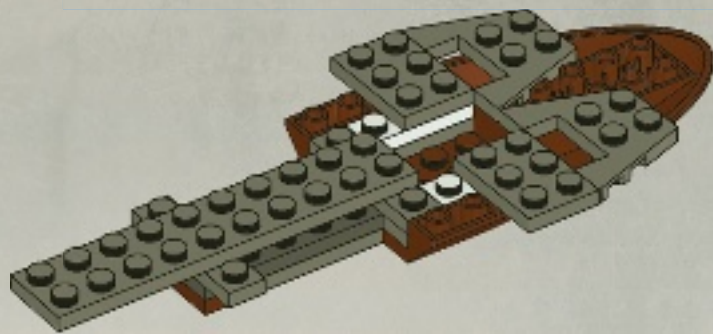



1x

8

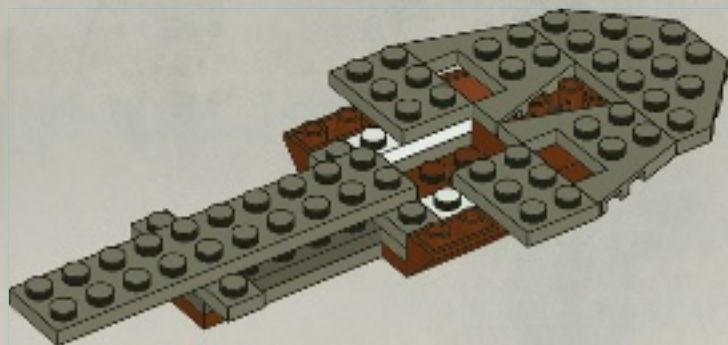



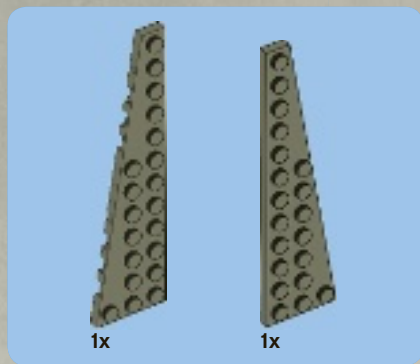

9

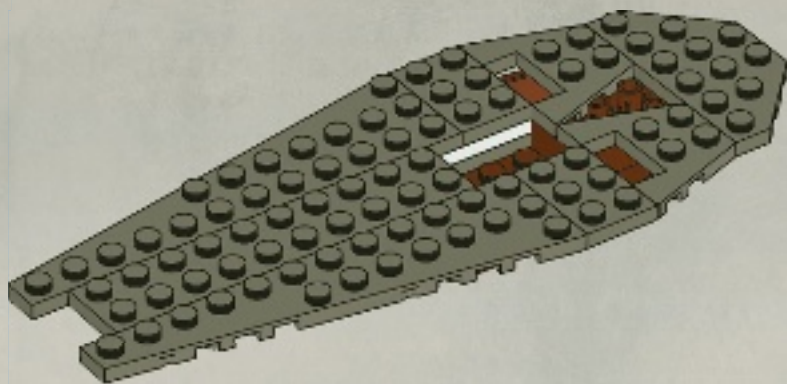



2x



1x

# 10

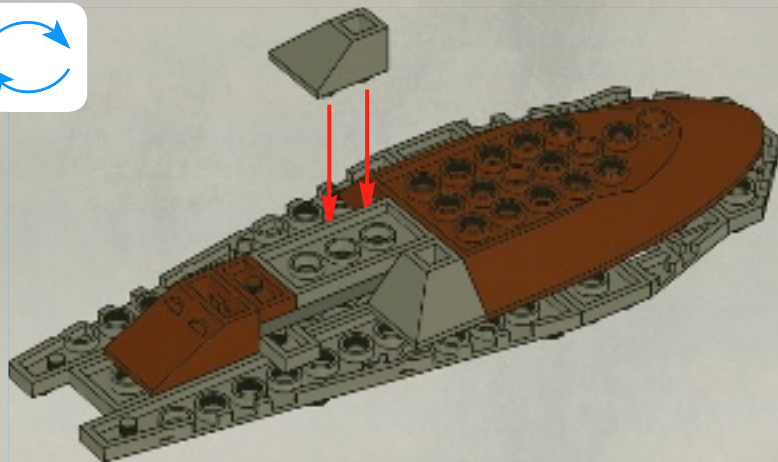



2x



1x



1x

# 11

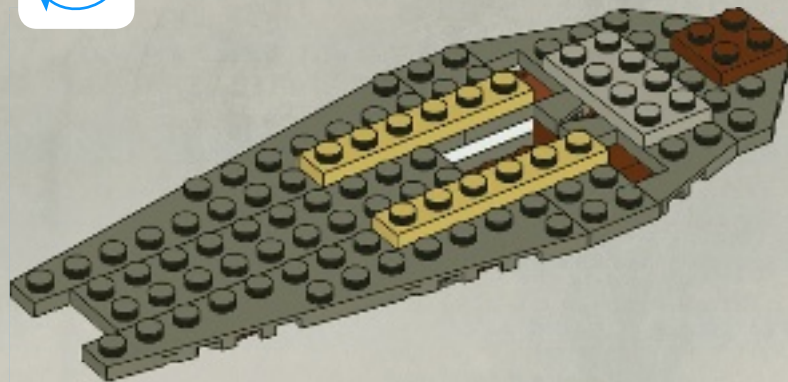



2x



2x

# 12

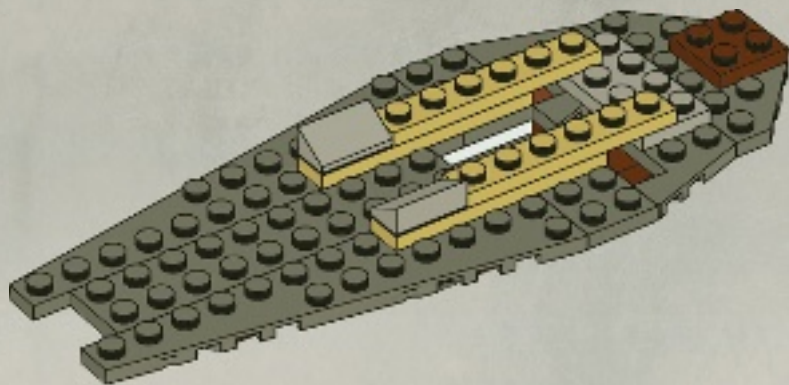



2x



1x

# 13

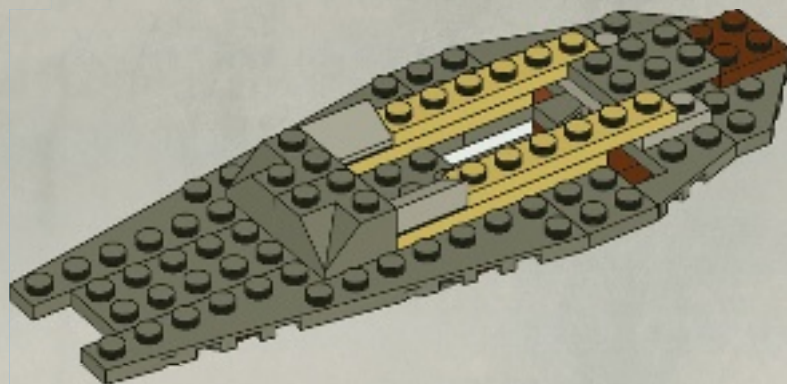



2x



2x

# 14

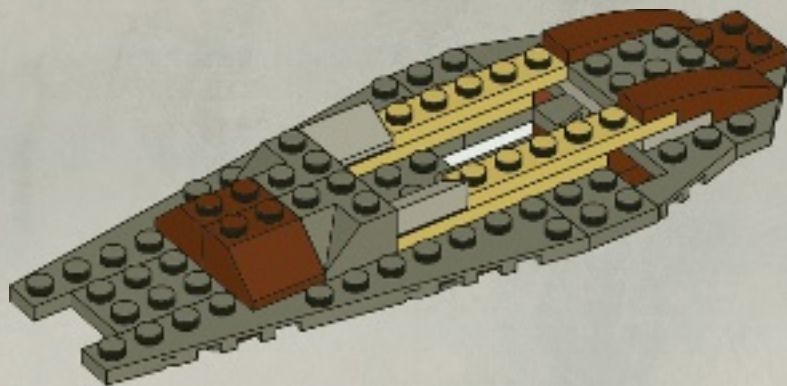



1x



1x

# 15

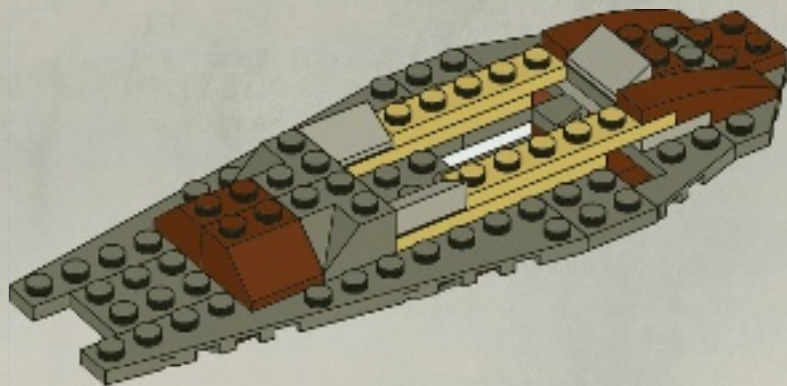



2x



2x

# 16

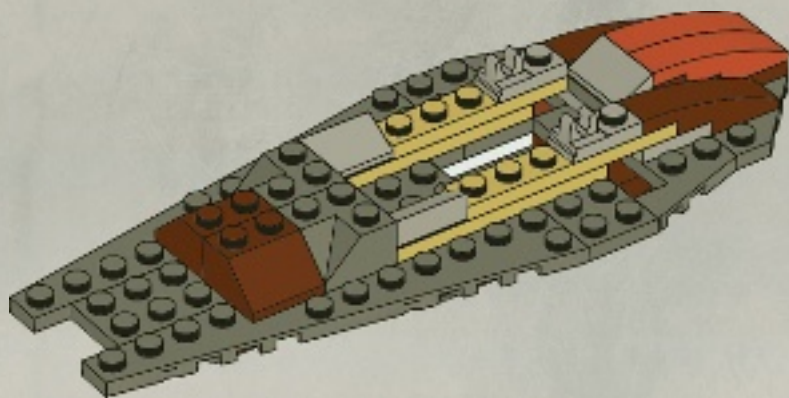





2x



2x

# 17

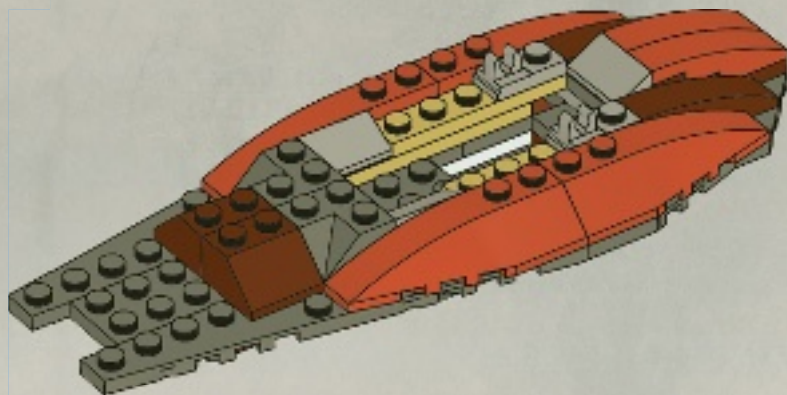

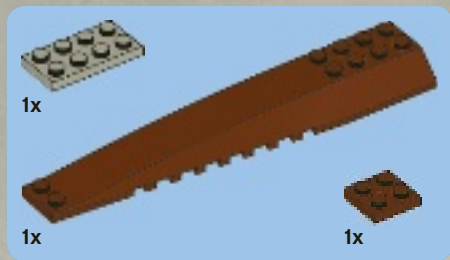

18

1

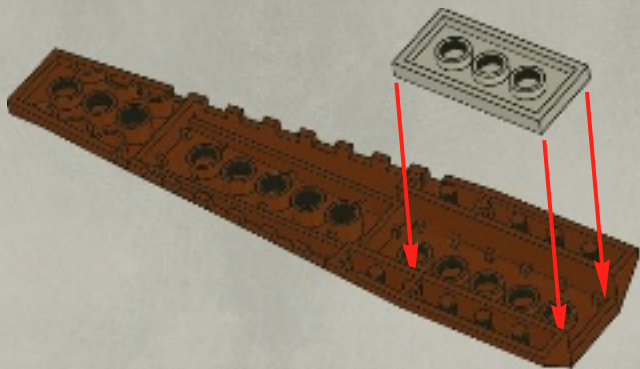

2

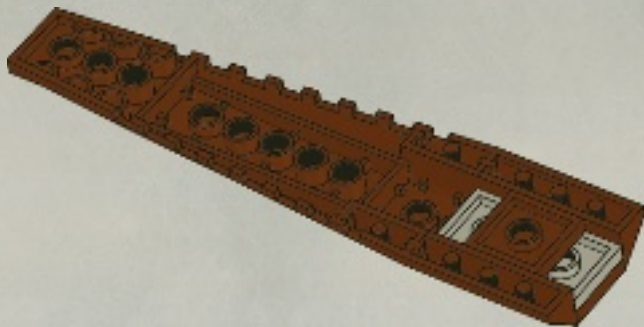

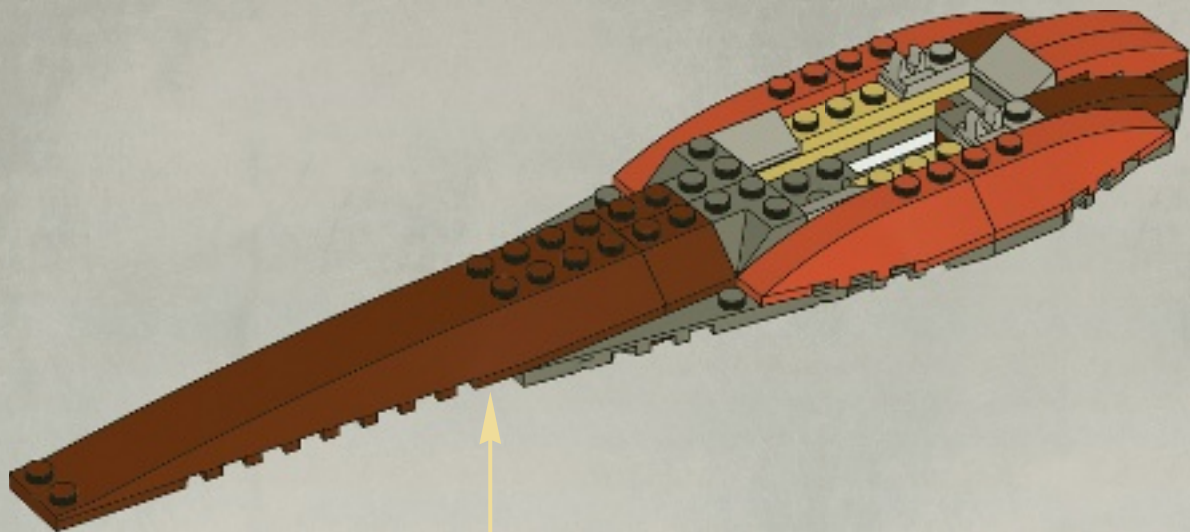



1x



1x

# 19

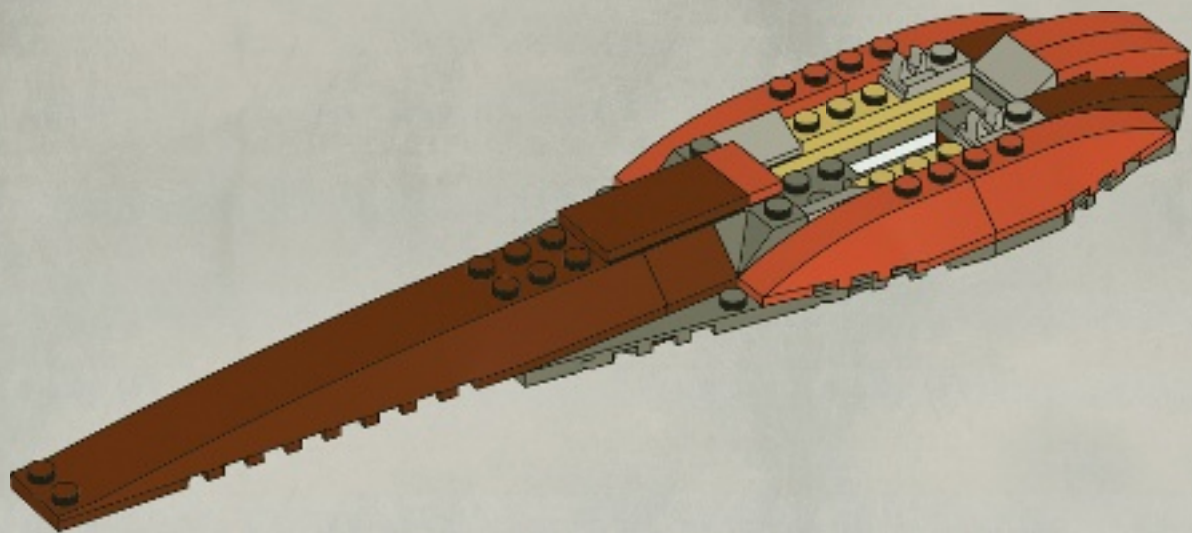

20



20

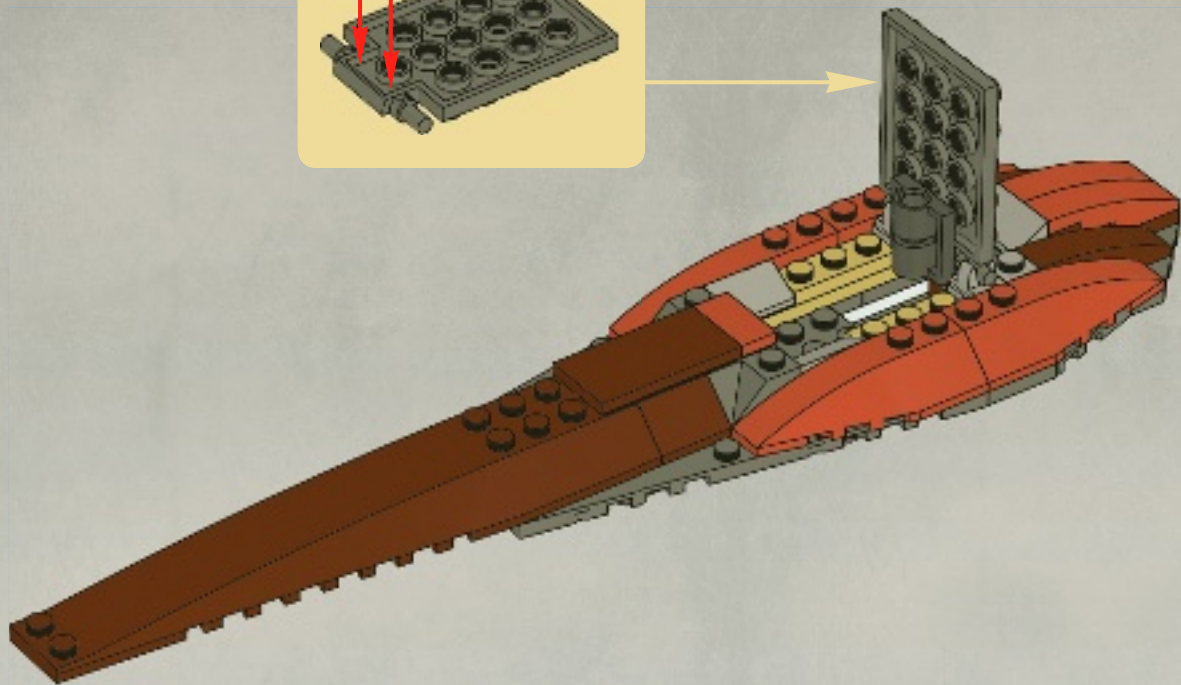
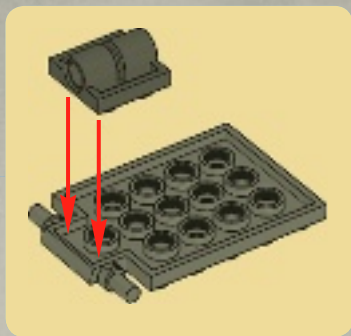



1x



1x



1x



1x

# 21

## 1



## 2



## 3



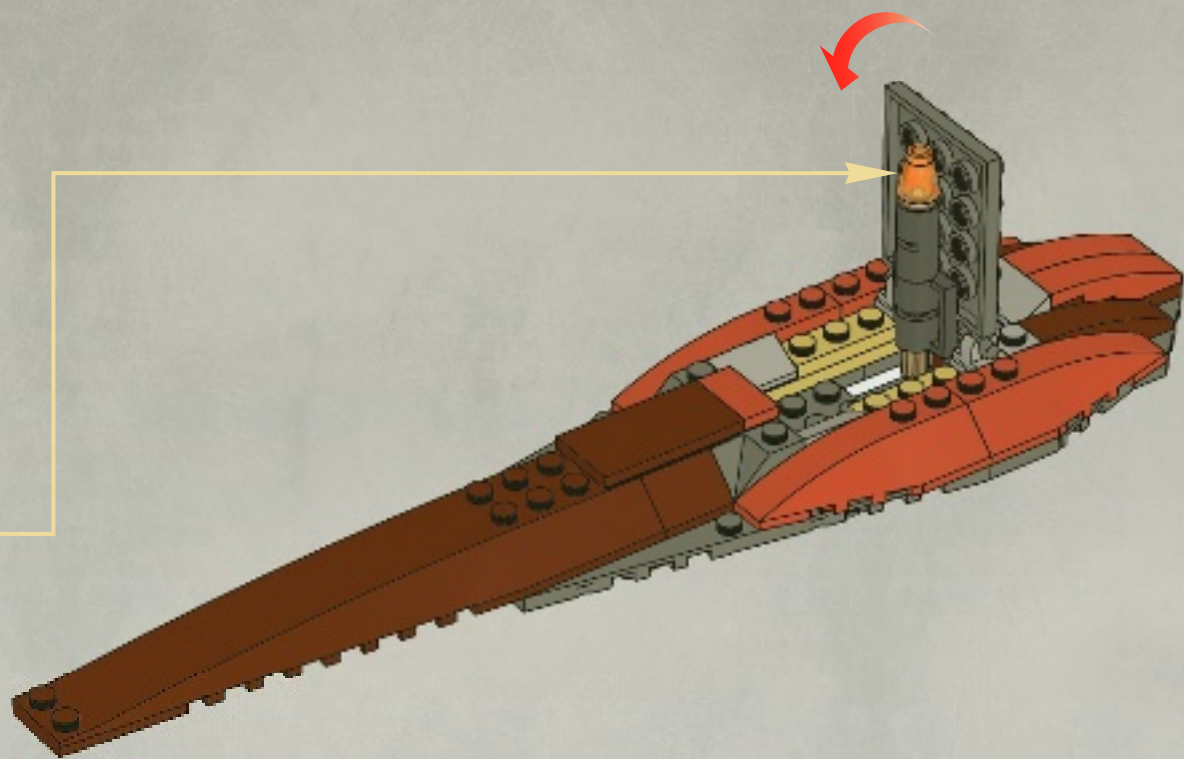



22

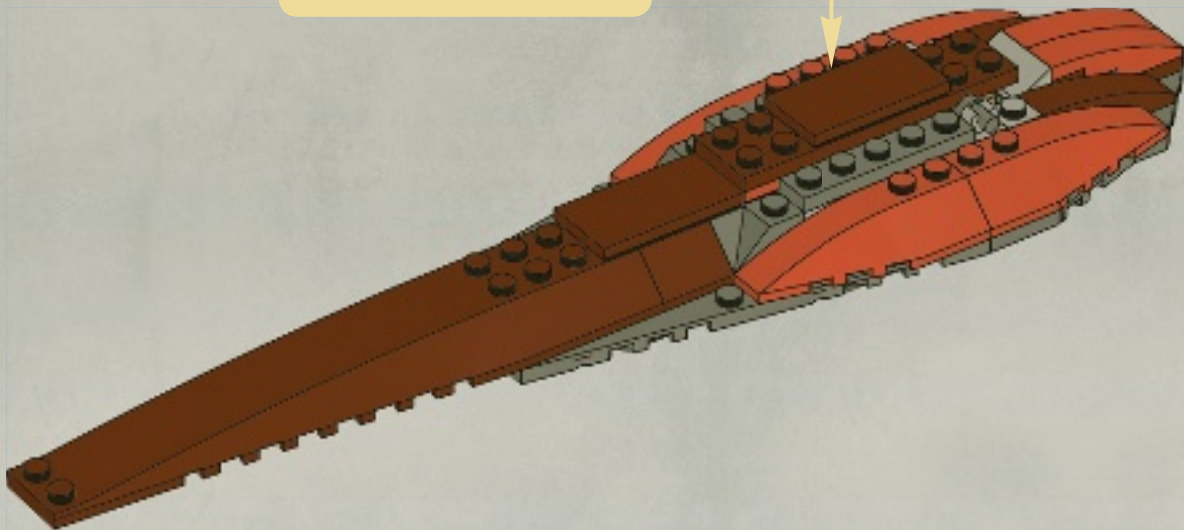
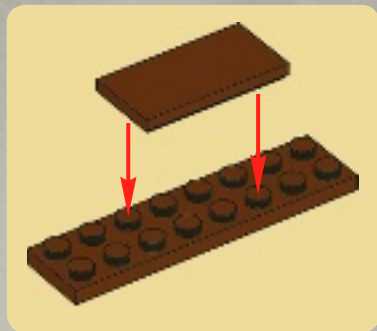





23



2



3



4

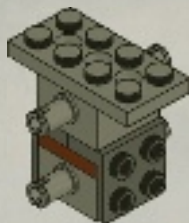

5

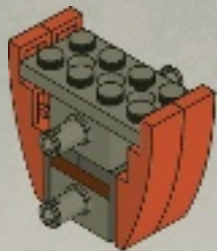

6

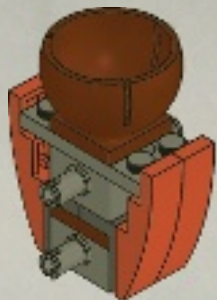

7

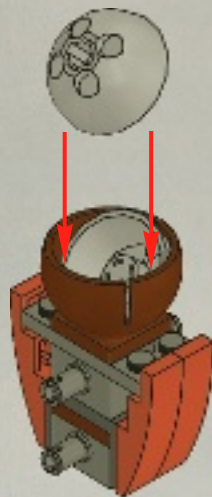

8

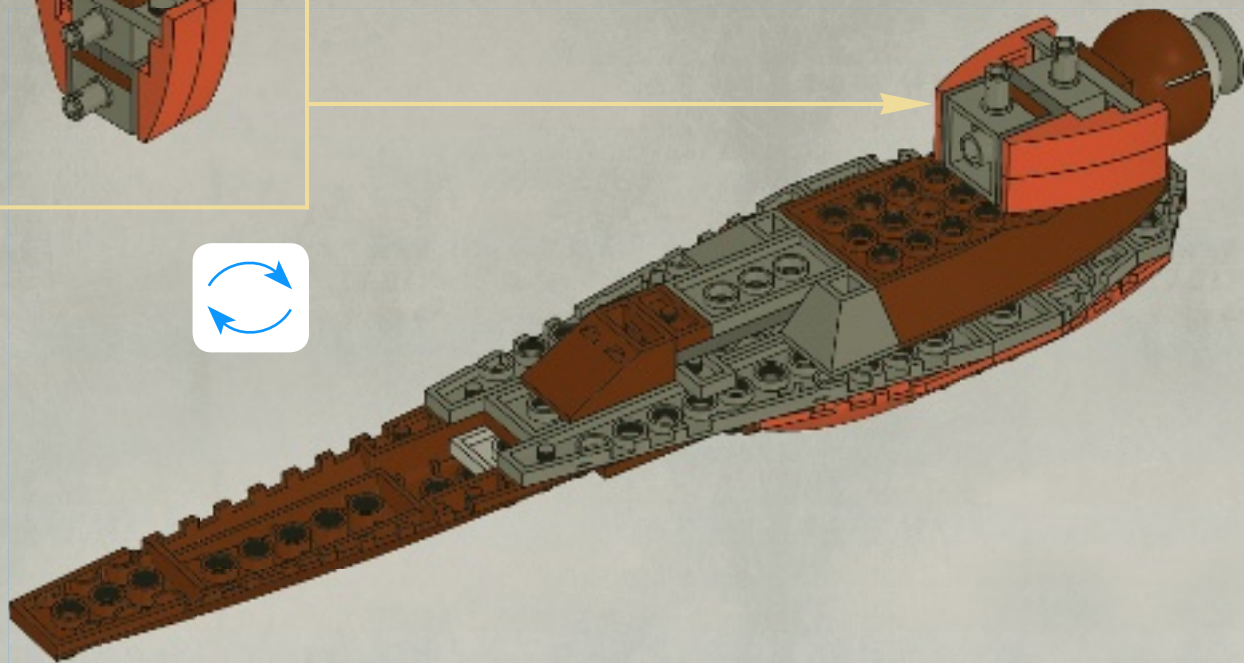
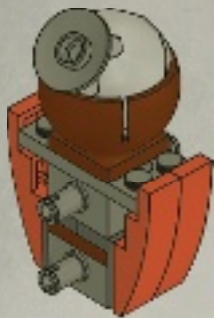



24

1

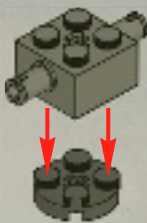

2



3



4



5

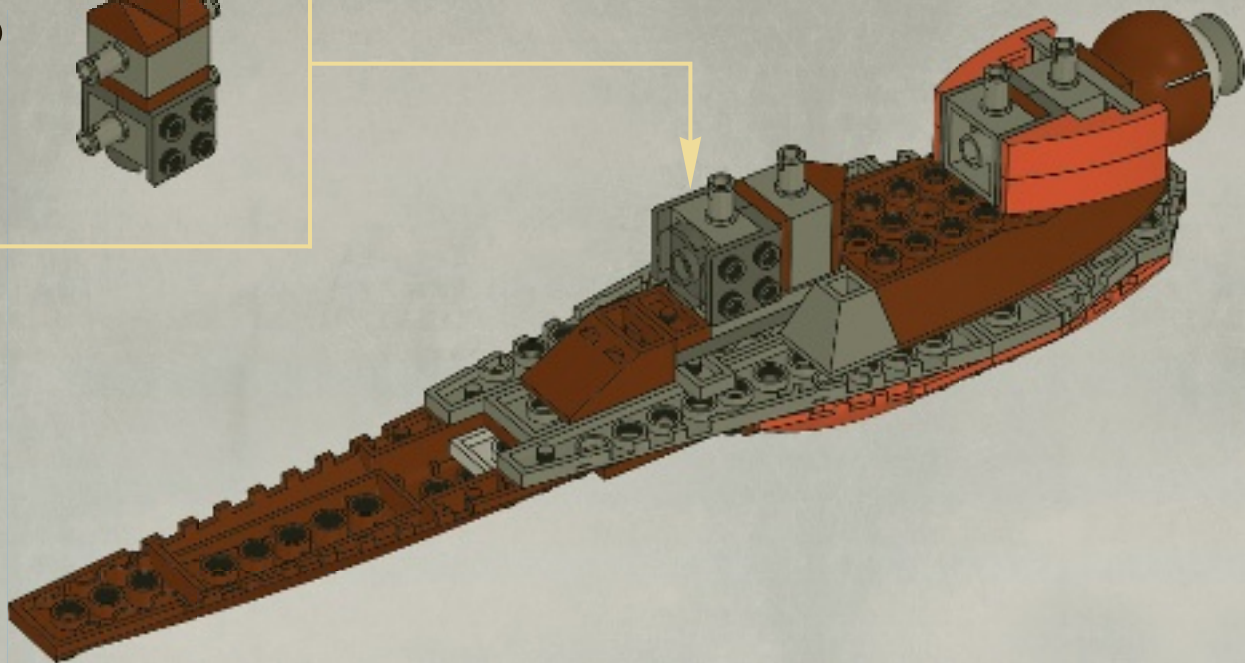



25

1



2



3

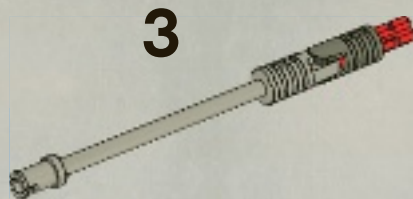

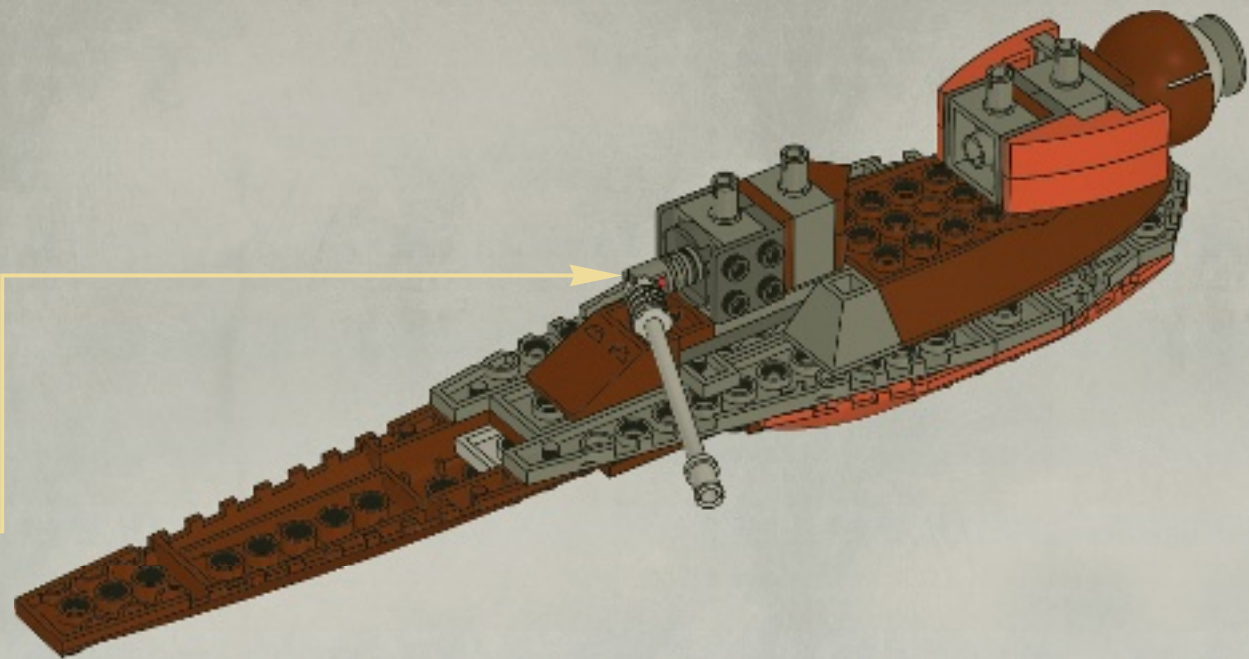



2x

26

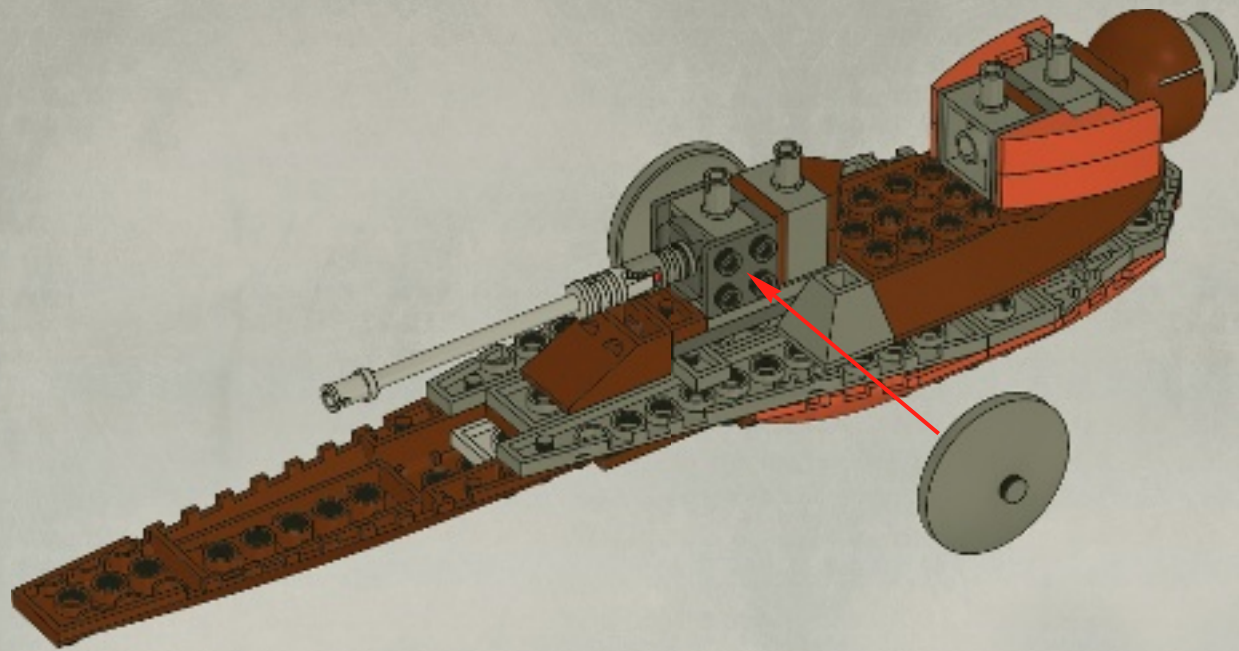





1

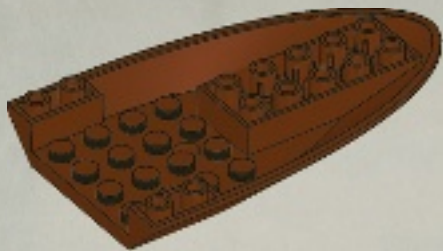

2

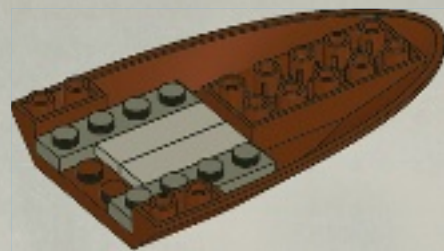



2x

3

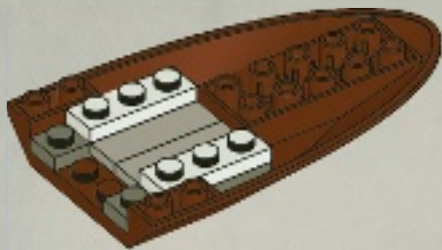

1x



1x



1x

4

1

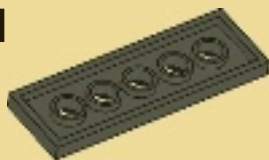

2

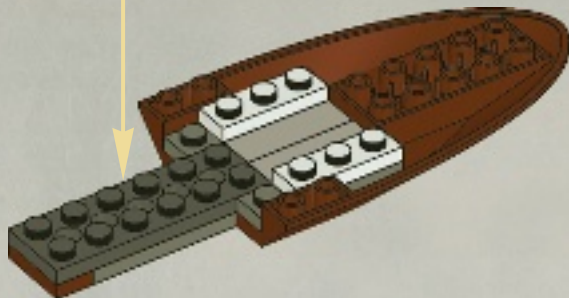
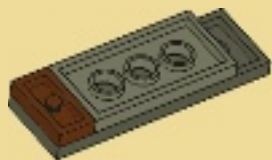



2x

5

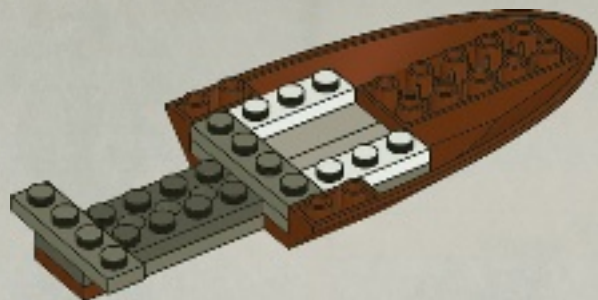

1x



2x

6

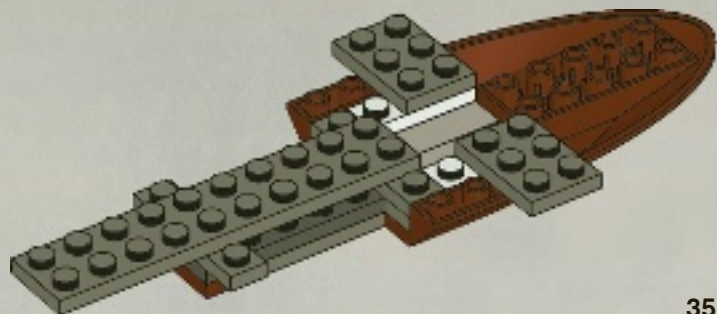



2x

7

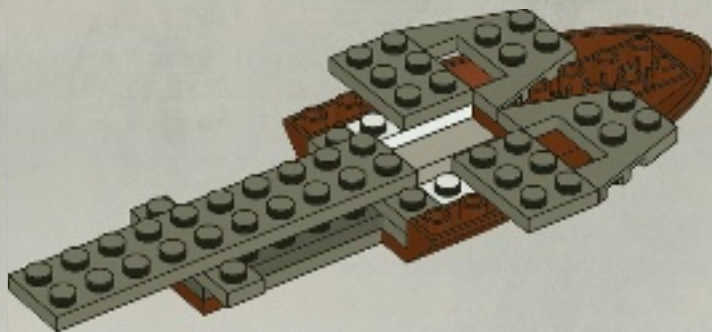



1x

8

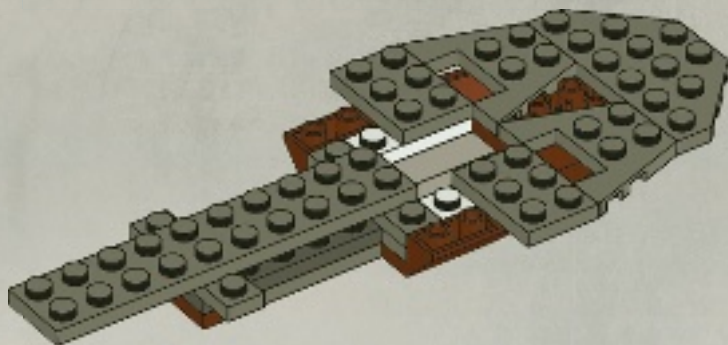

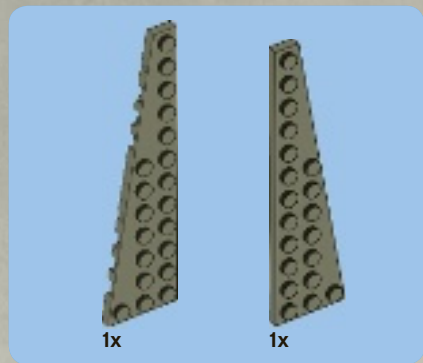

9

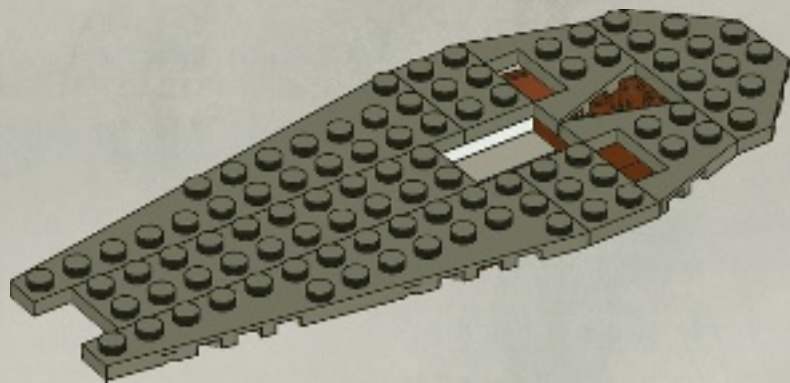



2x



1x

# 10

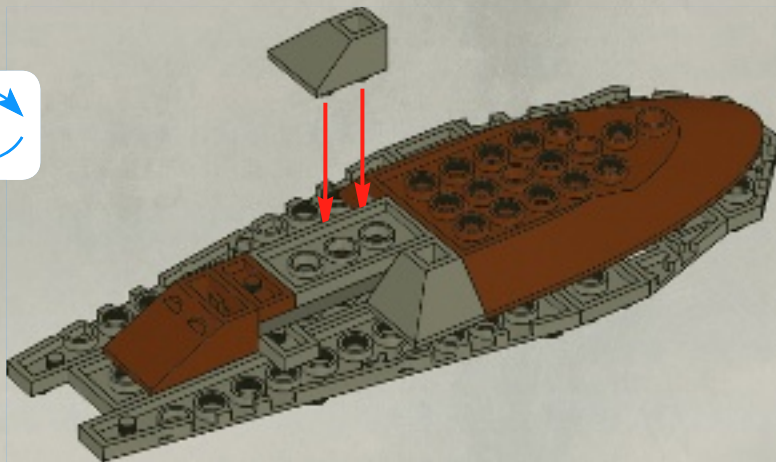



1x



1x



1x

# 11

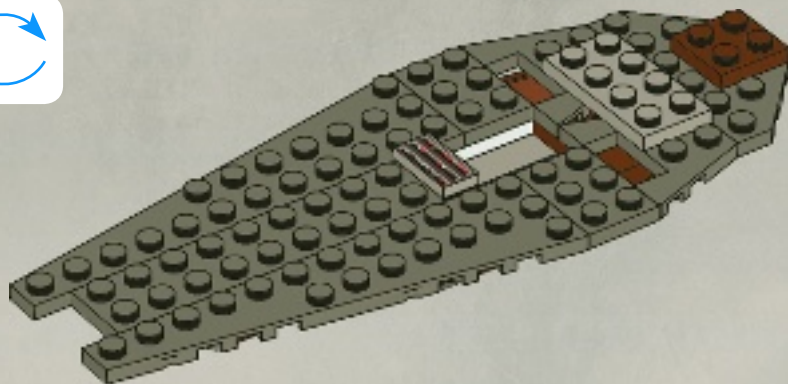





2x

12

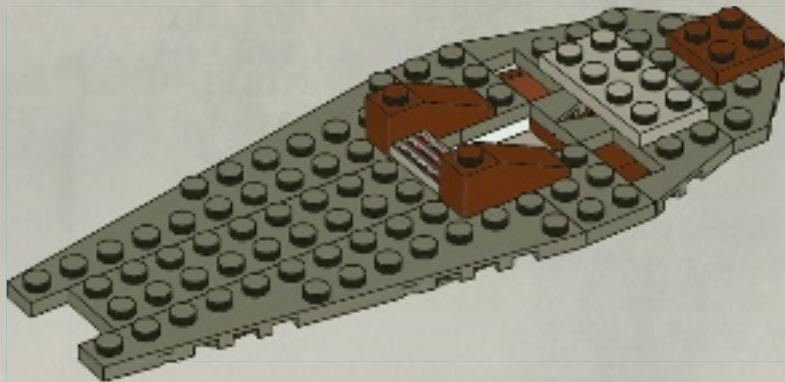



1x



2x

# 13

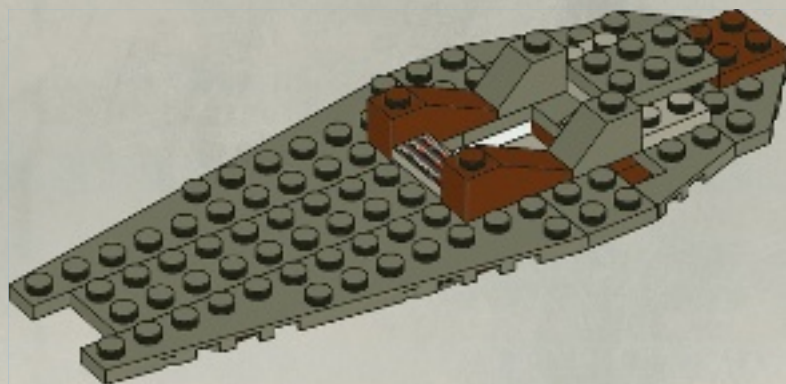



1x



2x

14

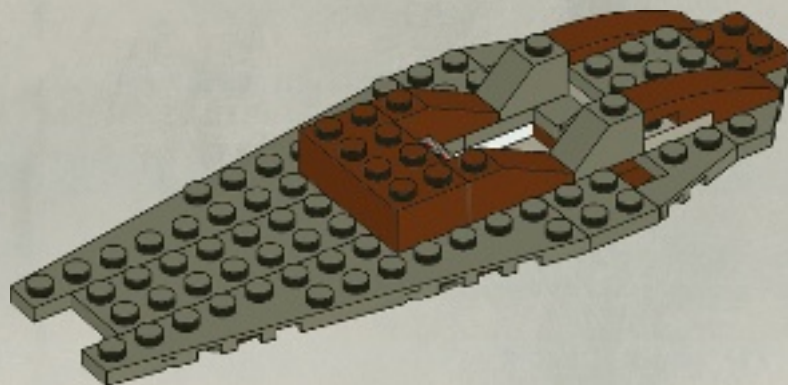



2x



1x



1x

# 15

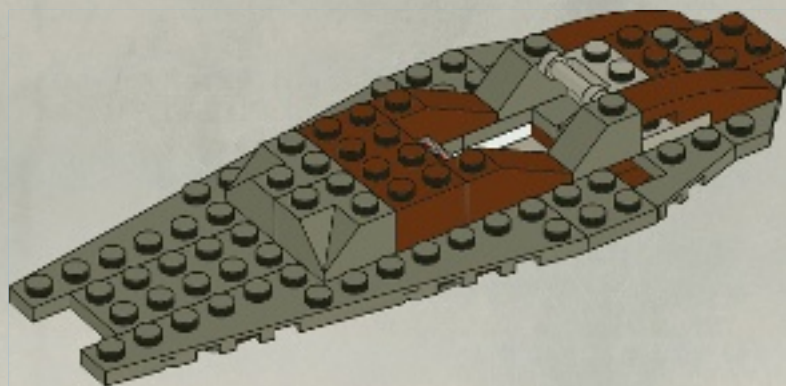



2x



2x

16

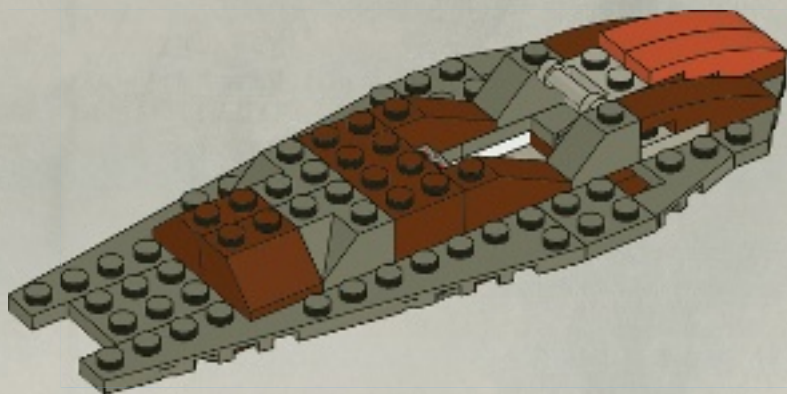

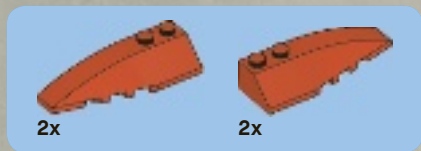

17

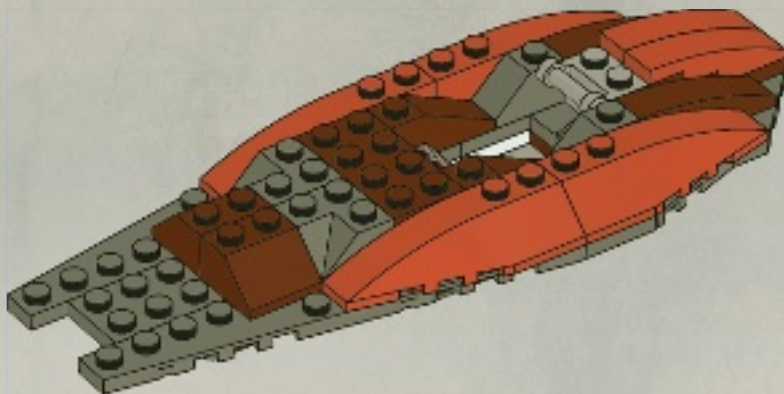

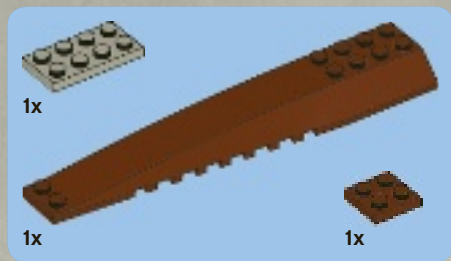

18

1

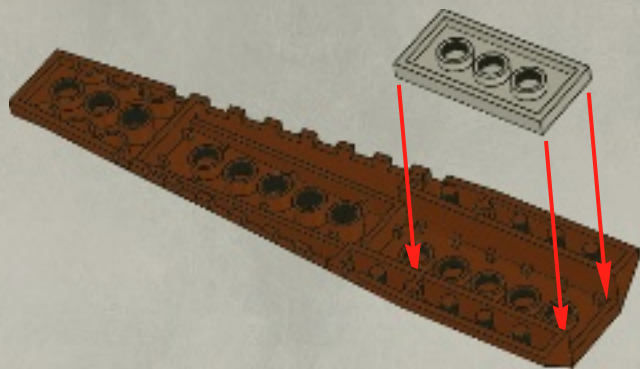

2

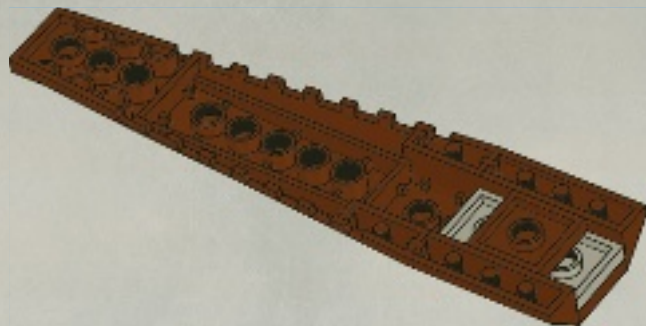

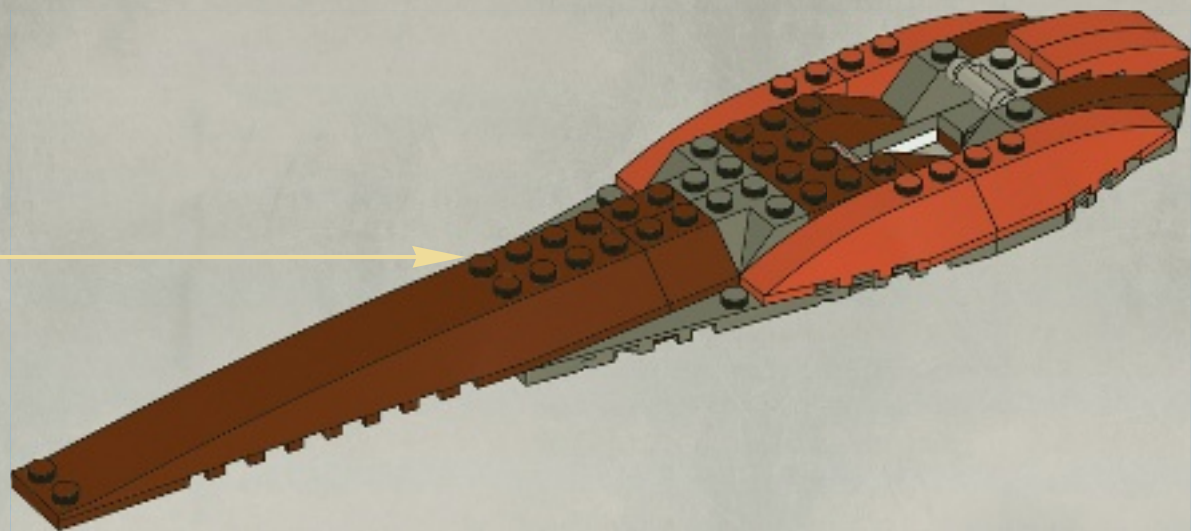





1x



2x

# 19

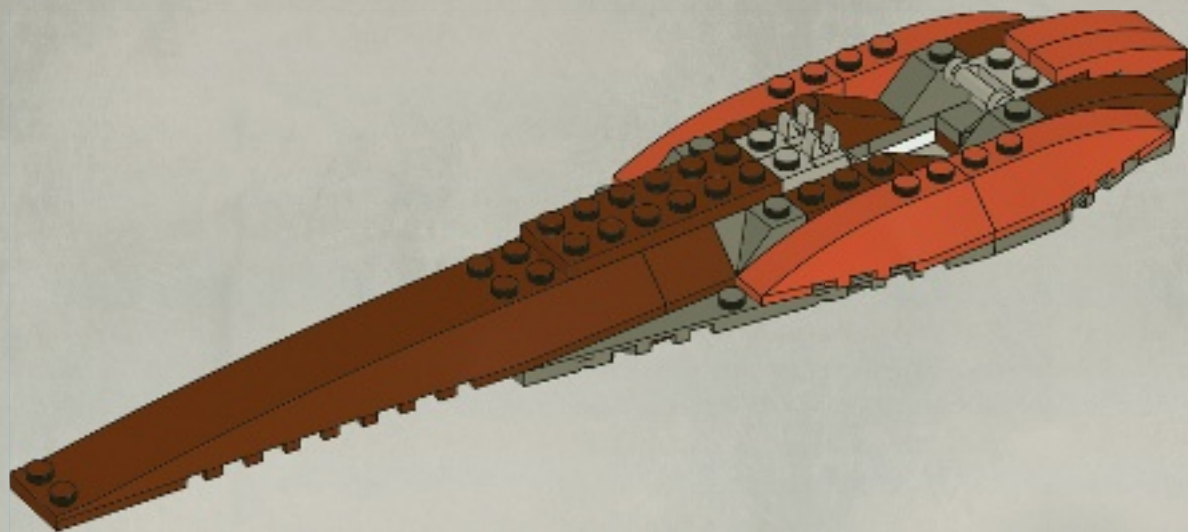



1x

20

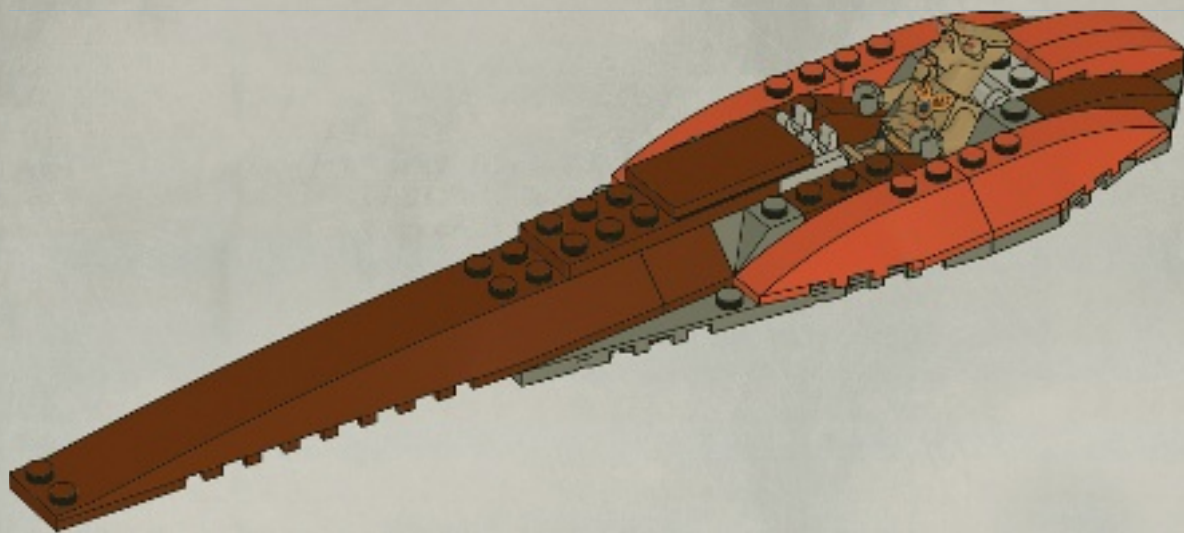



1x

21

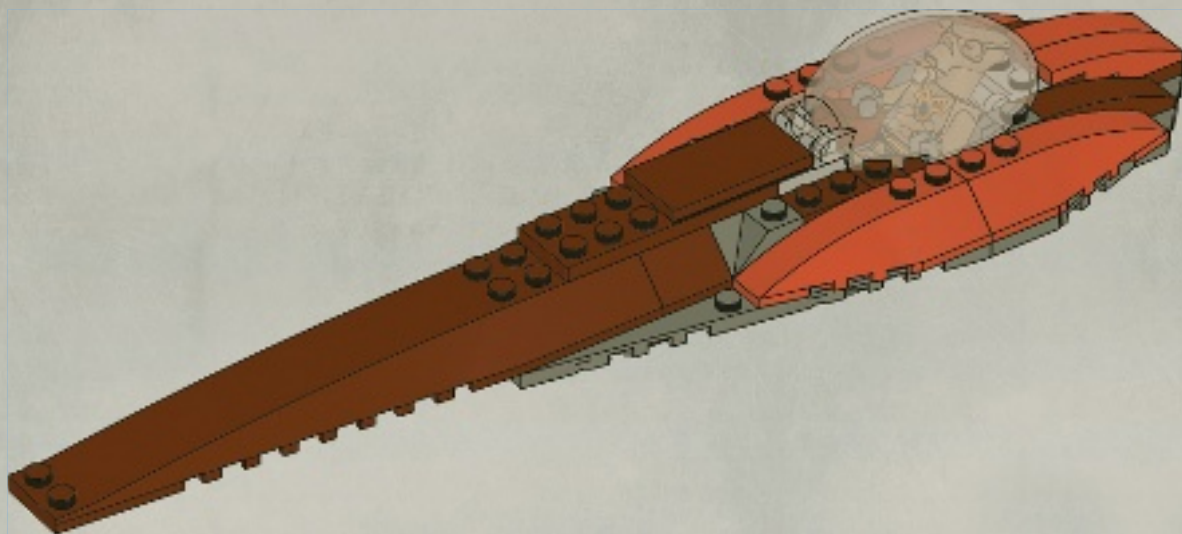



22

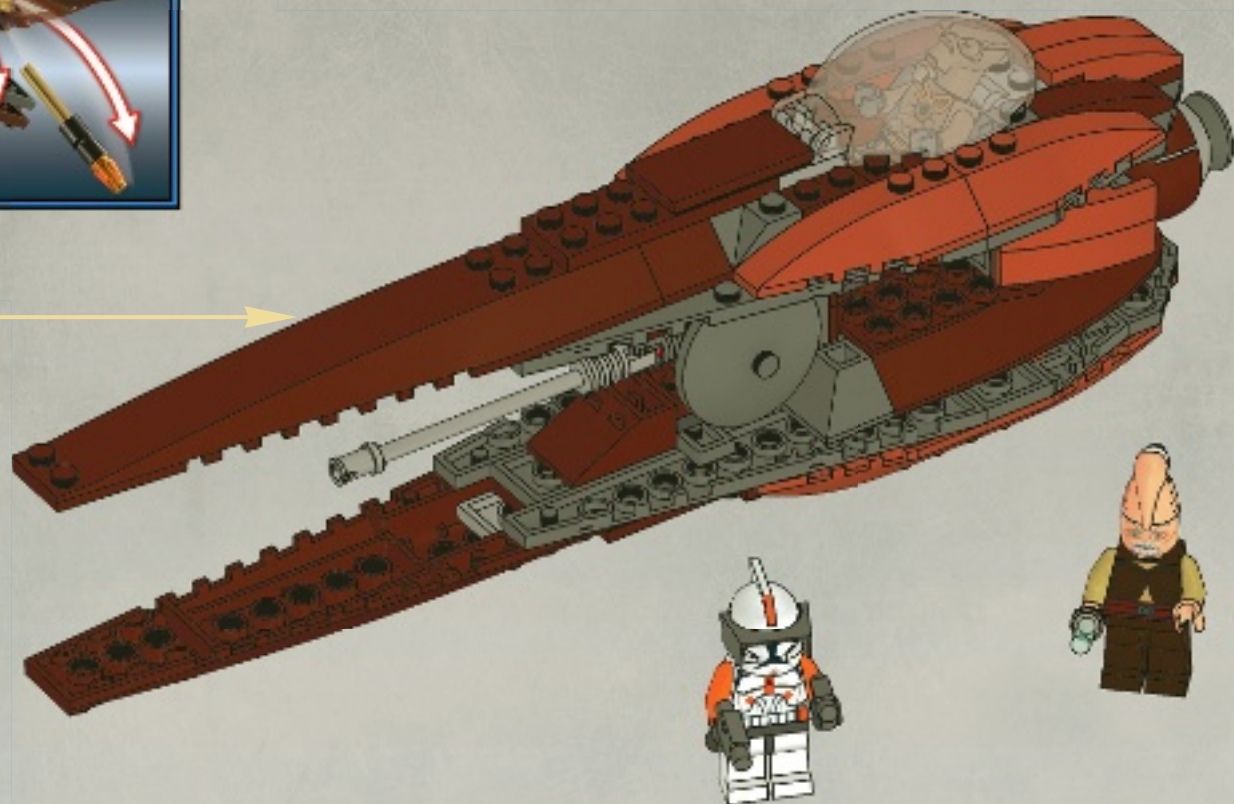



Customer Service

Kundenservice

Service Consommateurs

Servicio Al Consumidor

[www.lego.com/service](http://www.lego.com/service) or dial

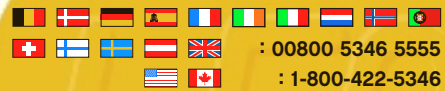

: 00800 5346 5555

: 1-800-422-5346



7956



7957



7961



7962



www.LEGOclub.com



LEGO Club Email



LEGO Club Magazine

**LEGO club**

**FREE! GRATIS! GRATUIT!**

**SIGN UP ONLINE!**

**www.LEGOclub.com**



**00800 5346 5555\***



**1-866-534-6258 • 1-877-518-5346**

US & Canada only

Outside continental

- \* Freephone. Mobile charges may apply.
- \* Numéro sans frais. Des frais peuvent s'appliquer avec les téléphones cellulaires.
- \* Gebührenfrei, Kosten für Anrufe aus Mobilfunknetzen können abweichen.
- \* Gratis telefonnummer vanaf vaste lijn.
- \* Det er et gratis nummer, når du ringer fra fasttelefon.
- \* Det är gratis, när du ringer från en fast telefon.
- \* Numéro sans frais. Des frais peuvent s'appliquer avec les téléphones portables.

# WIN!

Go to [www.LEGOsurvey.com/product](http://www.LEGOsurvey.com/product) to fill out a survey for a chance to win a cool LEGO® Product.

No purchase necessary.

Open to all residents where not prohibited.

## [www.LEGOsurvey.com/product](http://www.LEGOsurvey.com/product)

### GEWINNE!

Nimm an der Umfrage auf [www.LEGOsurvey.com/product](http://www.LEGOsurvey.com/product) teil und hab die Chance ein cooles LEGO® Produkt zu gewinnen!

Die Teilnahme am Gewinnspiel führt zu keinerlei Kaufverpflichtungen. Teilnahme in allen nicht ausgeschlossenen Ländern möglich.

### WIN!

Ga naar [www.LEGOsurvey.com/product](http://www.LEGOsurvey.com/product), vul een enquêteformulier in en maak kans op een cool LEGO® product.

Geen aankoopverplichting. Iedereen mag deelnemen, uitgezonderd ingezetenden van landen waar een enquêteverbod geldt.

### GAGNE !

Visite [www.LEGOsurvey.com/product](http://www.LEGOsurvey.com/product) pour répondre à un questionnaire et avoir une chance de gagner un produit LEGO® très cool !

Aucune obligation d'achat.

Ouvert à tous les résidents des pays autorisés.

### 当てよう!

[www.LEGOsurvey.com/product](http://www.LEGOsurvey.com/product) にアクセスして、アンケートにご記入ください。当選者にはレゴ®製品を差し上げます。

お買い上げの必要はありません。

禁止されていない限り、すべての皆様にご利用いただけます。