

BIONICLE

MANAS

9+



LEGO TECHNICAL

8539



1



2



3

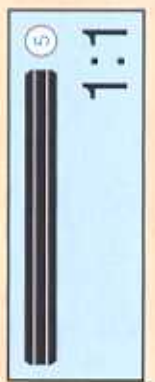
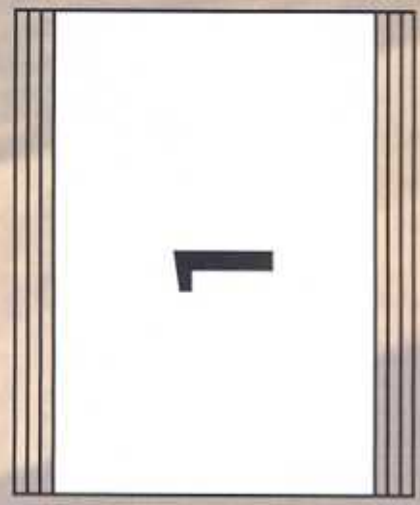
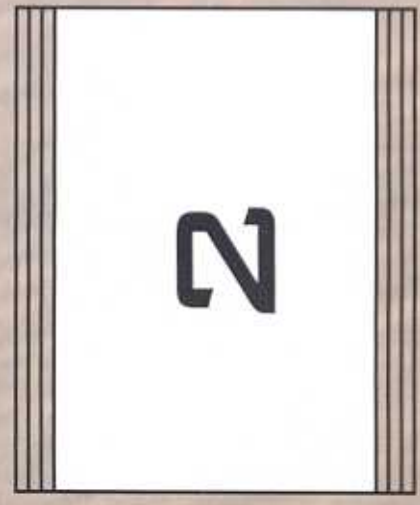
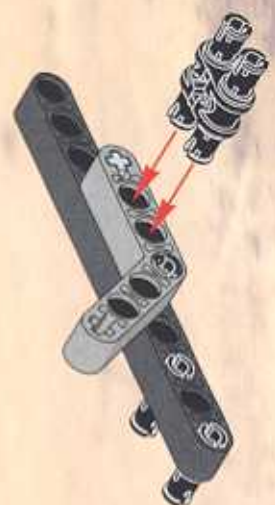

- 1x [Grey Technic Pin]
- 2x [Grey Technic Pin]
- 2x [Grey Technic Axle]

4

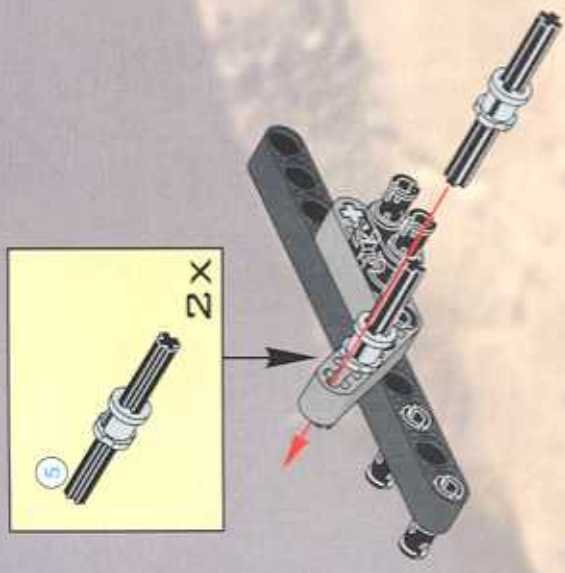

- 2x [Grey Technic Axle]

- 1x [Grey Technic Pin]
- 1x [Grey Technic Pin]

6



- 2x [Grey Technic Axle]
- 1x [Grey Technic Pin]
- 1x [Grey Technic Pin]

- 1:1 [Grey Technic Axle]

7

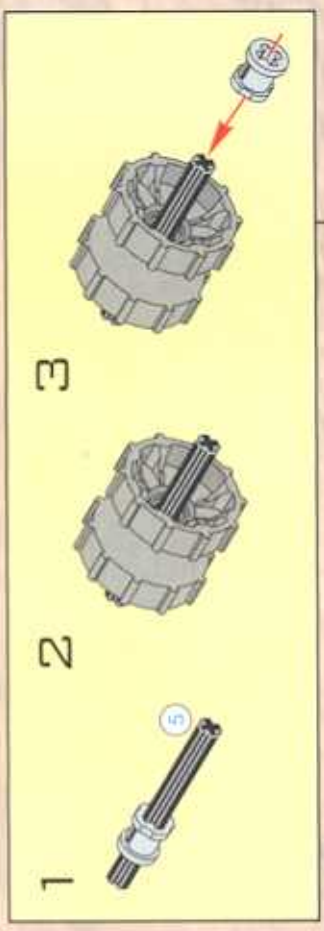

- 1x [Grey Technic Pin]

5





8

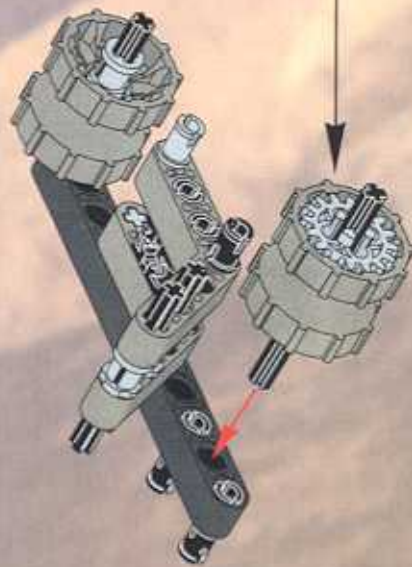
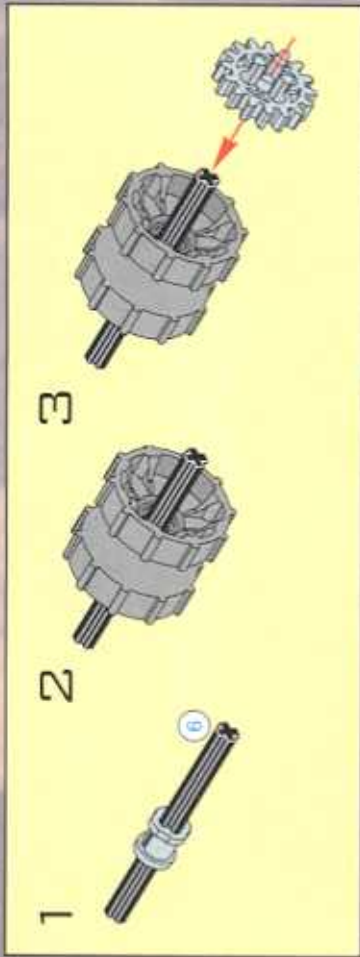

1:1



9

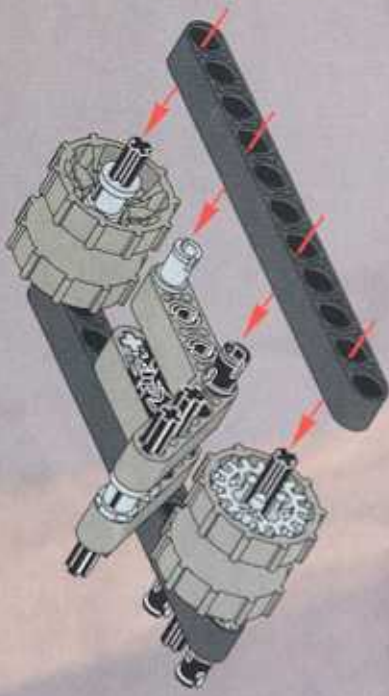

10

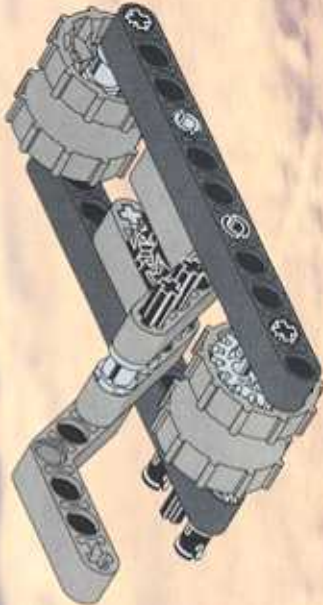

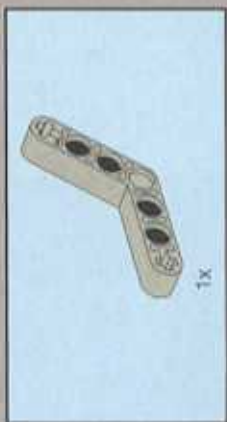
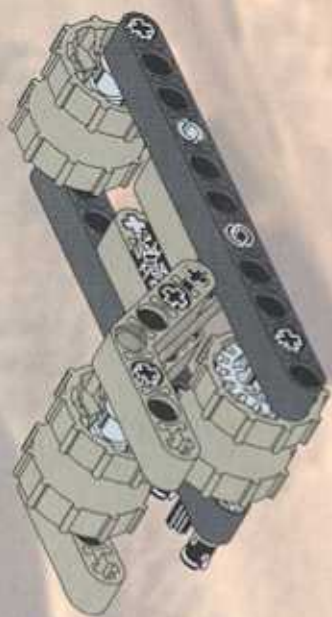

12



13



11

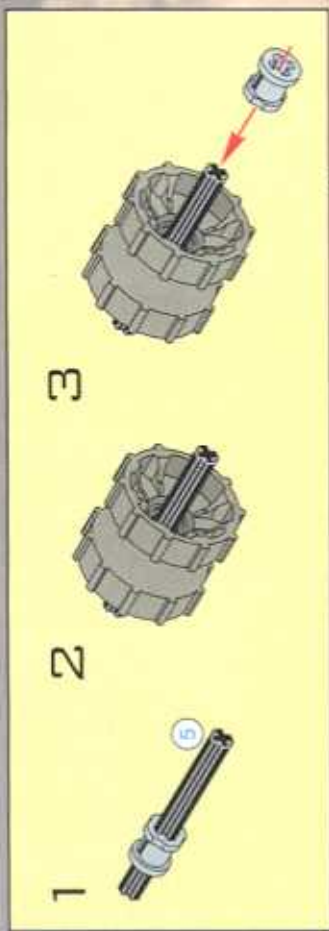



14

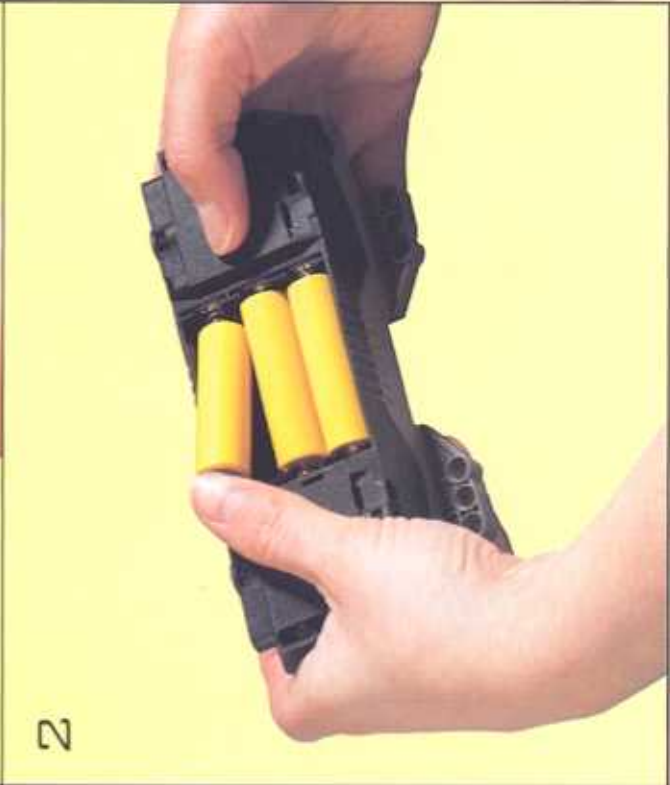
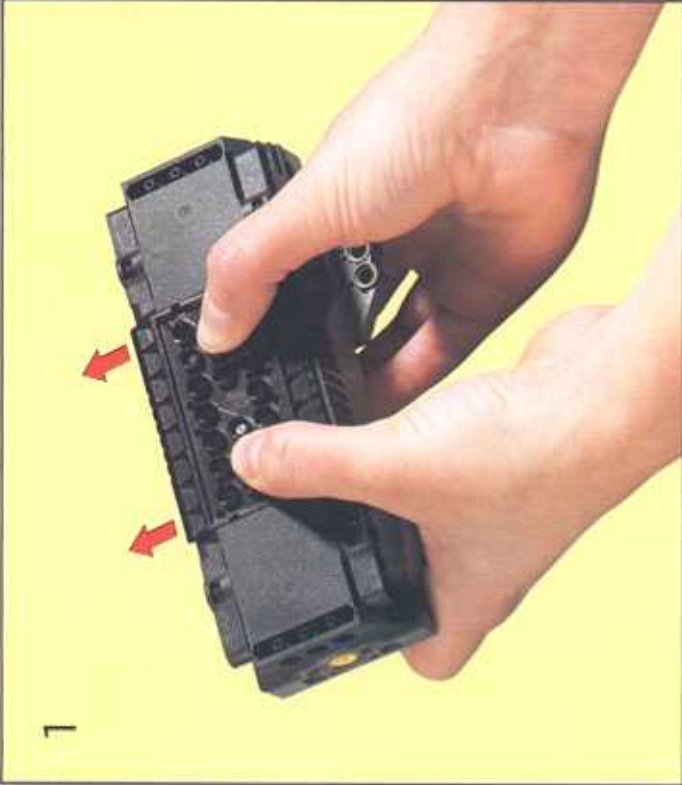
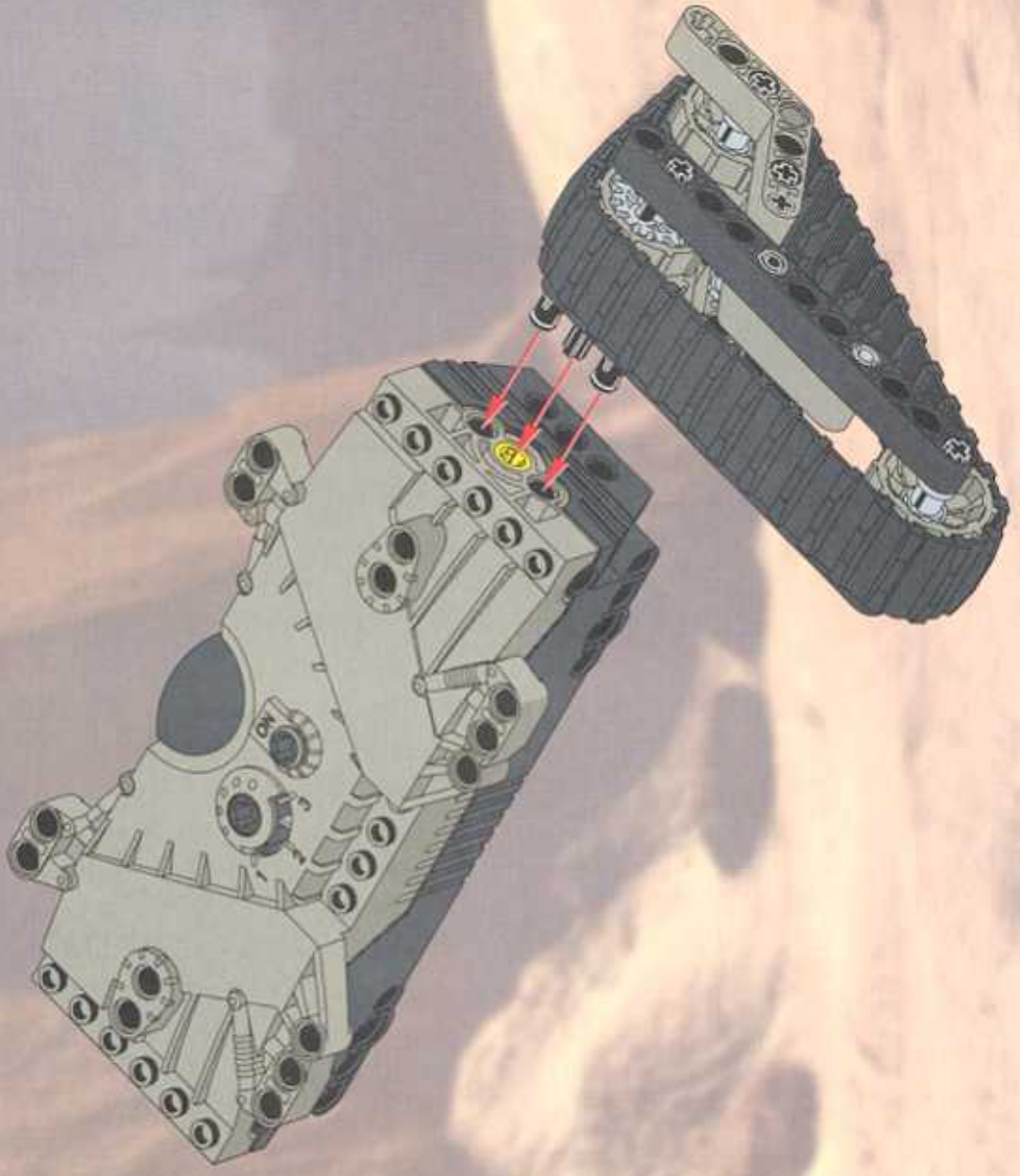



15



16



17

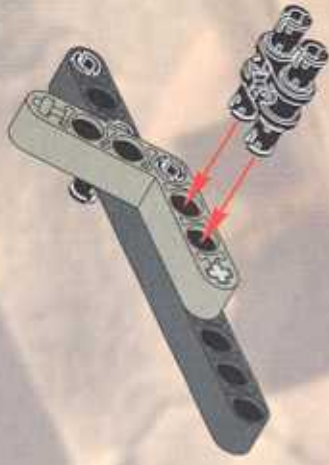

18

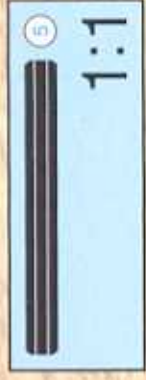
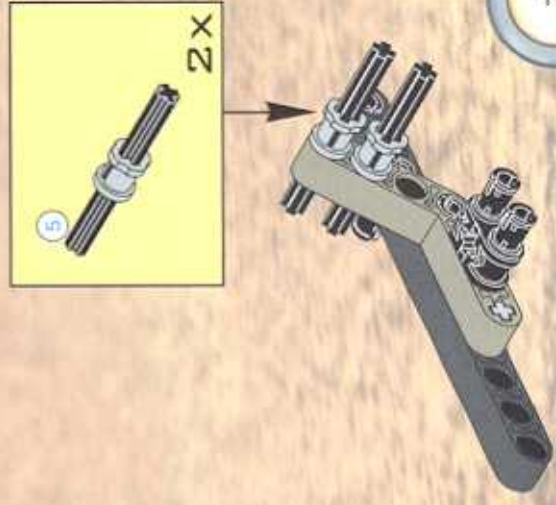



19



20

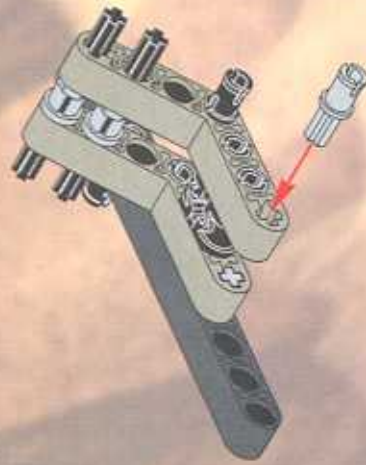

21

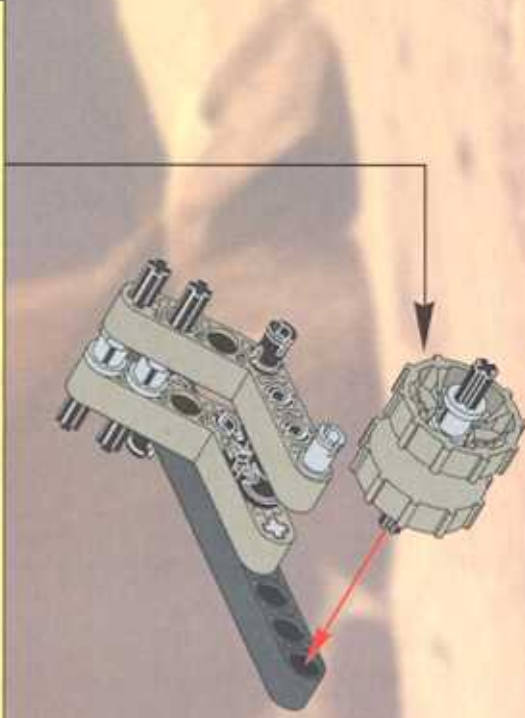
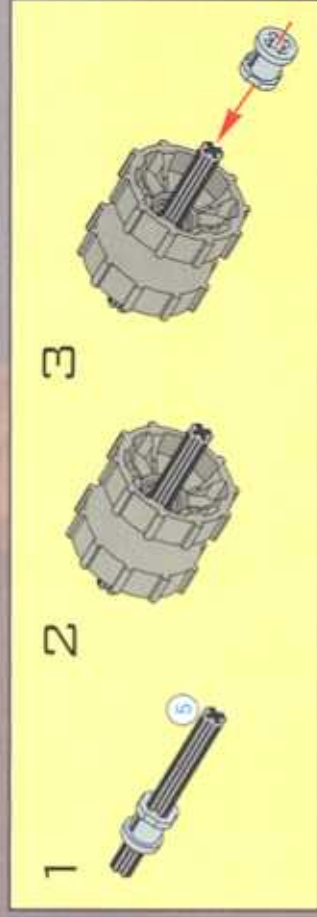

6
1:1

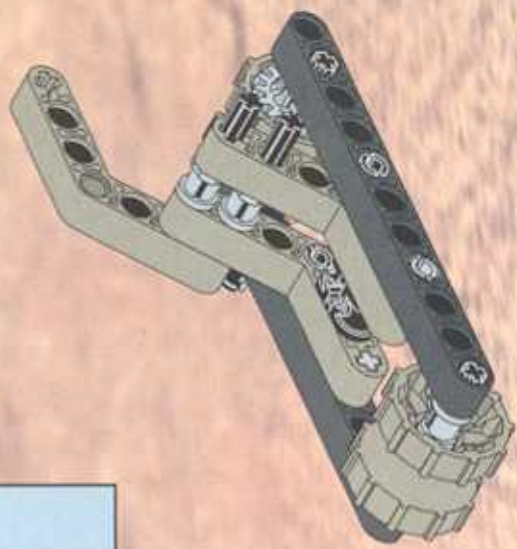

23

24

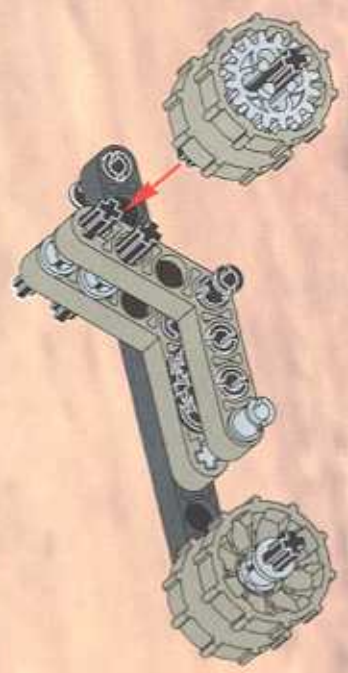
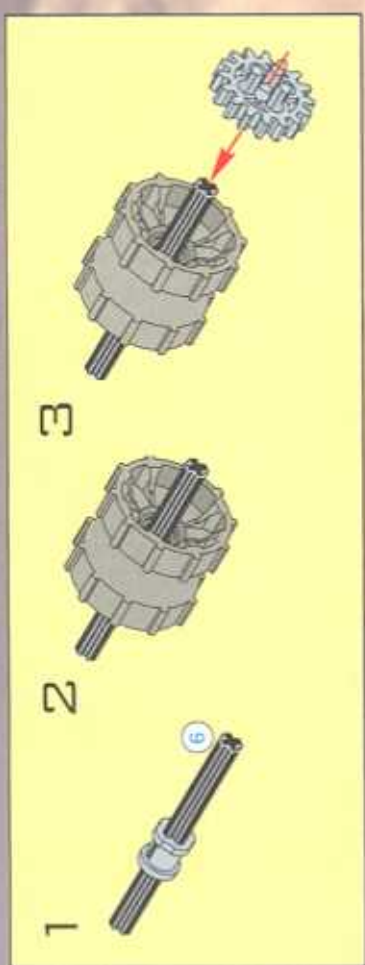

22

3

2

1

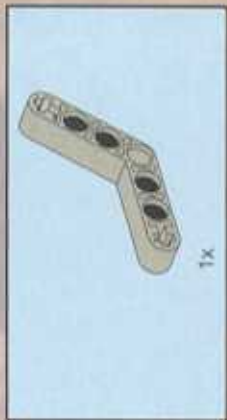

26

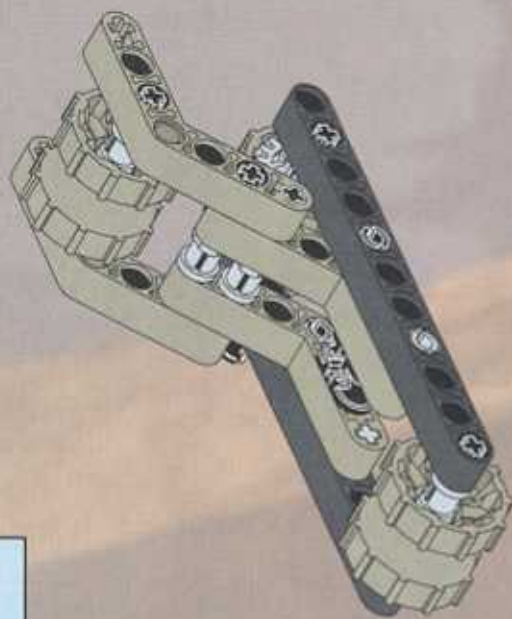

27



25

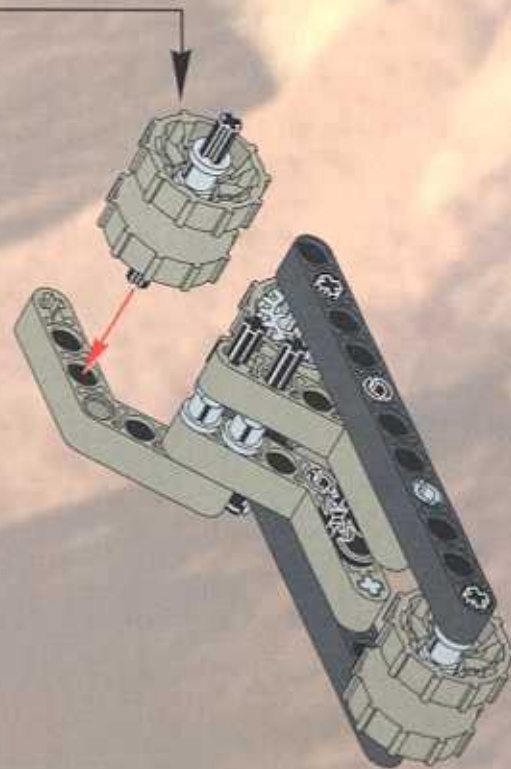
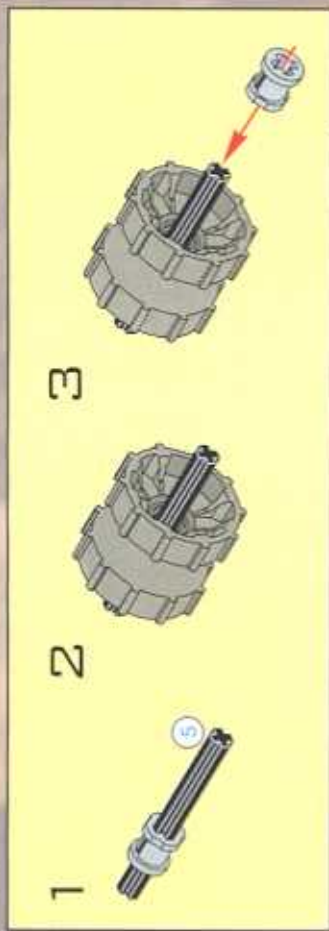

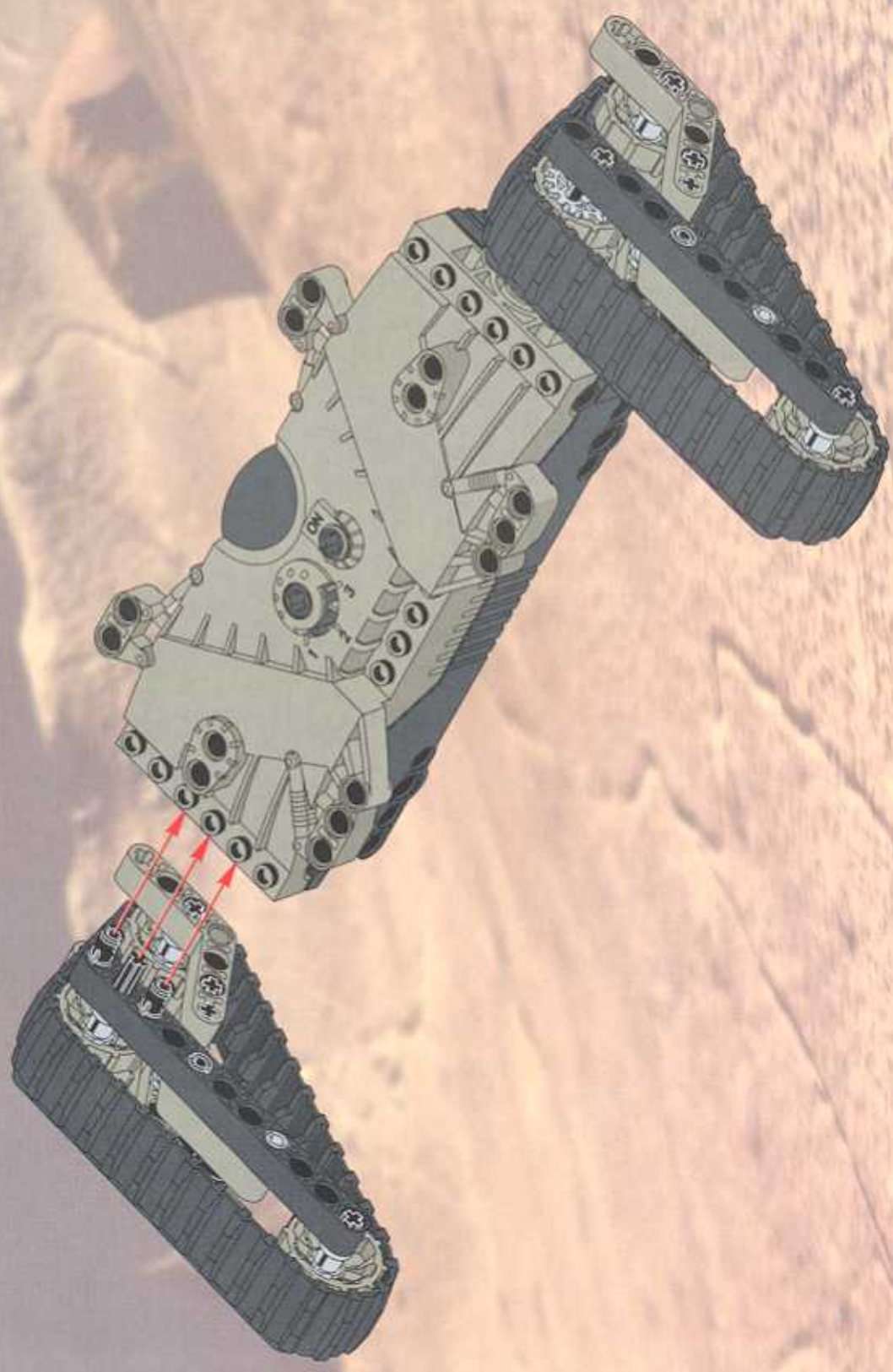

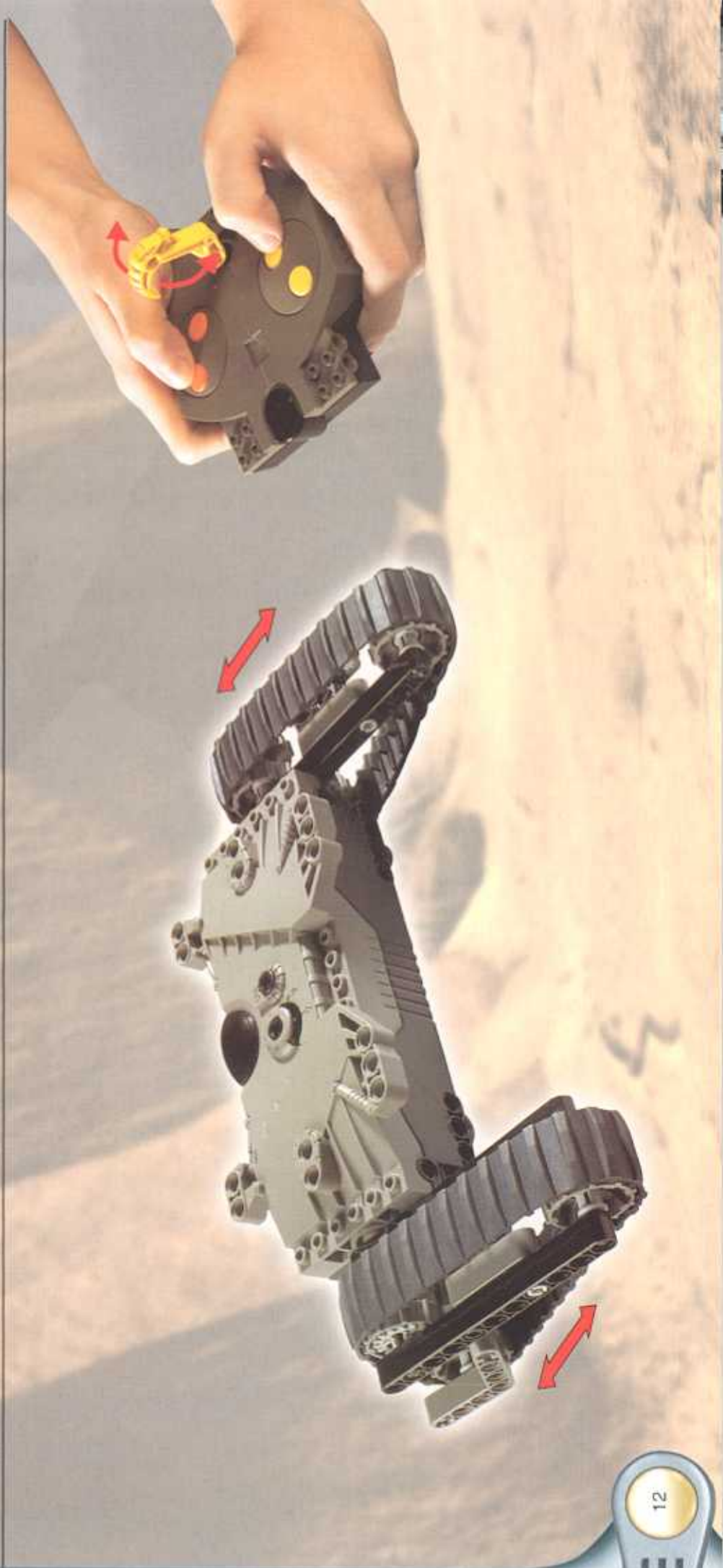
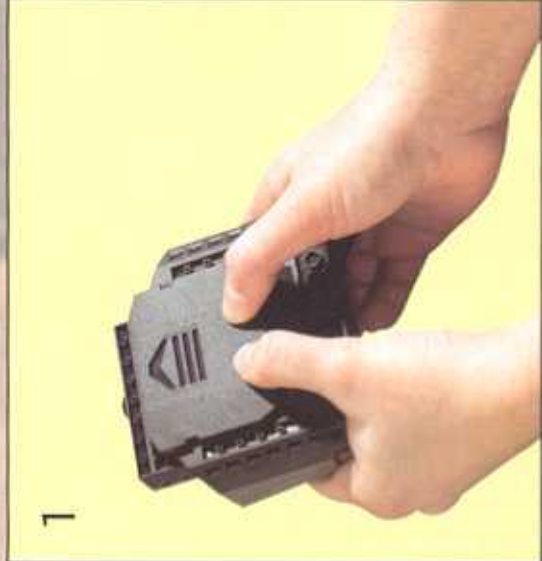
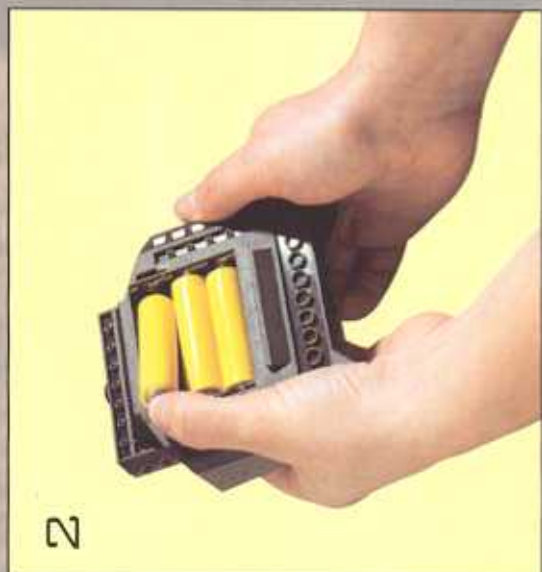



29



A light blue rectangular box containing a parts list for step 29. It lists two types of components, each with a small icon and the quantity '2x'. The first component is a black and white axle with a bush, and the second is a black and white axle with a different bush.

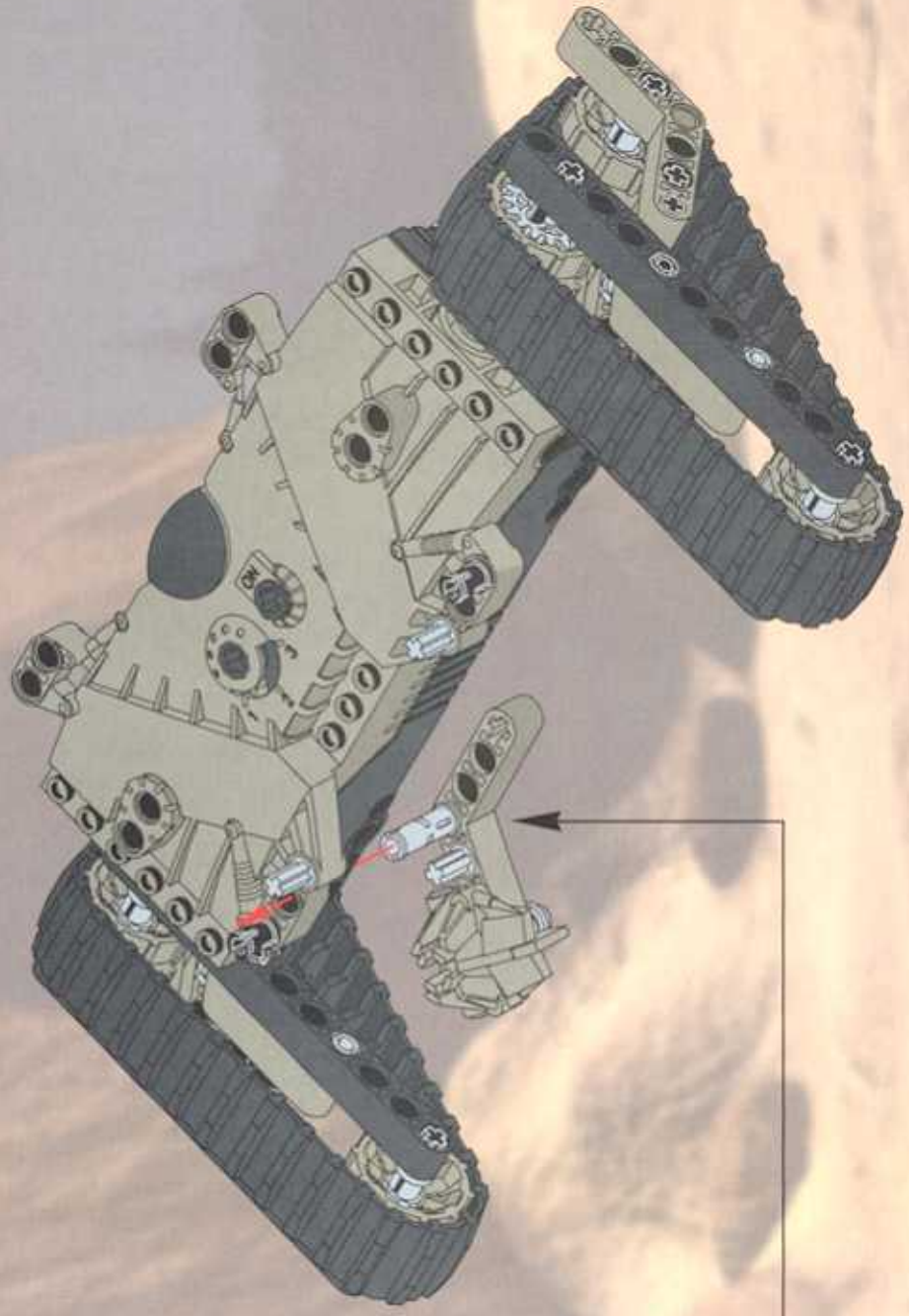

30

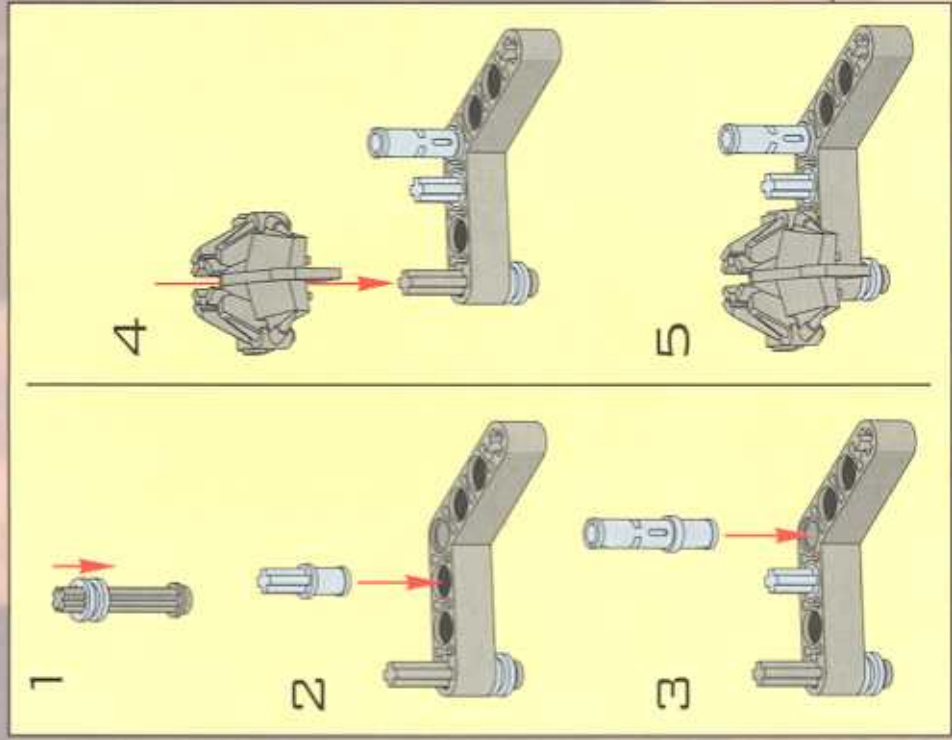

30

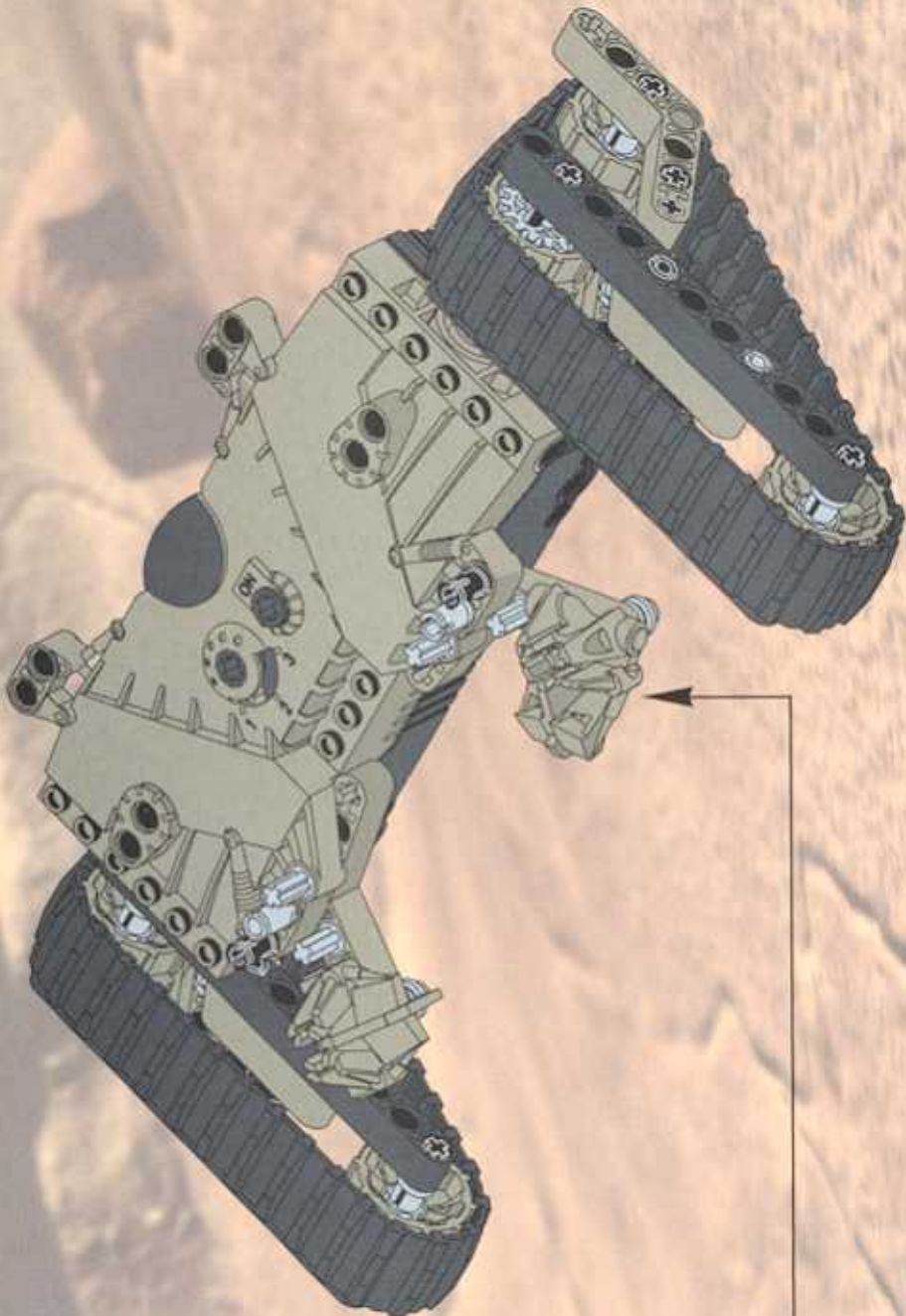

31

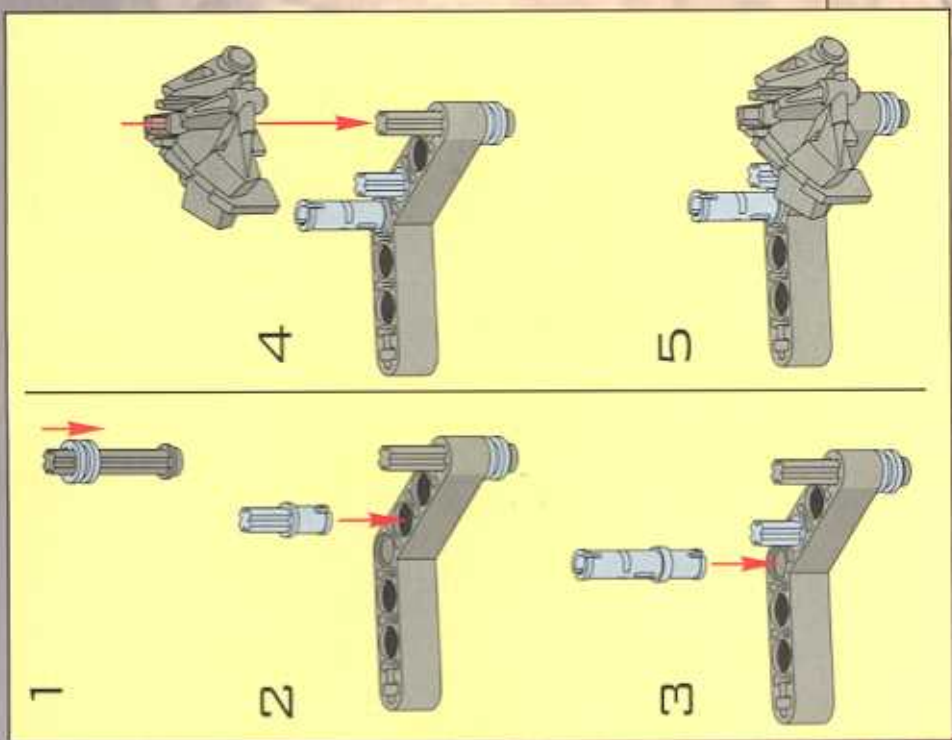

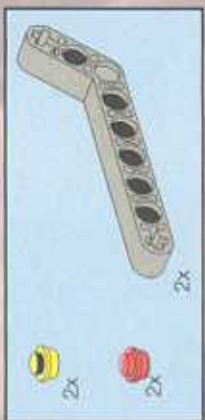
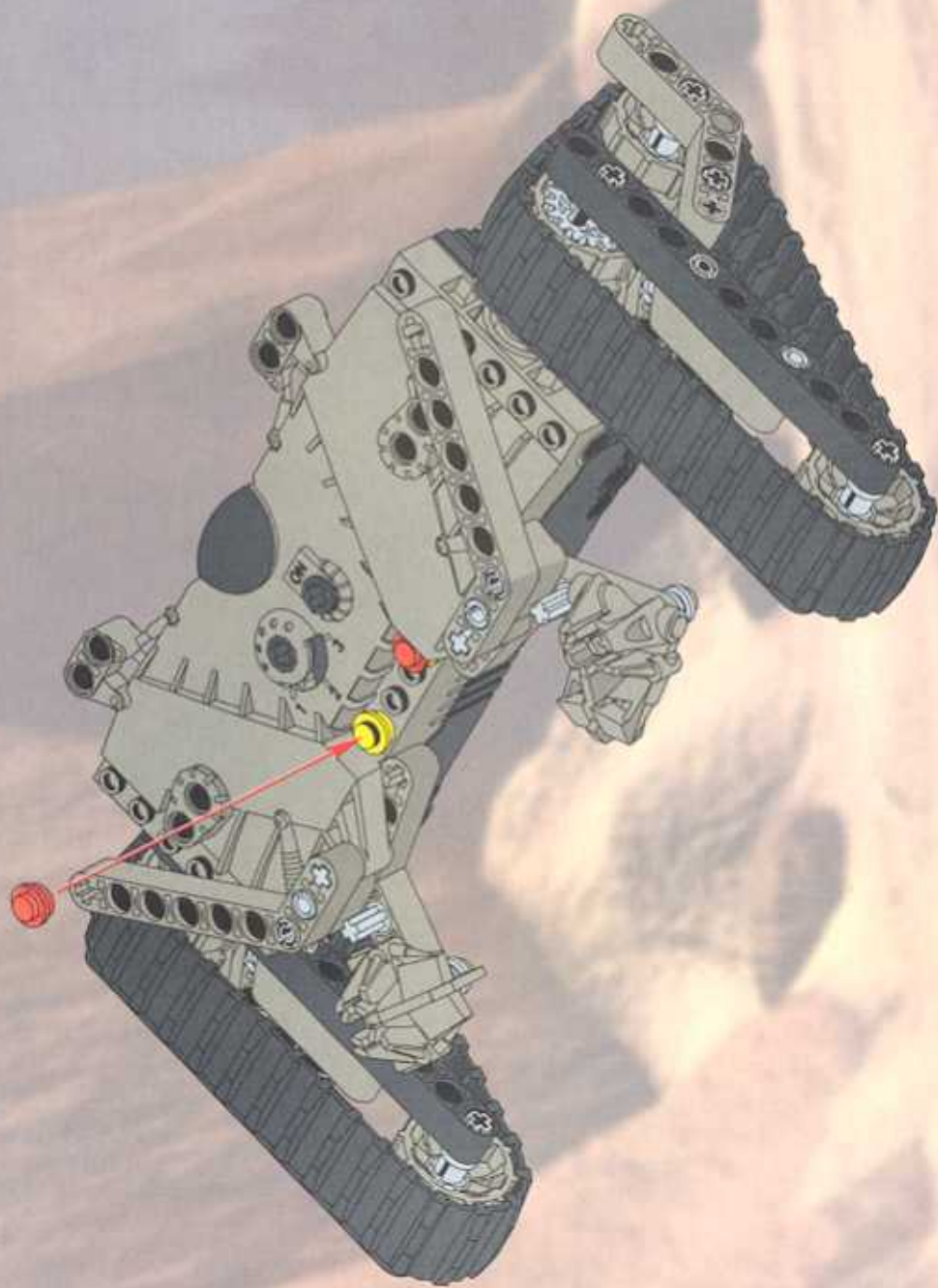

32

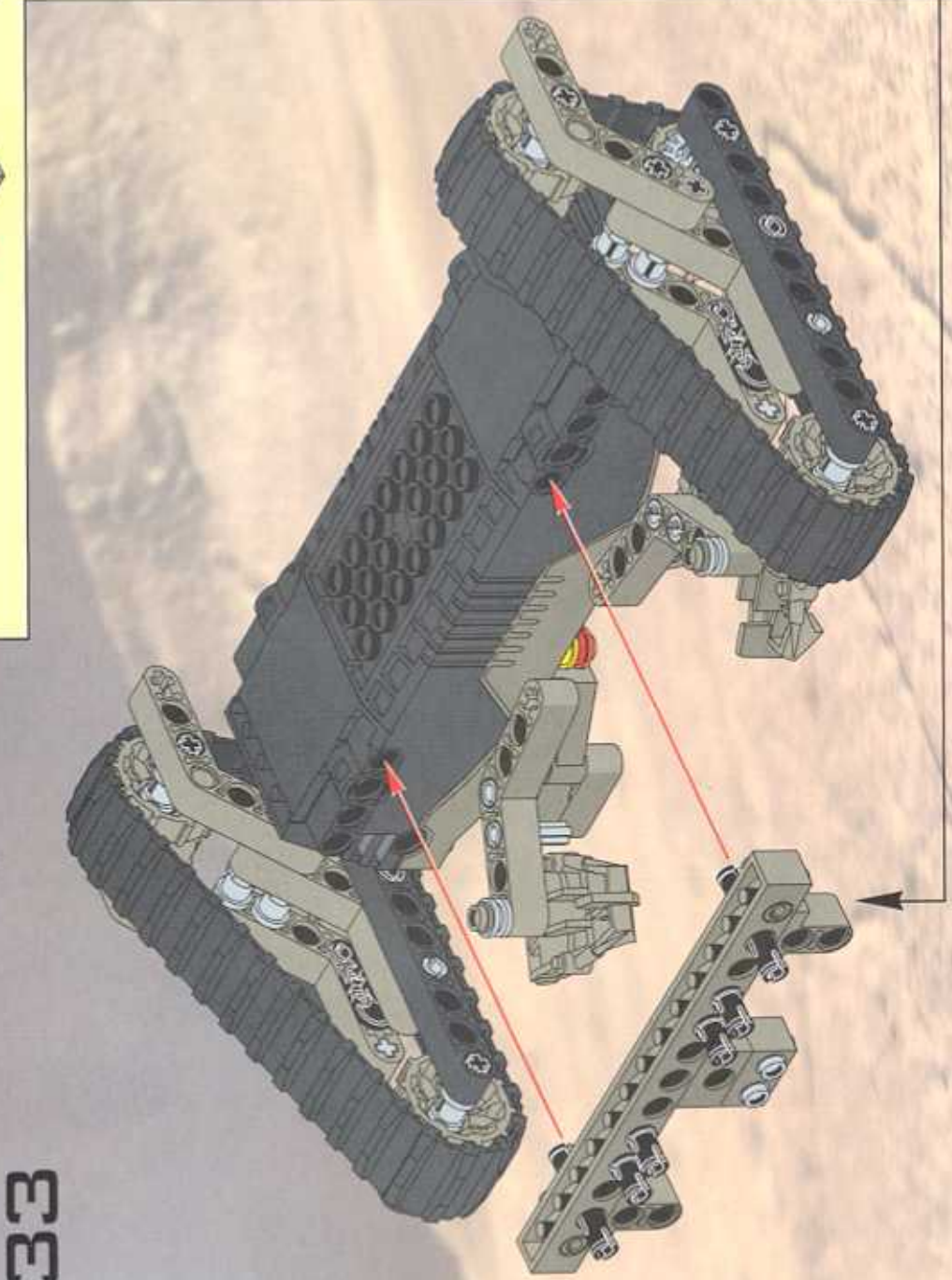
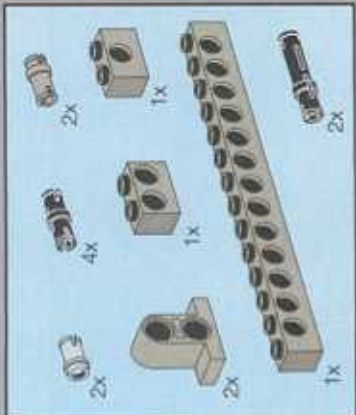
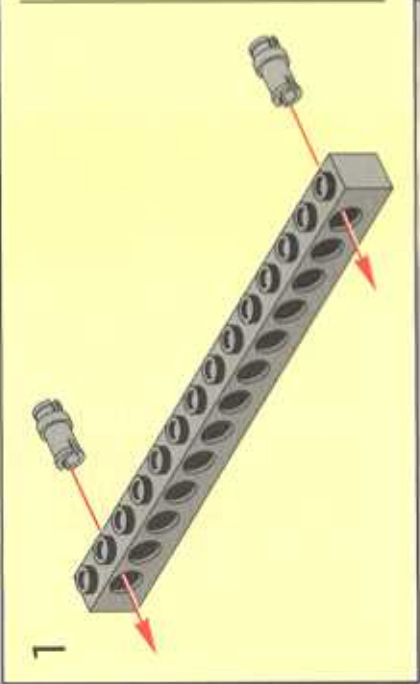
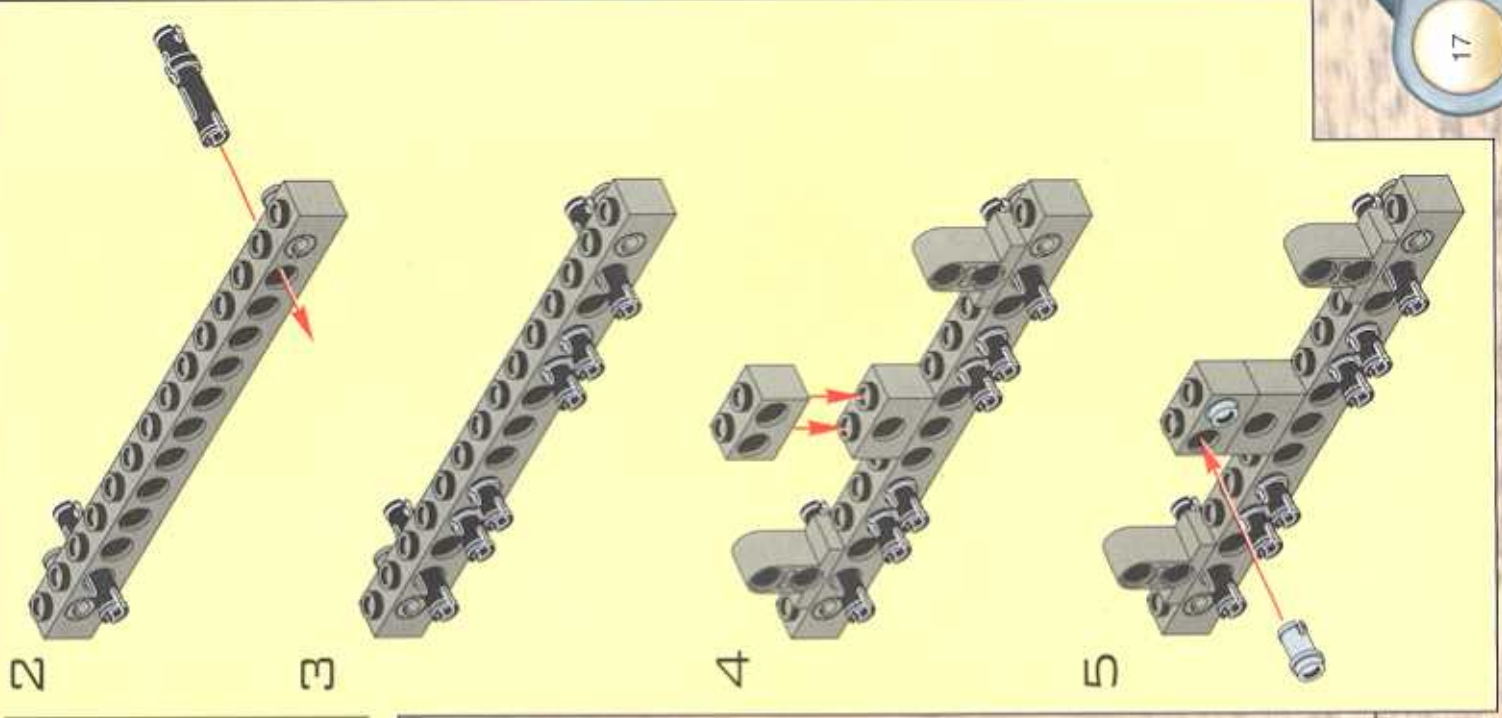



34

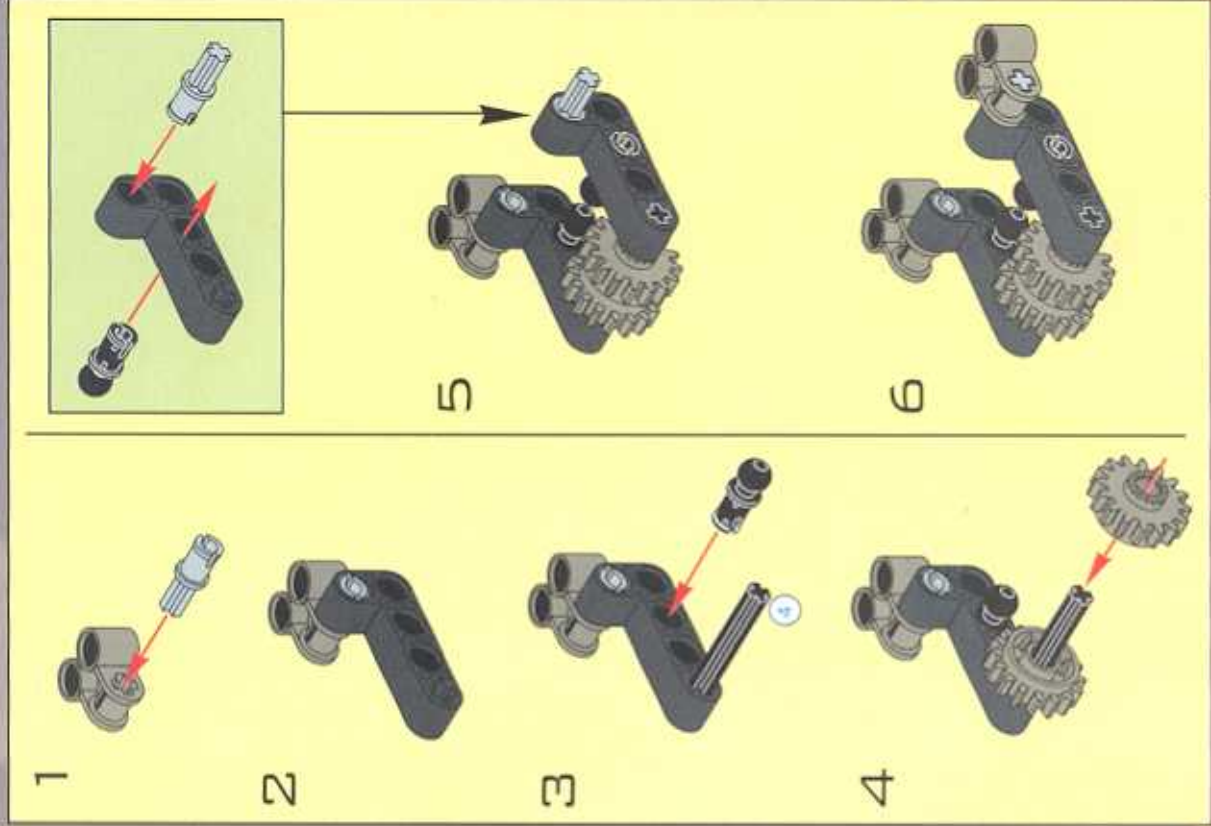
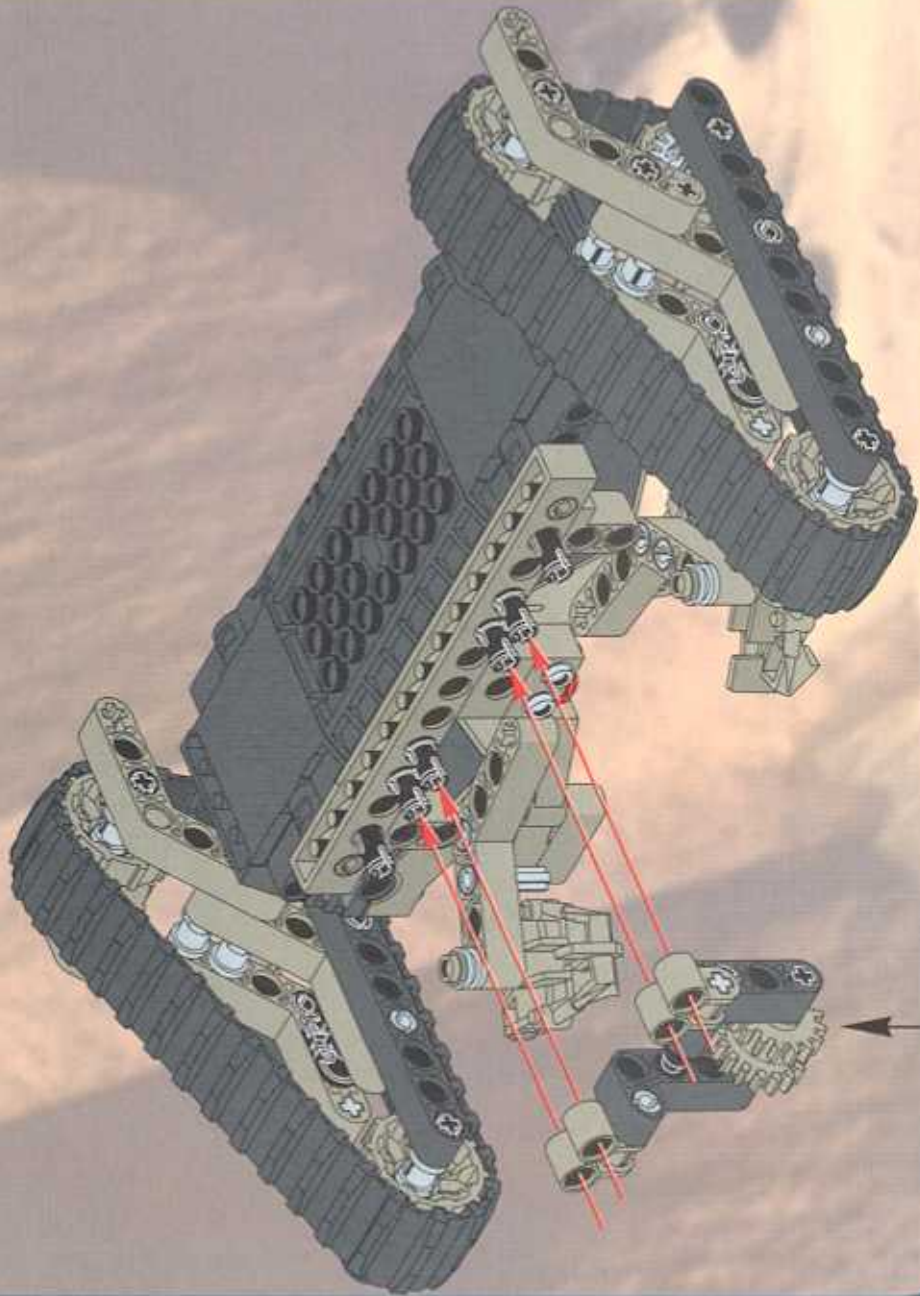

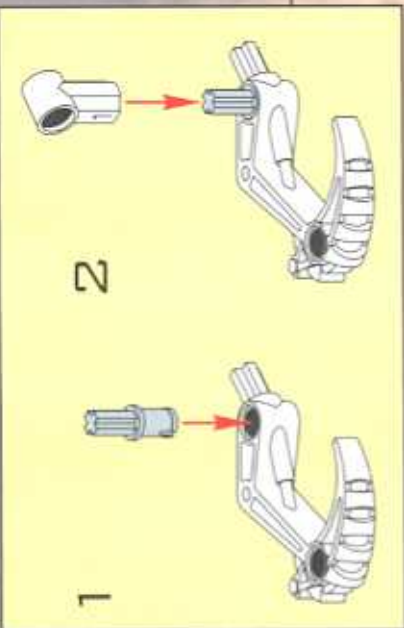
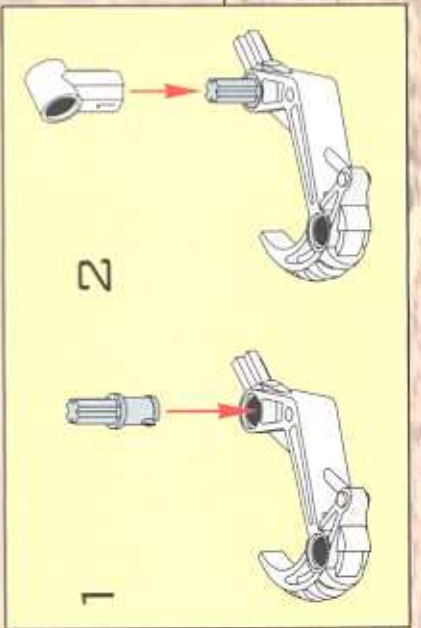
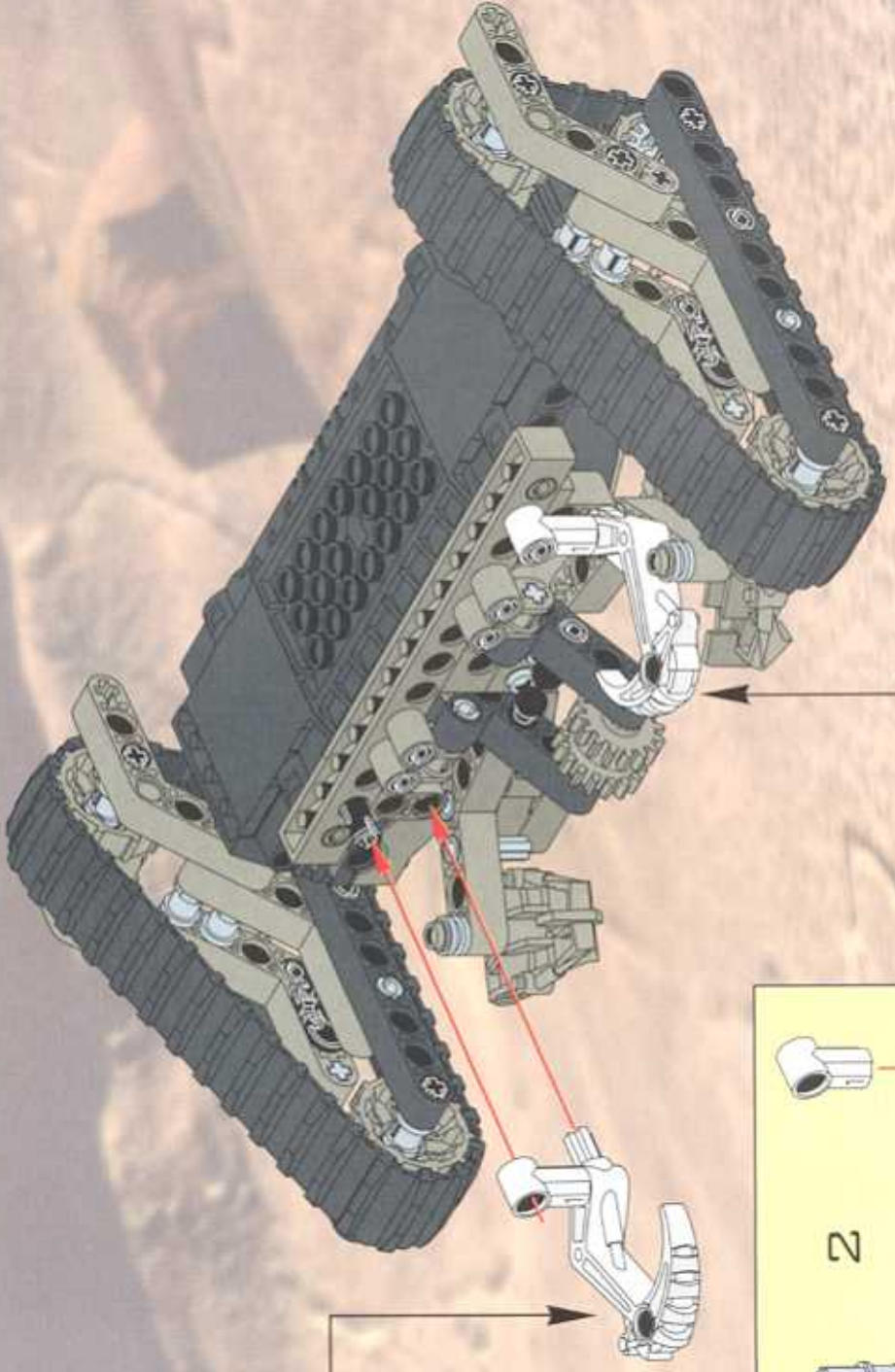

35



36

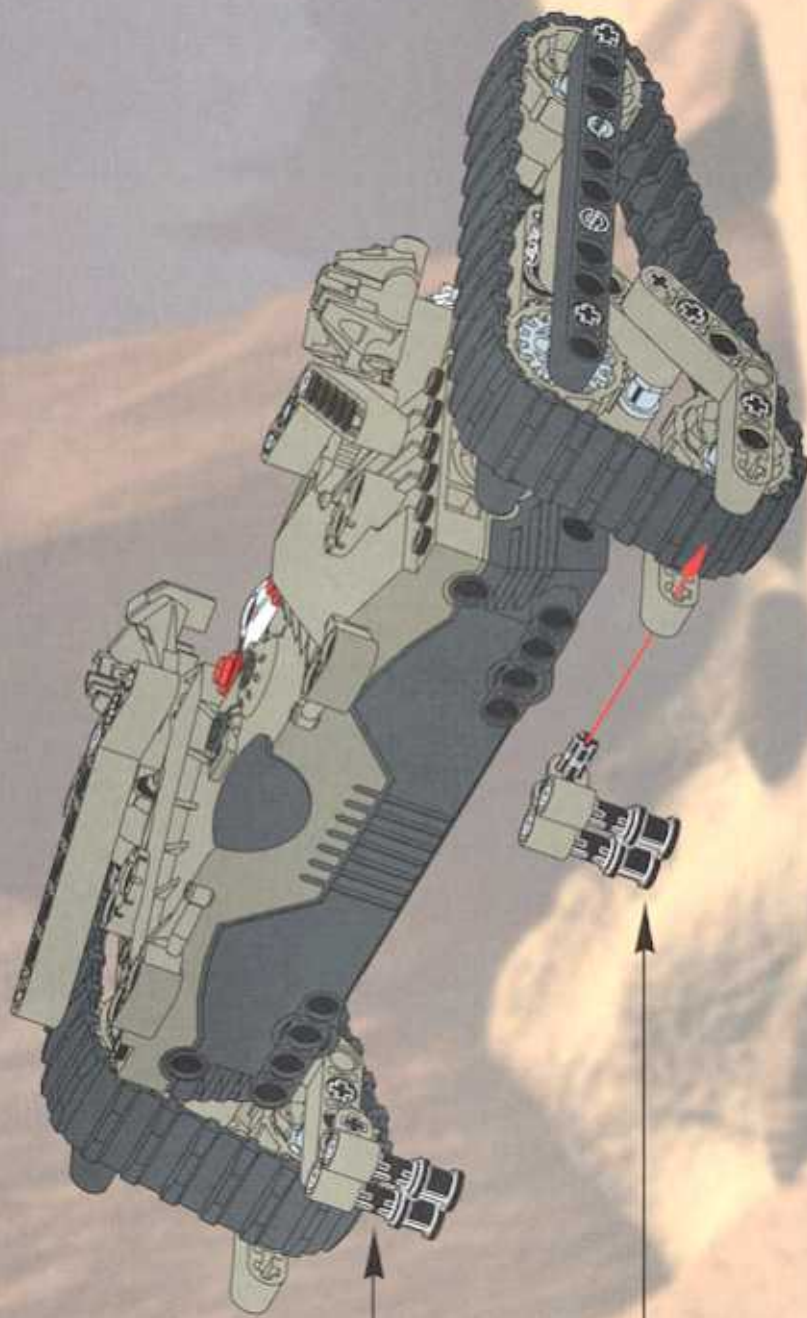
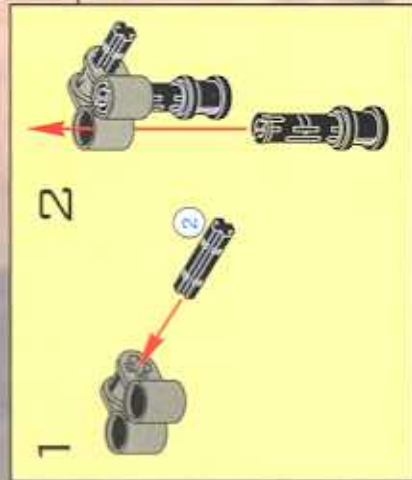
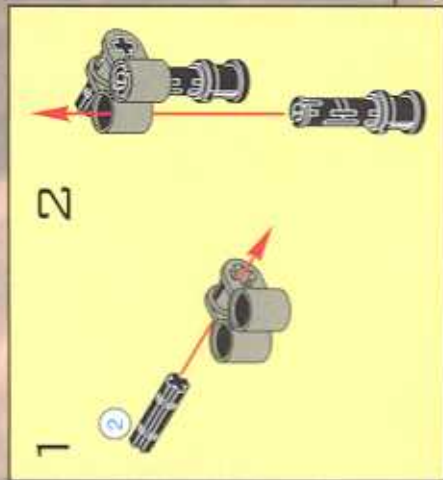



6
2x

6
2x

37

6
2x

6
1:1

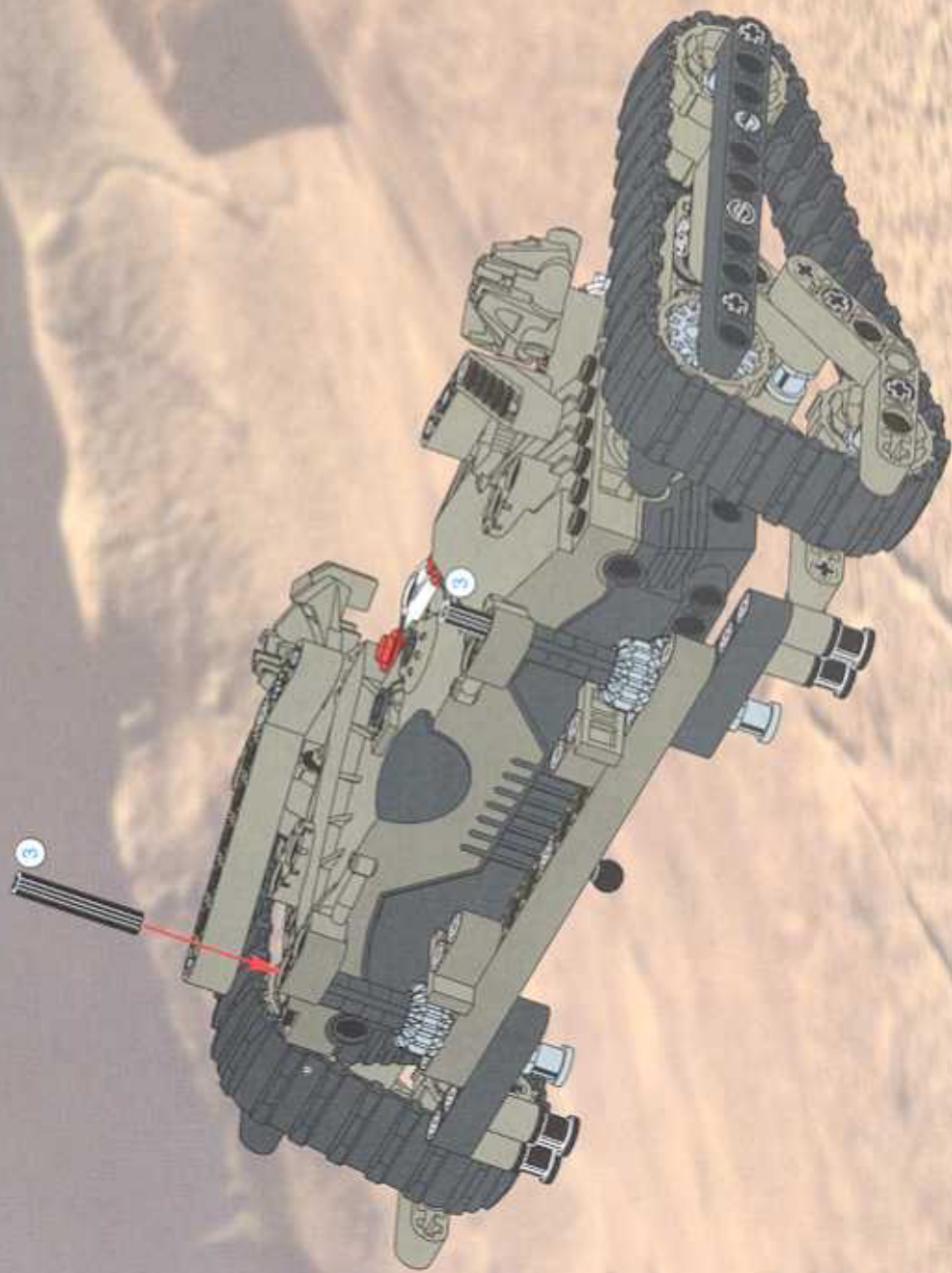

39



○ 2x
2x

40

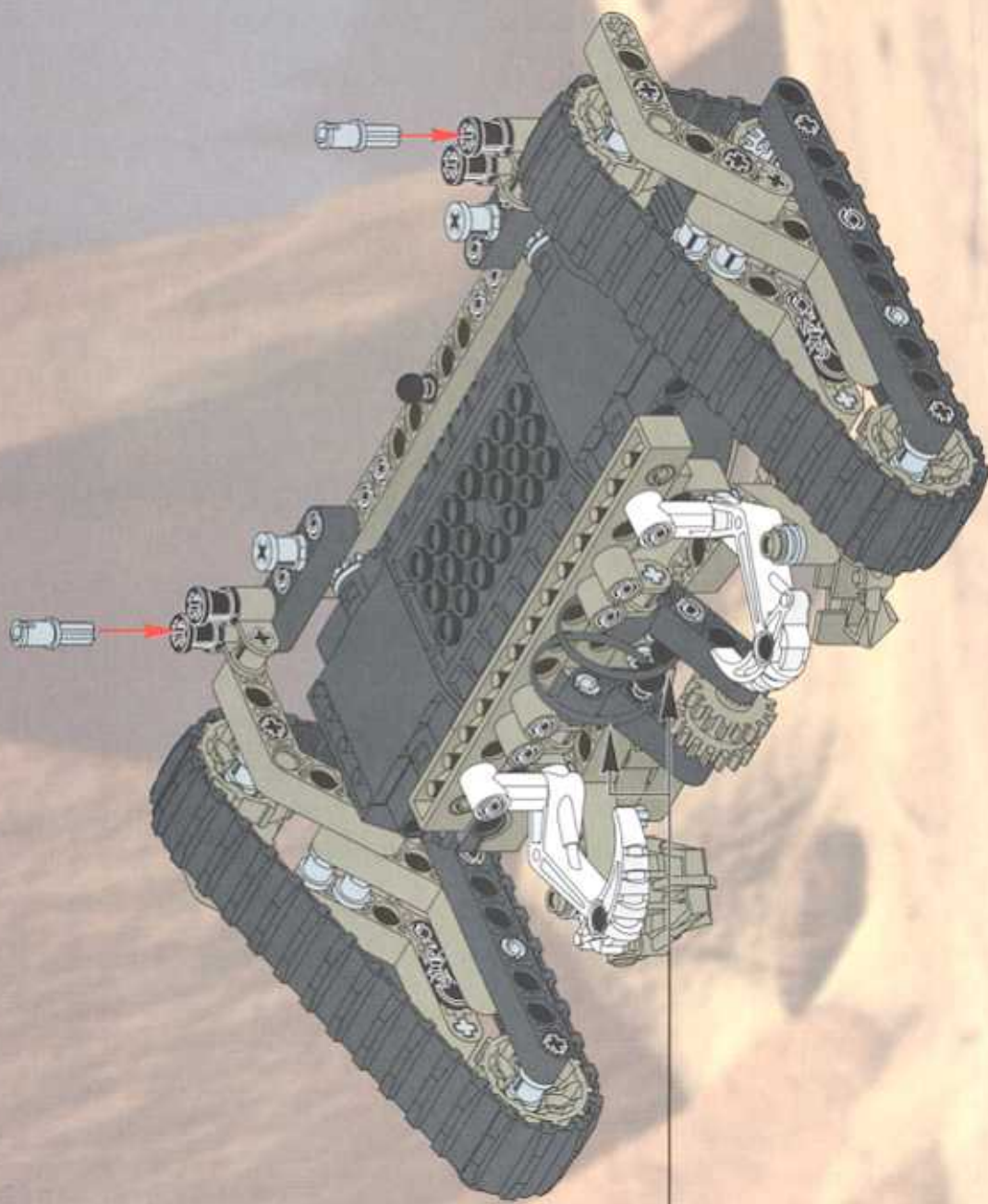

○ 2x

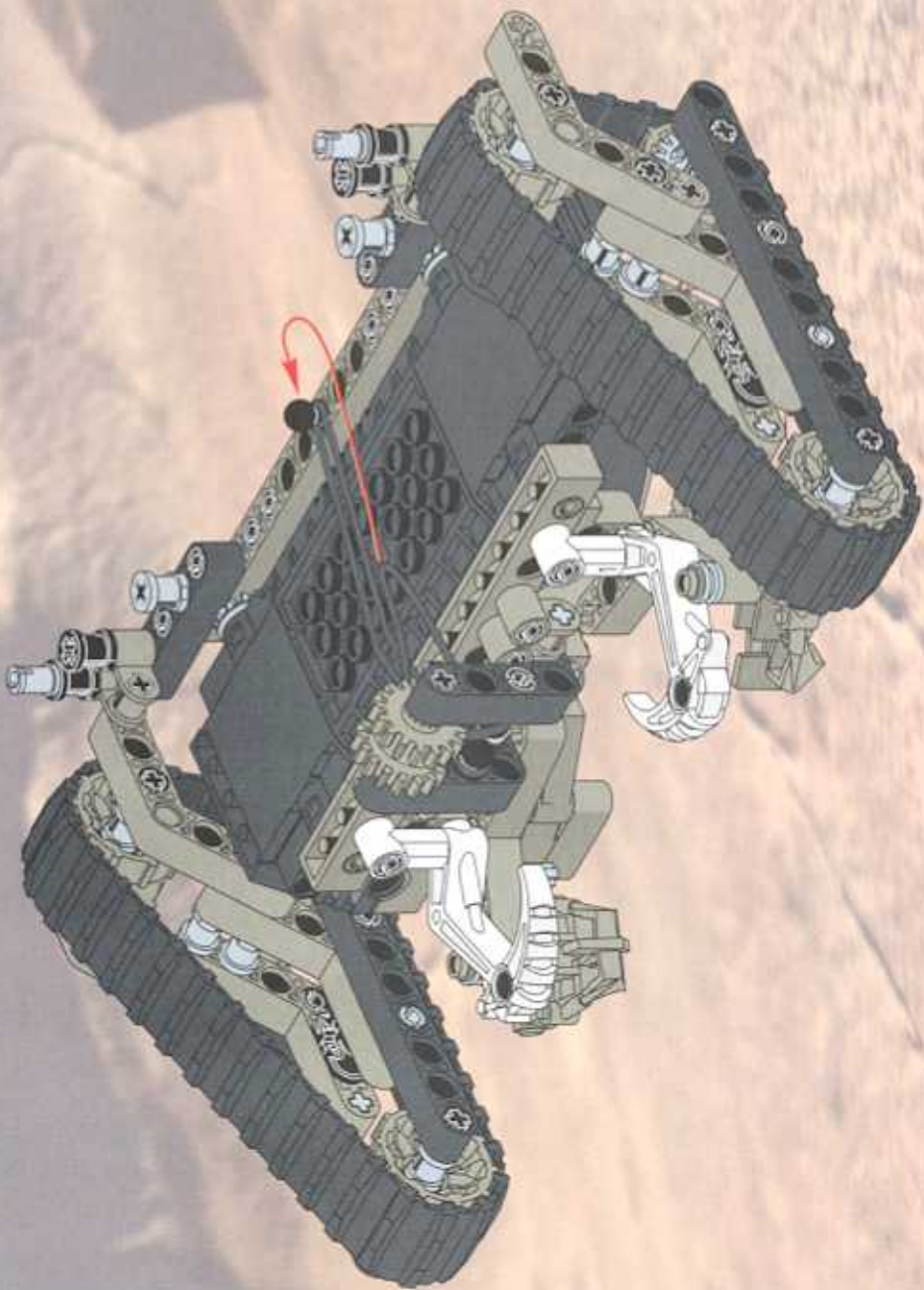



42

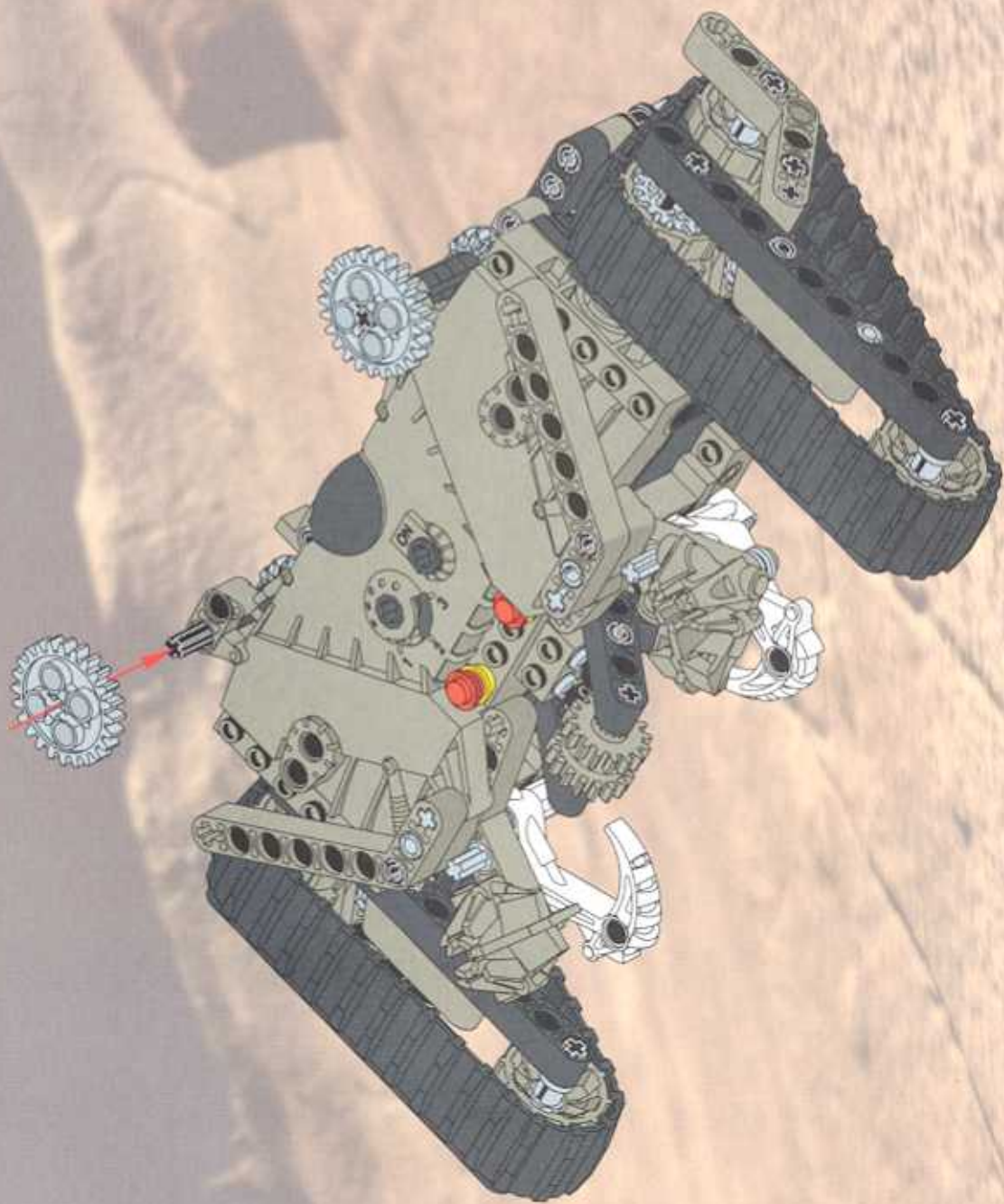

43

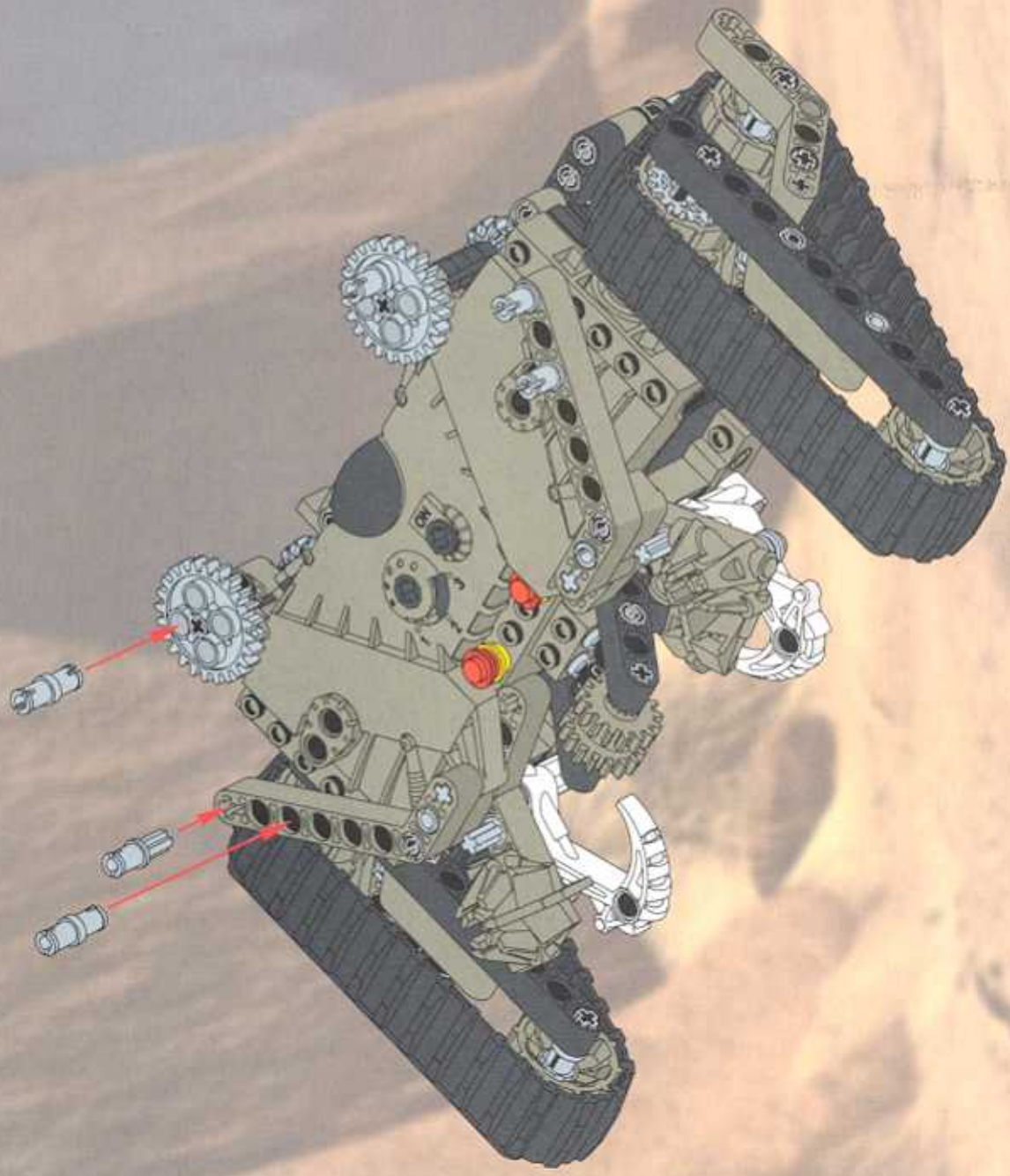

	2x
	4x

44

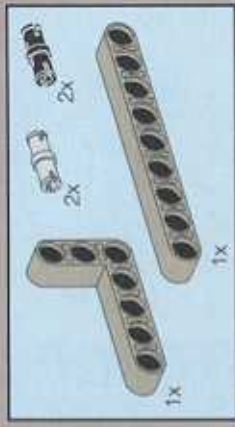
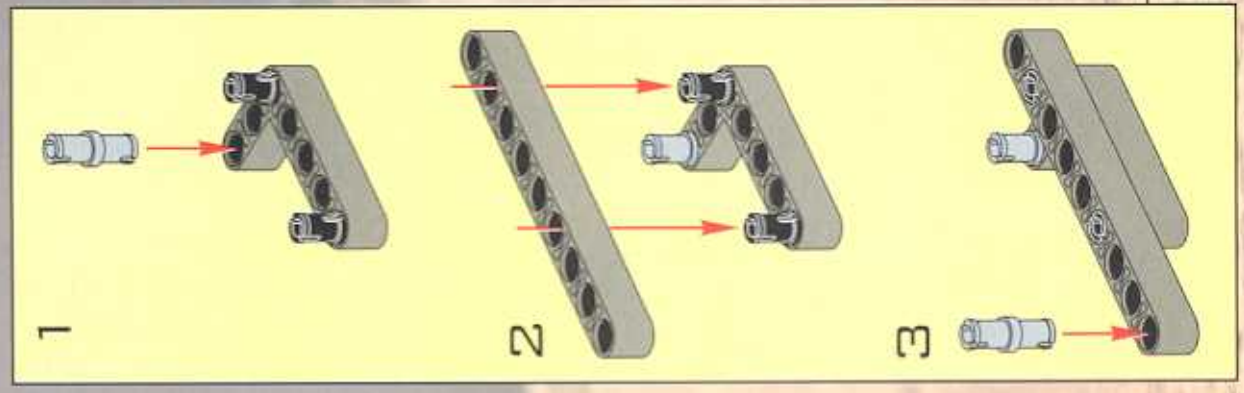
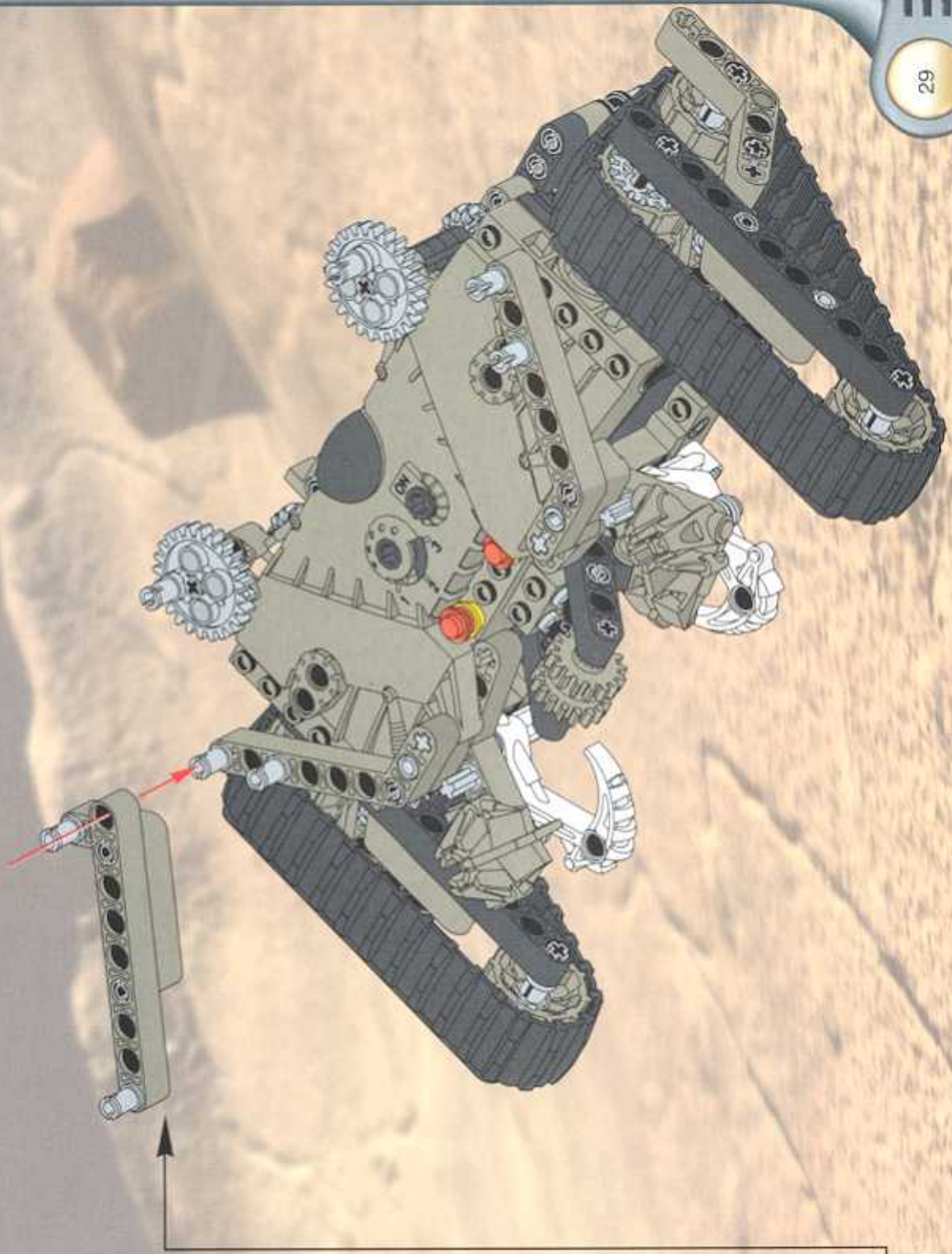

45

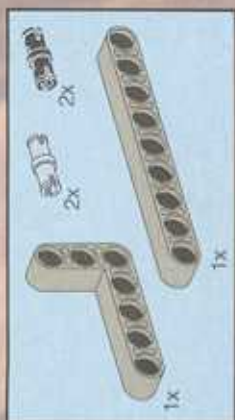
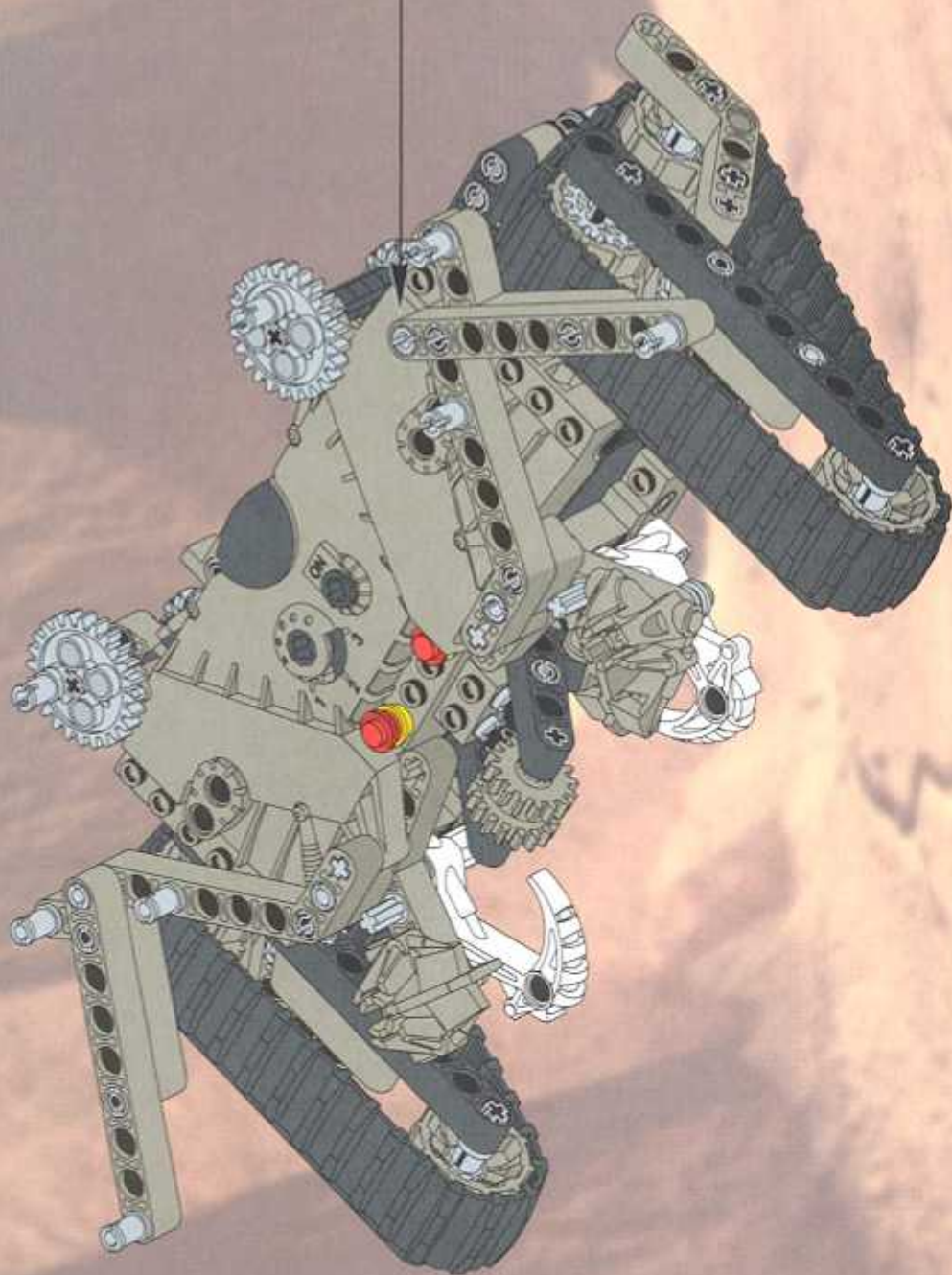
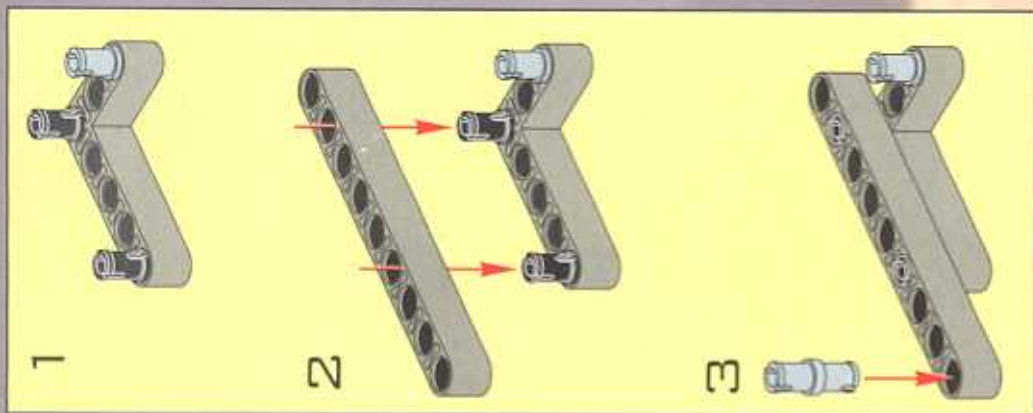

46

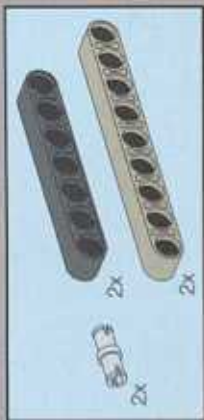
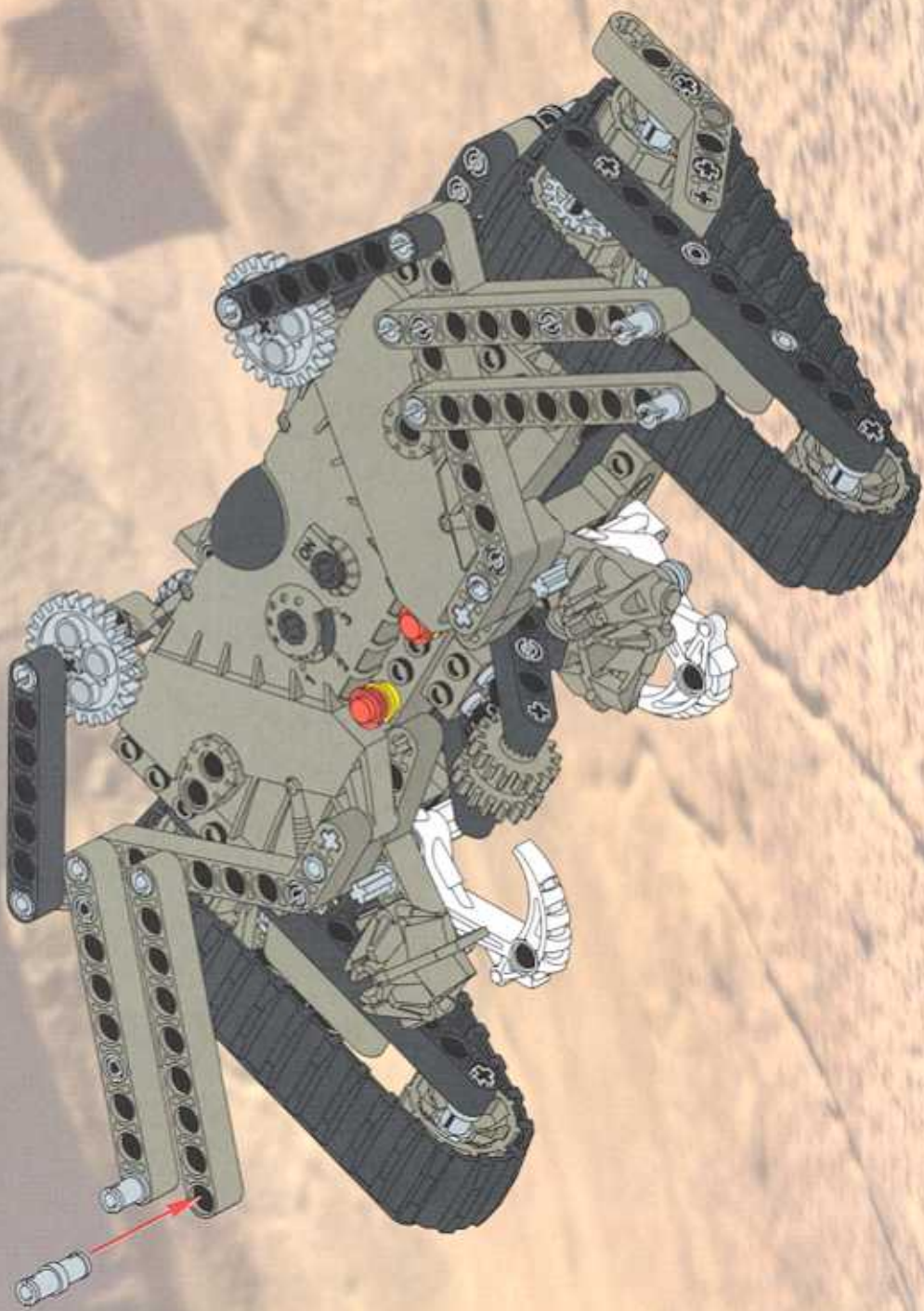

47

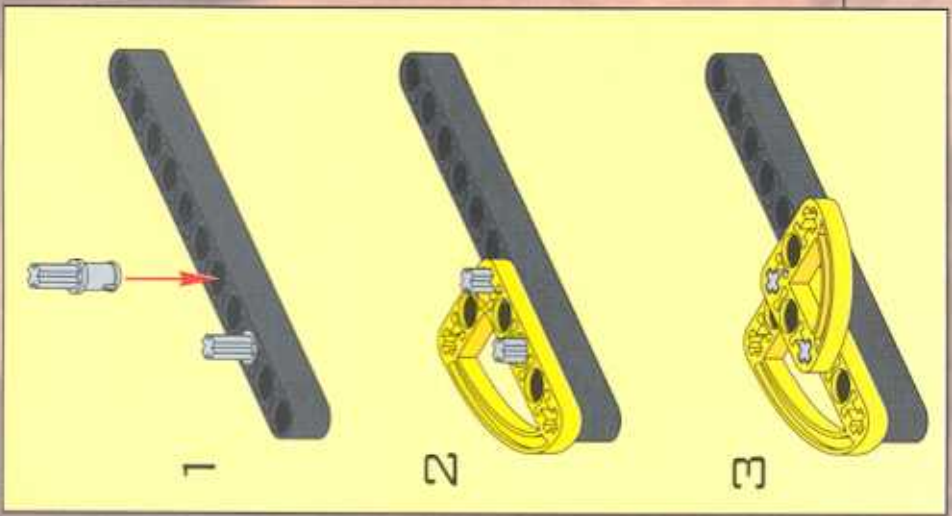
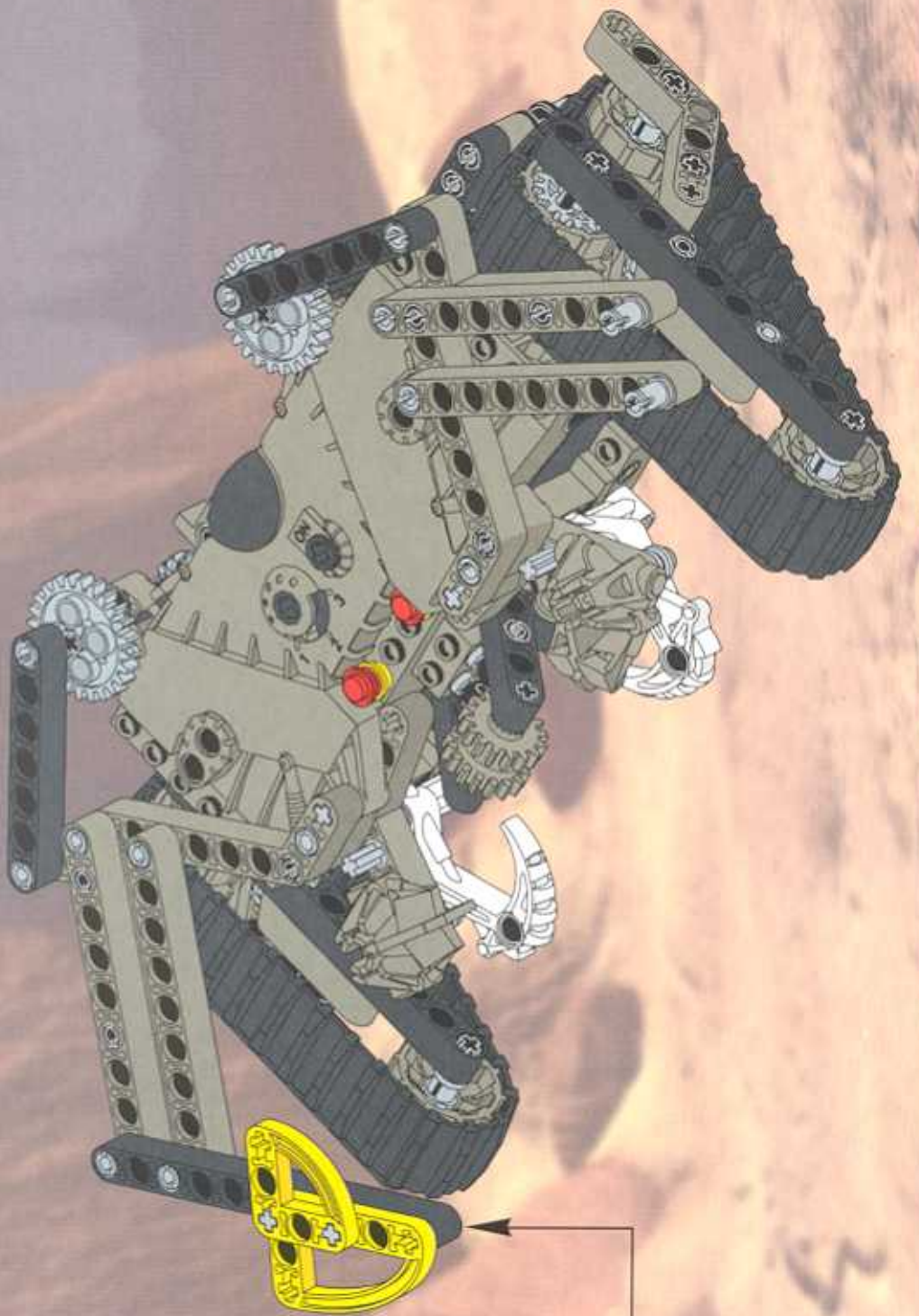

48

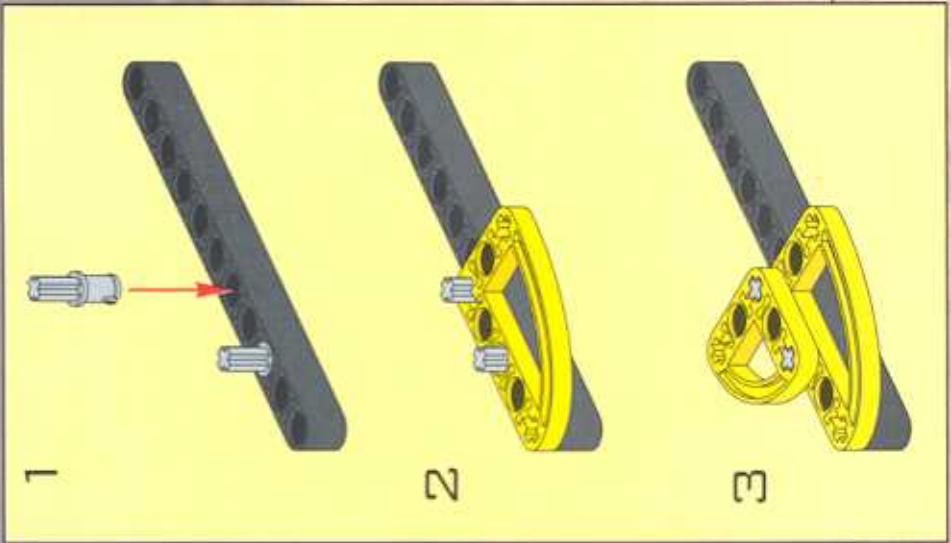
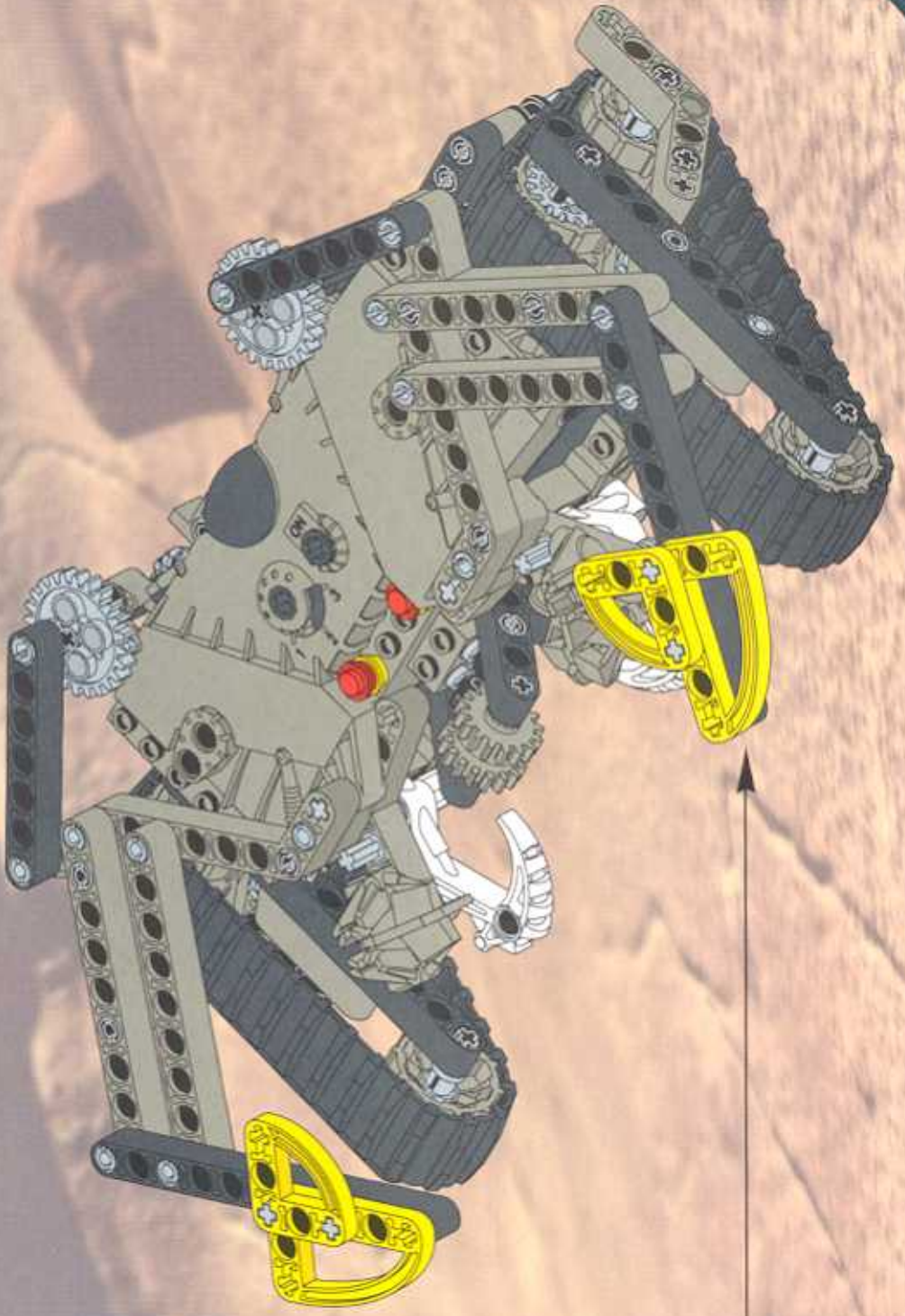

49



1



2



3



4

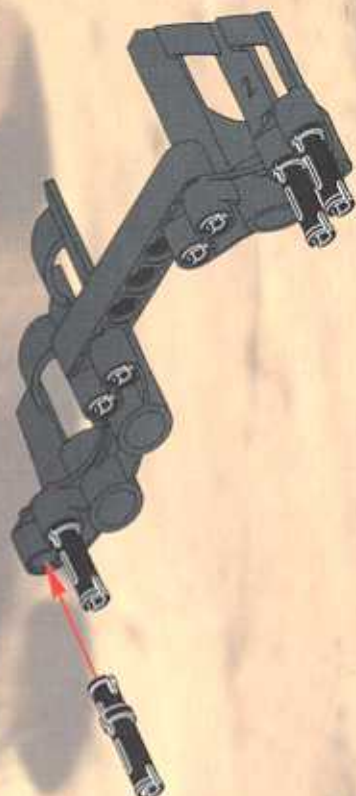

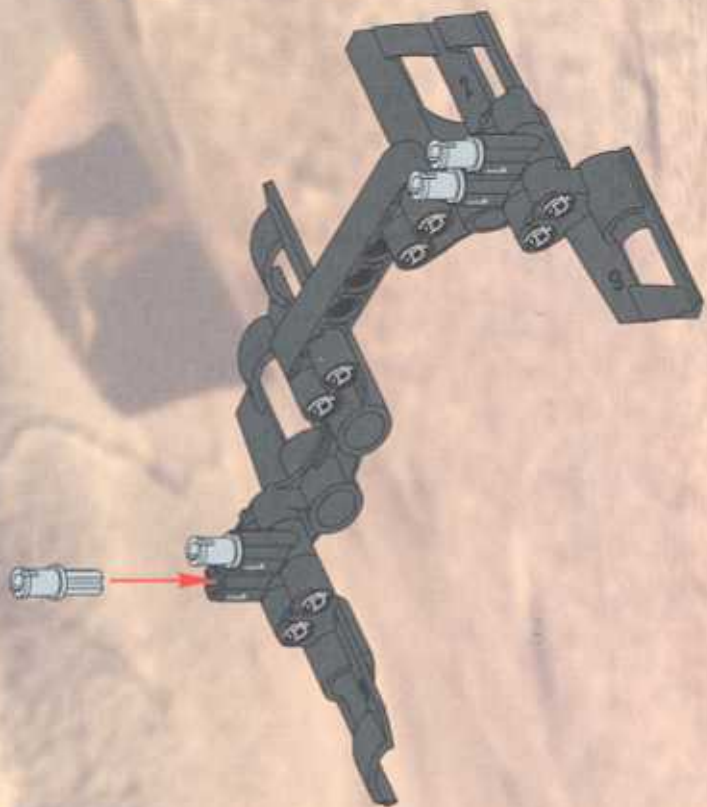

7

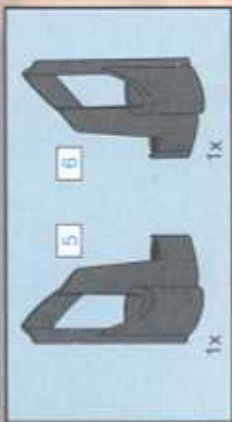

6

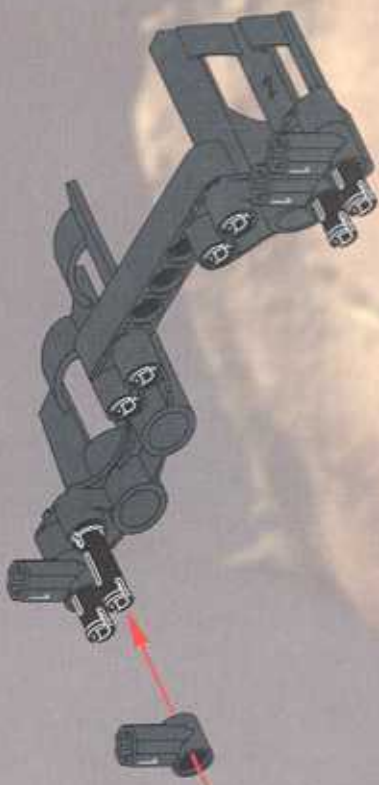

5

50

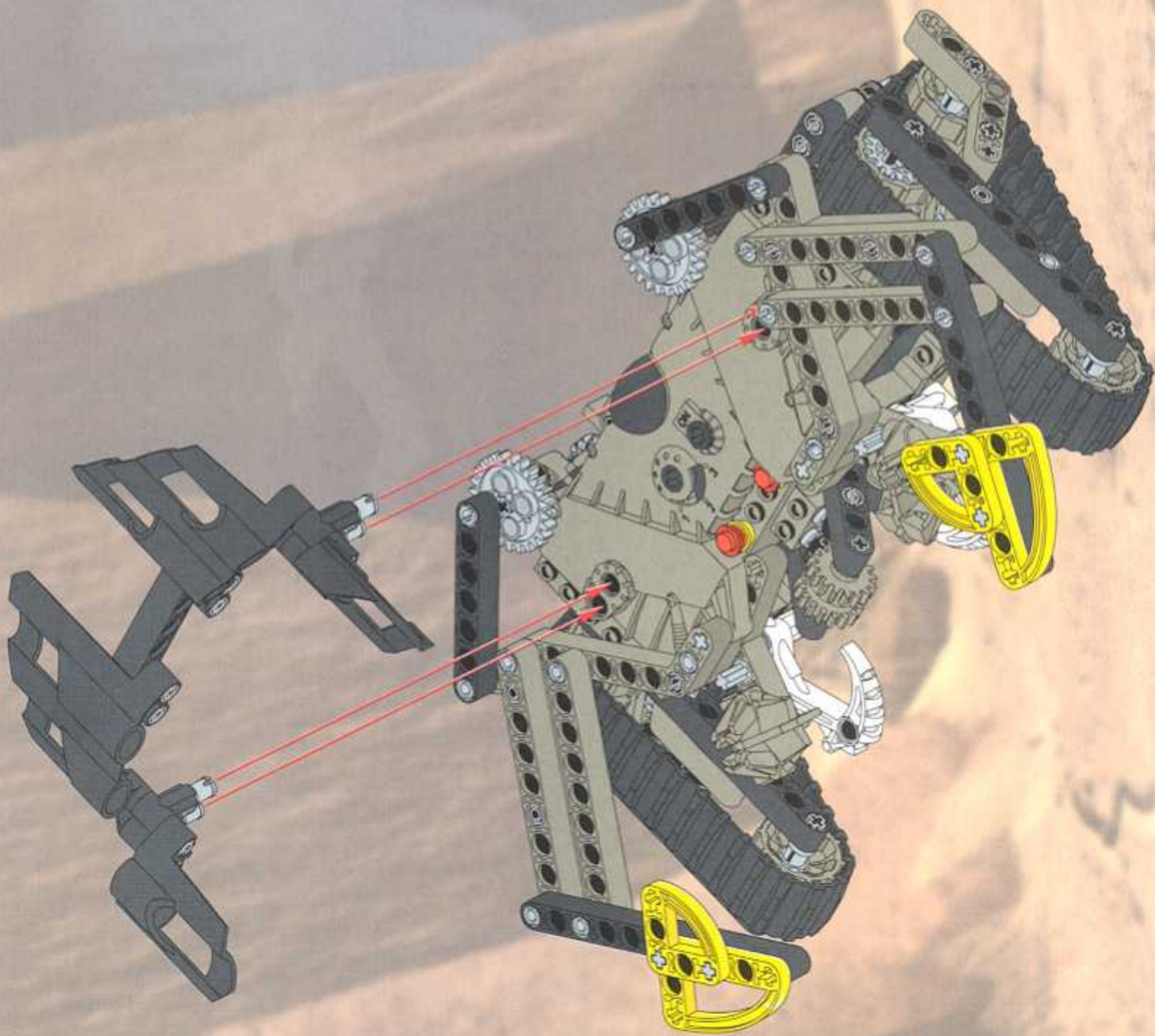

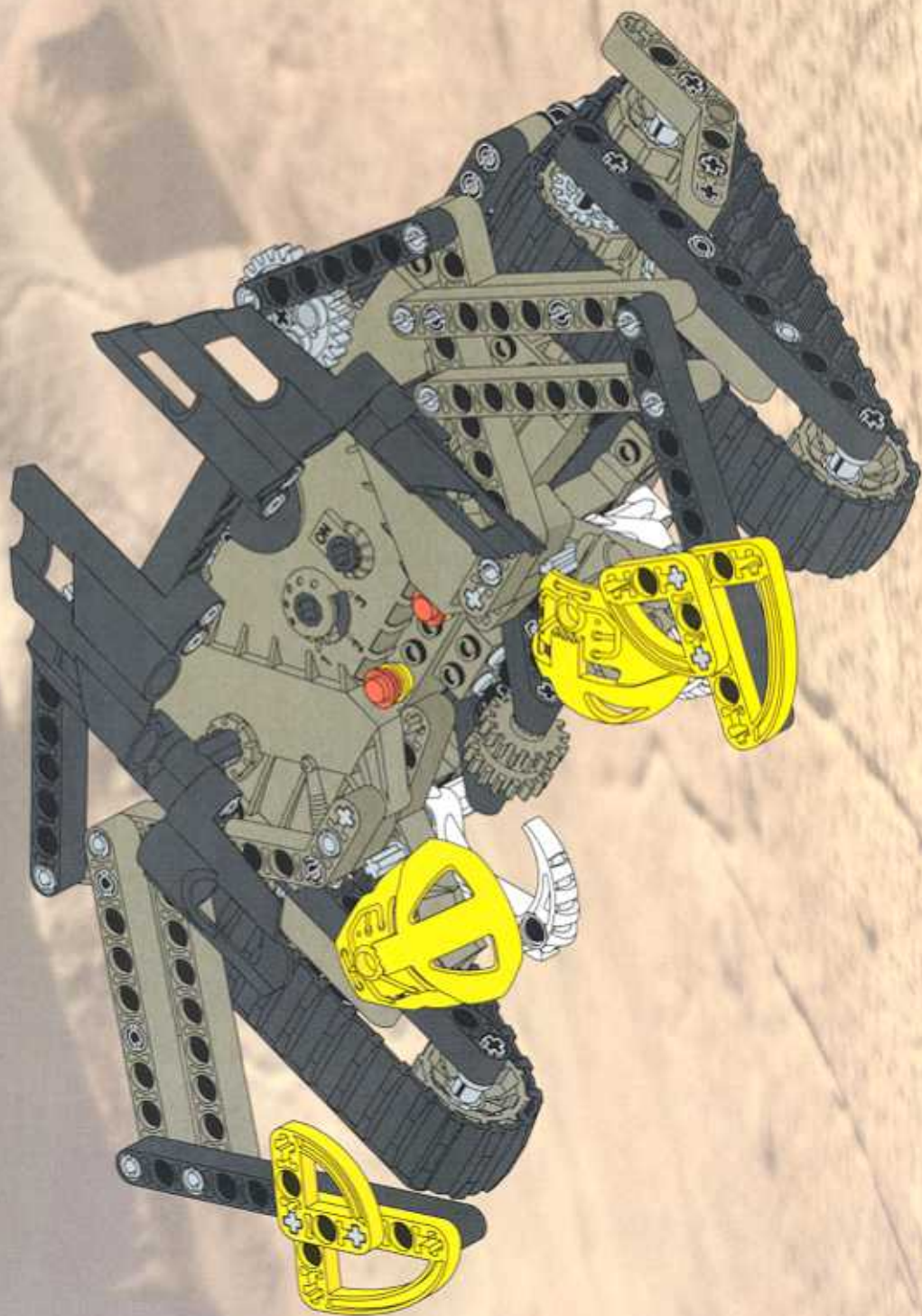

51

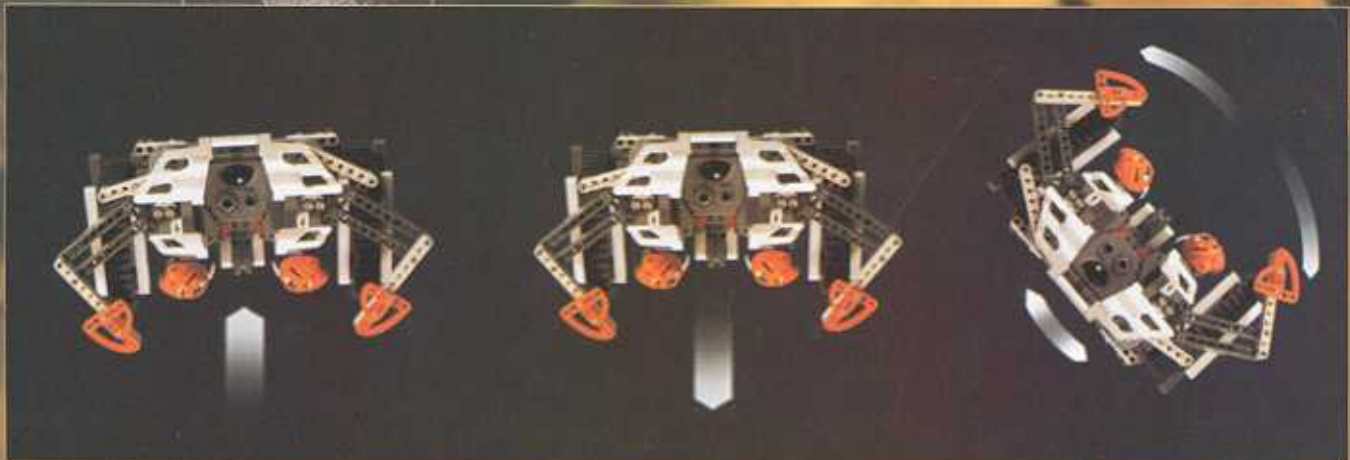

BIONICLE

www.bionicle.com

KANOHI

MIRU

AKAKU

KAUKAU

HAU

PAKARI

KAKAMA



TOA



TURAGA



MAHIKI

MATATU

RAU

HURA

RURU

KOMAU

72+



LEGO TECHNICAL

FIND THE POWER

ΜΥΑΚΑ & ΚΑΠΕ-ΡΑ
8538



ΠΥΙ-ΓΑΓΑ
8548



ΜΑΡΑΣ
8539



TARAKAVA
8549



BIONICLE



ΟΝΕΒΑ
8542

ΝΟΚΑΜΑ
8543

ΜΑΤΑΥ
8541

ΝΥΨΥ
8544

ΒΑΚΑΜΑ
8540

ΧΗΝΕΥΑ
8545

ΛΕΒΑ 8535

ΟΝΥΑ 8532

ΠΟΧΑΤΥ 8531

ΤΑΧΥ 8534

ΓΑΛΥ 8533

ΚΟΡΑΚΑ 8536



ΧΑΥ



ΜΙΡΥ

ΠΑΚΑΡΥ

LEGO TIME
AN ADVENTURE OF YOUR AGE



LEGO SOFTWARE



PC CD-ROM



GAME BOY™ ADVANCE



UNIVERSAL

LEGO, the LEGO logo and BIONICLE are trademarks of the LEGO Group. ©2001 The LEGO Group.



SLAMMER
TURBO

SLAMMER
STUNT BIKE

8242

8+

8240

7+



BATTLE CARS

8241

7+

LEGO TECHNIC

www.LEGO.com
JOIN THE FUN!
www.LEGO.com/createnrace