

BIONICLE

POHATU  NUVA



8568



1

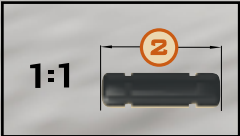
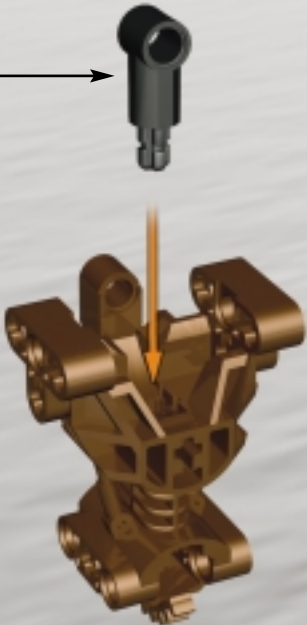

2

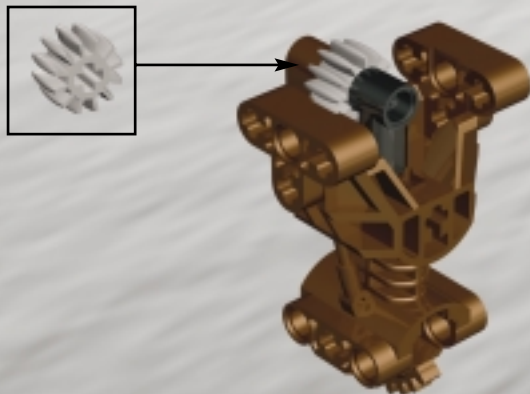

3

1:1

6

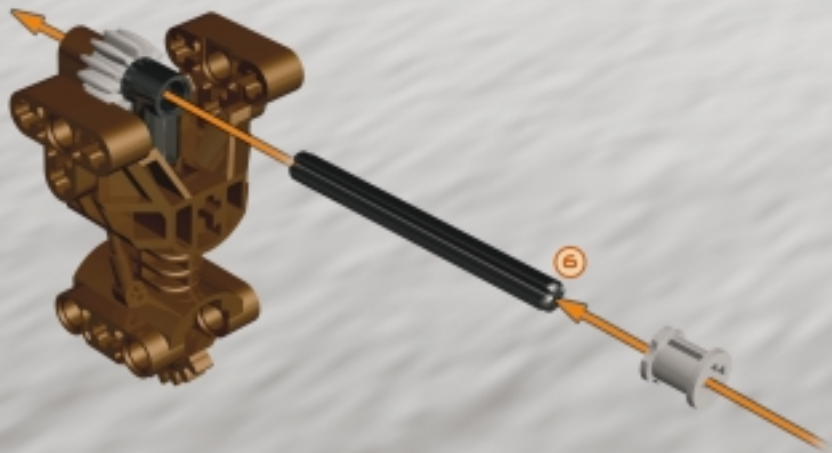

4

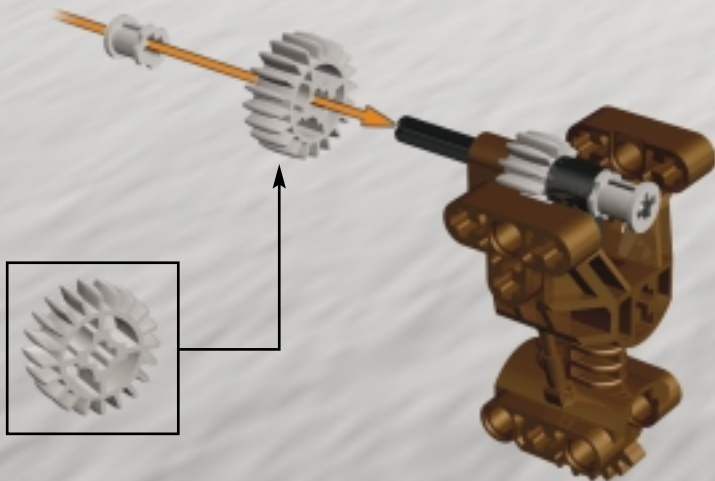

5

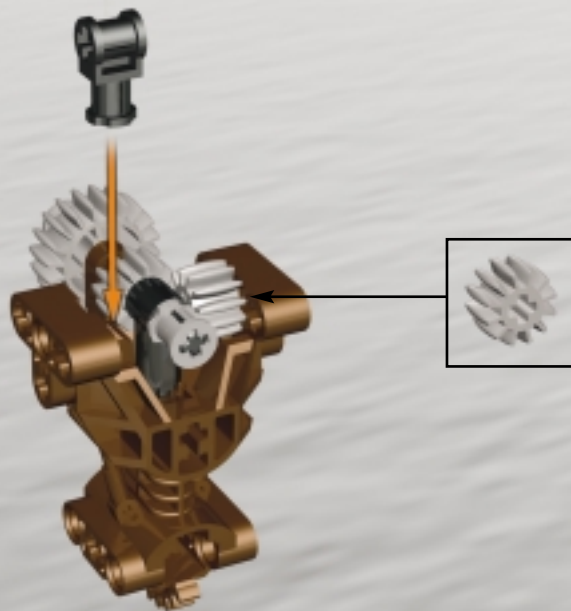

6

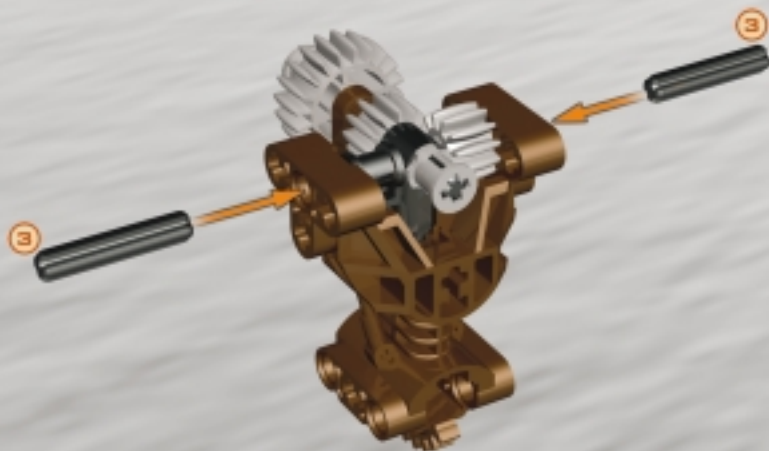

1:1



7

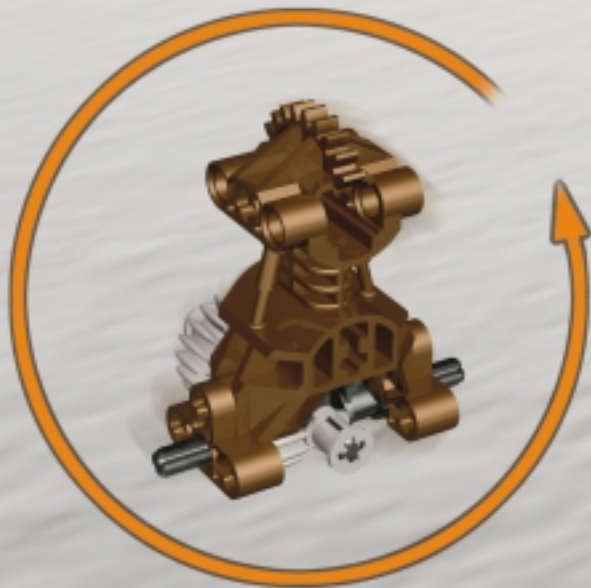

8

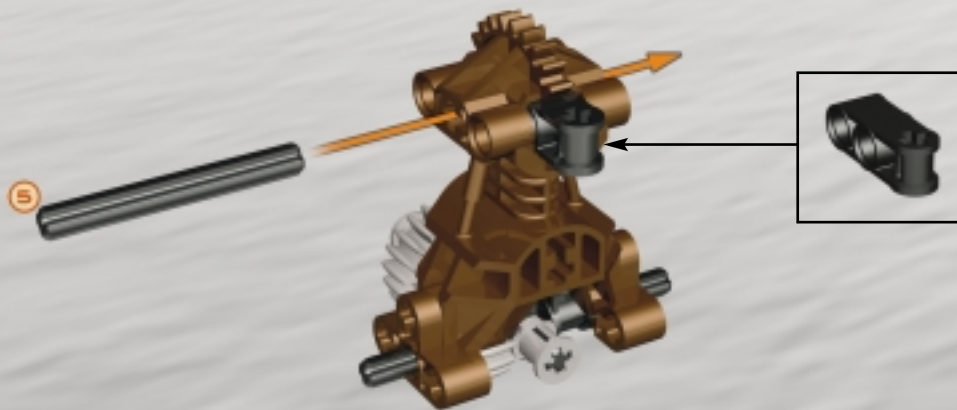

1:1

5

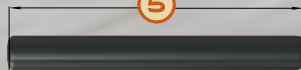

9

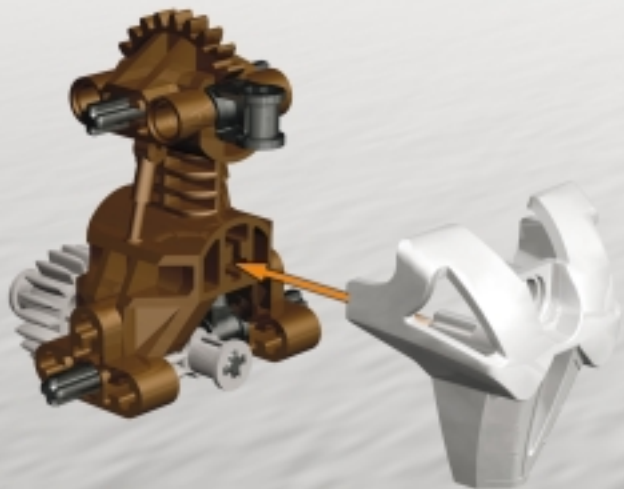

10

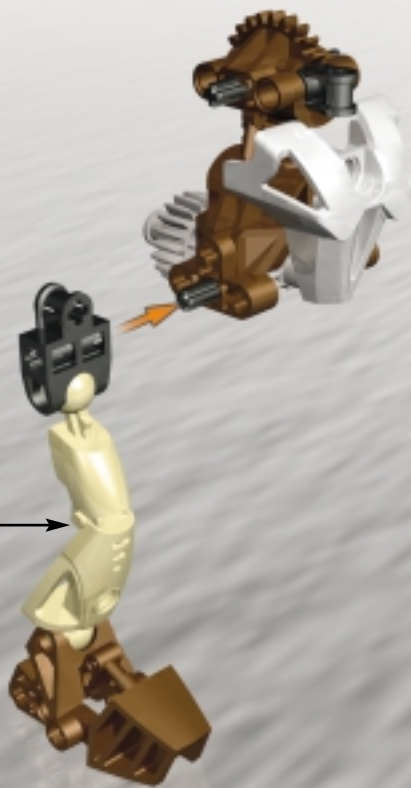

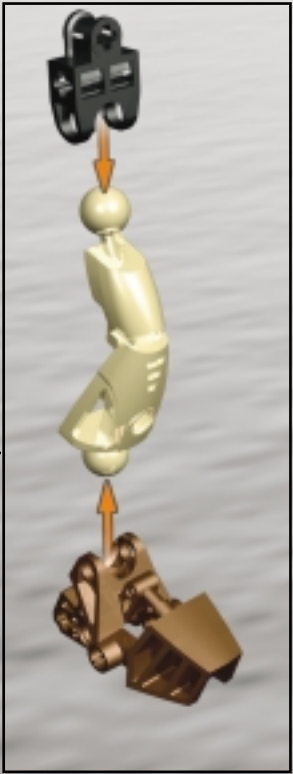
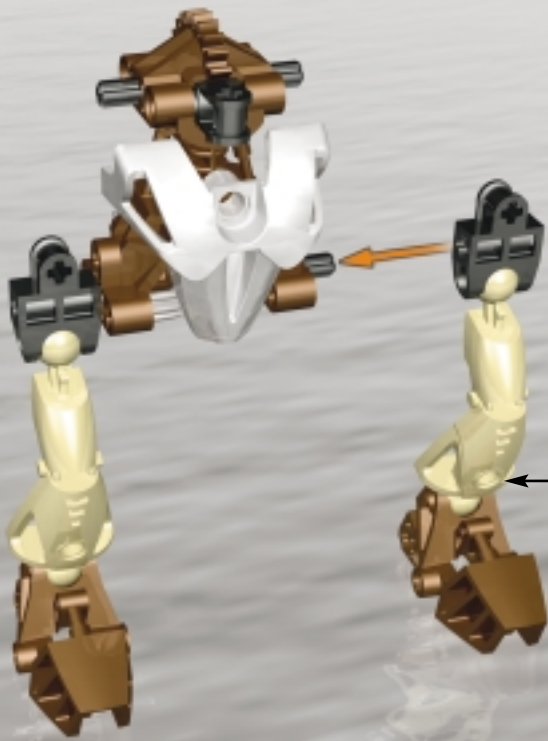

12

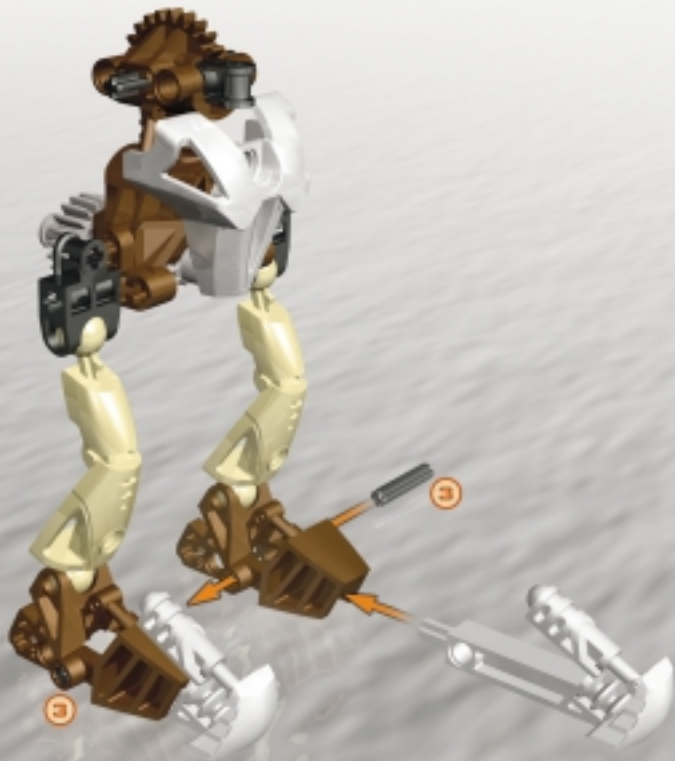

1:1

This inset diagram shows a grey Technic axle with a black pin inserted into one end. An orange circle with the number '3' is positioned above the axle, indicating that three of these components are needed for this step.

13

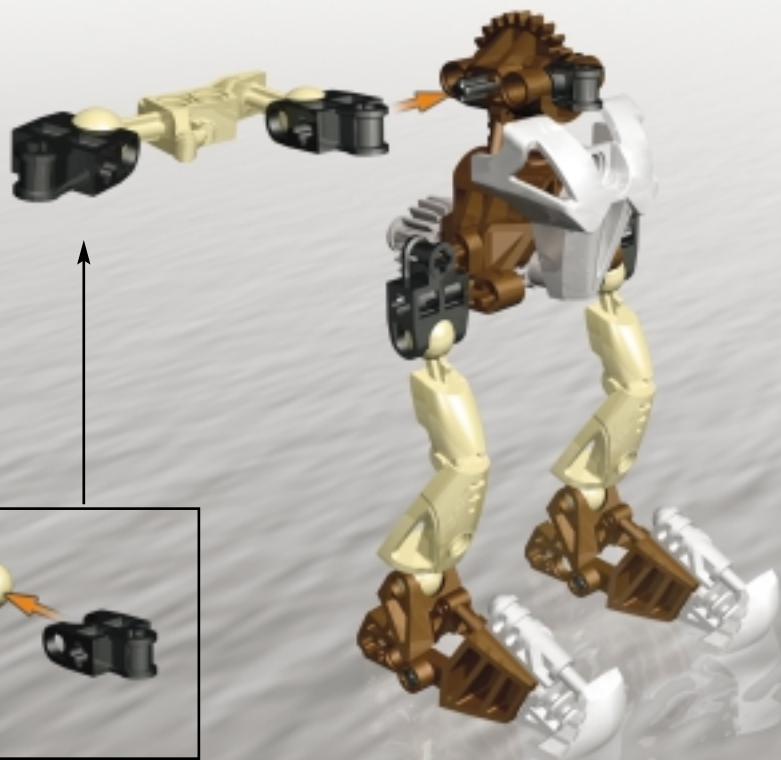

14

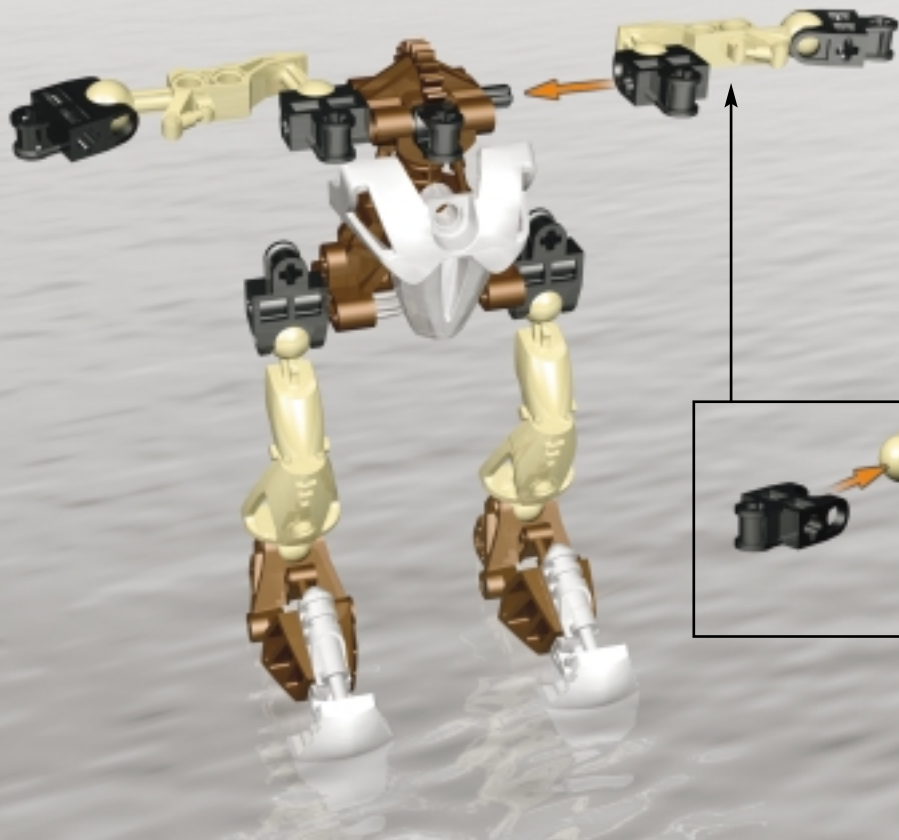

15



16

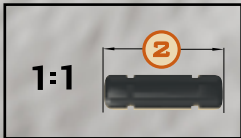
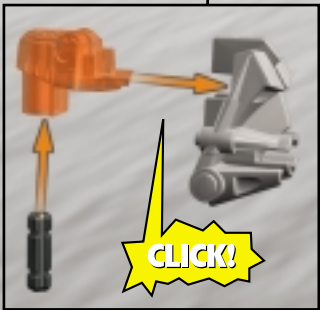

17



18



1

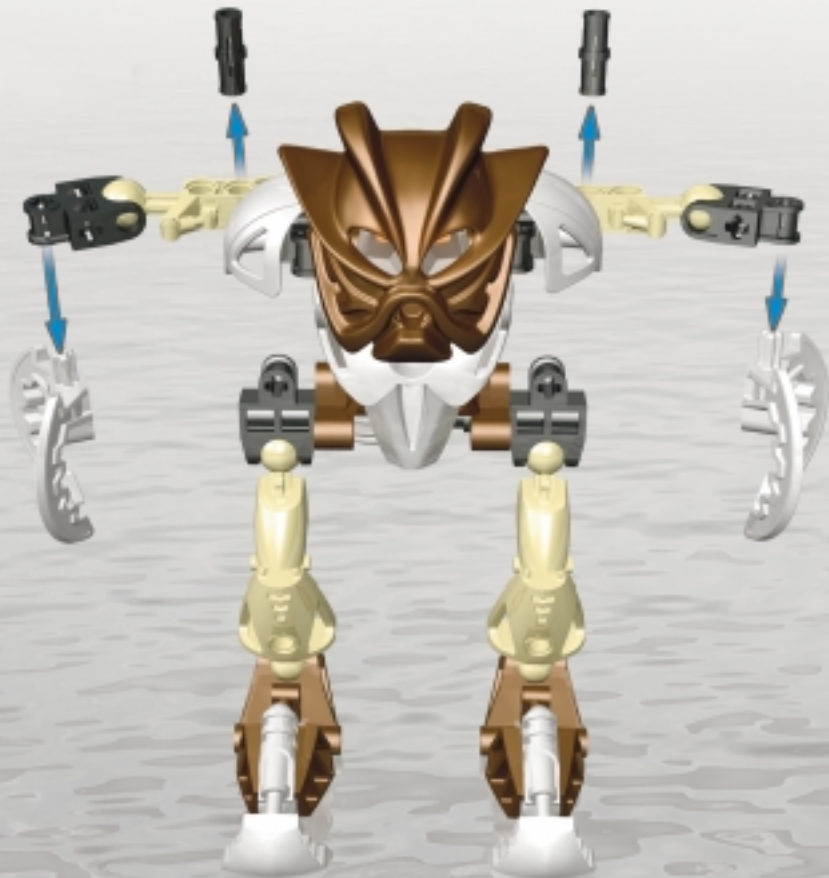

2



1



2



1



2







8566



8568



8572



14

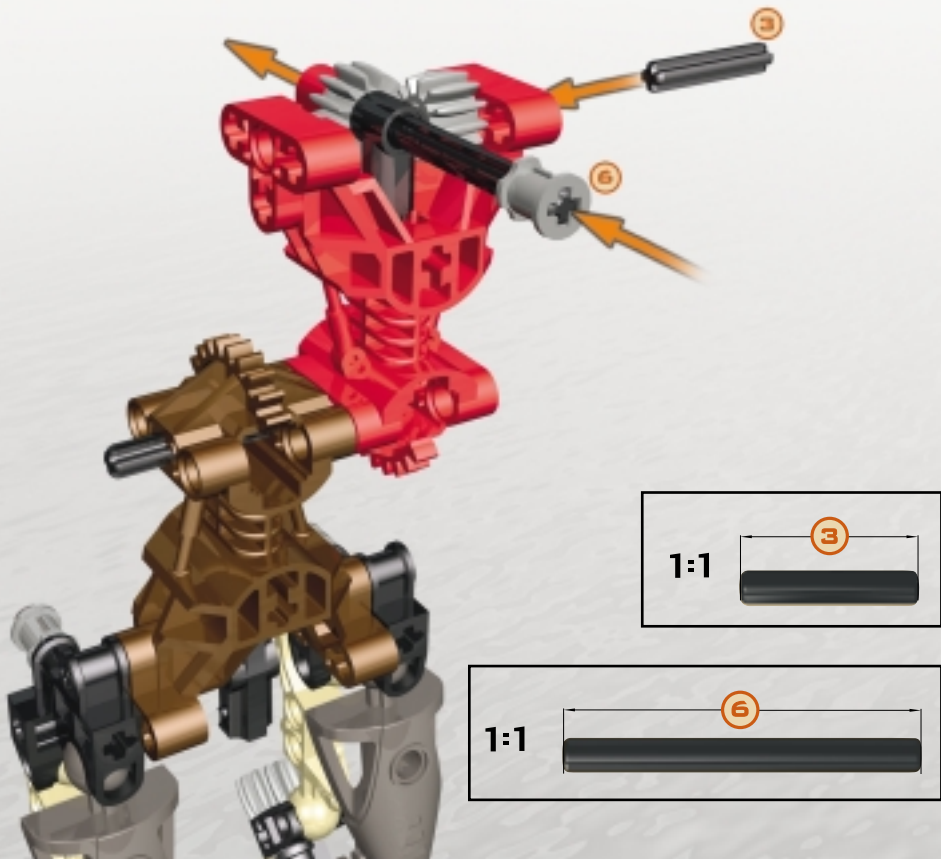

15

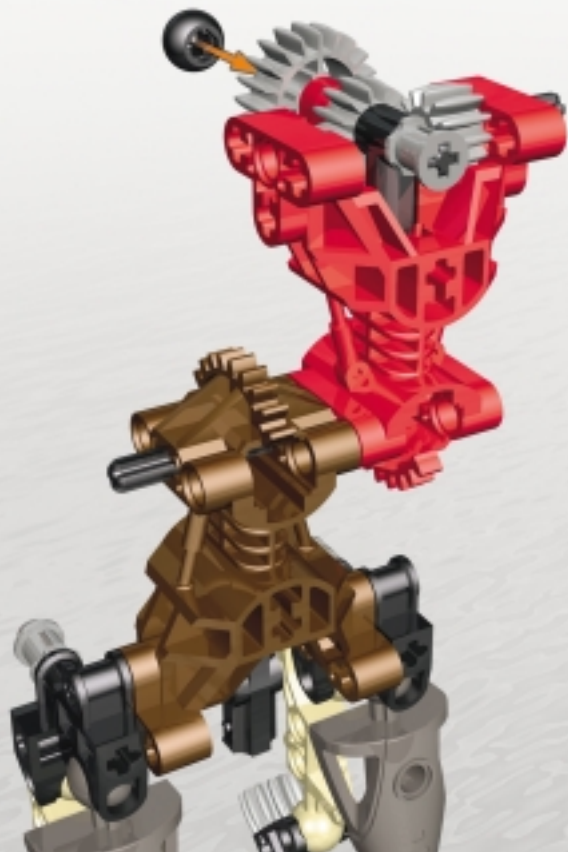

16

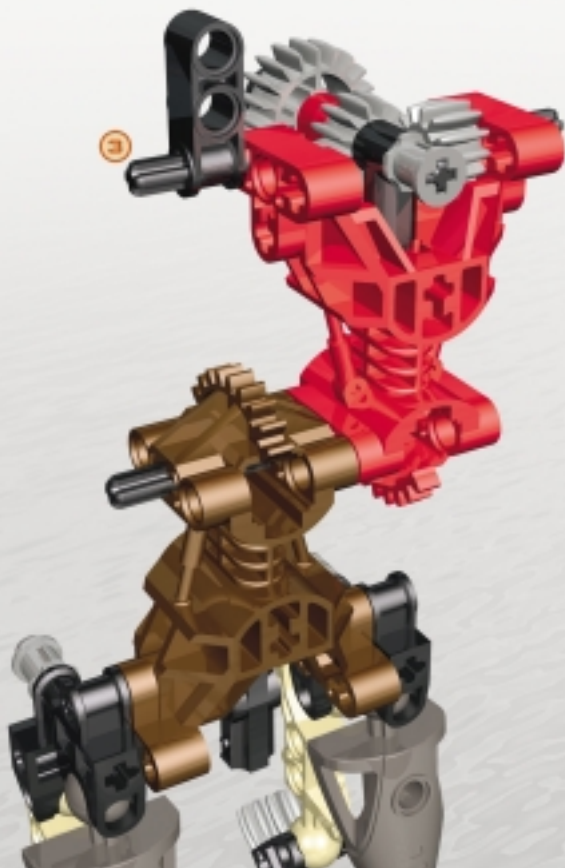

1:1



17

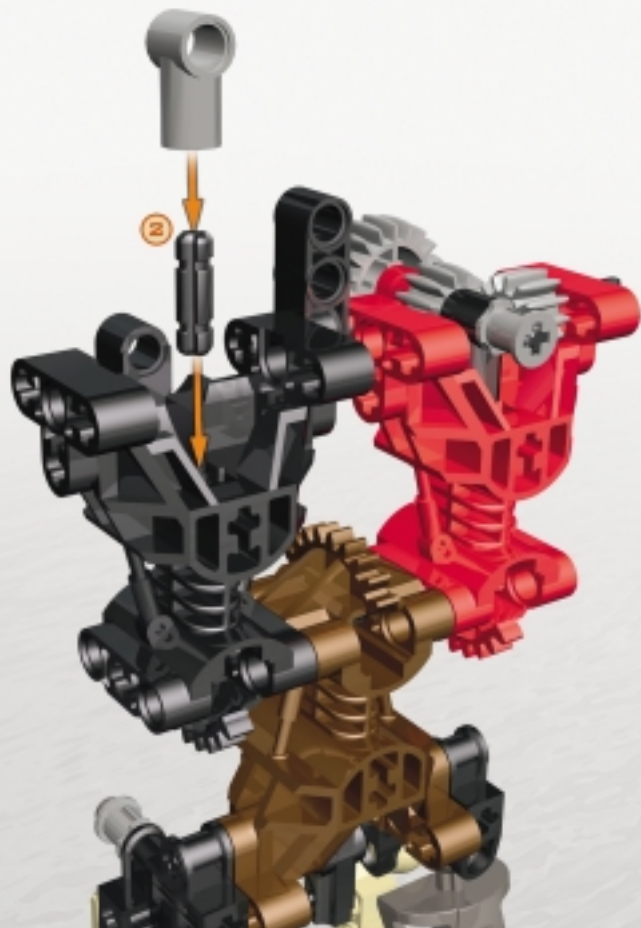

1:1



18



1:1



1:1



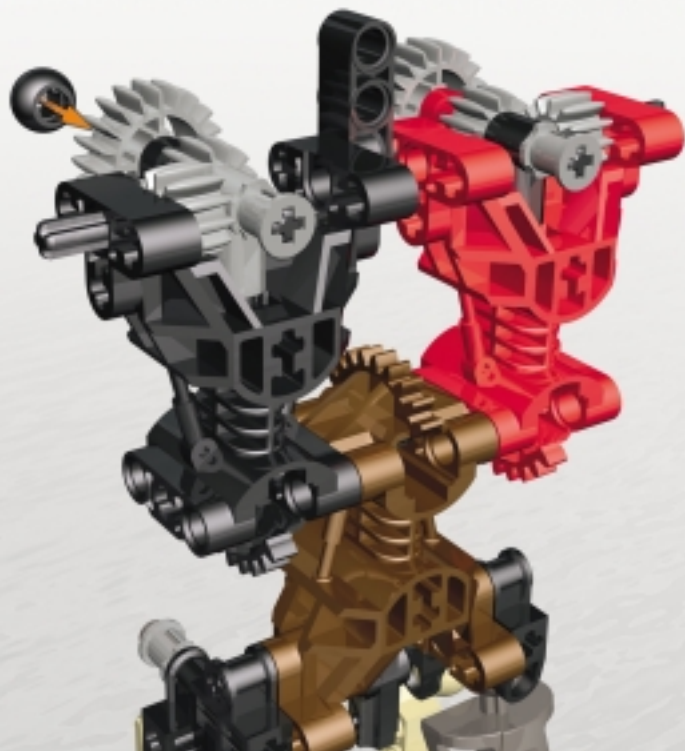

20

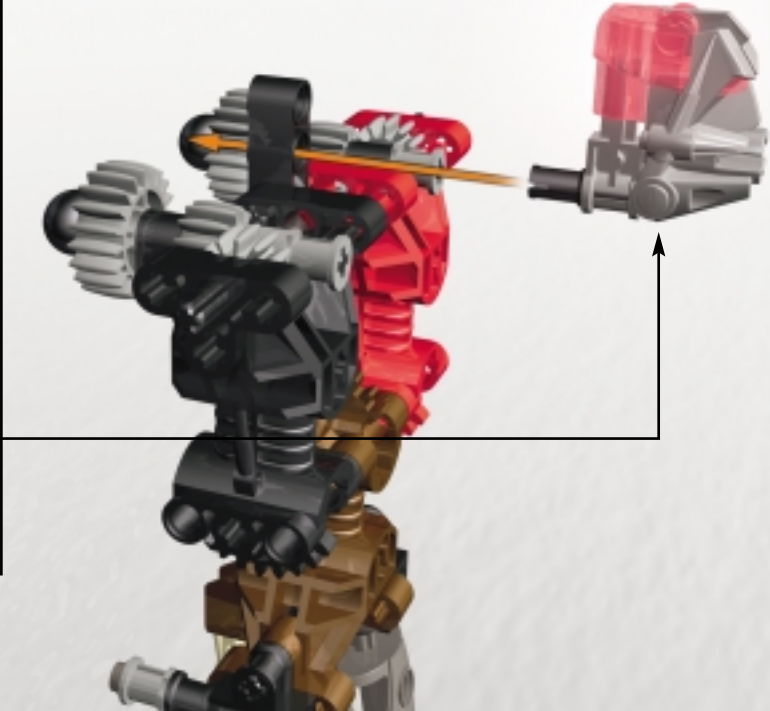
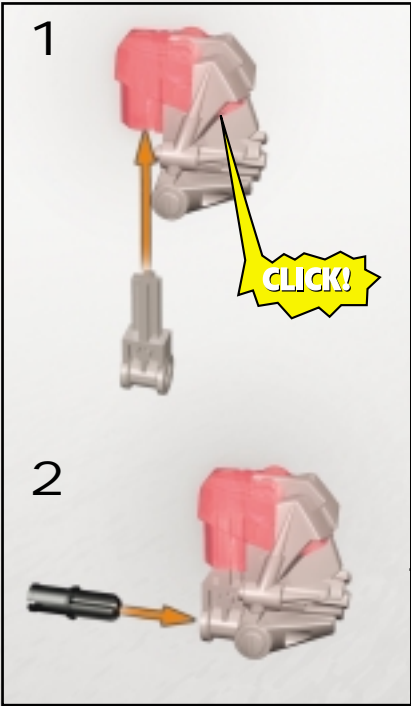

1



2



21



1



2

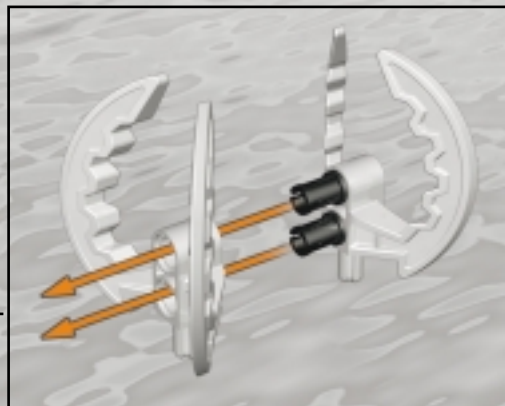

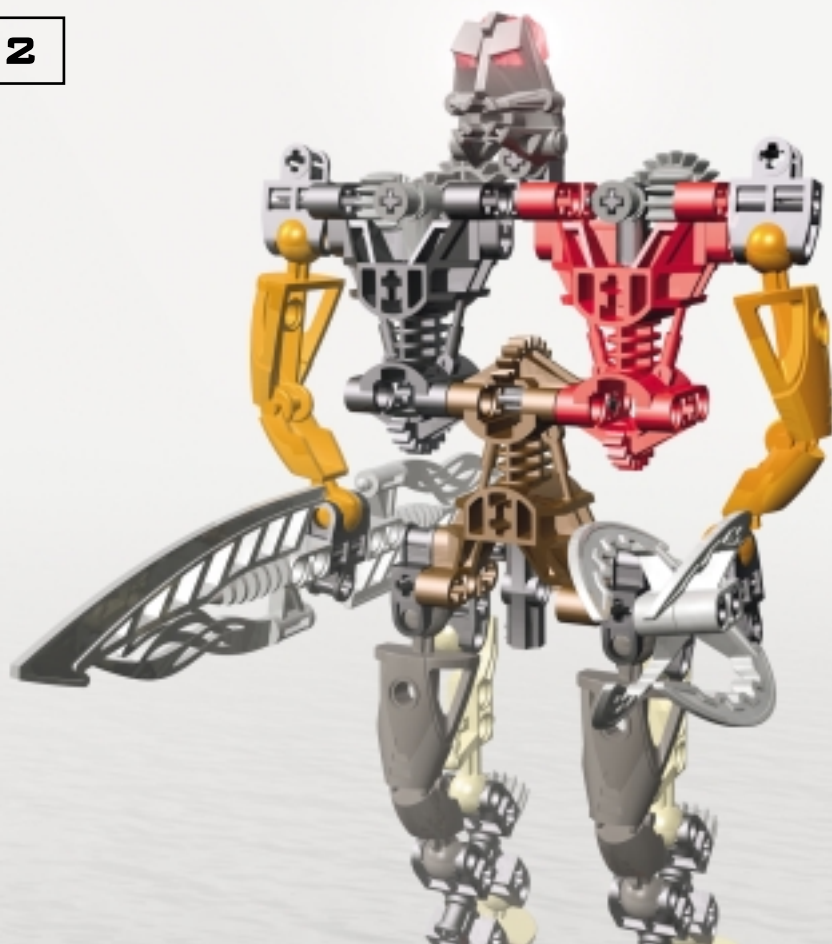

23

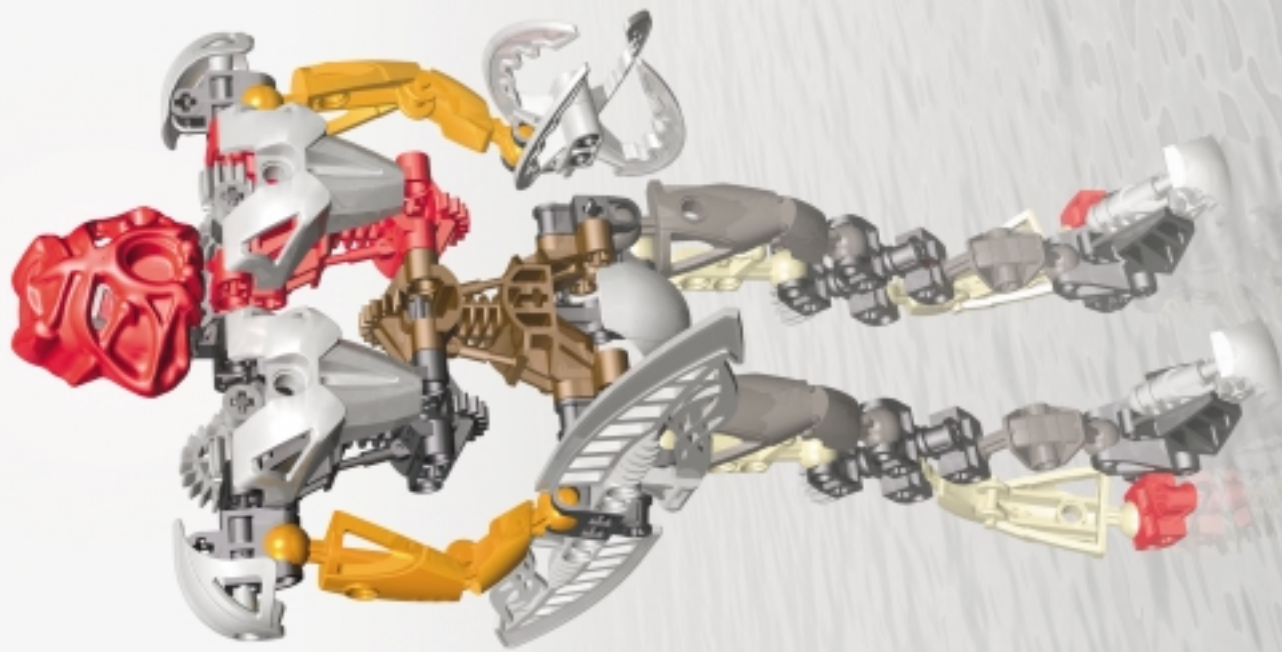



BIONICLE



www.bionicle.com