



NINJAGO

Masters of Spinjitzu



9444



1

CONVERTS

1

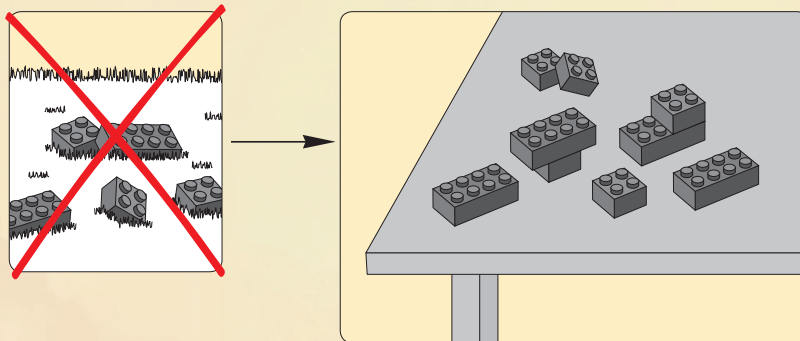

2

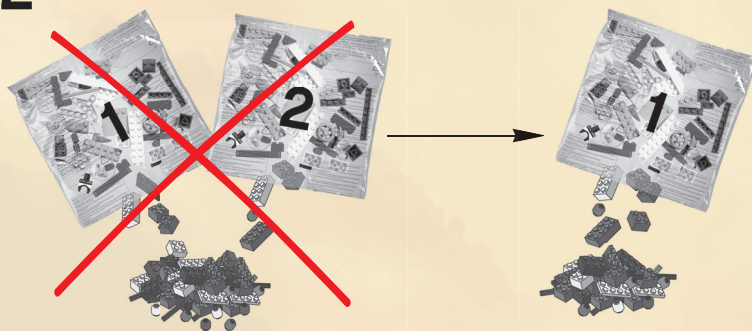

- EN IMPORTANT: Never modify the elements or use other projectiles than provided with this toy.
- DE WICHTIG: Die Elemente dürfen nicht verändert werden. Es dürfen ausschließlich die mit dem Spielzeug mitgelieferten Geschosse verwendet werden.
- FR IMPORTANT : Ne jamais modifier les éléments ni utiliser d'autres projectiles que ceux fournis avec ce jouet.
- IT IMPORTANTE: non modificare gli elementi o utilizzare proiettili non forniti con questo prodotto.
- NL BELANGRIJK! Verander niets aan de elementen en gebruik geen andere projectielen dan de bij het speelgoed geleverde.
- ES IMPORTANTE: No modifique los elementos ni utilice otros proyectiles diferentes a los suministrados junto con este juguete.
- DA VIGTIGT: Elementerne må ikke ændres, og der må ikke bruges andre projektiler end dem, der følger med legetøjet.
- FI TÄRKEÄÄ: Älä koskaan tee osiin muutoksia tai käytä lelussa muita kuin sen sisältämiä ammuksia.
- SV VIKTIGT: Modifiera aldrig delarna och använd aldrig andra projektiler än de som medföljer denna leksak.
- PT IMPORTANTE: Nunca modifique os elementos nem utilize projécteis que não tenham sido fornecidos com este brinquedo.
- EL ΣΗΜΑΝΤΙΚΟ: Ποτέ μην τροποποιείτε τα στοιχεία του παιχνιδιού και μην χρησιμοποιείτε άλλα βλήματα εκτός από αυτά που συνοδεύουν αυτό το παιχνίδι.
- JA 重要：部品を改造したり、本製品に付属の発射体以外のものを使用しないでください。
- ZH 重要提示：切勿更改组件或使用并非由本玩具附带的弹丸。
- KO 중요함: 이들 부품을 수정하거나 이 완구의 함께 제공된 것이 아닌 발사체는 결코 사용하지 마십시오.
- RU ВАЖНО: запрещается вносить изменения в элементы или использовать другие снаряды, отличные от тех, которые поставляются с данной игрушкой.
- PL WAŻNE: Nigdy nie modyfikować elementów zabawki ani nie używać pocisków innych niż dostarczone z zabawką.
- CZ UPOZORNĚNÍ: Nikdy neupravujte součástky a nepoužívejte jiné projektily než ty, které jsou dodávány s touto hračkou.
- SK UPOZORNENIE: Nikdy neupravujte súčiastky a nepoužívajte iné projektily než tie, ktoré sú dodávané s touto hračkou.
- HU FONTOS: Az elemeket nem szabad módosítani, és a játékhoz adott lövedékek helyett sem szabad mást használni.
- UA ВАЖЛИВО: забороняється вносити зміни до елементів або використовувати інші снаряди на відміну від тих, що поставляються з цією іграшкою.
- HR VAŽNO: Nemojte nikad mijenjati elemente ili koristiti druge projektilne osim onih koji su bili priloženi uz ovu igračku prilikom kupnje.
- SR Важно: Немојте да модификујете елементе и не користите друге пројектиле осим оних који долазе уз ову играчку.
- SL POMEMBNO: Nikoli ne spreminjajte elementov in uporabljajte le izstrelke, ki so bili priloženi tej igrači.
- RO IMPORTANT: Nu modificați niciodată elementele și nu utilizați alte proiectile decât cele furnizate cu această jucărie.
- BG ВАЖНО: Не видоизменяйте елементите и не използвайте други снаряди освен приложените към тази играчка.
- LV SVARĪGI! Nekad nepārveidojiet rotālietas elementus, vienmēr izmantojiet tikai tās komplektā iekļautās lodītes.
- ET OLULINE: Mänguasja osi ei tohi teistega asendada, kasutada võib ainult kaasasolevat heitkeha.
- LT DĖMESIO! Niekuomet nekeiskite elementų ir naudokite tik tuos šovinius, kurie yra pridėti prie šio žaislo.
- TR ÖNEMLİ: Hiçbir zaman parçalarda değişiklik yapmayın veya bu oyuncakla sağlananlar dışında mermiler kullanmayın.

2

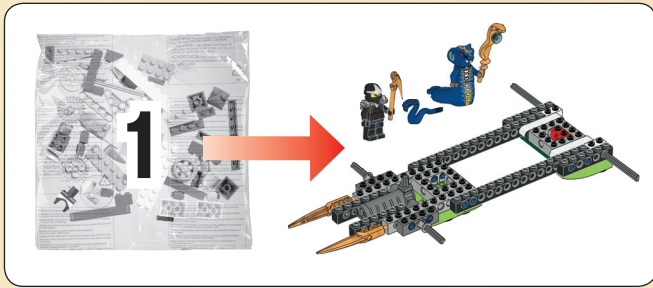

CONVERTS
TRANSFORMIERBAR
TRANSFORMATION
CONVERTIBLE
CONVERTÍVEL
ÁTALAKÍTHATÓ

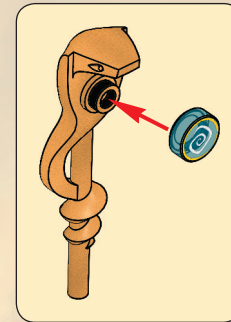
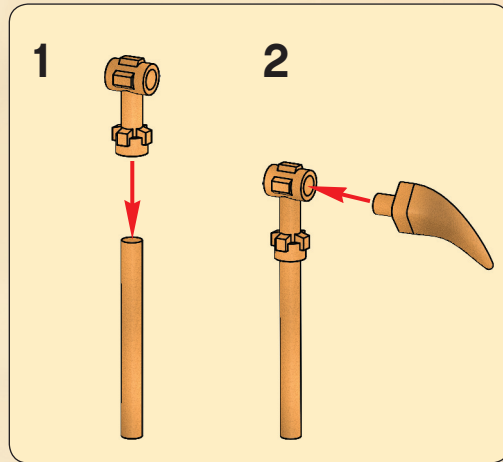
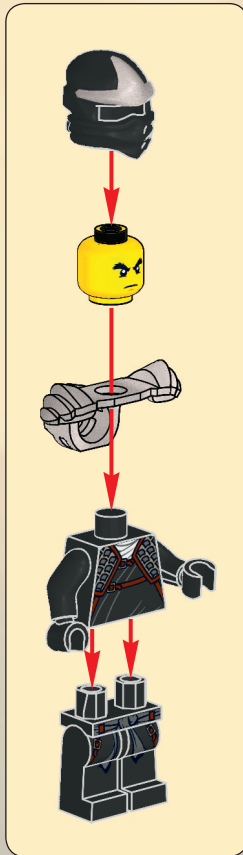

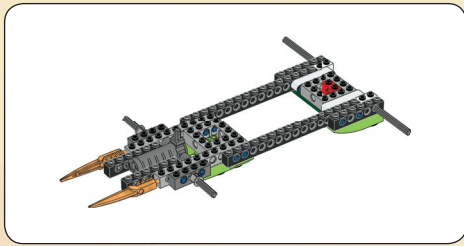

1

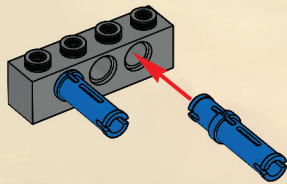

4

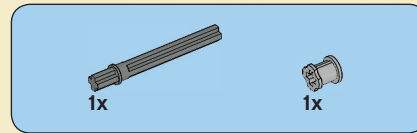

2

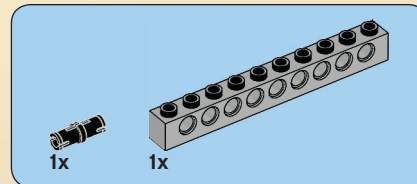
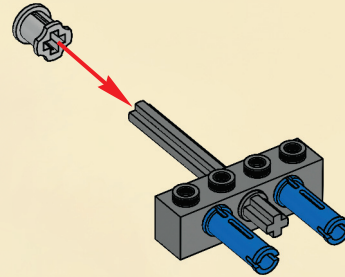

3

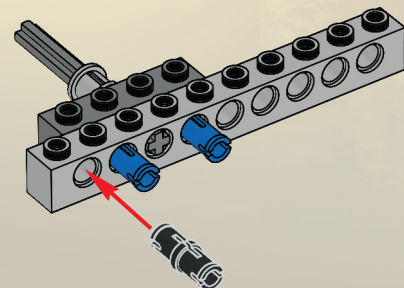

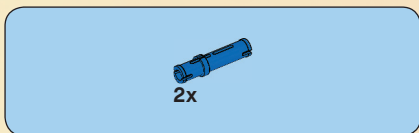

4

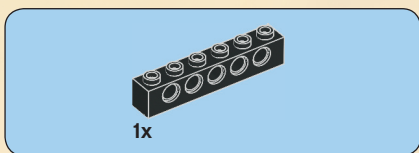
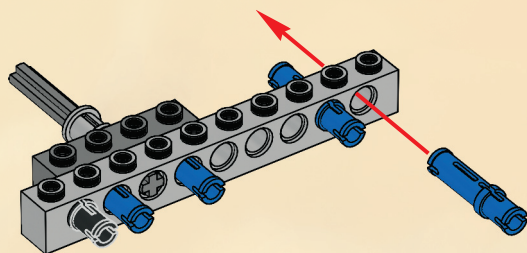

5

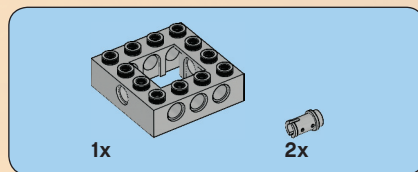
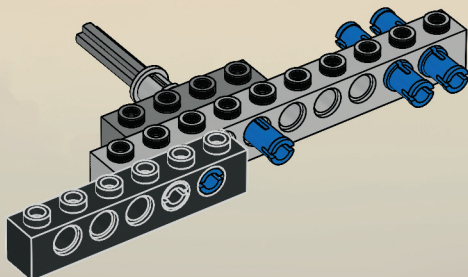

6

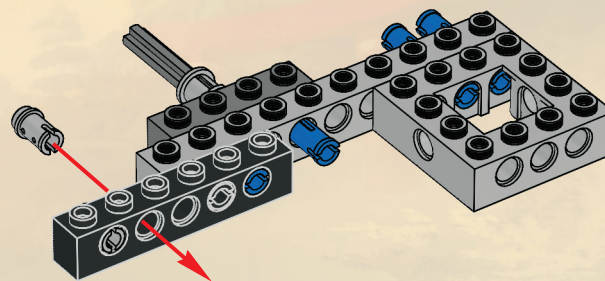

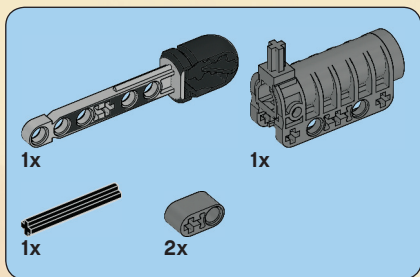

7

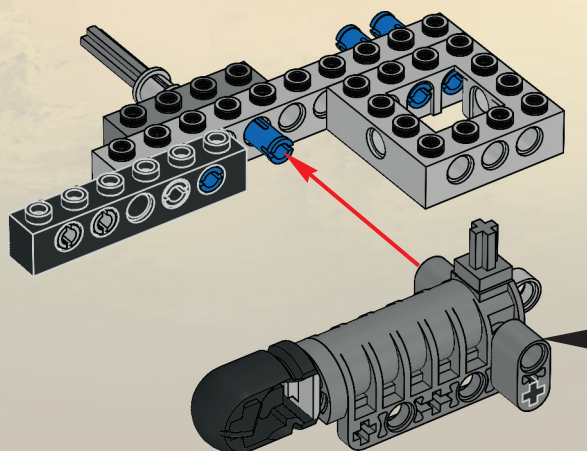
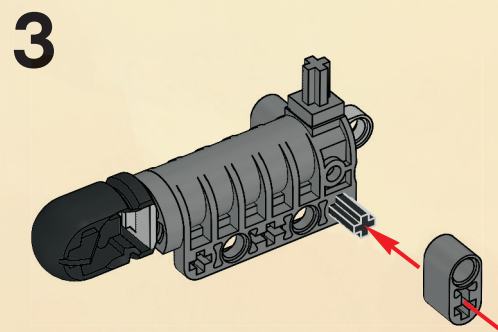
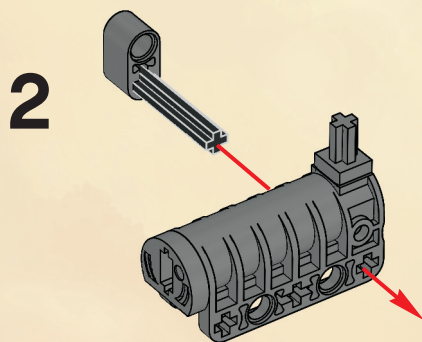
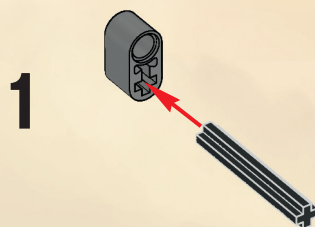

6



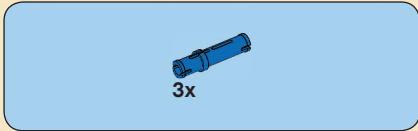
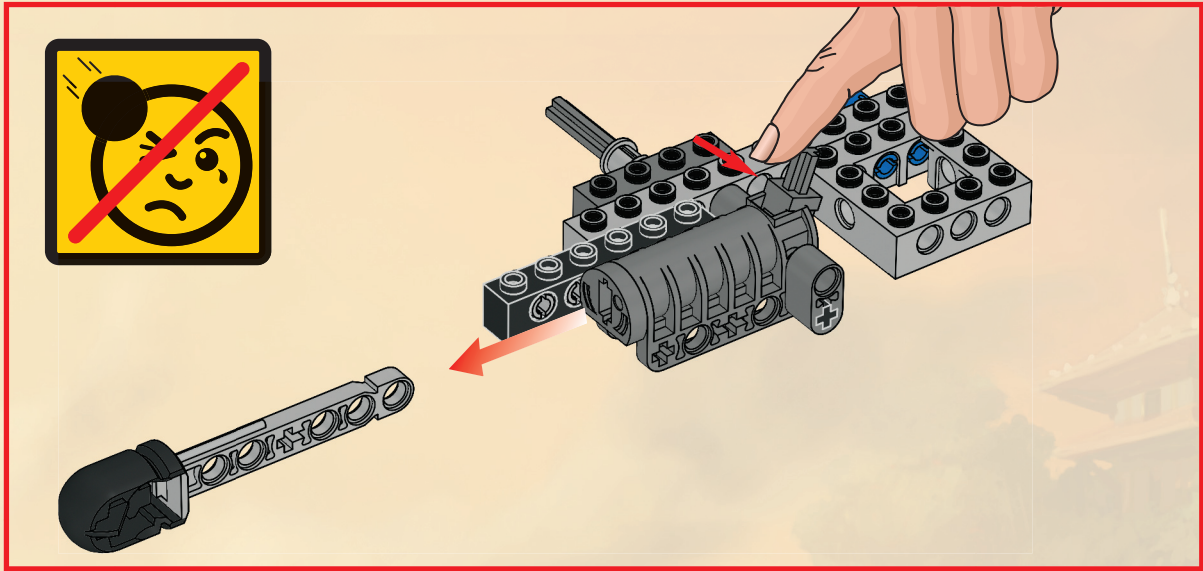

8

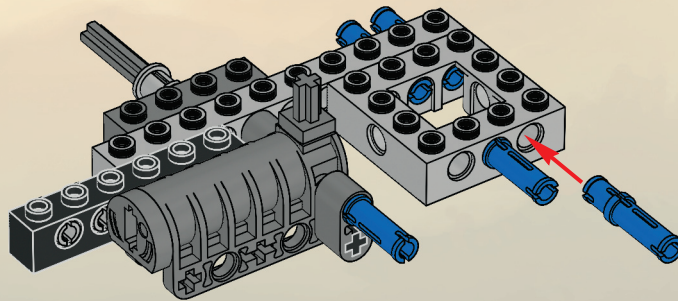

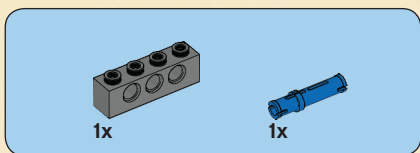

1

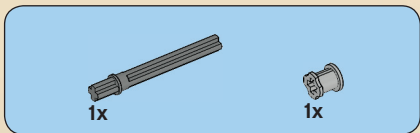
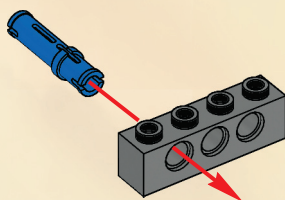

2

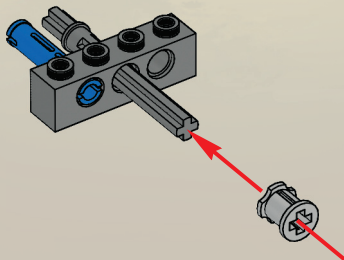

8

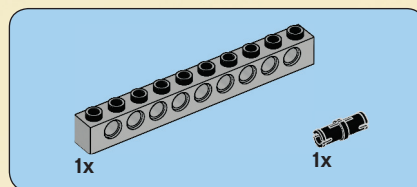

3

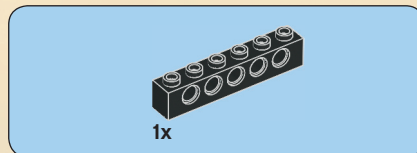
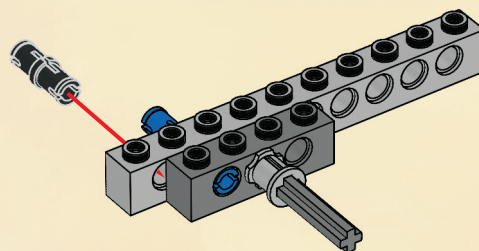

4

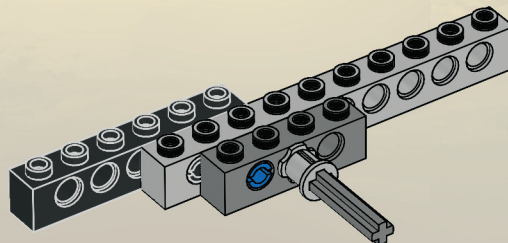

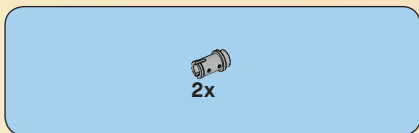

5

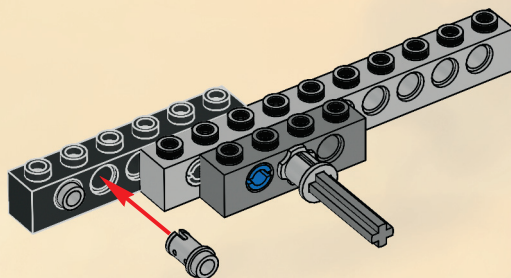

9

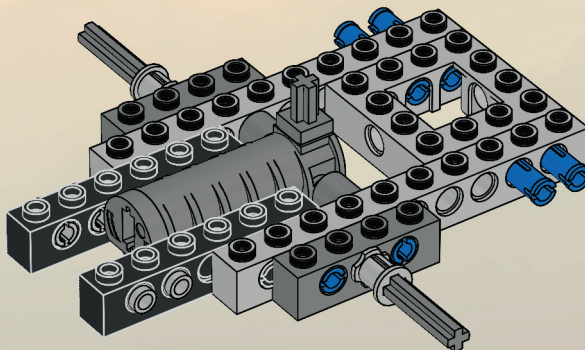

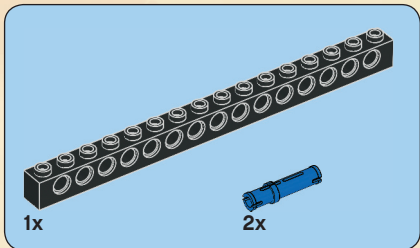
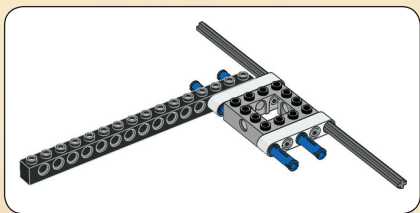

1

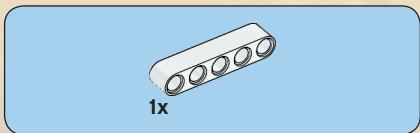
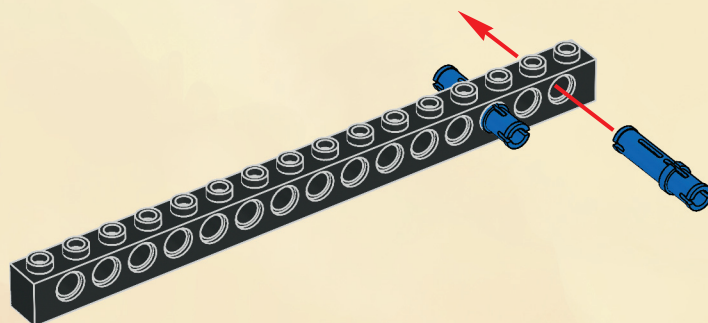

2

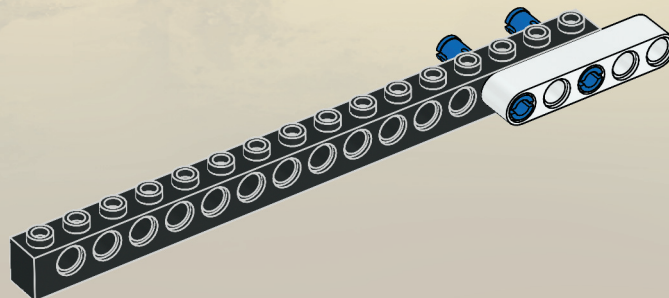

10



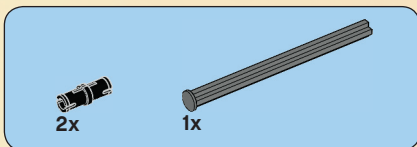

3

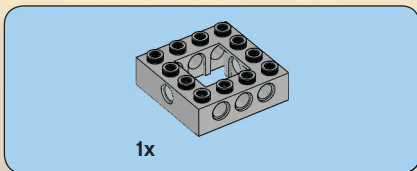
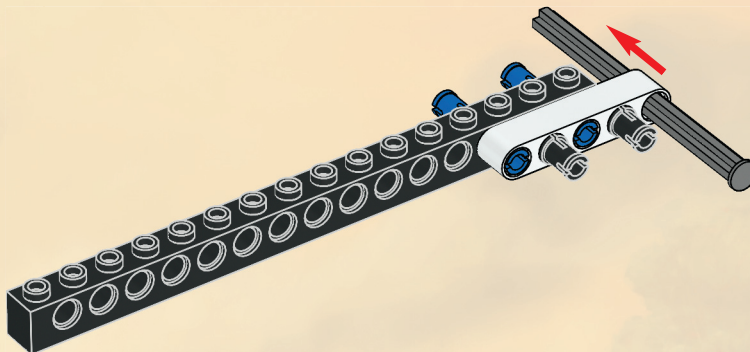

4

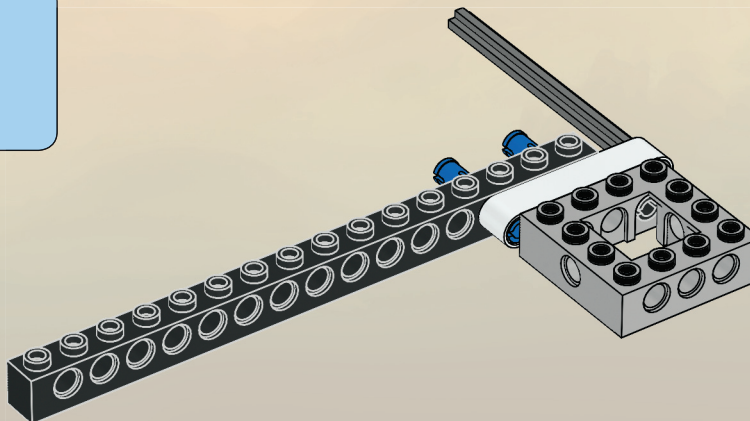



5

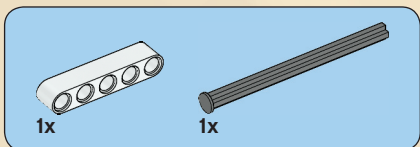
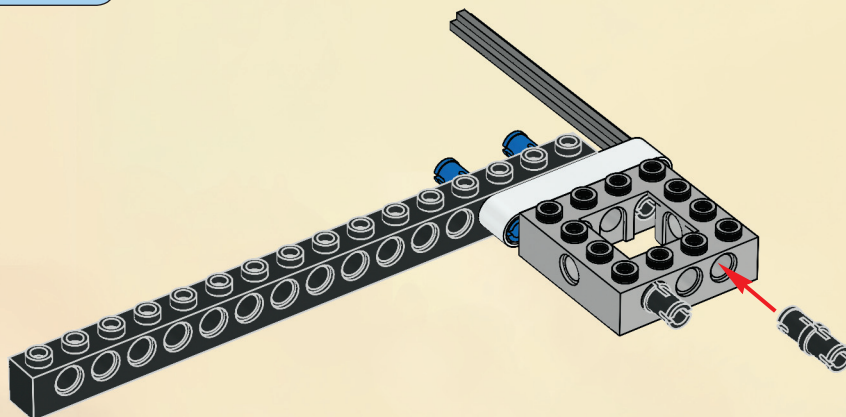

6

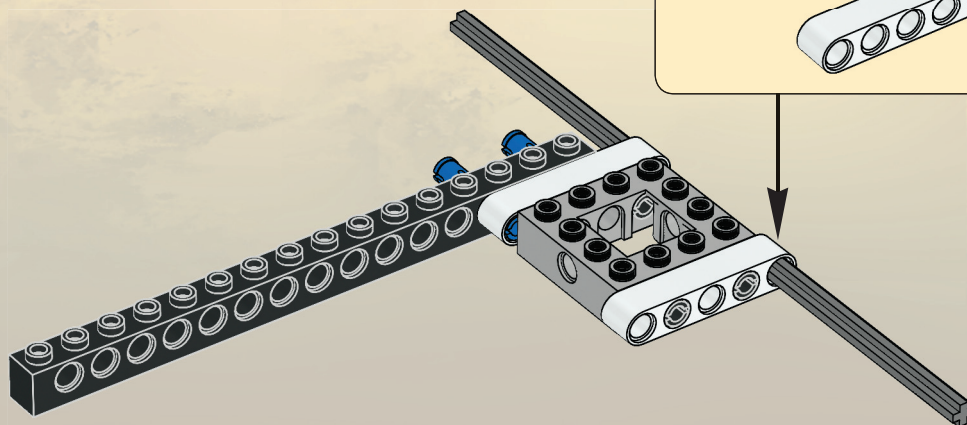
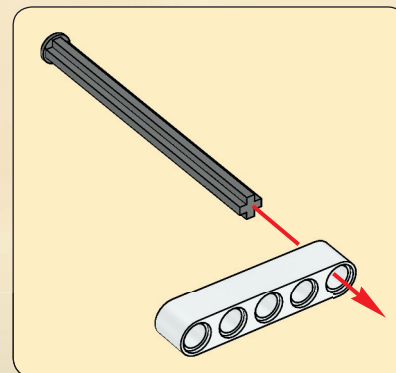

12





7

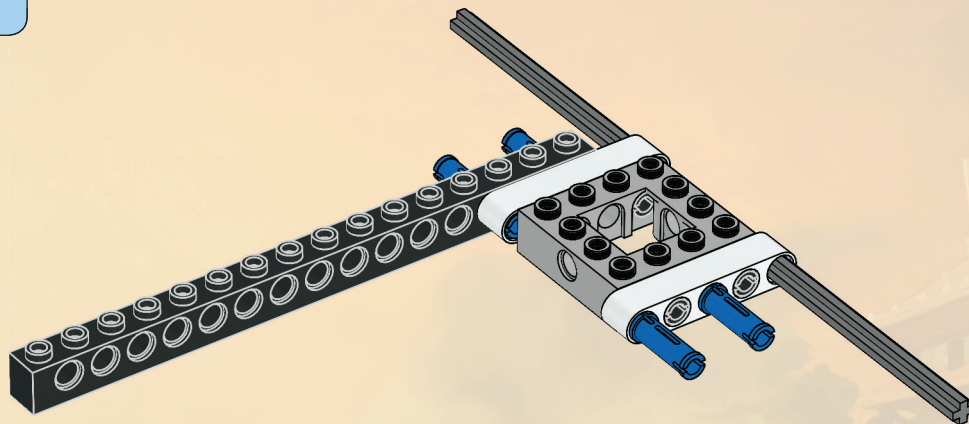

10

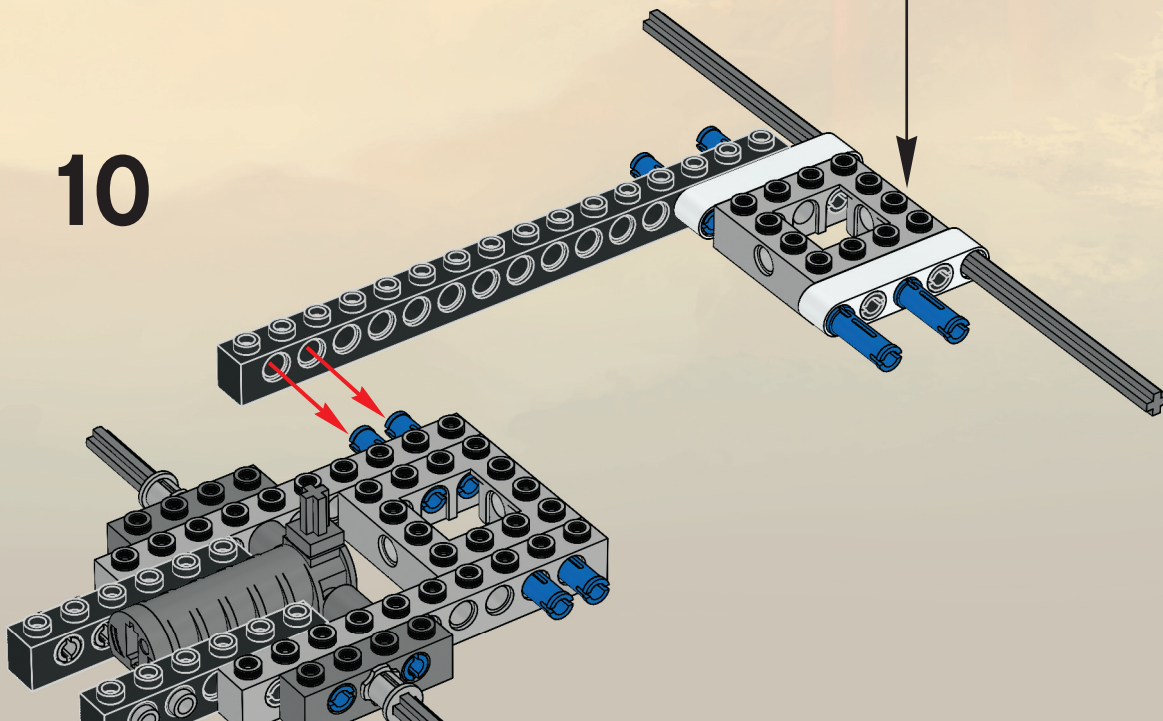

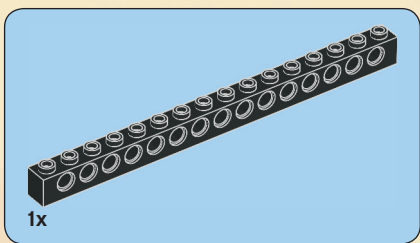

11

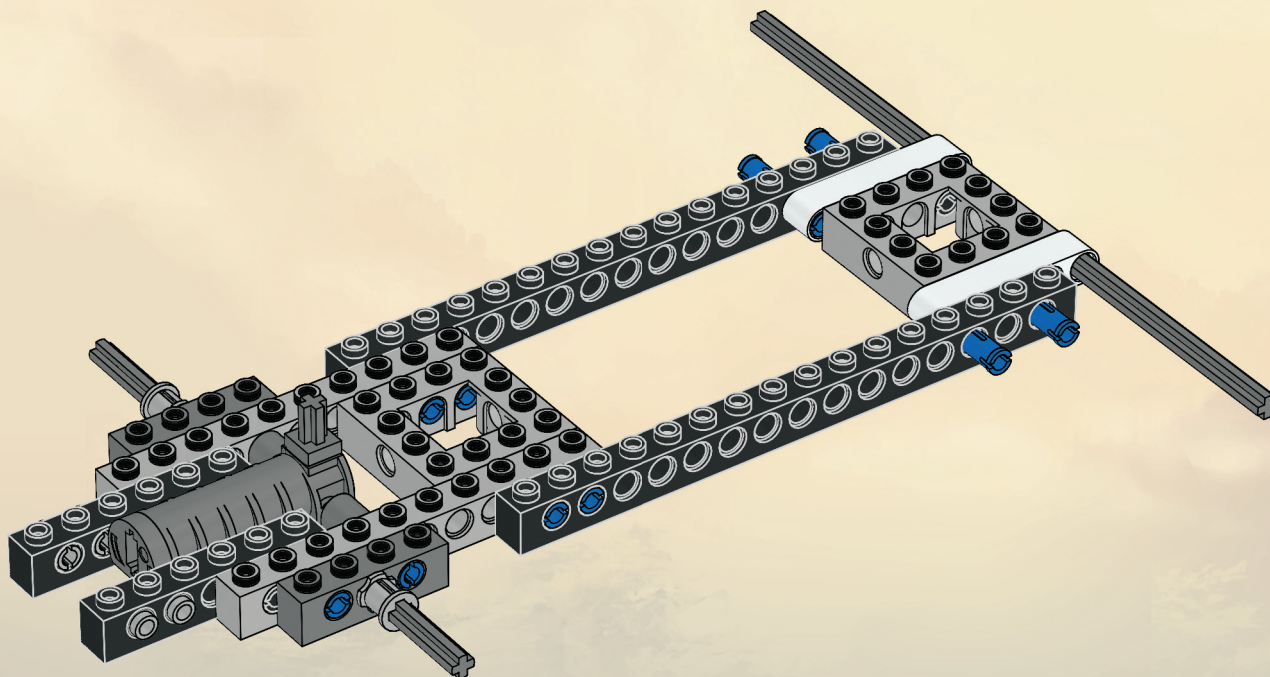

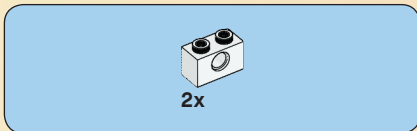

12

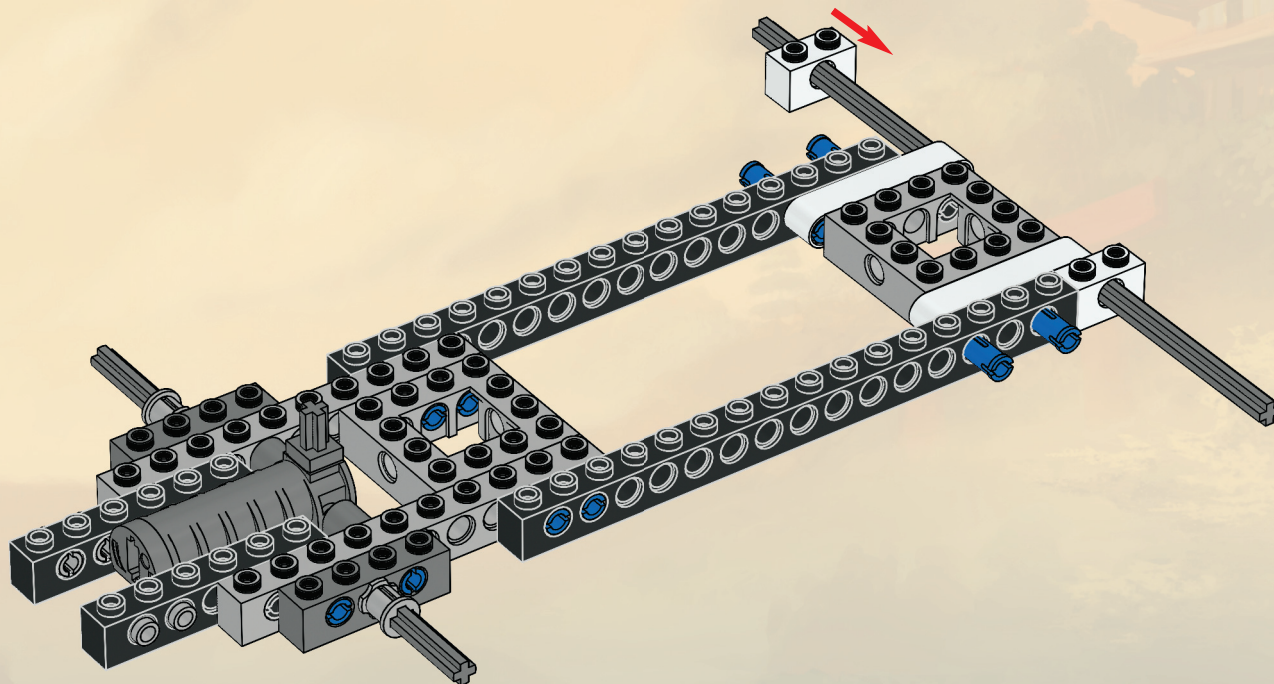

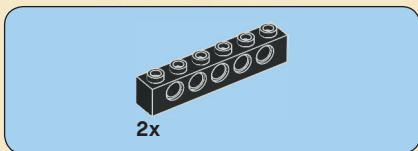

13

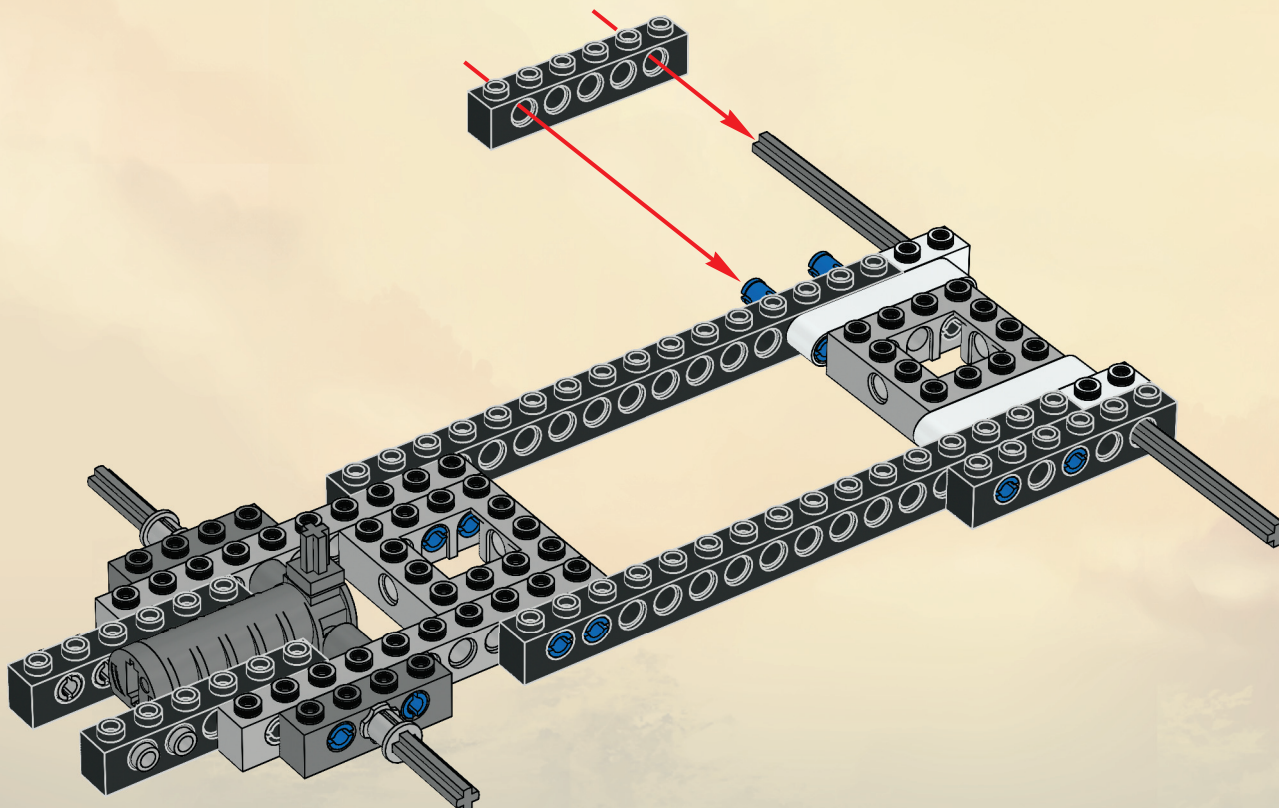

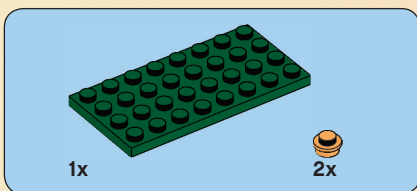

14

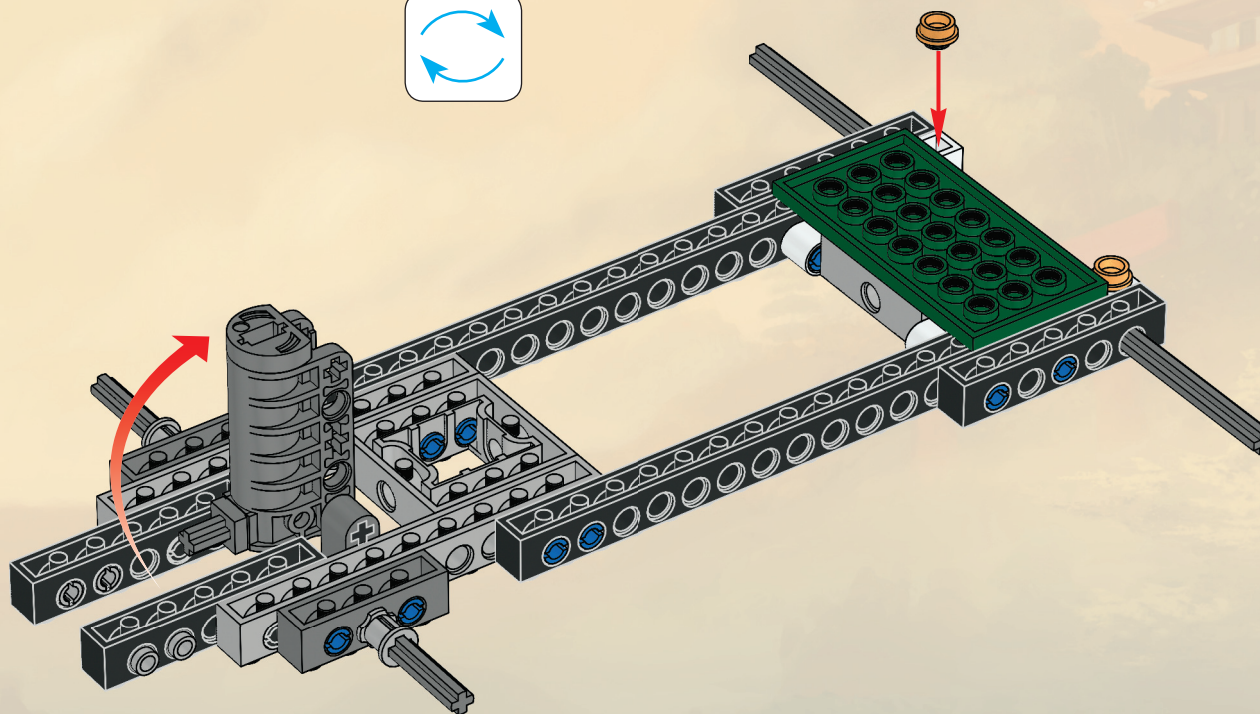
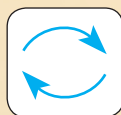

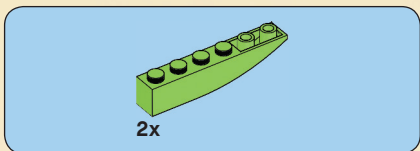

15

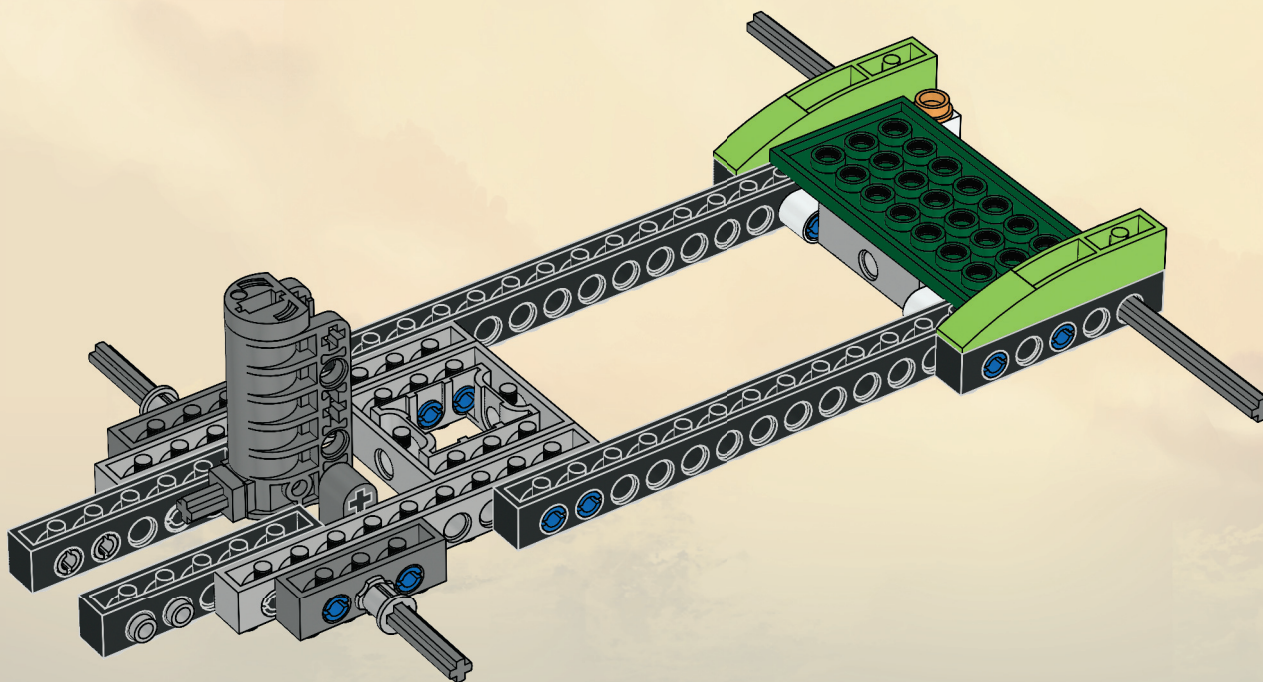

18



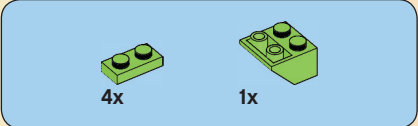

16

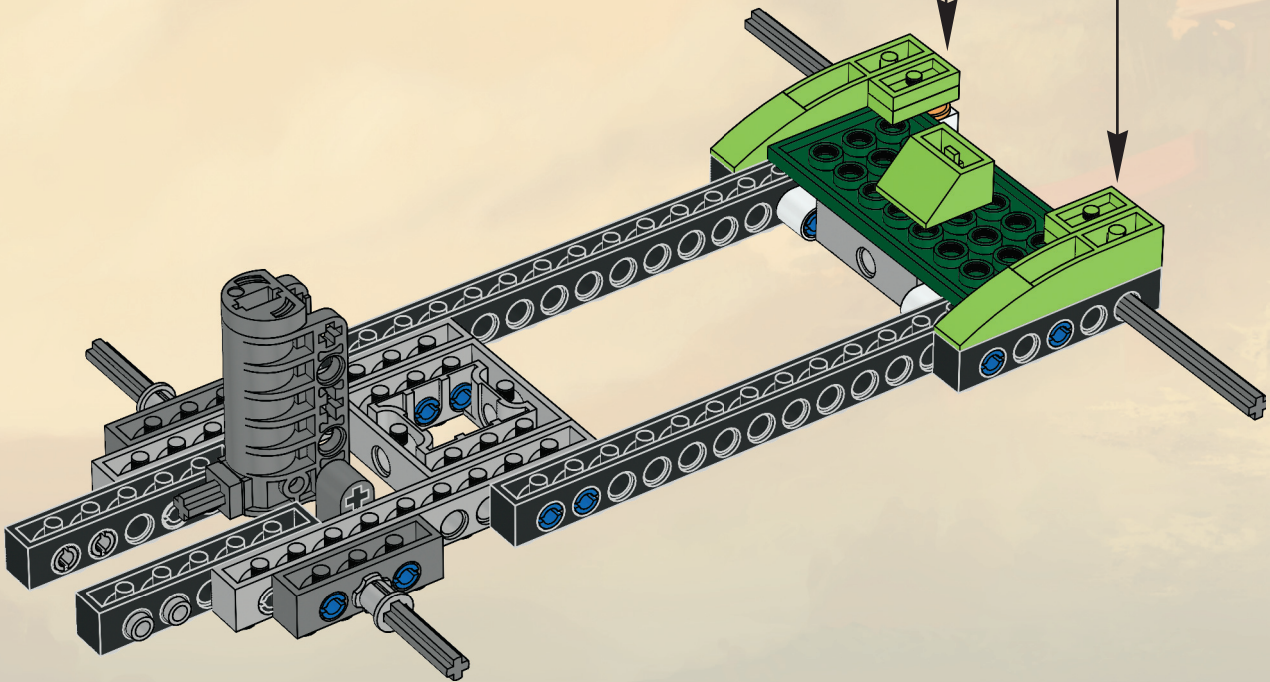
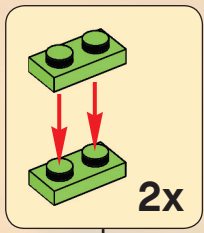

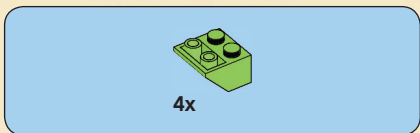

17

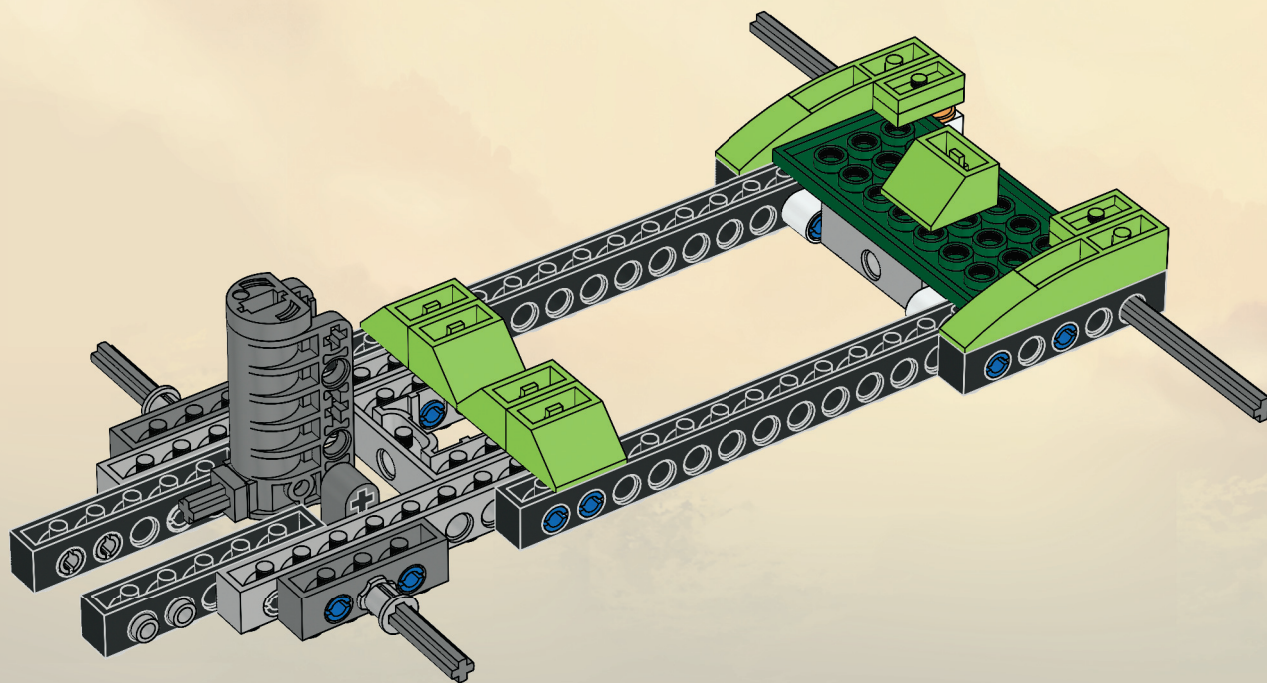

20



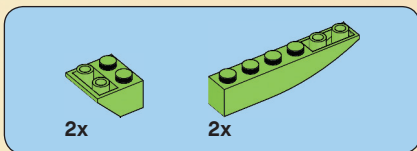

18

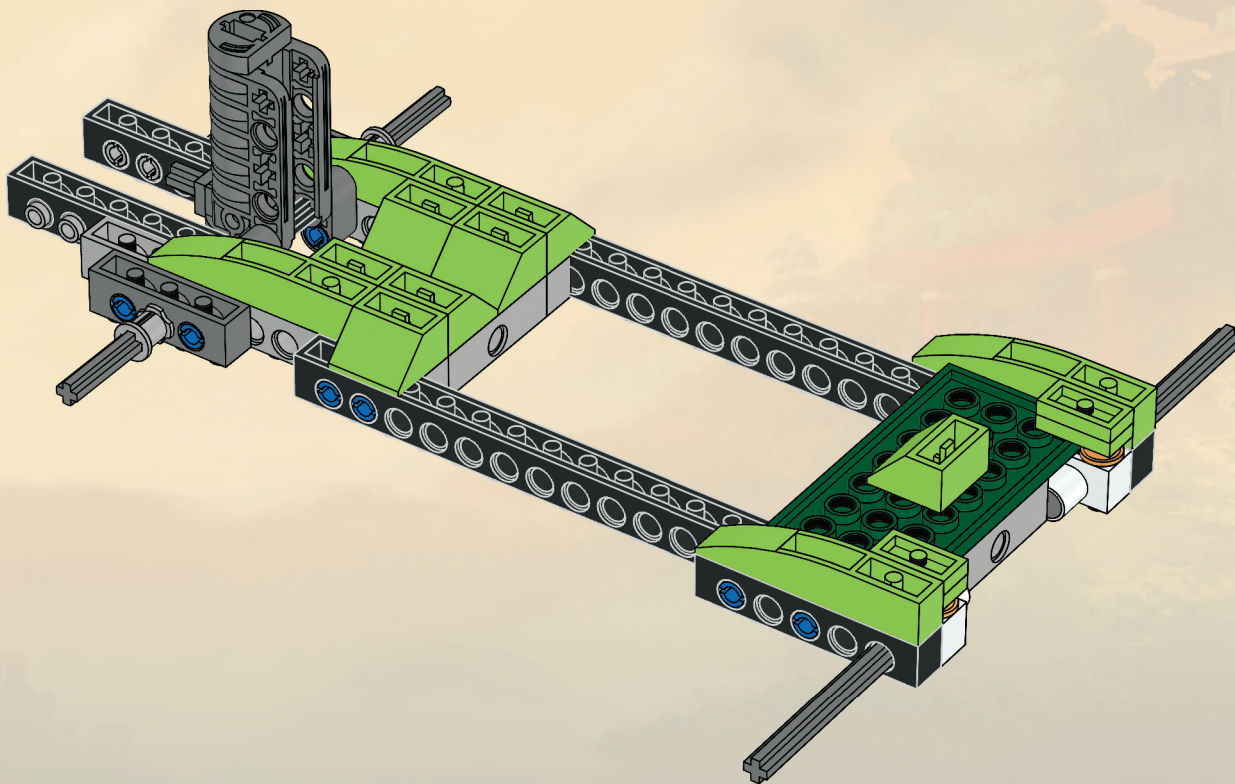

21



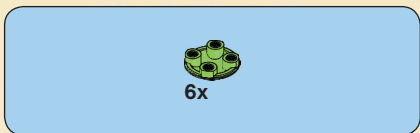

19

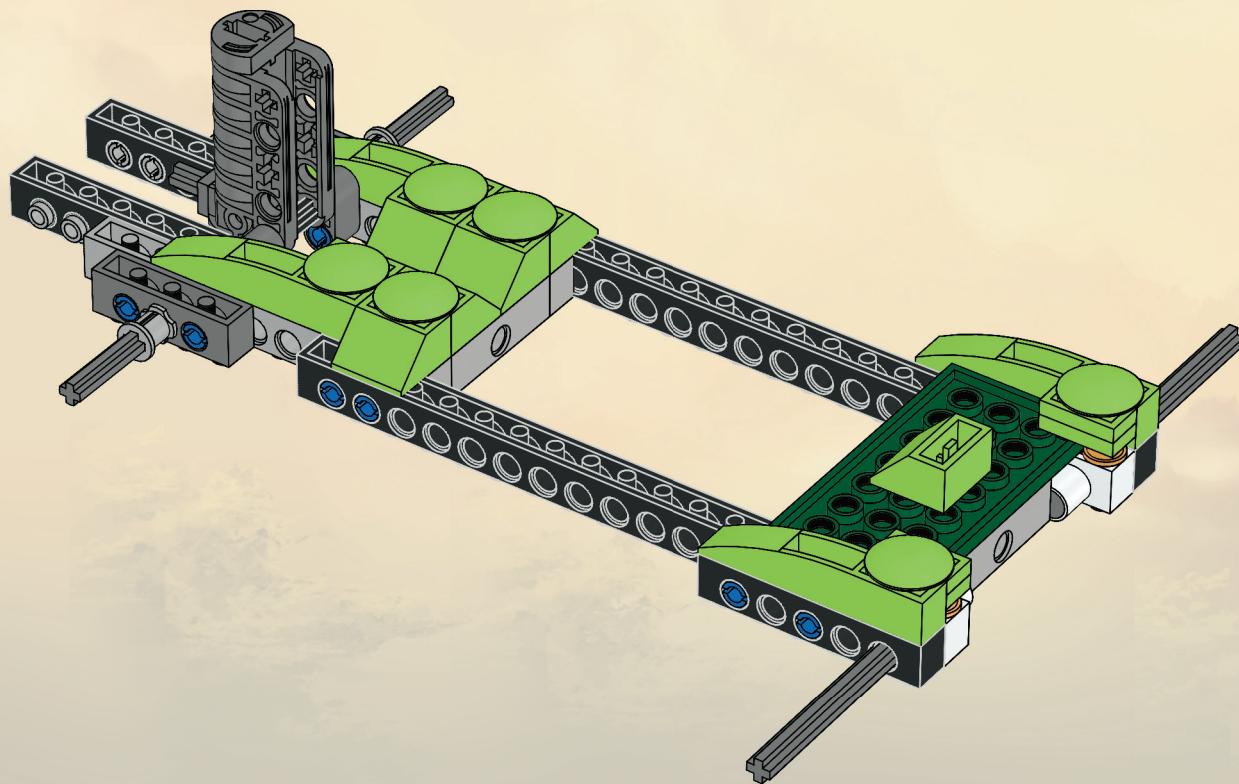

22



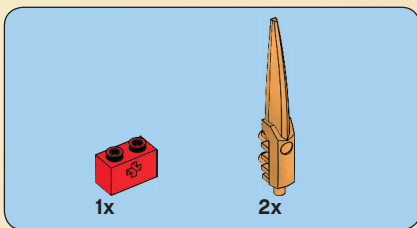

20

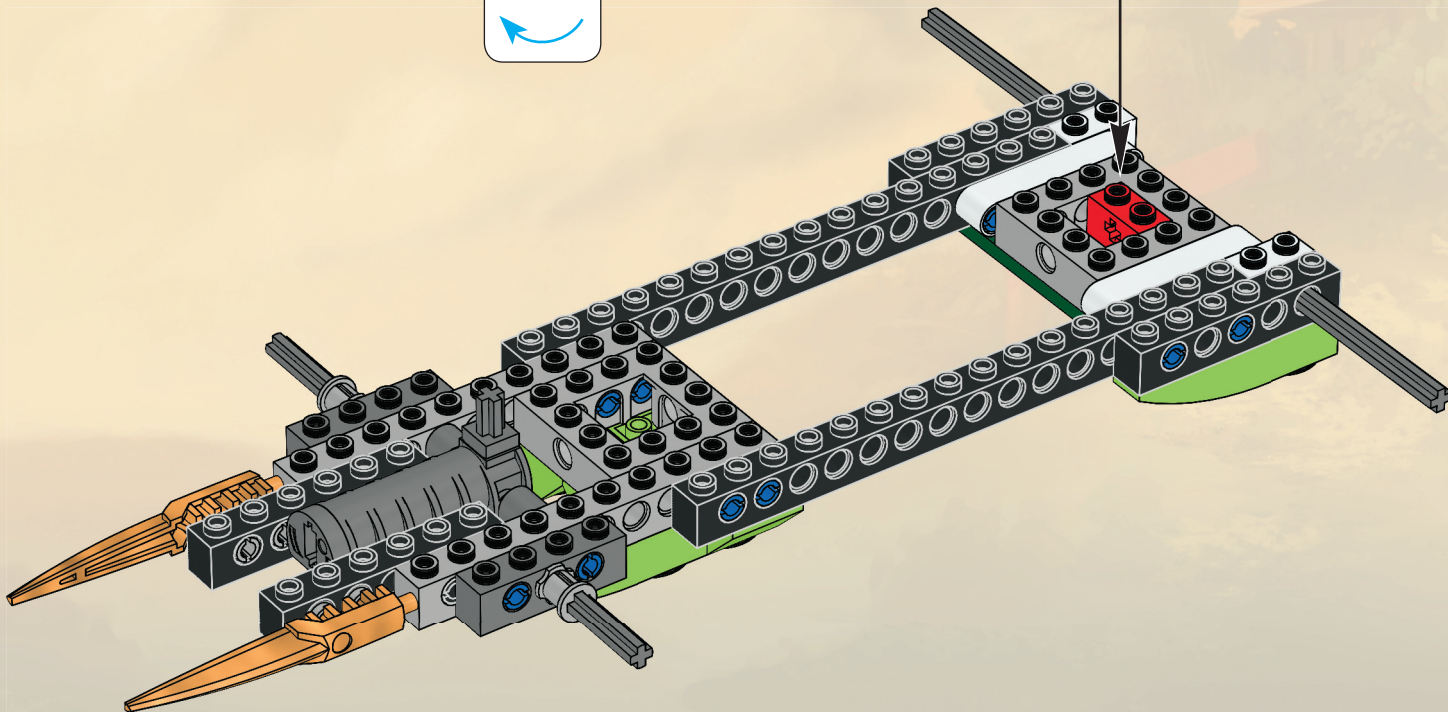
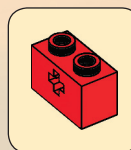
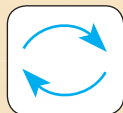

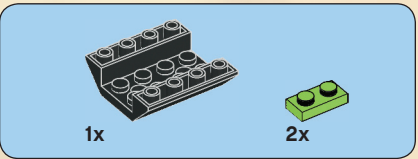
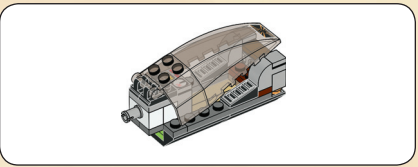
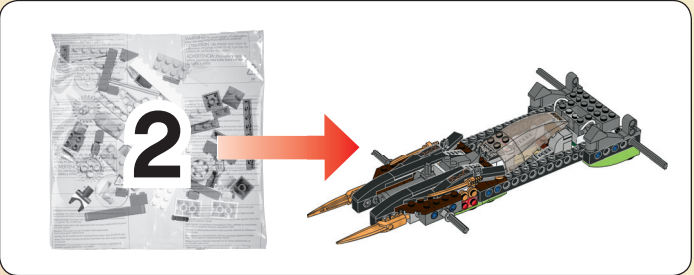

1

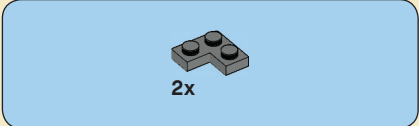
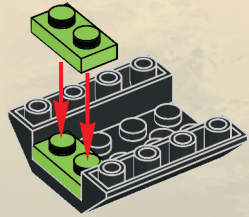

2

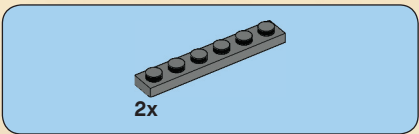
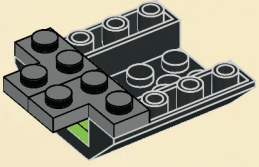

3

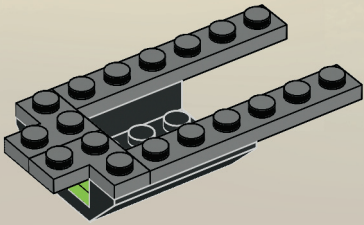

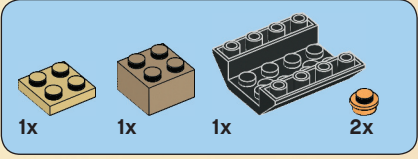

4

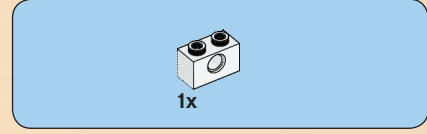
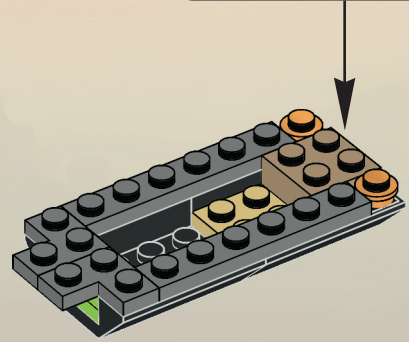
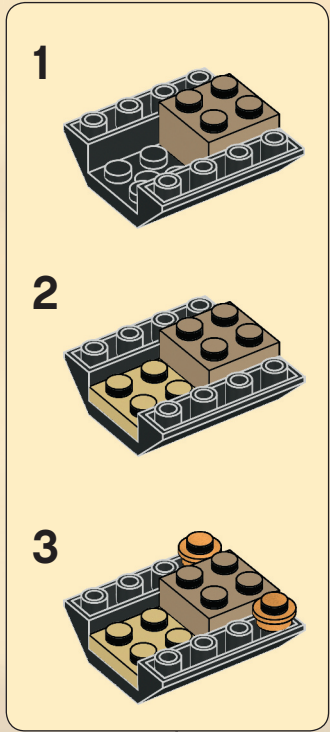

5

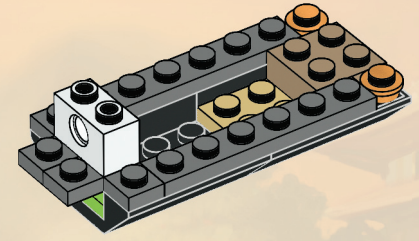

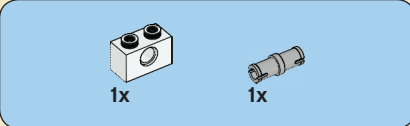

6

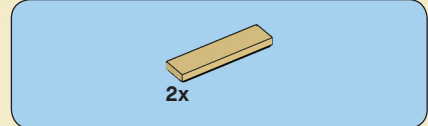
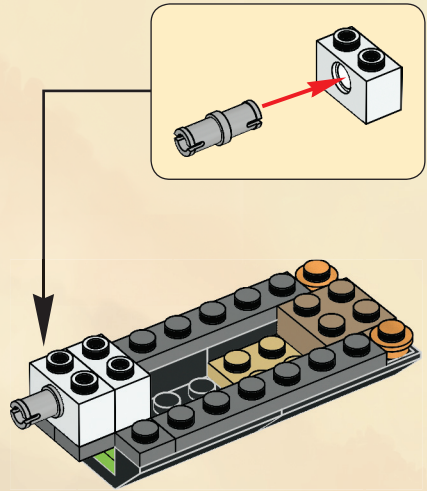

8

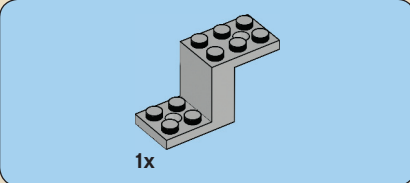
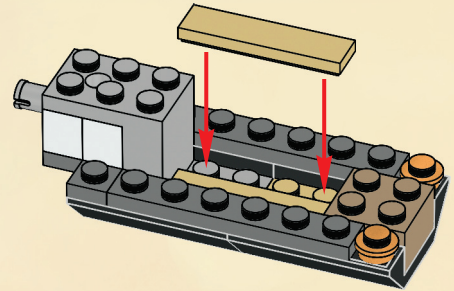

7

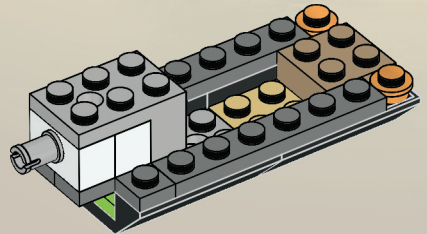

9

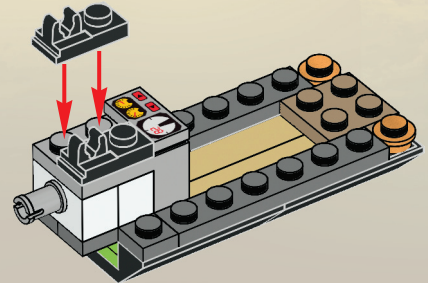

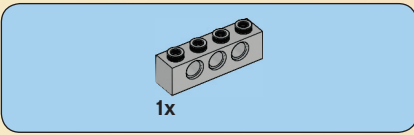

10

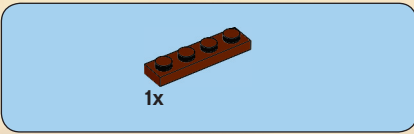
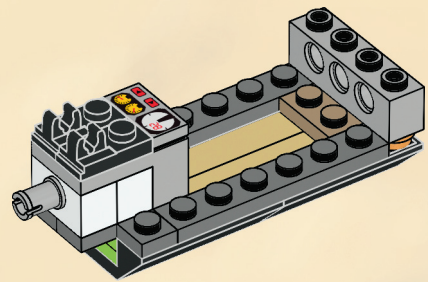

11

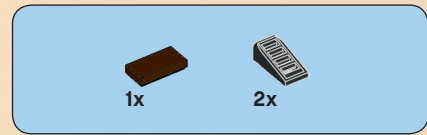
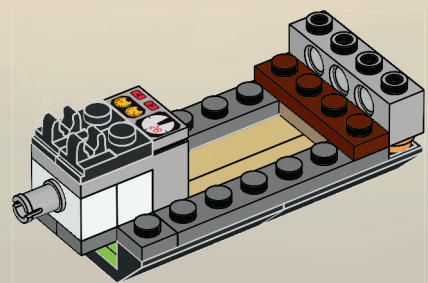

12

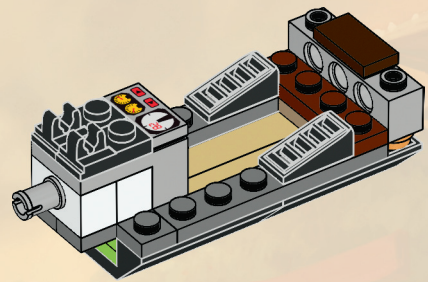



2x

13

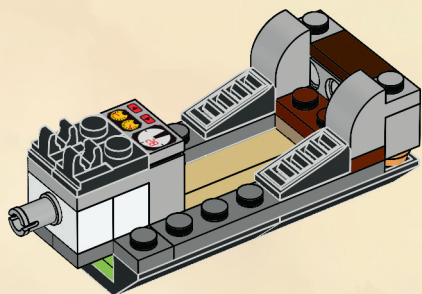

2x

14

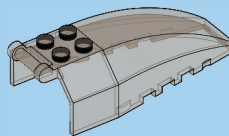
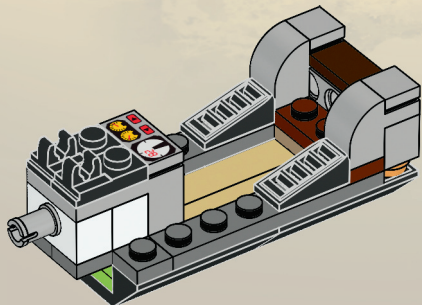

1x

15

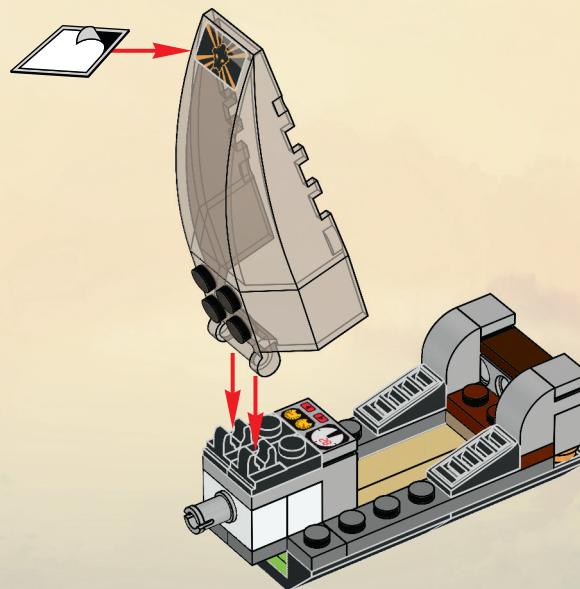



21

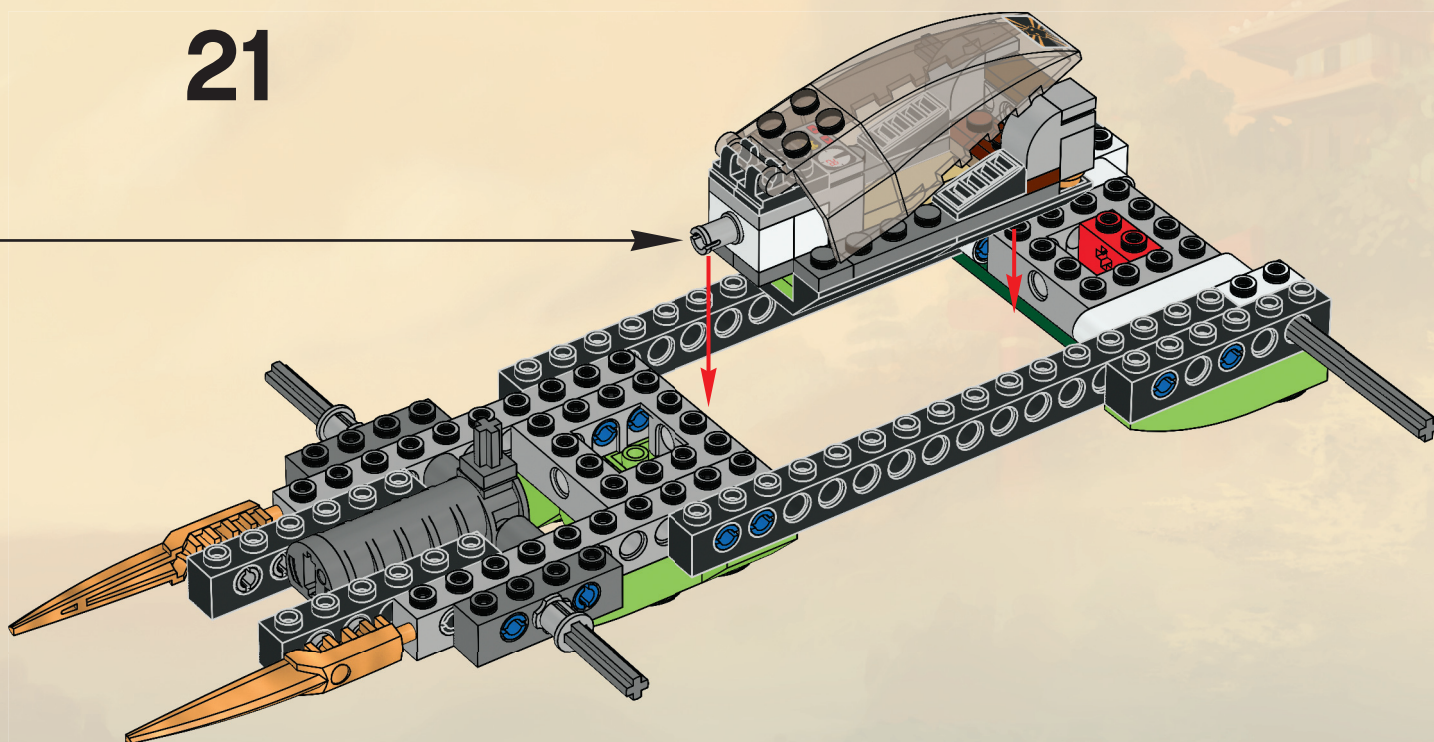



22

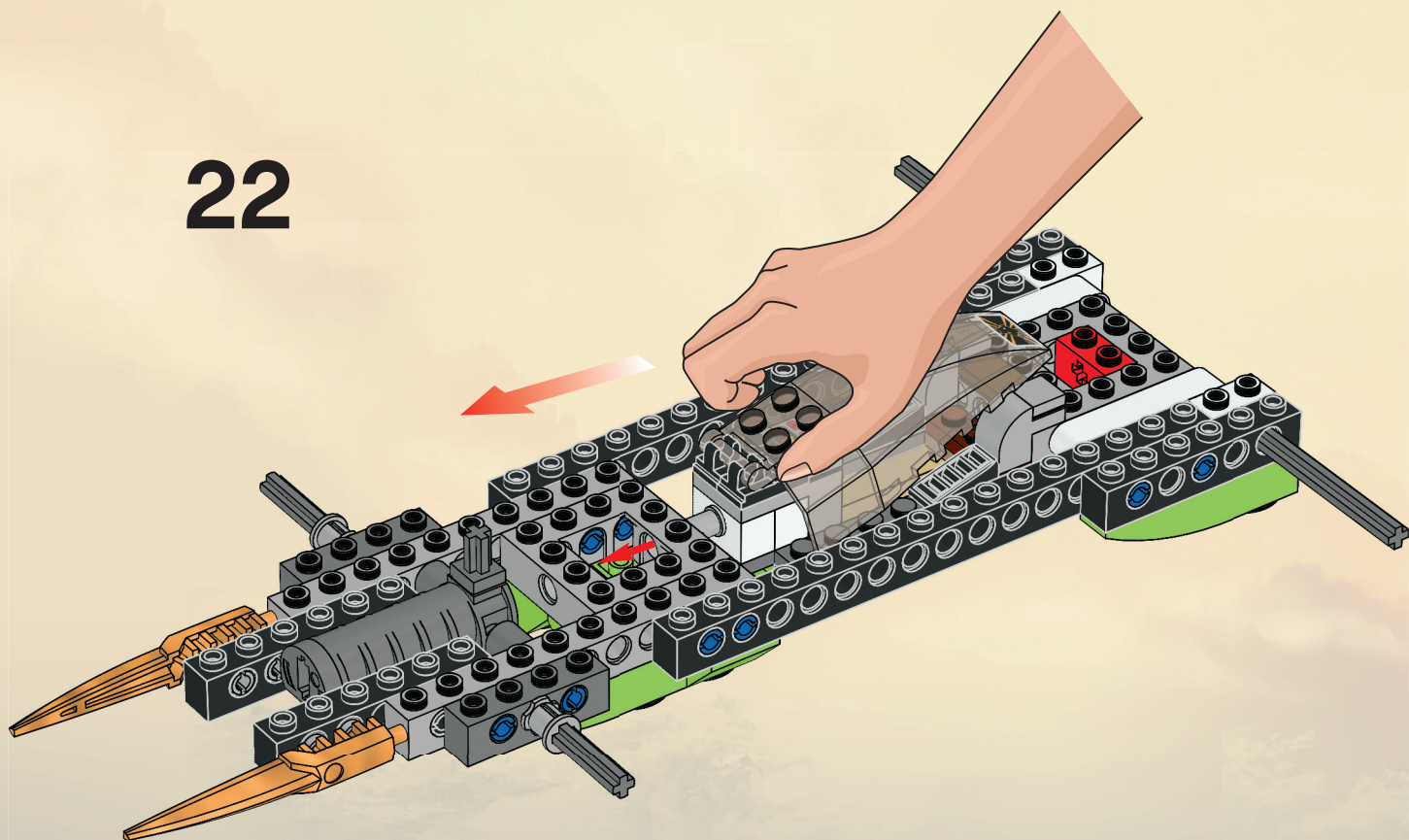

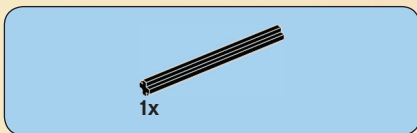

23

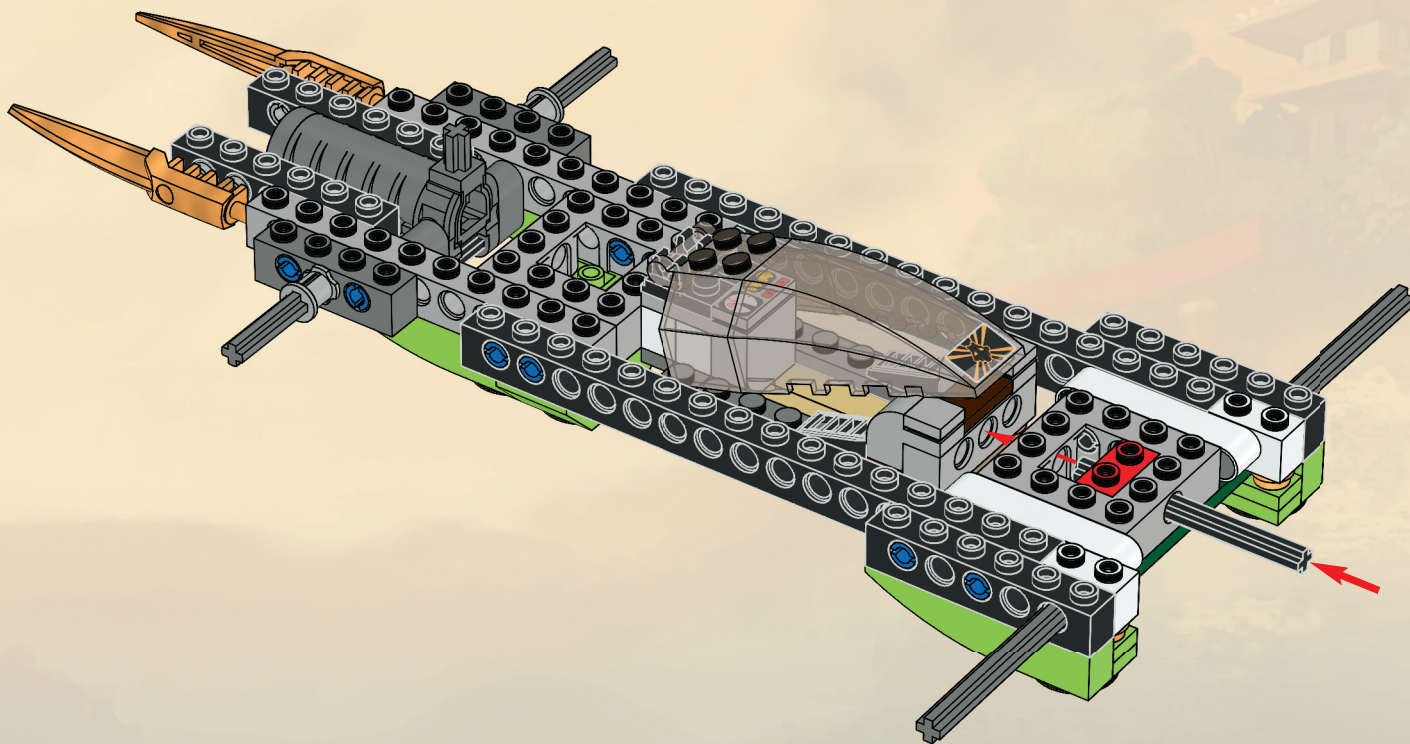

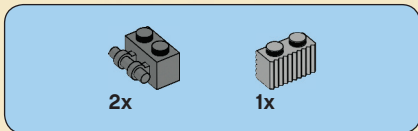

24

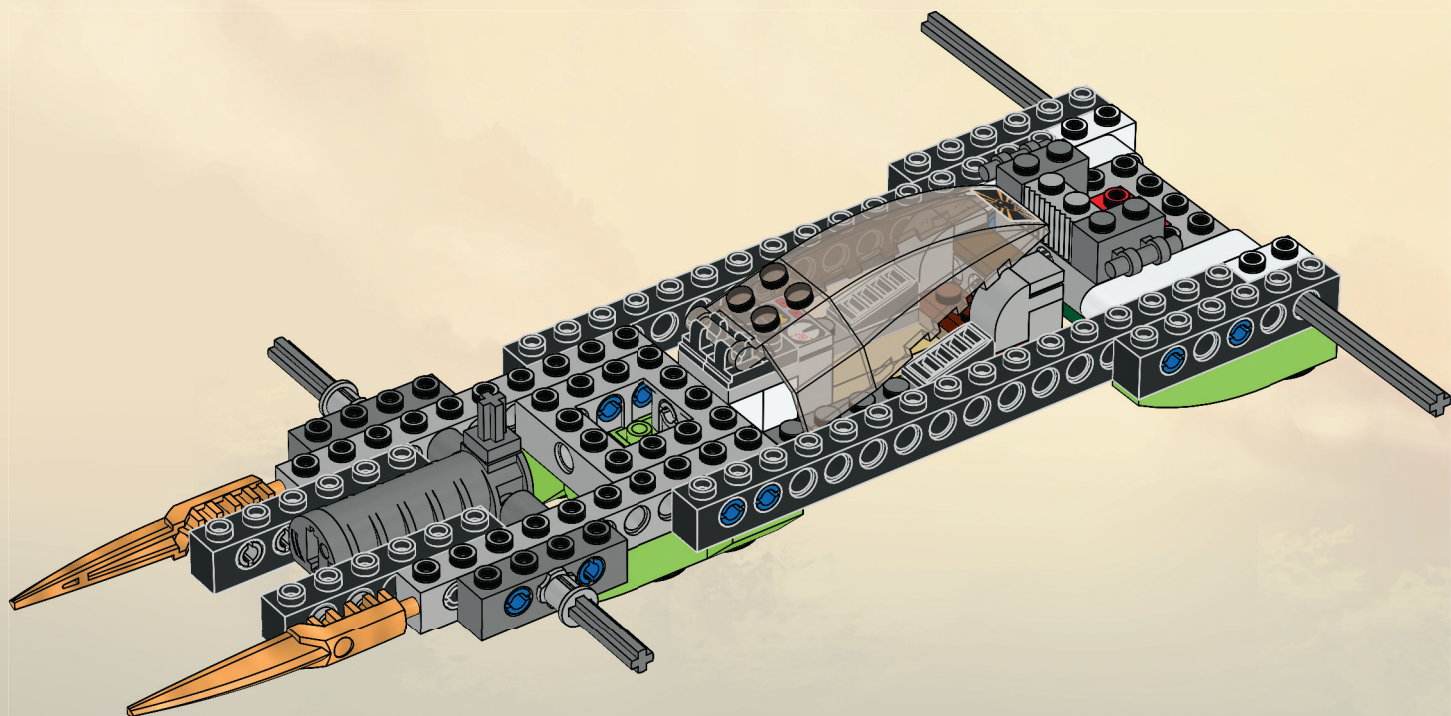

32



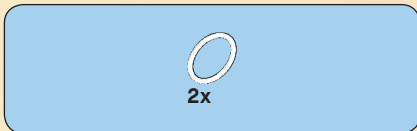

25

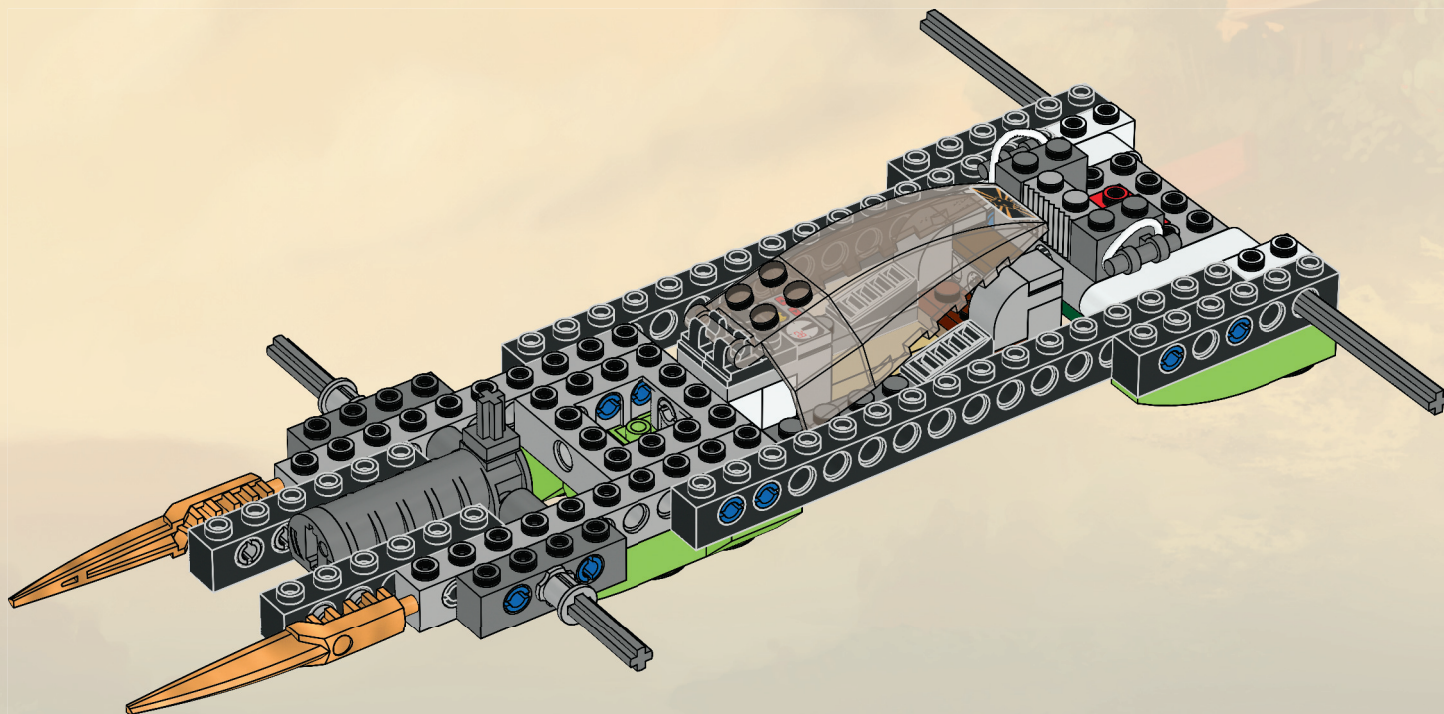

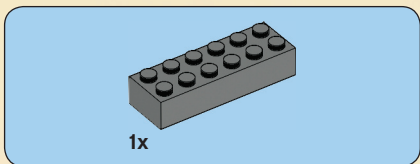

26

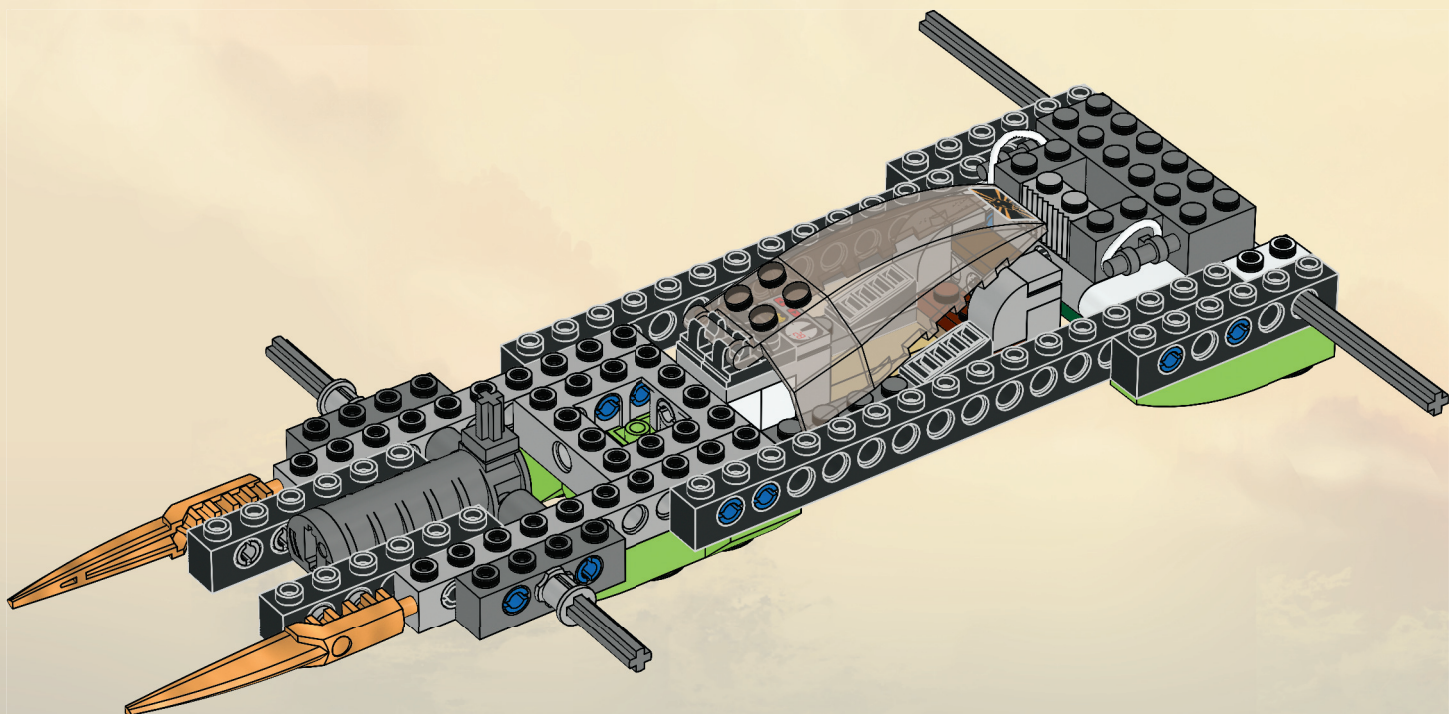

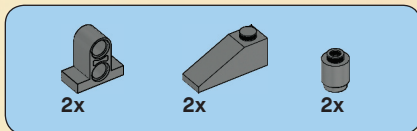

27

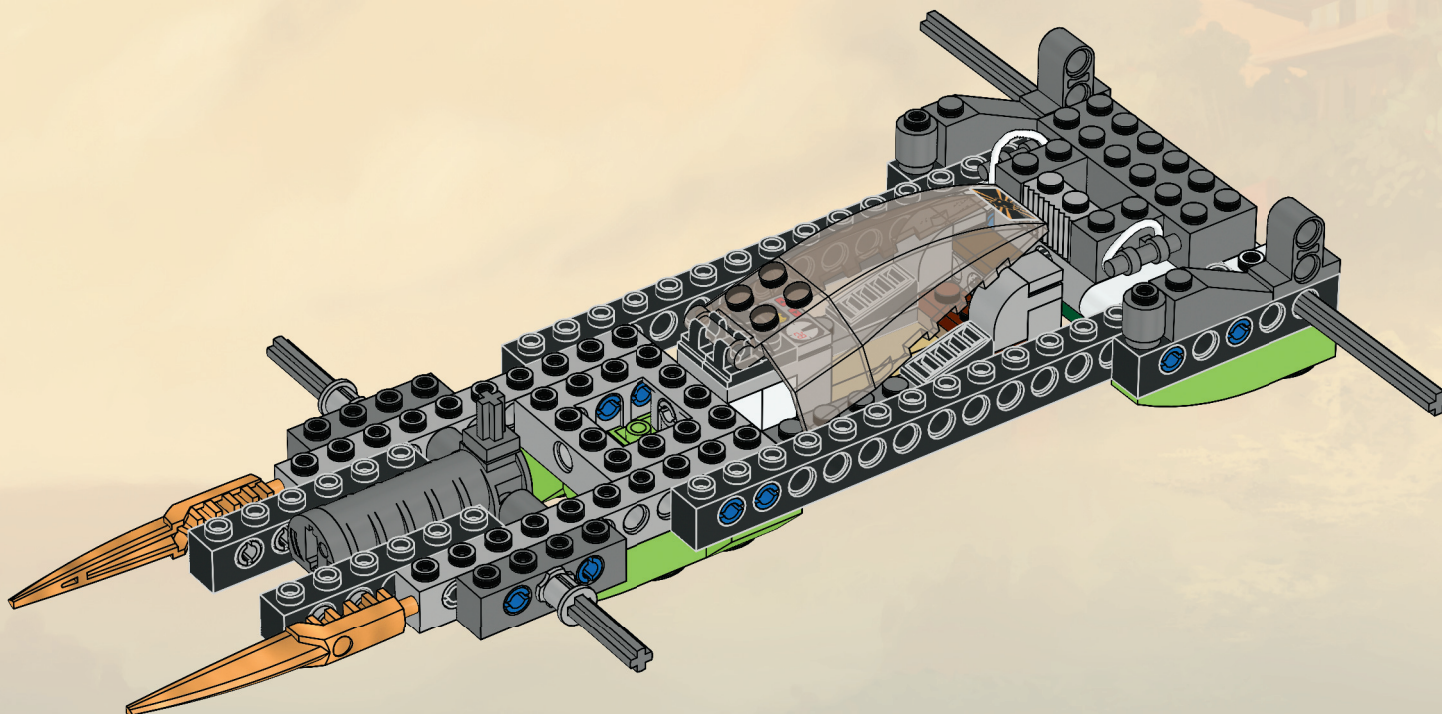

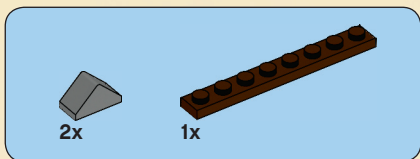

28

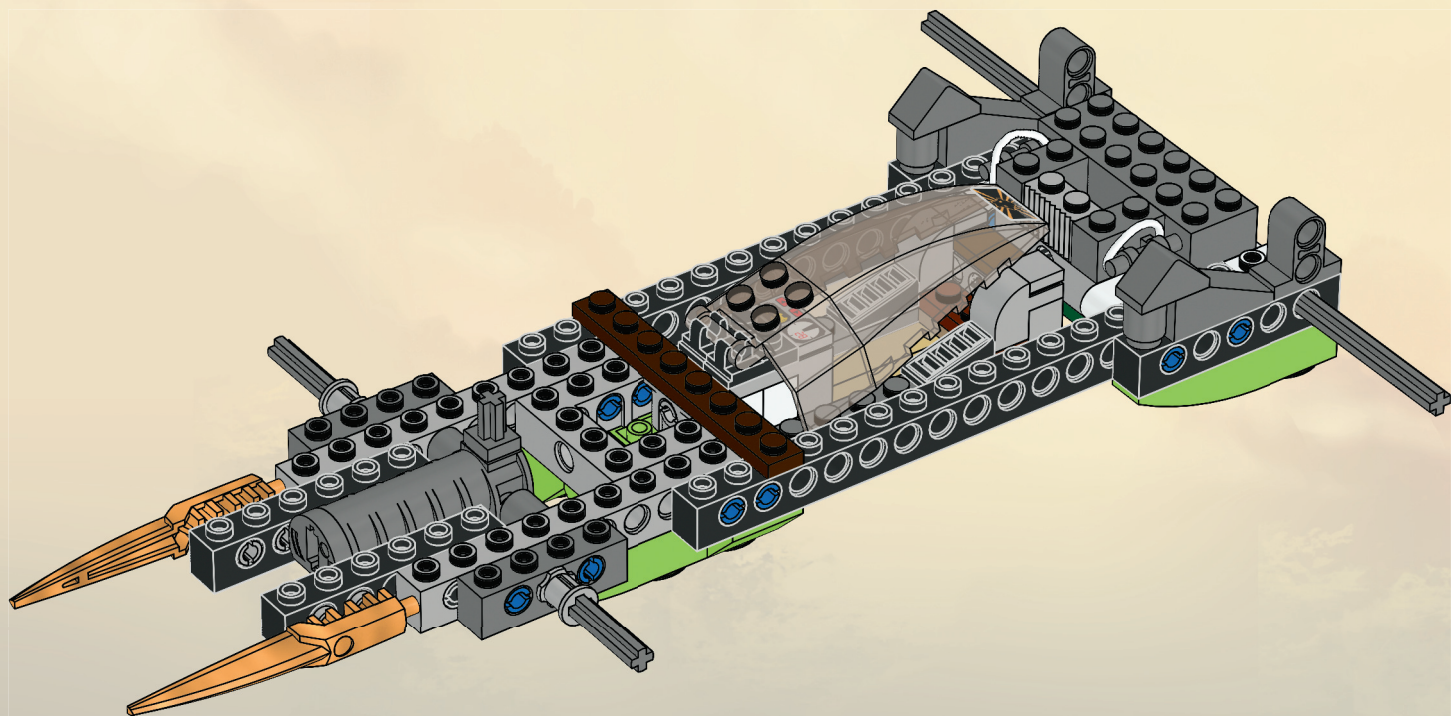



29

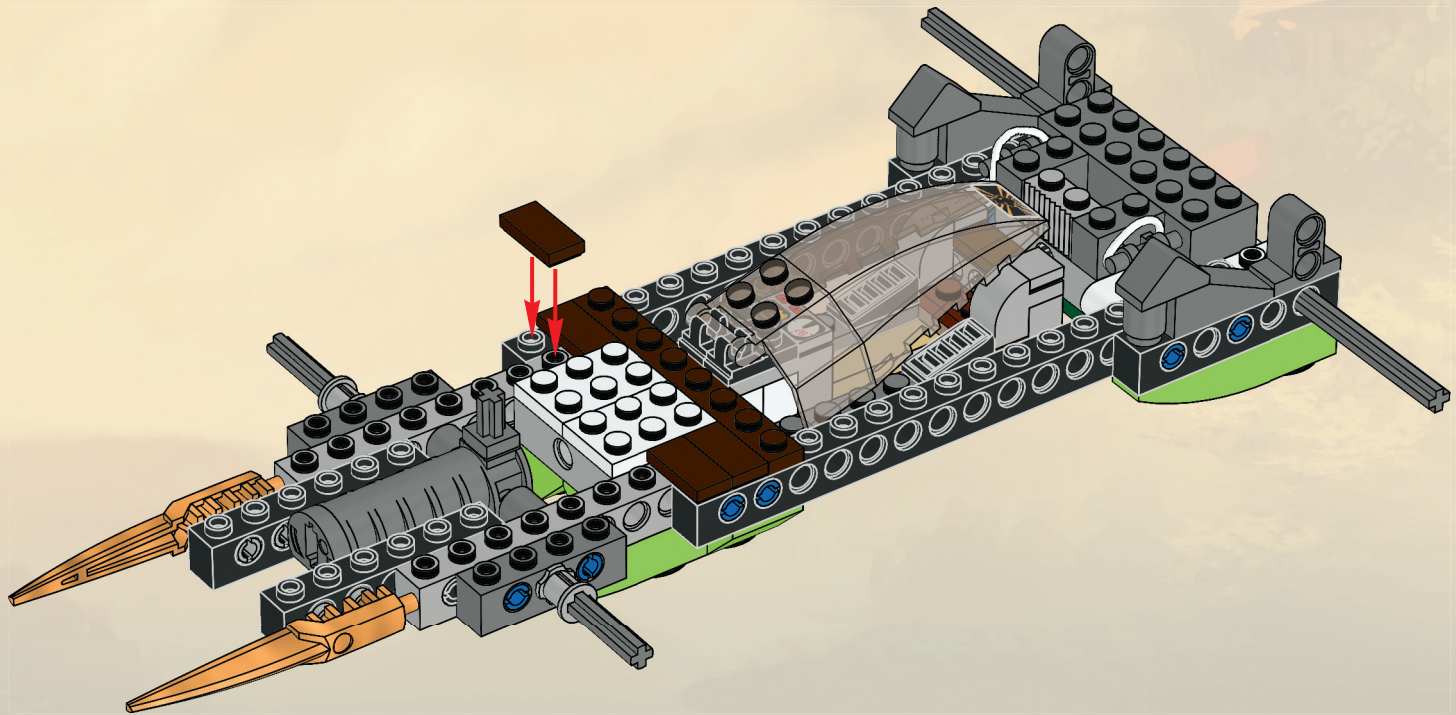



30

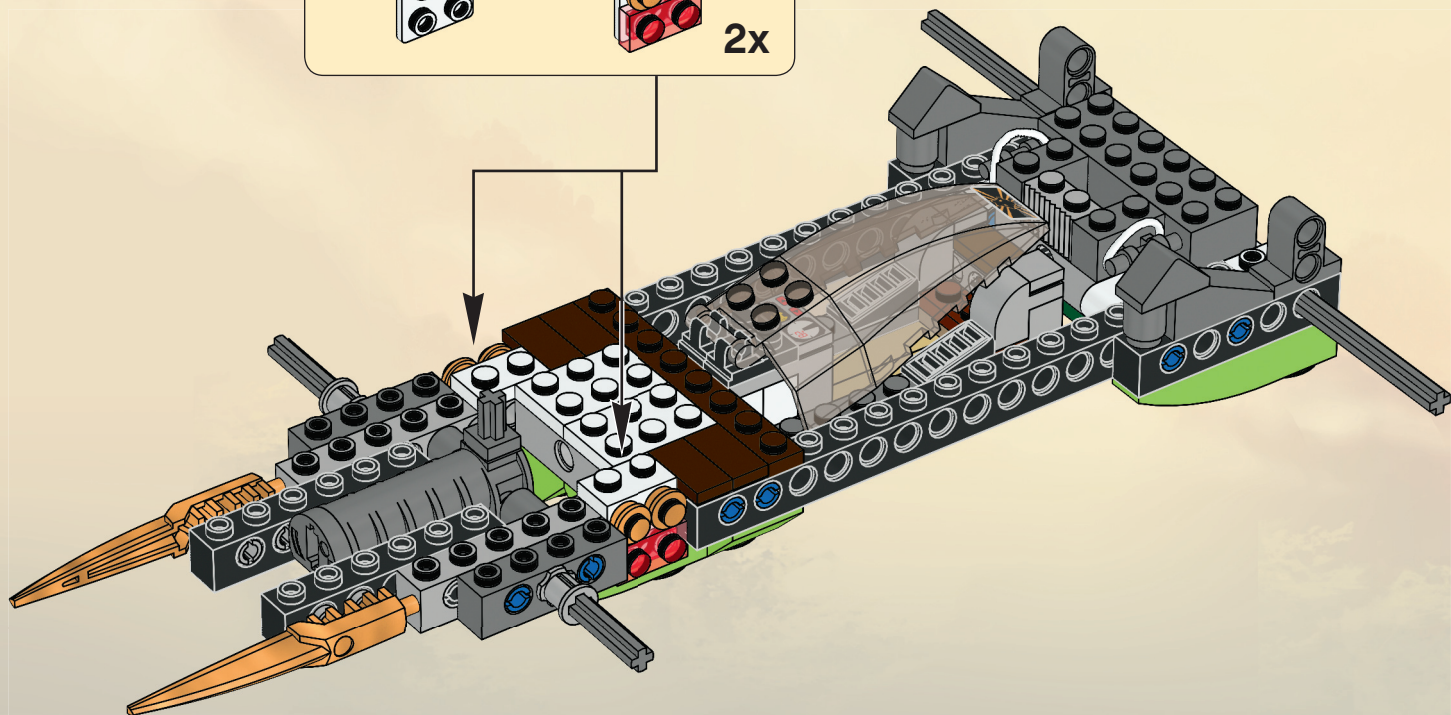
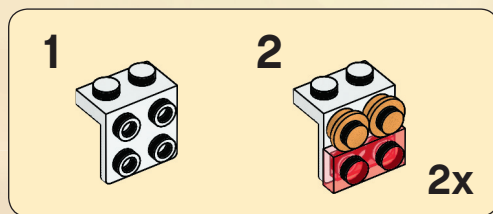

38





31

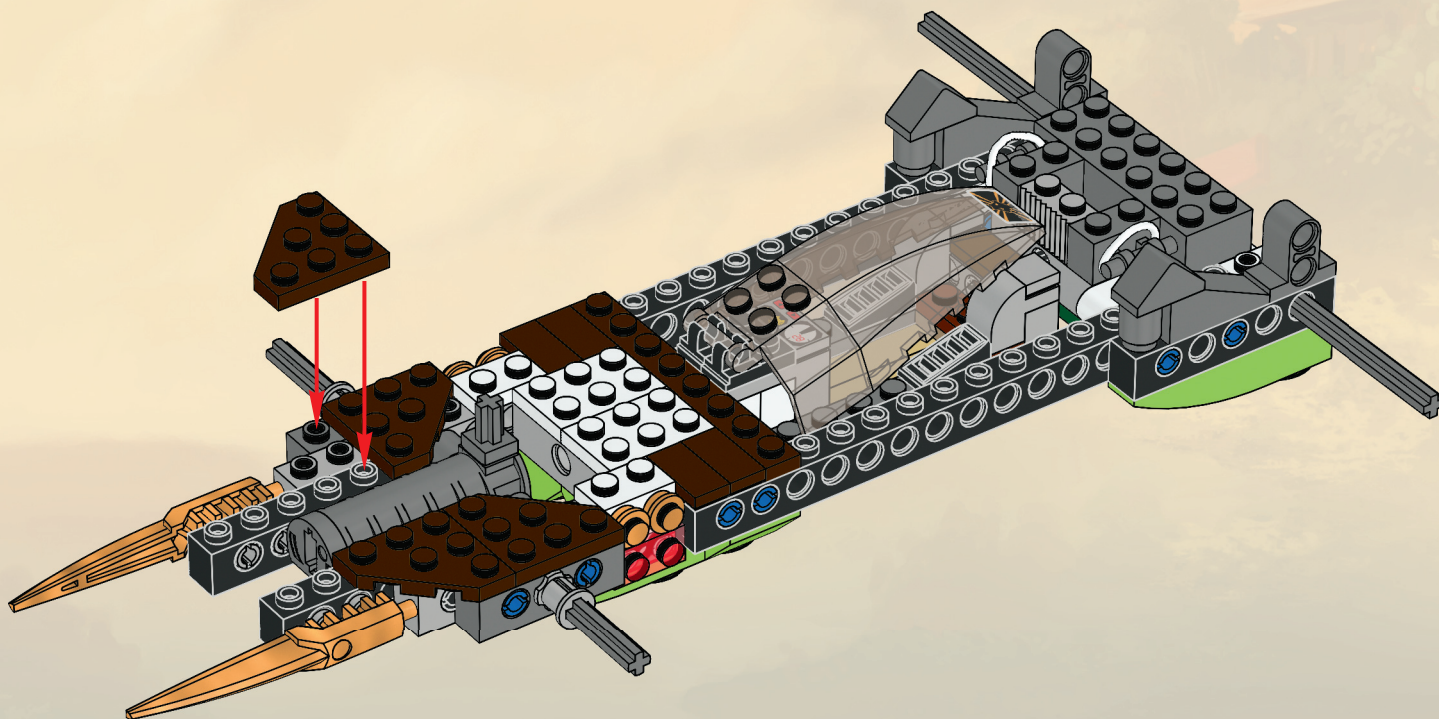



2x

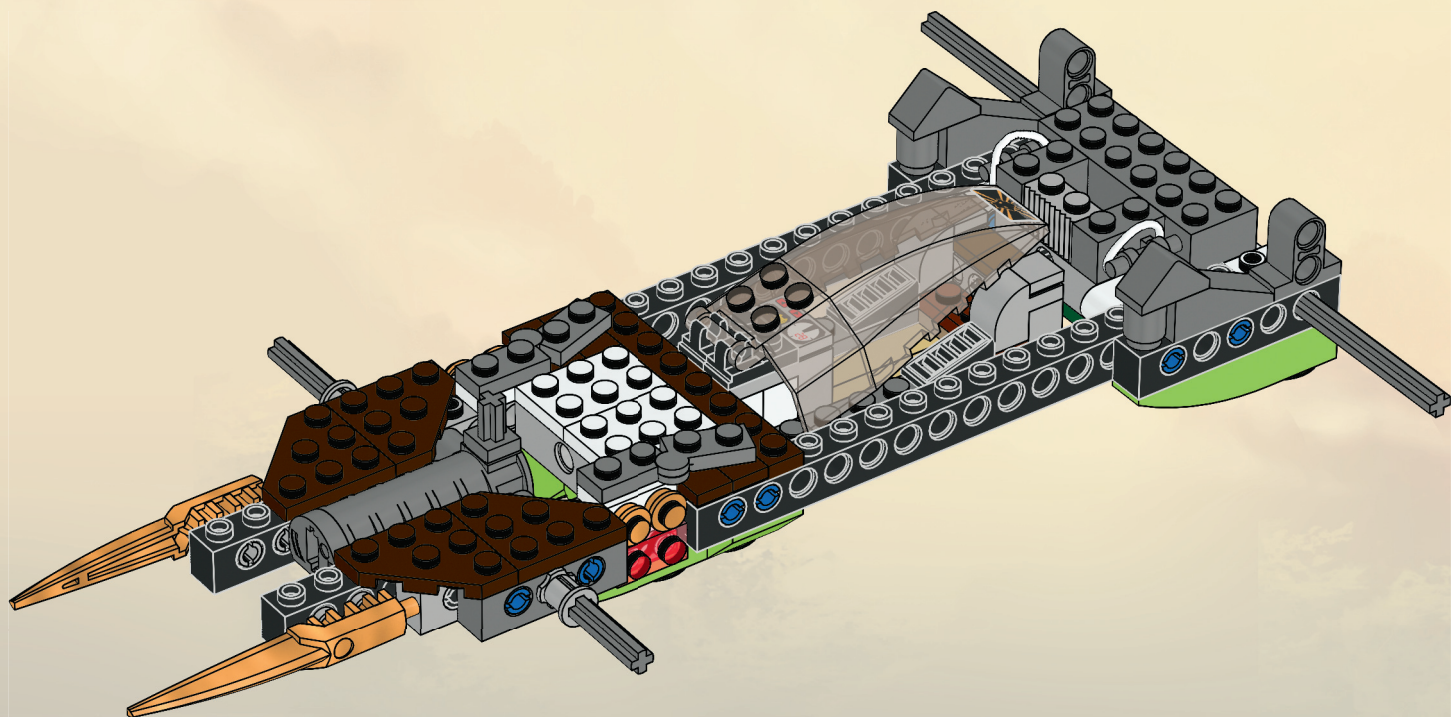

32



40





4x  2x 

33

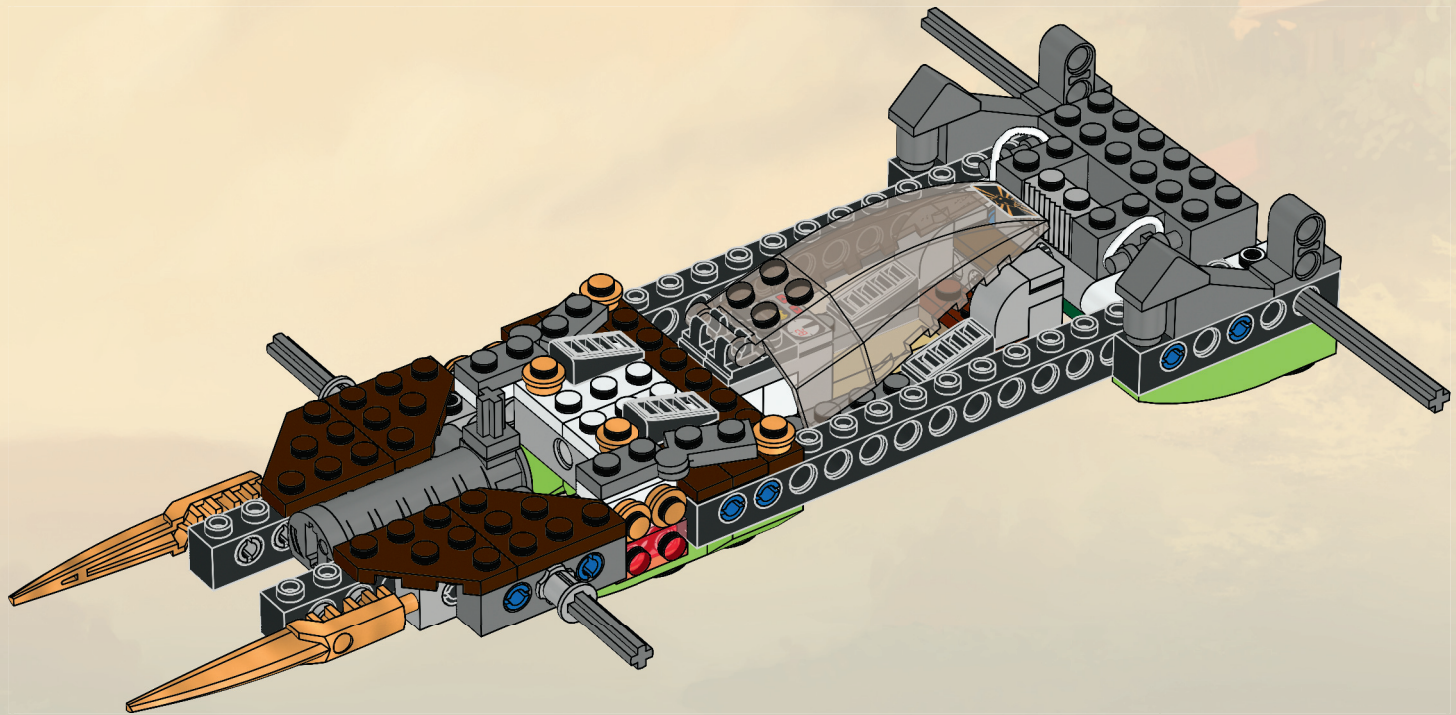



2x

34

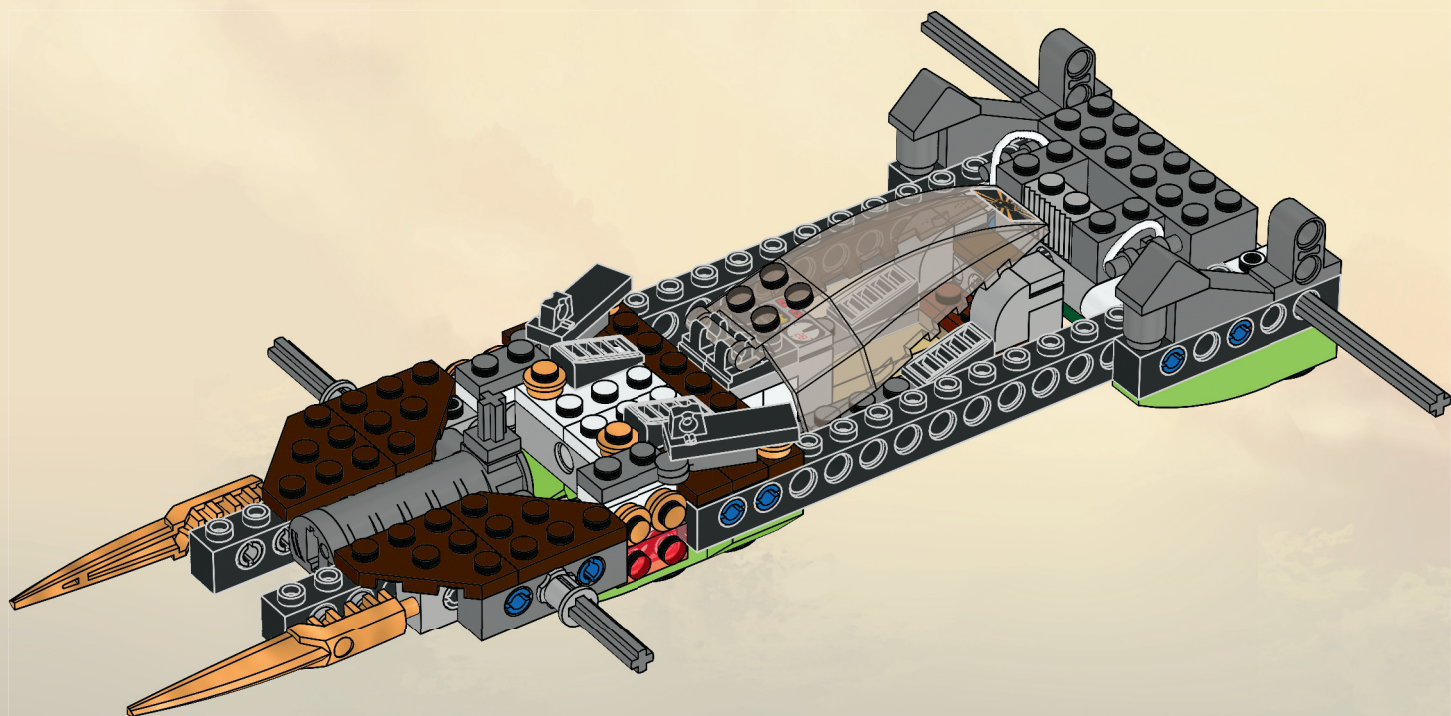

42





35

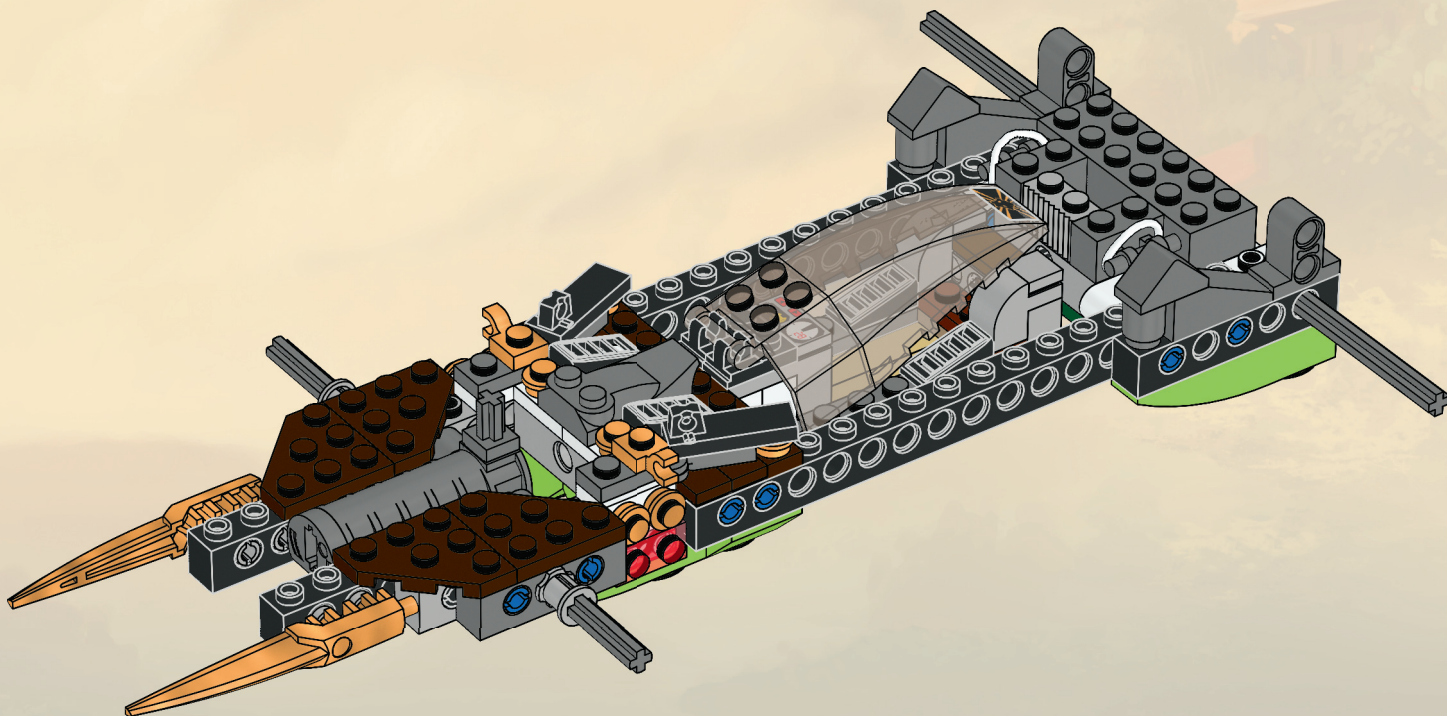



36

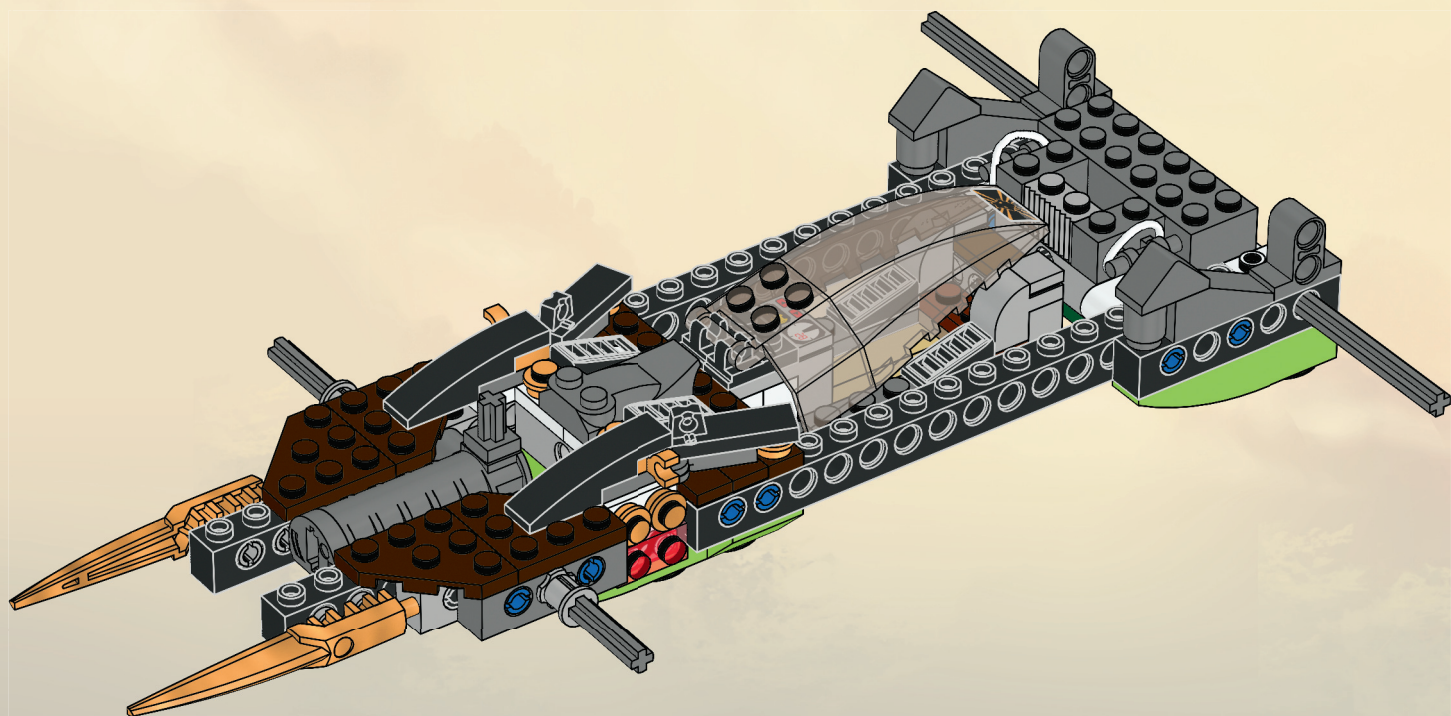

44



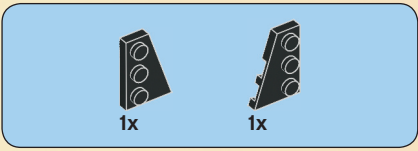

37

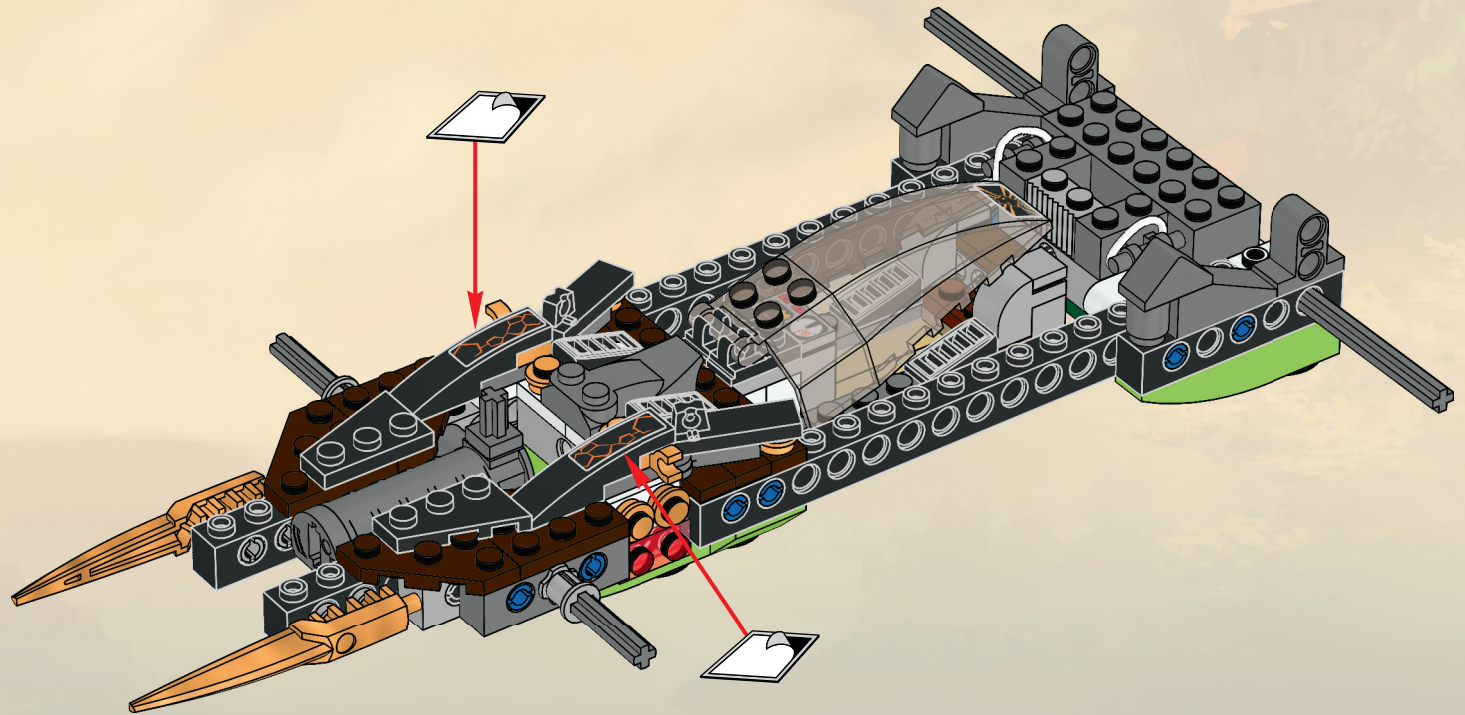

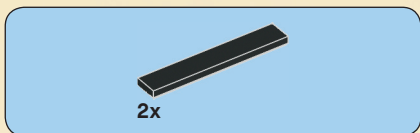

38

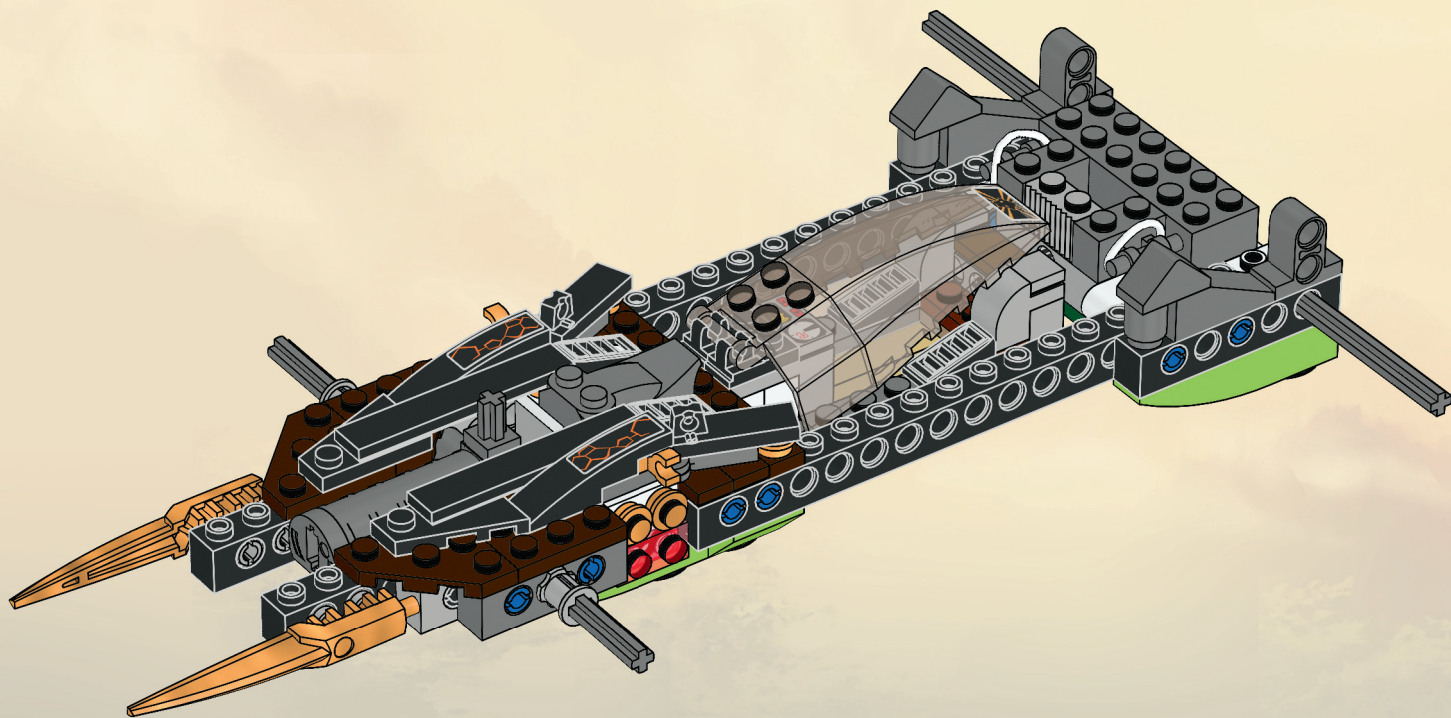

46



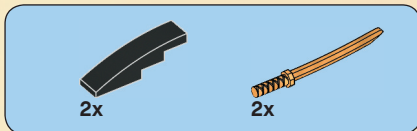

39

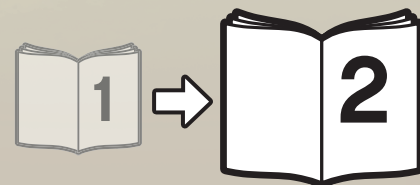
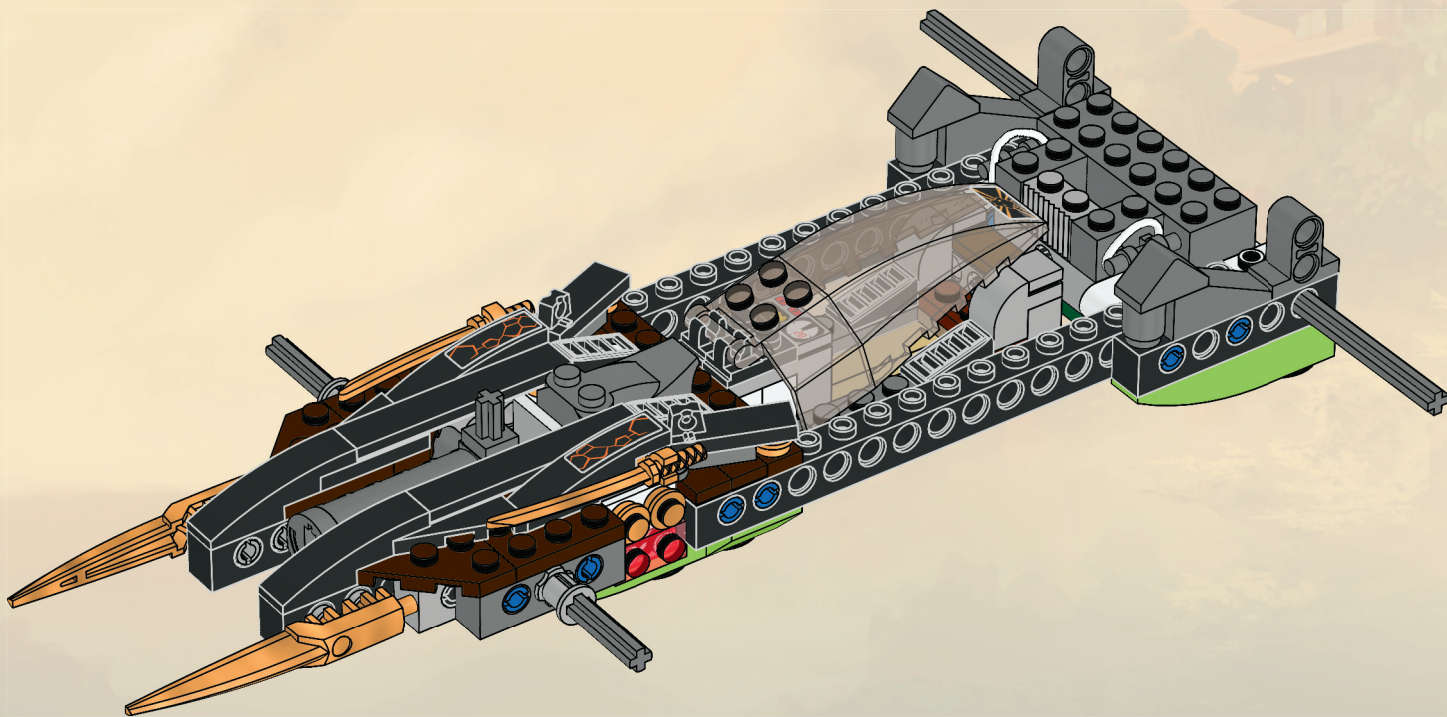



www.LEGOclub.com



LEGO® Club Email

LEGO club™

FREE! GRATIS! GRATUIT!



LEGO® Club Magazine

SIGN UP ONLINE!
www.LEGOclub.com

LEGO and the LEGO logo are trademarks of the LEGO Group. ©2012 The LEGO Group. 6002052



00800 5346 5555*



1-866-534-6258 • 1-877-518-5346

US & Canada only

Canada seulement

- * Freephone. Mobile charges may apply.
- * Numéro sans frais. Des frais peuvent s'appliquer avec les téléphones cellulaires.
- * Gebührenfrei, Kosten für Anrufe aus Mobilfunknetzen können abweichen.
- * Gratis telefoonnummer vanaf vaste lijn.
- * Det är et gratis nummer, når du ringer fra fasttelefon.
- * Det är gratis, när du ringer från en fast telefon.
- * Numéro sans frais. Des frais peuvent s'appliquer avec les téléphones portables.

BI15