



**STAR
WAR**

TM



9515





2x



4x

68

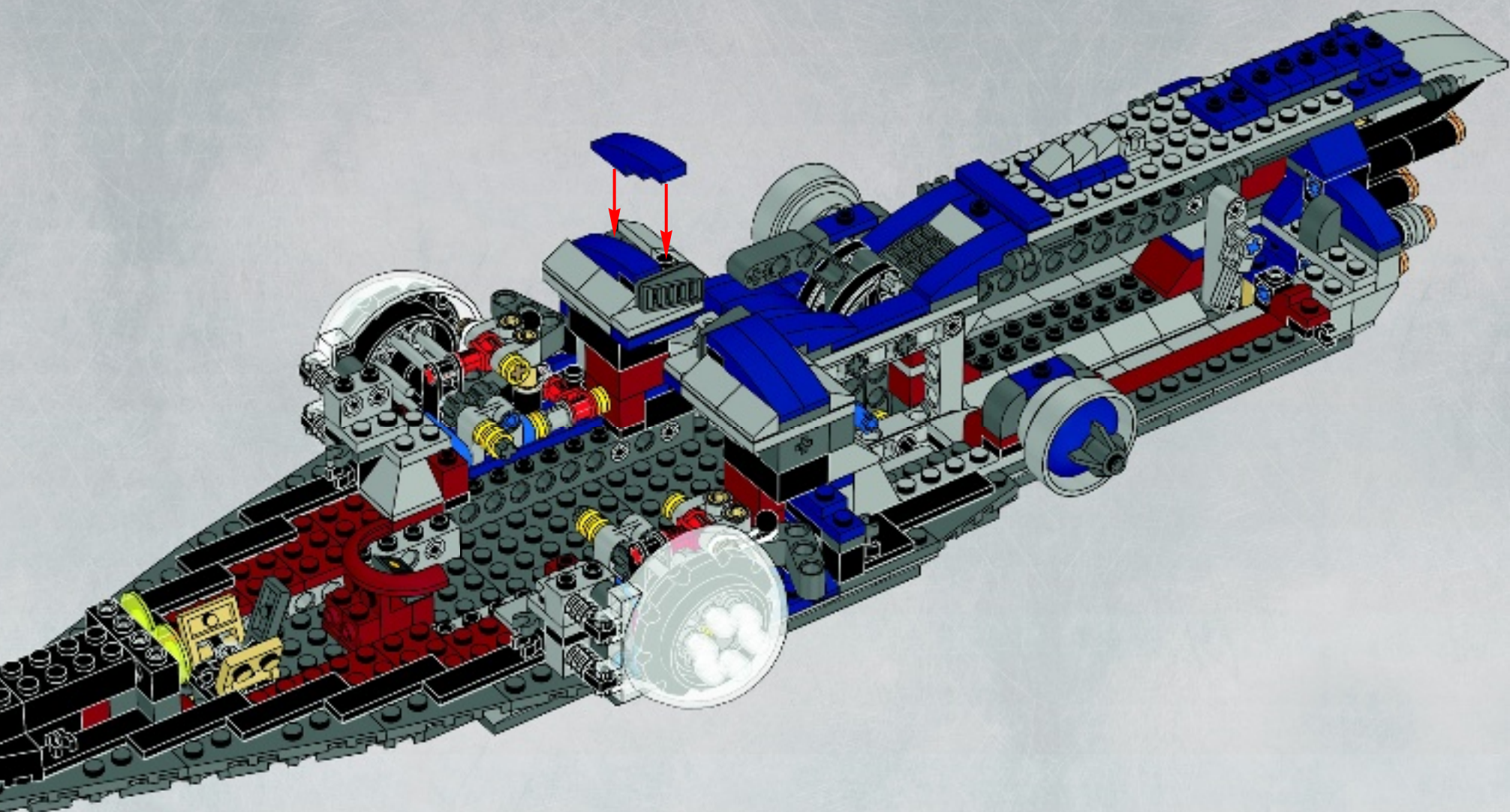

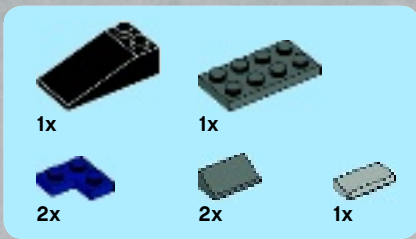

69

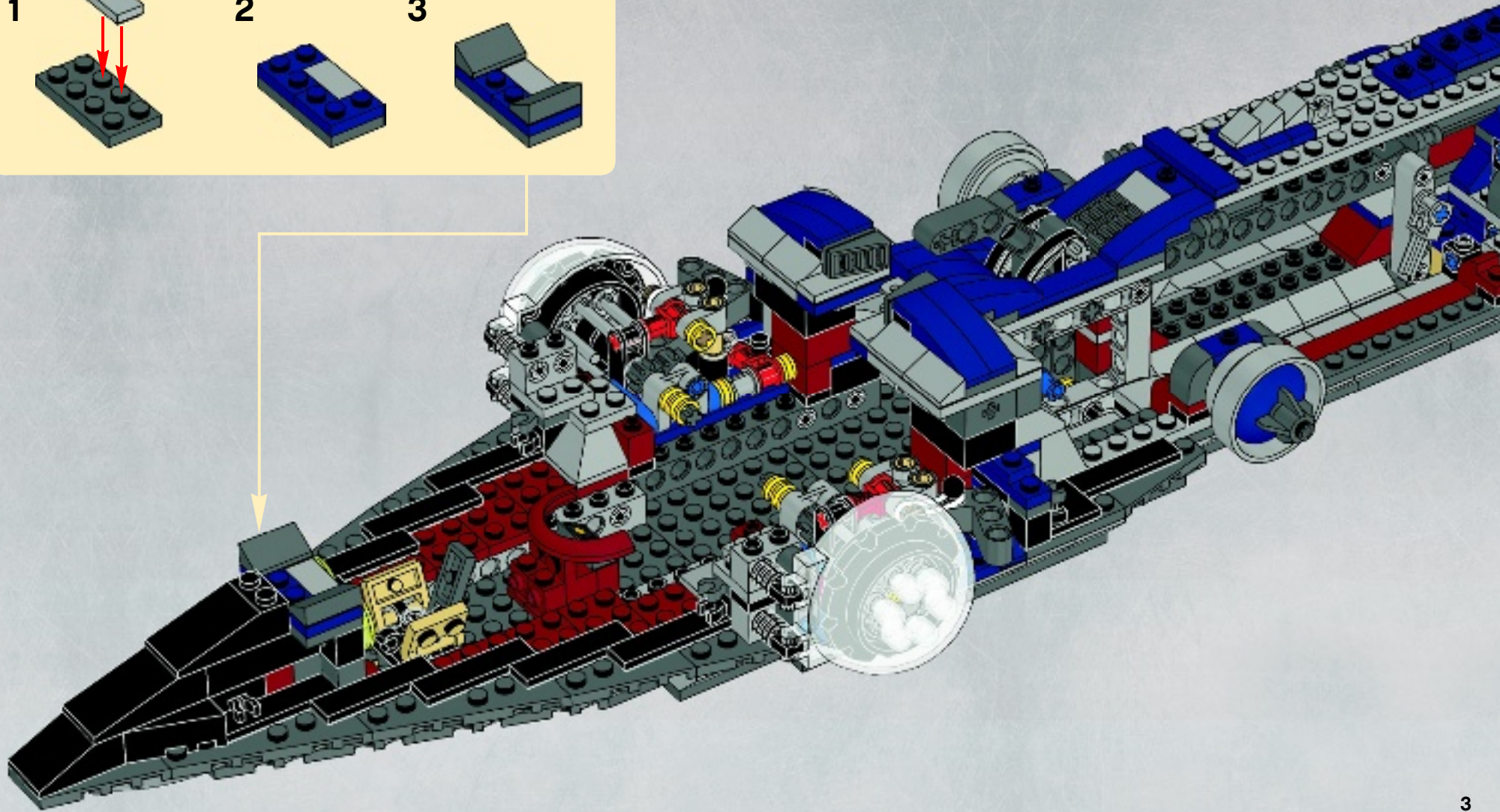
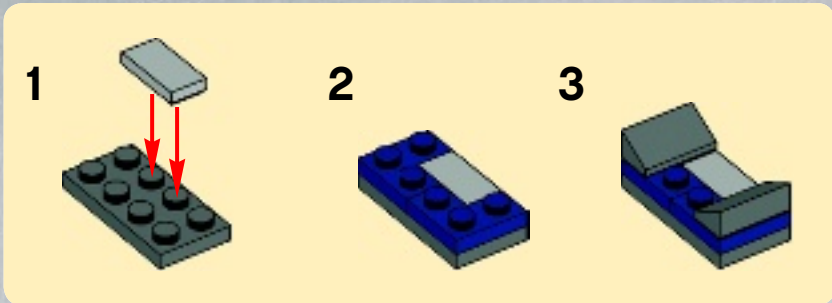

1x

2x

1x

70

1

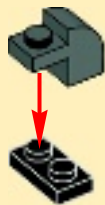

2

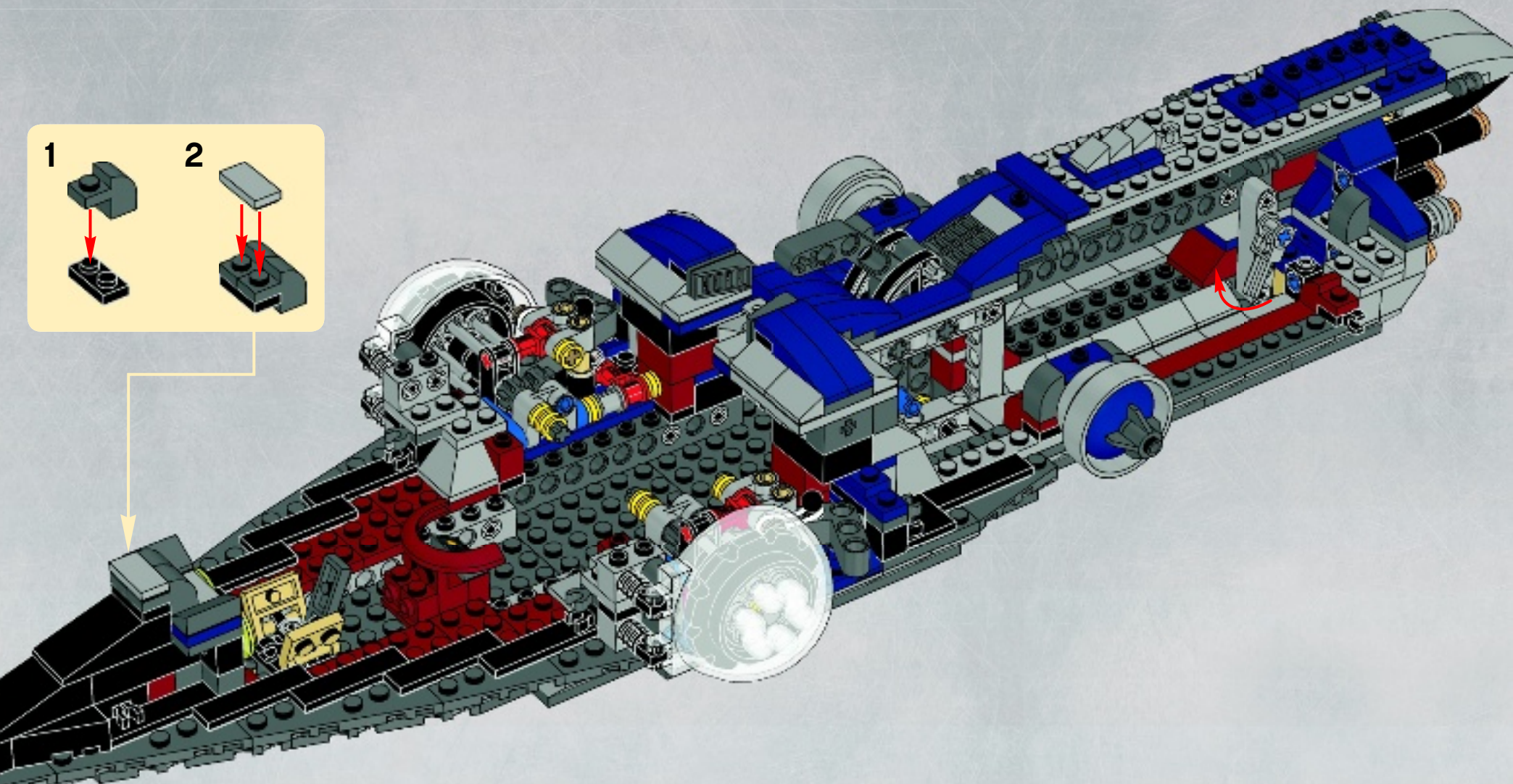
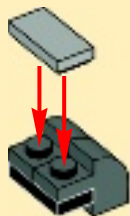



1

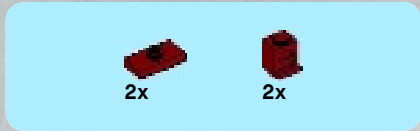
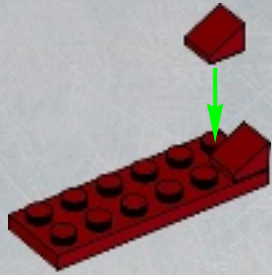

2

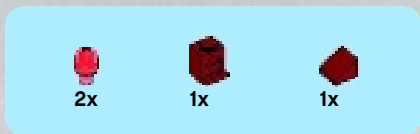
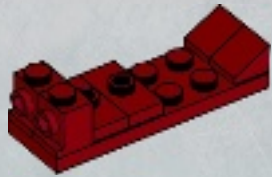

3

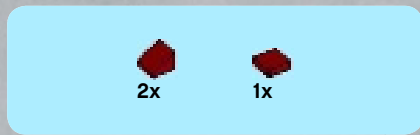
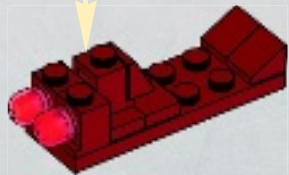

4

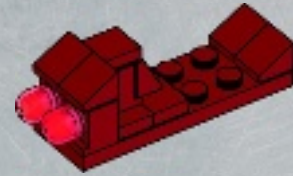

2x

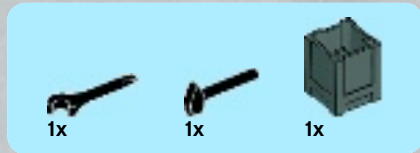

5

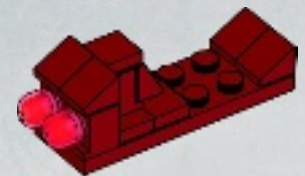
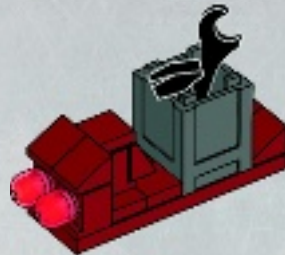

71

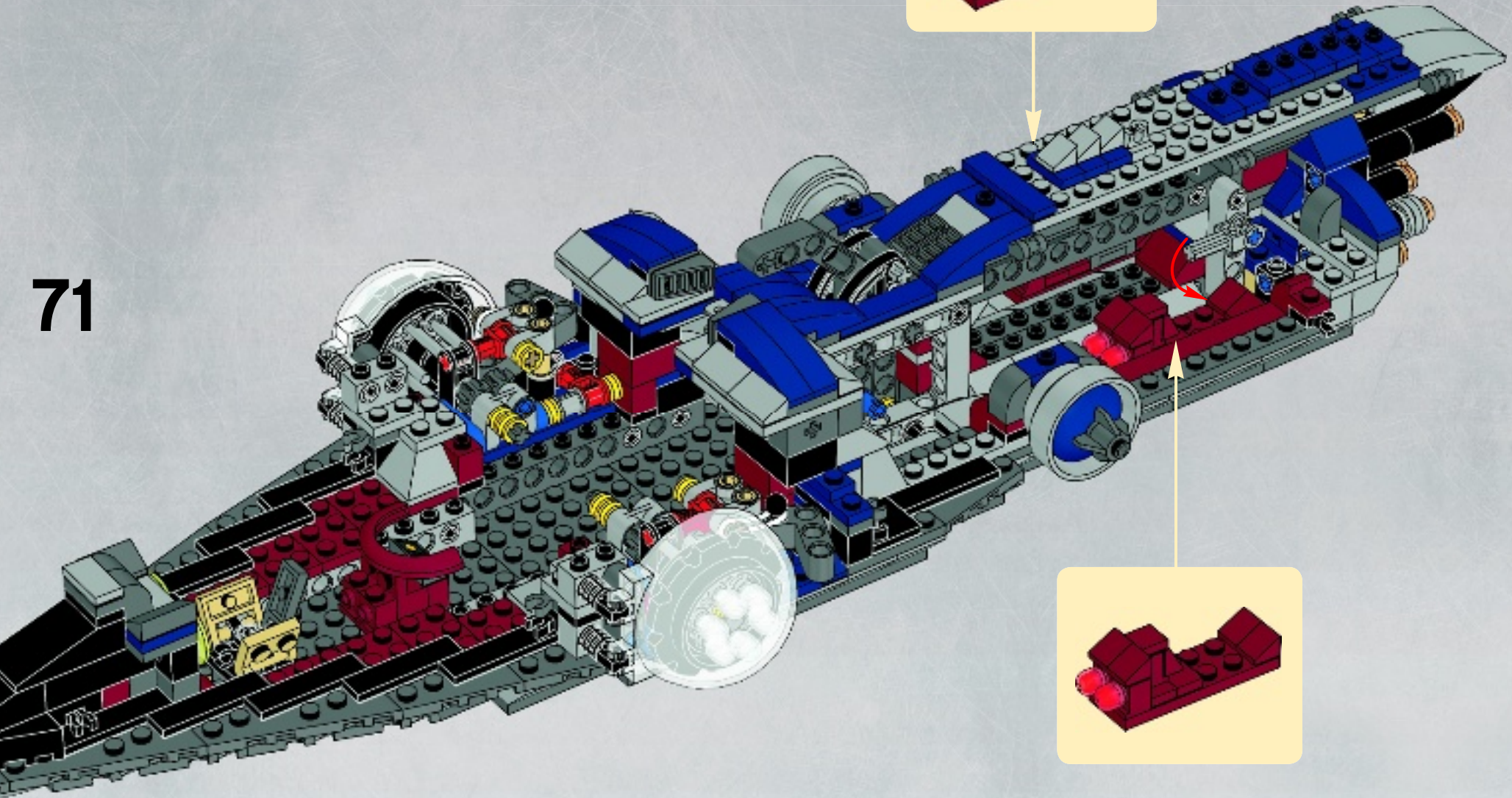

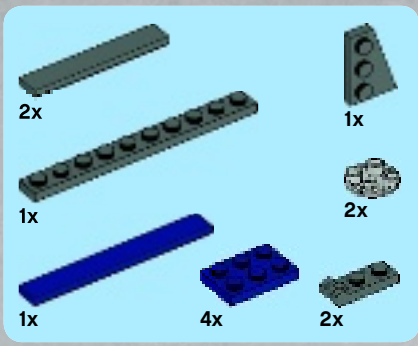

72

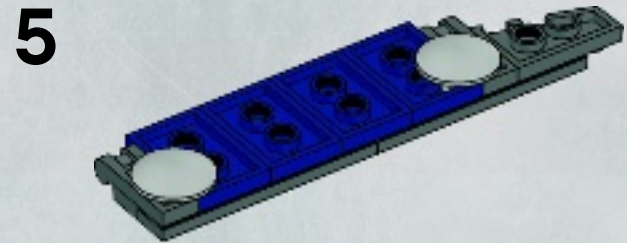
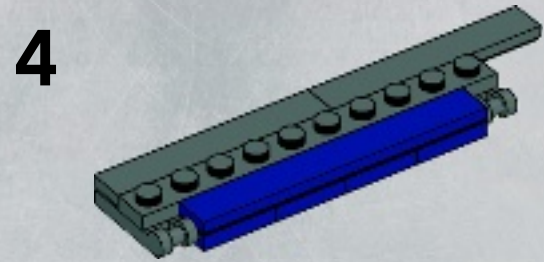
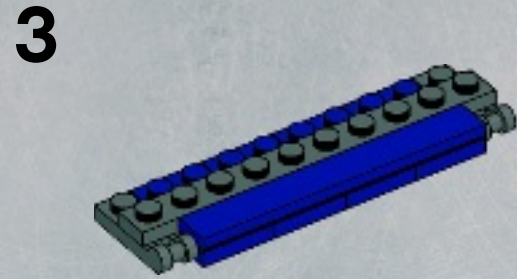
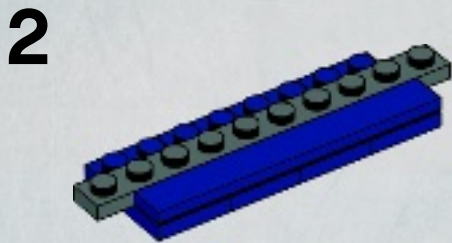
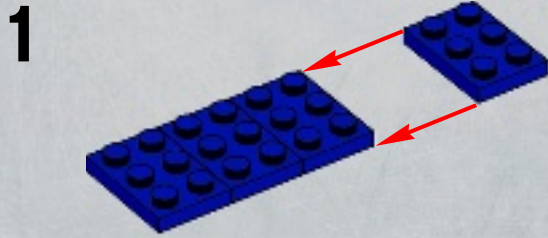

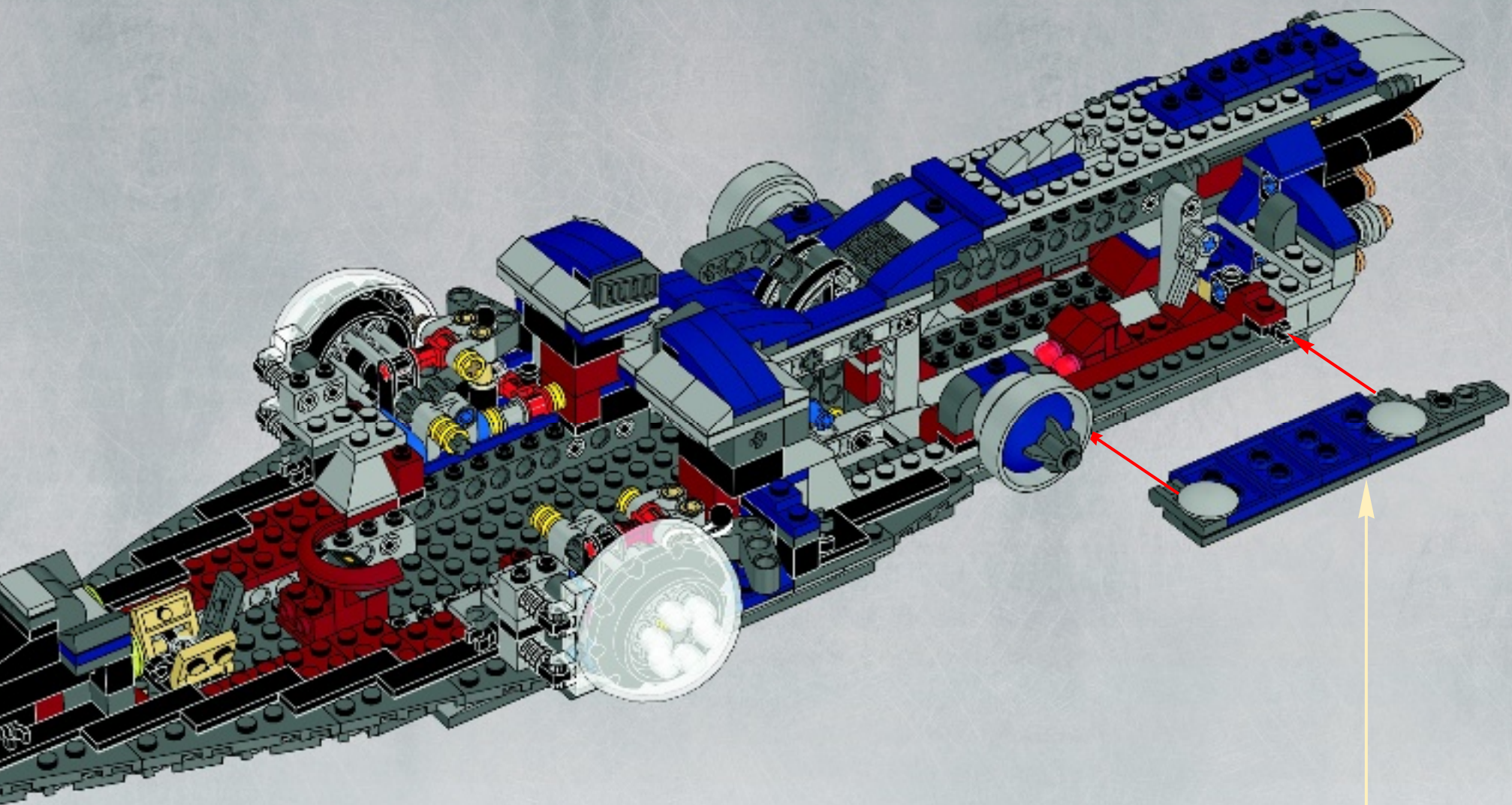

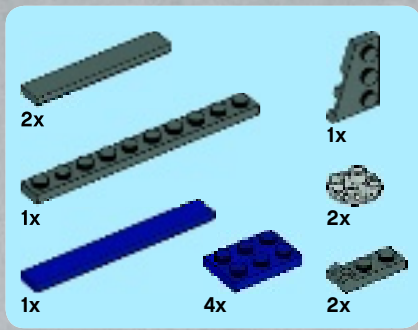

73

1

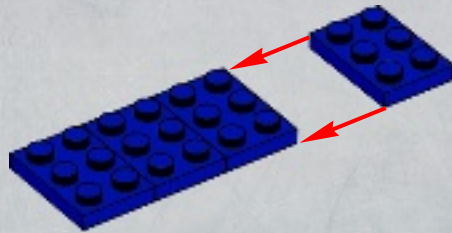

2

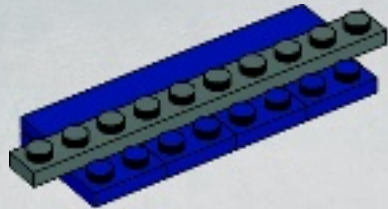

3

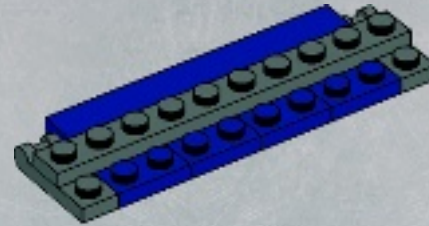

4

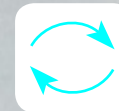
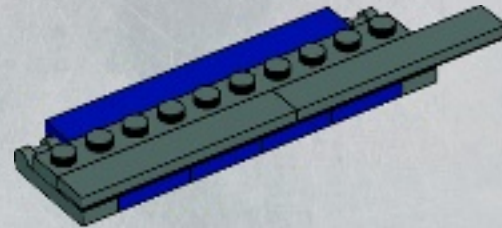

5



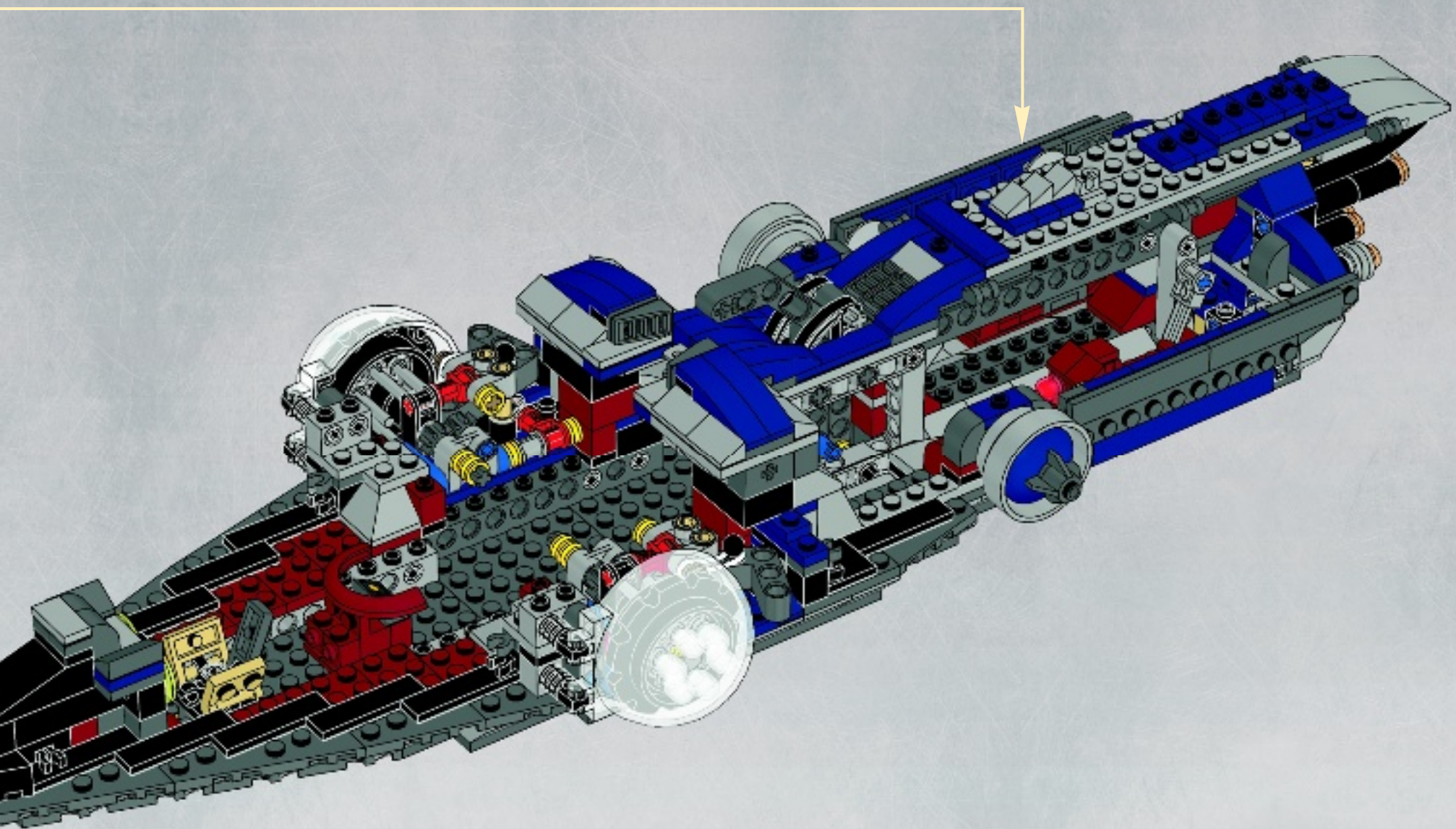

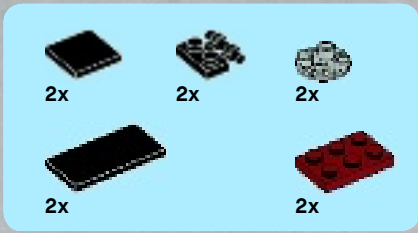

74

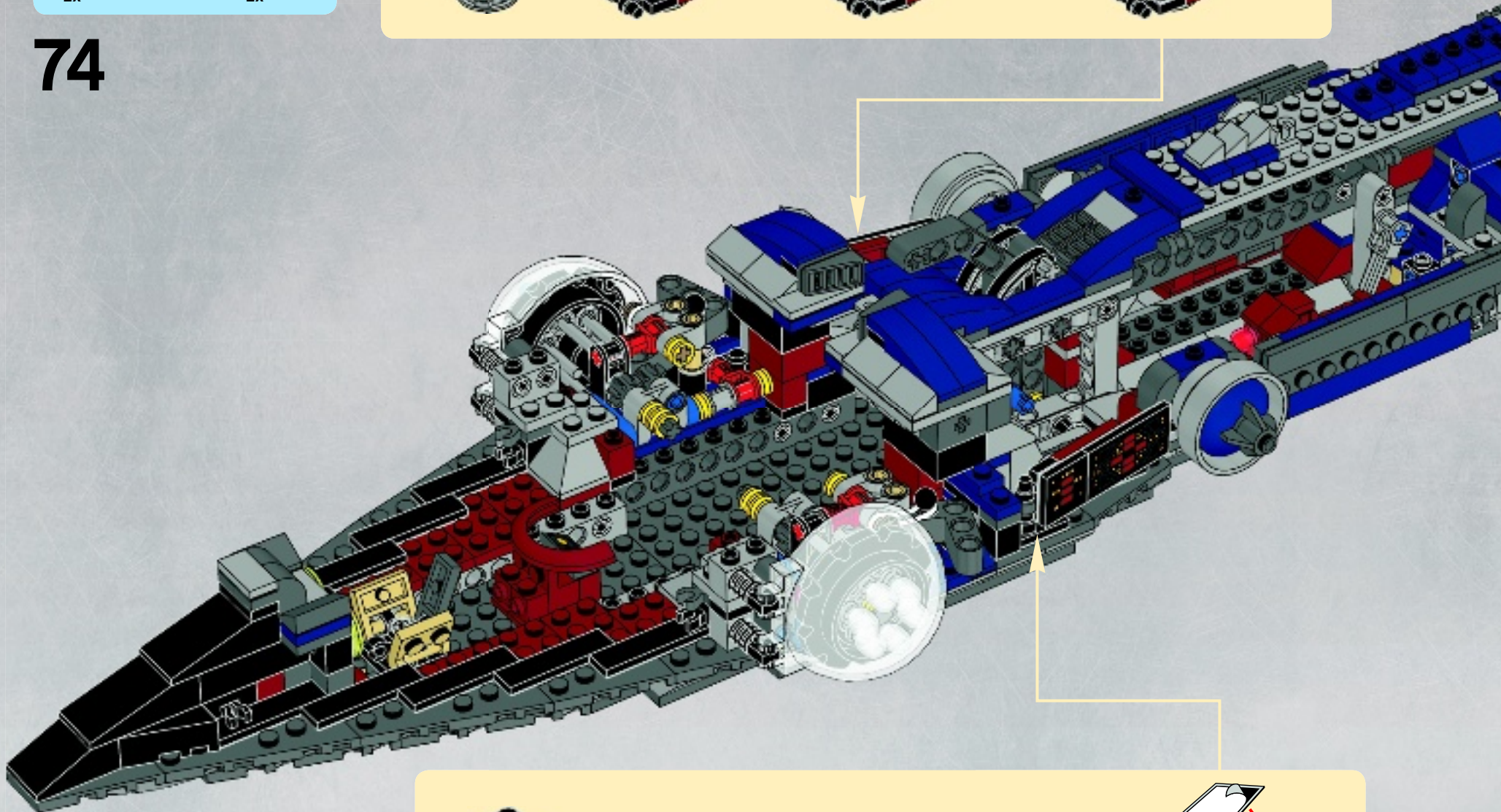
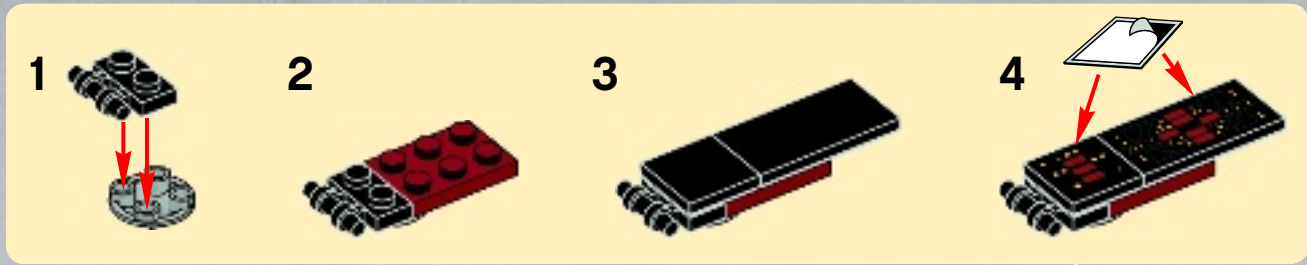

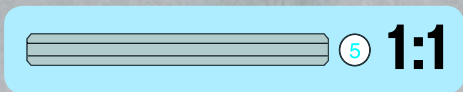
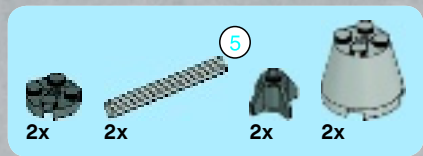

75

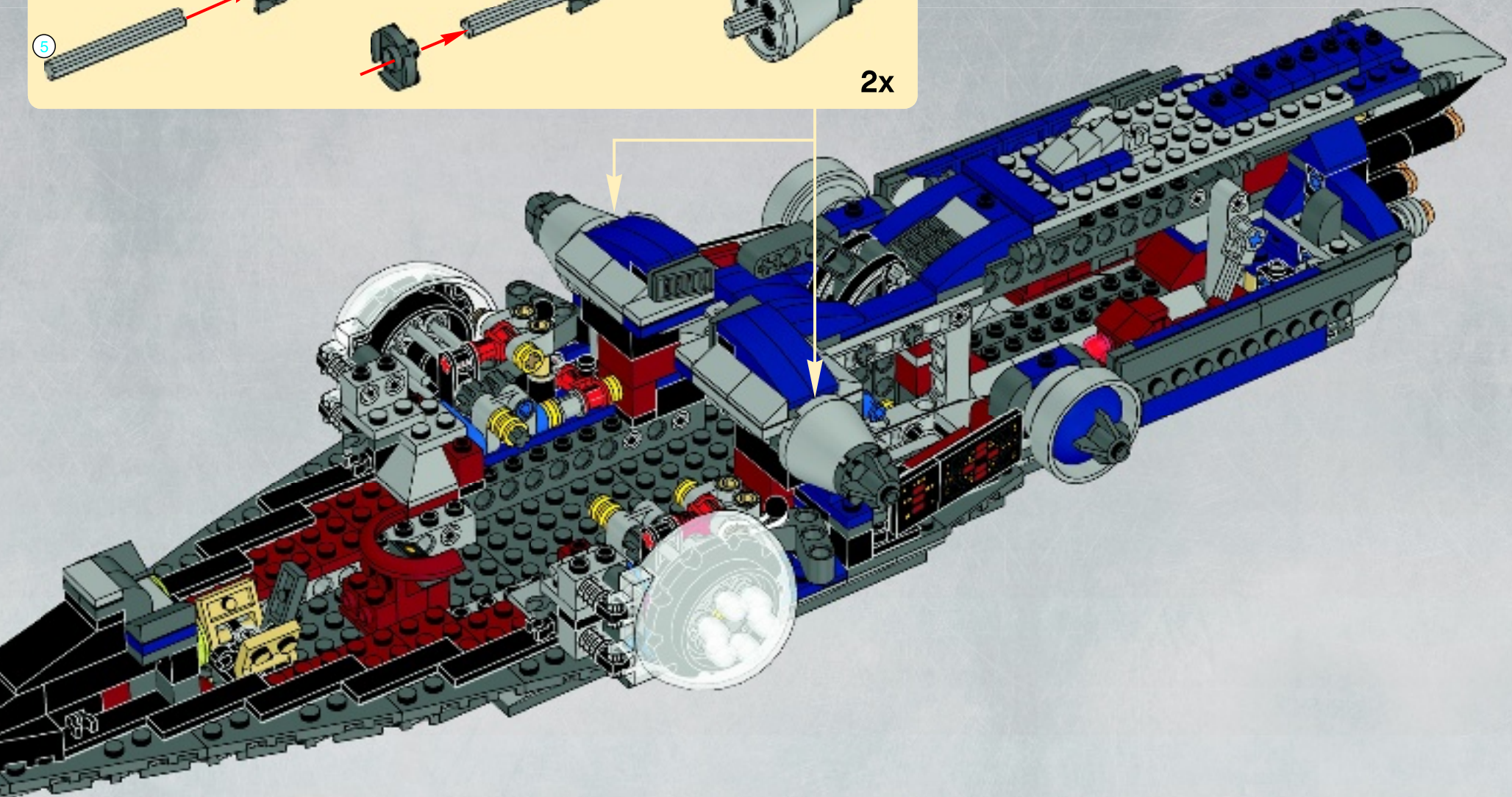
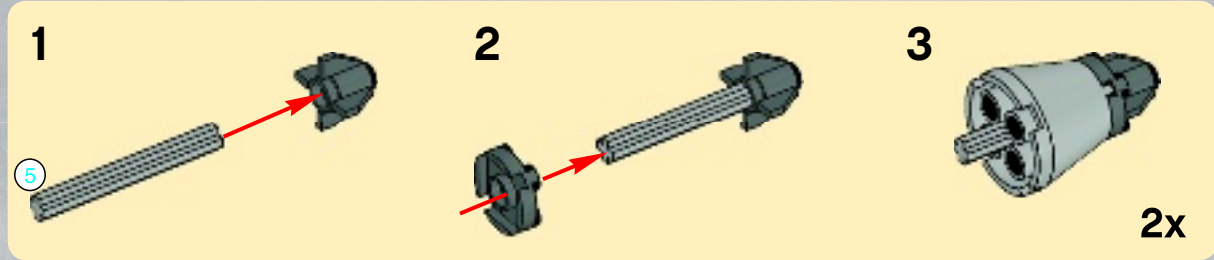

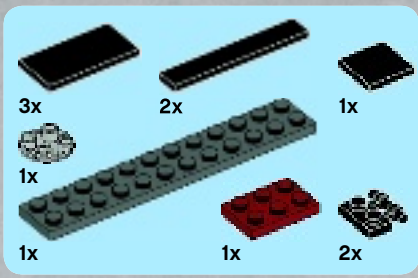

76

1

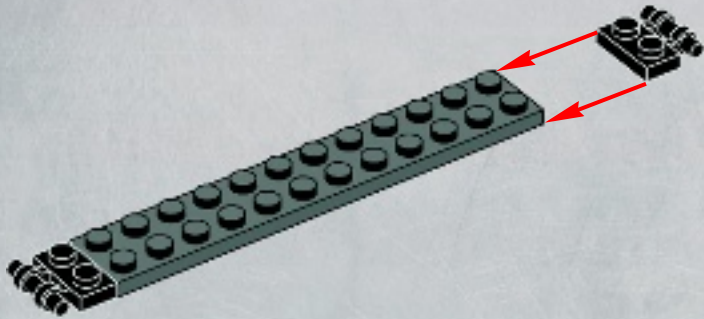

2

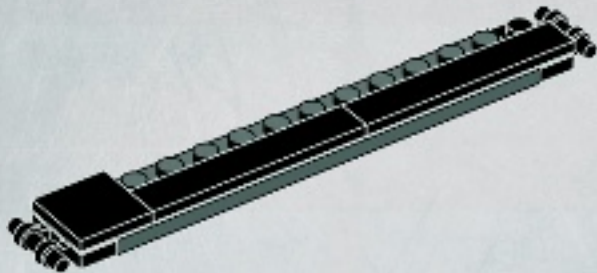

3

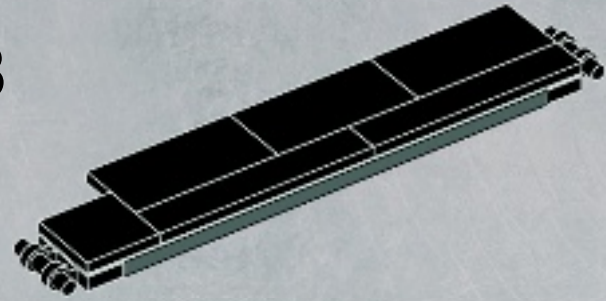

4

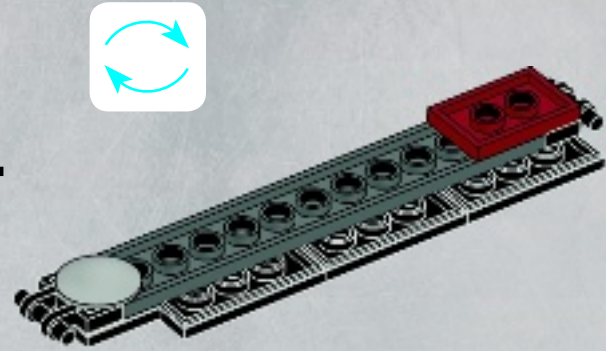

5

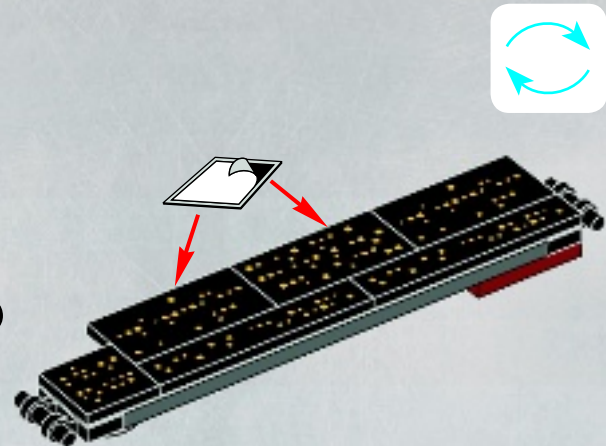

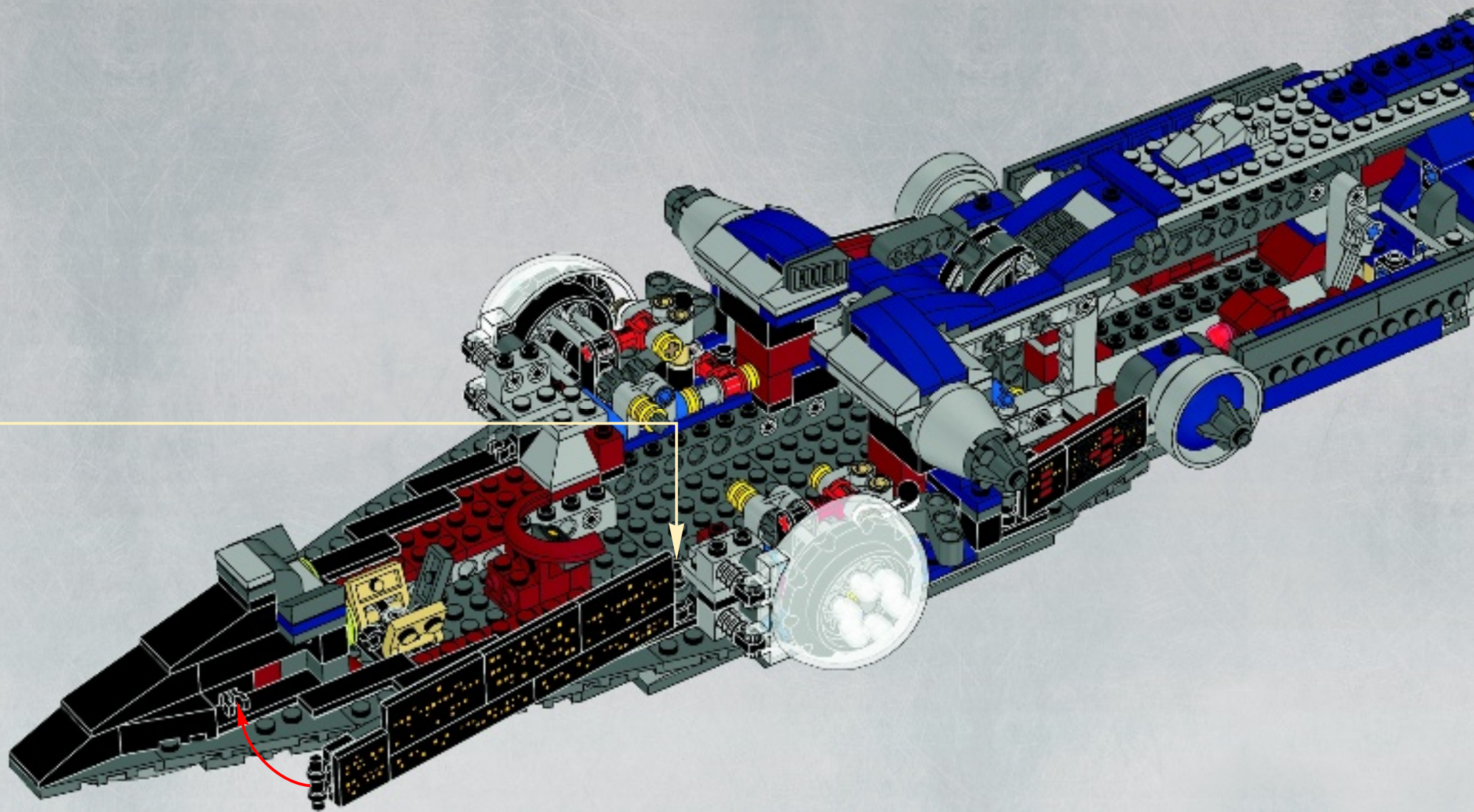

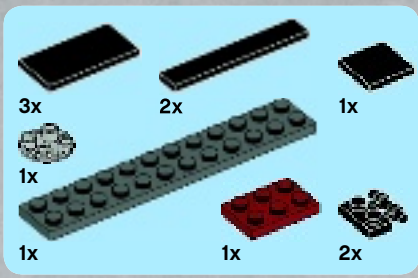

77

1

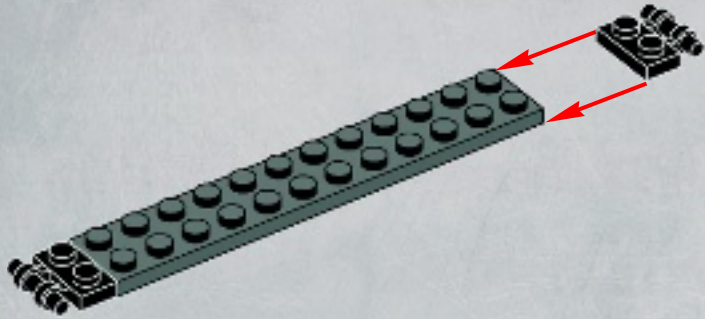

2

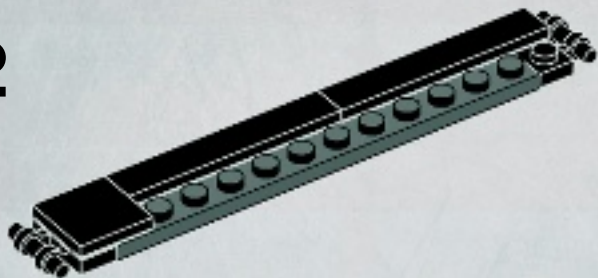

3

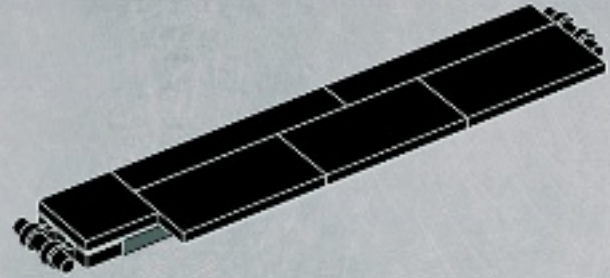

4

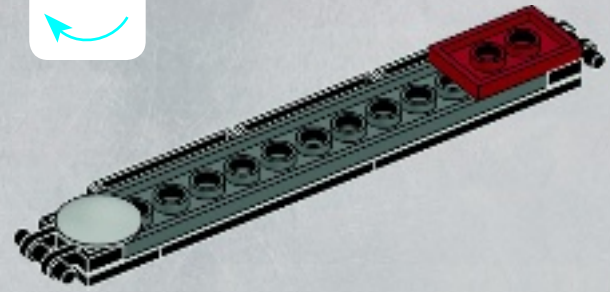

5

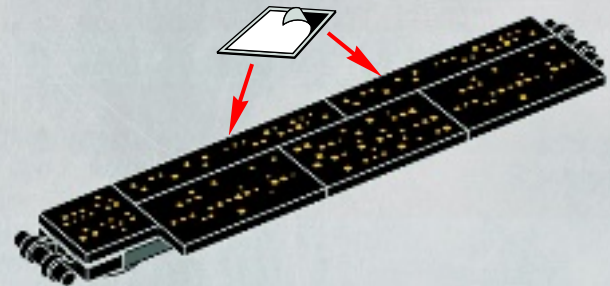

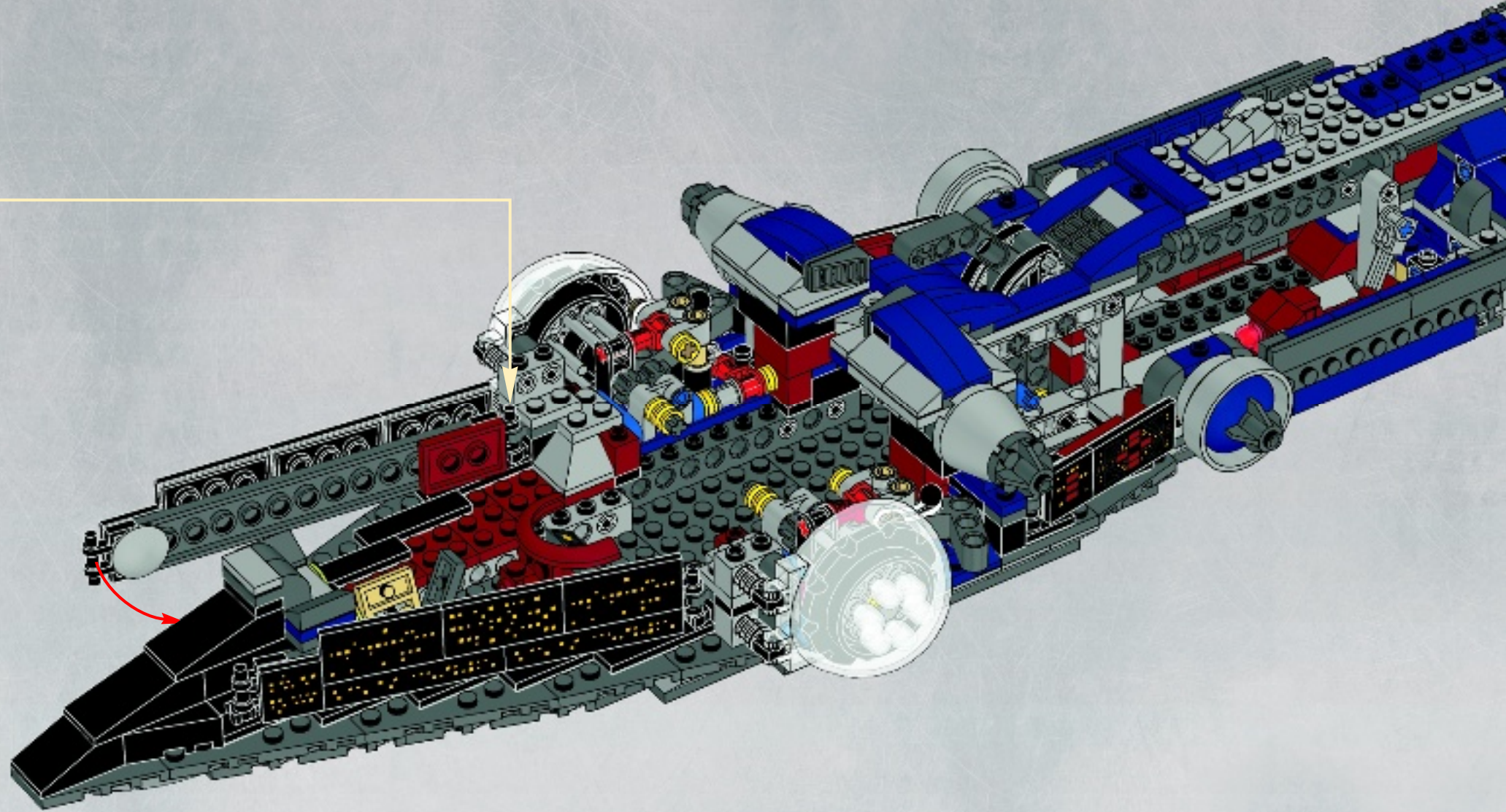

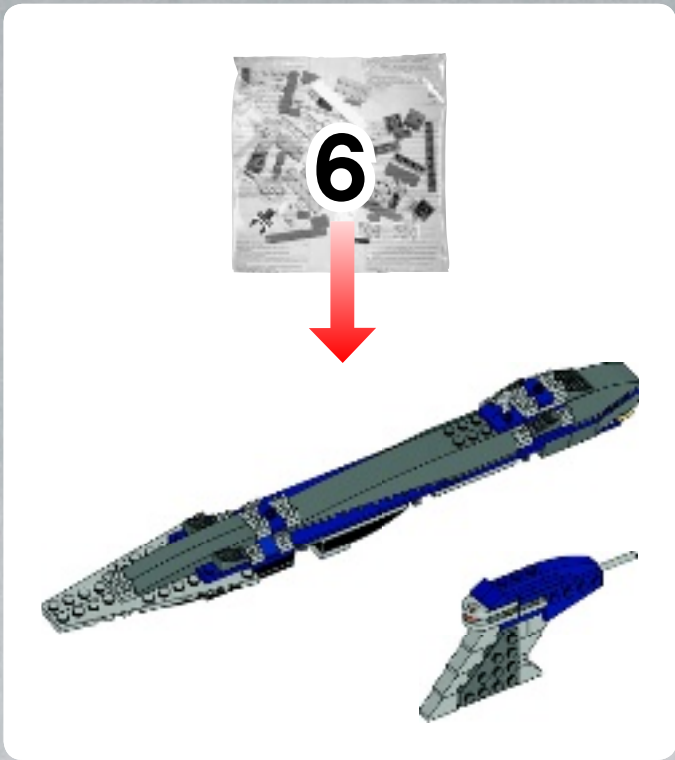

1

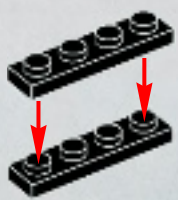

2

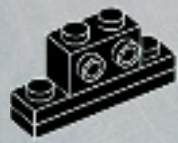

3

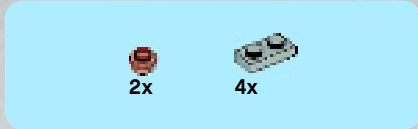
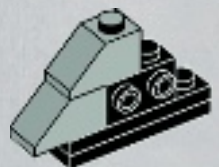

4

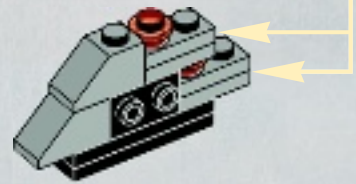
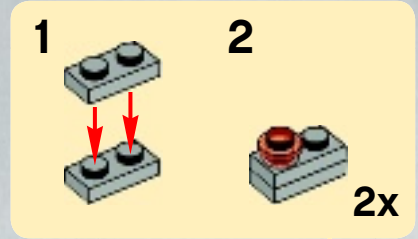



1x



2x

5

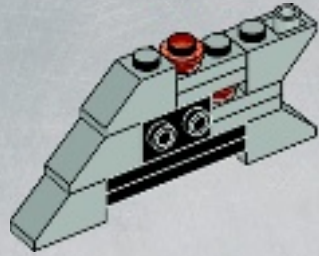

1x



1x



1x

6

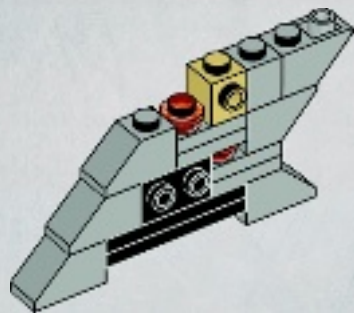

1x



1x

7

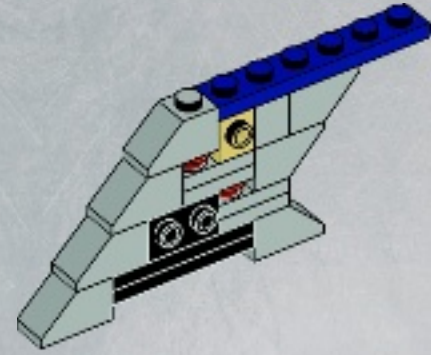

2x



2x

8

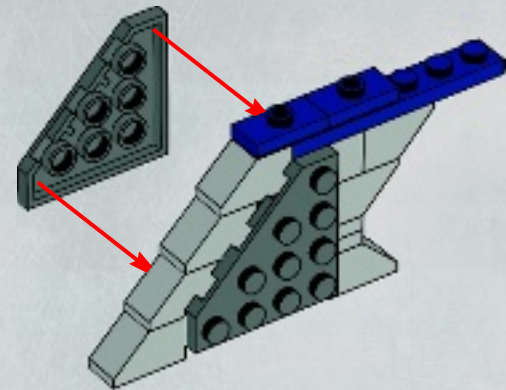

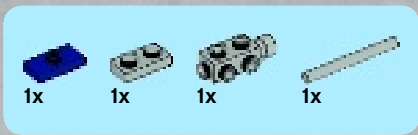

9

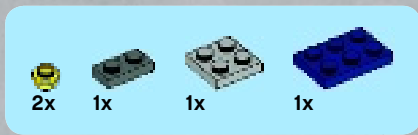
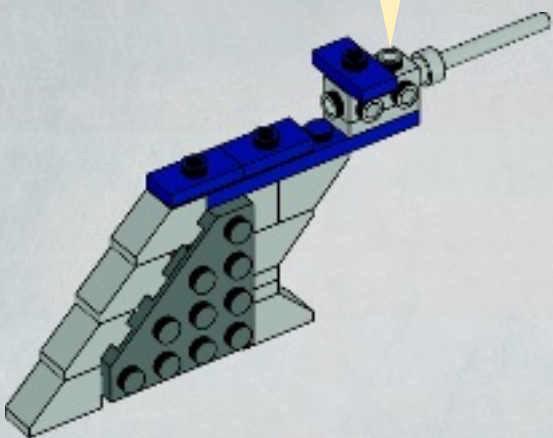
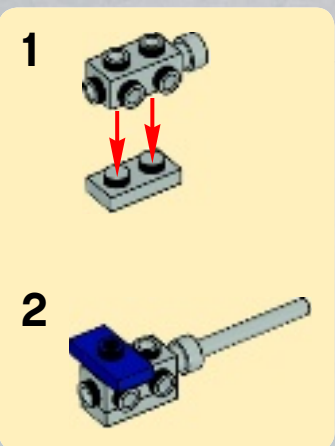

10

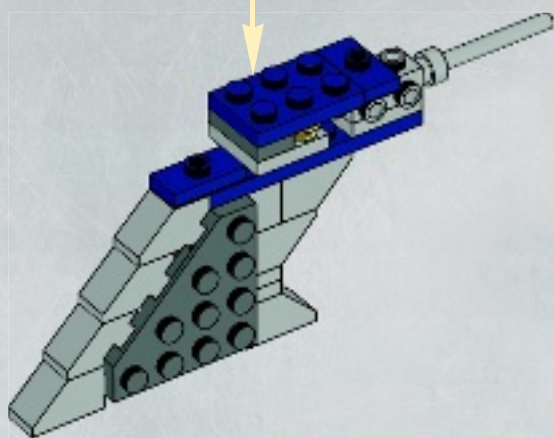



11

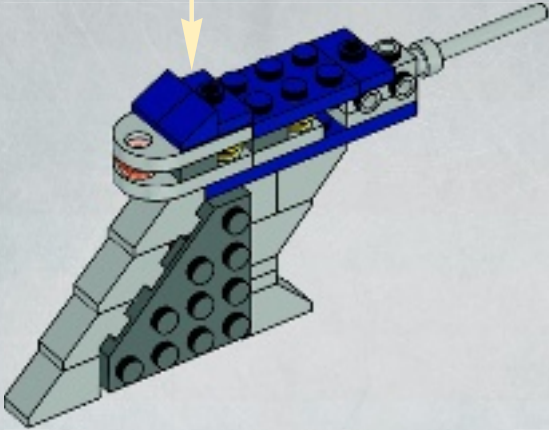
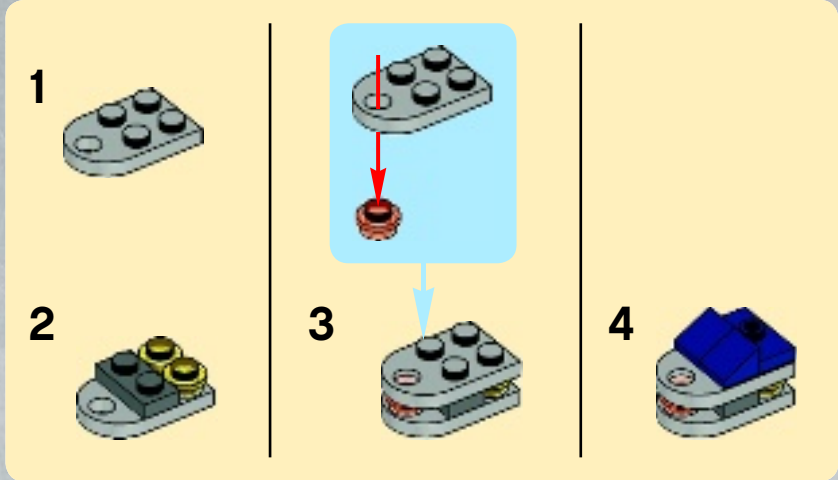

12

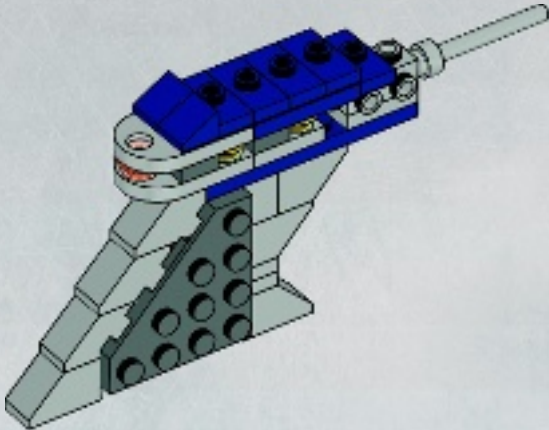

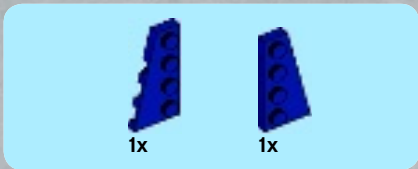

13

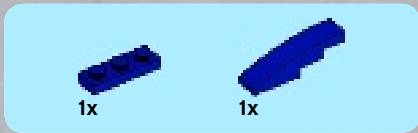
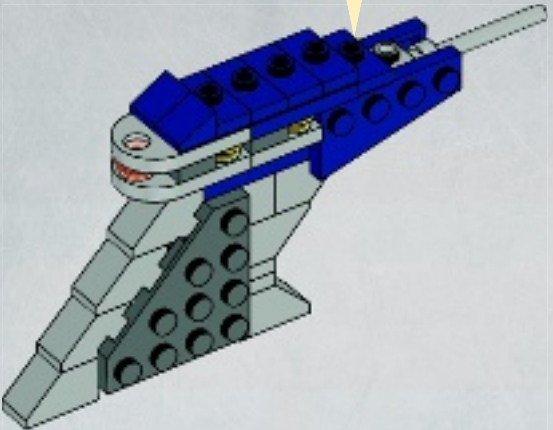

14

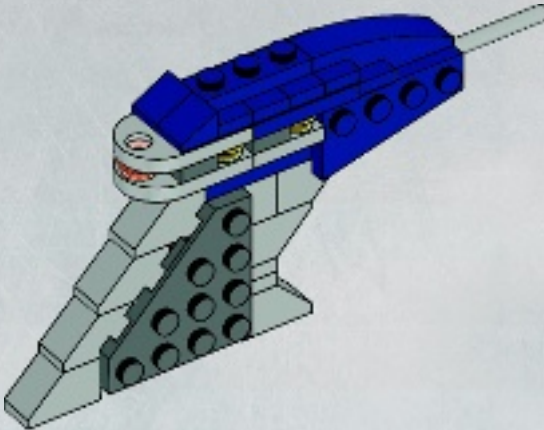

78

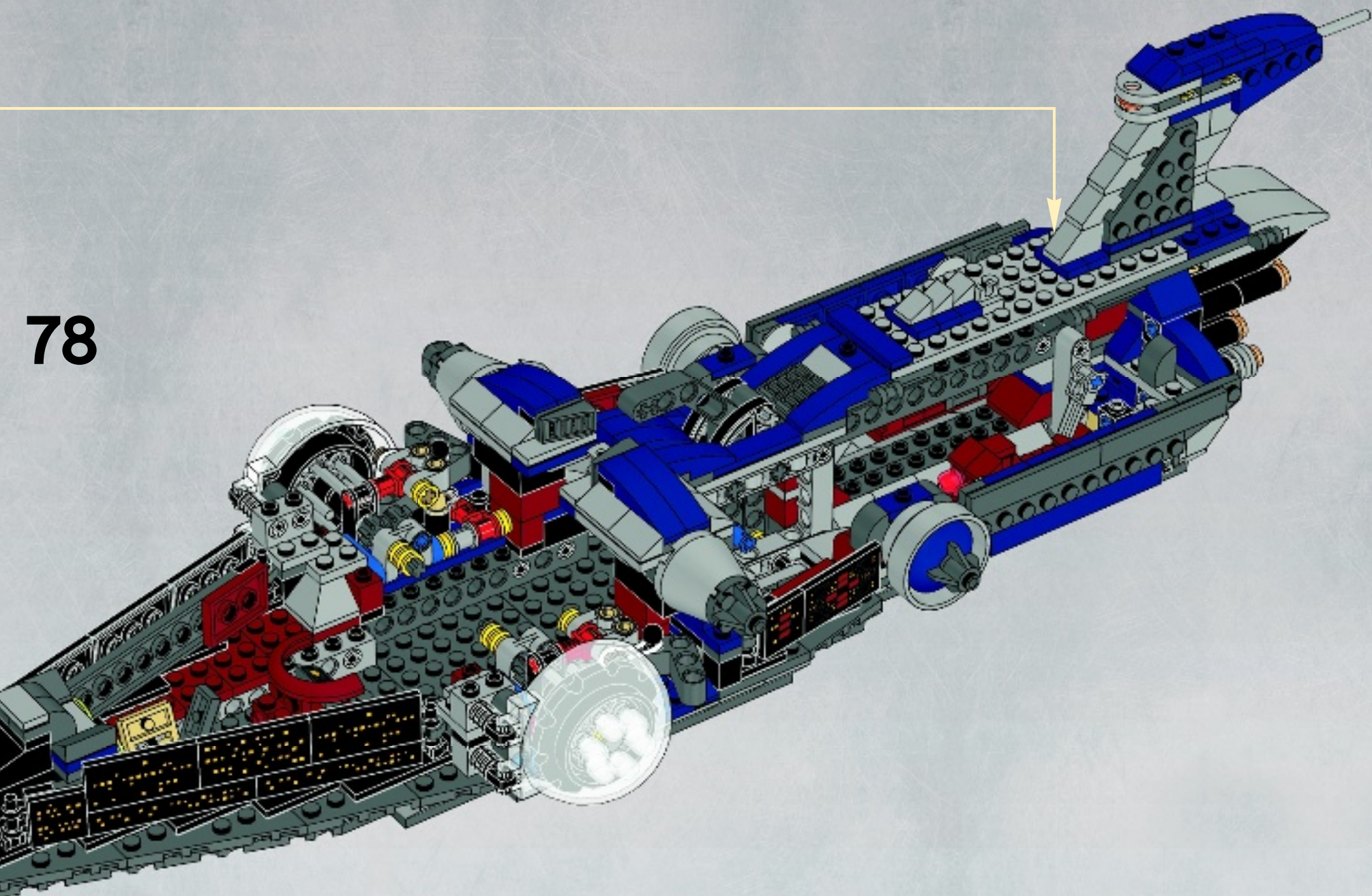

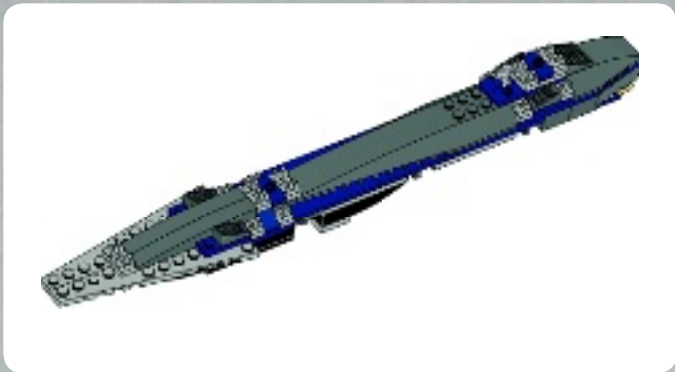

1

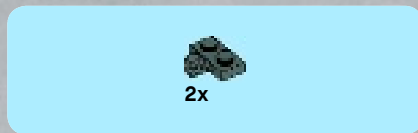
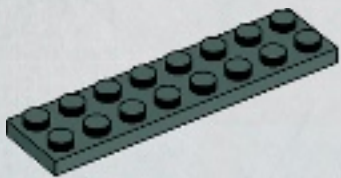

2

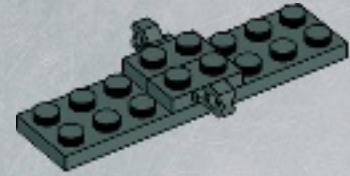

3

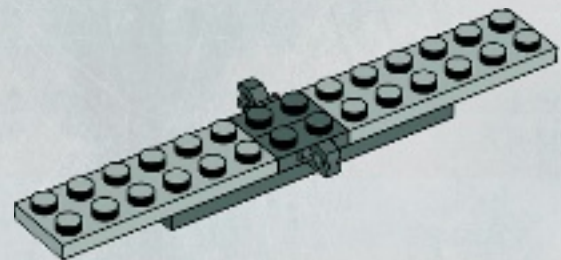

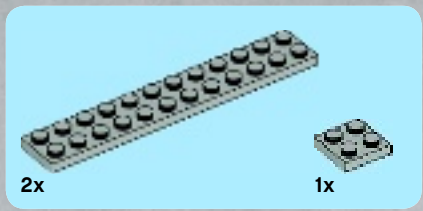

4

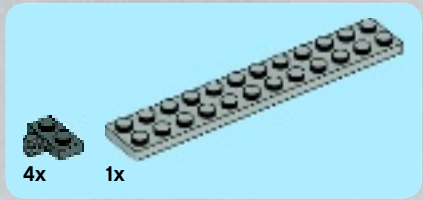
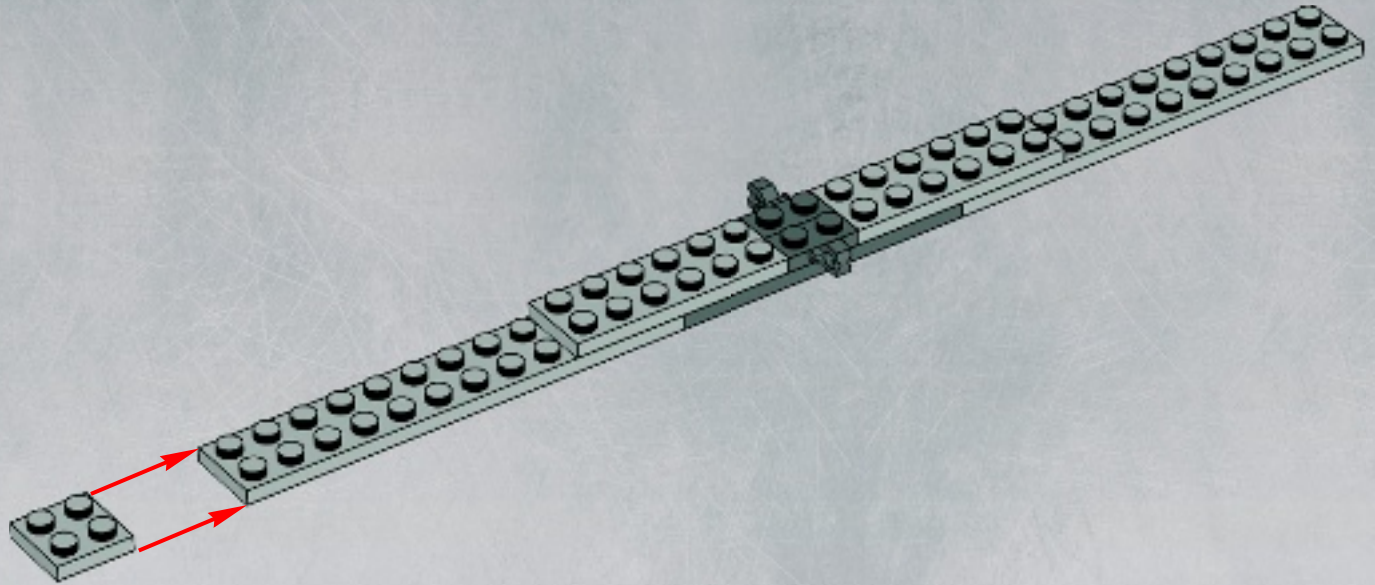

5

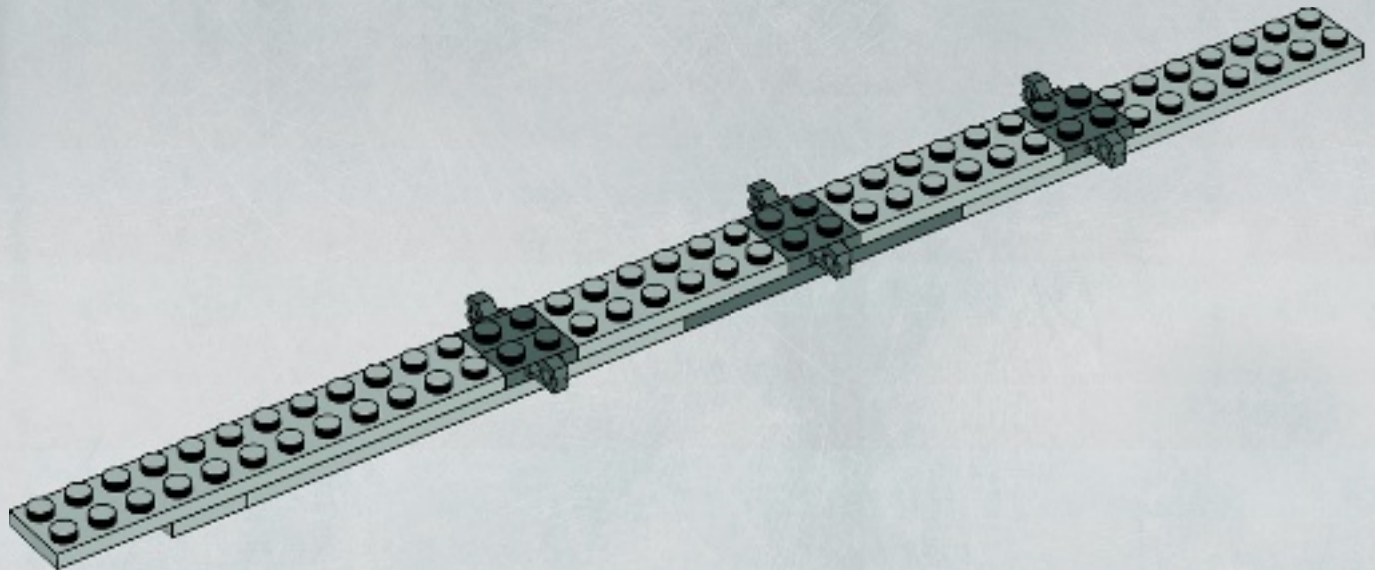

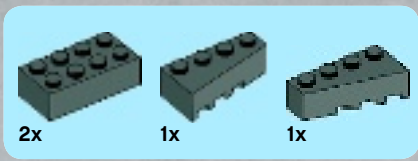

6

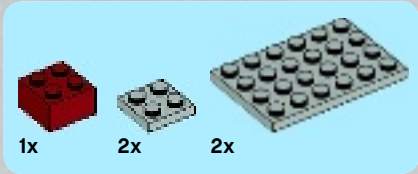
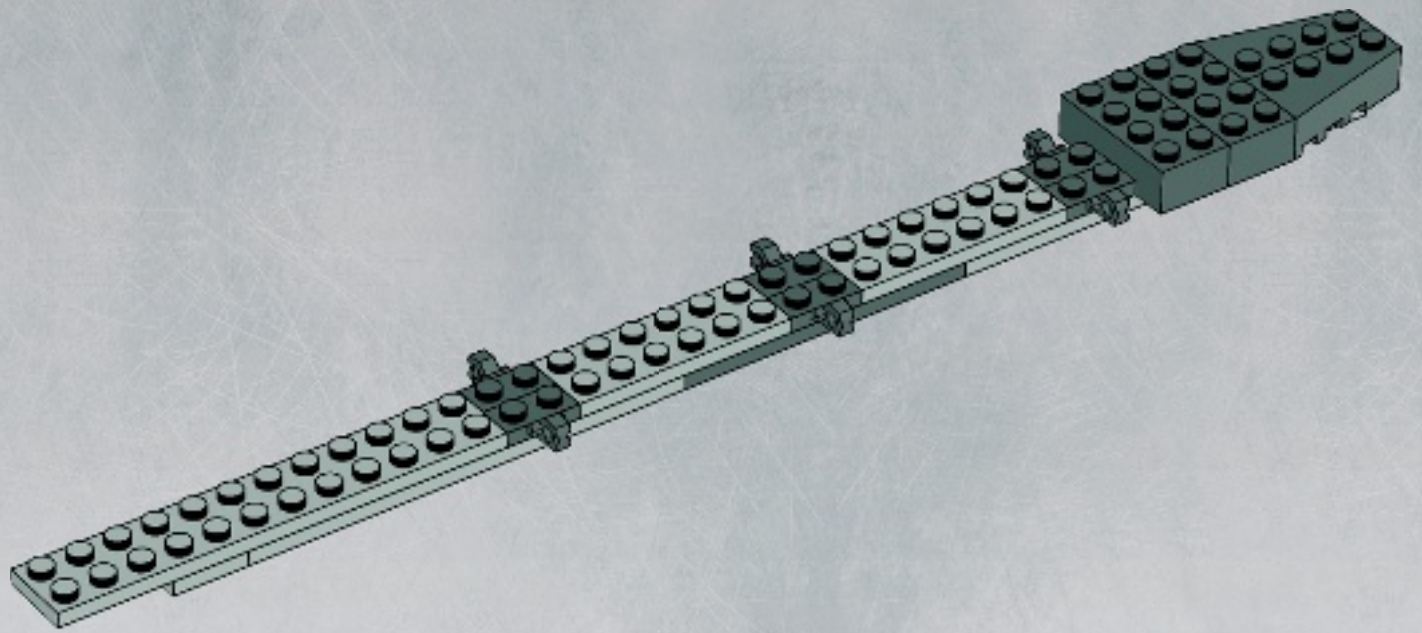

7

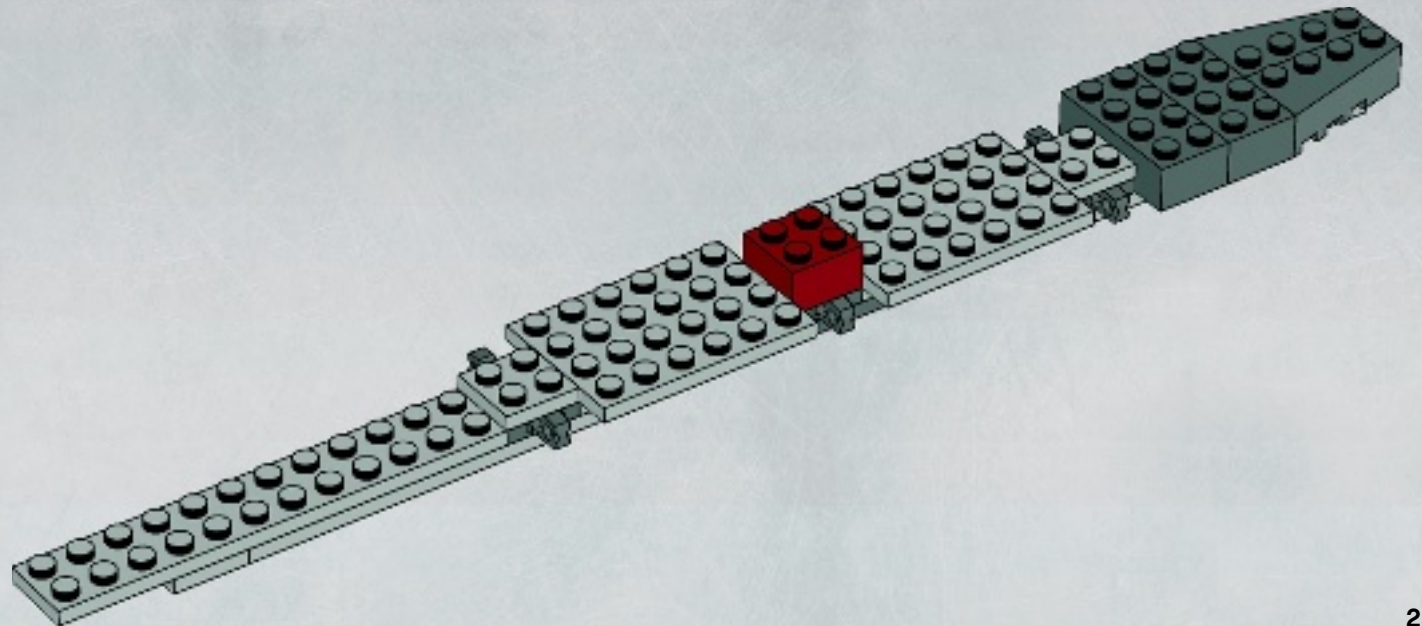

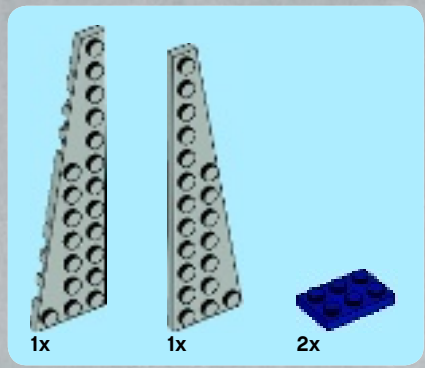

8

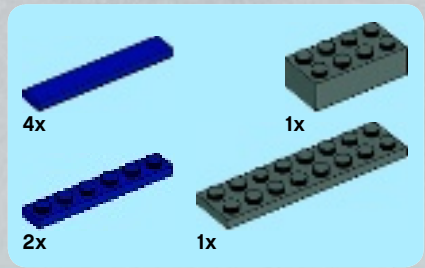
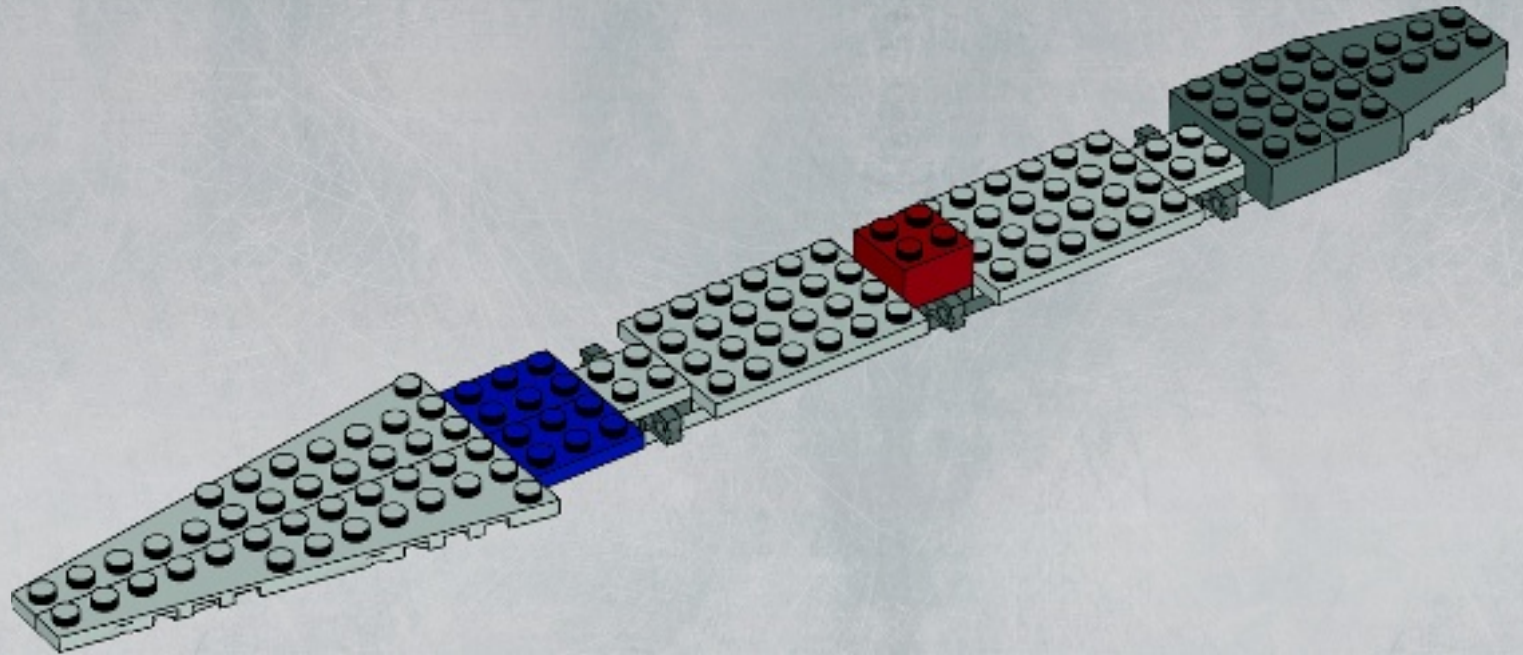

9

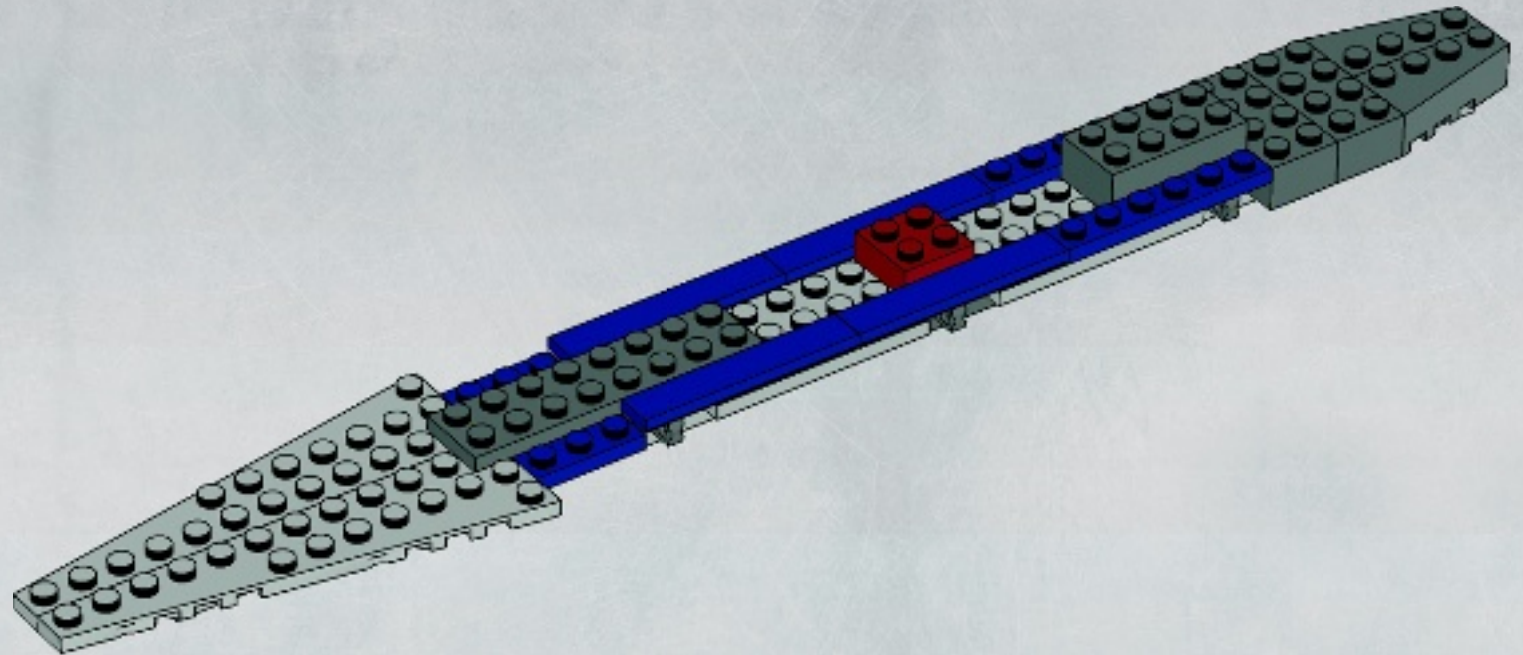

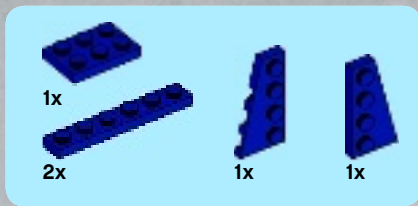

10

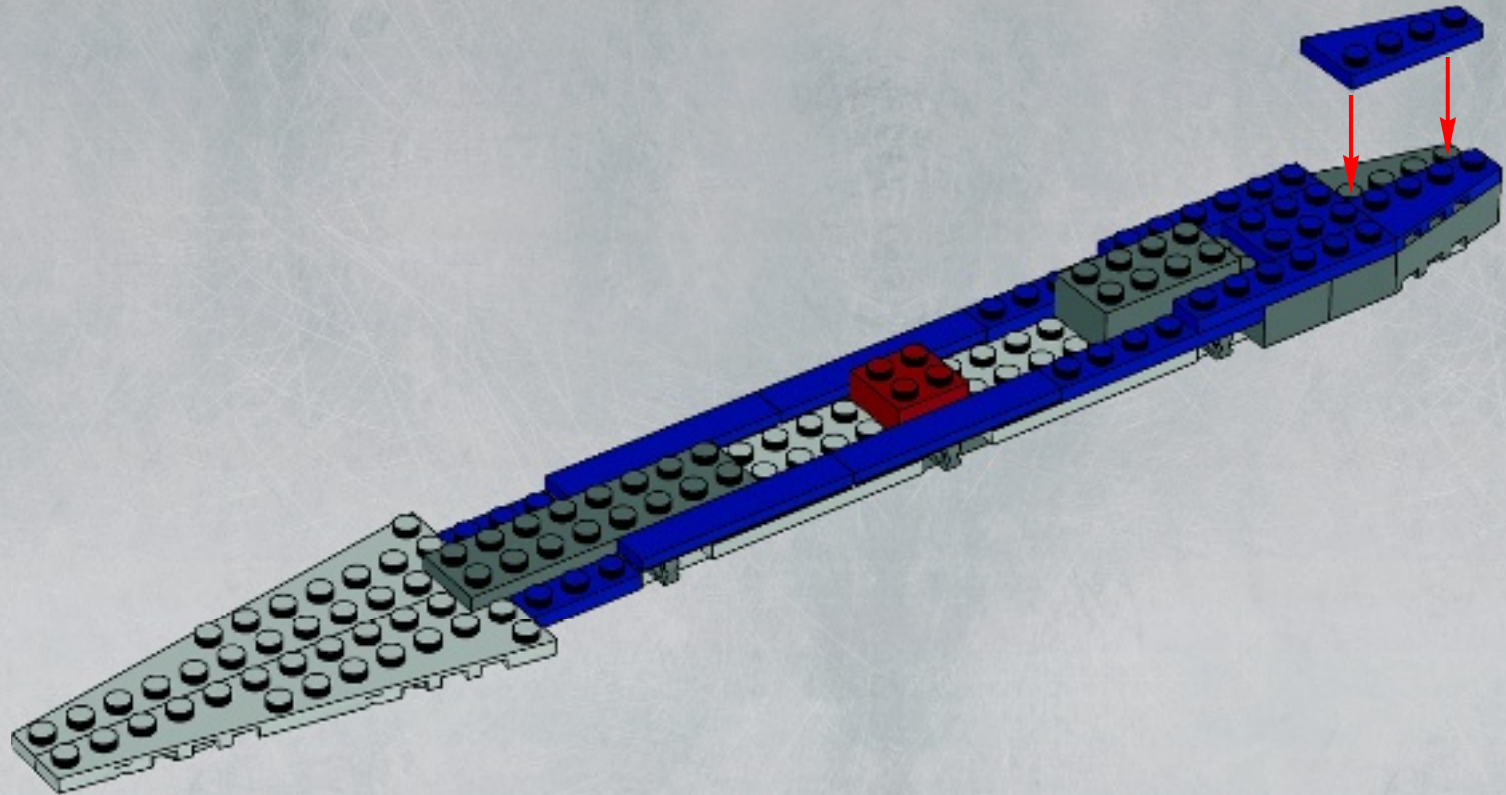

11

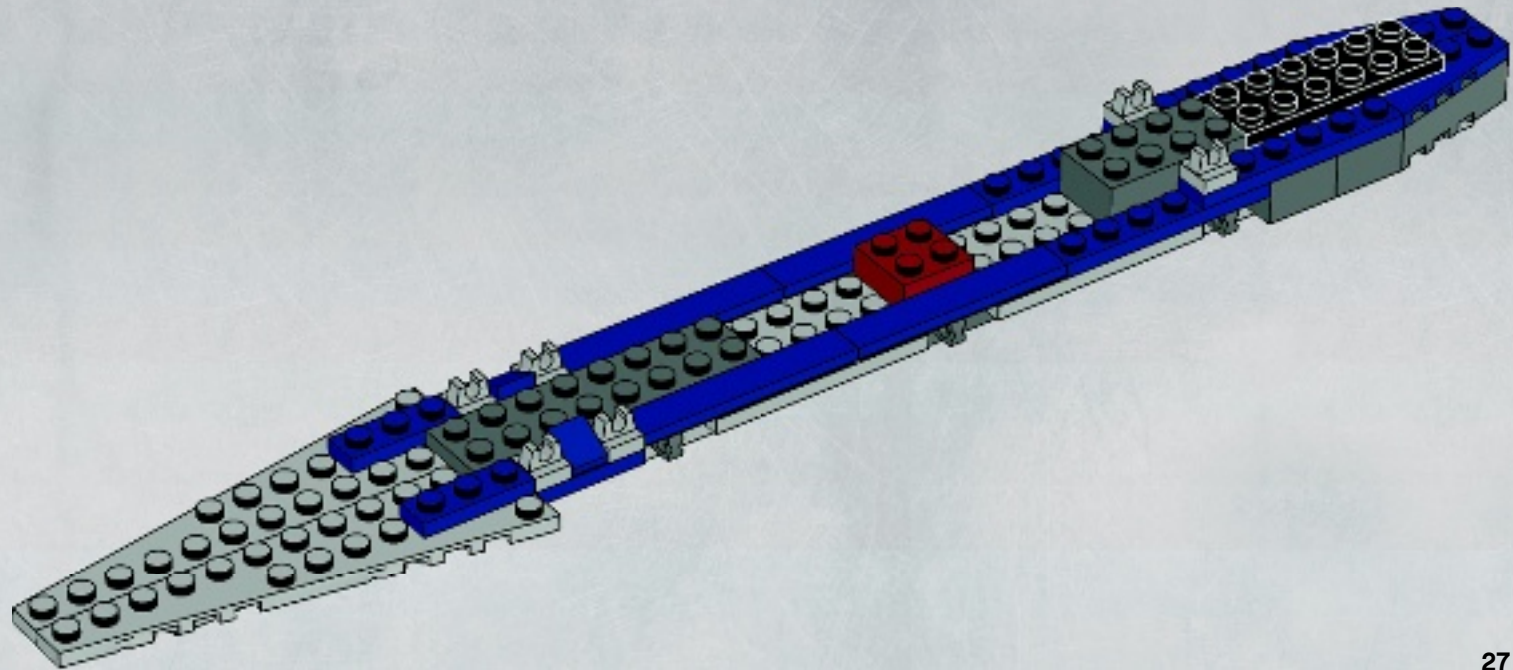

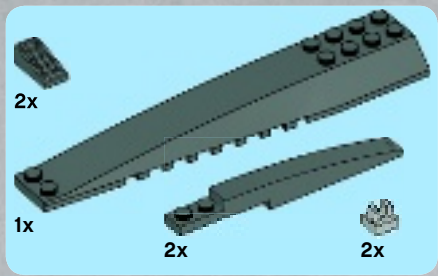

12

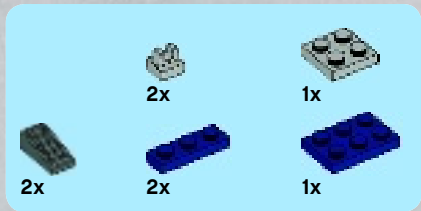
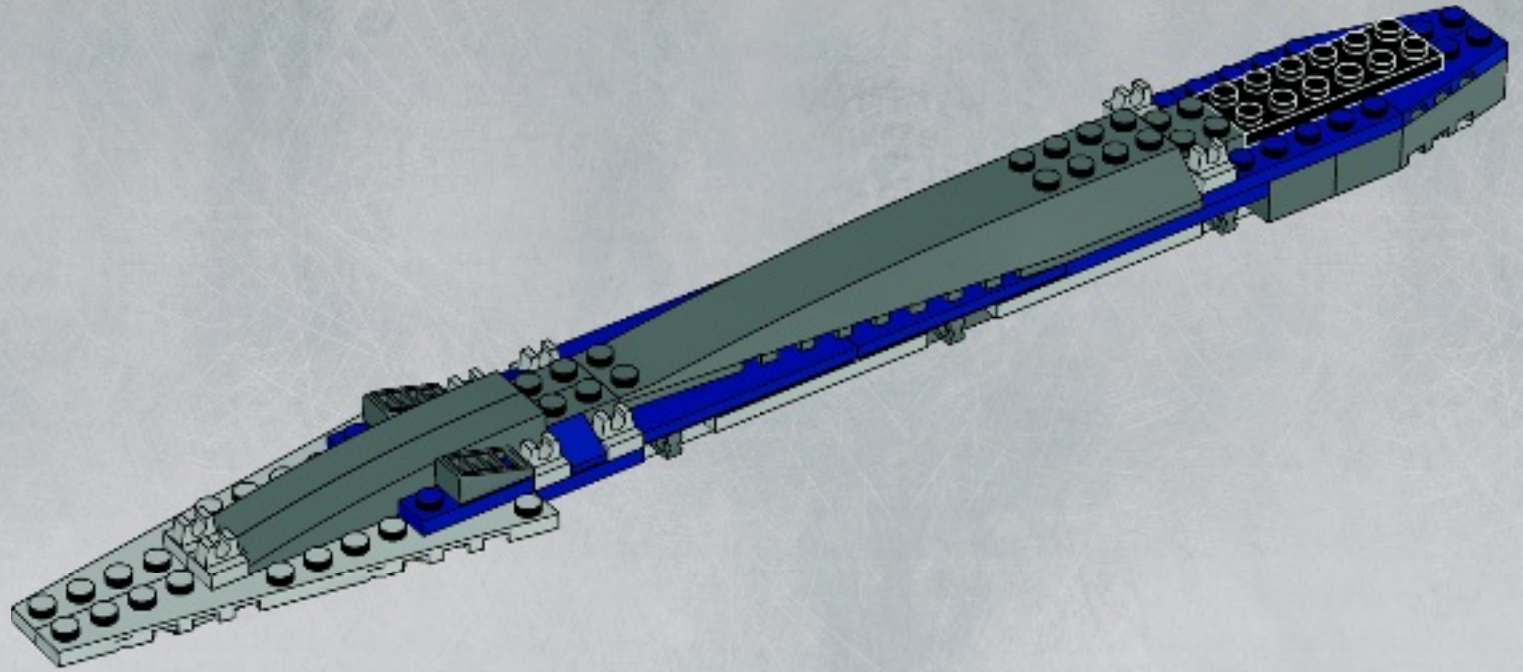

13

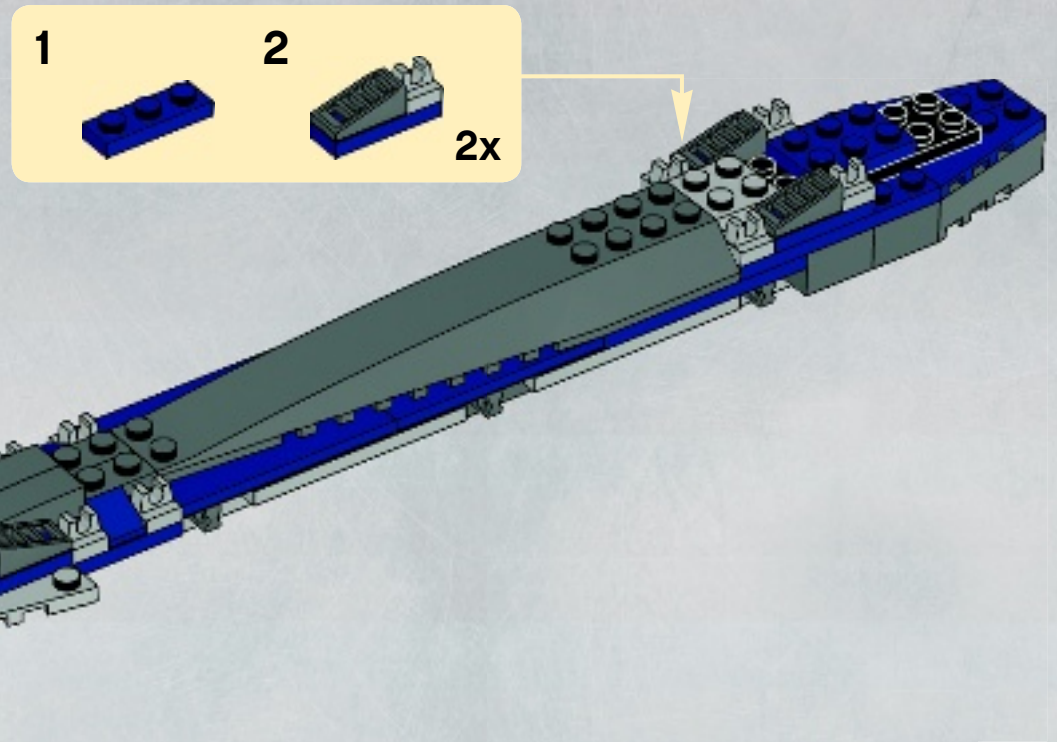



14

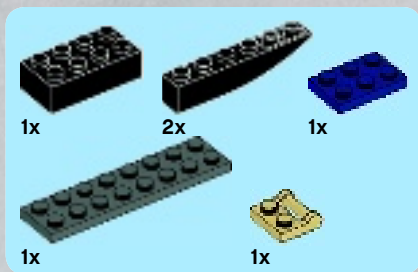
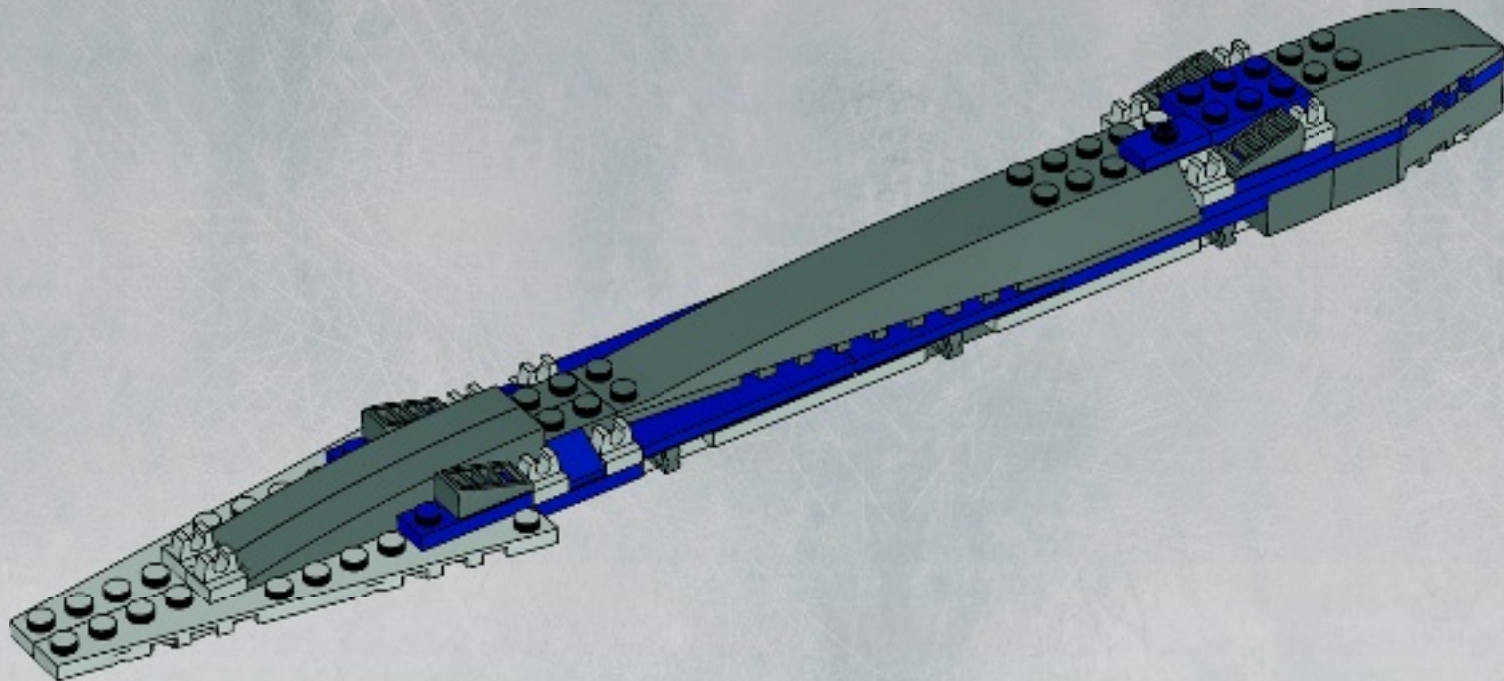

15

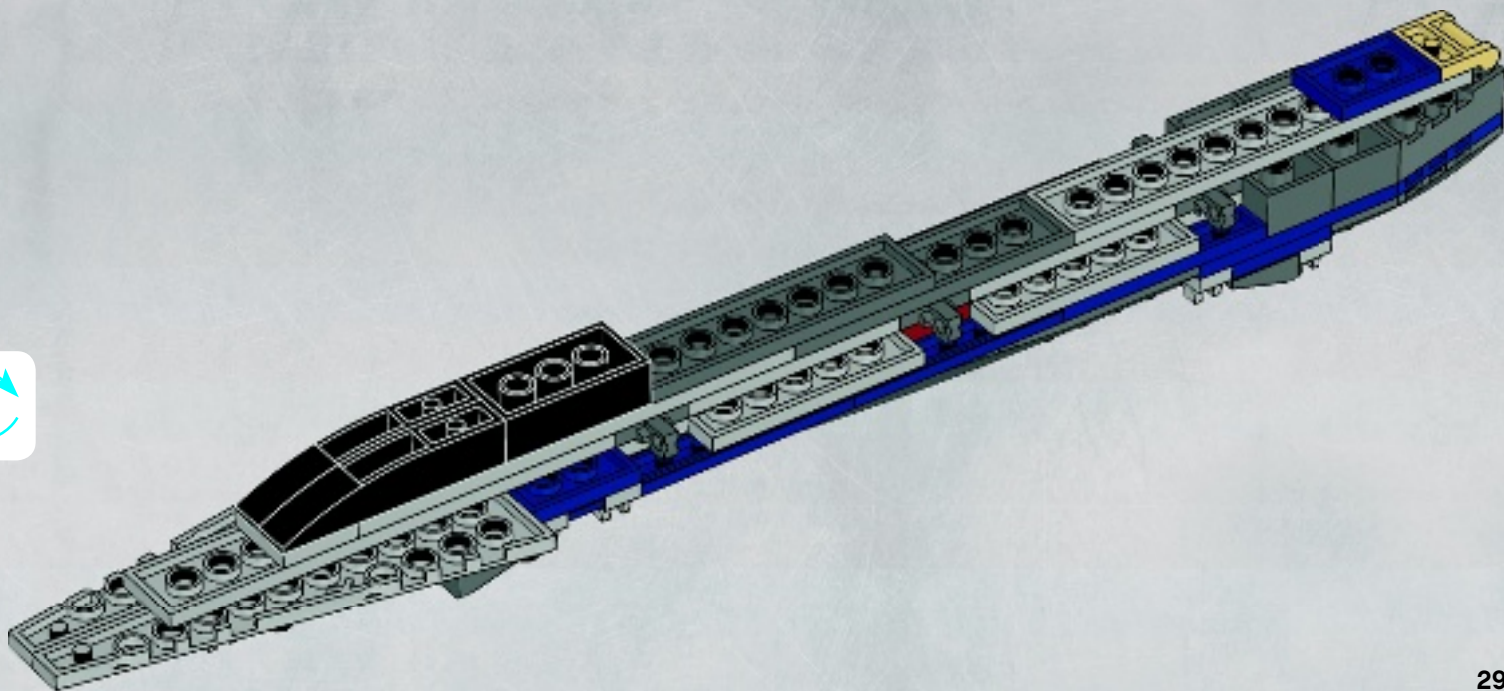
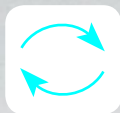



2x

16

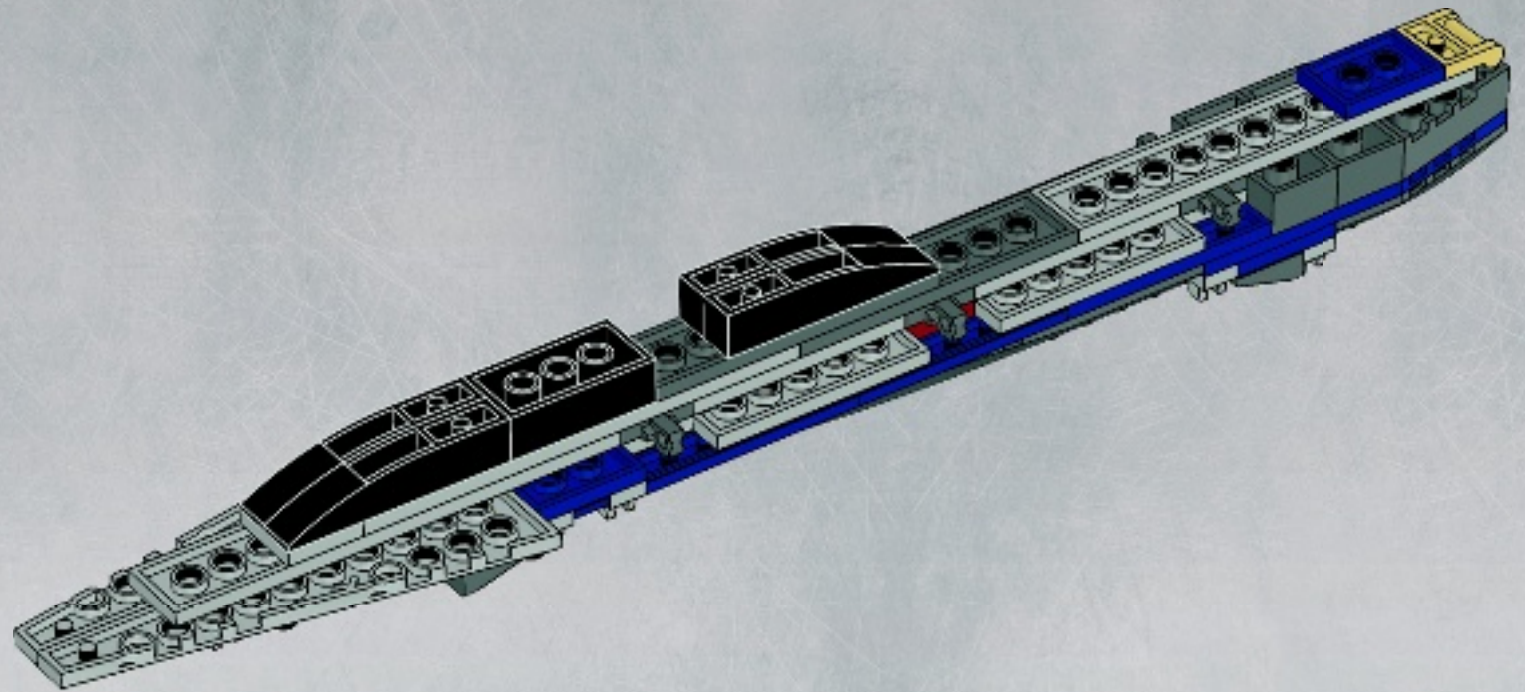

1x



1x



1x

17

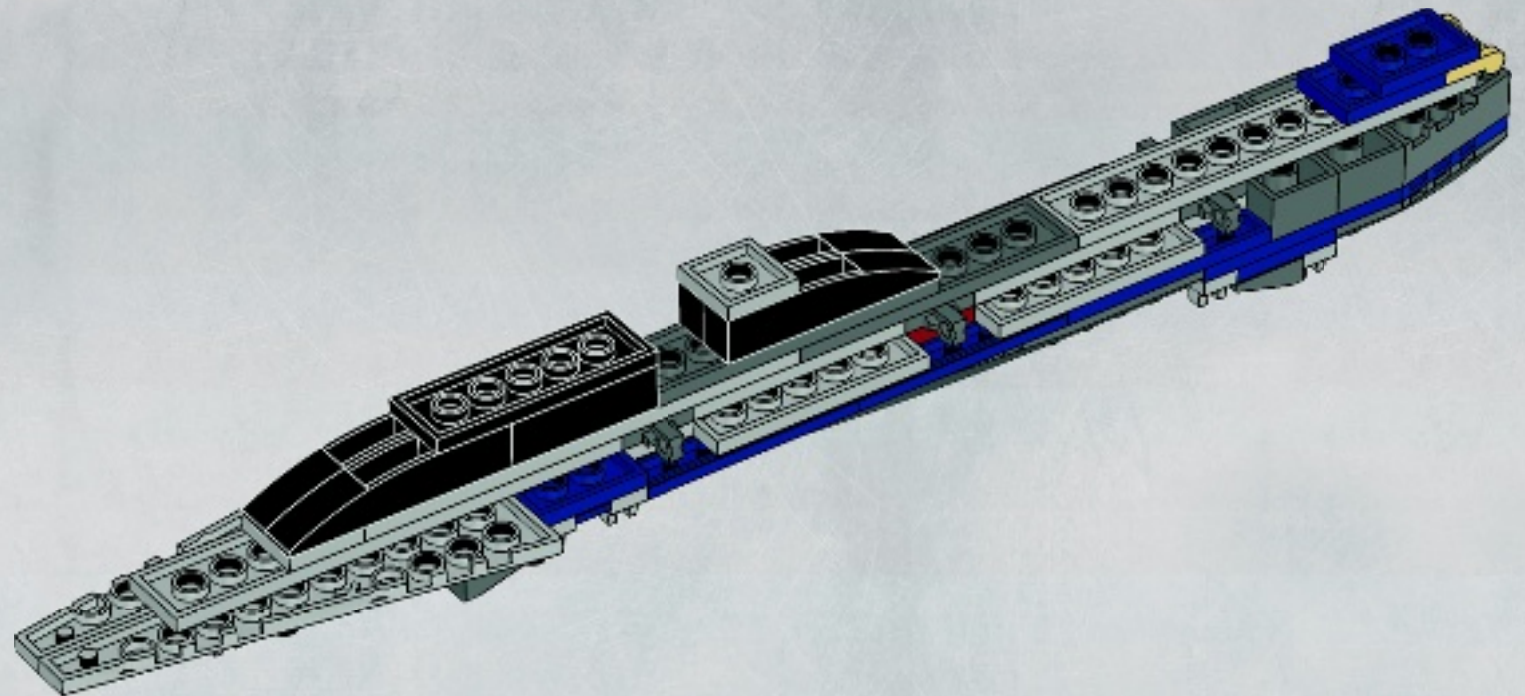



18

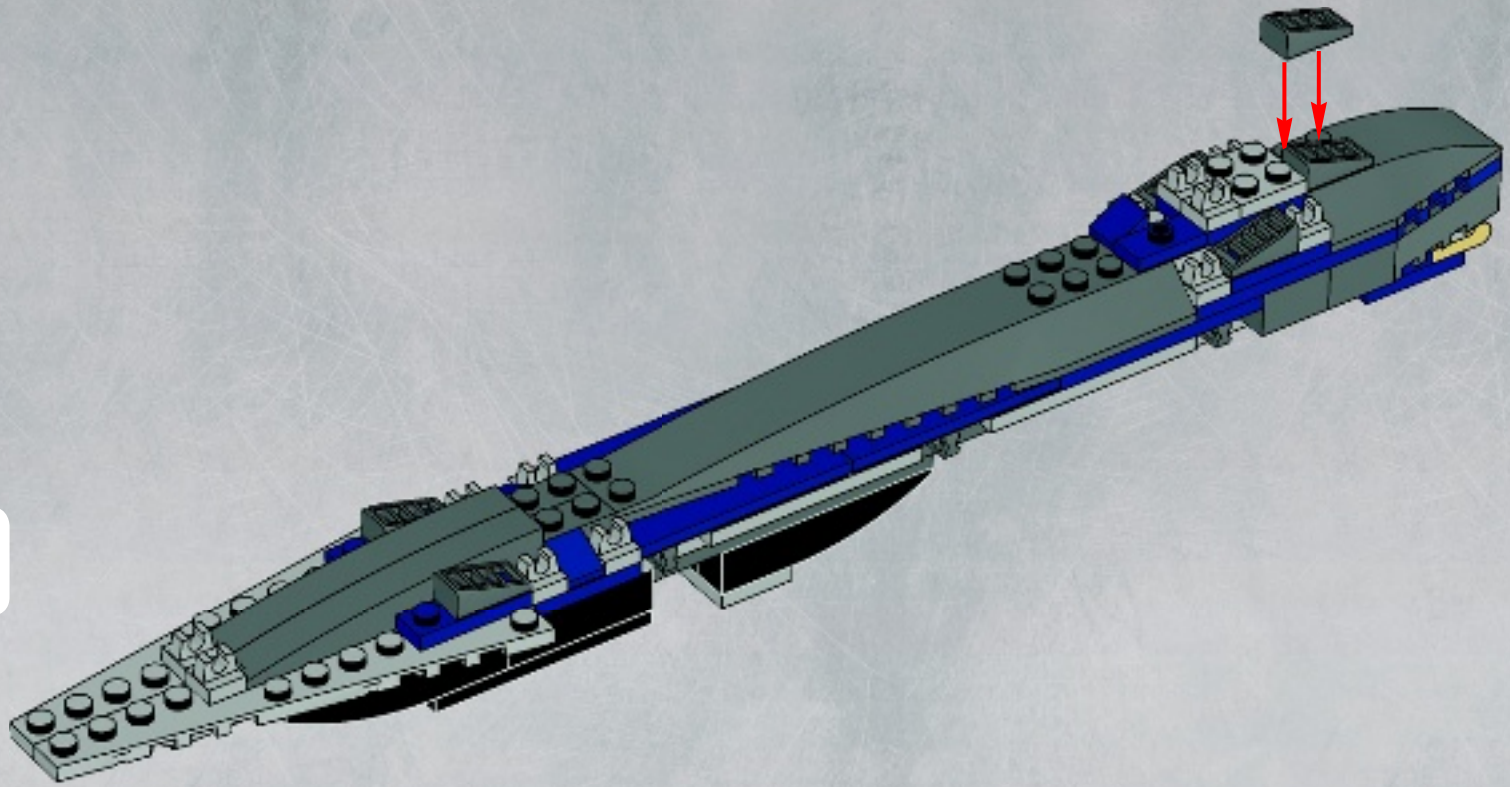

19

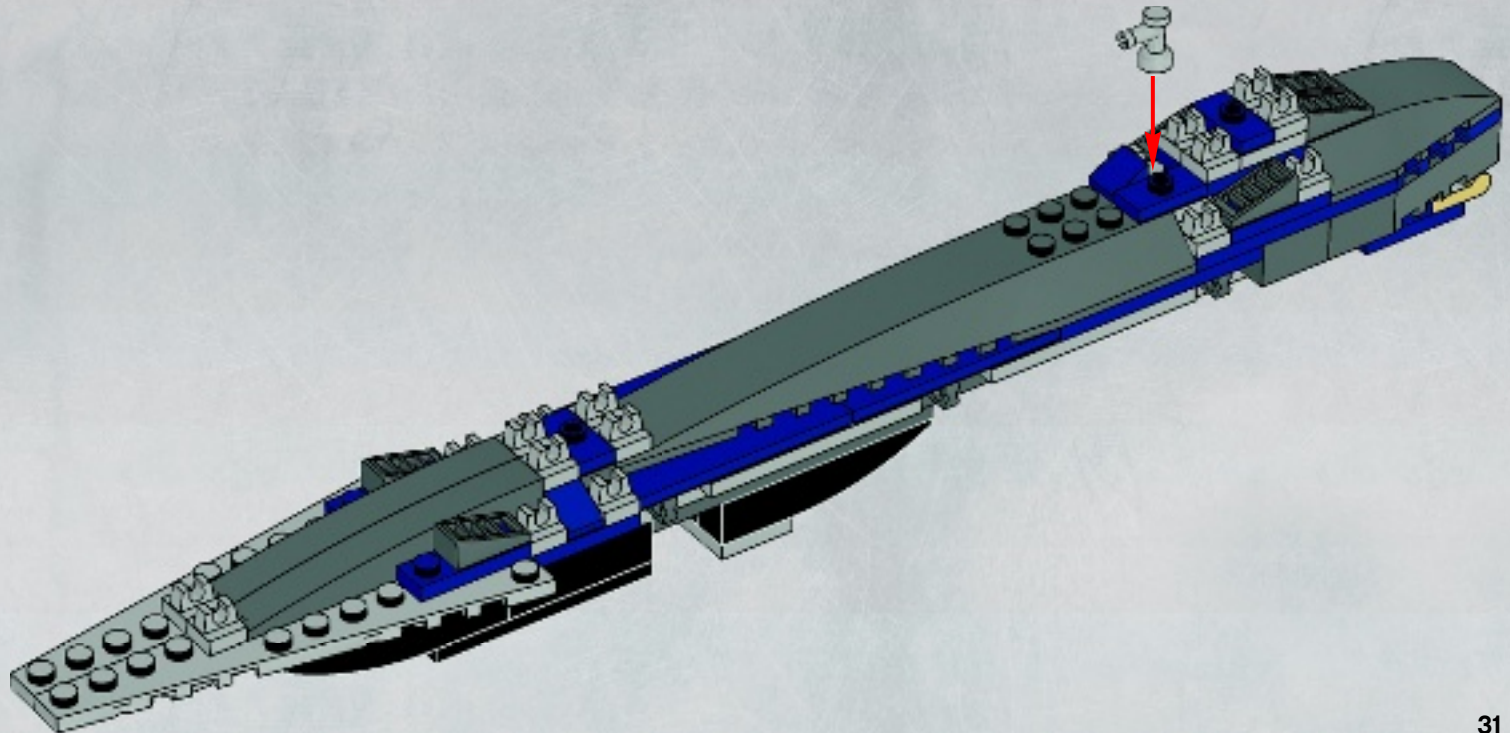

79

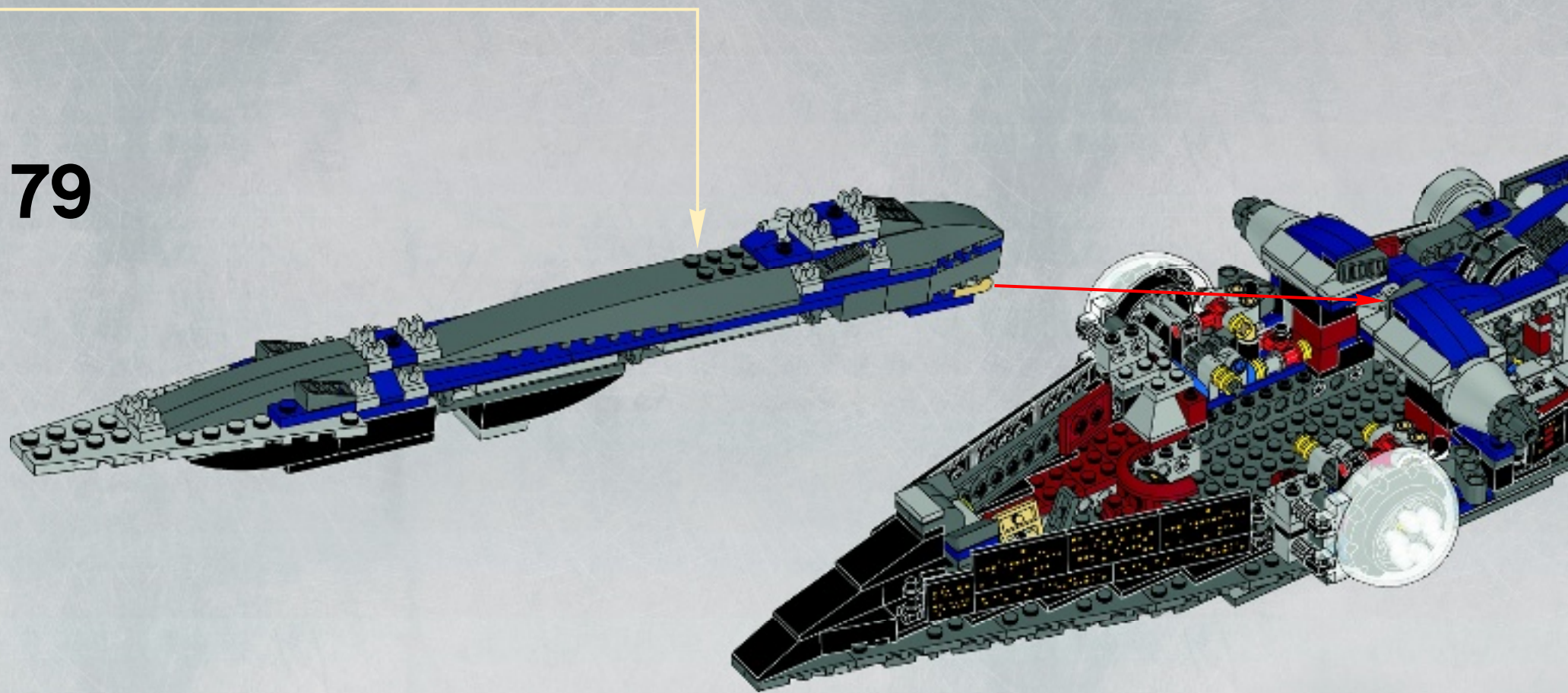

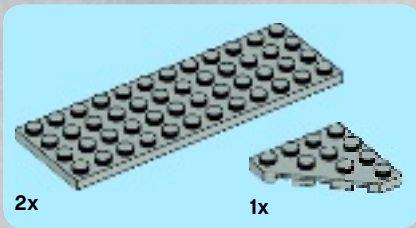
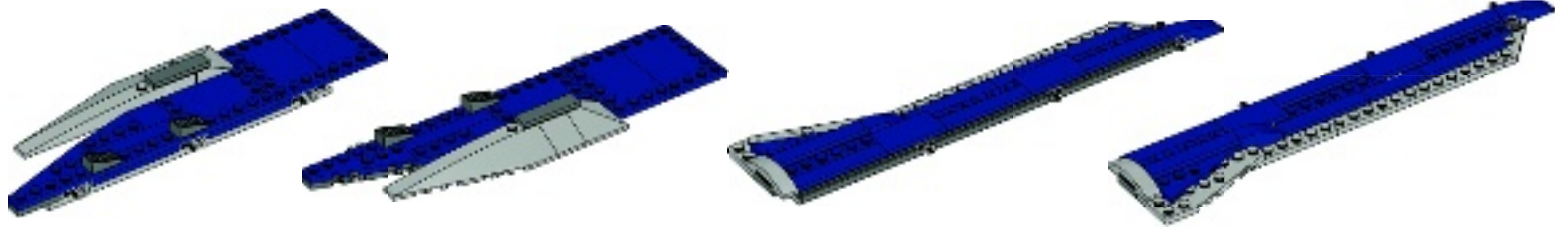

2x

1x

1

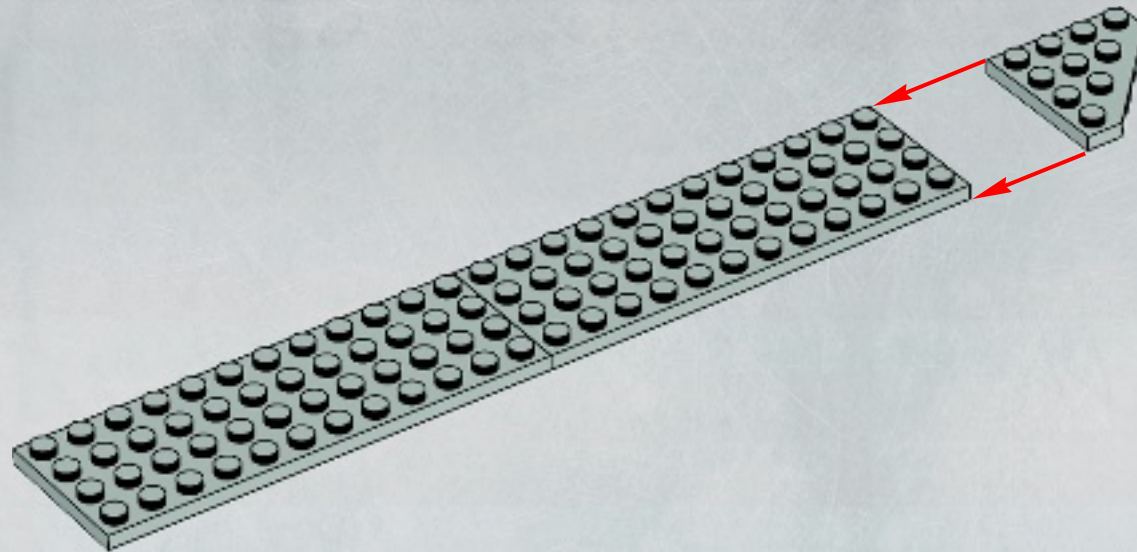

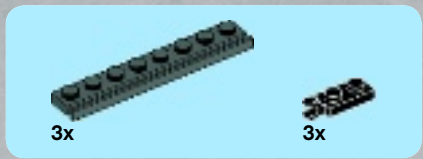

2

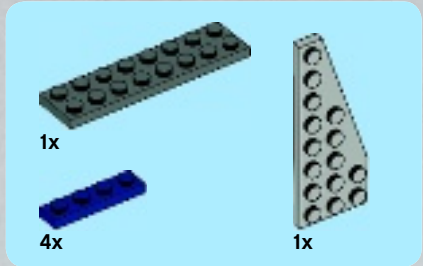
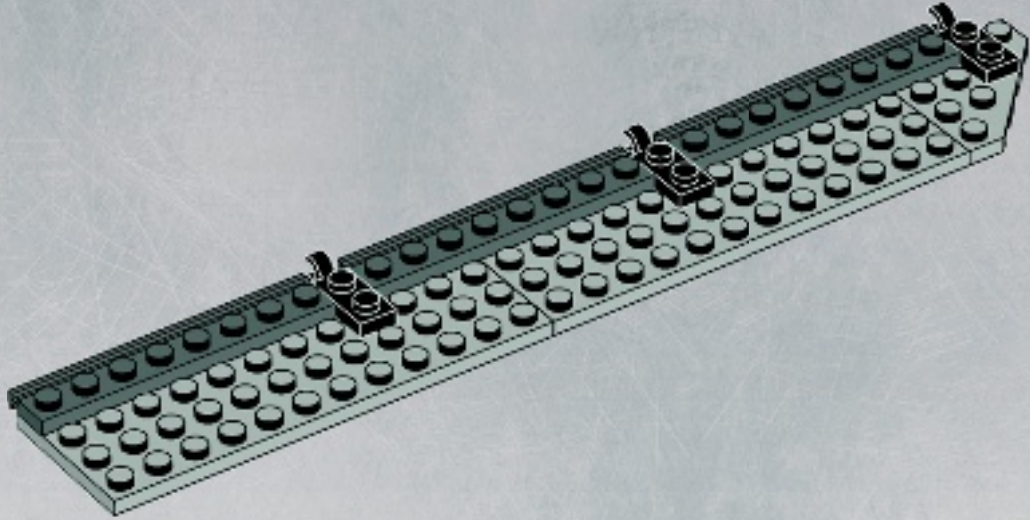

3

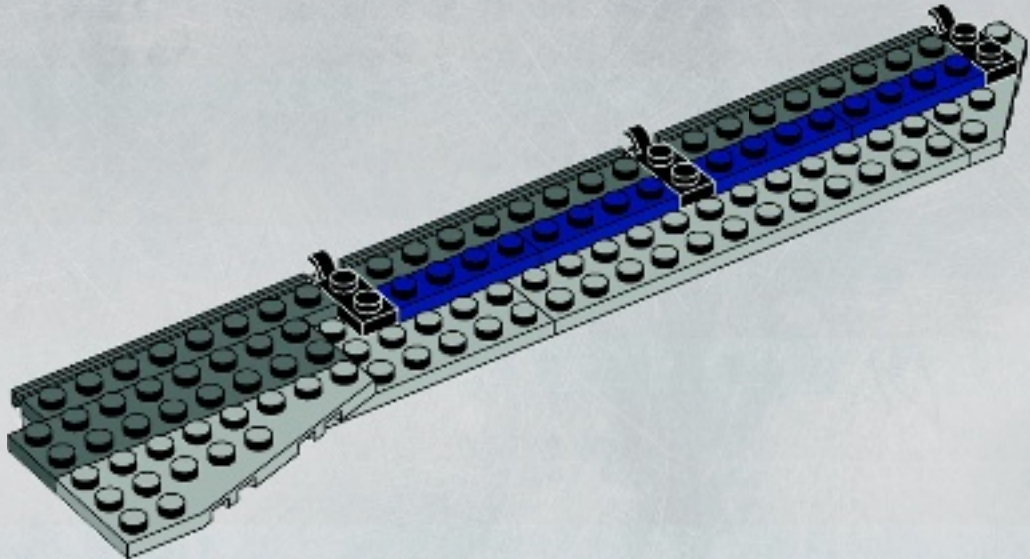

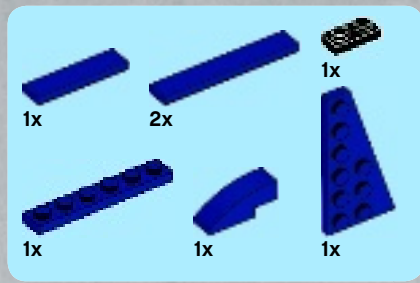

4

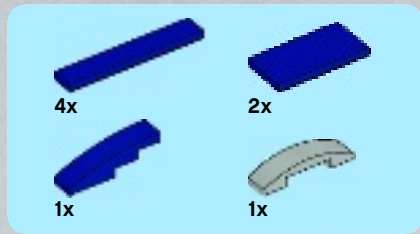
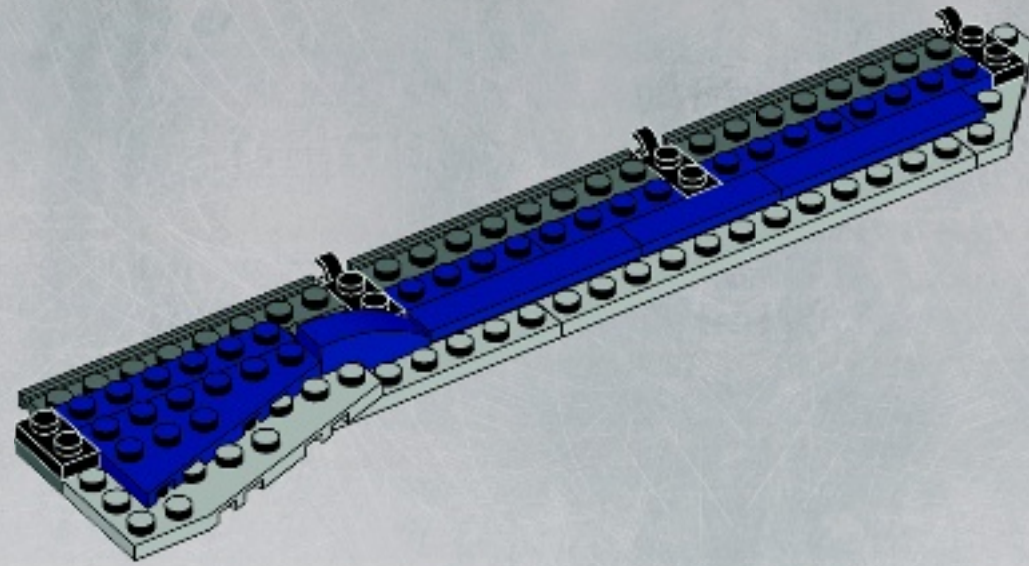

5

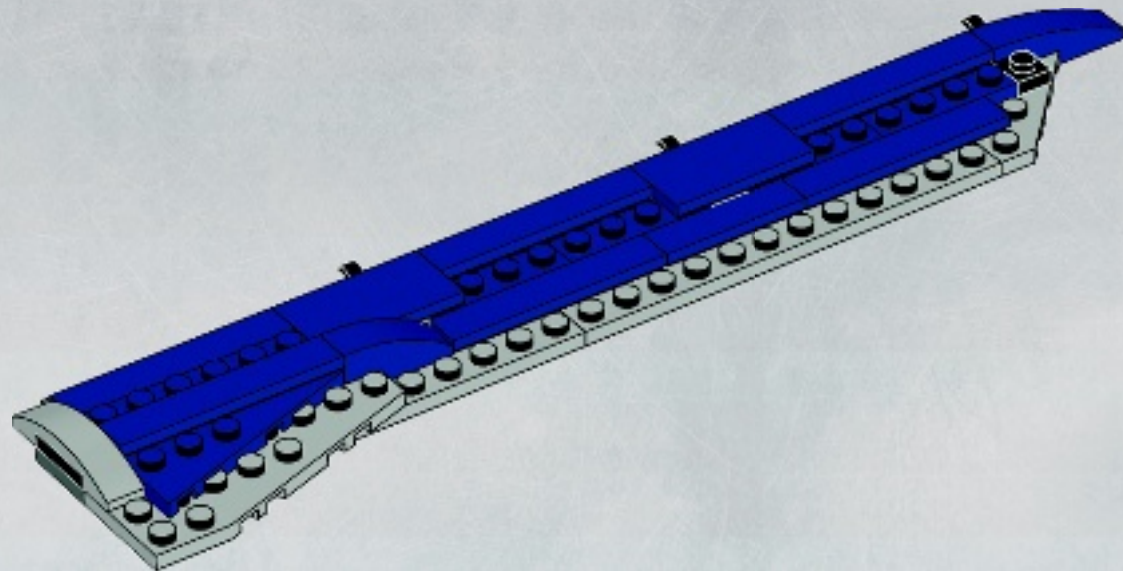



2x

6

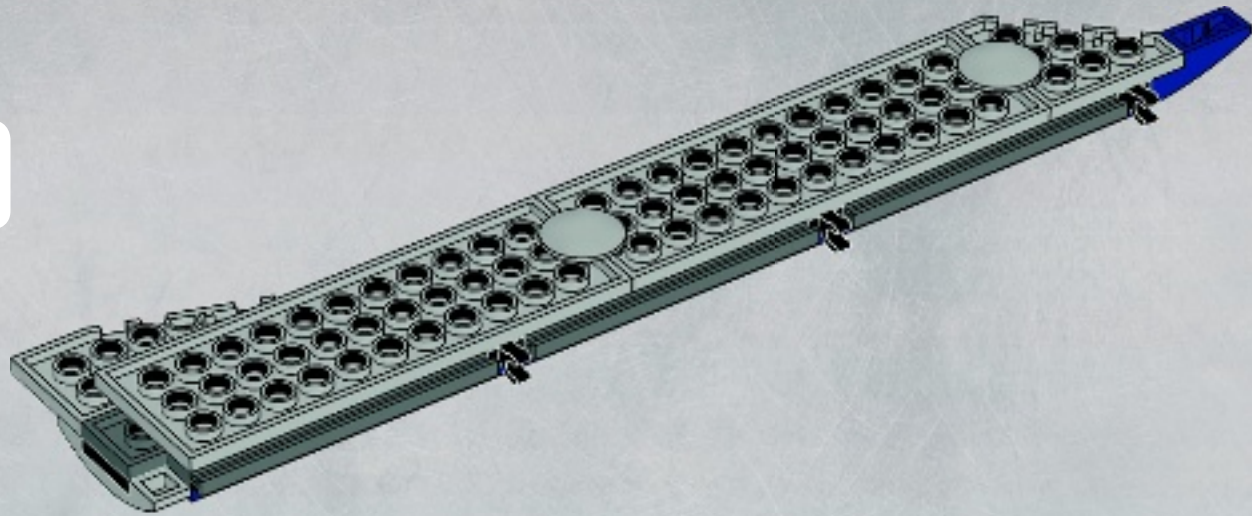

80

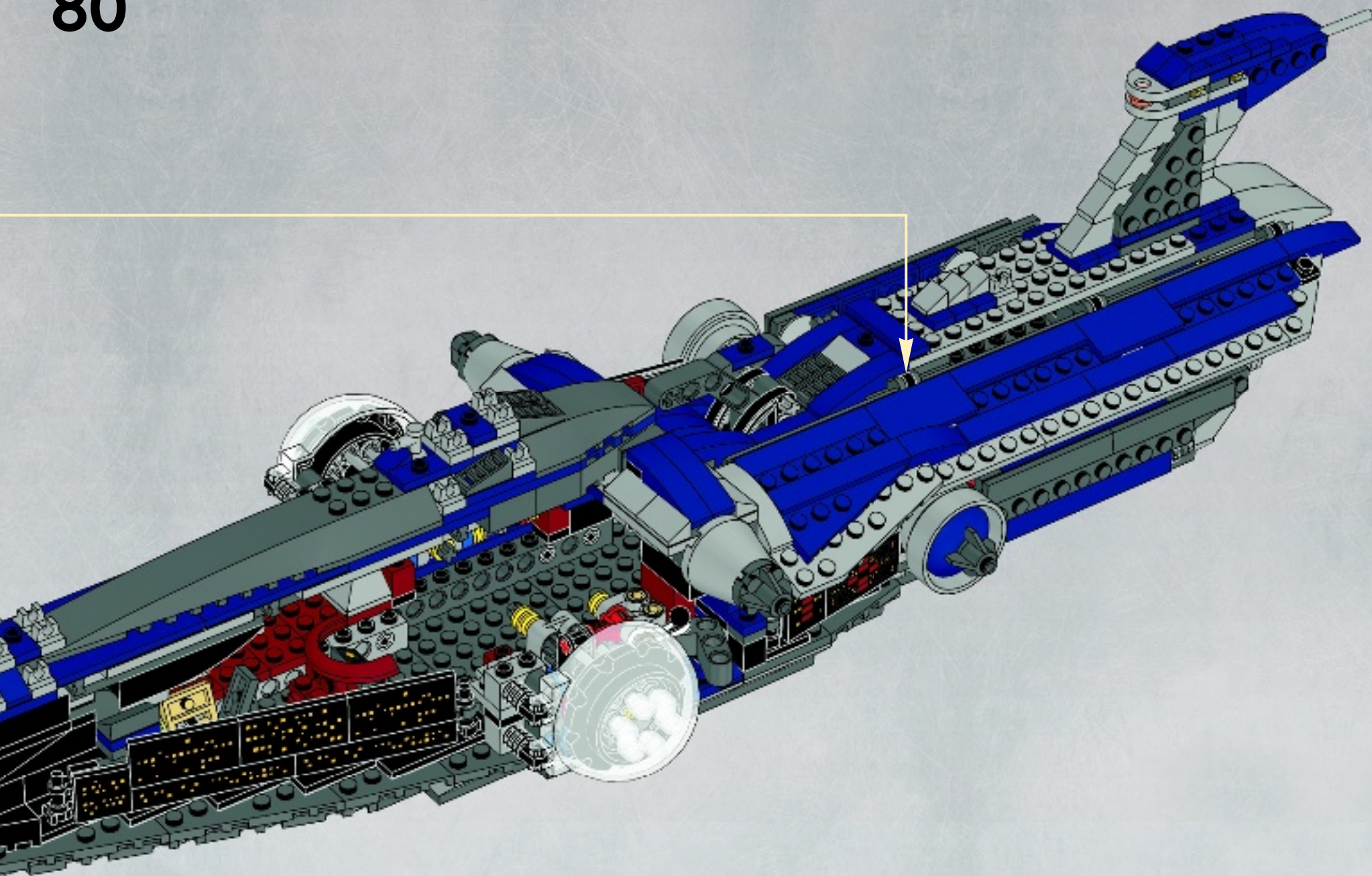

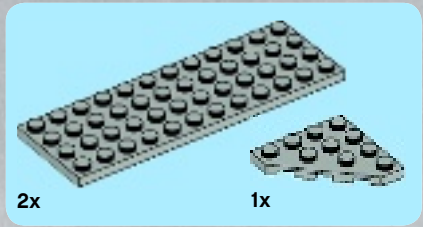

1

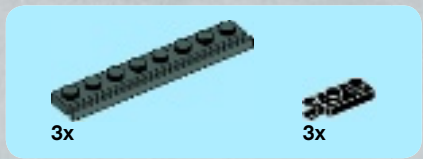
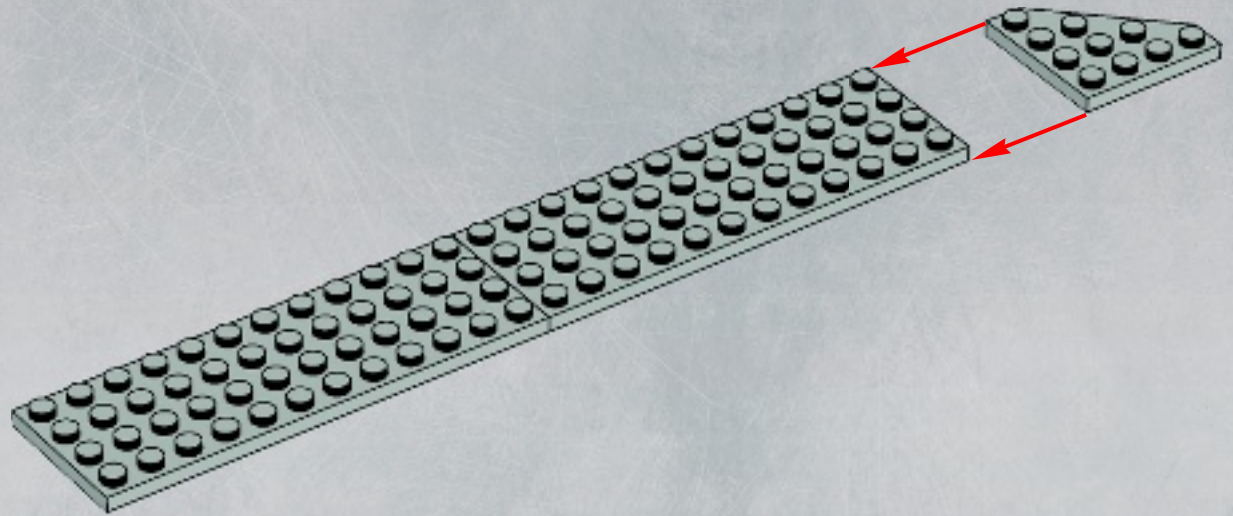

2

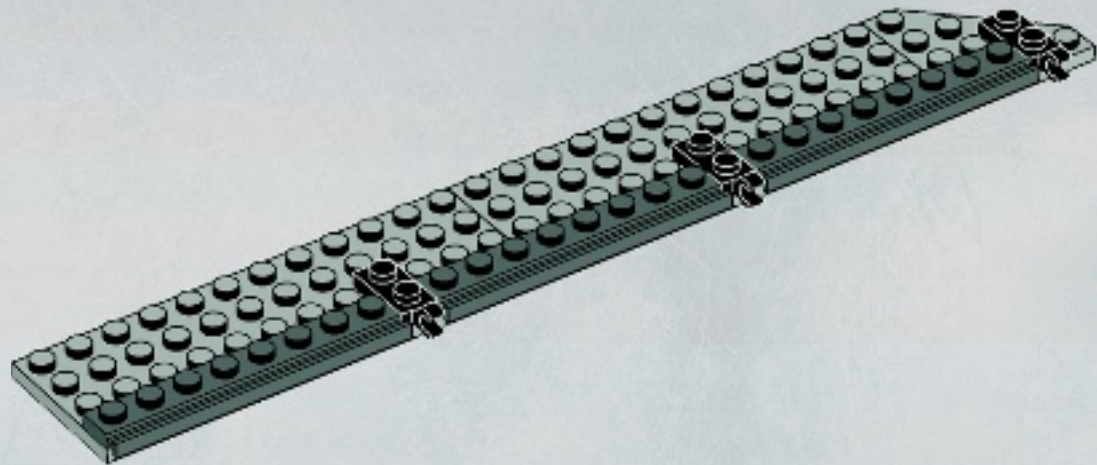

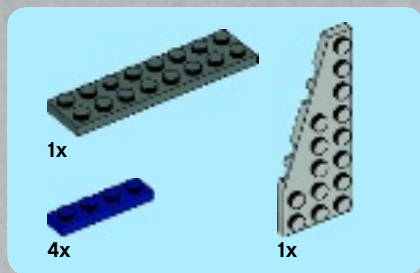

3

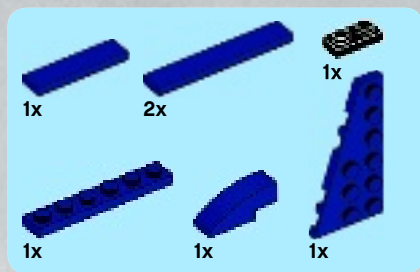
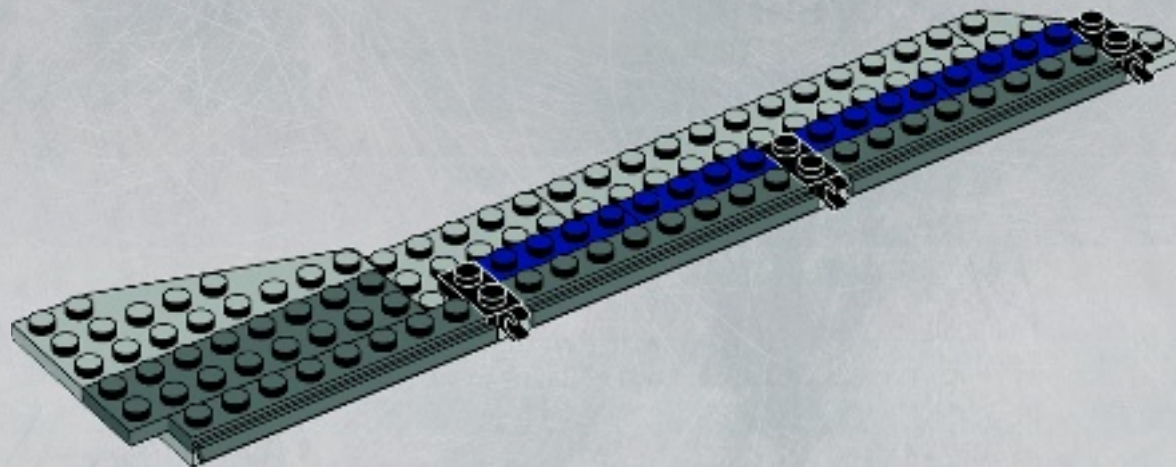

4

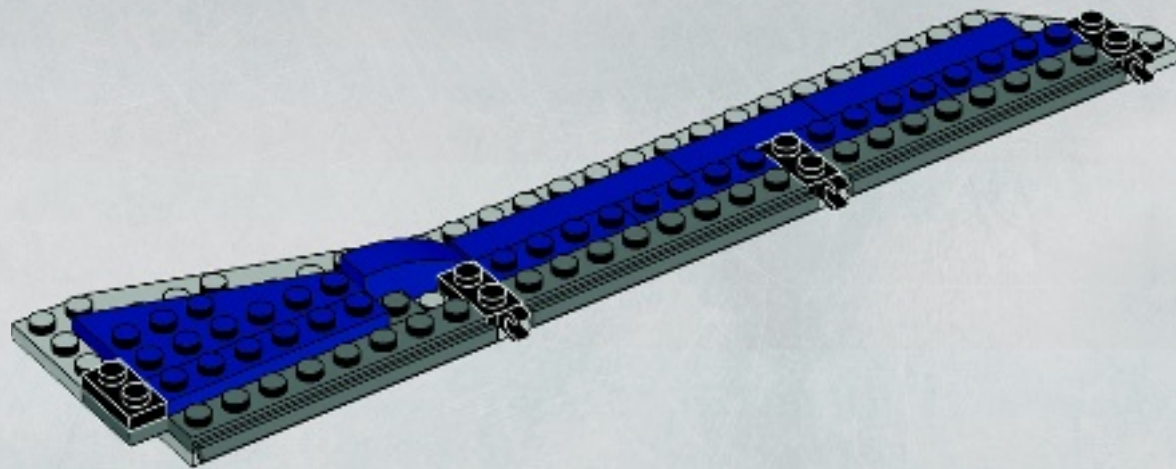

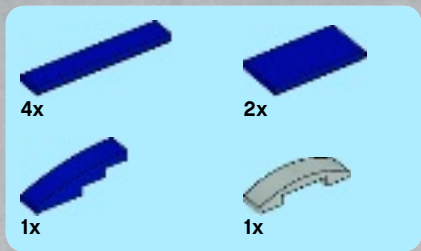

5

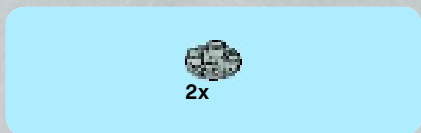
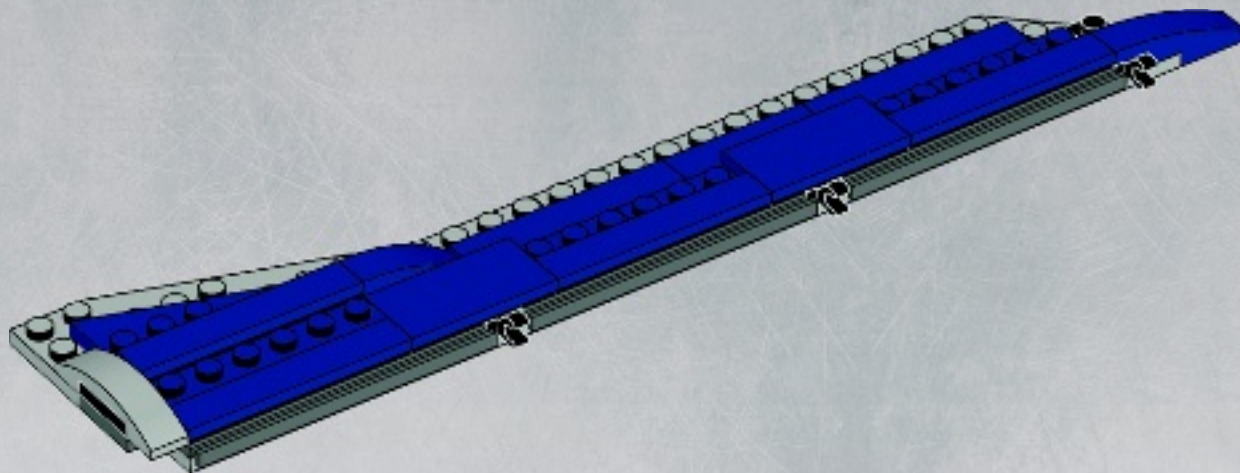

6

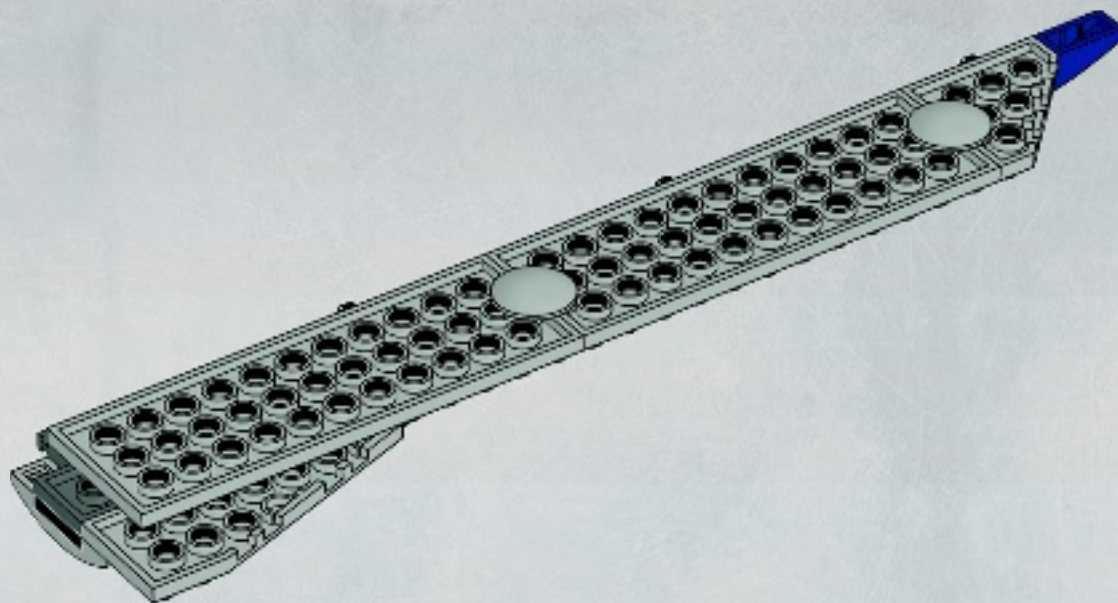

81

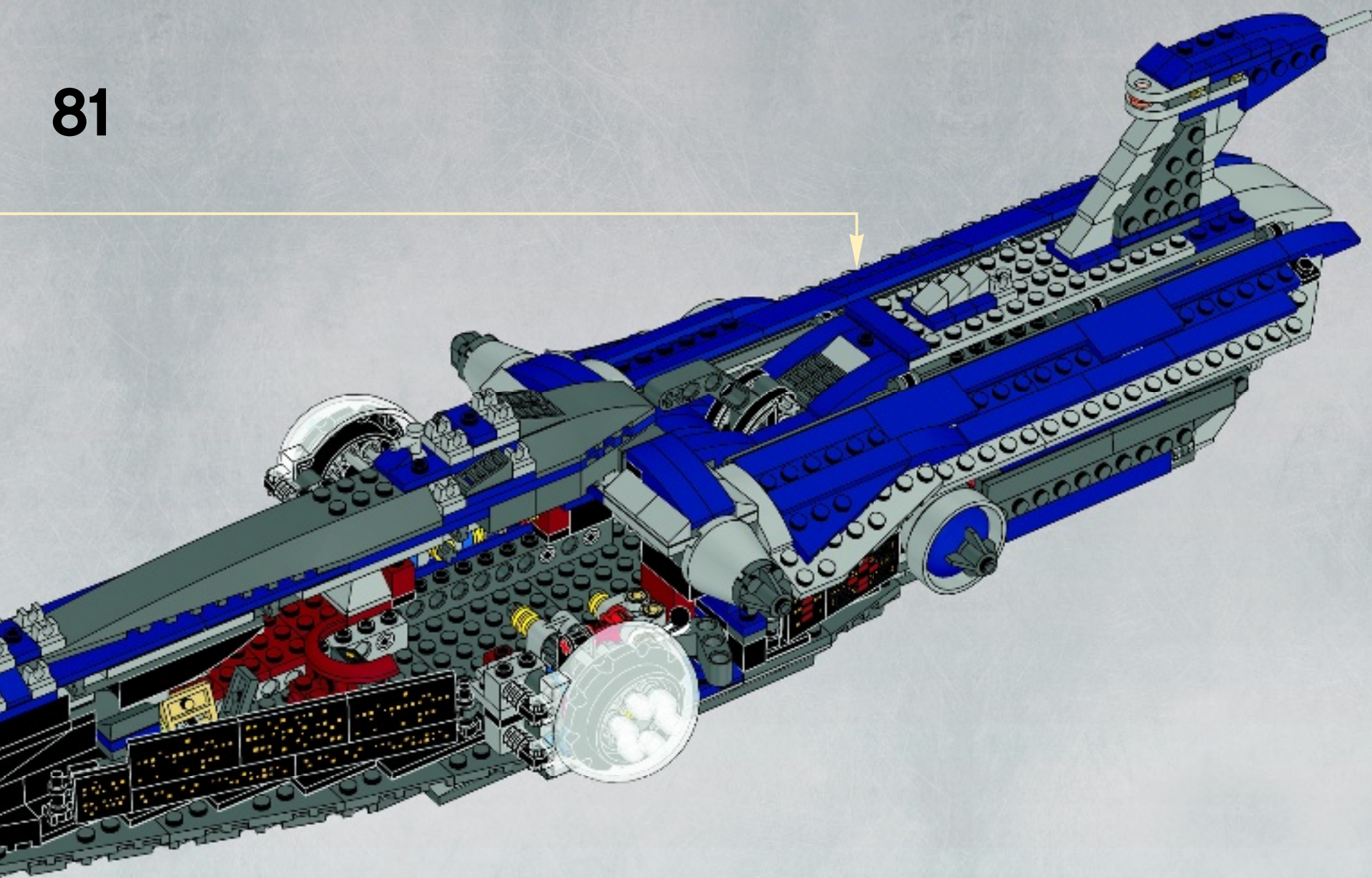

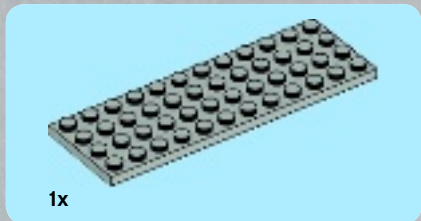
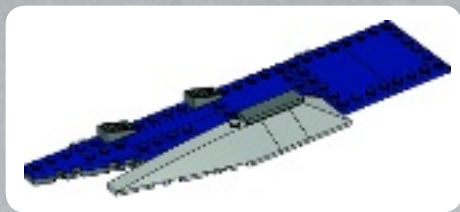

1x

1

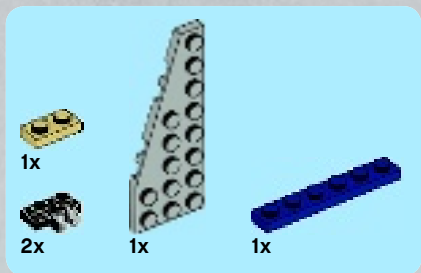
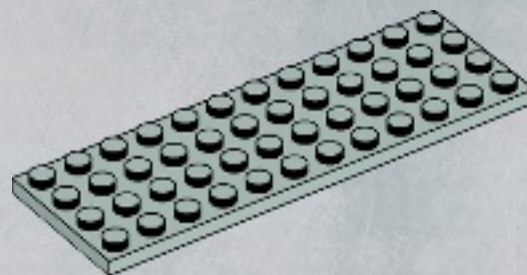

1x

2x

1x

1x

2

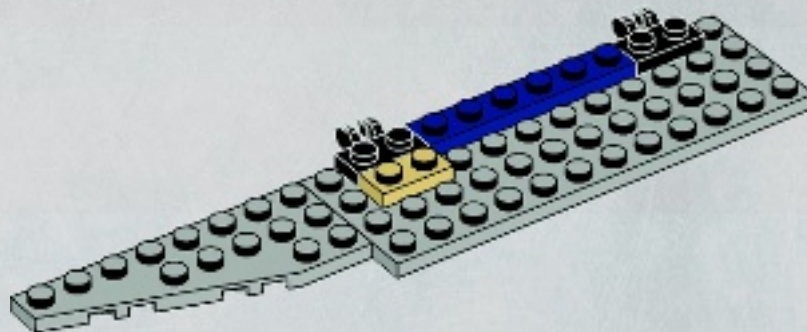



3

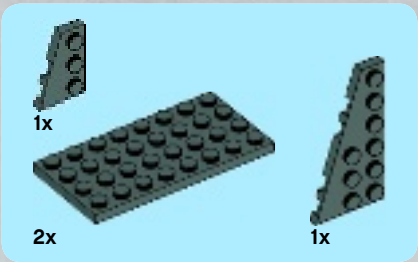
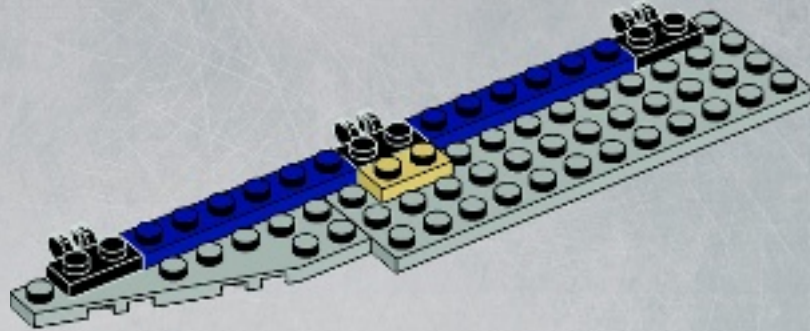

4

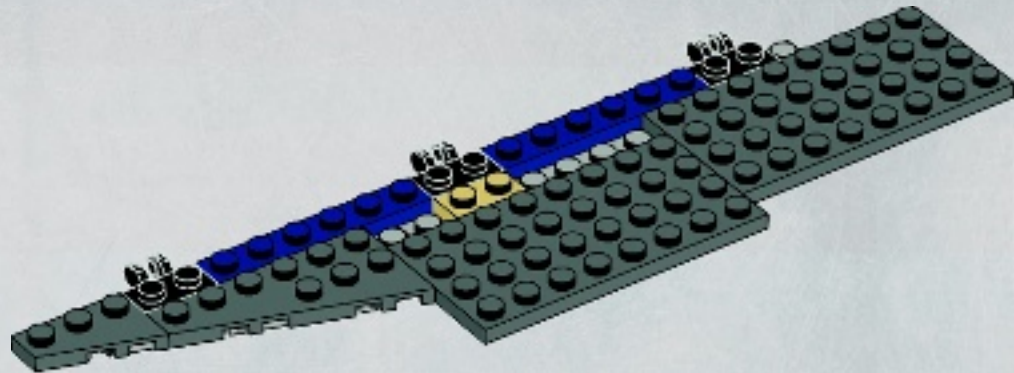

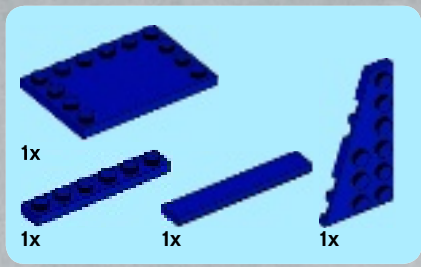

5

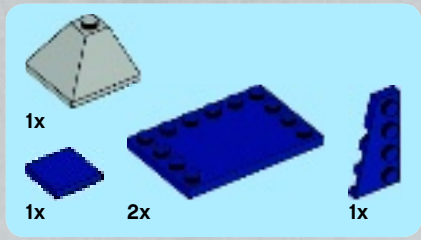
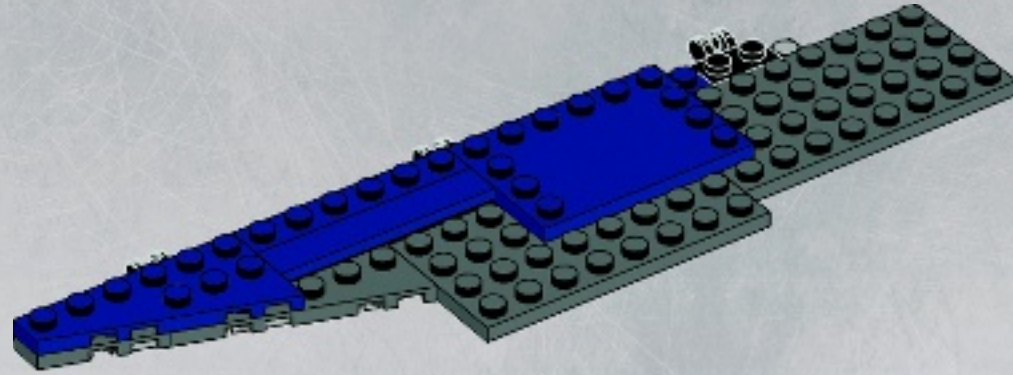

6

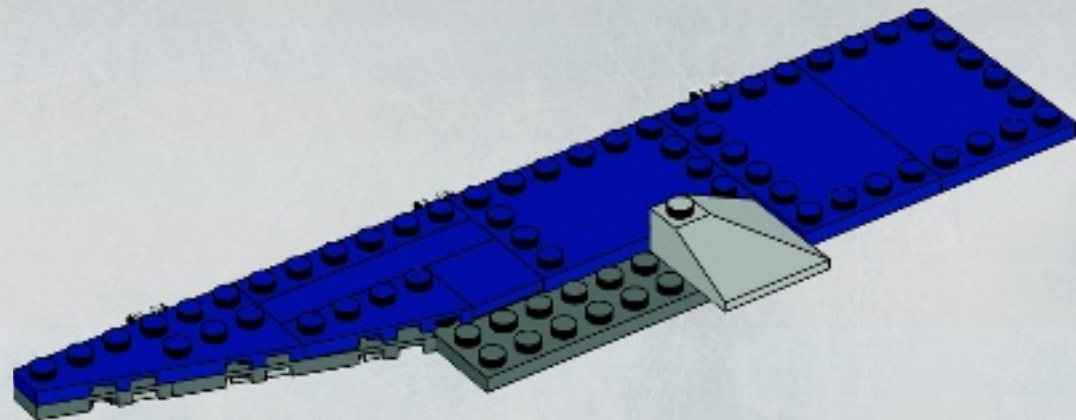

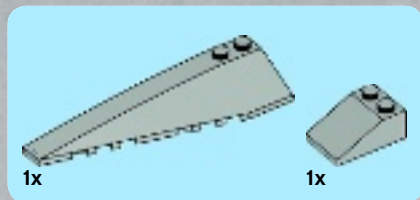

7

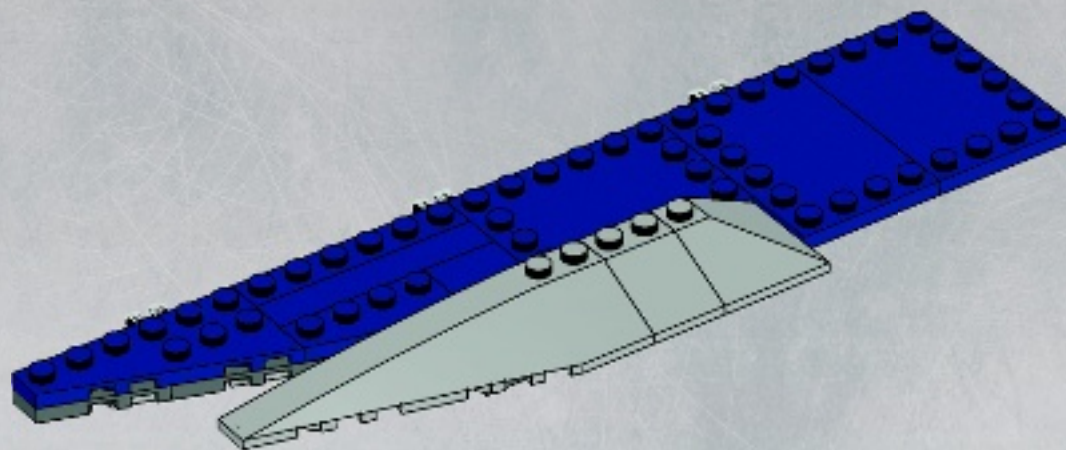

8

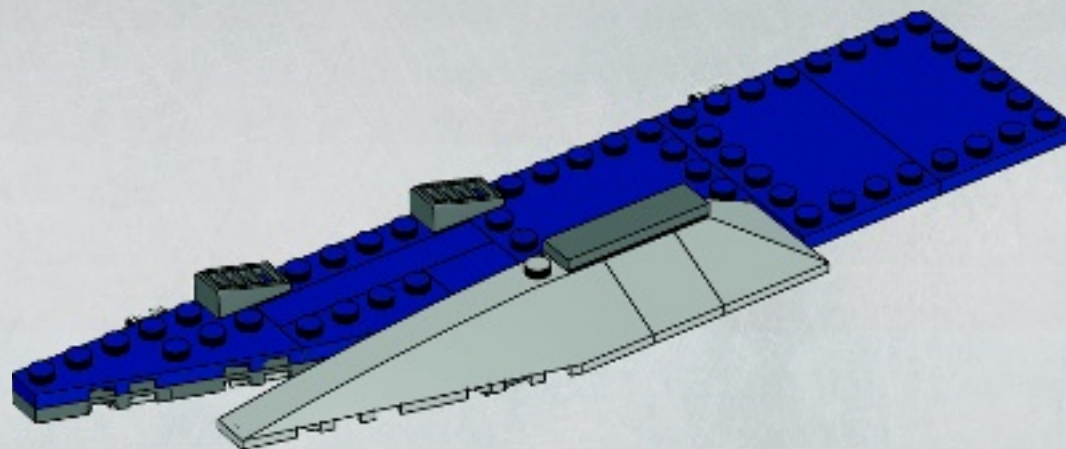

82

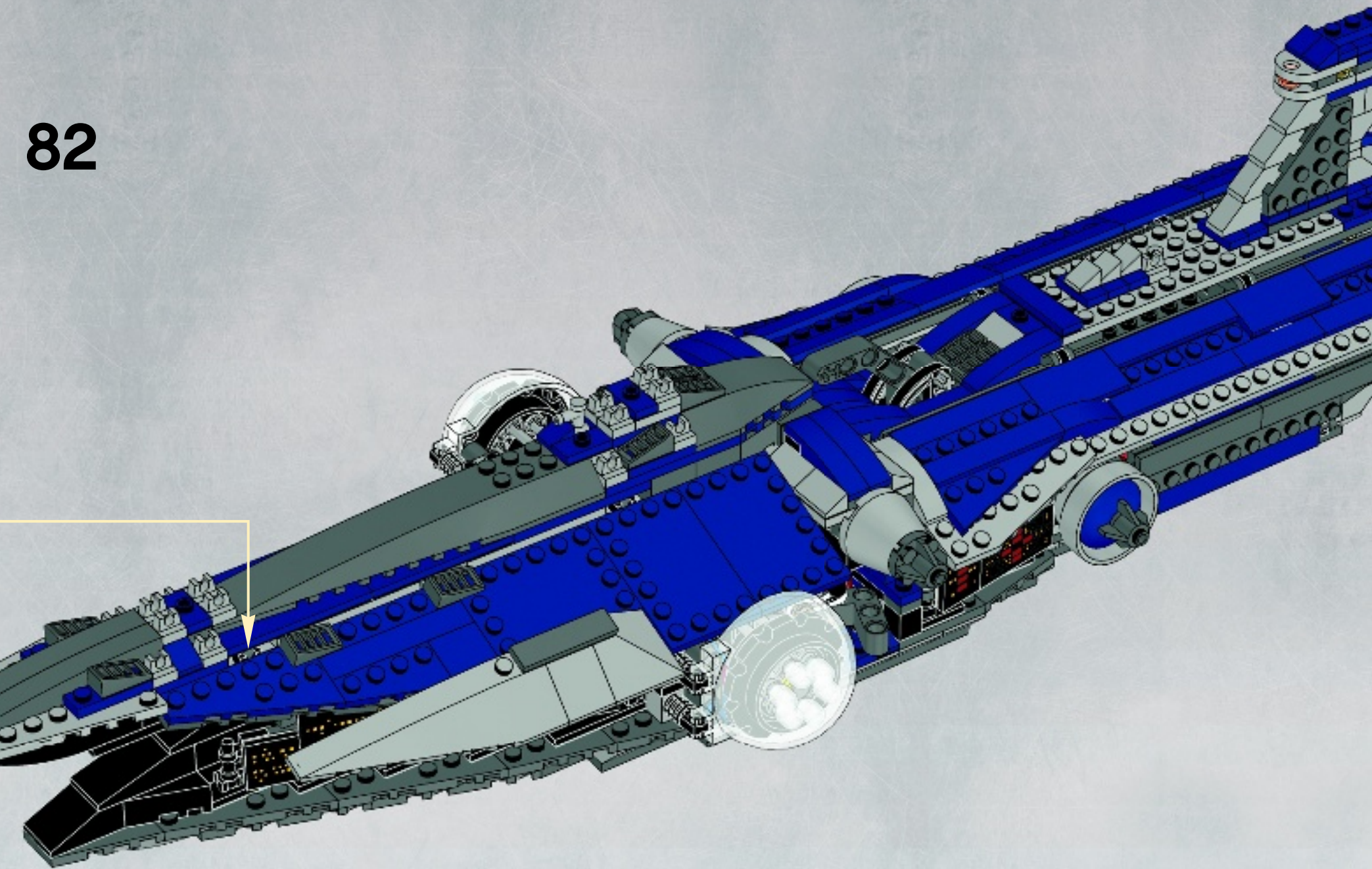

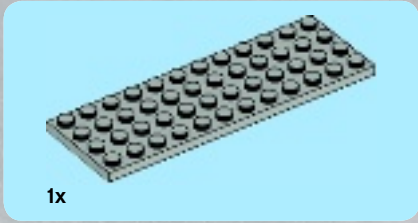
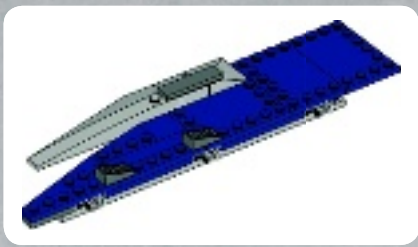

1x

1

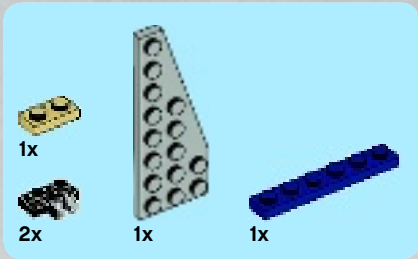
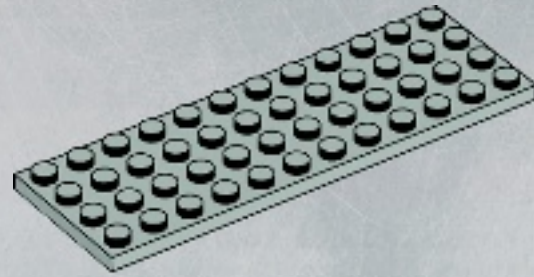

1x

2x

1x

1x

2

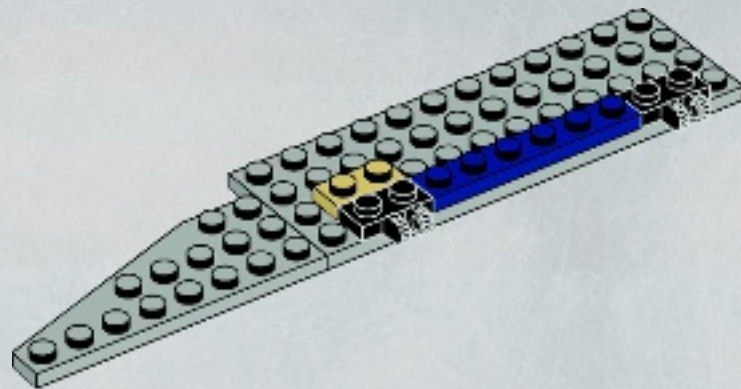



3

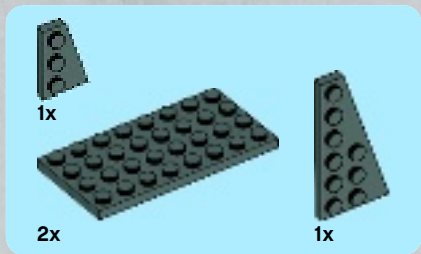
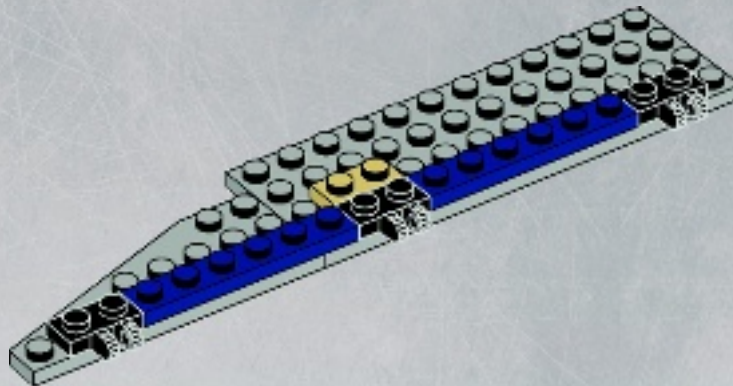

4

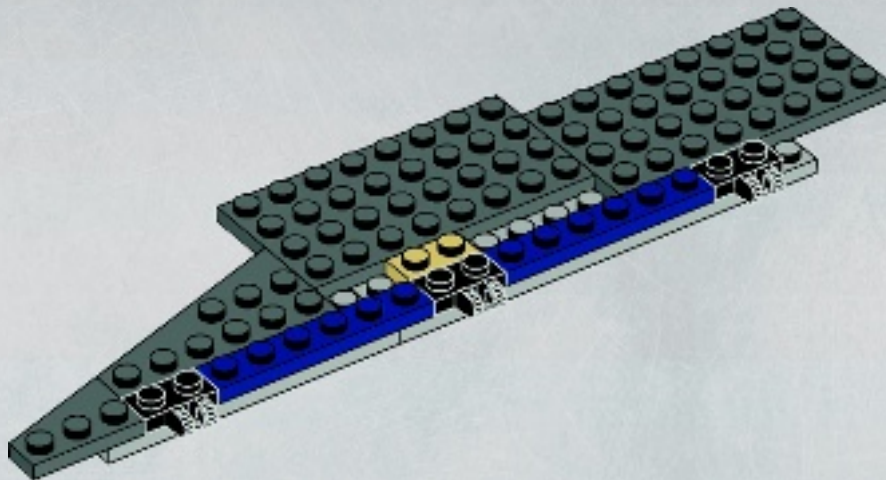

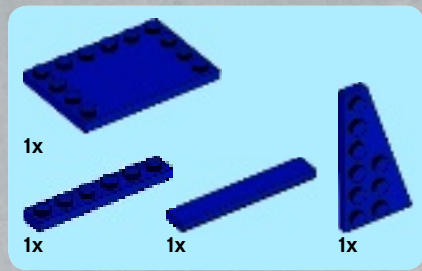

5

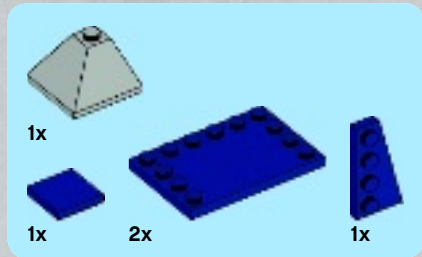
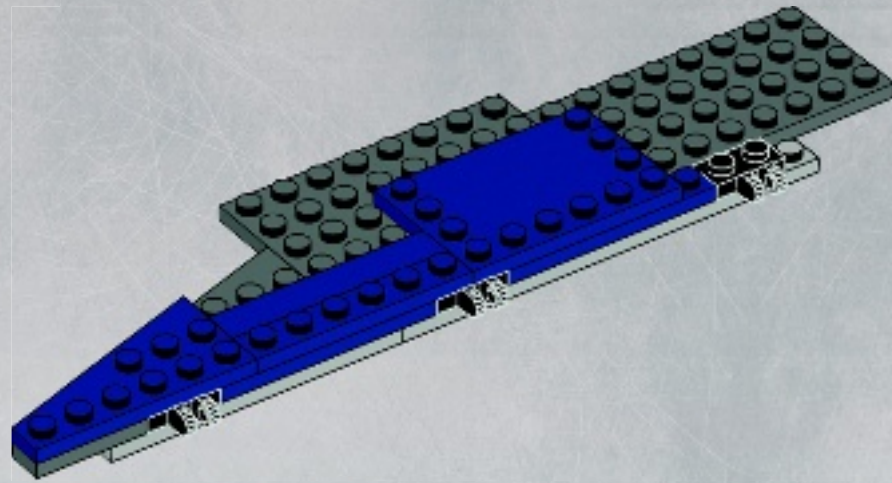

6

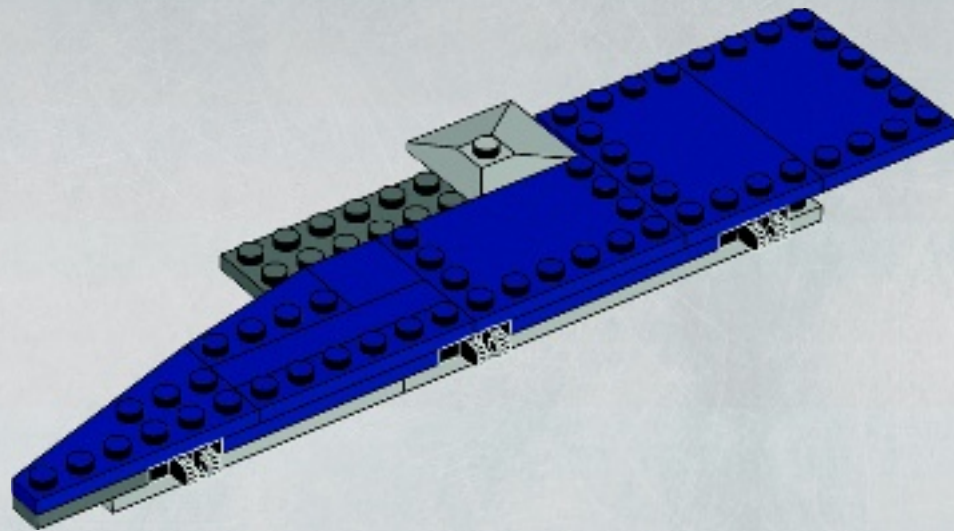

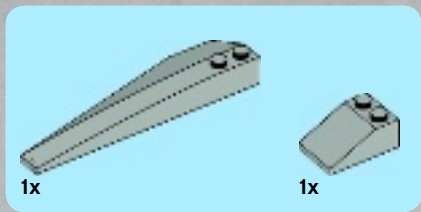

7

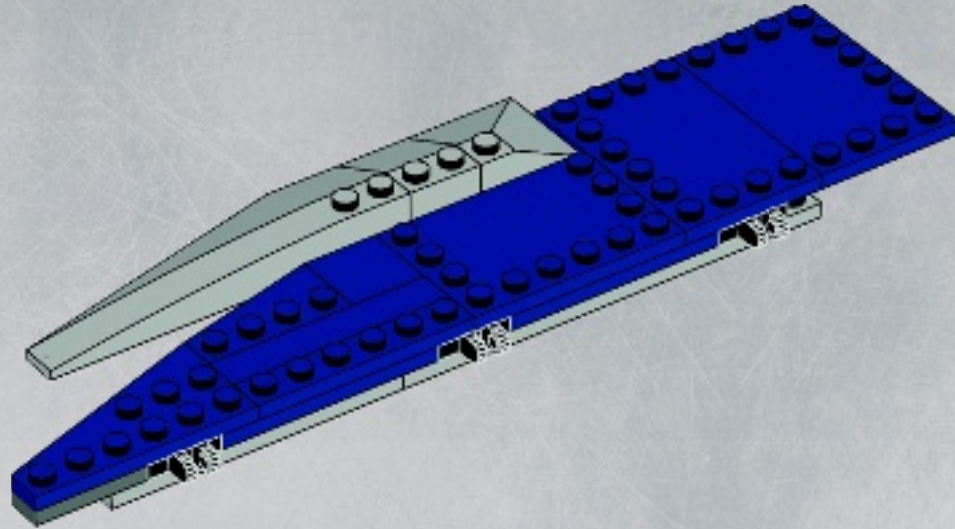

8

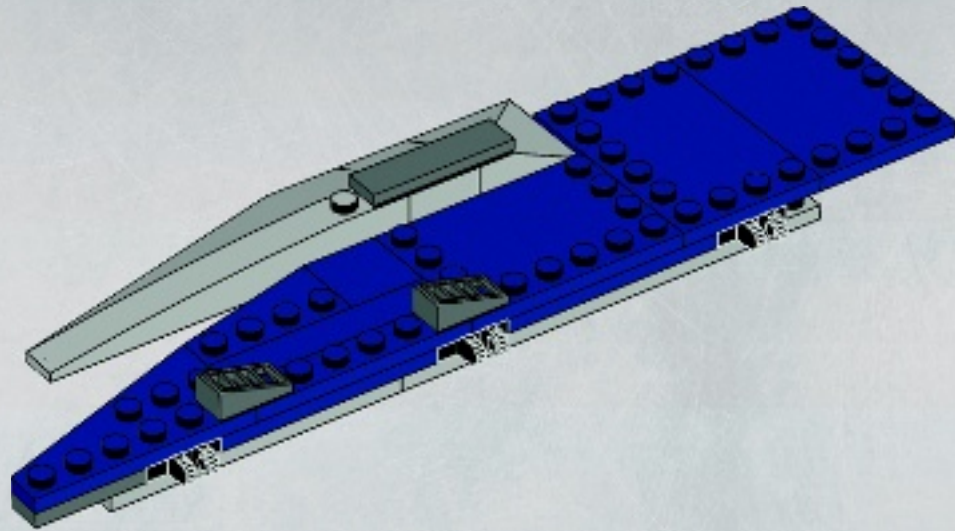

83



- 2x 4544140
- 1x 4113916
- 1x 4141533
- 1x 4213568
- 2x 4113917
- 3x 4217562
- 4x 4161734
- 2x 4508093
- 1x 4545336
- 2x 4262529
- 1x 4262538
- 2x 6019837
- 2x 4261885
- 1x 6006066
- 1x 6006068
- 4x 4514554
- 4x 4142865
- 4x 4118897
- 4x 4107829
- 14x 4143005
- 6x 4206482
- 13x 4514553
- 16x 4239601
- 4x 300226
- 2x 300126
- 4x 4533771
- 2x 4118624
- 1x 4253815
- 1x 4526931
- 1x 4527766
- 20x 654126
- 8x 370026
- 1x 329826
- 2x 4185583
- 6x 4160409
- 19x 302326
- 8x 371026
- 2x 379526
- 4x 4517925
- 6x 4515340
- 6x 4140588
- 6x 4535739
- 6x 306826
- 1x 4258354
- 12x 243126
- 8x 4560182
- 4x 663626
- 2x 9339
- 1x 4545112
- 1x 4521072
- 1x 452226
- 1x 400626
- 1x 4609050
- 2x 4498713
- 1x 4584126
- 4x 4159335
- 2x 4140430
- 2x 4121667
- 2x 4505842
- 2x 4582792
- 2x 4184169
- 34x 4121715
- 24x 4526982
- 6x 4140801
- 2x 370526
- 3x 370626
- 2x 370726
- 2x 4624369
- 2x 4626400
- 1x 4124108
- 4x 4497943
- 12x 6006124
- 3x 4124073
- 4x 3005744
- 3x 3005747
- 2x 3006349
- 1x 4654448
- 1x 4524098
- 2x 4566927
- 2x 4615996
- 4 2x 370526
- 6 2x 370526
- 8 2x 370526
- 9x 4504374
- 2x 4153653
- 6x 4540280
- 11x 4588293
- 24x 4186627
- 4x 4528482
- 13x 4177735
- 23x 4530028
- 8x 4502089
- 15x 4508313
- 8x 4264890
- 2x 4205004
- 5x 4568393
- 4x 4569836
- 18x 4252437
- 2x 4507080
- 3x 4529954
- 3x 4502091
- 2x 4667979
- 2x 6006628
- 2x 6006630
- 4x 4539102
- 6x 4539104
- 10x 4539092
- 6x 4539059
- 10x 4531415
- 2x 4609925
- 10x 4539082
- 4x 4539063
- 13x 4541510
- 2x 4539062
- 2x 4618986
- 2x 4550169
- 2x 4539083
- 1x 6060645
- 1x 4621617
- 16x 4222960
- 1x 4523794
- 1x 4227505
- 3x 4211389
- 1x 4211502
- 2x 4497653
- 6x 4211541
- 4x 4211374
- 3x 4521921
- 19x 4568637
- 7x 4211614
- 22x 4211437
- 2x 4515374
- 2x 42126250
- 44x 4211436
- 2x 4211421
- 2x 4211570
- 2x 4186667
- 2x 4622803
- 4x 4622742
- 1x 4539887
- 1x 4224592
- 1x 4180464
- 1x 4505088
- 1x 4505087
- 5x 4211398
- 23x 4211397
- 3x 4243797
- 2x 4211452
- 4x 4211425
- 2x 4211404
- 1x 4514846
- 3x 4211360
- 6x 4211401



2x
4539880

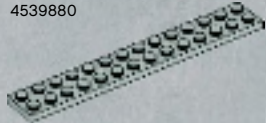

2x
4662161



19x
4211369



3x
4211414



10x
4211413



2x
4558169



2x
4211419



1x
4667166



12x
4278273

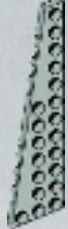

1x
4208988



2x
4258273



4x
4211889

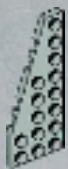

2x
4258275



1x
4209006



2x
4160560



2x
4211536



1x
4211503



1x
4211628



2x
4211473



2x
4511007



12x
4520320



5x
4211651



2x
6004888



2x
4211622



8x
4211758



1x
4211815



2x
4211639



1x
4626931



2x
6000606



4x
4211109



3x
4211085



4x
4210935



1x
4287972



1x
4287973



6x
4211137



4x
4567887



14x
4540386



4x
4212352



4x
4210797



2x
4658974



8x
4210797



2x
4579241



1x
4180486



1x
4260406



2x
4211063



14x
4211065



5x
4210997



5x
4210997



6x
4257526



6x
4211061



3x
4210678



2x
4210753



4x
4211122



2x
4211067



2x
4210706



2x
4210720



4x
4587212



6x
4210892



11x
4521187



2x
4211053



4x
4210651



6x
4210967



2x
4210872



2x
4210869



5x
4210782



5x
4210788



2x
4211042



5x
4290149



5x
4290150



2x
4210728



1x
4520307



2x
6019839



2x
6019836



1x
6019834



1x
6019833



2x
4210751



1x
4495931



1x
4210668



1x
4210749



2x
4560177



2x
4499858



4x
4514559



1x
4521066



1x
4541613



1x
6005953



1x
4541966



5x
4548731

Customer Service
Kundenservice
Service Consommateurs
Servicio Al Consumidor

www.lego.com/service or dial



: 00800 5346 5555

: 1-800-422-5346

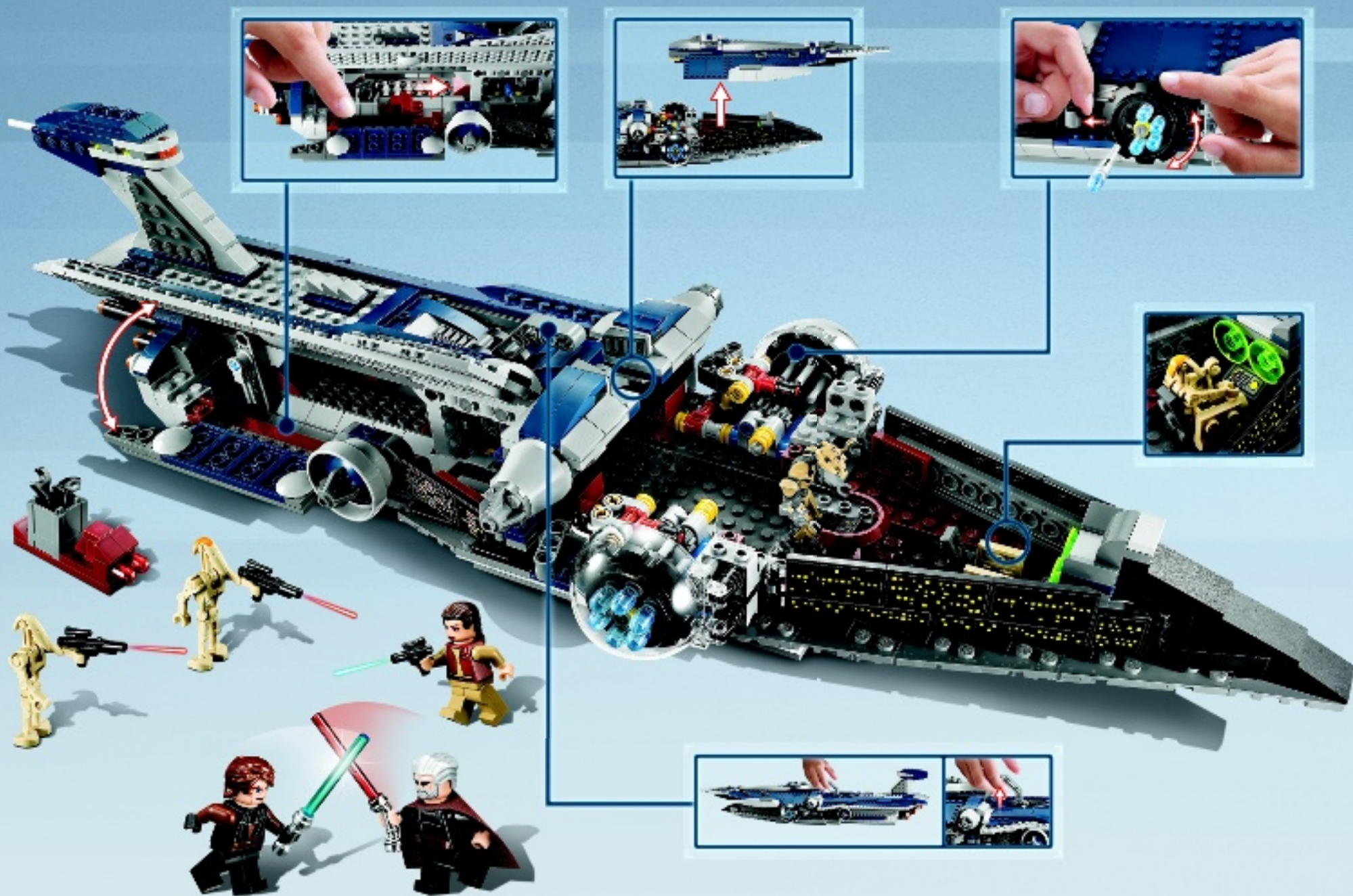

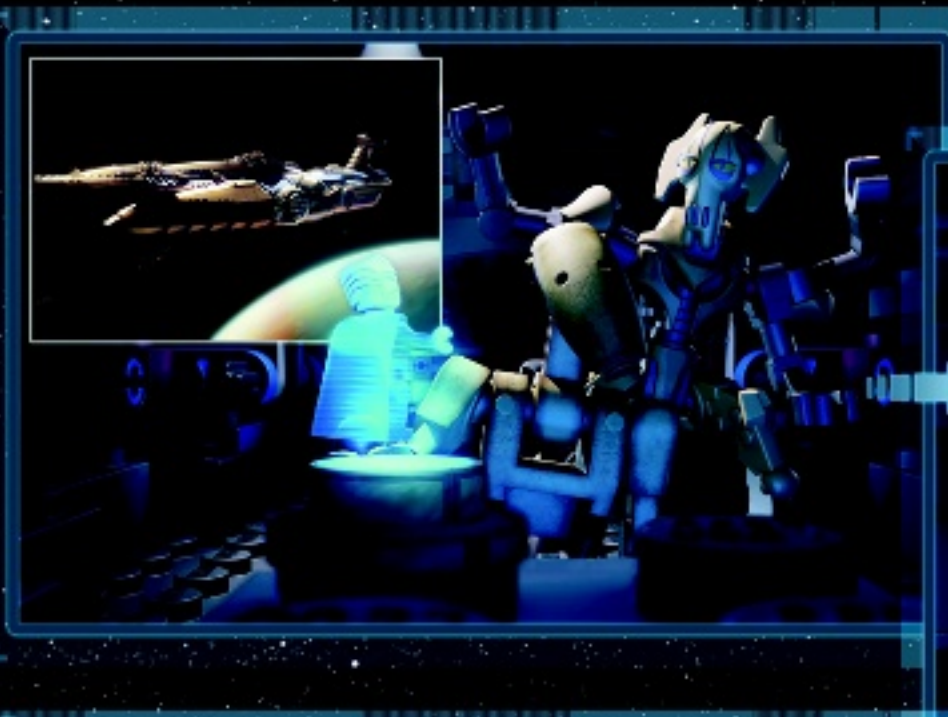



9496



9498



9497



9499



9500



9515



9516



9496



9496



9496



9496



9497



9497



9497



9498



9498



9498



9499



9499



9499



9499



9500



9500



9500



9515



9515



9515



9515



9515



9515



9516



9516



9516



9516



9516



9516



9516



9516



9516



9516

1



www.LEGOclub.com/Max

2



3



www.LEGOclub.com/Max



club™

FREE*! GRATIS! GRATUIT!





 starwars.LEGO.com



WIN!

Go to www.LEGOsurvey.com/product to fill out a survey for a chance to win a cool LEGO® Product. No purchase necessary. Open to all residents where not prohibited.



www.LEGO.com



www.LEGOsurvey.com/product

GEWINNE!

Nimm an der Umfrage auf www.LEGOsurvey.com/product teil und hab die Chance ein cooles LEGO® Produkt zu gewinnen! Die Teilnahme am Gewinnspiel führt zu keinerlei Kaufverpflichtungen. Teilnahme in allen nicht ausgeschlossenen Ländern möglich.

WIN!

Ga naar www.LEGOsurvey.com/product, vul een enquêteformulier in en maak kans op een cool LEGO® product. Geen aankoopverplichting. Iedereen mag deelnemen, uitgezonderd ingezetenden van landen waar een enquêteverbod geldt.

GAGNE!

Visite www.LEGOsurvey.com/product pour répondre à un questionnaire et avoir une chance de gagner un produit LEGO® très cool! Aucune obligation d'achat. Ouvert à tous les résidents des pays autorisés.

当てよう!

www.LEGOsurvey.com/product にアクセスして、アンケートにご記入ください。当選者にはレゴ製品を差し上げます。お買い上げの必要はありません。禁止されていない限り、すべての皆様にご利用いただけます。