



# STAR WARS



9516



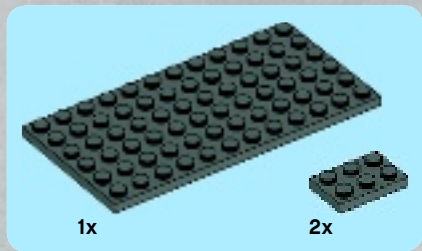
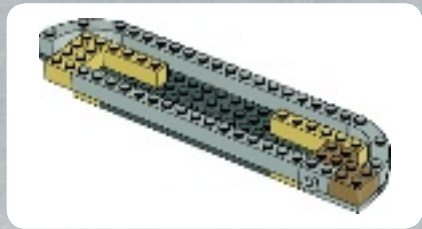
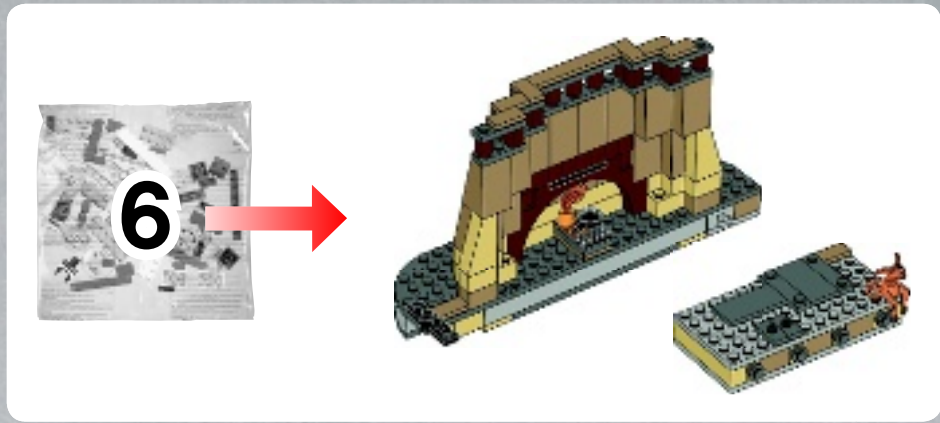

1

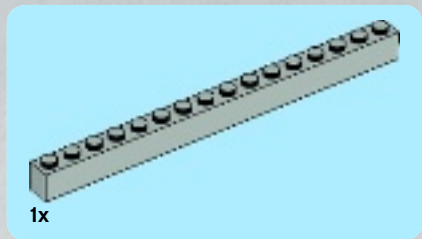
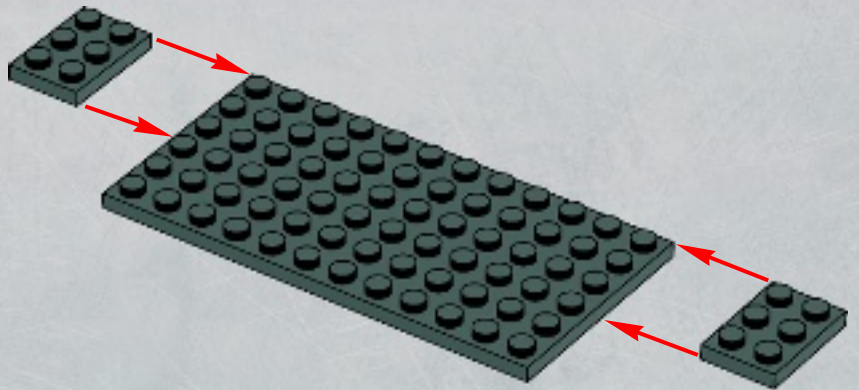

2

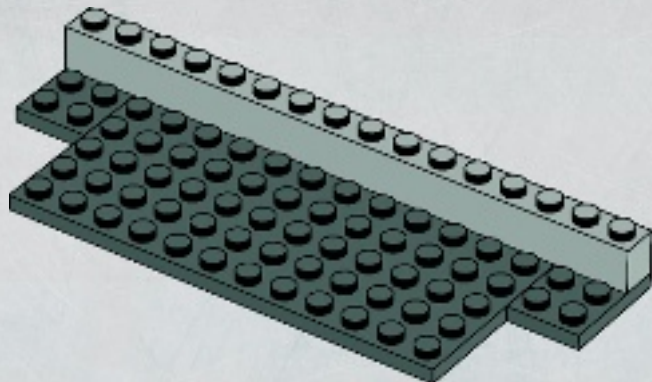



2x

3

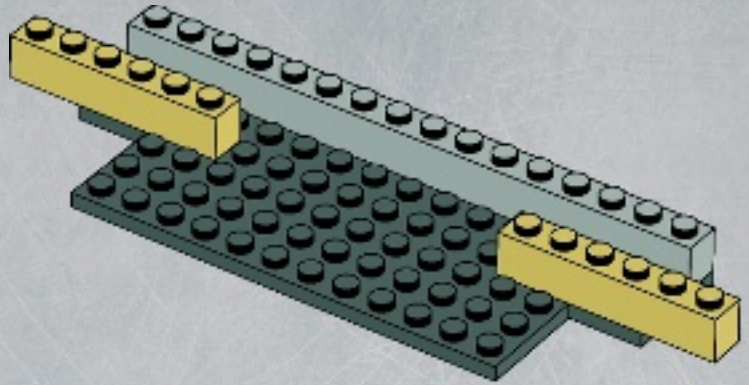

2x

4

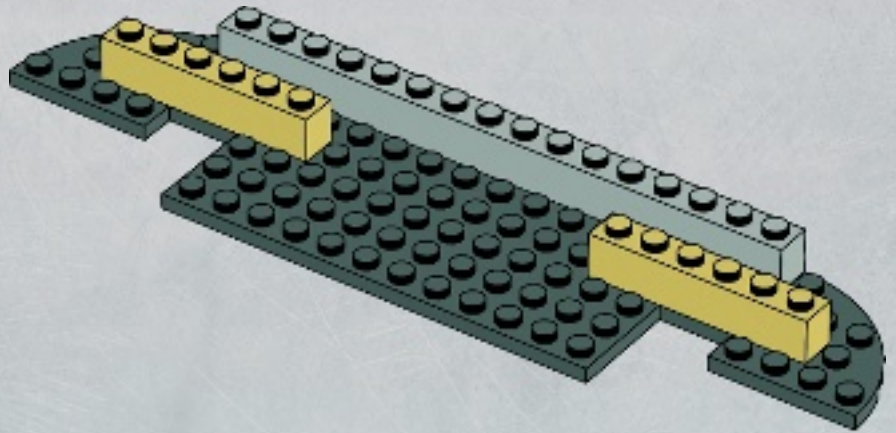

1x



2x

5

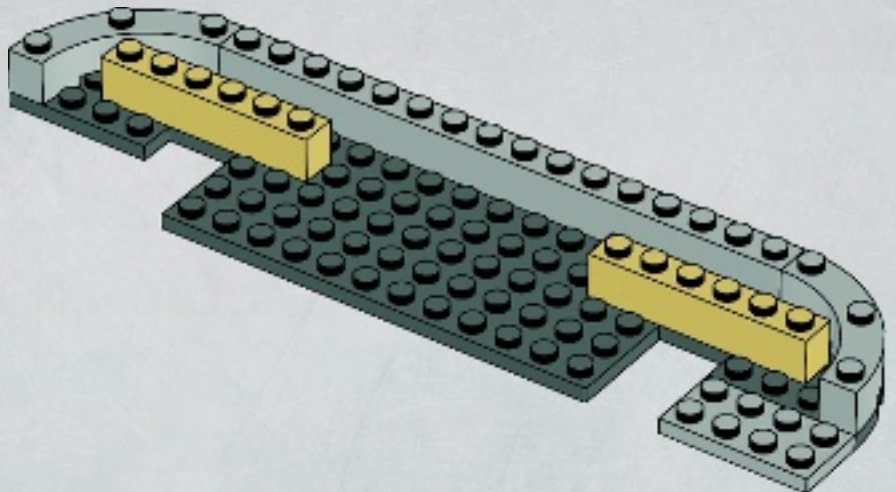



2x



1x

# 6

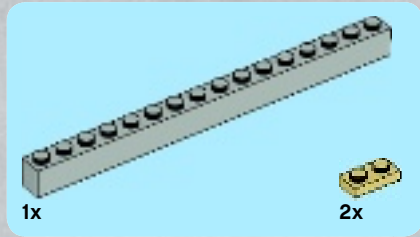
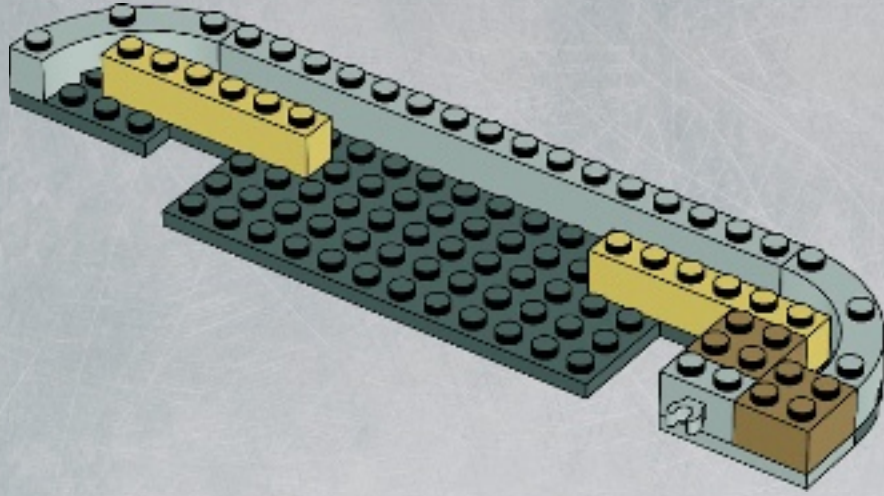

# 7

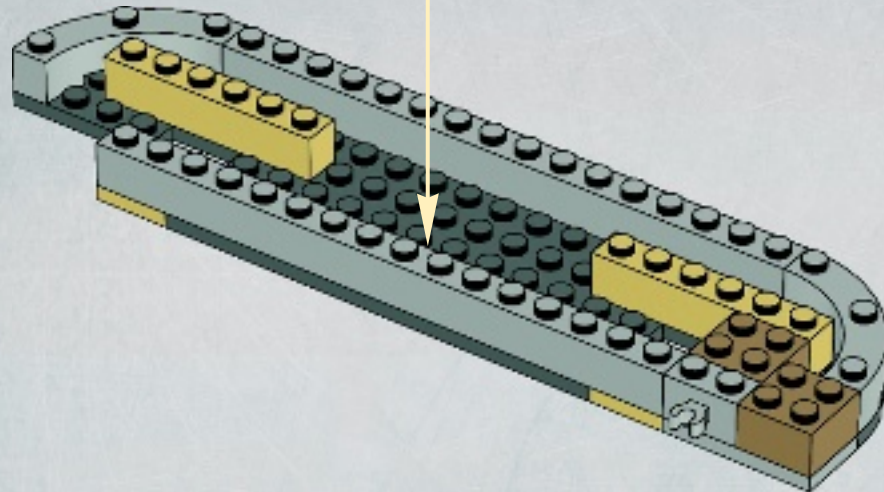
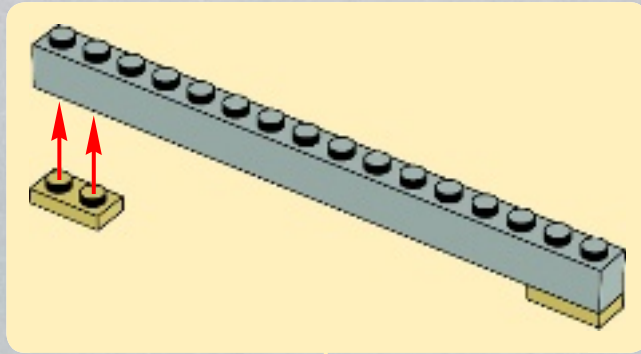



1x

8

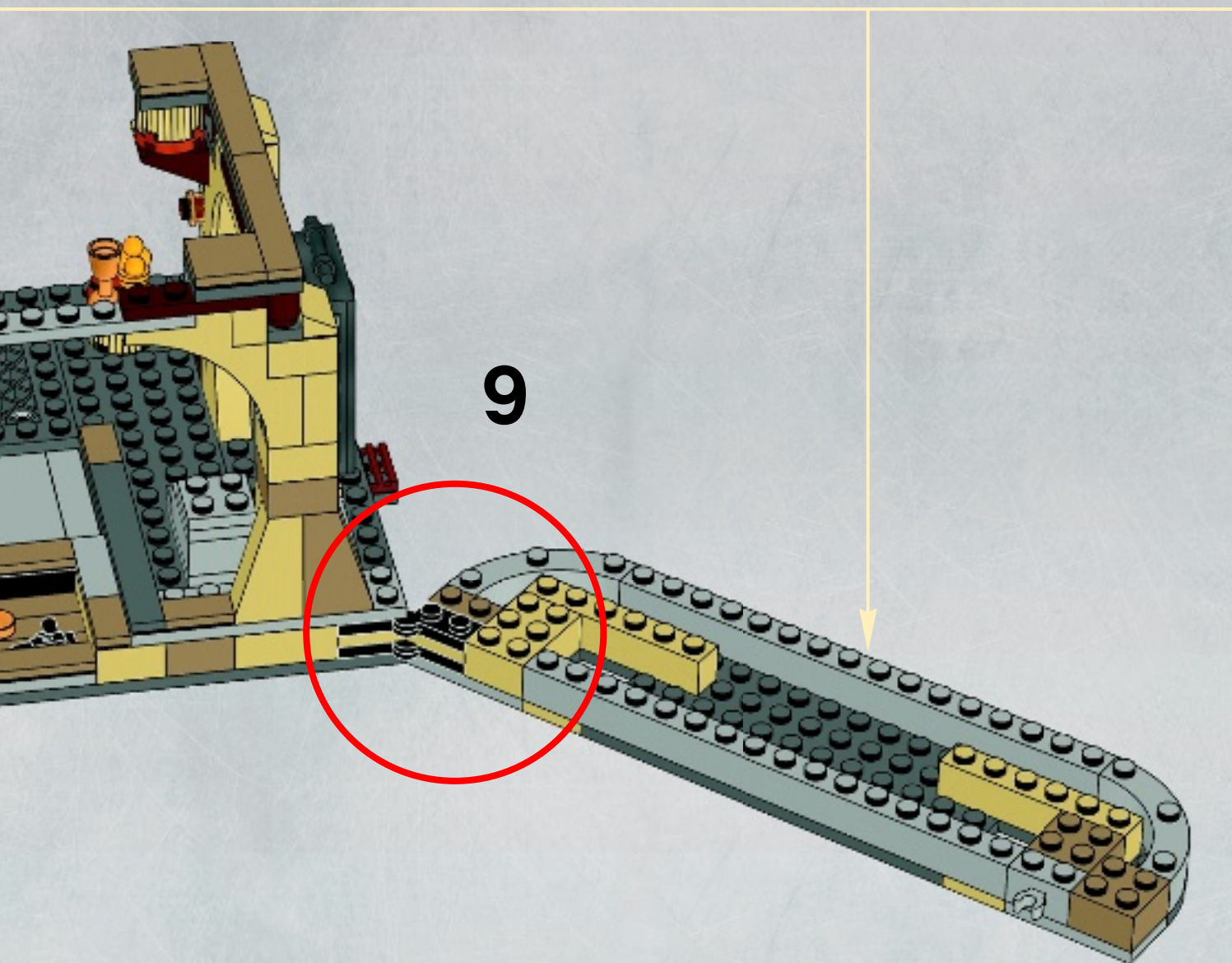
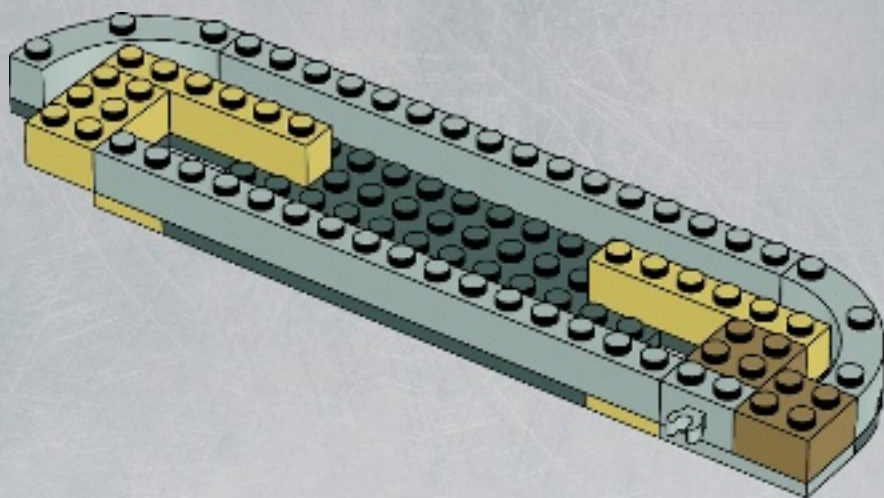

9

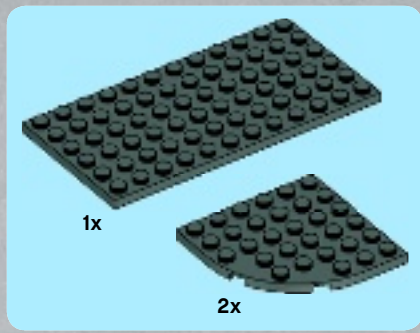

10

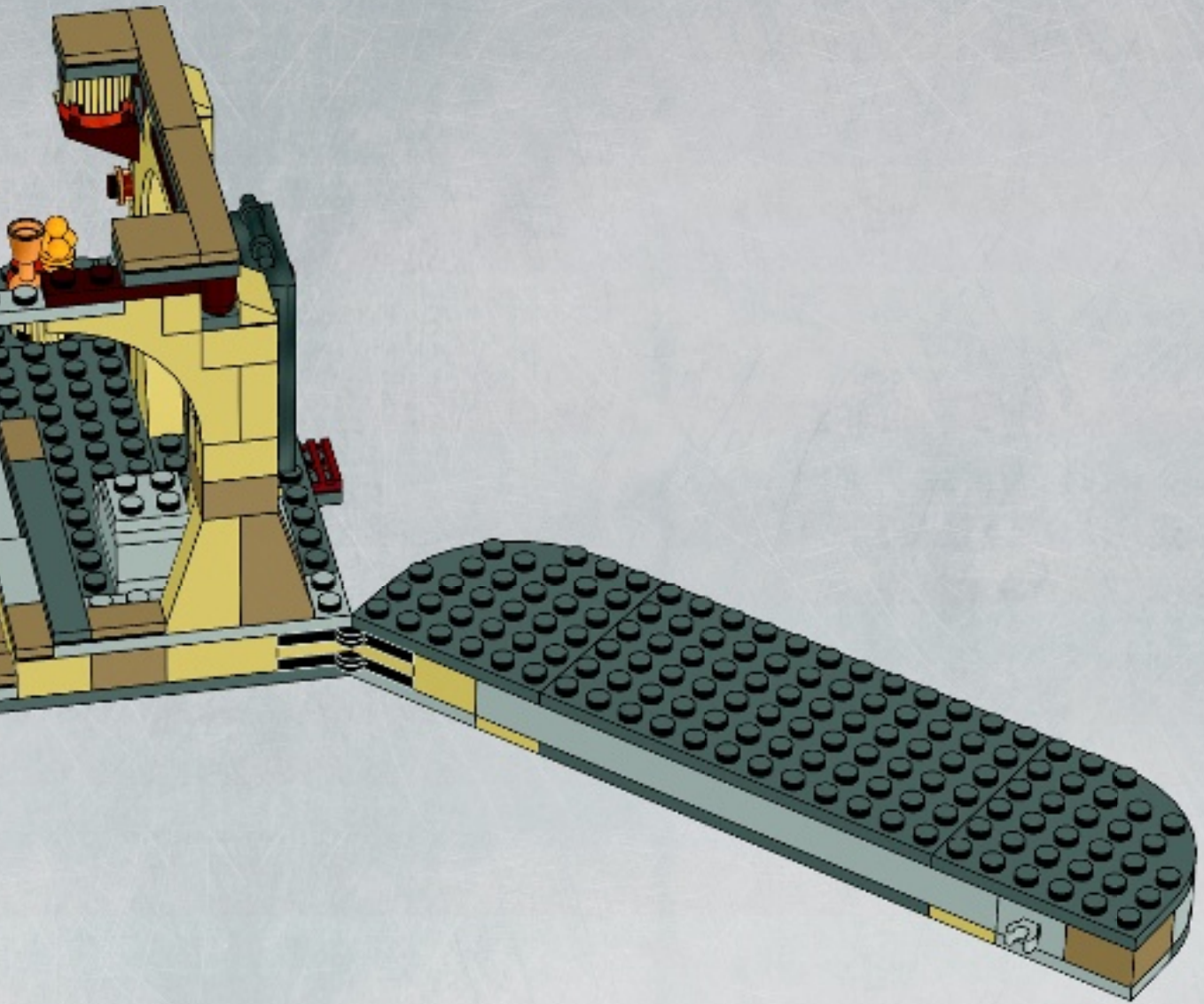

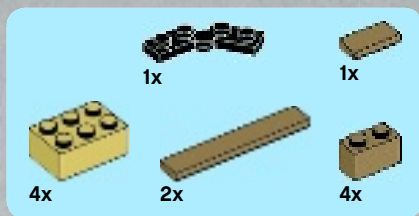

11

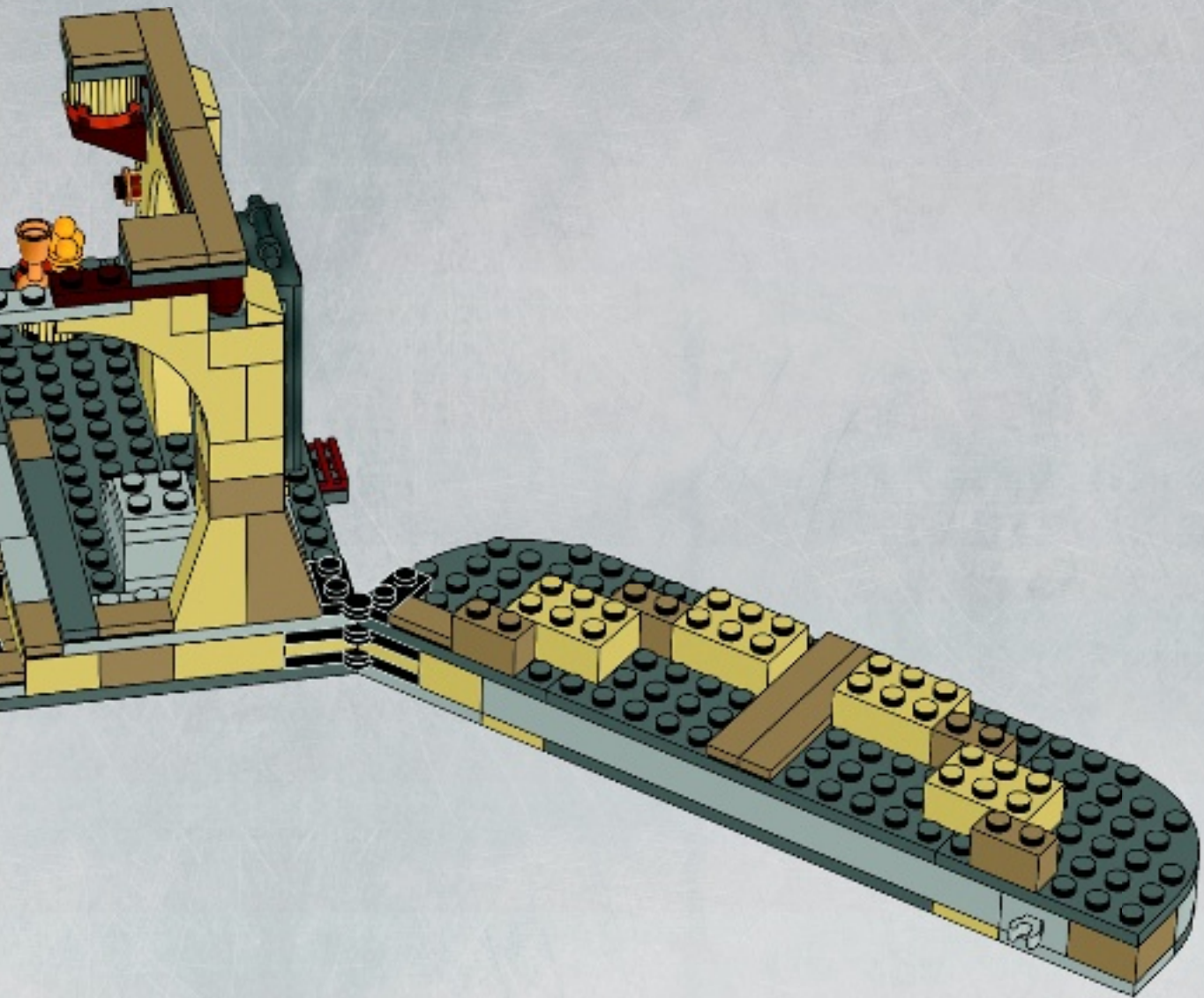

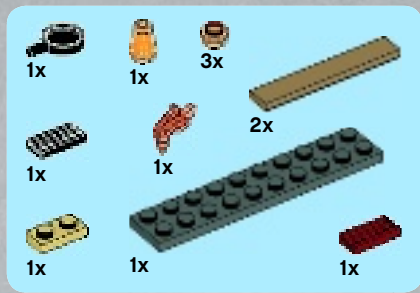

# 12

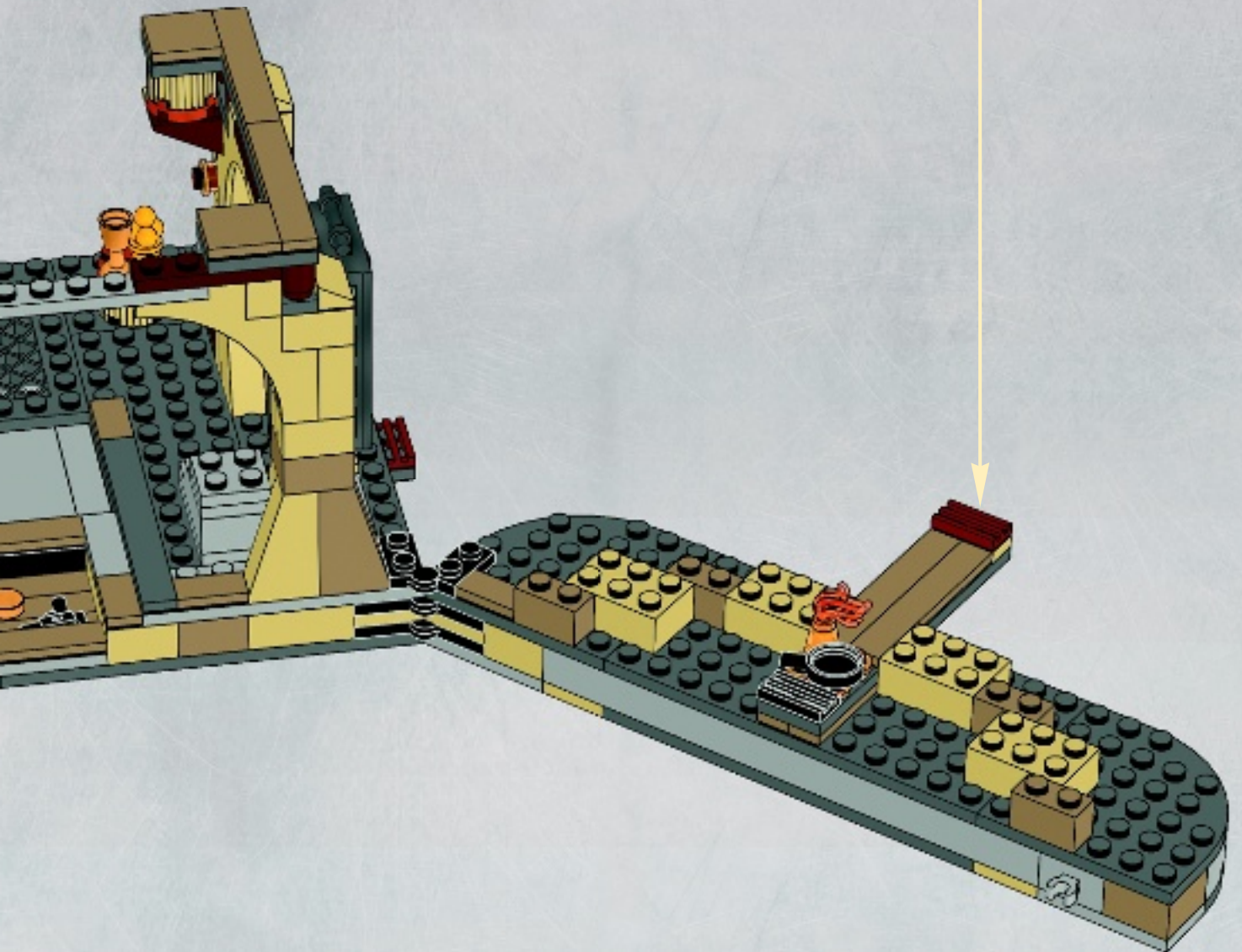
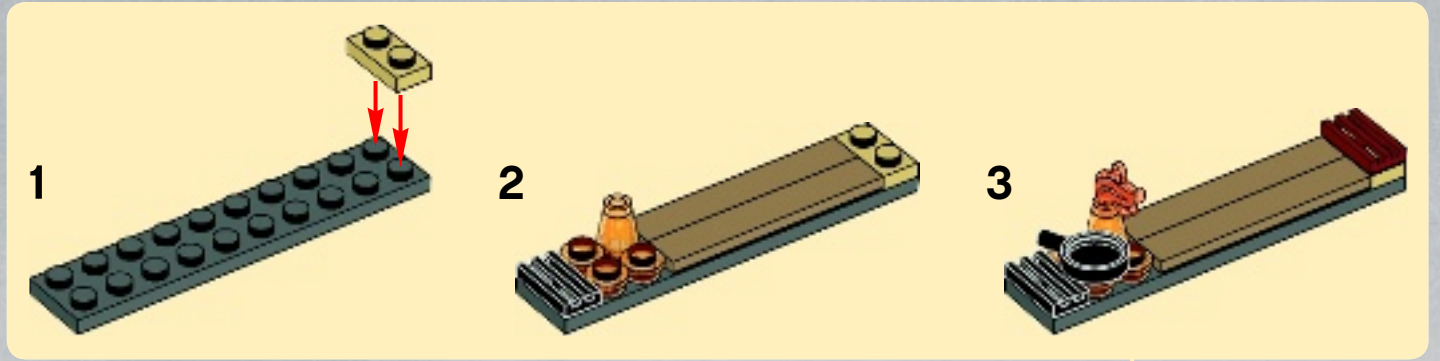



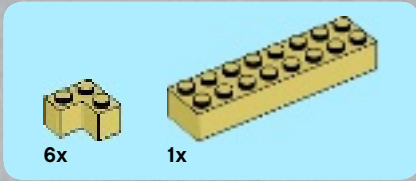

13

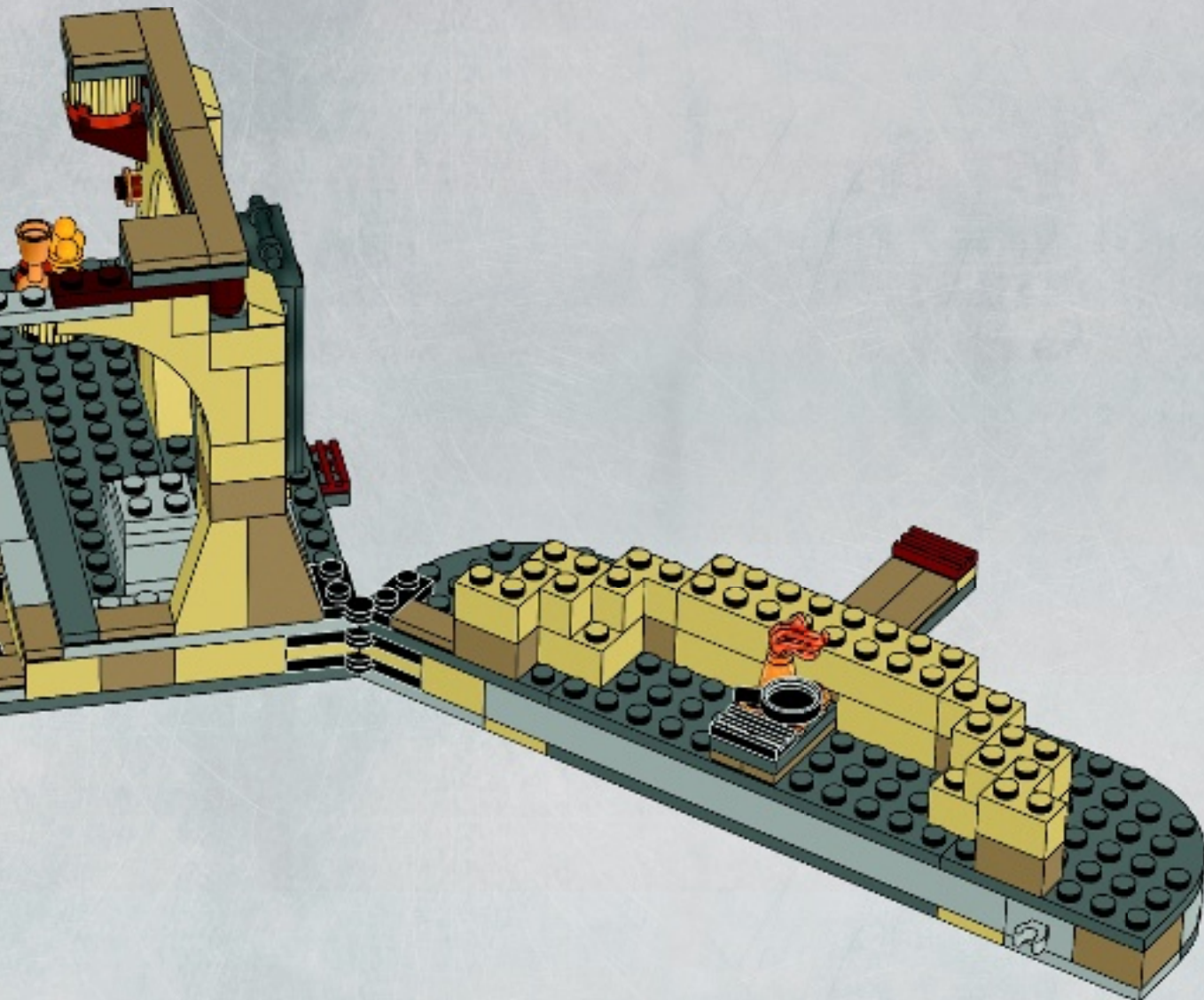

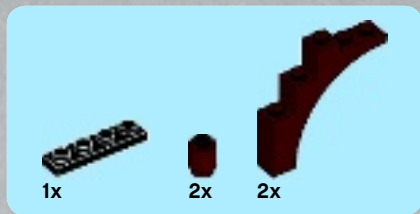

14

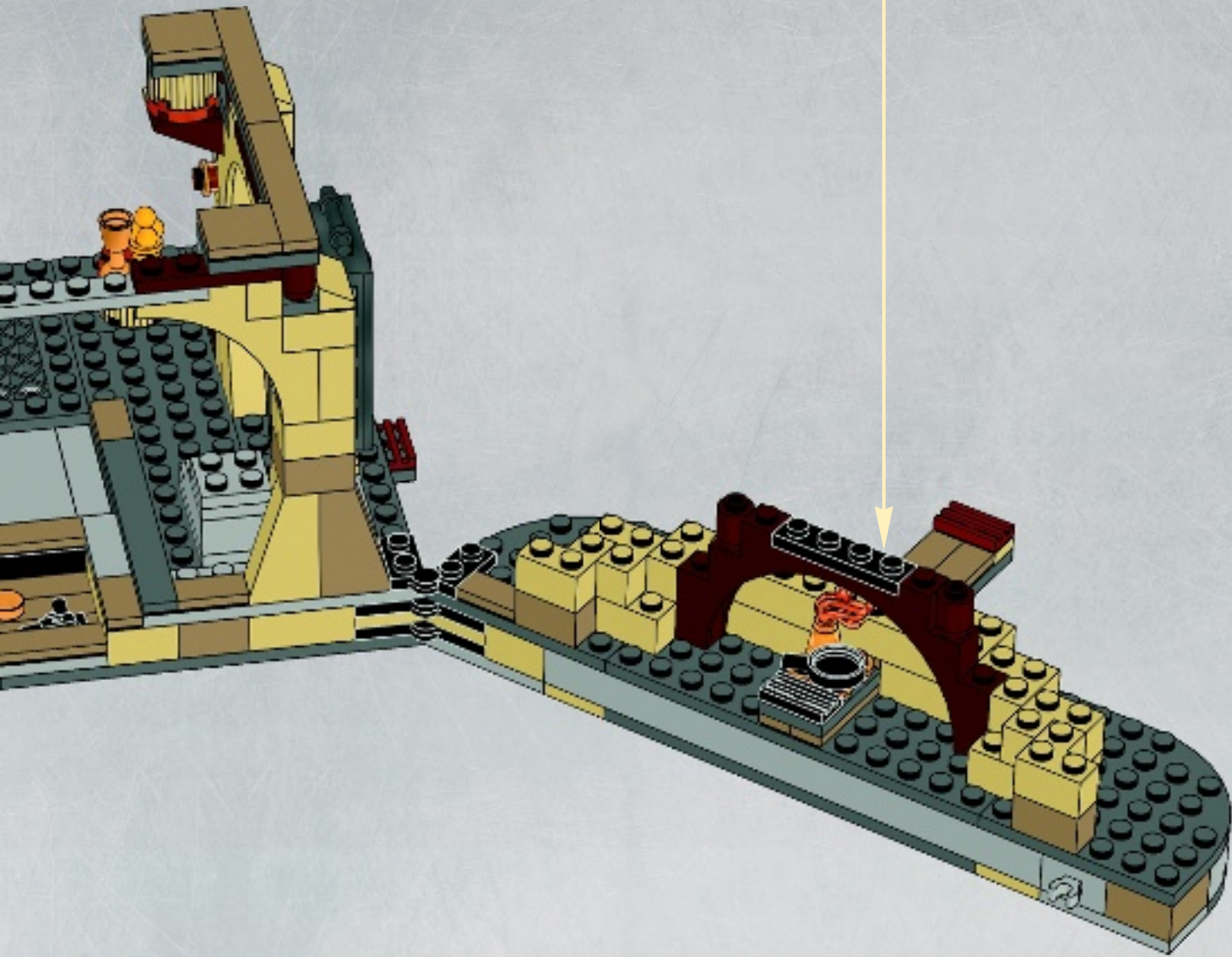
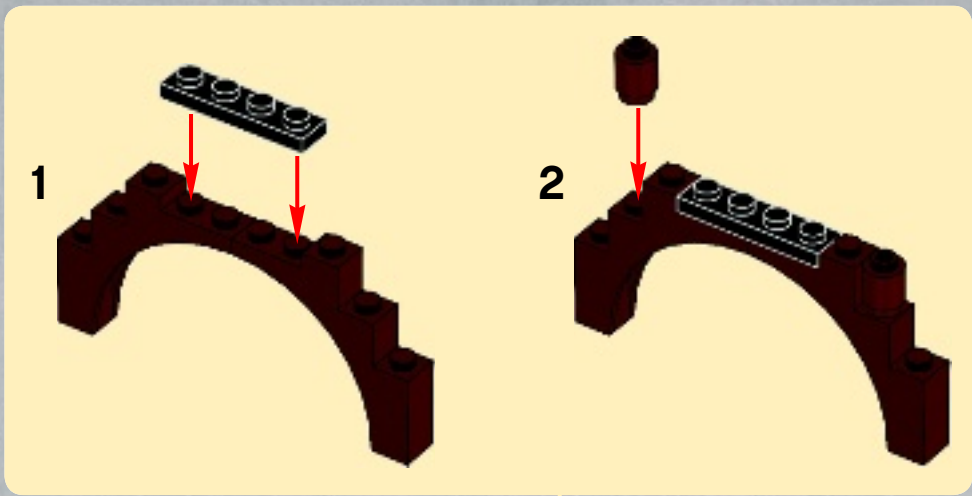



8x

15

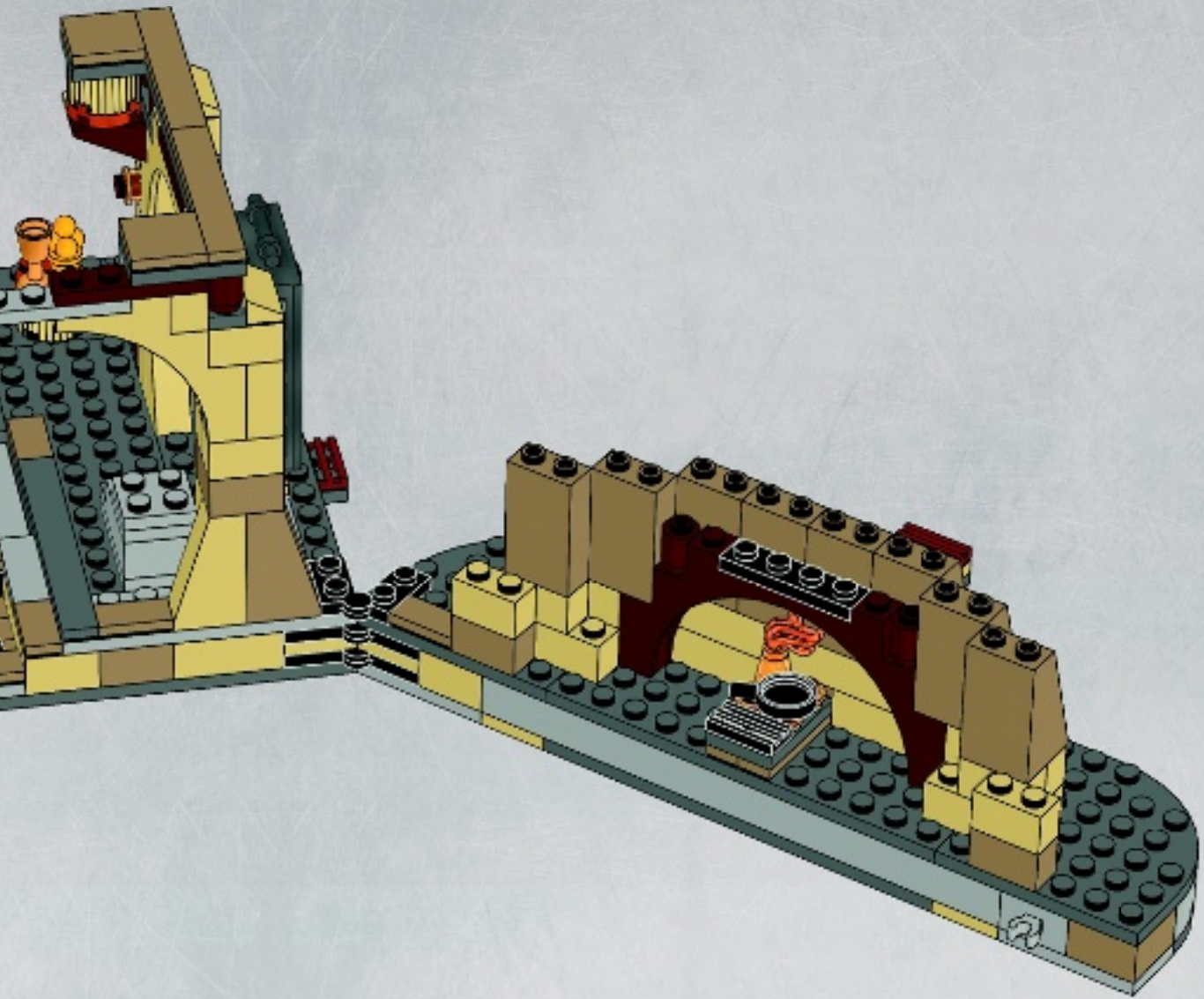



2x



4x

# 16

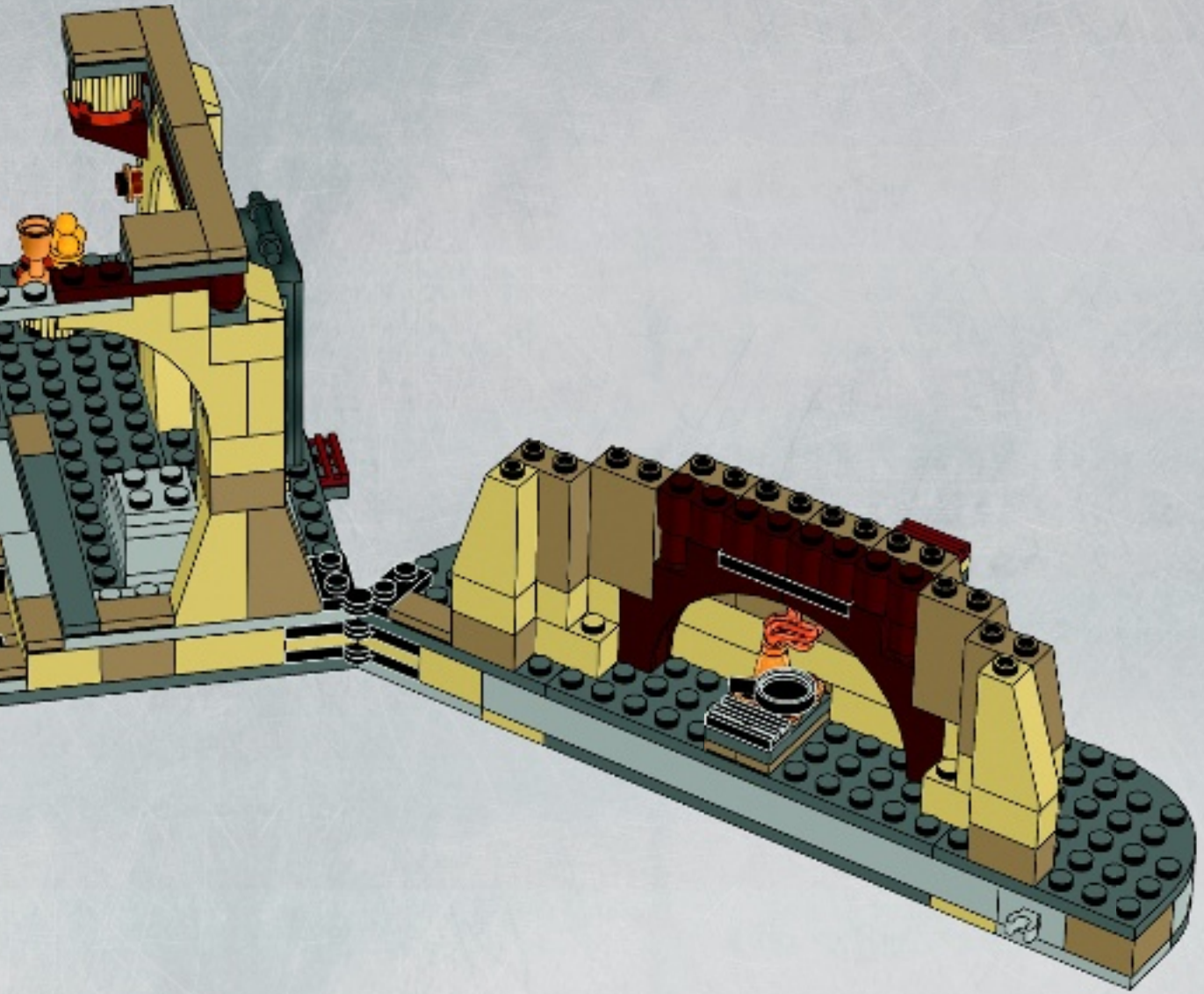



8x

17

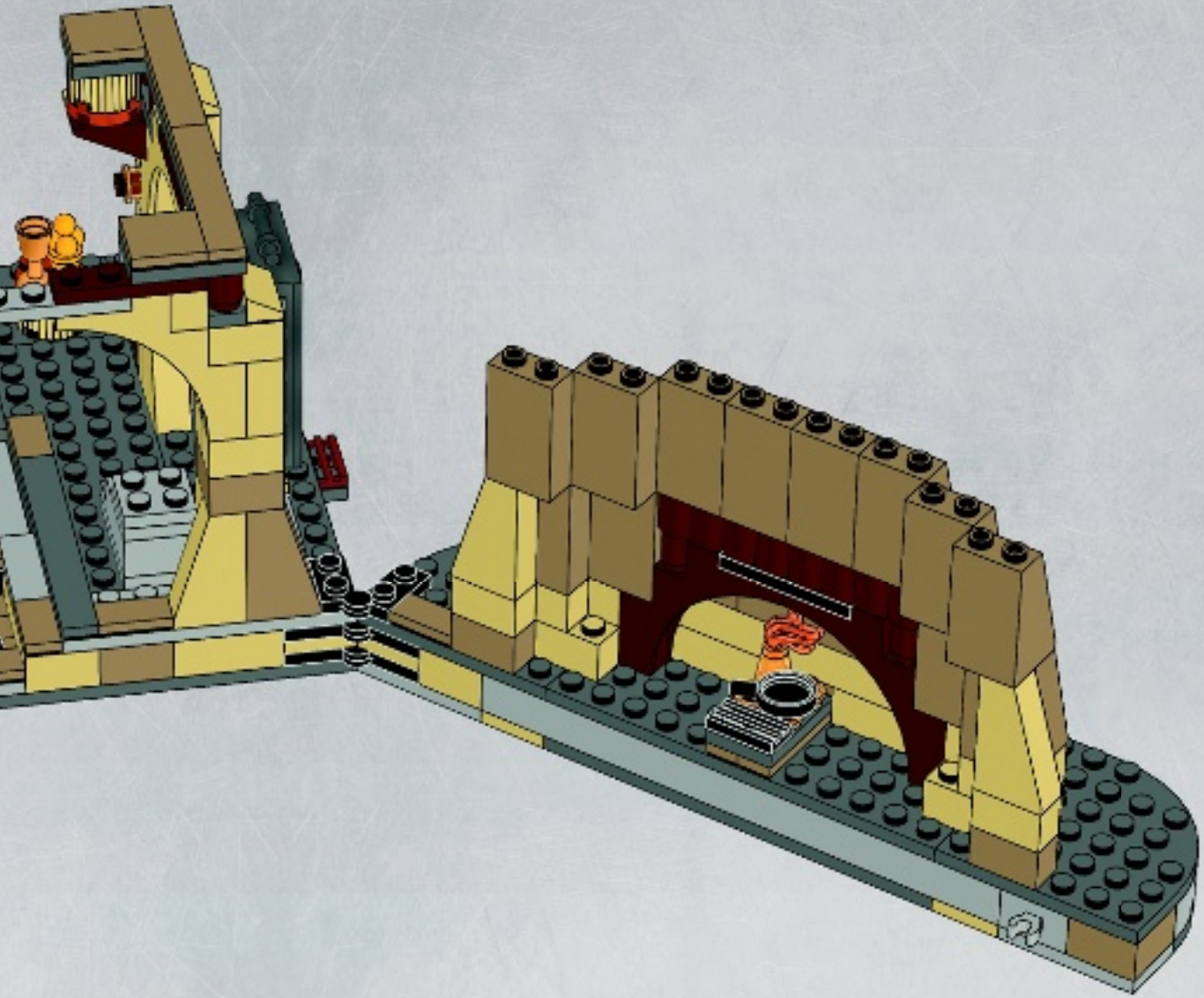



1x



4x

# 18

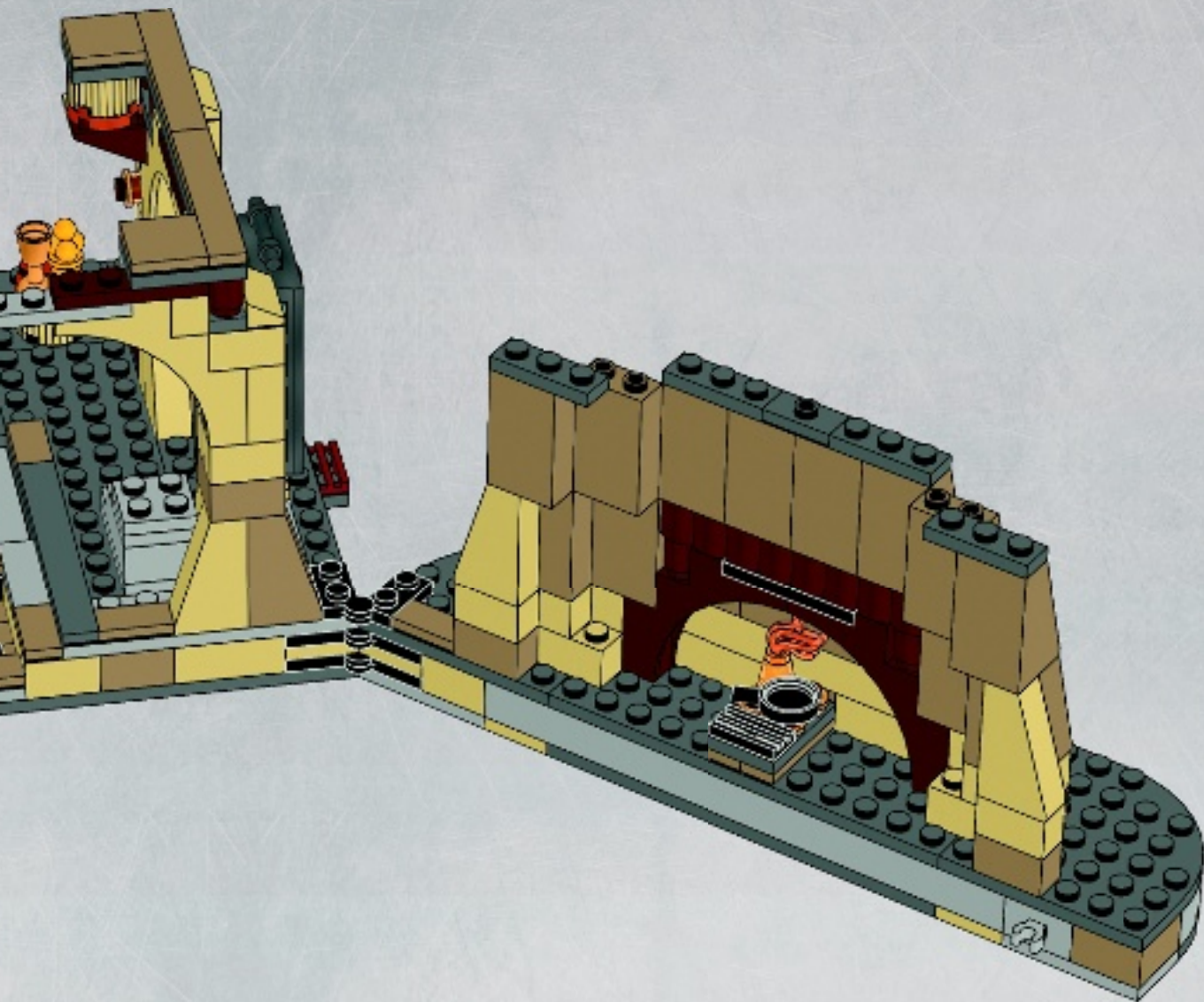



2x

# 19

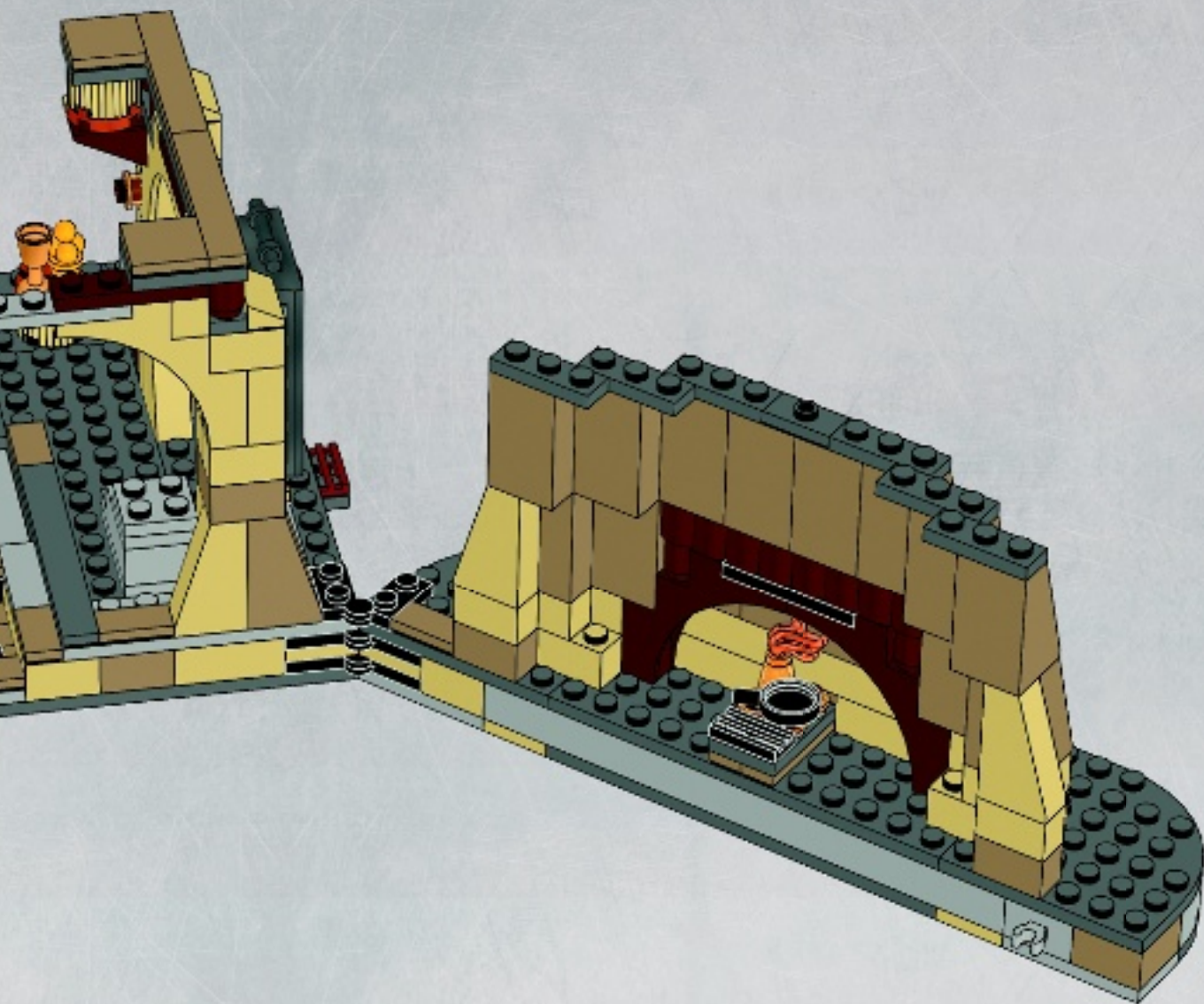



4x



5x

20

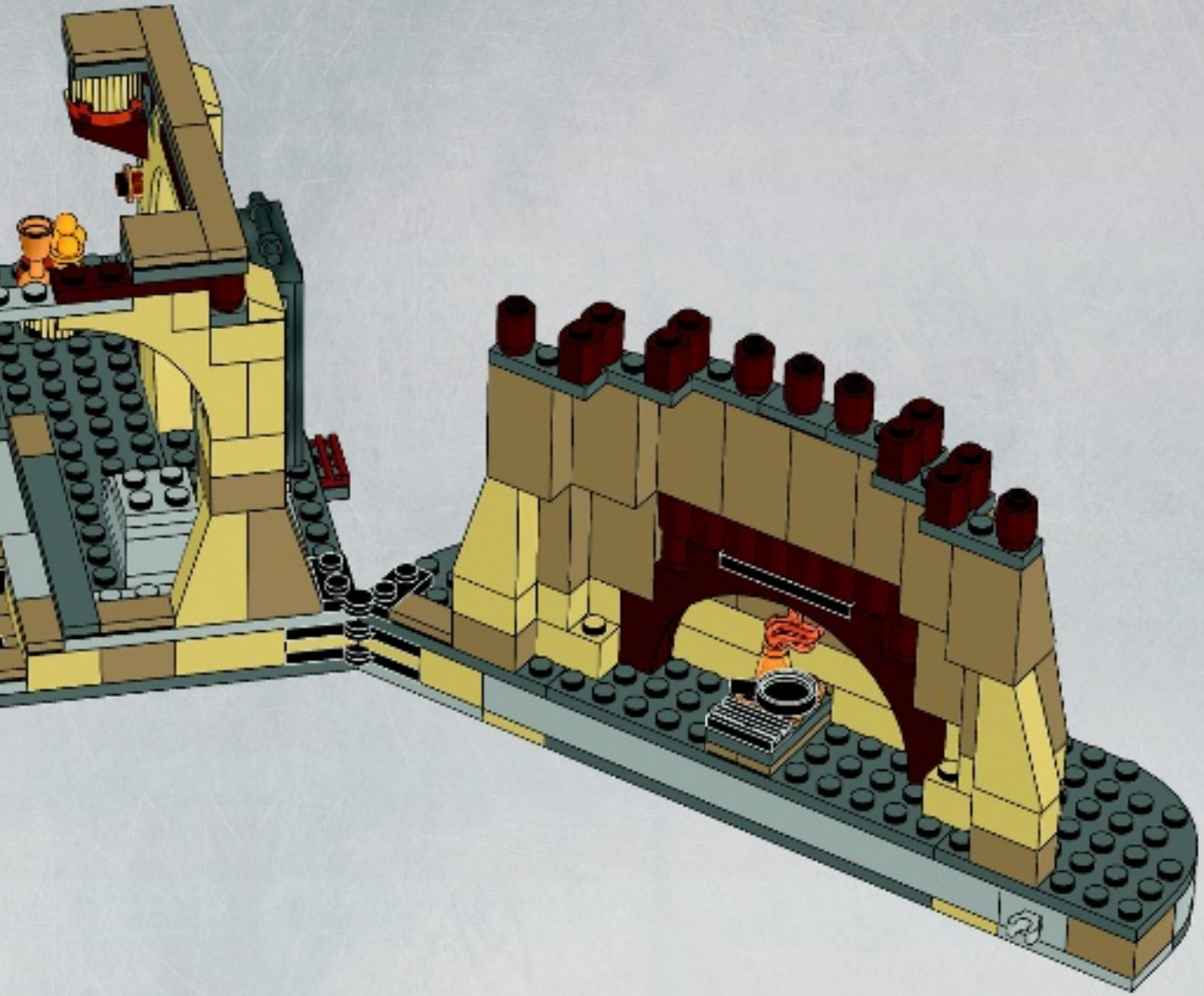





# 21

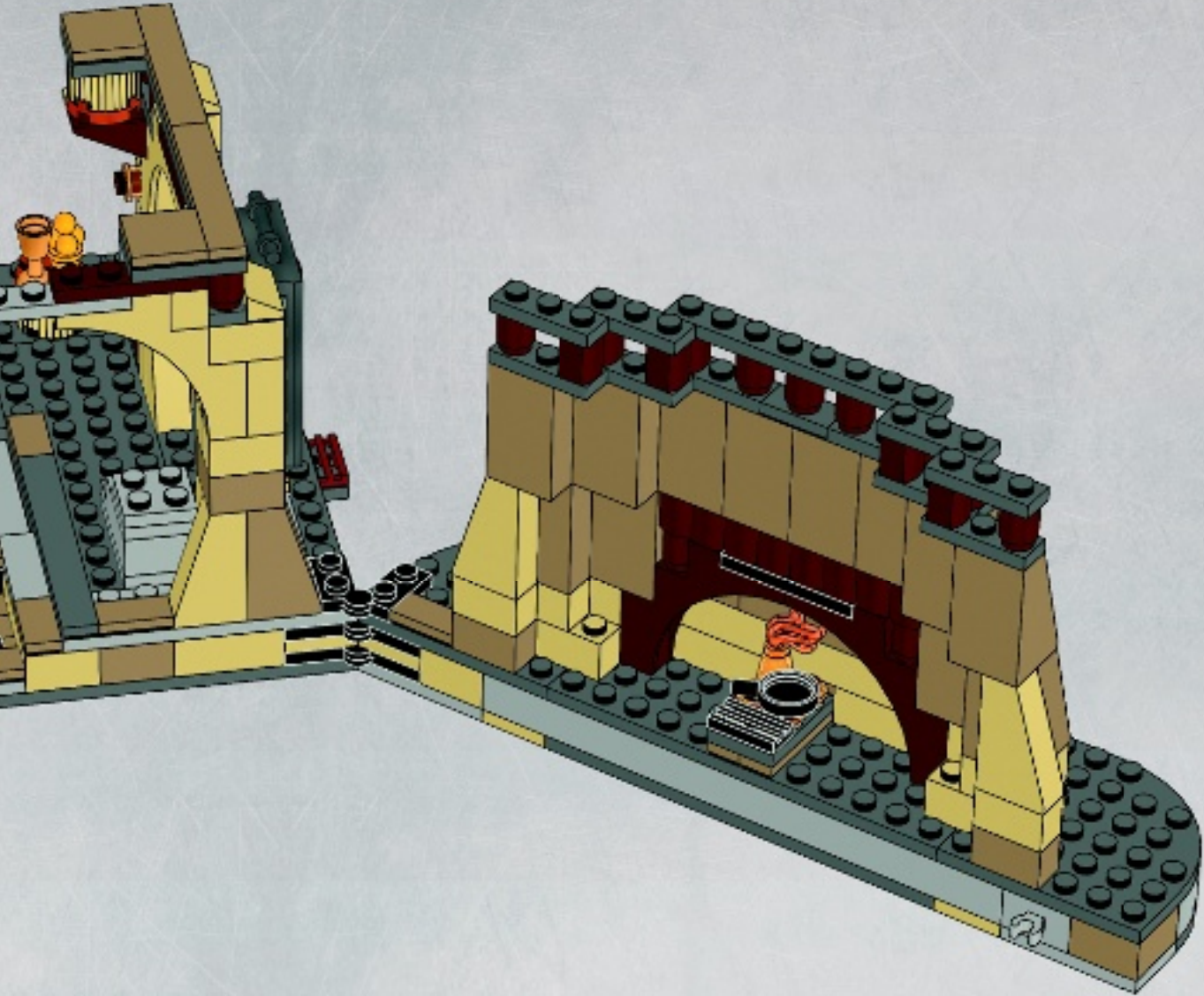

6x

1x

# 22

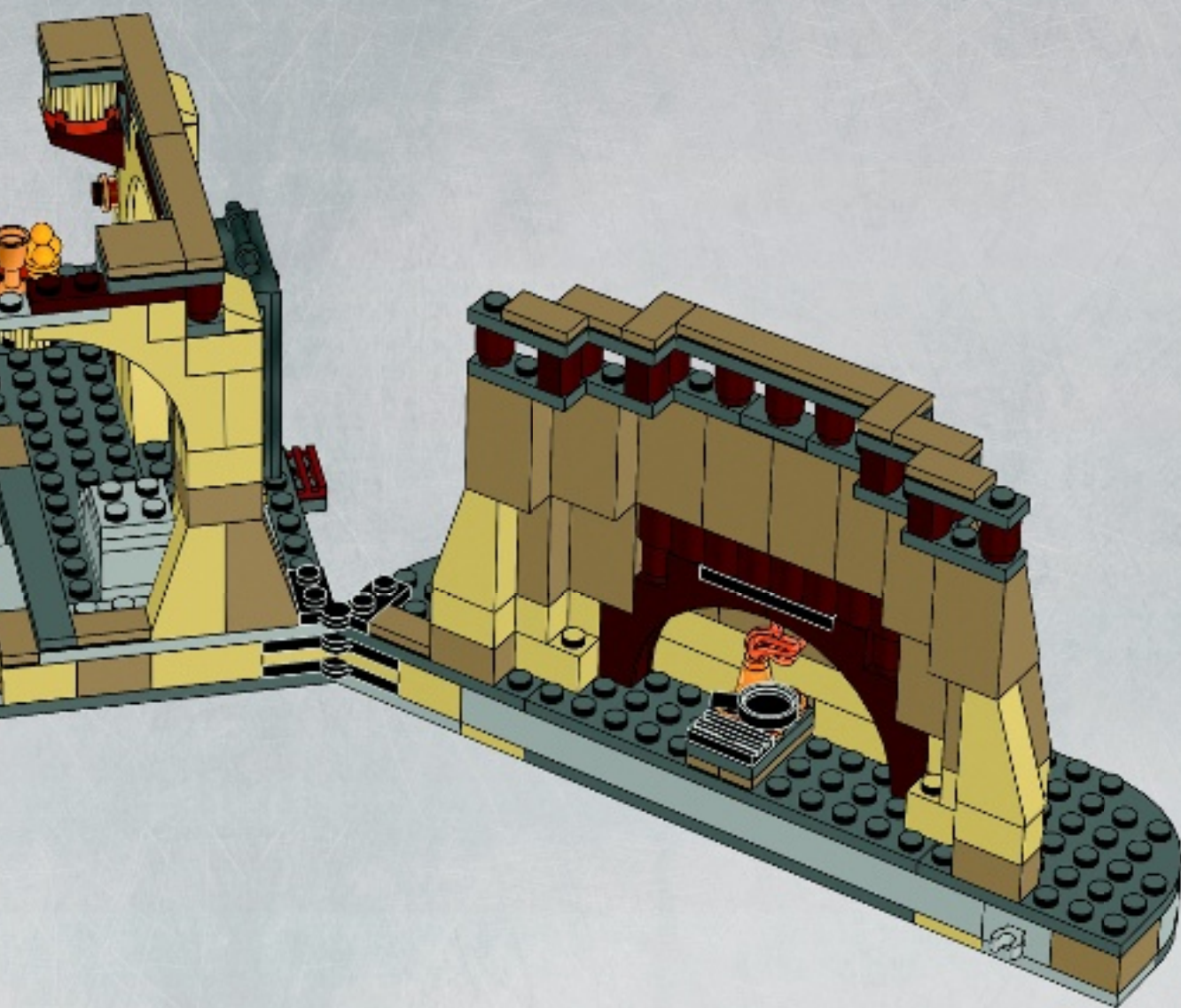

23

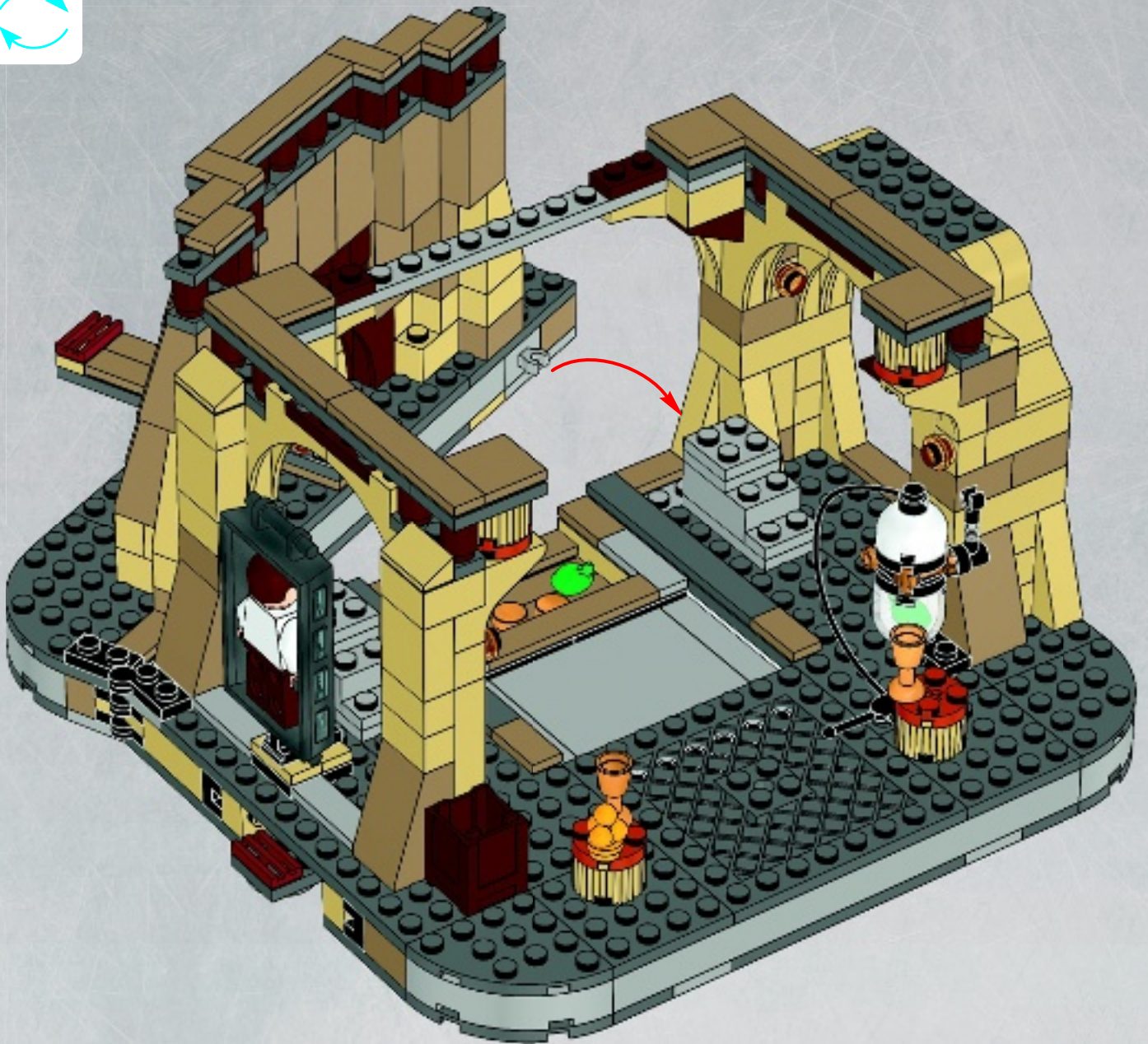

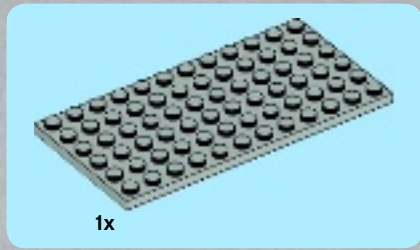

1

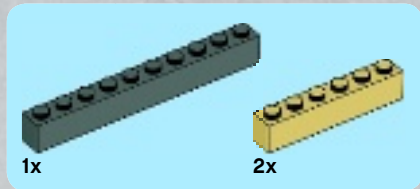
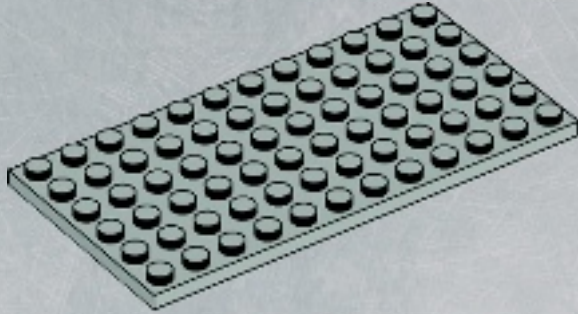

2

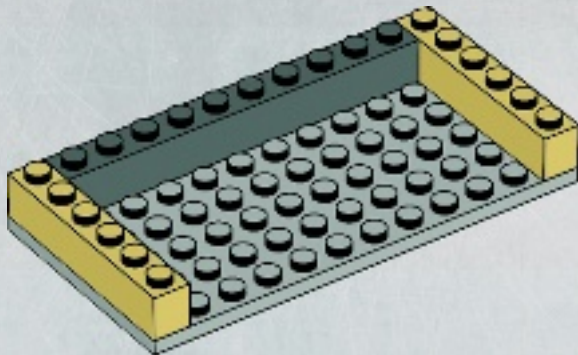

3

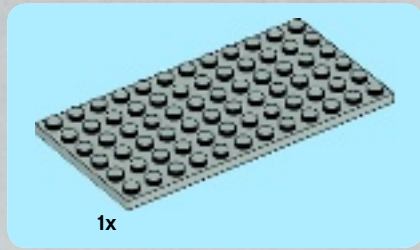
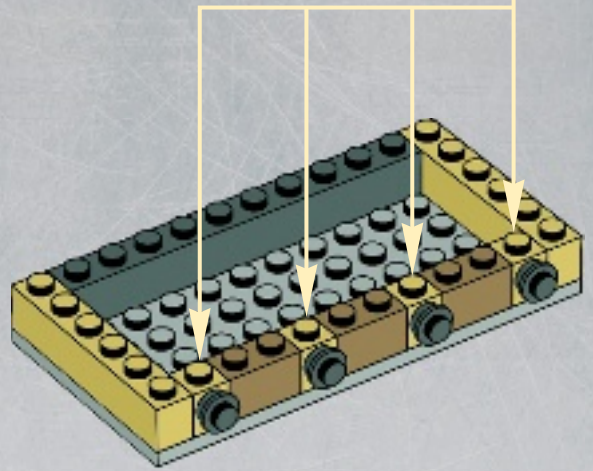
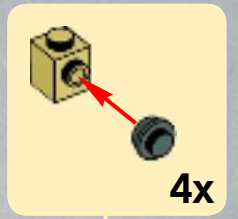

4

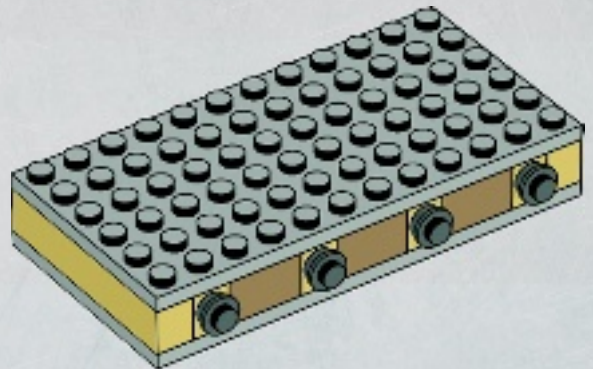



5

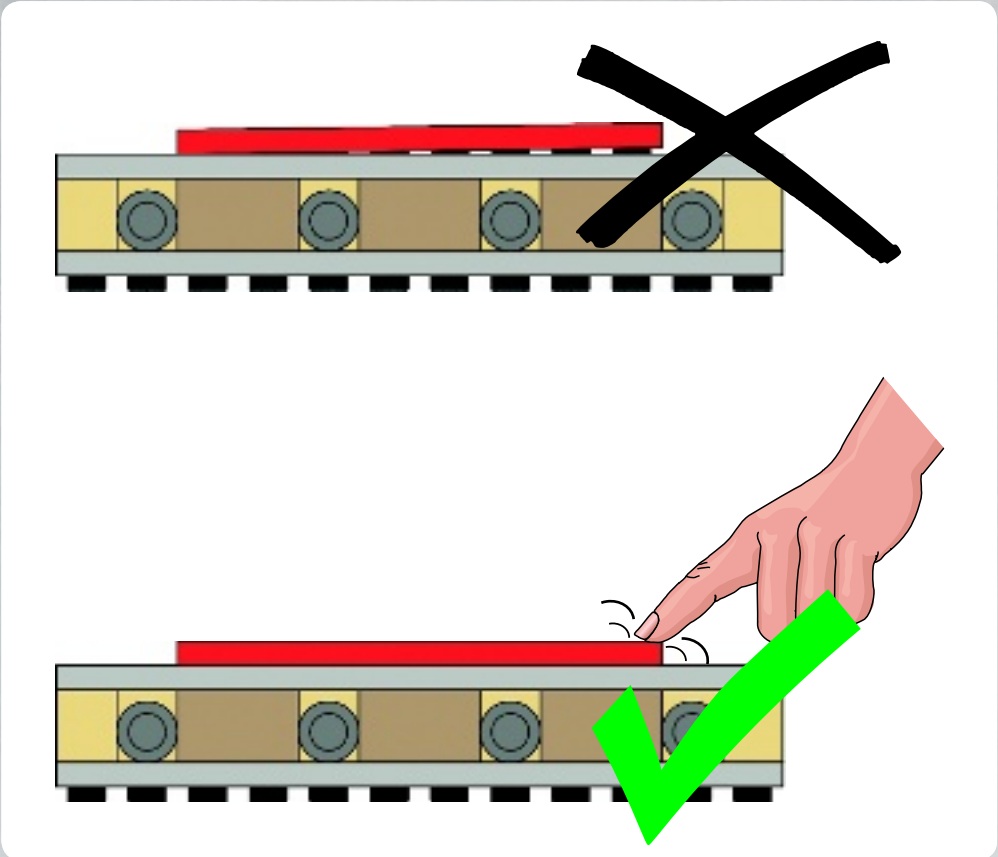
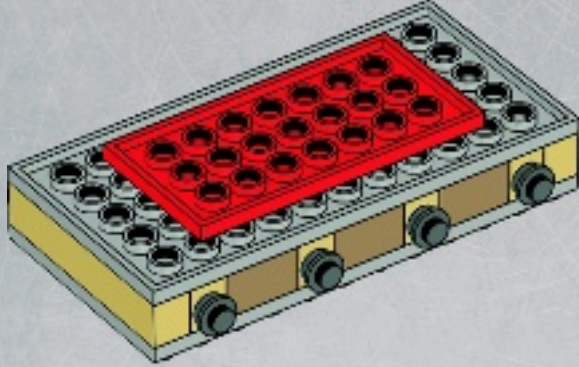



6

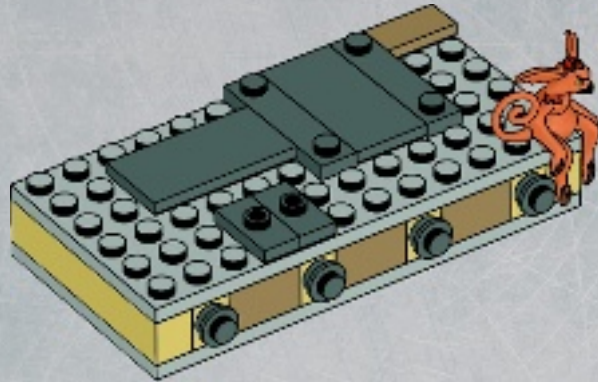

24

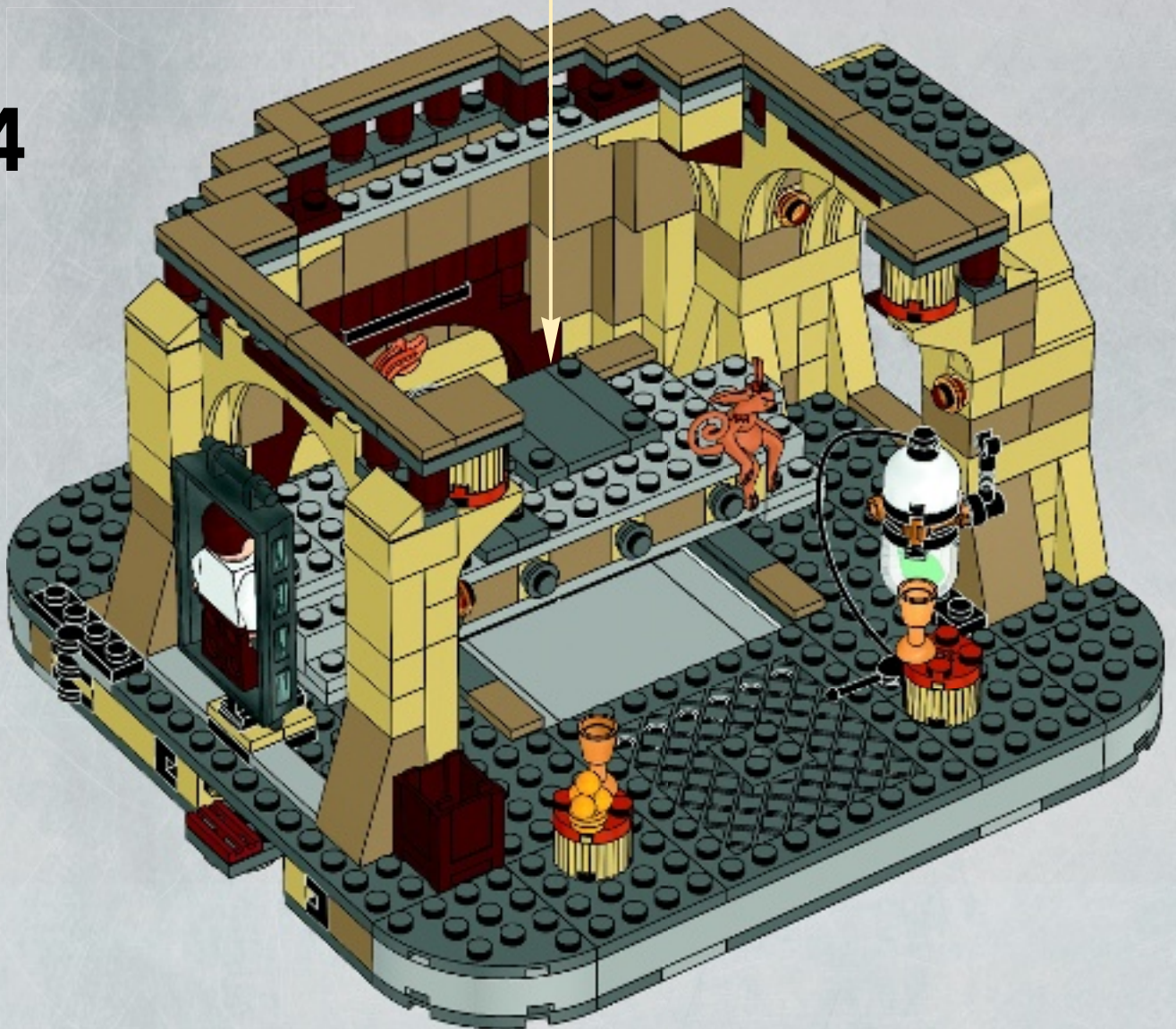

25





7

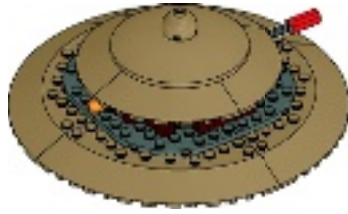

2x

1

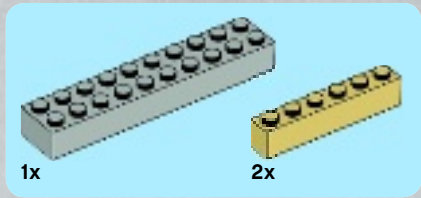
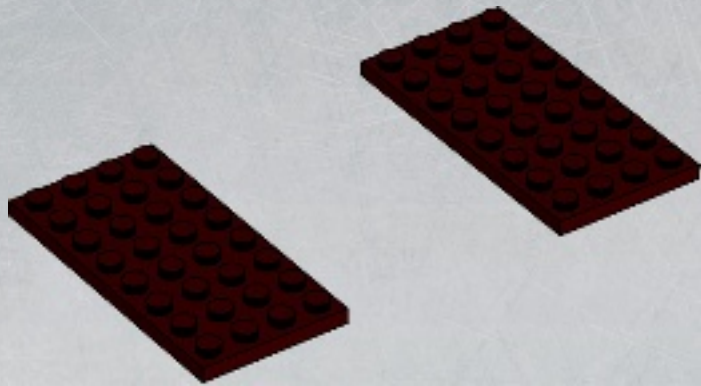

1x

2x

2

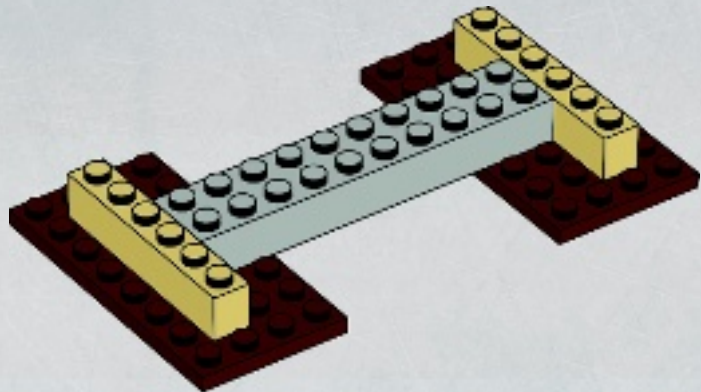



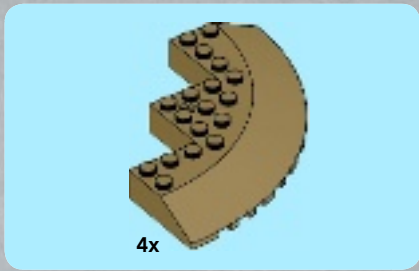

3

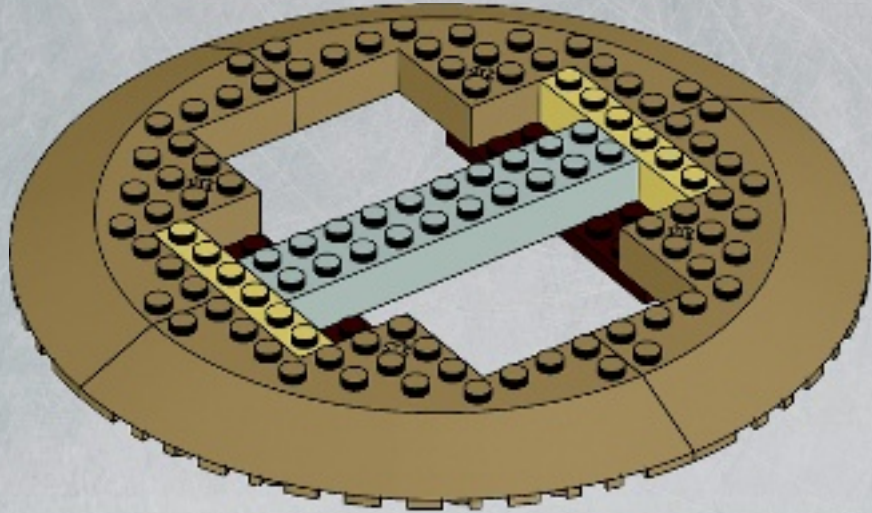

4

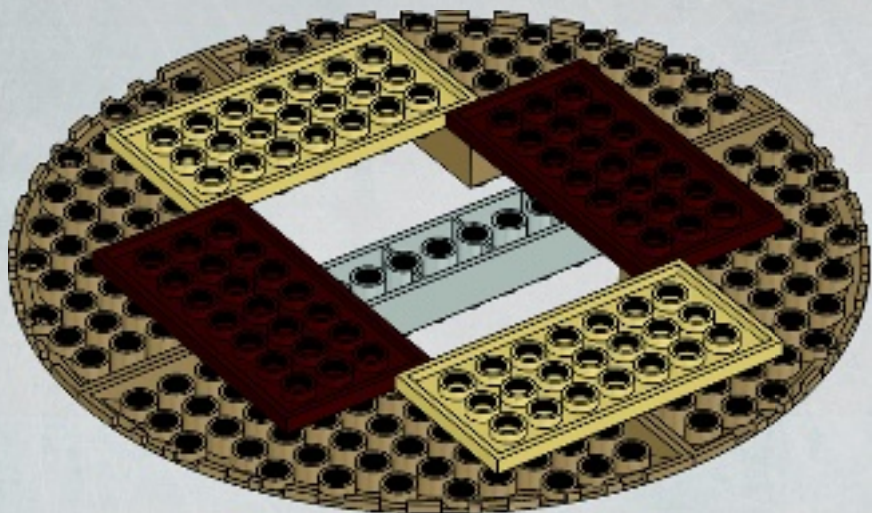



2x



5

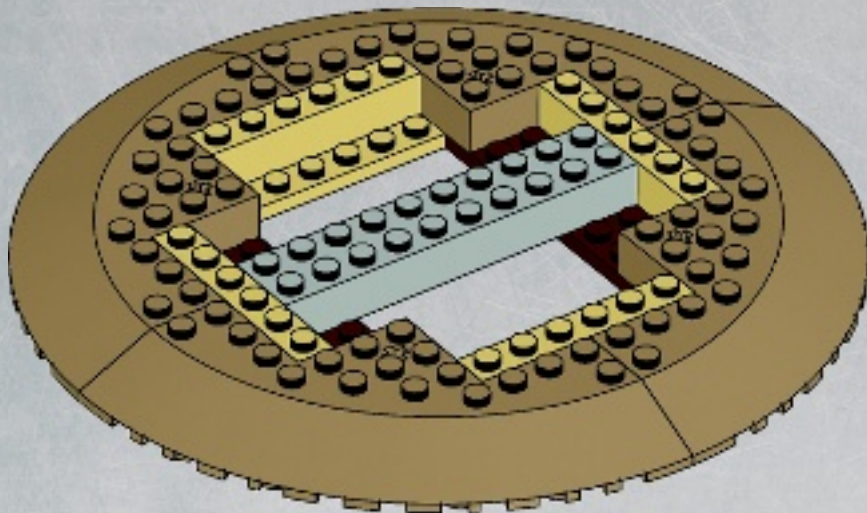

2x

6

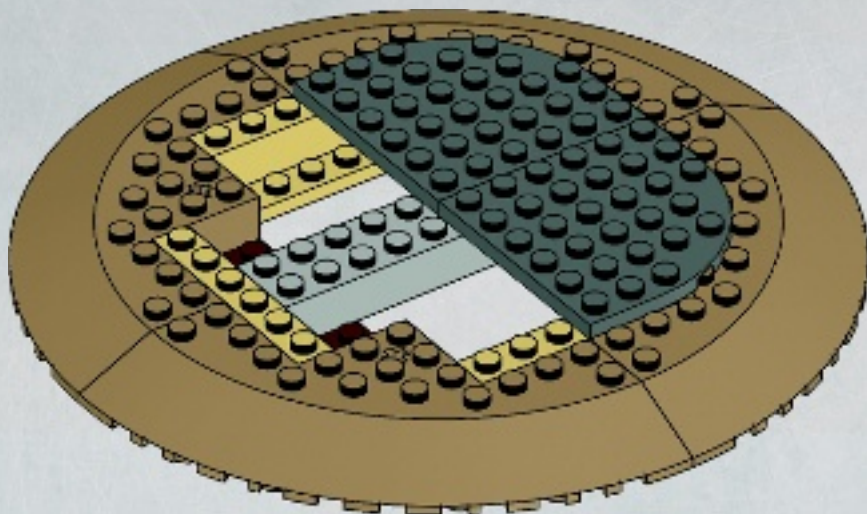

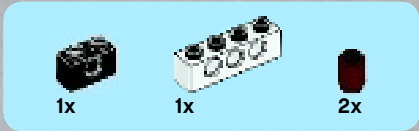

7

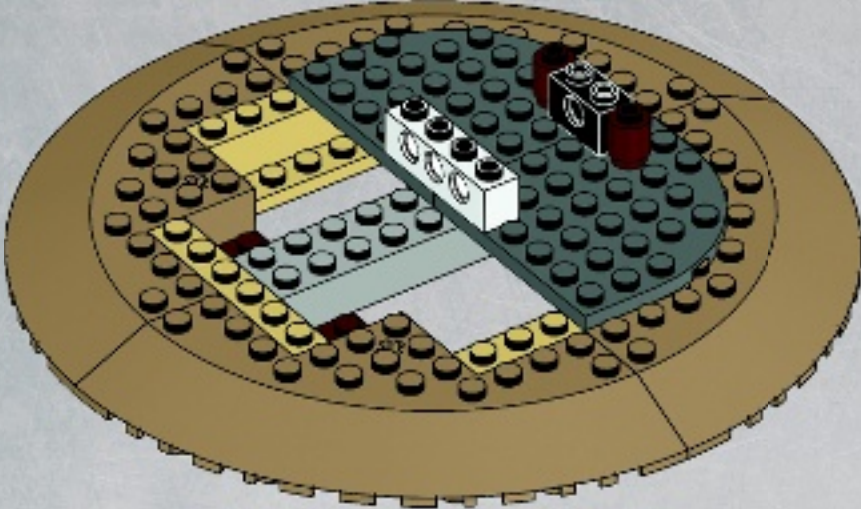

8

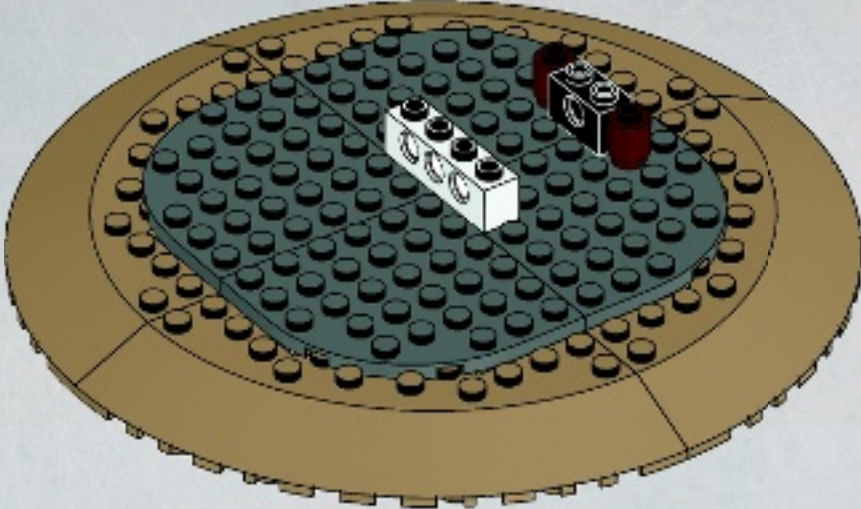

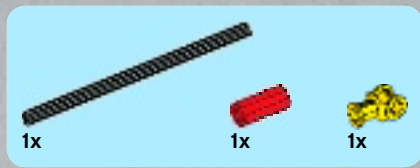

9

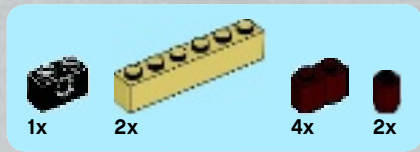
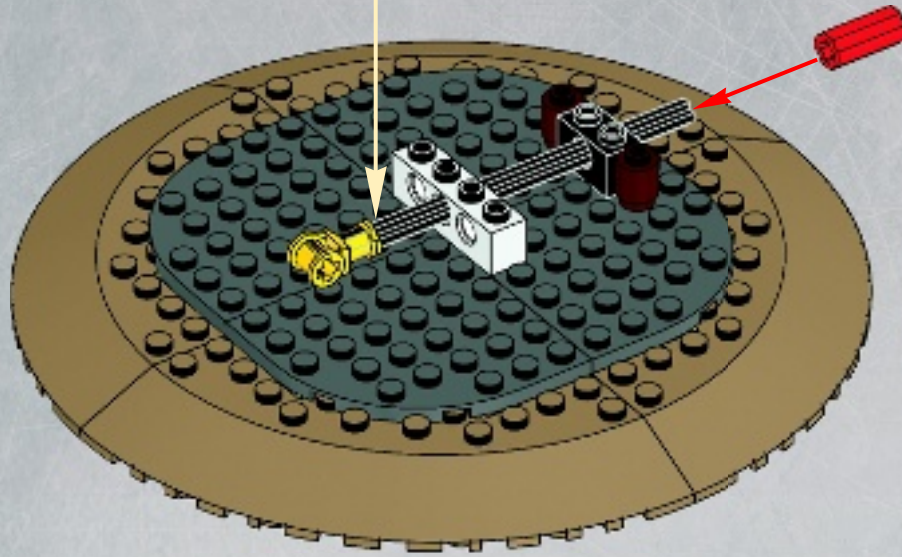
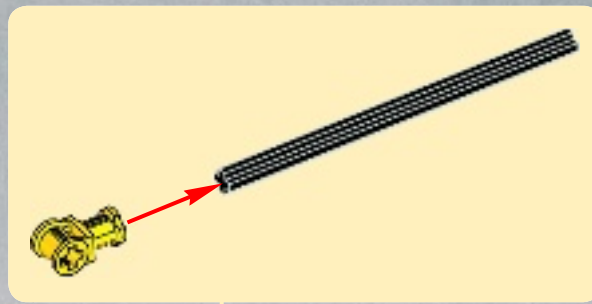

10

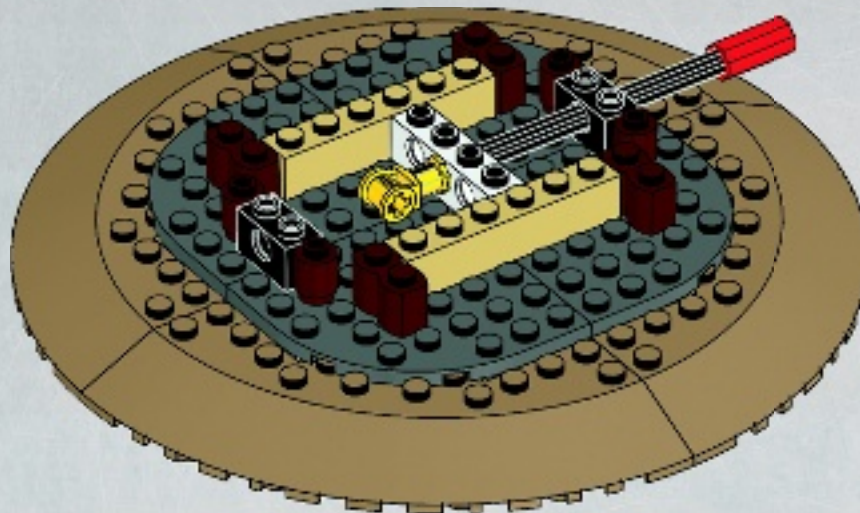



4x



1x



1x



# 11

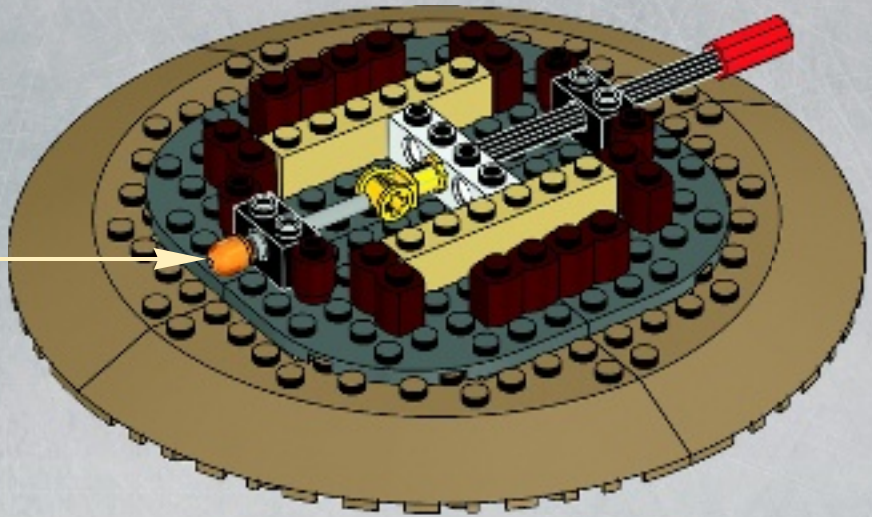
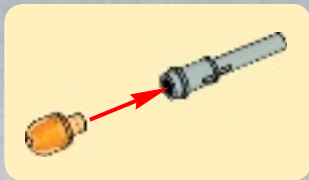

4x



# 12

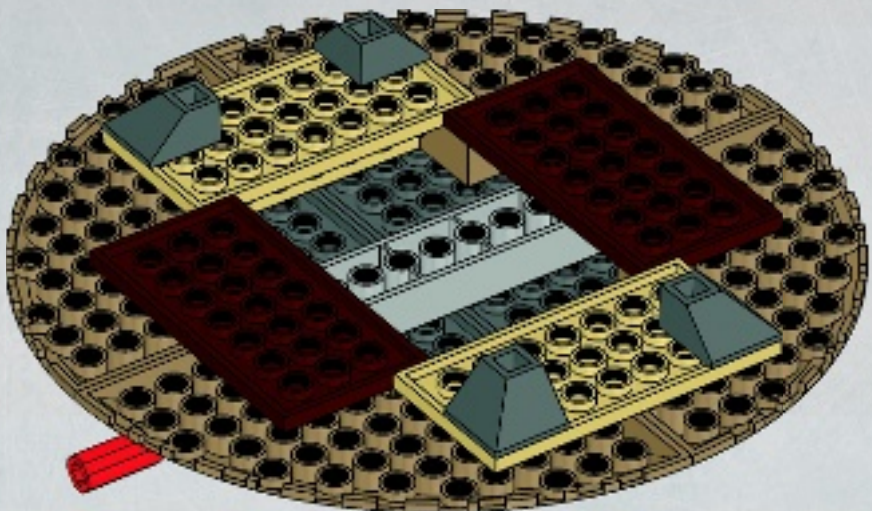

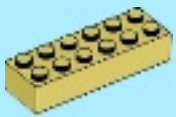

1x



# 13



4x

# 14

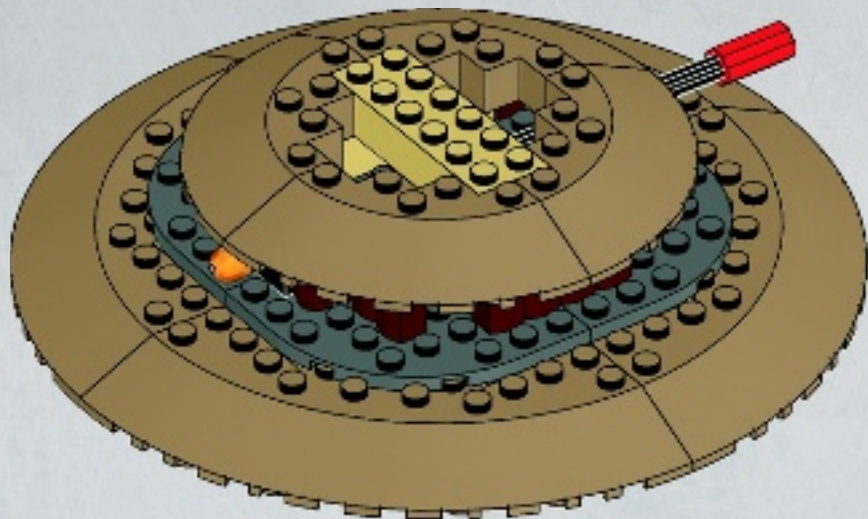



2x

# 15

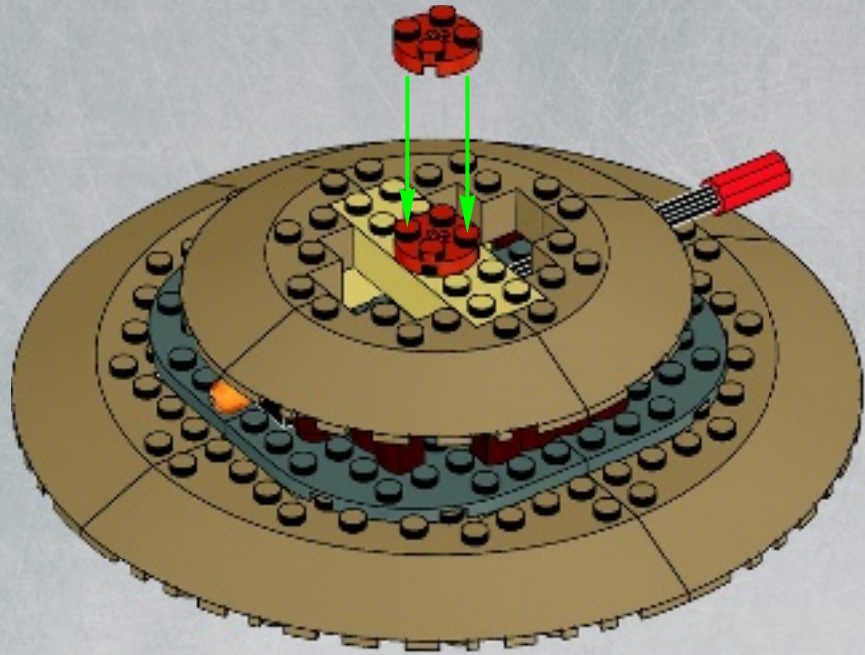

1x



1x

# 16

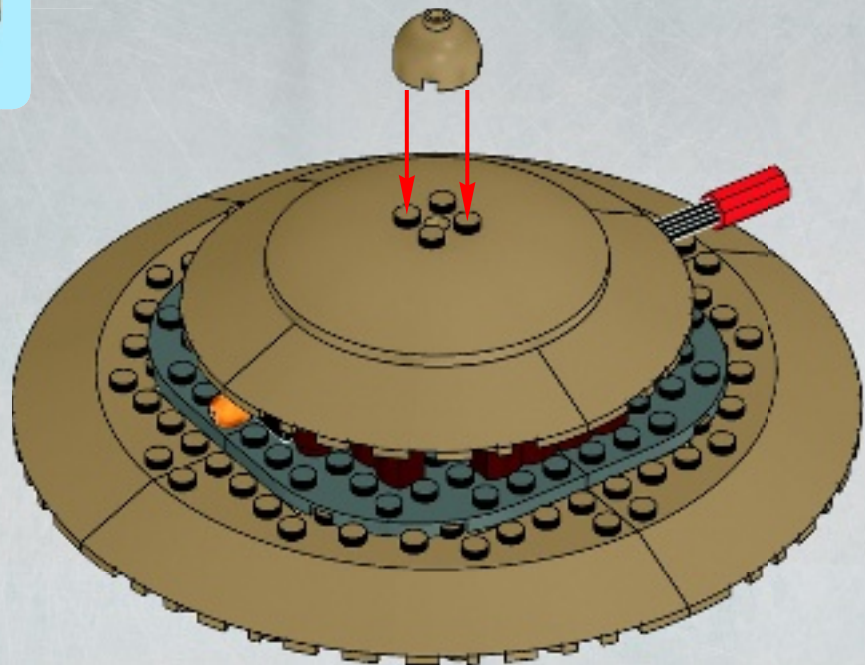

17





18

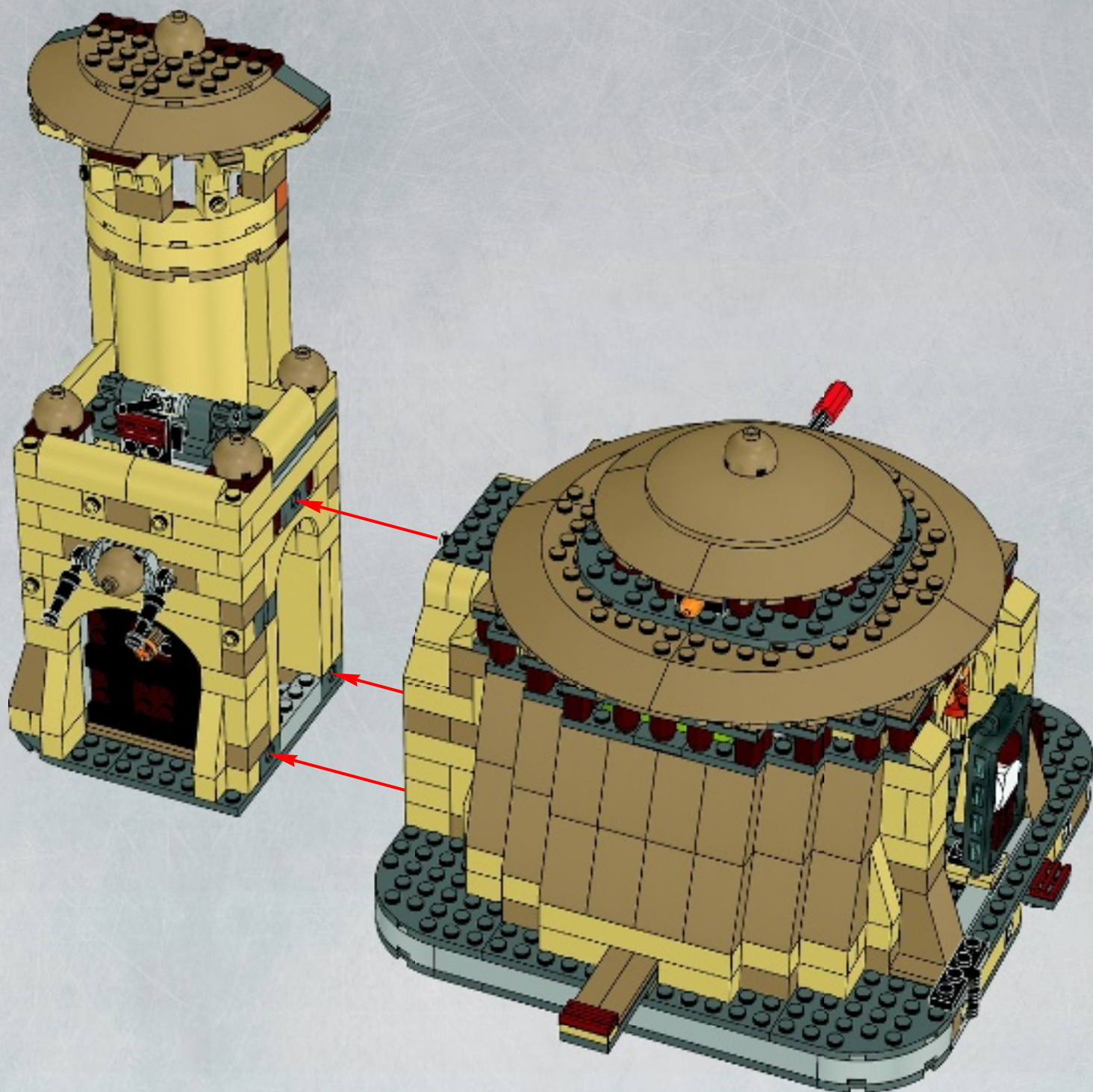





4x  
300801



1x  
4216652



1x  
370101



1x  
4584819



3 x  
4112980



5x  
4159279



5x  
4114064



32x  
4124455



15x  
4162465



6x  
4159739



4x  
4114319



13x  
4112982



1x  
4181134



4x  
4159774



1x  
4141533



2x  
4509897



4x  
6006805



2x  
4159196



4x  
4624086



14x  
4129996



4x  
4114322



6x  
4273526



10x  
4579306



4x  
6019724



10x  
4587269



1x  
4114073



2x  
4596319



8x  
4113917



2x  
4155708



2x  
6006789



22x  
4579260



5x  
4650647



1x  
6006800



1x  
6006528



1x  
6006530



1x  
303521



1x  
4513174



2x  
4206482



1x  
4239601



1x  
4107800



8x  
265326



2x  
370026



1x  
302426



1x  
371026



1x  
4598528



1x  
241226



2x  
4569733



3x  
74011



2x  
373826



1x  
4278359



3x  
403226



1x  
4124171



1x  
486526



1x  
73587



3x  
4538456



2x  
4140303



1x  
452826



1x  
4609050



1x  
4498713



1x  
4498712



4x  
4114206



2x  
4289538



5x  
4141580



1x  
368026



1x  
4528331



1x  
4107081



3x  
4140801



1x  
370626



1x  
373726



2x  
4157270



1x  
4162916



1x  
6006581



6x  
4616027



1x  
4113949



1x  
4106556



1x  
4540865



1x  
4654448



1x  
4620380



1x  
6006540



1x  
6006564



1x  
6006537



1x  
6016961



40x  
4521914



7x  
4255416



6x  
4609875



6x  
6006804



4x  
6006809



2x  
4530678



21x  
6000852



16x  
4496699



7x  
4507045



21x  
4507047

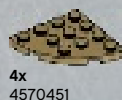

4x  
4570451

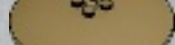

1x  
6006808



1x  
4566927



1x  
6009743



3x  
4541506



1x  
4567338



10x  
4222960



1x  
4524365



1x  
4286789



1x  
4262974



16x  
4211180



23x  
4211183



4x  
4211195



2x  
6012805



5x  
4216695



1x  
4211189



4x  
4211190



1x  
4211247



2x  
4216945



1x  
4271874

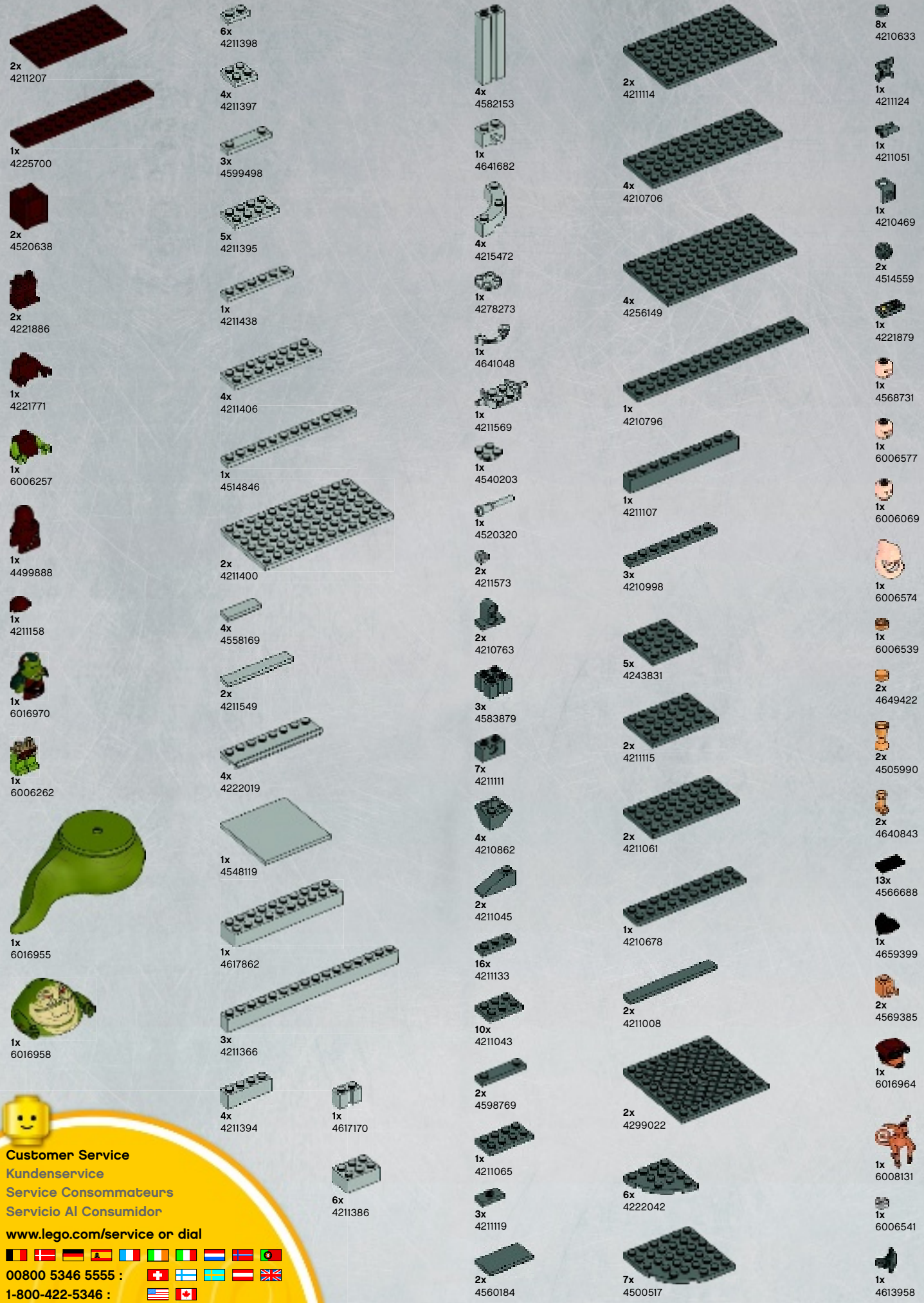

- 2x 4211207
- 1x 4225700
- 2x 4520638
- 2x 4221886
- 1x 4221771
- 1x 6006257
- 1x 4499888
- 1x 4211158
- 1x 6016970
- 1x 6006262
- 1x 6016955
- 1x 6016958

- 6x 4211398
- 4x 4211397
- 3x 4599498
- 5x 4211395
- 1x 4211438
- 4x 4211406
- 1x 4514846
- 2x 4211400
- 4x 4558169
- 2x 4211549
- 4x 4222019
- 1x 4548119
- 1x 4617862
- 3x 4211366

- 4x 4211394
- 1x 4617170
- 6x 4211386

- 4x 4582153
- 1x 4641682
- 4x 4215472
- 1x 4278273
- 1x 4641048
- 1x 4211569
- 1x 4540203
- 1x 4520320
- 2x 4211573
- 2x 4210763
- 3x 4583879
- 7x 4211111
- 4x 4210862
- 2x 4211045
- 16x 4211133
- 10x 4211043
- 2x 4598769
- 1x 4211065
- 3x 4211119
- 2x 4560184

- 2x 4211114
- 4x 4210706
- 4x 4256149
- 1x 4210796
- 1x 4211107
- 3x 4210998
- 5x 4243831
- 2x 4211115
- 2x 4211061
- 1x 4210678
- 2x 4211008
- 2x 4299022
- 6x 4222042
- 7x 4500517

- 8x 4210633
- 1x 4211124
- 1x 4211051
- 1x 4210469
- 2x 4514559
- 1x 4221879
- 1x 4568731
- 1x 6006577
- 1x 6006069
- 1x 6006574
- 1x 6006539
- 2x 4649422
- 2x 4505990
- 2x 4640843
- 13x 4566688
- 1x 4659399
- 2x 4569385
- 1x 6016964
- 1x 6008131
- 1x 6006541
- 1x 4613958

**Customer Service**  
**Kundenservice**  
**Service Consommateurs**  
**Servicio Al Consumidor**  
[www.lego.com/service](http://www.lego.com/service) or dial  
 00800 5346 5555 :   
 1-800-422-5346 :



JABBA THE HUTT™



HAN SOLO™



HAN IN CARBONITE™



B'OMARR MONK™



BIB FORTUNA™



GAMORREAN GUARD™



CHEWBACCA™



OOLA™



BOUSHH™



SALACIOUS B. CRUMB™

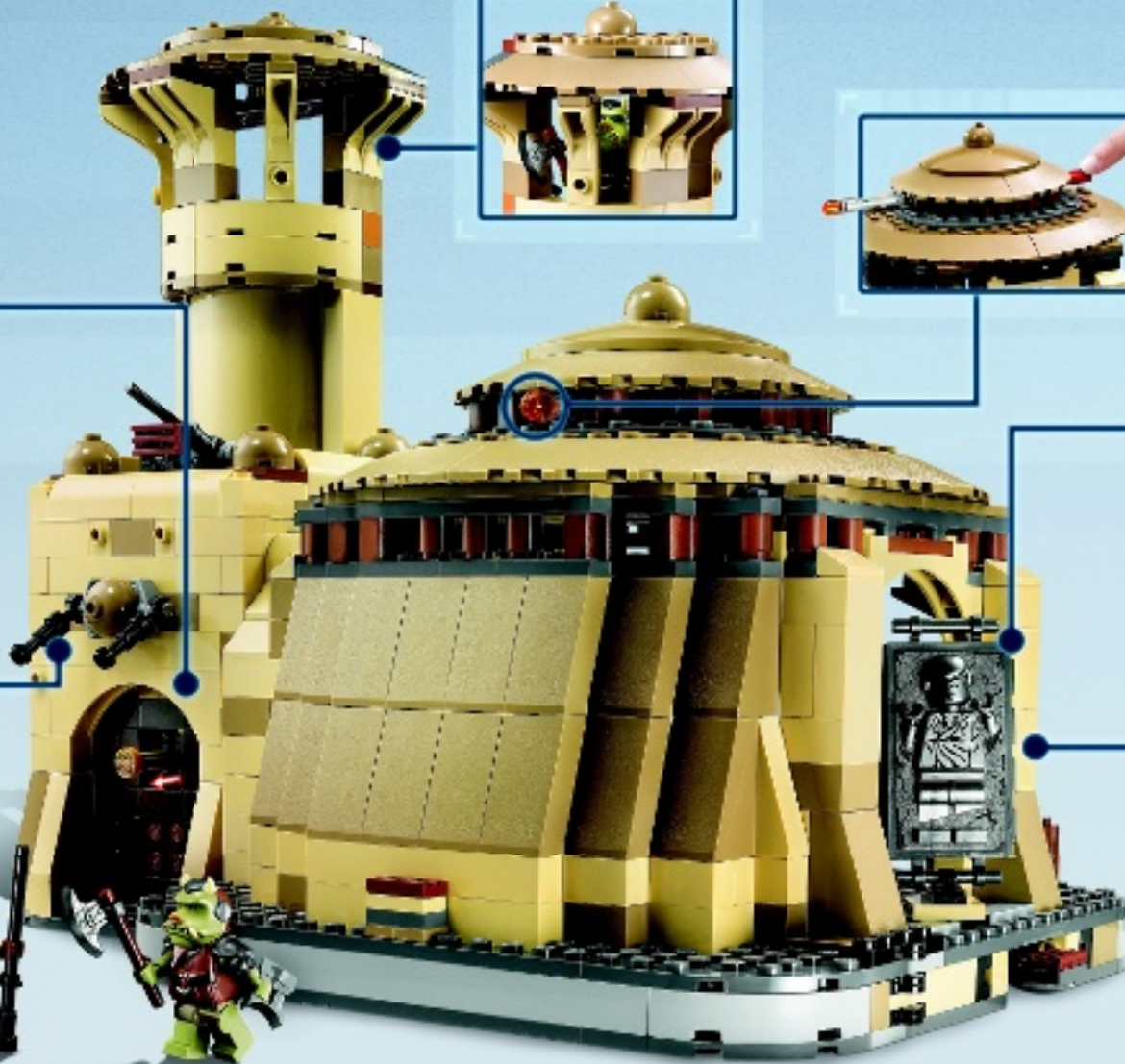
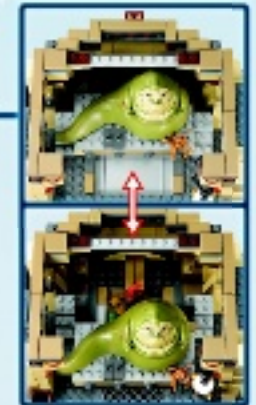





# club™

## FREE\*! GRATIS! GRATUIT!

# www.LEGOclub.com/Max



# 3



\*Paid subscription in Australia and New Zealand.  
\*Abonnement payant en Australie et Nouvelle-Zélande.



# WIN!



Go to [www.LEGOsurvey.com/product](http://www.LEGOsurvey.com/product) to fill out a survey for a chance to win a cool LEGO® Product. No purchase necessary. Open to all residents where not prohibited.

 [www.LEGO.com](http://www.LEGO.com)

# [www.LEGOsurvey.com/product](http://www.LEGOsurvey.com/product)

## GEWINNE!

Nimm an der Umfrage auf [www.LEGOsurvey.com/product](http://www.LEGOsurvey.com/product) teil und hab die Chance ein cooles LEGO® Produkt zu gewinnen! Die Teilnahme am Gewinnspiel führt zu keinerlei Kaufverpflichtungen. Teilnahme in allen nicht ausgeschlossenen Ländern möglich.

## WIN!

Ga naar [www.LEGOsurvey.com/product](http://www.LEGOsurvey.com/product), vul een enquêteformulier in en maak kans op een cool LEGO® product. Geen aankoopverplichting. Iedereen mag deelnemen, uitgezonderd ingezetenden van landen waar een enquêteverbod geldt.

## GAGNE!

Visite [www.LEGOsurvey.com/product](http://www.LEGOsurvey.com/product) pour répondre à un questionnaire et avoir une chance de gagner un produit LEGO® très cool! Aucune obligation d'achat. Ouvert à tous les résidents des pays autorisés.

## 当てよう!

[www.LEGOsurvey.com/product](http://www.LEGOsurvey.com/product) にアクセスして、アンケートにご記入ください。当選者にはレゴ®製品を差し上げます。お買い上げの必要はありません。禁止されていない限り、すべての皆様にご利用いただけます。